

# Graphics Layout Engine

## User Manual (v. 4.2.2)

C. Pugmire, St.M. Mundt, V.P. LaBella, J. Struyf

<http://www.gle-graphics.org/>

January 3, 2010



# Contents

<b>1</b>	<b>Preface</b>	<b>v</b>
<b>2</b>	<b>Tutorial</b>	<b>3</b>
2.1	Installing GLE . . . . .	3
2.2	Running GLE . . . . .	3
2.3	Drawing a Line on a Page . . . . .	3
2.4	Drawing a Simple Graph . . . . .	5
<b>3</b>	<b>Primitives</b>	<b>7</b>
3.1	Graphics Primitives (a summary) . . . . .	7
3.2	Graphics Primitives (in detail) . . . . .	8
<b>4</b>	<b>The Graph Module</b>	<b>23</b>
4.1	Graph Commands (a summary) . . . . .	23
4.2	Graph Commands (in detail) . . . . .	24
4.3	Bar Graphs . . . . .	36
4.4	3D Bar Graphs . . . . .	38
4.5	Filling Between Lines . . . . .	38
4.6	Notes on Drawing Graphs . . . . .	39
4.6.1	Importance of Order . . . . .	39
4.6.2	Line Width . . . . .	39
<b>5</b>	<b>The Key Module</b>	<b>41</b>
5.1	Global Commands . . . . .	42
5.2	Entry Definition Commands . . . . .	43
5.3	Defining the Key in the Graph Block . . . . .	44
<b>6</b>	<b>Programming Facilities</b>	<b>47</b>
6.1	Expressions . . . . .	47
6.2	Functions Inside Expressions . . . . .	47
6.3	Using Variables . . . . .	50
6.4	Programming Loops . . . . .	50
6.5	If-then-else . . . . .	51
6.6	Subroutines . . . . .	51
6.6.1	Default Arguments . . . . .	52
6.7	Forward Declarations . . . . .	52
6.8	I/O Functions . . . . .	52
6.9	Device dependend Control . . . . .	53
<b>7</b>	<b>Advanced Features</b>	<b>55</b>
7.1	Diagrams . . . . .	55
7.1.1	Named Boxes and the Join Command . . . . .	55
7.1.2	Object Blocks and Hierarchically Named Points . . . . .	57
7.2	LaTeX Interface . . . . .	58
7.2.1	Example . . . . .	58
7.2.2	Using LaTeX Packages . . . . .	59
7.2.3	Using UTF-8 Encoding in GLE Scripts with LaTeX Expressions . . . . .	59

7.2.4	Import a GLE Figure in a LaTeX Document	60
7.2.5	The .gle Directory	60
7.3	Filling, Stroking and Clipping Paths	60
7.4	Colour	61
7.5	GLE's Configuration File	62
<b>8</b>	<b>Surface and Contour Plots</b>	<b>63</b>
8.1	Surface Primitives	63
8.1.1	Overview	63
8.1.2	Surface Commands	63
8.2	Letz	67
8.3	Fitz	67
8.4	Contour	67
8.5	Color Maps	68
<b>9</b>	<b>GLE Utilities</b>	<b>71</b>
9.1	Fitls	71
9.2	Manip	72
9.2.1	Usage	72
9.2.2	Manip Primitives (a summary)	73
9.2.3	Manip Primitives (in detail)	73
<b>A</b>	<b>Tables</b>	<b>79</b>
A.1	Markers	79
A.2	Functions and Variables	79
A.3	L <sup>A</sup> T <sub>E</sub> X Macros and Symbols	82
A.4	Installing GLE	83
A.5	Fonts	83
A.6	Font Tables	84
A.7	Predefined Colors	94
A.8	Wall Reference	96
	<b>Index</b>	<b>97</b>

# Chapter 1

## Preface

### Abstract

GLE (Graphics Layout Engine) is a graphics scripting language designed for creating publication quality graphs, plots, diagrams, figures and slides. GLE supports various graph types (function plots, histograms, bar graphs, scatter plots, contour lines, color maps, surface plots, ...) through a simple but flexible set of graphing commands. More complex output can be created by relying on GLE's scripting language, which is full featured with subroutines, variables, and logic control. GLE relies on  $\LaTeX$  for text output and supports mathematical formulae in graphs and figures. GLE's output formats include EPS, PS, PDF, JPEG, and PNG. GLE is licenced under the BSD license. QGLE, the GLE user interface, is licenced under the GPL license.

### Trademark Acknowledgements

The following trademarks are used in this manual.

Windows	Microsoft Corporation.
$\TeX$	Donald E. Knuth, A Typesetting System.
$\LaTeX$	Leslie Lamport, A Document Preparation System.
PostScript	Page Description Language, Adobe Systems Inc.

### Typographic Conventions

The following conventions will be used in command descriptions:

[option]	Specifies an optional keyword or parameter, the brackets should not be typed.
option1   option2	Pick one of the options listed.
keyword	Keywords are represented in a bold typewriter font.
<i>exp,x,y,x1,y1</i>	Represent numbers or expressions. E.g. 2.2 or 2*5. Parameters to be entered by the user are given in italics.

### Pathways

For those in a hurry:

1. Read Chapter 2, The GLE Tutorial (beginners only).
2. Examine the examples at <http://www.gle-graphics.org/examples/>.
3. Browse through Chapter 4, The Graph Module.

For those with time:

- **Chapter 2, GLE Tutorial:**  
Covers installation and drawing a simple graph, highly recommended if you have never used GLE before.
- **Chapter 3, GLE Primitives:**  
Describes the commands used for creating diagrams and slides and for annotating graphs.

- **Chapter 4, The Graph Module:**  
Describes the commands for drawing graphs.
- **Chapter 5, The Key Module:**  
Describes the commands for producing keys for graphs.
- **Chapter 7, Advanced Features of GLE:**  
Covers advanced features of GLE. This includes programming constructs, the  $\LaTeX$  interface, ...
- **Chapter 8, Surface and Contour Plots:**  
Describes the commands for drawing three-dimensional graphs.
- **Chapter 9, GLE Utilities:**  
Describes FITLS and MANIP.



# Chapter 2

## Tutorial

### 2.1 Installing GLE

This tutorial assumes that GLE is correctly installed. Information about how to install GLE can be found at the following URLs. The GLE distribution also includes a README with brief installation instructions.

- Installation on Windows: <http://www.gle-graphics.org/tut/windows.html>.
- Installation on Linux: <http://www.gle-graphics.org/tut/linux.html>.
- Installation on Mac OS/X: <http://www.gle-graphics.org/tut/mac.html>.

Feel free to post any questions or comments you might have about installing GLE on the GLE mailing list, which is available here:

- Mailing list: <https://lists.sourceforge.net/lists/listinfo/glx-general>.

### 2.2 Running GLE

GLE is essentially a command line application; this tutorial will show you how to run it from the command prompt. GLE can also be run from your favorite text editor or from QGLE, GLE's graphical user interface. More information about running GLE from a text editor is given in the installation instructions.

On Windows, you run GLE from the Windows Command Prompt. Normally the GLE installer should have added an entry labeled "Command Prompt" to GLE's folder in the start menu. On Unix-like operating systems, GLE runs from an X-terminal, such as "konsole" on Linux / KDE.

Once you have opened the command prompt or terminal, try running GLE by entering the following command.

```
gle
```

As a result, GLE displays the following message.

```
GLE version x.y.z
Usage: gle [options] filename.gle
More information: gle -help
```

If this message does not appear and you see an error message instead, then GLE is not correctly installed. Refer to the installation instructions (Appendix A.4) for more information. In the following, we will show how to construct a simple drawing with GLE.

### 2.3 Drawing a Line on a Page

Let's start with drawing a line on the page. GLE needs to know the size of the drawing you wish to make. This is accomplished with the size command:



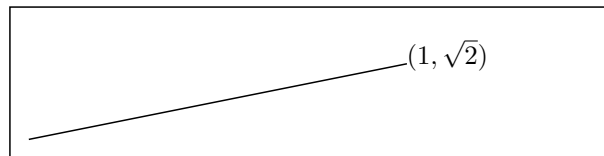

Figure 2.1: Result of your first GLE script.

```
size 8 2
```

This specifies that the output will be 8cm wide and 2cm high. Next we define a “current point” by moving to somewhere on the page:

```
amove 0.25 0.25
```

The origin (0,0) is at the bottom left hand corner of the page. Suppose we wish to draw a line from this point 5 cm across and 1 cm up:

```
size 8 2
amove 0.25 0.25
rline 5 1
```

This is a **relative** movement as the x and y values are given as distances from the current point, alternatively we could have used **absolute** coordinates:

```
size 8 2
amove 0.25 0.25
aline 5.25 1.25
```

To draw some text on the page at the current point, use the write command:

```
write "Hi there"
```

Or, alternatively, you could include arbitrary L<sup>A</sup>T<sub>E</sub>X expressions using the tex command:

```
tex "${1,\sqrt{2}}$"
```

Now we have constructed complete GLE script, which looks as follows:

```
size 8 2 box
amove 0.25 0.25
rline 5 1
tex "${1,\sqrt{2}}$"
```

Enter the above GLE script using a text editor and save it to disk (any editor that saves in UTF8 or ASCII format will work). The following assumes that you have saved the file under the name “**test.gle**” in the folder C:\GLE on Windows, or /home/john/gle on a Unix-like operating system. Now open a command prompt and go to the folder where you saved the file. Then, run GLE on the file.

On Windows, you do this as follows (C:\> is the prompt):

```
C:\> cd C:\GLE
C:\GLE> gle test.gle
```

Or on Unix:

```
cd ~/gle
gle test.gle
```

GLE produces by default an Encapsulated PostScript (.eps) file:

```
GLE x.y.z [test.gle]-C-R-[test.eps]
```

Try viewing the resulting “**test.eps**” with a PostScript viewer such as GhostView, and compare it to the output shown in Fig. 2.1. You can also preview it with QGLE, GLE’s graphical user interface. After you’ve started QGLE, enter the following command at the command prompt.

```
gle -p test.gle
```

This will preview the output in the QGLE previewer window. GLE can also create PDF files. This is accomplished by setting the output device to “pdf”.

```
gle -device pdf test.gle
```

Try viewing the resulting “test.pdf” with Acrobat Reader or similar. Other output formats supported by GLE (eps, ps, pdf, svg, jpg, png, x11) can also be obtained with the -device command line option (which can be abbreviated to -d). For example, to create a JPEG bitmap file, one can use:

```
gle -d jpg -r 200 test.gle
```

Help about the available command line options can be obtained with:

```
gle -help
```

and to obtain more information about a particular option, use:

```
gle -help option
```

The following command line options are supported by GLE:

-help	Shows help about command line options
-info	Outputs software version, build date, GLE_TOP, GLE_BIN, etc.
-verbosity	Sets the verbosity level of GLE console output
-device	Selects output device(s)
-resolution	Sets the resolution for bitmap and PDF output
-fullpage	Selects full page output
-output	Specifies the name of the output file
-preview	Previews the output with QGLE
-gs	Previews the output with GhostScript
-version	Selects a GLE version to run
-compatibility	Selects a GLE compatibility mode
-calc	Runs GLE in "calculator" mode
-tex	Indicates that the script includes LaTeX expressions
-inc	Creates an .inc file with LaTeX code
-texincprefix	Adds the given subdirectory to the path in the .inc file
-mkinittex	Creates "inittex.ini" from "init.tex"
-nocolor	Forces grayscale output
-transparent	Creates transparent output (with -d png)
-noctrl-d	Excludes CTRL-D from the PostScript output
-nomaxpath	Disables the upper-bound on the drawing path complexity
-safemode	Disables reading/writing to the file system
-allowread	Allows reading from the given path
-allowwrite	Allows writing to the given path

## 2.4 Drawing a Simple Graph

This section shows how to go about drawing a simple graph. Enter the following data in a new file and save it as “test.csv”. Note that you can export files in CSV (comma separated values) format with most spread sheet programs.

```
1,2
2,6
3,2
4,5
5,9
```

The data is in two columns with a comma separating each column of numbers. The following commands will draw a simple line graph of the data.

```

size 7 4
begin graph
  title "Simple Graph"
  xtitle "Time"
  ytitle "Output"
  data "test.csv"
  d1 line marker triangle color red
end graph

```

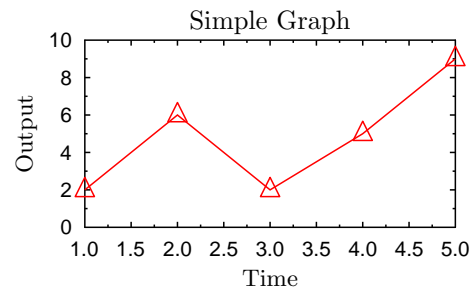

The commands `title`, `xtitle`, and `ytitle` specify the graph title and the axis titles. The command `data` loads the data file and the `d1` command specifies how the first curve on the graph should look like. These commands are discussed in detail in Chapter 4. Possible values for the `marker` option can be found on the GLE wall reference chart in Appendix A.8.

The axis ranges can be specified with “`xaxis min  $v_0$  max  $v_1$` ” and “`yaxis min  $v_0$  max  $v_1$` ”. A smooth line can be drawn through the data points by changing the `d1` command to: “`d1 line smooth`” as in the following example.

```

size 7 4
begin graph
  title "Smooth Graph"
  xtitle "Time"
  ytitle "Output"
  data "test.csv"
  yaxis min 0 max 10
  d1 line smooth color red
end graph

```

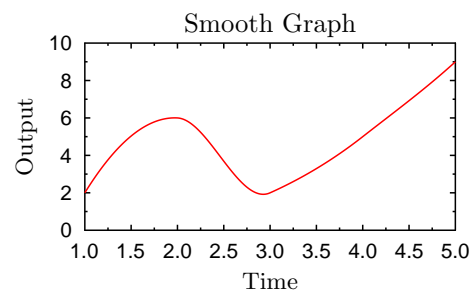

Note that the order of the commands is not important, except that `circle` is a parameter for the option `marker` and therefore must come right after it. The same holds for `line` and `smooth` and `color` and `blue` in the example “`d1 marker circle line smooth color blue`”.

It is simple to change to a bar graph and include last year’s measurements:

```

size 7 4
begin graph
  title "Bar Graph"
  xtitle "Measurement"
  ytitle "Output"
  data "year-2000.csv"
  data "year-2001.csv"
  key pos tl
  bar d1,d2 fill red,blue
end graph

```

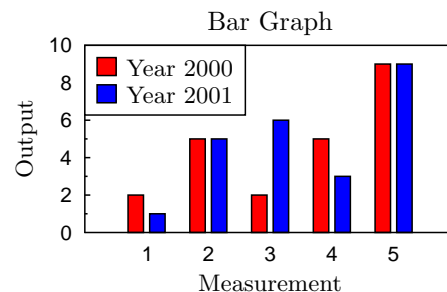

Adding `min` and `max` values on the axis commands is highly recommended because by default GLE won’t start from the origin unless the data happens to be very close to zero. It is also difficult to compare graphs unless they all have the same axis ranges. More information about the graph module is available in Chapter 4.

# Chapter 3

## Primitives

A GLE command is a sequence of keywords and values separated by white space (one or more spaces or tabs). Each command must begin on a new line. Keywords may not be abbreviated, the case is not significant. All coordinates are expressed in centimeters from the bottom left corner of the page.

GLE uses the concept of a **current point** which most commands use. For example, the command `aline 2 3` will draw a line from the **current point** to the coordinates (2,3).

The current graphics state also includes other settings like line width, colour, font, 2d transformation matrix. All of these can be set with various GLE commands.

### 3.1 Graphics Primitives (a summary)

```
! comment
@xxx
abound x y aline x y [arrow start] [arrow end] [arrow both] [curve α1 α2 d1 d2]
amove x y
arc radius a1 a2 [arrow end] [arrow start] [arrow both]
arcto x1 y1 x2 y2 rad
begin box [fill pattern] [add gap] [nobox] [name xyz] [round val]
begin clip
begin name name
begin object name
begin origin
begin path [stroke] [fill pattern] [clip]
begin rotate angle
begin scale x y
begin table
begin tex
begin text [width exp]
begin translate x y
bezier x1 y1 x2 y2 x3 y3
bitmap filename width height [type type]
bitmap_info filename width height [type type]
box x y [justify jtype] [fill color] [name xxx] [nobox] [round val]
circle radius [fill pattern]
closepath
colormap fcf xmin xmax ymin ymax pixels-x pixels-y width height [color] [palette pal]
curve ix iy [x1 y1 x y x y ... xn yn]ex ey
define marker markername subroutine-name
draw name.point [arg1 ... argn] [name name]
ellipse dx dy [options]
elliptical_arc dx dy theta1 theta2 [options]
for var = exp1 to exp2 [step exp3] command [...] next var
grestore
gsave
```

```

if exp then command [...] else command [...] end if
include filename
join object1.just sep object2.just [curve  $\alpha_1 \alpha_2 d_1 d_2$ ]
local var1, ..., varn
margins top bottom left right
marker marker-name [scale-factor]
orientation o
papersize size
postscript filename.eps width-exp height-exp
print string$ ...
psbttweak
pscomment exp
rbezier x1 y1 x2 y2 x3 y3
return exp
reverse
rline x y [arrow end] [arrow start] [arrow both] [curve  $\alpha_1 \alpha_2 d_1 d_2$ ]
rmove x y
save objectname
set alabeldist d
set alabelscale s
set arrowangle angle
set arrowsize size
set arrowstyle simple — filled — empty
set atitledist s
set atitlescale s
set background it c
set cap butt — round — square
set color col
set dashlen dashlen-exp
set fill fill color/pattern
set font font-name
set fontlwidth line-width
set hei character-size
set join mitre — round — bevel
set just left | center | right | tl | etc...
set lstyle line-style
set lwidth line-width
set pattern fill pattern
set texscale scale | fixed | none
set titlescale s
set ticksscale s
sub sub-name paramter1 paramter2 etc
tex string [name xxx] [add val]
text unquoted-text-string
write string$ ...

```

## 3.2 Graphics Primitives (in detail)

*! comment*

Indicates the start of a comment. GLE ignores everything from the exclamation point to the end of the line. This works both in GLE scripts and in data files used in, e.g., graph blocks.

*@xxx*

Executes subroutine *xxx*.

*abound x y*

Update the current bounding box to include the point  $(x, y)$  without drawing anything. This command is useful in combination with ‘begin box’, ‘begin name’, etc., e.g., to add empty space to the box.

`aline  $x$   $y$  [arrow start] [arrow end] [arrow both] [curve  $\alpha 1$   $\alpha 2$   $d 1$   $d 2$ ]`

Draws a line from the current point to the absolute coordinates  $(x,y)$ , which then becomes the new current point. The arrow qualifiers are optional, they draw arrows at the start or end of the line, the size of the arrow is proportional to the current font height.

If the curve option is given, then a Bezier curve is drawn instead of a line. The first control point is located at a distance  $d 1$  and angle  $\alpha 1$  from the current point and the second control point is located at distance  $d 2$  and angle  $\alpha 2$  from  $(x,y)$ .

`amove  $x$   $y$`

Changes the current point to the absolute coordinates  $(x,y)$ .

`arc  $radius$   $a 1$   $a 2$  [arrow end] [arrow start] [arrow both]`

Draws an arc of a circle in the anti-clockwise direction, centered at the current point, of radius  $radius$ , starting at angle  $a 1$  and finishing at angle  $a 2$ . Angles are specified in degrees. Zero degrees is at three o'clock and Ninety degrees is at twelve o'clock.

```
arc 1.2 20 45
```

The command `narc` is identical but draws the arc in the clockwise direction. This is important when constructing a path.

```
amove .5 .5
rline 1 .5 arrow end
arc 1 10 160
arc .5 -90 0
```

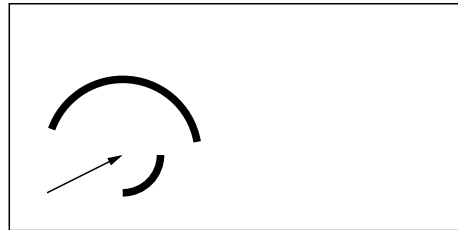

`arcto  $x 1$   $y 1$   $x 2$   $y 2$   $rad$`

Draws a line from the current point to  $(x 1,y 1)$  then to  $(x 2,y 2)$  but fits an arc of radius  $rad$  joining the two vectors instead of a vertex at the point  $(x 1,y 1)$ .

```
amove 1.5 .5
rline 1 0
set lwidth .1
arcto 2 0 -1 1 .5
set lwidth 0
rline -1 1
```

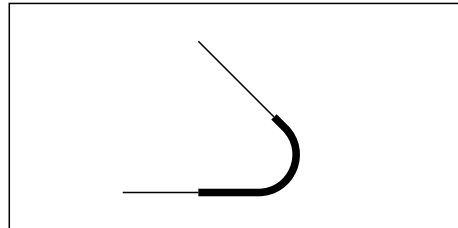

`begin  $block\_name$  ...  $end$   $block\_name$`

There are several block structured commands in GLE. Each `begin` must have a matching `end`. Blocks which change the current graphics state (e.g. scale, rotate, clip etc) will restore whatever they change at the end of the block. Indentation is optional but should be used to make the GLE program easier to read.

`begin box [fill  $pattern$ ] [add  $gap$ ] [nobox] [name  $xyz$ ] [round  $val$ ]`

Draws a box around everything between `begin box` and `end box`. The option `add` adds a margin of  $margin$  cm to each side of the box to make the box slightly larger than the area defined by the graphics primitives in the `begin box ...end box` group (to leave a gap around text for example). The option `nobox` stops the box outline from being drawn.

The `name` option saves the coordinates of the box for later use with among others the `join` command.

If the `round` option is used, a box with rounded corners will be drawn.

```
begin box add 0.2
  begin box fill gray10 add 0.2 round .3
    text John
  end box
end box
```

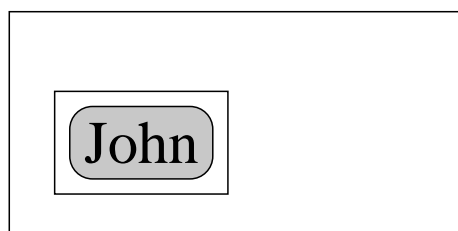

**begin clip**

This saves the current clipping region. A clipping region is an arbitrary path made from lines and curves which defines the area on which drawing can occur. This is used to undo the effect of a clipping region defined with the `begin path` command. See the example CLIP.GLE in appendix B at the end of the manual.

**begin name *name***

Saves the coordinates of what is inside the block for later use with among others the `join` command. This command is equivalent to ‘`begin box name ... nobox`’.

**begin object *name* [*arg1*, ..., *argn*]**

Declares a new object (sub-figure) that can be drawn later with the ‘`draw`’ command. Section 7.1.2 explains in detail how this command works and how it can be used.

Object blocks can have arguments if they are not defined inside a subroutine. Such object blocks are called ‘static objects’; they behave similar to subroutines. Object blocks can also be defined inside a subroutine. In that case, they are called ‘dynamic objects’ and cannot have arguments. They may, however, refer to all arguments and local variables of the surrounding subroutine.

**begin origin**

This makes the current point the origin. This is good for subroutines or something which has been drawn using `amove,aline`. Everything between the `begin origin` and `end origin` can be moved as one unit. The current point is also saved and restored.

**begin path [*stroke*] [*fill pattern*] [*clip*]**

Initialises the drawing of a filled shape. All the lines and curves generated until the next `end path` command will be stored and then used to draw the shape. `stroke` draws the outline of the shape, `fill` paints the inside of the shape in the given colour and `clip` defines the shape as a clipping region for all future drawing. Clipping and filling will only work on PostScript devices.

**begin rotate *angle***

The coordinate system is rotated anti-clockwise about the current point by the angle *angle* (in degrees). For example, to draw a line of text running vertically up the page (as a Y axis label, say), type:

```
begin rotate 90
  text This is
end rotate
```

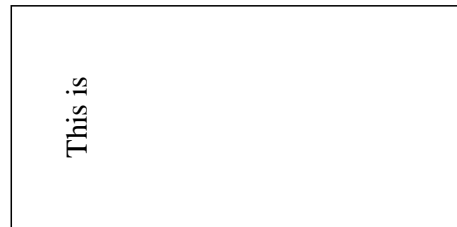
**begin scale *x y***

Everything between the `begin` and `end` is scaled by the factors *x* and *y*. E.g., `scale 2 3` would make the picture twice as wide and three times higher.

```
begin scale 3 1
  begin rotate 30
    text This is
  end rotate
end scale
```

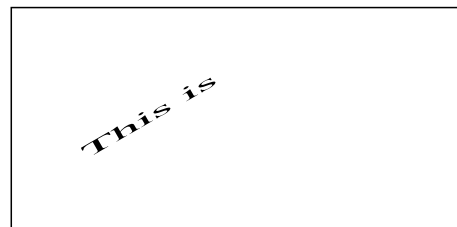
**begin table**

This module is an alternative to the `TEXT` module. It reads the spaces and tabs in the source file and aligns the words accordingly. A single space between two words is treated as a real space, not an alignment space.

With a proportionally spaced font columns will line up on the left hand side but not on the right hand side. However with a fixed pitch font, like `tt`, everything will line up.

```
begin table
  Here is my table
  of text see how
  22 44 55 33
  0.1 999 1 .2
  3 33 2 33
  it lines up
end table
```

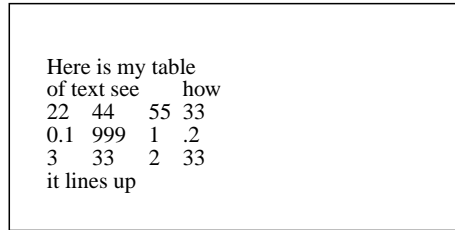

```
Here is my table
of text see how
22 44 55 33
0.1 999 1 .2
3 33 2 33
it lines up
```

```
begin text [width exp]
```

This module displays multiple lines/paragraphs of text. The block of text is justified according to the current justify setting. See the `set just` command for a description of justification settings.

If a width is specified the text is wrapped and justified to the given width. If a width is not given, each line of text is drawn as it appears in the file. Remember that GLE treats text in the same way that L<sup>A</sup>T<sub>E</sub>X does, so multiple spaces are ignored and some characters have special meaning. E.g., `\ ^ _ & { }`

To include Greek characters in the middle of text use a backslash followed by the name of the character. E.g., `3.3\Omega S` would produce “3.3ΩS”.

To put a space between the Omega and the S add a backslash space at the end. E.g., `3.3\Omega\ S` produces “3.3Ω S”

Sometimes the space control characters (e.g. `\:`) are also ignored, this may happen at the beginning of a line of text. In this case use the control sequence `\glass` which will trick GLE into thinking it isn't at the beginning of a line. E.g.,

```
text \glass \:\: Indented text

set hei 0.25 just tl font tt
begin text width 5
  This is my paragraph of text to see
  if it wraps things at four cm as I have
  told it to do.
end text
...
begin text
  Now some text without
  a width
  specified
end text
```

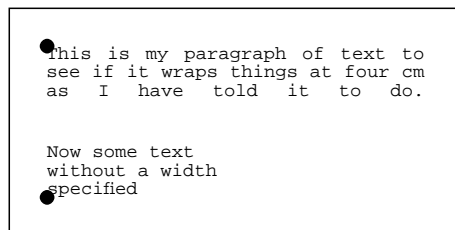

```
• This is my paragraph of text to
  see if it wraps things at four cm
  as I have told it to do.

Now some text
without a width
specified
```

There are several L<sup>A</sup>T<sub>E</sub>X like commands which can be used within text. The complete list can be found in Appendix A.3. A few examples are:

<code>\ \' \v \u \= \^ \.</code>	Implemented TeX accents
<code>\~{} _{} }</code>	Superscript, subscript
<code>\ \_</code>	Forced Newline, underscore character
<code>\, \: \;</code>	0.5em, 1em, 2em space (em = width of the letter 'm')
<code>\tex{expression}</code>	Any LaTeX expression
<code>\char{22}</code>	Any character in current font
<code>\glass</code>	Makes move/space work on beginning of line
<code>\rule{2}{4}</code>	Draws a filled in box, 2cm by 4cm
<code>\setfont{rmb}</code>	Sets the current text font
<code>\sethei{0.3}</code>	Sets the font height (in cm)
<code>\setstretch{2}</code>	Scales the quantity of glue between words
<code>\lineskip{0.1}</code>	Sets the default distance between lines of text
<code>\linegap{-1}</code>	Sets the minimum required gap between lines
<code>{\rm ...}, {\it ...}</code>	Sets roman, and italic font
<code>{\bf ...}, {\tt ...}</code>	Sets bold, and typewriter (monospaced) font
<code>\alpha, \beta, ...</code>	Greek symbols

```
begin translate x y
```

Everything between the begin and end is moved x units to the right and y units up.



**bezier**  $x1\ y1\ x2\ y2\ x3\ y3$

Draws a Bézier cubic section from the current point to the point  $(x3,y3)$  with Bézier cubic control points at the coordinates  $(x1,y1)$  and  $(x2,y2)$ . For a full explanation of Bézier curves see the PostScript Language Reference Manual.

**bitmap**  $filename\ width\ height$  [**type**  $type$ ]

Imports the bitmap  $filename$ . The bitmap is scaled to  $width \times height$ . If one of these is zero, it is computed based on the other one and the aspect ratio of the bitmap. GLE supports TIFF, JPEG, PNG and GIF bitmaps (depending on the compilation options).

Bitmaps are compressed automatically by GLE using either the LZW or the JPEG compression scheme.

**bitmap\_info**  $filename\ width\ height$  [**type**  $type$ ]

Returns the dimensions in pixels of the bitmap in the output parameters  $width$  and  $height$ .

**box**  $x\ y$  [**justify**  $jtype$ ] [**fill**  $color$ ] [**name**  $xxx$ ] [**nobox**] [**round**  $val$ ]

Draws a box, of width  $x$  and height  $y$ , with its bottom left corner at the current point. If the justify option is used, the box will be positioned relative to the specified point. E.g., TL = top left, CC = center center, BL = bottom left, CENTER = bottom center, RIGHT = bottom right, LEFT = bottom left. See **set just** for a description of justification settings.

If a fill pattern is specified, the box will be filled. Remember that white fill is different from no fill pattern - white fill will erase anything that was inside the box.

If the round option is used, a box with rounded corners will be drawn.

**circle**  $radius$  [**fill**  $pattern$ ]

Draws a circle at the current point, with radius  $radius$ . If a fill pattern is specified the circle will be filled.

**closepath**

Joins the beginning of a line to the end of a line. I.e., it does an **aline** to the end of the last **amove**.

**colormap**  $fcn\ xmin\ xmax\ ymin\ ymax\ pixels-x\ pixels-y\ width\ height$  [**color**] [**palette**  $pal$ ]

Draws a colormap of the function  $fcn(x,y)$ , in which  $x$  ranges from  $xmin$  to  $xmax$ , and  $y$  ranges from  $ymin$  to  $ymax$ . The size of the colormap is  $width$  by  $height$  centimeter and the resolution is  $pixels-x$  by  $pixels-y$  pixels. A colormap is grayscale by default; it is drawn in color if the option **color** is given. In the latter case, it is possible to specify a palette subroutine  $pal$  mapping the range  $0 \dots 1$  to a range of colors. This command is similar to the colormap command in a graph block (Sec. 8.5).

**curve**  $ix\ iy\ [x1\ y1\ x\ y\ x\ y \dots xn\ yn]ex\ ey$

Draws a curve starting at the current point and passing through the points  $(x1,y1) \dots (xn,yn)$ , with an initial slope of  $(ix,iy)$  to  $(x1,y1)$  and a final slope of  $(ex,ey)$ . All the vectors are relative movements from the vector before.

```
amove 1 1
curve 1 0 0 1 1 0 0 -1 1 0
amove 3.6 1
curve 0 1 0 1 1 0 0 -1 0 -1
```

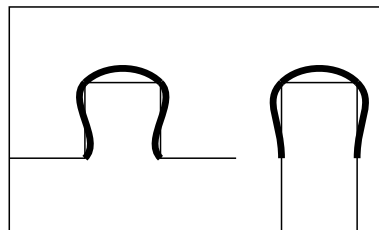

**define marker**  $markername\ subroutine-name$

This defines a new marker called  $markername$  which will call the subroutine  $subroutine-name$  whenever it is used. It passes two parameters, the first is the requested size of the marker and the second is a value from a secondary dataset which can be used to vary size or rotation of a marker for each point plotted.

To define a character from the postscript ZapDingbats font as a marker you would use, e.g.

```

sub subnamex size mdata
  gsave                                ! save font and x,y
  set just left font pszd hei size
  t$ = "\char{102}"
  rmove -twidth(t$)/2 -theight(t$)/2 ! centers marker
  write t$
  grestore                               ! restores font and x,y
end sub

```

The second parameter can be supplied using the *mdata* command when drawing a graph, this gives the marker subroutine a value from another dataset to use to draw the marker. For example the marker could vary in size, or angle, with every one plotted.

```
d3 marker myname mdata d4
```

```
define markername fontname scale dx dy
```

This command defines a new marker, from any font, it is automatically centered but can be adjusted using *dx,dy*. e.g.

```
defmarker hand pszd 43 1 0 0
```

```
draw name.point [arg1 ... argn] [name name]
```

Draws a named object block that has been previously defined using a “begin/end object” (p. 10) construct. The object is drawn such that the point indicated by the first argument of the draw command appears at the current position. The point can be any (hierarchically) named point on the object and may include the justify options defined for the join command (p. 14).

If the object block has parameters (similar to a subroutine) then these parameters can be given as *arg1 ... argn*.

The “draw” command names the object using the same name as the name of the object block by default. An alternative name can be supplied using its “name” option.

See Sec. 7.1.2 for a detailed explanation of this command with examples.

```
ellipse dx dy [options]
```

This command draws an ellipse with the diameters *dx* and *dy* in the *x* and *y* directions, respectively. The *options* are the same as the circle command.

```
elliptical_arc dx dy theta1 theta2 [options]
```

This command is similar to the arc command except that it draws an elliptical arc in the clockwise direction with the diameters *dx* and *dy* in the *x* and *y* directions, respectively. *theta1* and *theta2* are the start and stop angle, respectively. The *options* are the same as for the arc command.

The command *elliptical\_narc* is identical but draws the arc in the clockwise direction. This is important when constructing a path.

```
for var = exp1 to exp2 [step exp3] command [...] next var
```

The for ... next structure lets you repeat a block of statements a number of times.

GLE sets *var* equal to *exp1* and then repeats the following steps.

- If *var* is greater than *exp2* then GLE commands are skipped until the line after the next statement.
- The value *exp3* is added to *var*.
- The statements between the for and next statement are executed.

If *exp1* is greater than *exp2* then the loop is not executed.

```

for x = 1 to 4 step 0.5
  amove x 1
  aline 5-x 2
next x

```

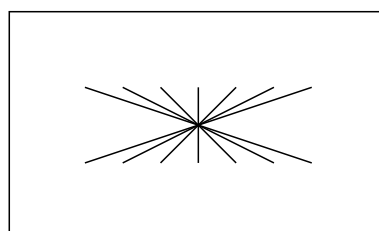

Table 3.1: Include files distributed with GLE.

barstyles.gle	Defines additional styles for bar plots.
color.gle	Defines functions for working with colors.
colors-gle-4.0.12.gle	Redefines all colors defined in GLE 4.0.12 and before.
contour.gle	Subroutines for drawing contour plots
electronics.gle	Subroutines for drawing electrical circuits
ellipse.gle	Draw text in an ellipse
feyn.gle	Subroutines for drawing Feynmann diagrams
graphutil.gle	Subroutines for drawing graphs
piesub.gle	Pie chart routines
polarplot.gle	Polar plotting routines
shape.gle	Drawing various shapes
simpletree.gle	Draw simple trees
stm.gle	Add labels to images
ziptext.gle	Draw zipped text

**grestore**

Restores the most recently saved graphics state. This is the simplest way to restore complicated transformations such as rotations and translations. It must be paired with a previous **gsave** command.

**gsave**

Saves the current graphics transformation matrix and the current point and the current colour, font etc.

**if *expression* then *command* [...] else *command* [...] end if**

If *expression* evaluates to true, then execution continues with the statements up to the corresponding **else**, otherwise the statements following the **else** and up to the corresponding **end if** are executed.

```

amove 3 3
if xpos()=3 then
  text We are at x=3
else
  text We are elsewhere
end if

```

Note: **end if** is not spelt **endif**.

**include *filename***

Includes the GLE script “filename” into the current script. This is useful for including library scripts with subroutines. GLE searches a number of predefined directories for include files. By default, this includes the current directory and the “lib” or “gleinc” subdirectory of the root directory (GLE\_TOP) of your GLE installation. The latter includes a number of subroutine files that are distributed with GLE (Table 3.1). Additional include directories can be defined by means of the environment variable GLE\_USRLIB.

**join *object1.just sep object2.just* [*curve*  $\alpha_1$   $\alpha_2$   $d_1$   $d_2$ ]**

Draws a line between two named objects. An object is simply a point or a box which was given a name when it was drawn.

The justify qualifiers are the standard GLE justification abbreviations: **.br** (bottom right), **.bl** (bottom left), **.bc** (bottom centre), **.tr** (top right), **.tc** (top centre), **.tl** (top left), **.cr** (centre right), **.cc** (centre centre), and **.cl** (centre left). In addition, **.v** and **.h** can be used to draw vertical or horizontal lines connecting to the object, **.c** for drawing a line connecting to e circle or ellipse, and **.box** for drawing a line to a rectangle. Fig. 3.3 shows examples of the different cases.

If *sep* is written as -, a line is drawn between the named objects e.g.

```

join fred.tr - mary.tl

```









































 triangle	 fcircle	 odot	 flower	 handpen
 wtriangle	 diamond	 ominus	 club	 letter
 ftiangle	 wdiamond	 oplus	 heart	 phone
 square	 fdiamond	 otimes	 spade	 plane
 wsquare	 cross	 star	 dag	 scircle
 fsquare	 plus	 star2	 ddag	 ssquare
 circle	 minus	 star3	 snake	 trianglez
 wcircle	 asterisk	 star4	 dot	 diamondz

Figure 3.1: All markers supported by GLE. (The names that start with “w” are white filled.)

Arrow heads can be included at both ends of the line by writing *sep* as `<->`. Single arrow heads are produced by `<-` and `->`. Note that *sep* must be separated from `object1.just` and `object2.just` by white space.

If the justification qualifiers are omitted, a line will be drawn between the centers of the two objects (clipped at the edges of the rectangles which define the objects). This is the same as using the `.box` qualifier on both objects.

The curve option is explained with the `aline` command. Fig. 3.3 shows an example where the “join” command is used with the curve option.

Sec. 7.1.1 contains several examples of joining objects.

**local** *var*<sub>1</sub>, ..., *var*<sub>*n*</sub>

Defines a local variable inside a subroutine. It is possible to initialize the variable to a particular value with, e.g., `local x = 3`, which defines the local variable ‘x’ and assigns it the value 3. You can also define several local variables at once, e.g., `local x, y` defines the local variables ‘x’ and ‘y’.

**margins** *top bottom left right*

This command can be used to define the page margins. Margins are only relevant for making full-page figures (using the `-fullpage` command line option). See also the “papersize” command.

**marker** *marker-name* [*scale-factor*]

Draws marker *marker-name* at the current point. The size of the marker is proportional to the current font size, scaled by the value of *scale-factor* if present. Markers are referred to by name, eg. `square`, `diamond`, `triangle` and `fcircle`. Markers beginning with the letter `f` are usually filled variants. Markers beginning with `w` are filled with white so lines are not visible through the marker. For a complete list of markers refer to Fig. 3.1.

```
set just lc
amove 0.5 2.5
marker diamond 1
rmove 0.6 0; text Diamond
amove 0.5 2
marker triangle 1
rmove 0.6 0; text Triangle
...
```

**orientation** *o*

Sets the orientation of the output in full-page mode. Possible values are “portrait” and “landscape”. Fig. 3.2 illustrates these two cases.

**papersize** *size*

**papersize** *width height*

Sets the paper size of the output. This is used only when GLE is run with the option “-fullpage” or when the PostScript output device is used (i.e., “-d ps”). The command either takes one argument,

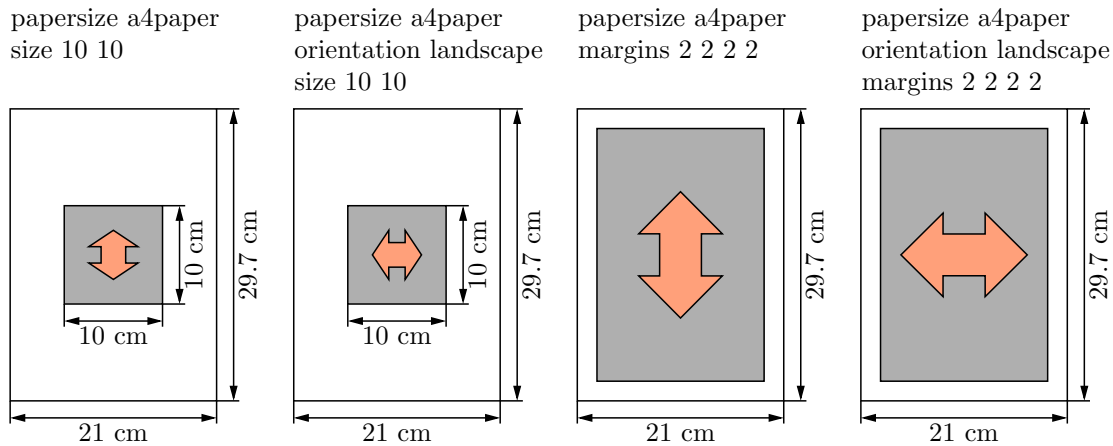

Figure 3.2: Result of different combinations of the commands “papersize”, “margins”, “size”, and “orientation” for fullpage graphics (`gle -fullpage figure.gle`).

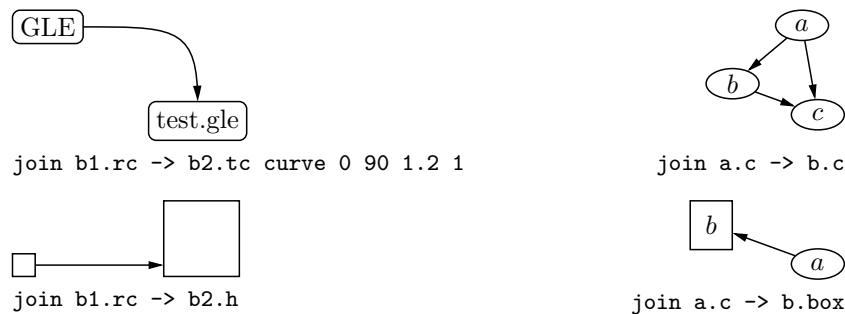

Figure 3.3: Different ways of joining objects.

which should be one of the predefined paper size names or two numbers, which give the width and height of the output measured in cm. The following paper sizes are known by GLE: `a0paper`, `a1paper`, `a2paper`, `a3paper`, `a4paper`, and `letterpaper`.

If a “size” command is given in the script, then the output is drawn centered on the page. If no size command is included in the script, then the output will appear relative to the bottom-left corner of the page, offset by the page margins (see “margins” command). Fig. 3.2 illustrates these two cases.

The paper size can also be set in GLE’s configuration file (Sec. 7.5).

`postscript filename.eps width-exp height-exp`

Includes an encapsulated postscript file into a GLE picture, the postscript picture will be scaled up or down to fit the width given. On the screen you will just see a rectangle.

Only the *width-exp* is used to scale the picture so that the aspect ratio is maintained. The height is only used to display a rectangle of the right size on the screen.

`print string$ ...`

This command prints its argument to the console (terminal).

`psbttweak`

Changes the default behavior of the bounding box. The default behavior is to have the lower corner at (-1,-1), which for some interpreters (i.e., Photoshop) will leave a black line around the bottom and left borders. If this command is specified then the origin of the bounding box will be set to (0,0).

This command must appear before the first `size` command in the GLE file.

`pscomment exp`

Allows inclusion of *exp* as a comment in the preamble of the postscript file. Multiple `pscomment` commands are allowed.

This command must appear before the first `size` command in the GLE file.

`rbezier  $x1$   $y1$   $x2$   $y2$   $x3$   $y3$`

This command is identical to the `BEZIER` command except that the points are all relative to the current point.

```
amove 0.5 2.8
rbezier 1 1 2 -1 3 1
amove 0.2 0.2
rbezier 1 1 2 1.2 1.8 0
```

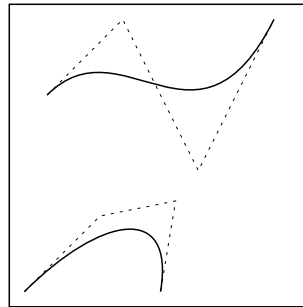

`return  $exp$`

The `return` command is used inside subroutines to return a value.

`reverse`

Reverses the direction of the current path. This is used when filling multiple paths in order that the Non-Zero Winding Rule will know which part of the path is 'inside'.

With the Non-Zero Winding Rule an imaginary line is drawn through the object. Every time a line of the object crosses it from left to right, one is added to the counter; every time a line of the object crosses it from right to left, one is subtracted from the counter. Everywhere the counter is non-zero is considered to be the 'inside' of the drawing and is filled.

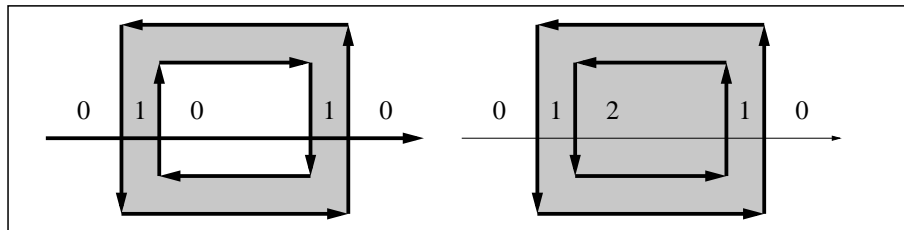

`rline  $x$   $y$  [arrow end] [arrow start] [arrow both] [curve  $\alpha1$   $\alpha2$   $d1$   $d2$ ]`

Draws a line from the current point to the relative coordinates  $(x,y)$ , which then become the new current point. If the current point is (5,5) then `rline 3 -2` is equivalent to `aline 8 3`. The optional qualifiers on the end of the command will draw arrows at one or both ends of the line, the size of the arrow head is proportional to the current font size.

The `curve` option is explained with the `aline` command.

`rmove  $x$   $y$`

Changes the current point to the relative coordinate  $(x,y)$ . If the current point is (5,5) then `rmove 3 -2` is equivalent to `amove 8 3`.

`save  $objectname$`

This command saves a point for later use with the `join` command.

`set alabeldist  $d$`

The spacing between the graph axis labels and the axis is set to  $d$ .

`set alabelscale  $s$`

The graph axis label font size is set to '`alabelscale`' times '`hei`'.

`set arrowangle  $angle$`

Sets the opening angle of the arrow tips. (Actually, half of the opening angle.)

`set arrowsize  $size$`

Sets the length of the arrow tips in centimeter.

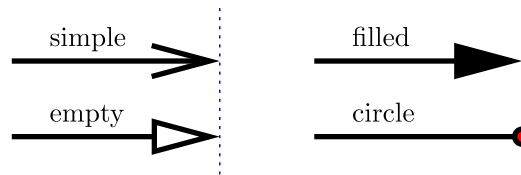

Figure 3.4: Different arrow tip styles.

`set arrowstyle simple — filled — empty`

Sets the style of the arrow tips. There are three pre-defined styles: simple, filled, and empty (See Fig. 3.4).

It is also possible to create user-defined arrow tip styles. To do so, create a subroutine ‘`arrow_xxxx langle aangle asize`’, with `xxxx` the name of the new style. The parameter `langle` is the angle of the line on which the arrow tip is to be drawn and the parameters `aangle` and `asize` are the current values of the settings `arrowangle` and `arrowsize`. The user-defined style can be enabled, in the same way as the built-in ones, with ‘`set arrowstyle xxxx`’. Fig. 3.4 shows the three predefined styles and a user-defined tip style that is defined by the following subroutine:

```
sub arrow_circle langle aangle asize
  circle 0.1 fill red
end sub
```

More complex examples of user-defined arrow styles can be found in the GLE example repository.

`set atitledist s`

The spacing between the graph axis title and the axis labels is set to `d`.

`set atitlescale s`

The graph axis title font size is set to ‘`atitlescale`’ times ‘`hei`’.

`set background ic`

Set the background color for a pattern fill to `c`. (See ‘`set fill`’.)

`set cap butt — round — square`

Defines what happens at the end of a wide line.

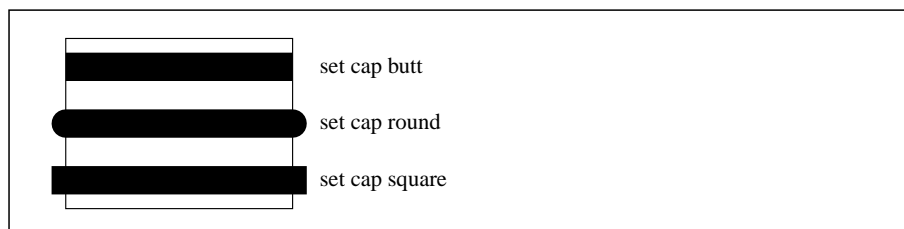

`set color col`

Sets the current colour for all future drawing operations. GLE supports all SVG/X11 standard color names. These are listed in Appendix A.7, and include the following: black, white, red, green, blue, cyan, magenta, yellow, gray10, gray20, ..., gray90. It is also possible to specify a gray scale as a real number with 0.0 = black and 1.0 = white. Colors can also be set using the HTML notation, e.g., `#FF0000` = red. Finally, the functions `rgb(red,green,blue)` and `rgb255(red,green,blue)` may be used to create custom colors. Fig. 3.5 gives some examples.

```
mm$ = "blue"
amove 0.5 0.5
for c = 0 to 1 step 0.05
  box 0.2 2 fill (c) nobox
  rmove 0.2 0
next c
amove 2 1
box 2 1 fill white nobox
rmove -0.2 0.2
box 2 1 fill mm$
```

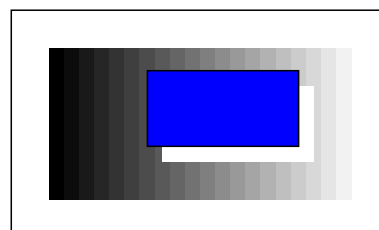



Figure 3.5: Examples of setting the drawing color.

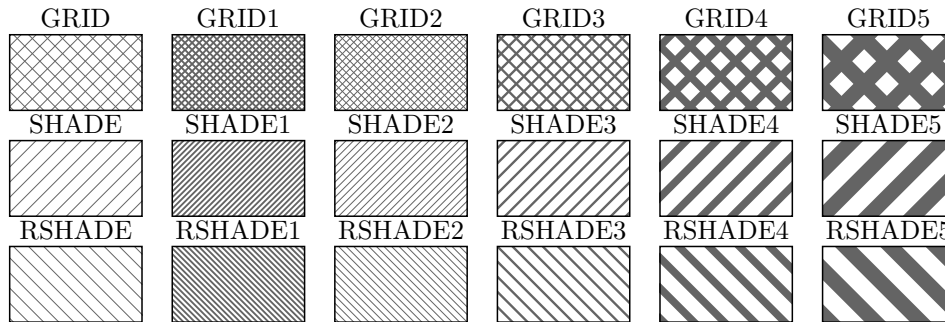

Figure 3.6: Patterns for painting shapes.

`set dashlen` *dashlen-exp*

Sets the length of the smallest dash used for the line styles. This command MUST come before the `set lstyle` command. This may be needed when scaling a drawing by a large factor.

`set fill` *fill color/pattern*

Sets the color or pattern for filling shapes. This command works in combination with shapes such as circles, ellipses, and boxes. If the argument is a color, then shapes are filled with the given color (see “set color”). If it is a pattern, then the shapes are painted with the given pattern in black ink. Fig. 3.6 lists a number of pre-defined patterns. To paint a shape in a color different from black, first set the color, then the pattern. That is,

```
set background yellow
set fill red
set pattern shade
box 2 2
```

will draw a box and paint it using the shade pattern and red ink on a yellow background. To draw shapes that are not filled, use the command “set fill clear”. That is,

```
set fill clear
box 2 2
```

will draw an empty box.

`set font` *font-name*

Sets the current font to *font-name*. Valid *font-names* are listed in Appendix A.2.

There are three types of font: PostScript, L<sup>A</sup>T<sub>E</sub>X and Plotter. They will all work on any device, however L<sup>A</sup>T<sub>E</sub>X fonts are drawn in outline on a plotter, and so may not look very nice. PostScript fonts will be emulated by L<sup>A</sup>T<sub>E</sub>X fonts on non-PostScript printers.

`set fontwidth` *line-width*

This sets the width of lines to be used to draw the stroked (Plotter fonts) on a PostScript printer. This has a great effect on their appearance.



```

set font pltr
amove .2 .2
text Tester
set fontwidth .1
set cap round
rmove 0 1.5
text Tester

```



set hei *character-size*

Sets the height of text. For historical reasons, concerning lead type and printing conventions, a height of 10cm actually results in capital letters about 6.5cm tall.

The default value of “hei” is 0.3633 (to mimic the default height of L<sup>A</sup>T<sub>E</sub>X expressions).

set join mitre — round — bevel

Defines how two wide lines will be joined together. With mitre, the outside edges of the join are extended to a point and then chopped off at a certain distance from the intersection of the two lines. With **round**, a curve is drawn between the outside edges.

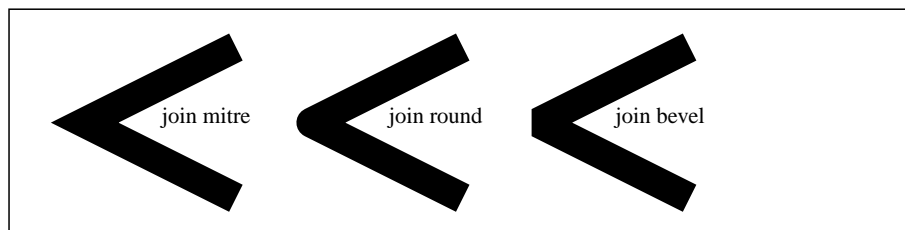

set just left | center | right | tl | etc...

Sets the justification which will be used for text commands.

```

amove 0.5 3
set just left
box 1.5 0.6
text Justify left
rmove 2 0
set just bl
box 1.5 0.6
text Justify bl

```

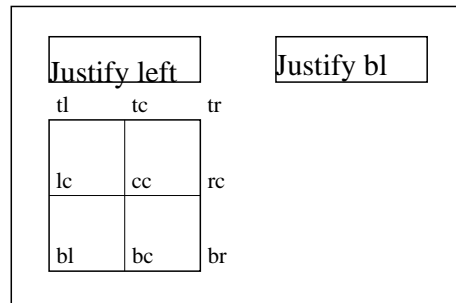

set lstyle *line-style*

Sets the current line style to line style number *line-style*. There are 9 predefined line styles (1–9). When a line style is given with more than one digit the first digit is read as a run length in black, the second a run length in white, the third a run length in black, etc.

```

set just left
for z = 0 to 4
  set lstyle z
  rline 2 0
  rmove 0.1 0
  write z
  rmove -2.1 -0.4
next z

```

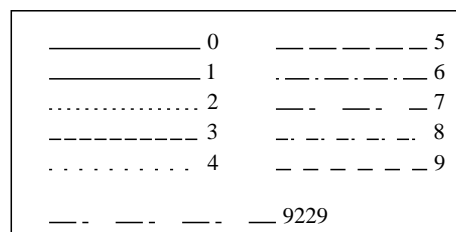

set lwidth *line-width*

Sets the width of lines to *line-width* cm. A value of zero will result in the device default of about 0.02 cm, so a lwidth of .0001 gives a thinner line than an lwidth of 0.

set pattern *fill pattern*

Specifies the filling pattern. A number of pre-defined patterns is listed in Fig. 3.6. See the description of “set fill” for more information.

set `texscale` *scale* | *fixed* | *none*

This setting controls the scaling of L<sup>A</sup>T<sub>E</sub>X expressions (Sec. 7.2): ‘`scale`’ scales them to the value of ‘`hei`’, ‘`fixed`’ scales them to the closest L<sup>A</sup>T<sub>E</sub>X default size to ‘`hei`’, and ‘`none`’ does not scale them. With ‘`none`’, the font size in your graphics will be exactly the same as in your main document.

set `titlescale` *s*

The graph title font size is set to ‘`titlescale`’ times ‘`hei`’.

set `ticksscale` *s*

The size of the graph axis ticks is set to ‘`ticksscale`’ times ‘`hei`’.

sub *sub-name* *parameter1* *parameter2* etc.

Defines a subroutine. The end of the subroutine is denoted with `end sub`. Subroutines must be defined before they are used.

Subroutines can be called inside any GLE expression, and can also return values. The parameters of a subroutine become local variables. Subroutines are re-entrant.

```
sub tree x y a$
  amove x y
  rline 0 1
  write a$
  return x/y
end sub

tree 2 4 "mytree"           (Normal call to subroutine)
slope = tree(2,4,"mytree") (Using subroutine in an expression)
```

tex *string* [*name xxx*] [*add val*]

Draw a L<sup>A</sup>T<sub>E</sub>X expression at the current point using the current value of ‘`justify`’. See Sec. 7.2 for more information. Using the `name` option, the L<sup>A</sup>T<sub>E</sub>X expression can be named, just like a box. The size of the virtual named box can be increased with the `add` option.

text *unquoted-text-string*

This is the simplest command for drawing text. The current point is unmodified after the text is drawn so following one text command with another will result in the second line of text being drawn on top of the first. To generate multiple lines of text, use the `begin text ... end text` construct.

```
text "Hi, how's tricks", said Jack!
```

write *string*\$ ...

This command is similar to `text` except that it expects a quoted string, string variable, or string expression as a parameter. If `write` has more than one parameter, it will concatenate the values of all the parameters.

```
a$ = "Hello there "
xx = sqrt(10)
t$ = time$()
c$ = a$+t$
write a$+t$ xx
```

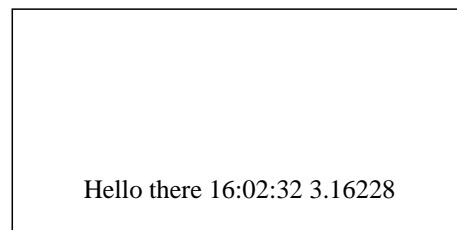

The built in functions `sqrt()` and `time$()` are described in Appendix A.2.



# Chapter 4

## The Graph Module

A graph should start with `begin graph` and end with `end graph`. The data to be plotted are organised into datasets. A dataset consists of a series of (X,Y) coordinates, and has a name based on the letter “d” and a number between 1 and 99, e.g. `d1`

The name `dn` can be used to define a default for all datasets. Many graph commands described below start with `dn`. This would normally be replaced by a specific dataset number e.g.,

```
d3 marker diamond
```

For each `xaxis` command there is a corresponding `yaxis`, `y2axis` and `x2axis` command for setting the top left and right hand axes. These commands are not explicitly mentioned in the following descriptions.

### 4.1 Graph Commands (a summary)

```
center
colormap fct pixels-x pixels-y [color] [invert] [zmin z1] [zmax z2] [palette pal]
data filename [d1 d2 d3 ...] [d1=c1,c3] [ignore n] [comment char]
dn [deresolve m] [average] line
dn err d5 errwidth width-exp errup nn% errdown d4
dn herr d5 herrwidth width-exp herrleft nn% errright d4
dn key "Dataset title"
dn line [impulses] [steps] [fsteps] [hist] [bar]
dn lstyle line-style lwidth line-width color col
dn marker marker-name [msize marker-size] [mdata dn]
dn nomiss
dn smooth — smoothm
dn svg_smooth [m]
dn xmin x-low xmax x-high ymin y-low ymax y-high
dn file "all.dat,xc,yc" [marker mname] [line]
fullsize
hscale h
key pos tl nobox hei exp offset xexp yexp
let ds = exp [from low] [to high] [step exp] [where exp]
let ds = x-exp, y-exp [from low] [to high] [step exp] [where exp]
let dn = [routine] dm [options]
let ds = hist dm [from x1] [to x2] [bins n] [step n]
let ds = ... [nsteps n]
let ds = ... [range dn]
math
nobox
scale h v
scale auto
size x y
title "title" [hei ch-hei] [color col] [font font] [dist cm]
under call
```

```

vscale v
x2labels on
xaxis — yaxis — x2axis — y2axis
xaxis angle  $\alpha$ 
xaxis base exp-cm
xaxis color col font font-name hei exp-cm lwidth exp-cm
xaxis dsubticks sub-distance
xaxis format format-string
xaxis grid
xaxis log
xaxis min low max high
xaxis nofirst nolast
xaxis nticks number dticks distance dsubticks distance
xaxis ftick x0 dticks distance
xaxis off
xaxis shift cm-exp
xlabel font font-name hei char-hei color col
xnames "name" "name" ...
xnames from dx
xnoticks pos1 pos2 pos3 ...
xplaces pos1 pos2 pos3 ...
xside color col lwidth line-width off
xsubticks lstyle num lwidth exp length exp off
xticks lstyle num lwidth exp length exp off
xtitle "title" [hei ch-hei] [color col] [font font] [dist cm] [adist cm]
y2title "text-string" [rotate]
yaxis negate
bar dx,... dist spacing
bar dn,... fill f pattern p
bar dx,... from dy,...
bar dn,... horiz
bar dn,... width xunits,... fill col,... color col,...
fill x1,d3 color green xmin val xmax val
fill d4,x2 color blue ymin val ymax val
fill d3,d4 color green xmin val xmax val
fill d4 color green xmin val xmax val

```

## 4.2 Graph Commands (in detail)

### center

Centers the graph (including the title and axis labels) in the graph box. (The command ‘scale auto’ implicitly performs ‘center’.)

```
colormap fc pixels-x pixels-y [color] [invert] [zmin z1] [zmax z2] [palette pal]
```

The colormap command is discussed in Section 8.5.

```
data filename [d1 d2 d3 ...] [d1=c1,c3] [ignore n] [comment char]
```

Specifies the name of a file to read data from. By default, the data will be read into the next free datasets unless the optional specific dataset names are specified.

A dataset consists of a series of (X,Y) coordinates, and has a name based on the letter **d** and a number between 1 and 99, e.g. **d1** or **d4**. Up to 99 datasets may be defined.

From a file with 3 columns the command ‘data "data.csv"’ would read the first and second columns as the x and y values for dataset 1 (d1) and the first and third columns as the x and y values for dataset 2 (d2). The next data command would use dataset 3 (d3).

Such a data file looks like this:

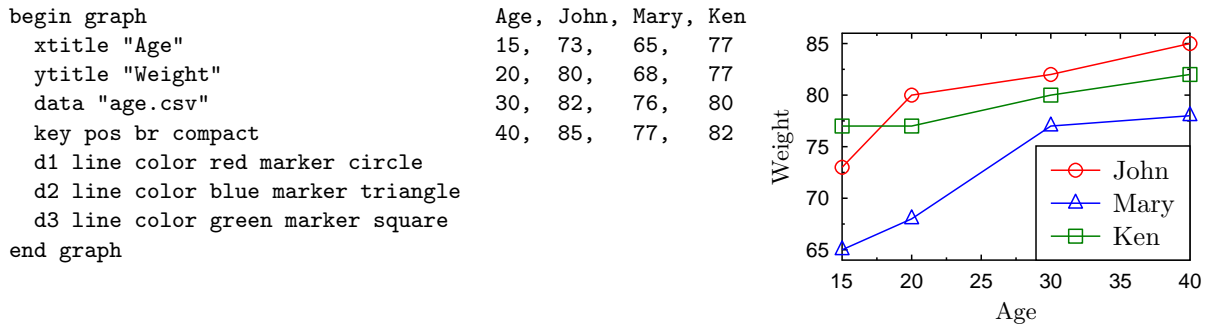

Figure 4.1: Line graph with key taken from the column labels in the first data row. Left: the graph block; middle: the dataset “age.csv”; right: the resulting graph.

```

1, 2.7, 3
2, 5, *
3, 7.8, 7
4, 9, 4

```

The first point of dataset **d1** would then be **(1, 2.7)** and the first point of dataset **d2** would be **(1, 3)**. The data values can be space, tab, comma, or semi-colon separated.

Missing values can be indicated with “\*”, “?”, “-”, or “.”.

The option `d3=c2,c3` allows particular columns of data to be read into a dataset. In this example, `d3` would read its x-values from column 2 and y-values from column 3.

```

size 7 3.5
begin graph
  size 6 3
  title "Simple Graph"
  xtitle "Time"
  ytitle "Output"
  data "data.csv"
  d1 line marker triangle color red
end graph

```

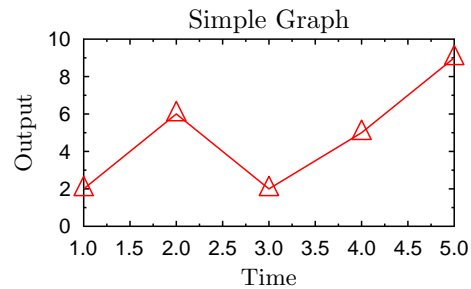

**Comments:** Comments can be included with the symbol “!”. All characters from “!” until the end of the line of the data file are ignored. It is possible to change the symbol that indicates a comment with the option ‘comment’. E.g., with ‘data “data.csv” comment #’, lines starting with # will be treated as comments.

**Ignore header:** The option `ignore n` makes GLE ignore the first  $n$  lines of the data file. This is useful if the first  $n$  lines do not contain data.

**Auto key:** If the first row of a data file does not contain actual data but instead contains column labels, then these labels are used by GLE to create a key for the graph (Chapter 5). GLE automatically detects this case by checking if all fields in the first row are valid numbers or not. If not, then GLE assumes that the first row contains column labels. Column labels that include a space or that could be incorrectly interpreted as a number should be double quoted. Fig. 4.1 illustrates this with an example.

**Auto x-labels:** If the first column of a data file does not contain numeric data, but instead contains symbolic labels, then these labels are used to label the horizontal axis. For example, if the data file contains

```

Mon, 1
Tue, 4
Wed, 3.5
Thu, 2
Fri, 1
Sat, 5
Sun, 4

```

then GLE creates an x-axis with one label for each day of the week, similar to that of the graph in Fig. 4.11.

`dn [deresolve m] [average] line`

The ‘deresolve’ option sub-samples a dataset. Given the parameter  $m > 1$ , it keeps only 1 out of every  $m$  points (starting with the first point). If the option ‘average’ is given, then it will compute the average of the y-values of every window of  $m$  points. This average value will be plotted at the middle (x-value) of the window. The ‘deresolve’ option never removes the first and last point in a dataset if it is used in conjunction with ‘dn line’.

`dn err d5 errwidth width-exp dn errup nn% errdown d4`

For drawing error bars on a graph. The error bars can be specified as an absolute value, as a percentage of the y value, or as a dataset. The up and down error bars can be specified separately e.g.,

```
d3 err .1
d3 err 10%
d3 errup 10% errdown d2
d3 err d1 errwidth .2
```

```
begin graph
  title "Error Bars"
  dn lstyle 2 msize 1.5
  d1 marker circle errup 30% errdown 1
  d2 marker square err 30% errwidth .1
end graph
```

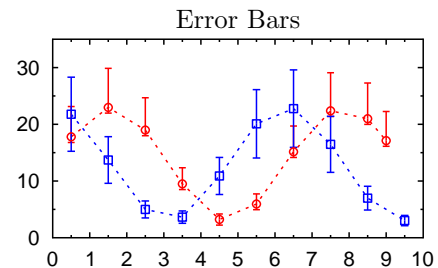

`dn herr d5 herrwidth width-exp dn herrleft nn% herrright d4`

These commands are identical to the error bar commands above except that they will draw bars in the horizontal plane.

`dn key "Dataset title"`

If a dataset is given a title like this a key will be drawn. Use the key command (below, after `hscale`) to set the size and position of the key. Use the key module (Chapter 5) to draw more complex keys.

`dn line [impulses] [steps] [fsteps] [hist] [bar]`

This tells GLE to draw lines between the points of the dataset. By default GLE will not draw lines or markers, this is often the reason for a blank graph.

If a dataset has missing values GLE will not draw a line to the next real value, which leaves a gap in the curve. To avoid this behavior simply use the `nomiss` qualifier on the `dn` command used to define the line. This simply throws away missing values so that lines are drawn from the last real value to the next real value.

The options `impulses`, `steps`, `fsteps`, `hist`, and `bar` draw lines as shown in Figure 4.2.

- `impulses`: connects each point with the xaxis.
- `steps`: connects consecutive points with two line segments: the first from  $(x_1, y_1)$  to  $(x_2, y_1)$  and the second from  $(x_2, y_1)$  to  $(x_2, y_2)$ .
- `fsteps`: connects consecutive points with two line segments: the first from  $(x_1, y_1)$  to  $(x_1, y_2)$  and the second from  $(x_1, y_2)$  to  $(x_2, y_2)$ .
- `hist`: useful for drawing histograms: assumes that each point is the center of a bin of the histogram.
- `bar`: similar to ‘hist’, but now also separates the bins with vertical lines.

`dn lstyle line-style lwidth line-width color col`

These qualifiers are all fairly self explanatory. See the `lstyle` command in Chapter 3 (Page 20) for details of specifying line styles.

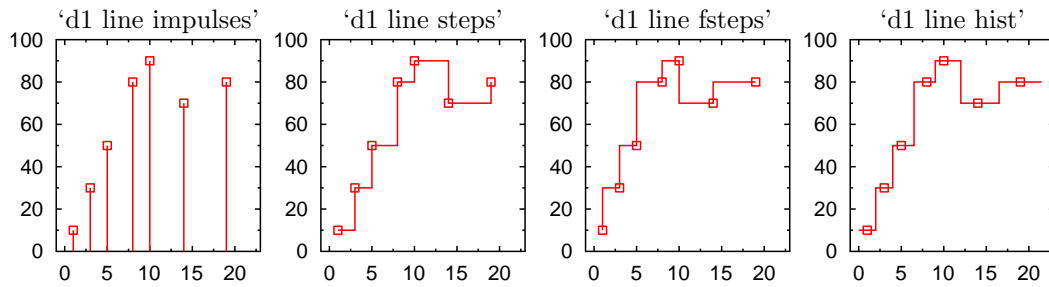

Figure 4.2: The impulses, steps, fsteps, and hist options of the line command.

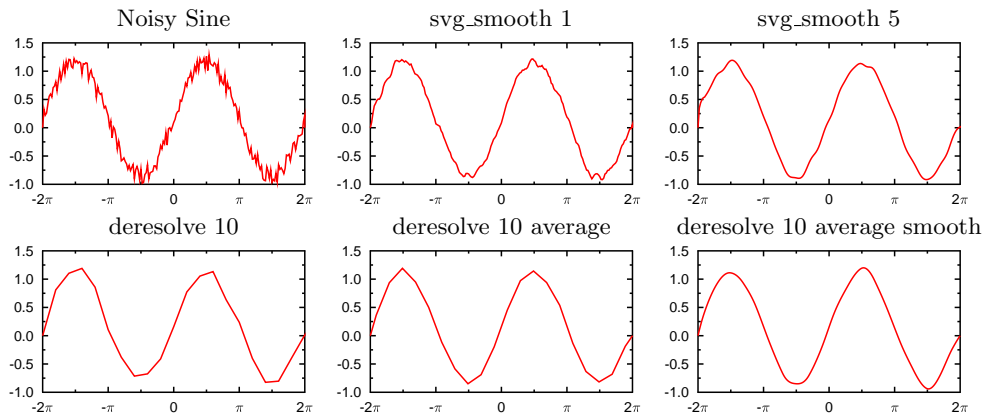

Figure 4.3: Various smooth options.

`dn marker marker-name [msize marker-size] [mdata dn]`

Specifies the marker to be used for the dataset. There is a set of pre-defined markers (refer to Appendix A.1 for a list) which can be specified by name (e.g., circle, square, triangle, diamond, cross, ...). Markers can also be a user-defined subroutine (See the `define marker` command in Chapter 2). The `mdata` option allows a secondary dataset to be defined which will be used to pass another parameter to the marker subroutine, this allows each marker to be drawn at a different angle, size or colour.

The `msize` qualifier sets the marker size for that dataset. The size is a character height in cm, so that the actual size of the markers will be about 0.7 of this value.

`dn nomiss`

If a dataset has missing values, GLE will not draw a line to the next real value, which leaves a gap in the curve. To avoid this behavior simply use the `nomiss` qualifier on the `dn` command used to define the line. This simply ignores missing values.

```
begin graph
  title "Ignore missing values (nomiss)"
  xtitle "Time"
  ytitle "Output"
  data "tut.dat"
  d1 lstyle 2
  d2 nomiss lstyle 1 marker diamond msize .2
end graph
```

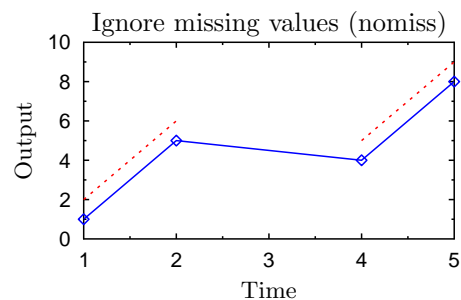

`dn [smooth] [smoothm] line`

This will make GLE draw a smoothed line through the points. A third degree polynomial is fitted piecewise to the given points.

The `smoothm` alternative will work for multi valued functions, i.e., functions which have more than one y value for each x value.



dn [svg\_smooth] [m] line

The option `svg_smooth` performs a quadratic or cubic and 7 point Savitsky Golay smoothing on the data. The parameter `m` specifies the number of iterations of smoothing, that is, the smoothing algorithm is run `m` times on the dataset. Fig. 4.3 shows an example.

dn xmin *x-low* xmax *x-high* ymin *y-low* ymax *y-high*

These commands map the dataset onto the graph's boundaries. The data will be drawn as if the X axis was labelled from *x-low* to *x-high* (regardless of how the axis is actually labelled). A point in the dataset at  $X = x\text{-low}$  will appear on the left hand edge of the graph.

dn file "all.dat,xc,yc" [marker mname] [line]

The 'file' option specifies a file from which the dataset is to be loaded. This option is an alternative to the "data" command (p. 24).

By default the first two columns of the data file will be read in, but other columns may be specified. E.g., "all.dat,3,2" would read *x*-values from column 3 and *y*-values from column 2. Or, to read the 4th dataset, specify the file as "all.dat,1,5".

If the *x* column is specified as '0' then GLE will generate the *x* data points. E.g., 1,2,3,4,5...

The file option also accepts variables in place of the file name, e.g.:

```
x$ = "test.dat,2,3"
d1 file x$ line color red
```

fullsize

This is equivalent to `scale 1 1, noborder`. It makes the graph size command specify the size and position of the axes instead of the size of the outside border. See Fig. 4.8 (right) for an example.

hscale *h*

Sets the length of the xaxis to *h* times the size of the graph box (default is 0.7). *h* can also be set to 'auto'. See `scale` for more details.

key pos *tl* nobox hei *exp* offset *xexp* *yexp*

This command allows the features of a key to be specified. The `pos` qualifier sets the position of the key. E.g., `tl=topleft, br=bottomright`, etc.

let ds = *exp* [from *low*] [to *high*] [step *exp*] [where *exp*]

This command defines a new dataset as the result of an expression on the variable *x* over a range of values. For example:

```
let d1 = sin(x)+log(x) from 1 to 100 step 1
```

**NOTE: The lack of spaces inside the expression are necessary.**

Here are some further examples:

```
begin graph
  ...
  let d1 = 1/x from 0.2 to 10
  let d2 = sin(x)*2+2 from 0 to 10
  let d3 = 10*(1/sqrt(2*pi))* &
    exp(-2*(sqr(x-4)/sqr(2))) &
    from 0.2 to 10 step 0.1
  dn line
  d2 lstyle 2 color red
  d3 lstyle 3 color blue
end graph
```

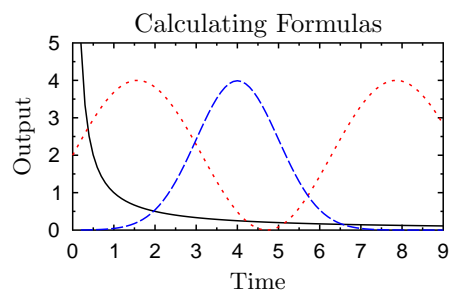

The `let` command also allows the use of other datasets. E.g., to generate an average of two datasets:

```
data "file.csv" d1 d2
let d3 = (d1+d2)/2
```

More precisely, this command creates a dataset with as  $x$ -values the union of the  $x$ -values from  $d1$  and  $d2$ , and as  $y$ -values the average of the  $y$ -values of  $d1$  and  $d2$ . That is, the `let` command first computes the set of  $x$ -values by taking the union of the sets of  $x$ -values of all datasets that appear in the expression together with the  $x$ -values generated by the `from/to/step` construct. Then it iterates over these  $x$ -values. In each iteration, it assigns the  $x$ -value to the variable ‘ $x$ ’, and, for each dataset included in the expression, it assigns its corresponding  $y$ -value to the dataset identifier. Then it evaluates the given expression  $exp$  and adds the resulting point  $(x, exp)$  to the target dataset. If the `let` expression includes more than one dataset, and the  $x$ -ranges of these datasets are different, then linear interpolation is used to compute the missing  $y$ -values.

If the  $x$ -axis is a ‘log’ axis then the ‘step’ option is read as the number of steps to produce rather than the size of each step. The “from”, “to”, and “step” parameters are optional. The values of “from” and “to” default to the horizontal axis’ range.

This command can also be used to modify the values in a data set, e.g., ‘`let d1 = 2*d1`’, will multiply all  $y$ -values in dataset  $d1$  by 2.

The option ‘where  $exp$ ’ can be used to select values from a dataset, e.g., ‘`let d1 = d2 where ((x > 10) and (x < 20))`’ will select all points from  $d2$  for which the  $x$ -value is between 10 and 20; ‘`let d1 = d2 where d2 < 10`’ will select all points for which the  $y$ -value is below 10.

`let ds = x-exp, y-exp [from low] [to high] [step exp] [where exp]`

This syntax for the ‘let’ command is similar to the previous one, but now two expressions can be given:  $x-exp$  is used to compute the  $x$ -values of the points in the target dataset ‘ $ds$ ’ and  $y-exp$  is used to compute the  $y$ -values. The parameter that is modified by the `from/to/step` construct is still the variable ‘ $x$ ’.

This syntax can be used to perform transformations on both the  $x$  and the  $y$ -values of the points in a dataset. For example,

```
let d1 = 2*x, d1+4
```

will multiply the  $x$ -values of  $d1$  by 2 and add 4 to the  $y$ -values.

This syntax can also be used to define datasets that are not functions. The following example defines a circle:

```
let d1 = sin(x), cos(x) from 0 to 2*pi
```

`let dn = [routine] dm [options] [slopevar] [offsetvar] [rsqvar]`

GLE includes several fitting routines that allow an equation to be fit to a data series. These routines can be included in a ‘let’ expression as shown above, where  $dn$  will contain results of fitting routine to the data in  $dm$ .

The following routines are available :

- **linfit**: fits the data in  $dm$  to the straight line equation  $y = m \cdot x + b$ .
- **logfit**: fits the data in  $dm$  to the equation  $y = a \cdot \exp(b \cdot x)$ .
- **log10fit**: fits the data in  $dm$  to the equation  $y = a \cdot 10^{b \cdot x}$ .
- **powxfit**: fits the data in  $dm$  to the equation  $y = a \cdot x^b$ .

The value for  $a$  is stored in ‘*slopevar*’ and the value for  $b$  is stored in ‘*offsetvar*’. The  $r^2$  value of the fit is stored in ‘*rsqvar*’. Note that these variables are optional.

The following options are available :

- **from**  $xmin$  to  $xmax$  The range of the data in  $dn$  extends from the  $xmin$  to  $xmax$  as specified by the user.
- **step**  $xstep$  Specifies the  $x$ -resolution of the fitted equation. Similar to the `step` option of the `let` command.
- **rsq**  $var$  The  $r^2$  value of the fit will be stored in  $var$ .
- **xmin**  $x1$ , **xmax**  $x2$ , **ymin**  $y1$ , **ymax**  $y2$  Only use data points from  $dm$  in the given window to fit the equation. That is, only data points  $(x, y)$  from  $dm$  are used for which  $x_1 \leq x \leq x_2$  and  $y_1 \leq y \leq y_2$ .

```

slope = 0; offs = 0; rsquare = 0

set texlabels 1
begin graph
  title "Linear fit"
  xtitle "$x$"
  ytitle "$y = ax + b$"
  data "data.csv"
  let d2 = linfit d1 from 0 to 10 slope offset rsquare
  d1 marker circle color blue
  d2 line color red
end graph

begin key
  pos br nobox
  text "$y = "+format$(slope,"fix 2")+ "x + "+format$(offset,"fix 2")+ "$"
  text "$r^2 = "+format$(rsquare,"fix 2")+ "$"
end key

```

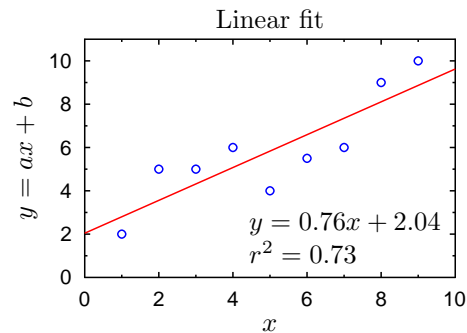

Figure 4.4: Fitting linear equations ‘let d2 = fitlin d1’.

- `limit_data_x` The range of the data in `dn` extends from the minimum  $x$  value in `dm` to the maximum  $x$  value in `dm`.
- `limit_data_y` The range of the data in `dn` extends from the  $x$  value of the minimum  $y$  value in `dm` to the  $x$  value of the maximum  $y$  value in `dm`.
- `limit_data` The range of the data in `dn` extends from the greater of the  $x$  value of the minimum  $y$  value or the minimum  $x$  value in `dm` to the greater of the  $x$  value of the maximum  $y$  value or the maximum  $x$  value in `dm`.

let `dn = fit dm` with `eqn` [options]

Fit the coefficients of a given equation so that it best fits the data in dataset `dm`. Fig. 4.5 shows an example. The equation to fit is given by the ‘with’ option. In this example, it is  $a \sin(bx) + cx^2 + d$ . GLE will search for values for the coefficients  $a$ ,  $b$ ,  $c$ , and  $d$  such that the given equation fits `dm` best. Note that all used coefficients must be initialized to zero before the graph block (see figure).

The fit command has the same options as the `linfit` command. In addition, it has the following settings.

- `with eqn` Gives the equation to fit.
- `eqstr strvar$` Sets the string variable in which the string representation of the fitted equation is to be stored.
- `format fmt$` Sets the numeric format to use while converting the fitted equation into its string representation. See the documentation of `format$` on page 48 for a description of the syntax.

let `ds = hist dm` [from `x1`] [to `x2`] [bins `n`] [step `n`]

Computes a histogram for the values in ‘`dm`’ and store the result in ‘`dn`’. E.g., if the file ‘`normal.csv`’ contains a single column with samples from the standard Gaussian distribution, then the graph block

```

begin graph
  ...
  data "normal.csv"
  let d2 = hist d1 step 0.5
  d2 line bar color red
end graph

```

will result in the histogram shown in Fig. 4.6.

let `ds = ...` [nsteps `n`]

The ‘`nsteps`’ options is an alternative to the ‘`step`’ option of the ‘`let`’ command. It specifies the total number of steps rather than the step width. The default value for ‘`nsteps`’ is 100.

```

a = 0; b = 0; c = 0; d = 0; r = 0

set texlabels 1
begin graph
  xtitle "$x$"
  ytitle "$f(x)$"
  title "$f(x) = a\sin(bx)+cx^2+d$"
  data "data.csv"
  let d2 = fit d1 with a*sin(b*x)+c*x^2+d rsq r
  d1 marker circle color blue
  d2 line color red
end graph

fct$ = "$f(x) = "+format$(a,"fix 2")+ &
      "\sin("+format$(b,"fix 2")+ "x")+ "+ &
      format$(c,"fix 2")+ "x^2+" + &
      format$(d,"fix 2")+ "$"

begin key
  pos br nobox
  text fct$
  text "$r^2$ = "+format$(r,"fix 3")
end key

```

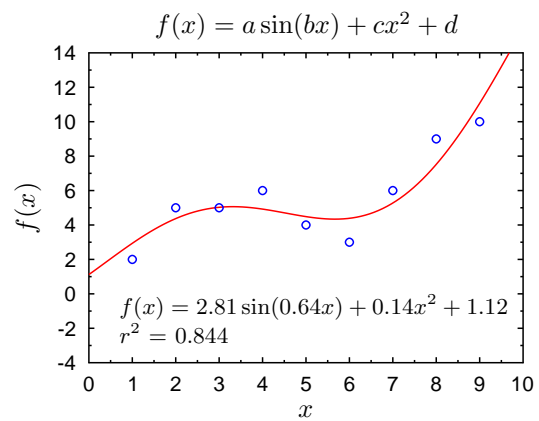

Figure 4.5: Fitting arbitrary curves ‘let d2 = fit d1 with ...’.

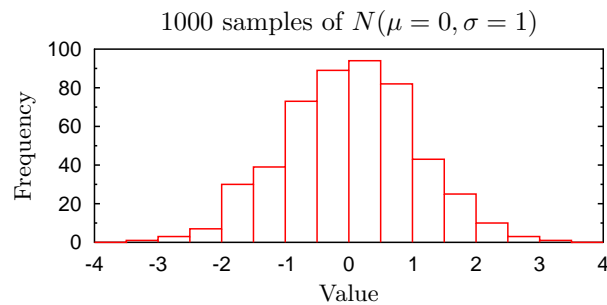

Figure 4.6: An example of ‘let dn = hist dn’.

```
let ds = ... [range dn]
```

Takes the x-values for this ‘let’ expression from dataset ‘dn’. This is useful if you need to define a function for the same x-values as the ones you have in a given dataset.

**math**

Use this option to create a math mode graph, with the axis crossing at point (0,0). Fig. 4.7 shows an example. The corresponding GLE code is as follows:

```

begin graph
  math
  title "f(x) = sin(x)"
  xaxis min -2*pi max 2*pi ftick -2*pi dticks pi format "pi"
  yaxis dticks 0.25 format "frac"
  let d1 = sin(x)
  d1 line color red
end graph

```

**nobox**

This removes the outer border from the graph.

**size x y**

Defines the size of the graph in cm. This is the size of the outside box of a graph. The default size of the axes of the graph will be 70% of this, (see `scale`). If no `size` command is given, then the size of the graph is initialized to the size of the figure (`pagewidth()` by `pageheight()`).

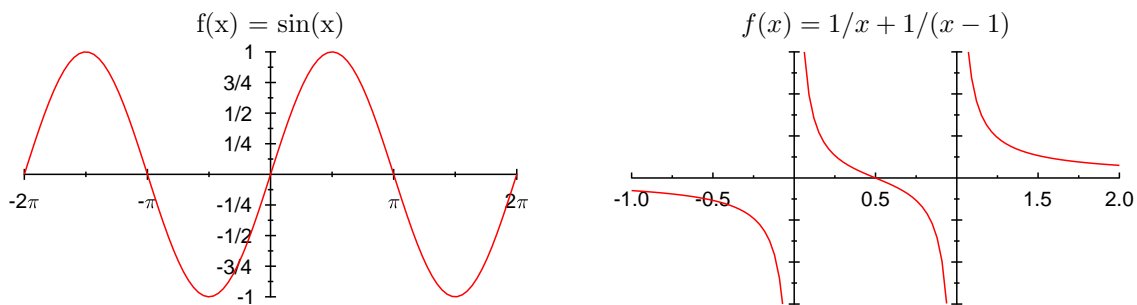

Figure 4.7: Left: math mode graph. Right: graph illustrating the ‘origin’ option of ‘axis’.

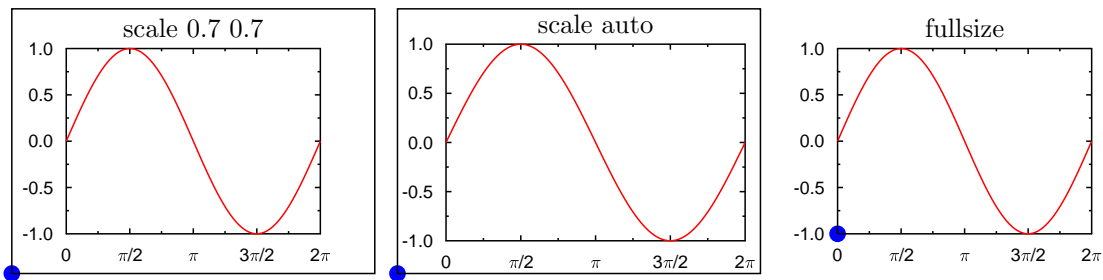

Figure 4.8: Different axis scaling options: default, automatic, and ‘fullsize’. The blue dot indicates the origin  $(x, y)$  of the graph, that is, the graph is generated with ‘`amove x y`’ followed by ‘`begin graph`’ ... ‘`end graph`’. The xaxis is labeled using the option ‘`format pi`’.

#### scale $h v$

Sets the length of the xaxis to  $h$  times the width of the graph box, and the length of the yaxis to  $v$  times the height of the graph box. For example, with ‘`size 10 10`’ and ‘`scale 0.7 0.7`’, the length of the  $x$  and  $y$  axis will be 7 centimeter. ‘`scale 1 1`’ makes the xaxis (yaxis) the same length as the width (height) of the graph box, which is useful for positioning some graphs (see ‘`fullscale`’). The default value for  $h$  and  $v$  is 0.7.

If  $h$  or  $v$  is set to the keyword `auto`, then the graph is scaled automatically in that direction to fill the entire box. The command ‘`scale auto`’ automatically scales the graph in both directions. Note that autoscale also moves the graph, similar to the command ‘`center`’.

This `size` command is equivalent to the two commands ‘`hscale h`’ and ‘`vscale v`’ and allows one to specify the two scale factors with one command.

Fig. 4.8 shows examples of the different axis scaling options: default, automatic, and ‘fullsize’.

#### title “*title*” [`hei ch-hei`] [`color col`] [`font font`] [`dist cm`]

This command gives the graph a centered title. The list of optional keywords specifies features of it. The `dist` command is used for moving the title up or down. The default title font size is the value of the ‘`hei`’ setting multiplied by the setting ‘`titlescale`’ (default 1.16).

#### vscale $v$

Sets the length of the yaxis to  $v$  times the size of the graph box (default is 0.7).  $v$  can also be set to ‘`auto`’. See `scale` for more details.

#### under call

Executes subroutine ‘`call`’ before drawing the graph. The output is clipped to the graph window and the subroutine can use the functions ‘`xg()`’, ‘`yg()`’, and variables ‘`xgmin`’, ‘`ygmin`’, etc. This is useful for drawing a custom graph background. It is also possible to include subroutine calls in the graph block without the ‘`under`’ keyword. In that case, they are executed after the graph is drawn and can be used to draw on top of the graph.

#### x2labels on

This command ‘`activates`’ the numbering of the x2axis. There is a corresponding command ‘`y2axis on`’ which will activate y2axis numbering.

`xaxis` — `yaxis` — `x2axis` — `y2axis`

A graph is considered to have four axes: The normal `xaxis` and `yaxis` as well as the top axis (`x2axis`) and the right axis (`y2axis`).

Any command defining an `xaxis` setting will also define that setting for the `x2axis`.

The secondary axes `x2` and `y2` can be modified individually by starting the axis command with the name of that axis. E.g.,

```
begin graph
  size 6 3
  xtitle "X-axis"
  ytitle "Y-axis"
  x2title "X2-axis"
  y2title "Y2-axis"
  x2ticks length 0.6
  x2subticks color red
end graph
```

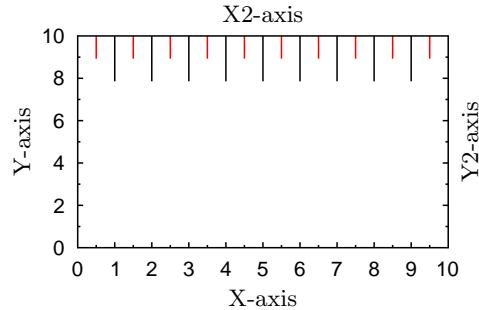

`xaxis angle`  $\alpha$

Rotate the labels by  $\alpha$  degrees. Fig. 4.12 gives an example.

`xaxis base` *exp-cm*

Scale the axis font and ticks by *exp-cm*. The default value of the 'base' setting is the value of 'hei'.

`xaxis color` *col font font-name hei exp-cm lwidth exp-cm*

These axis qualifiers affect the colour, `lstyle`, `lwidth`, and font used for drawing the `xaxis` (and the `x2axis`). These can be overridden with more specific commands. E.g., '`xticks color blue`' would override the axis colour when drawing the ticks. The subticks would also be blue as they pick up tick settings by default.

`xaxis dsubticks` *sub-distance*

See `xaxis nticks` below.

`xaxis format` *format-string*

Specifies the number format for the labels. See the documentation of `format$` on page 48 for a description of the syntax. Example:

```
xaxis format "fix 1"
```

`xaxis grid`

This command makes the `xaxis` ticks long enough to reach the `x2axis` and the `yaxis` ticks long enough to reach the `y2axis`. When used with both the `x` and `y` axes this produces a grid over the graph. Use the `xticks lstyle` command to create a faint grid.

`xaxis log`

Draws the axis in logarithmic style, and scales the data logarithmically to match (on the `x2axis` or `y2axis` it does not affect the data, only the way the ticks and labeling are drawn)

Be aware that a straight line should become curved when drawn on a log graph. This will only happen if you have enough points or have used the `smooth` option.

`xaxis min` *low max high*

Sets the minimum and maximum values on the `xaxis`. This will determine both the labeling of the axis and the default mapping of data onto the graph. To change the mapping see the dataset `dn` commands `xmin`, `ymin`, `xmax`, and `ymax`.

`xaxis nofirst nolast`

These two switches simply remove the first or last (or both) labels from the graph. This is useful when the first labels on the `x` and `y` axis are too close to each other.

`xaxis nticks` *number dticks distance dsubticks distance*

`nticks` specifies the number of ticks along the axis. `dticks` specifies the distance between ticks and `dsubticks` specifies the distance between subticks. For example, to get one subtick between every

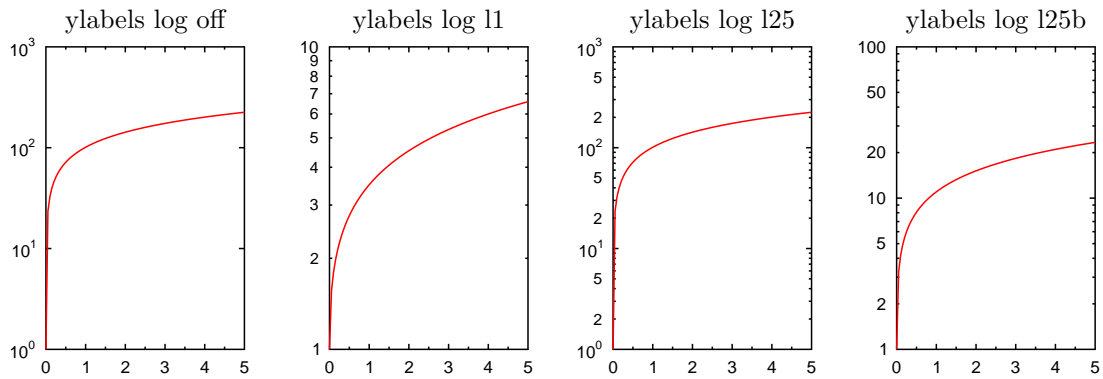

Figure 4.9: Possibilities for the ‘log’ option of ‘ylabel’.

main tick with main ticks 3 units apart, simply specify `dsbticks 1.5`. Alternatively, one can also use `nsbticks`.

By default ticks are drawn on the inside of the graph. To draw them on the outside use the command:

```
xticks length -.2
yticks length -.2
```

`xaxis ftick  $x0$  dticks  $distance$  nticks  $number$`

Labels the xaxis starting from position ‘ $x0$ ’, with distance ‘ $distance$ ’ between the ticks. This will result in a tick at the positions  $x0 + i \times distance$ , with  $i$  ranging from 0 to  $(number - 1)$ .

`xaxis off`

Turns the whole axis off — labels, ticks, subticks and line. Often the `x2axis` and `y2axis` are not required, they could be turned off with the following commands:

```
x2axis off
y2axis off
```

`xaxis shift  $cm-exp$`

This moves the labeling to the left or right, which is useful when the label refers to the data between the two values.

`xlabels [font  $font-name$ ] [hei  $char-hei$ ] [color  $col$ ] [dist  $dis$ ] [on] [off] [log  $lgmode$ ]`

This command controls the appearance of the axis labels. The default label font size is the value of the ‘`hei`’ setting multiplied by the setting ‘`alabelscale`’ (default 0.8). The default value for `dist` is controlled by the setting ‘`alabeldist`’.

The command ‘`xlabels off`’ turns the labels for the xaxis off. Similarly, ‘`xlabels on`’ turns them on (the default for the  $x$  and  $y$  axis, but not for the  $x2$  and  $y2$  axis).

Possible values for `lgmode` are: ‘`off`’, ‘`l1`’, ‘`l25`’, and ‘`l25b`’. These control the subticks for a log scale axis. The value ‘`off`’ means no subticks (i.e., only main ticks at  $10^k$ ), ‘`l1`’ means 10 subticks, and ‘`l25`’ means two subticks at the positions  $2 \cdot 10^k$  and  $5 \cdot 10^k$ . The value ‘`l25b`’ is identical to ‘`l25`’ except that now the format function (given with the ‘`format`’ option of the ‘`xaxis`’ command) is used to label the subticks. In the other case, the subticks are labeled with the values ‘`2`’ and ‘`5`’ in a small font (0.7 times the size of the main tick labels). These settings are illustrated in Fig. 4.9.

`xnames "name" "name" ...`

This command replaces the numeric labeling with text labels. Given data consisting of seven measurements, taken from Monday to Sunday, one per day then

```
xnames "Mon" "Tue" "Wed" "Thu" "Fri" "Sat" "Sun"
xaxis min 0 max 6 dticks 1
```

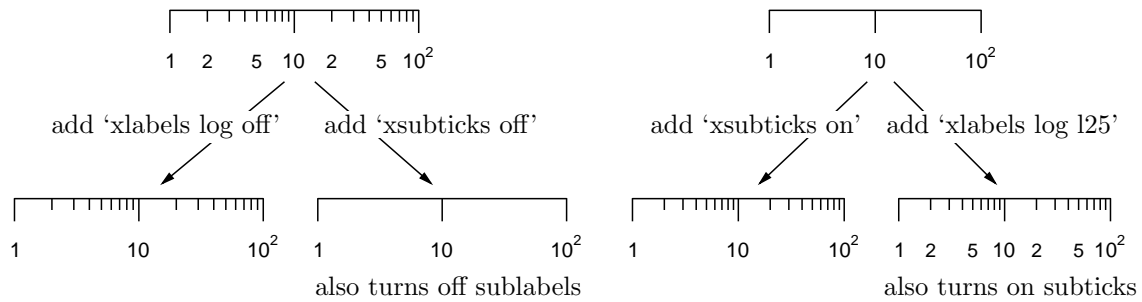

Figure 4.10: How log subticks and log sublabels interact.

```
begin graph
  ytitle "Happyness"
  title "Names \& Places"
  xnames "Mon" "Tue" "Wed" "Thu"
  xnames "Fri" "Sat" "Sun"
  xaxis min 0 max 6 dticks 1
  ...
end graph
```

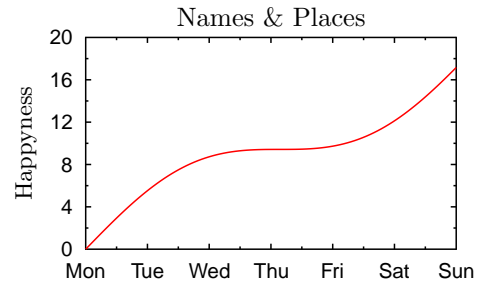

Figure 4.11: Example illustrating the “xnames” command.

would give the desired result (Fig. 4.11). Note it is essential to define a specific axis minimum, maximum, dticks, etc., otherwise the labels may not correspond to the data.

If there isn’t enough room on the line for all the names then simply use an extra xnames command.

xnames from *dx*

Takes the labels for the xaxis from dataset *dx*. For example, if the data file contains:

```
0, Mercury, 0.382
1, Venus, 0.949
2, Mars, 0.532
3, Jupiter, 11.21
4, Saturn, 9.449
5, Uranus, 4.007
6, Neptune, 3.883
```

then ‘ynames from d1’ uses the data from the second column as labels for the yaxis (Fig. 4.12).

xnoticks *pos1 pos2 pos3 ...*

Disables the axis ticks at the given positions.

xplaces *pos1 pos2 pos3 ...*

This is similar to the xnames command but it specifies a list of points which should be labelled. This allows labeling which isn’t equally spaced. For example:

```
xplaces 1 2 5 7
xnames "Mon" "Tue" "Fri" "Sun"
```

If there isn’t enough room on the line for all the places then simply use an extra xplaces command.

xside color *col* lwidth *line-width* off

This command controls the appearance of the axis line, i.e. the line to which the ticks are attached.

xsubticks lstyle *num* lwidth *exp* length *exp* off

This command gives fine control of the appearance of the axis subticks.



`xticks lstyle num lwidth exp length exp off`

This command gives fine control of the appearance of the axis ticks. Note: To get ticks on the outside of the graph, i.e. pointing outwards, specify a negative tick length:

```
xticks length -.2
yticks length -.2
```

`xtitle "title" [hei ch-hei] [color col] [font font] [dist cm] [adist cm]`

This command gives the axis a centered title. The list of optional keywords specify features of it. The `dist` option is used for controlling the distance between the title and the axis labels. The default font size is the value of the `'hei'` setting multiplied by the setting `'atitlescale'` (default 1.0). The default value for `dist` is controlled by the setting `'atitledist'`. The `'adist'` option is an alternative to `'dist'`, but specifies the distance between the title and axis itself. This option is useful for perfectly aligning, e.g., the y-axis titles of multiple graphs (if the graphs are in one vertical column, but their y-axis labels have a different width).

`xaxis negate`

This is reversed the numbering on the y axis. For use with measurements below ground, where you want zero at the top and positive numbers below the zero.

`y2title "text-string" [rotate]`

By default the `y2title` is written vertically upwards. The optional `rotate` keyword changes this direction to downwards. The `rotate` option is specific to the `y2title` command.

```
begin graph
  xaxis min 0 max 9 nofirst nolast
  xaxis hei 0.4 nticks 6 dsubticks 0.3
  xaxis lwidth 0.05 color red
  xticks length 0.2
  ytitle "Log Yaxis"
  yaxis log min 1 max 10
  yticks length 0.2
  y2axis min 1 max 10000 format "sci 0 10"
  y2side color blue
  y2title "Y2title rotated " hei 0.3 rotate
  x2axis off
  y2labels on
  let d1 = sin(x)*4+5 from 0 to 9
  dn line color blue
end graph
```

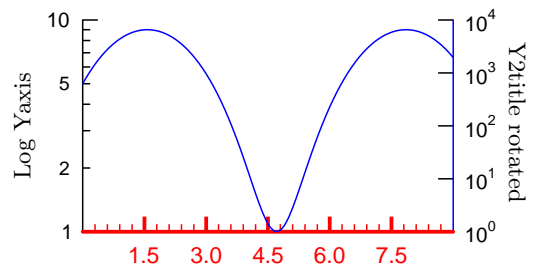

## 4.3 Bar Graphs

Drawing a bar graph is a subcommand of the normal graph module. This allows bar and line graphs to be mixed. The `bar` command is quite complex as it allows a great deal of flexibility. The same command allows stacked, overlapping and grouped bars.

For stacked bars use separate bar commands as in the first example below:

```
bar d1 fill black
bar d2 from d1 fill gray10
```

For grouped bars put all the datasets in a list on a single bar command:

```
bar d1,d2,d3 fill gray10,gray40,black
```

```
begin graph
  title "Bean stalk data" dist 0.1
  xtitle "Year measured"
  ytitle "Height of stalk"
  xaxis dticks 1
  yaxis min 0 max 6 dticks 2
  data "gc_bean.dat"
  bar d1,d2,d3 fill blue,orange,red
end graph
```

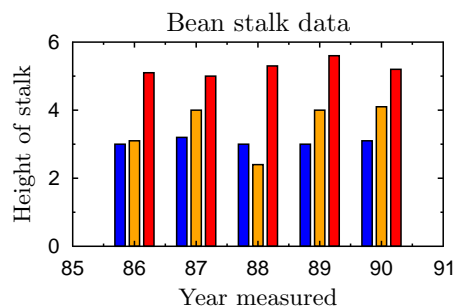

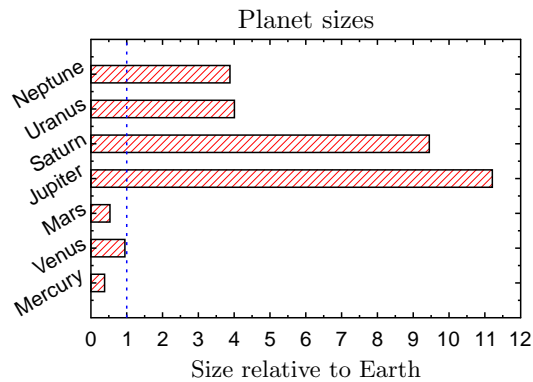

Figure 4.12: Illustration of the ‘horiz’ and ‘pattern’ keywords of the ‘bar’ command, and of the ‘angle’ option of the ‘yaxis’ command.

`bar dx,... dist spacing`

Specifies the distance between bars in dataset(s) `dx,...`. The distance is measured from the left hand side of one bar to the left hand side of the next bar. A distance of less than the width of a bar results in the bars overlapping.

`bar dx,... from dy,...`

This sets the starting point of each bar in datasets `dx,...` to be at the value in datasets `dy,...`, and is used for creating stacked bar charts. Each layer of the bar chart is created with an additional bar command.

```
bar d1,d2
bar d3,d4 from d1,d2
bar d5,d6 from d3,d4
```

Note 1: It is important that the values in `d3` and `d4` are greater than the values in `d1` and `d2`.

Note 2: Data files for stacked bar graphs should not have missing values, replace the \* character with the number on its left in the data file.

```
begin graph
...
data "gc_bean.dat"
bar d1 fill gray20
bar d2 from d1 fill white
end graph
```

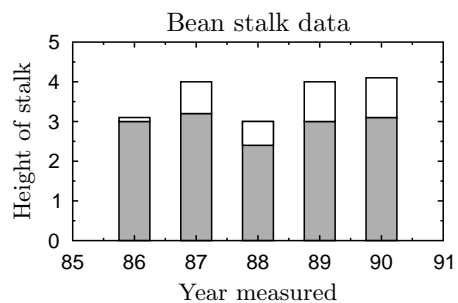

`bar dn,... width xunits,... fill col,... color col,...`

The rest of the bar qualifiers are fairly self explanatory. When several datasets are specified, separate them with commas (with no spaces between commas).

```
bar d1,d2 width 0.2 dist 0.2 fill gray10,gray20 color red,green
```

`bar dn,... fill f pattern p`

The ‘pattern’ option specifies the pattern used for filling the bars. Fig. 3.6 gives an overview of the predefined patterns that can be used here. Fig. 4.12 shows an example of the command ‘`bar d2 horiz fill red pattern shade2`’.

`bar dn,... horiz`

The option ‘horiz’ makes the bars horizontal instead of vertical (Fig. 4.12).

## 4.4 3D Bar Graphs

3d Bar graphs are now supported, the commands are:

```
bar d1,d2 3d .5 .3 side red,green notop
bar d3,d4 3d .5 .3 side red,green top black,white
```

Take note of comma's.

```
bar dx,... 3d xoffset yoffset side color list top color list [notop]
```

`3d xoffset yoffset`

Specifies the x and y vector used to draw the receding lines, they are defined as fractions of the width of the bar. A negative xoffset will draw the 3d bar on the left side of the bar instead of the right hand side.

`side color list`

The color of the side of each of the bars in the group.

`top color list`

The color of the top part of the bar

`notop`

Turns off the top part of the bar, use this if you have a stacked bar graph so you only need sides on the lower parts of each stack.

```
begin graph
...
data "gc_bean.dat"
bar d1,d2,d3 dist 0.25 width 0.15 3d 1 0.25 &
fill red,blue,forestgreen &
side orange,dodgerblue,green
end graph
```

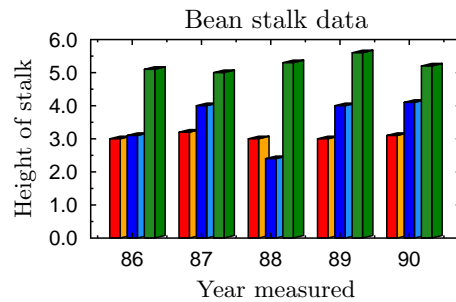

## 4.5 Filling Between Lines

```
fill x1,d3 color green xmin val xmax val
```

Fills between the xaxis and a dataset, use the optional xmin, xmax, ymin, ymax qualifiers to clip the filling to a smaller region

```
fill d4,x2 color blue ymin val ymax val
```

This command fills from a dataset to the x2axis.

```
fill d3,d4 color green xmin val xmax val
```

This command fills between two datasets.

```
fill d4 color green xmin val xmax val
```

This command treats the dataset as a polygon and fills it. The dataset should be a closed polygon.

```
begin graph
title "Shading areas of the graph" dist 0.1
xtitle "Height of stalk"
ytitle "Year measured"
xaxis min 86 max 90
yaxis min 0 max 6
data "gc_fill.dat"
fill d2,x2 color gray40
fill x1,d1 color gray10 xmin 85 xmax 88
fill x1,d1 color gray90 xmin 88 xmax 91
dn line
end graph
```

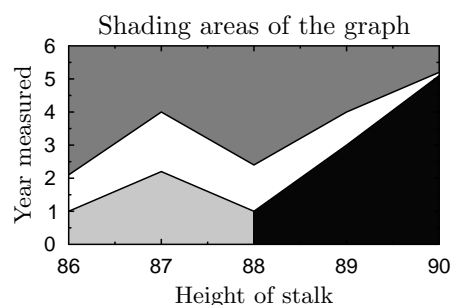

## 4.6 Notes on Drawing Graphs

### 4.6.1 Importance of Order

Most of the graph commands can appear in any order, but in some cases order is significant.

As some `let` commands operate on data which has been read into datasets, the `data` commands should precede the `let` commands.

The wildcard `dn` command should appear before specific `d1` commands which it will override.

By default `xaxis` commands also change the `x2axis`, and `xlabels` commands also change `x2labels`, so to specify different settings for the `x` and `x2` axes, put the `x2` settings after the `x` settings.

```
begin graph
  size 10 10
  data a.dat
  let d2 = d1*3
  dn marker square lstyle 3 ! sets d1 and d2
  d2 marker dot
  xaxis color green
  xticks color blue
  x2axis color black
end graph
```

### 4.6.2 Line Width

When scaling a graph up or down for publication the default line width may need changing. To do this simply specify a `set lwidth` command before beginning the graph.

```
size 10 10
set lwidth .1
begin graph
  ...
end graph
```



# Chapter 5

## The Key Module

The key module is used for drawing keys. The key can be either specified through a separate key block or directly in the graph block (by prefixing the key commands with the keyword “key”). This chapter first discusses how to define the key using a key block. Section 5.3 shows how to include the key commands directly in a graph block.

The key block usually comes directly after the graph block as follows:

```
begin graph
  ...
end graph

begin key
  position tr
  offset 0.2 0.2
  text "Blue"   marker circle   fill blue
  text "Red"    marker triangle  fill red   lstyle 2
  text "Orange" marker square   fill orange lstyle 3
end key
```

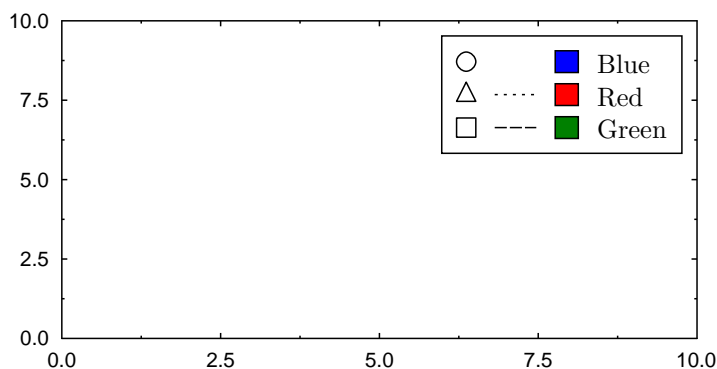

The key block consists of two parts: (a) global commands, and (b) the definitions of the entries. Global commands appear at the beginning of the key and define, e.g., the position of the key. In the example, “position” and “offset” are global commands. Multiple global commands are allowed on a given line. The entry definitions start after the global commands. All commands relevant to a given entry must appear on the same line. In the example, there are three entry definitions and each definition starts with the “text” command. Entries can be organized into columns using the “separator” command.

There are two possible ways to set the position of a key: (a) the key can be positioned relative to the graph, and (b) it can be positioned at given coordinates. To position the key relative to the graph, use the commands “position” and (optionally) “offset”. For example,

```
position tr
offset 0.2 0.2
```

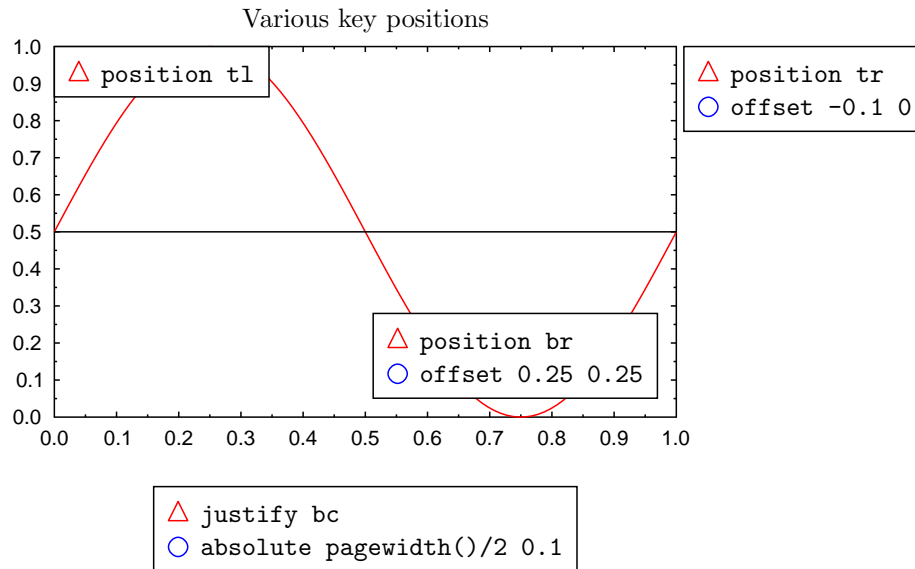

Figure 5.1: Various positions for the key.

places the key at the top-right corner of the graph 0.2 cm from each side. To position the key at given coordinates use the “justify” and “absolute” commands. For example,

```
justify bc
absolute 5 0.1
```

places the bottom-center of the key at position (5 cm, 0.1 cm). Fig. 5.1 gives some examples of positioning the key.

## 5.1 Global Commands

Global commands appear at the start of the key block. They control the position of the key and various other properties of the key. Several global key commands may appear on one line in the script.

**absolute** *x y*

Places the key at position  $(x, y)$  on the figure. The anchor point of the key is specified with the “justify” command.

**base** *h* or **row** *h*

Sets the base scale of the entries. The sizes of all components are initialized based on this. E.g., to change the size of the filled box in an entry, use this command.

**boxcolor** *c*

Set the background color of the key to *c*.

**coldist** *d*

Sets the distance between columns. (To obtain a key with multiple columns, use the “separator” command.)

**compact**

Creates a more compact key by combining the “line” and “marker” fields into one field. The effect of this is shown in Fig. 5.3.

**dist** *d*

Sets the distance between the different components of an entry (the marker, the line, the fill, and the text).

**hei** *h*

Sets the height of the text in the entries of the key. If this command is not given, then the current height is used. (To set the current height, use “set hei”, see page 20.)

**justify** *x*

Sets the anchor point of the key. Possible values: tl, bl, tr, br, tc, bc, lc, rc, cc. These stand for top-left, bottom-left, top-right, bottom-right, top-center, bottom-center, left-center, right-center, and center. Use this command in combination with the “absolute” command. Fig. 5.1 gives some examples.

**llen** *x*

Sets the length of the line in the entries.

**lpos** *x*

Sets the vertical position of the line in the entries. (This is normally set automatically.)

**margins** *x y*

Sets the margins of the key block. (The space between the border and the entries.)

**nobox**

Do not draw a border around the key.

**off**

Disable this key.

**offset** *x y*

Specifies the distance in cm between the position specified with the “position” or “pos” command and the actual key. A negative offset places the key outside of the graph (Fig. 5.1).

**position** *x* or **pos** *x*

Specifies the position of the key on the graph. Possible values: tl, bl, tr, br, tc, bc, lc, rc, cc. These stand for top-left, bottom-left, top-right, bottom-right, top-center, bottom-center, left-center, right-center, and center. Optionally, the “offset” command can be combined with this command. Fig. 5.1 gives some examples.

## 5.2 Entry Definition Commands

Each entry in the key is represented by one line in the key block, and all commands for a given entry must appear on that line. The following commands can be used to define key entries.

**color** *c*

Sets the color of the line and marker. The other components of the key are drawn in the default color. (To set the default color, use “set color”, see page 18.)

**fill** *p*

Sets the fill color or pattern.

**line**

Shorthand for “lstyle 1”.

**lstyle** *s*

Sets the line style.

**lwidth**

Sets the width of the line.

**marker** *m*

Sets the marker.

**mscale** *x*

Sets the scale of the marker.

**msize** *x*

Sets the size of the marker.

**pattern** *x*

Sets the filling pattern. Fig. 3.6 shows examples of filling patterns.





Figure 5.2: Defining a key with multiple columns.

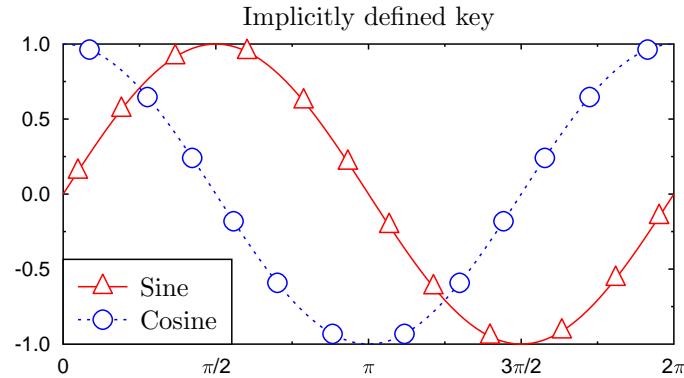

Figure 5.3: Defining the key together with the graph block.

separator [lstyle *s*]

Use this command to divide the key into multiple columns. If the “lstyle” option is given, then a line is drawn between the columns in the given style. Possible values are given with the description of the “set lstyle” command on page 20. The “separator” command should be inserted between the key entries that should go in different columns. For example,

```
begin key
  position bl
  line color red   text "Red"
  line color green text "Green"
  line color blue  text "Blue"
  separator
  line color orange text "Orange"
  line color purple text "Purple"
  line color black text "Black"
end key
```

will result in the key shown in Fig. 5.2.

text *s*

The text for the entry.

### 5.3 Defining the Key in the Graph Block

It is also possible to define the key in the graph block itself. This is accomplished by prefixing global key commands with the keyword “key”. The entries are in this case defined with the “dn” commands and the labels are set with the “key” option to these commands.

The following presents an example:

```
begin graph
  title "Implicitly defined key"
  let d1 = sin(x)
  let d2 = cos(x)
  xaxis min 0 max 2*pi dticks pi/2 format "pi"
  key compact pos bl
  d1 line color red marker triangle mdist 1 key "Sine"
```

```
d2 line color blue marker circle mdist 1 lstyle 2 key "Cosine"  
end graph
```

Fig. 5.3 shows the result.

If you plot data from a data file, and the first row of the file contains column labels, then these labels will be used automatically to construct the key. However, if you prefer to construct the key manually instead by defining a key block, then you can override this behavior by making GLE ignore the row with the labels using the “ignore” option of the “data” command. E.g., `data "myfile.csv" ignore 1` (see p. 25). Alternatively, you can accomplish the same by adding the command “key off” to the graph block to disable the automatically generated key.



# Chapter 6

## Programming Facilities

### 6.1 Expressions

Wherever GLE is expecting a number it can be replaced with an expression. For example

```
rline 3 2
```

and

```
rline 9/3 sqrt(4)
```

will produce the same result.

An expression in GLE is delimited by white space, so it may not contain any spaces - 'rline 3\*3 2' is valid but 'rline 3 \* 3 2' will not work.

Or 'let d2 = 3+sin(d1)' will work and 'let d2= 3 + sin(d1)' won't.

Expressions may contain numbers, arithmetic operators (+, -, \*, /, ^ (to the power of)), relational operators (>, <, =>, <=, =, <>) Boolean operators (and, or), variables and built-in functions.

When GLE is expecting a colour or marker name (like 'green' or 'circle') it can be given a string variable, or an expression enclosed in braces.

### 6.2 Functions Inside Expressions

`eval(str)`

Evaluates the given string as if it was a GLE expression and returns the result. E.g., `eval("3+4")` returns 7.

`arg(i)`, `arg$(i)`, `nargs()`

Provide access to the command line arguments that are passed to GLE. This is useful for generating multiple similar plots from a single script. `arg(i)` returns the i-the argument (as a number), `arg$(i)` returns the i-the argument as a string, and `nargs()` returns the number of arguments. Only arguments that come after the name of the GLE script are counted. For example, if GLE is run as:

```
gle -o graph-1.eps graph.gle "Title" 0.5
```

then `nargs()` returns 2, `arg$(1)` returns "Title", and `arg(2)` returns 0.5.

The typical use of these functions is to create a script "graph.gle" as follows:

```
size 10 10
begin graph
  title arg$(1)
  data arg$(2)
  d1 line color red
end graph
```

and then creating different graphs by running GLE multiple times:

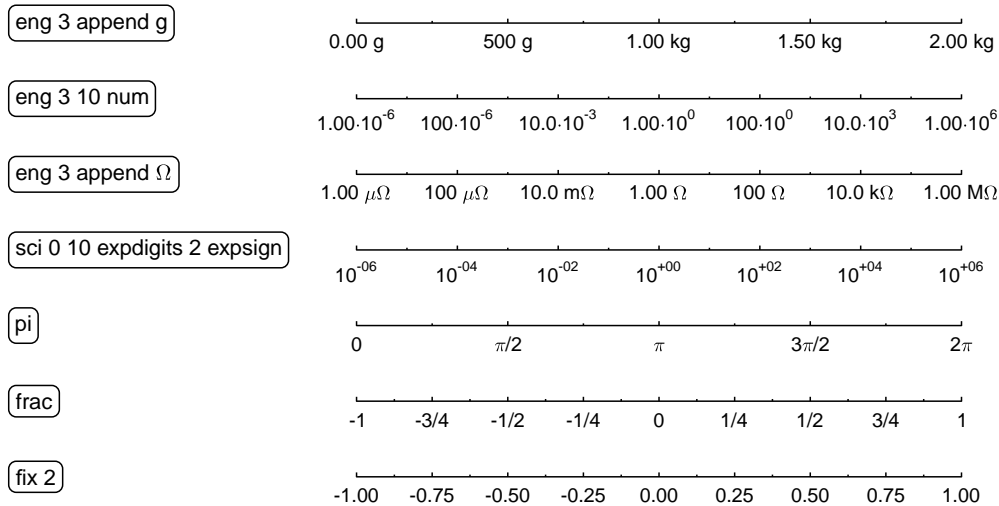

Figure 6.1: Examples of number formatting options.

```
gle -o beans.eps graph.gle "Beans" "beans.csv"
gle -o peas.eps graph.gle "Peas" "peas.csv"
```

This will create two graphs: “beans.eps” and “peas.eps”. The `arg()` functions can be used at all places in the script where an expression is expected. They can even be used in place of GLE commands in a graph block by means of the `\expr()` function. For example,

```
data "file.csv"
d\expr{arg(1)} line color red
```

in the graph block will allow one to draw different datasets from a single file on multiple graphs. To do so, run:

```
gle -o d1.eps graph.gle 1
gle -o d2.eps graph.gle 2
```

`dataxvalue(ds,i)`, `datayvalue(ds,i)`, `ndata(ds)`

These functions can be used to retrieve the data values from a given dataset. They only work after data has been loaded by means of a graph block (Ch. 4).

A dataset is specified with a dataset identifier *ds* (a string of the form “*d*”, with *i* an integer). The function ‘`ndata`’ returns the number of points in the dataset, and the functions ‘`dataxvalue`’ and ‘`datayvalue`’ return the *x* and *y* values of point *i*, where *i* ranges from 1 to `ndata(ds)`.

The following example shows how these functions can be used to compute the maximum of a dataset:

```
sub dmaxy ds$
  local crmax = datayvalue(ds$,1)
  for i = 2 to ndata(ds$)
    crmax = max(crmax, datayvalue(ds$,i))
  next i
  return crmax
end sub
```

This subroutine together with other subroutines for computing the minimum, mean, area, etc. of a dataset are defined in the include file ‘`graphutil.gle`’, which is distributed together with GLE.

`format$(exp,format)`

Returns a string representation of *exp* formatted as specified in *format*.

Basic formats:

- `append s`: appends the string *s* after the formatted number. This can be used to add a unit.

- `dec`, `hex` [upper—lower], `bin`: format as decimal, hexadecimal (upper-case or lower-case), or binary.
- `fix` *places*: format with *places* decimal places.
- `sci` *sig* [e,E,10] [*expdigits num*] [*expsign*]: format in scientific notation with *sig* significant digits. Use ‘e’, ‘E’, or ‘10’ as notation for the exponent. With the option *expdigits* the number of digits in the exponent can be set and *expsign* forces a sign in the exponent.
- `eng` *digits* [e,E,10] [*expdigits num*] [*expsign*] [*num*]: format in engineering notation. The options are similar to ‘sci’. If the option ‘num’ is given, then numeric notation is used instead of, e.g.,  $\mu$ , m, k, M.
- `round` *sig*: format a number with *sig* significant digits.
- `frac`: format the number as a fraction.
- `pi`: format the number as a fraction times  $\pi$  (E.g., xaxis labels of Fig. 4.8).

Options for all formats:

- `nozeroes`: remove unnecessary zeroes at the end of the number.
- `sign`: also include a sign for positive numbers.
- `pad` *nb* [left] [right]: pad the result with spaces from the left or right.
- `prefix` *nb*: prefix the number with zeroes so that *nb* digits are obtained.
- `prepend` *s*: prepends the string *s* before the formatted number.
- `min` *val*: use format for numbers  $\geq val$ .
- `max` *val*: use format for numbers  $\leq val$ .

Examples:

- `format$(3.1415, "fix 2") = 3.14`
- `format$(3756, "round 2") = 3800`
- `format$(3756, "sci 2 10 expdigits 2") = 3.8 · 1003`

Several formats can be combined into one string: `"sci 2 10 min 1e2 fix 0"` uses scientific notations for numbers above  $10^2$  and decimal notation for smaller numbers. See Fig. 6.1 for more examples.

`pagewidth()`, `pageheight()`

These functions return the width and height of the output. These are the values set with the ‘`size`’ command.

`pointx()`, `pointy()`

These functions return the x and y values of a named point.

```
begin box add 0.1 name mybox
  write "Hello"
end box
amove pointx(mybox.bc) pointy(mybox.bc)
rline 0 -2 arrow end
```

`twidth(str)`, `theight(str)`, `tdepth(str)`

These functions return the width, depth and height of a string, if it was printed in the current font and size.

`width(obj)`, `height(obj)`

These functions return the width and height of a named object.

`xend()`, `yend()`

These functions return the end point of the last thing drawn. This is of particular interest when drawing text.

```
text abc
set color blue
text def
```

This would draw the `def` on top of the `abc`. To draw the `def` immediately following the `abc` simply do the following (Note that absolute move is used, not relative move):

```
set just left
text abc
set color gray20
amove xend() yend()
text def
```



`xg()`, `yg()`

With these functions it is possible to move to a position on a graph using the graph's axis units. To draw a filled box on a graph, at position `x=948`, `y=.004` measured on the graph axis:

```
begin graph
  xaxis min 100 max 2000
  yaxis min -.01 max .01
  ...
end graph
amove xg(948) yg(.004)
box 2 2 fill gray10
```

`xpos()`, `ypos()`

Returns the current `x` and `y` points.

See Appendix A.2 for an overview of all functions provided by GLE.

## 6.3 Using Variables

GLE has two types of variables, floating point and string. String variables always end with a dollar sign. A string variable contains text like "Hello, this is text", a floating point variable can only store numbers like 1234.234.

```
name$ = "Joe"
height = 6.5 ! Height of person
shoe = 0.05 ! shoe adds to height of person
amove 1 1
box 0.2 height+shoe
write name$
```

## 6.4 Programming Loops

The simple way to draw a  $6 \times 8$  grid would be to use a whole mass of line commands:

```
amove 0 0
rline 0 8
amove 1 0
rline 1 8
...
amove 6 0
rline 6 8
```

this would be laborious to type in, and would become impossible to manage with several grids. By using a simple loop this can be avoided:

```
for x = 0 to 6
  amove x 0
  rline x 8
next x
for y = 0 to 8
  amove 0 y
  rline 6 y
next y
```

Besides for-next loops, GLE also supports while and until loops:

```
i = 0
while i <= 10
  print "Value: " i
  i = i + 1
next
```

```
i = 0
until i > 10
  print "Value: " i
  i = i + 1
next
```

## 6.5 If-then-else

GLE supports if-then-else statements as follows:

```
if a < 1 then print a "is smaller than 1"
else if a < 2 then print a "is smaller than 2 but larger than 1"
else if a < 3 then print a "is smaller than 3 but larger than 2"
else print a "is larger than 3"
```

to create blocks of code for the ‘then’ and ‘else’ branches, instead use:

```
if a < 1 then
  print a "is smaller than 1"
  ...
else
  ...
end if
```

More complex conditions can be created with the logic connectives ‘and’, ‘or’, and ‘not’ (note the parenthesis around the logical expressions):

```
if (a >= 1) and (a <= 10) then print "a is between 1 and 10"
```

## 6.6 Subroutines

To draw lots of grids all of different dimensions a subroutine can be defined and then used again and again:

```
sub grid nx ny
  local x, y
  begin origin
    for x = 0 to nx
      amove x 0
      aline x ny
    next x
    for y = 0 to ny
      amove 0 y
      aline nx y
    next y
  end origin
end sub
```

```
amove 2 4
grid 6 8
amove 2 2
grid 9 5
```



Inside a subroutine, the keyword `'local'` can be used to define local variables. E.g., `'local x = 3'`, defines the local variable `'x'` and assigns it the value 3. It is also possible to define several local variables at once, as is shown in the `'grid'` example above.

The keyword `'return'` can be used to return a value from a subroutine. E.g.,

```
sub gaussian x mu sigma
  return 1/(sigma*sqrt(2*pi))*exp(-((x-mu)^2)/(2*sigma^2))
end sub
```

The main GLE file will be much easier to manage if subroutine definitions are moved into a separate file:

```
include "griddef.gle"

amove 2 4
grid 2 4
amove 2 2
grid 9 5
```

More information about the `"include"` command can be found on page 14.

### 6.6.1 Default Arguments

Given the following subroutine definition:

```
sub mysub x y color$ fill$
  default color "black"
  default fill "clear"
  print "Color: " color$
  print "Fill: " fill$
end sub
```

the following calls are valid:

```
mysub 1 0
mysub 1 0 red
mysub 1 0 red green
mysub 1 0 fill blue
mysub 1 0 color red
mysub 1 0 color red fill blue
```

## 6.7 Forward Declarations

A forward declaration of a subroutine is possible with:

```
declare sub mysub x y
```

Forward declarations are required for declaring mutually recursive subroutines.

## 6.8 I/O Functions

The following I/O functions are available:

`fopen name file [read|write]`

Open the file `"name"` for reading or for writing. The resulting file handle is stored in variable `"file"` and must be passed to all other I/O functions.

`fclose file`

Close the given file.

`fread file x1 ...`

`freadln file x1 ...`

Read entries from `"file"` into given arguments `x1 ...`

`fwrite file x1 ...`

Write given arguments to “*file*”.

`fwriteln file x1 ...`

Write given arguments to “*file*” and start a new line.

`fgetline file line$`

Read an entire line from “*file*” and store it in the string “*line\$*”.

`ftokenizer file commentchar spacetokens singletokens`

Sets up the parameters of the tokenizer that controls the reading of “*file*”. The *commentchar* parameter specifies the characters that are to be interpreted as line comments. It is a string, but each character of the string is assumed to be a separate comment character. The default is “!”. If one would write “!%”, then both “!” and “%” would be comment indicators. The `fread` functions skip everything after a comment character to the end of the line. The *spacetokens* string represents the set of characters that are interpreted as spaces or delimiters. The default value is “, \t \r \n”, i.e., space, comma, tab, carriage return, and newline are delimiters by default. Finally, the *singletokens* string identifies characters that should be returned as separate tokens, even if they are glued to other tokens. For example, if “@” would be a single char token, then the string “me@myself.com” would be returned in three tokens: “me”, “@”, and “myself.com”.

For example:

```
fopen "file.dat" f1 read
fopen "file.out" f2 write
until feof(f1)
    fread f1 x y z
    aline x y
    rline x z
    fwrite f2 x*2 "y =" y
next
fclose f1
fclose f2
```

## 6.9 Device dependend Control

A built in function which returns a string describing the device is available.

e.g. `DEVICE$() = "HARDCOPY, PS,"`

on the postscript driver.

This can be used to use particular fonts etc on appropriate devices. E.g.:

```
if pos(device$(),"PS,",1)>0 then
    set font psncsb
end if
```



# Chapter 7

## Advanced Features

This chapter covers the advanced features of GLE.

### 7.1 Diagrams

#### 7.1.1 Named Boxes and the Join Command

GLE can name objects using the “begin/end name” (p. 10), “begin/end box” (p. 9), and “begin/end object” (p. 10) constructs, and using the “name” option supported by some drawing commands. The name is always associated with the rectangular region on the figure that corresponds to the bounding box of the object (the smallest rectangle that surrounds all points of the object). The following example shows how to create a blue rectangle named “square” and a box with the text “Title” named “titlebox”.

```
amove 1 1
box 1 1 fill blue name square

amove 5 5
begin box add 0.1 name titlebox
  write "Title"
end box
```

The “join” command (p. 14) can now be used to draw lines or curves (optionally with arrows) between designated points of the named objects. The following example shows how to draw an arrow from the top-right (“tr”) point of the blue square to the bottom-centre point (“bc”) of the object named “titlebox”.

```
join square.tr -> titlebox.bc
```

The “->” in the join command indicates that the arrow should go from the first object towards the second. The symbol “<-” is used to draw the arrow in the opposite direction. A bidirectional arrow is obtained with “<->” and a line without an arrow is obtained with “-”. The join command can also create Bezier curves instead of straight lines. See the command’s description on p. 14 for more information.

```
join square.tr -> titlebox.bc
join square.tr <- titlebox.bc
join square.tr <-> titlebox.bc
join square.tr - titlebox.bc
```

The named points (corners, centre points, ...) on each named object are indicated as defined in Table 7.1. “.box” clipping is the default and can be omitted.

It is also possible to name an individual point (instead of an object). To do so, simply move there and save that point as a named object.

```
amove 2 3; save apoint
join apoint - square
```

Table 7.1: Justify options for the join command.

.tr	Top right
.tc	Top centre
.tl	Top left
.bl	Bottom left
.bc	Bottom centre
.br	Bottom right
.rc	Right centre
.lc	Left centre
.cc	Centre
.v	Vertical line
.h	Horizontal line
.c	Circle/ellipse clipping (for drawing lines to, e.g., a circle)
.box	Box clipping

The functions “pointx” (abbreviated to “ptx”, see p. 49), “pointy” (abbreviated to “pty”), “width”, and “height” (p. 49) apply to named points and objects. They retrieve the “x” respectively “y” coordinate of a named point, and the width and height of a named object. For example:

```
print ptx(square.tr)
print pty(square.tr)
print width(square)
print height(square)
```

### Complete Example

Below is a complete example that makes use of the constructs described above. The resulting figure is shown in Fig. 7.1.

```
begin name line
  amove 8 18
  rline 0 -6
end name

begin name main
  amove 9.5 6.5
  ellipse 2 0.8
  write "Main"
end name

amove 3 16
begin box name grv add 0.3 round 0.3 fill lightcyan
  write "GRV"
end box

amove 12.5 16.5
begin box name cheese add 0.3 fill lightcyan
  write "Cheese"
end box

amove 15.5 11.5
begin box name chv add 0.3 fill lightcyan
  write "CHV"
end box

amove 3 10
begin box name goats add 0.3 fill lightcyan
  write "Goats"
```

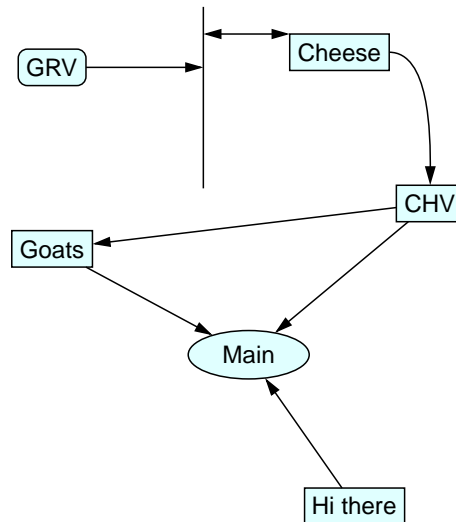

Figure 7.1: Joining named points.

```
end box
```

```
amove 13 1.5
begin box name hi add 0.3 fill lightcyan
  write "Hi there"
end box
```

```
join chv -> goats           ! ".box" is default and can be omitted
join grv -> line.h          ! ".h" means to join horizontally
join line.h <-> cheese.tl
join cheese.rc -> chv.tc curve 0 90 1.5 1
join main.c <- hi          ! ".c" is used for circles
join main.c <- chv
join main.c <- goats
```

### 7.1.2 Object Blocks and Hierarchically Named Points

The “begin/end name” (p. 10) construct names the object that results from the drawing commands in this block. The “begin/end object” (p. 10) is similar, but it does not actually draw the object. It rather defines an object that can be drawn later by means of the “draw” command (p. 13). An object block is therefore very similar to a subroutine. It actually works in the same way as a subroutine, but it is ‘executed’ by the “draw” command rather than by a regular subroutine call. An object block can also have parameters. Here is an example of an object block that defines a house.

```
begin object house
  ! draw a house with a named door and window
  set join round
  ! draw the roof
  begin path stroke fill lightsalmon
    amove 0 1.625
    aline 1.25 2.5
    aline 2.5 1.625
    closepath
  end path
  ! draw the brick wall
  amove 0 0
  box 2.5 1.625 fill cornsilk
```

```

! draw the door
amove 1.5 0
box 0.75 1.375 fill burlywood name door
! draw the window
amove 0.25 0.625
box 1 0.75 fill skyblue name window
end object

```

To draw the house defined by the above block, one uses the following draw command. The first argument of the command is the name of the object followed by a dot followed by a justify option (Table 7.1). The justify option is used to position the object. In this case, the house is drawn such that its bottom-centre point is horizontally in the middle of the figure and at a height of 1.5 cm.

```

amove pagewidth()/2 1.5
draw house.bc

```

The “draw” command names the object using the same name as the name of the object block by default. An alternative name can be given using its “name” option. In this example, the resulting object on the figure will be called “house”. Note that the object definition for the house also includes names for the sub-objects “door” and “window”. These names can be accessed using the “dot” notation as follows:

```

print ptx(house.door.cc)
print pty(house.door.cc)

```

These so-called hierarchical object names can also be used to position the object. The following example draws the house such that its door’s centre point is at position (5, 5).

```

amove 5 5
draw house.door.cc

```

By using the “draw” command inside an object’s definition, names can be arbitrary nested. For example, if “door” would be defined as an object block that includes the name “handle”, and if the object block defining “house” would include a draw command to draw the object “door”, then the global name of the door’s handle becomes “house.door.handle”.

The hierarchical object names can be used to refer to points on the object. The following example shows how these can be used with the pointx and pointy function to draw labels on the figure.

```

set just lc
amove pointx(house.rc)+0.5 pointy(house.door.cc)
begin name doorlabel add 0.05
  write "house.door.cc"
end name

set just rc
amove pointx(house.lc)-0.5 pointy(house.window.cc)
begin name windowlabel add 0.05
  write "house.window.cc"
end name

join windowlabel.rc -> house.window.cc
join doorlabel.lc -> house.door.cc

```

The resulting figure is shown in Fig. 7.2. The file “shape.gle” that is distributed with GLE contains object block definitions for many useful shapes.

## 7.2 $\LaTeX$ Interface

### 7.2.1 Example

GLE files can include arbitrary  $\LaTeX$  expressions using the  $\LaTeX$  interface. There are two ways to include a  $\LaTeX$  expression. The first one is by using the ‘`tex`’ primitive. The second one is by using the ‘`\tex{}`’ macro in a string.

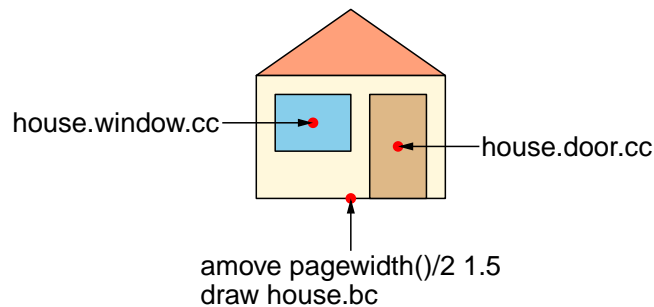

Figure 7.2: Drawing objects and hierarchically named points.

```

set texlabels 1
begin graph
  ...
  title "Plot of $f(x) =
    \frac{x-\sqrt{5}}{(x-1)\cdot(x-4)}$"
  xtitle "$x$"
  ytitle "$y = f(x)$"
  ...
end graph

set just bc
amove xg(sqrt(5)) yg(2.5)
tex "$\sqrt{5}$" add 0.1 name sq5b

amove xg(sqrt(5)) yg(0); save sq50
join sq5b.bc -> sq50

```

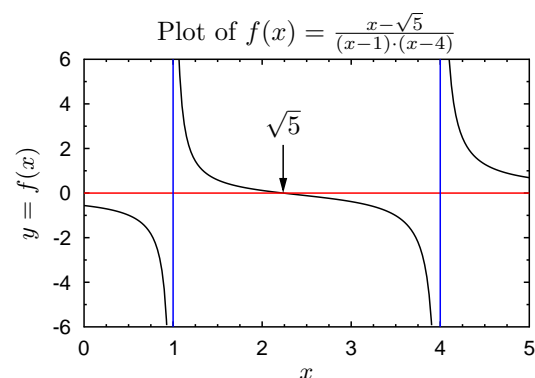

L<sup>A</sup>T<sub>E</sub>X expressions are drawn on top of all other graphics and cannot be clipped (Sec. 7.3).

L<sup>A</sup>T<sub>E</sub>X expressions respect the ‘just’ setting and, depending on the value of ‘texscale’, also the ‘hei’ setting (the font size). If ‘set texscale scale’ is used, then L<sup>A</sup>T<sub>E</sub>X expressions are scaled to the value of ‘hei’. If ‘set texscale none’ is used, then L<sup>A</sup>T<sub>E</sub>X expressions are not scaled. As a result, the font sizes in your graphics will be exactly the same as in your main document. To obtain different font sizes, use the font size primitives provided by L<sup>A</sup>T<sub>E</sub>X (e.g., `\large`, ...). Finally, if ‘set texscale fixed’ is used, then the default L<sup>A</sup>T<sub>E</sub>X size that most closely matches the value of ‘hei’ is selected.

### 7.2.2 Using LaTeX Packages

If your L<sup>A</sup>T<sub>E</sub>X expressions require special L<sup>A</sup>T<sub>E</sub>X packages, these can be loaded using the `texpreamble` block. E.g., put the following near the beginning of your GLE file:

```

begin texpreamble
  \documentclass{llncs}
  \usepackage{amsmath}
  \usepackage{amssymb}
  \DeclareMathSymbol{\R}{\mathbin}{AMSb}{"52}
end texpreamble

```

### 7.2.3 Using UTF-8 Encoding in GLE Scripts with LaTeX Expressions

If you save your .gle files in Unicode (UTF-8) encoding, then you can type accented characters (such as é, ü, ž, ...) directly into your GLE script. In order to also allow such encoded characters in L<sup>A</sup>T<sub>E</sub>X expressions, add the following ‘texpreamble’ to your GLE script:

```

size 4 4
begin texpreamble
  \usepackage[utf8]{inputenc}
end texpreamble
amove 1 2; tex "éüž"

```



### 7.2.4 Import a GLE Figure in a LaTeX Document

There are two methods for importing the output of a GLE file with  $\TeX$  expressions in your  $\LaTeX$  document. The most obvious one is by just importing the .eps/.pdf file generated by GLE with `\includegraphics`. E.g., if you have a GLE script 'sin.gle' and you run 'gle -d eps -d pdf sin.gle' to produce the .eps/.pdf output, then you could include this in a LaTeX document as follows:

```
\documentclass{article}
\usepackage{graphics}
\begin{document}
  \begin{figure}
    \includegraphics{sin}
    \caption{\label{sin}The sine function.}
  \end{figure}
\end{document}
```

An alternative method is by using GLE's command line option '-inc'. If this option is supplied, then GLE will create besides the usual .eps or .pdf file also an .inc file. This .inc file can be imported in a  $\LaTeX$  document as follows.

```
\input{myfile.inc}
```

The .inc file tells latex (or pdflatex) to include the .eps/.pdf output file created by GLE. It also includes  $\TeX$  draw commands for drawing the  $\LaTeX$  expressions on top of the GLE output. Note that the .eps/.pdf file created by GLE does not include these if -inc is used (you can check this by viewing it with GhostView).

To be able to include .inc files, the following must be included in the preamble of your  $\LaTeX$  document.

```
\usepackage{graphics}
\usepackage{color}
```

If you place your .gle files in a subdirectory of the directory where your  $\LaTeX$  document resides, the .inc file created by GLE should include the path to this subdirectory in the '`\includegraphics`' primitive it uses for including the .eps/.pdf file generated by GLE. To add this path, use the '`-texincprefix`' command line option of GLE. For example, if your GLE files are in a subdirectory called 'plots' then one should run GLE as follows.

```
gle -texincprefix "plots/" -inc myfile.gle
```

GLE can color and rotate  $\LaTeX$  expressions (use '`set color`' and '`begin rotate`'). Note however that 'xdvi' does not support these effects, so you will not be able to see them if you use this viewer. In the final PostScript or PDF output, they will of course be displayed correctly.

The main advantage of using the -inc method is that the resulting file size will be smaller because the  $\LaTeX$  fonts are not included in the .eps/.pdf file generated by GLE.

### 7.2.5 The .gle Directory

If your source includes  $\LaTeX$  expressions, then GLE will construct a subdirectory called '.gle' for storing temporary files (e.g., used for measuring the printed size of the  $\LaTeX$  expressions). After you are finished you can safely delete the .gle directory. GLE will recreate it automatically if required.

## 7.3 Filling, Stroking and Clipping Paths

It is possible to set up arbitrary clipping regions. To do this draw a shape and make it into a path by putting a `begin path clip ... end path`, around it. Then draw the things to be clipped by that region. To clear a clipping path surround the whole section of GLE commands with `begin clip ... end clip`. Characters can be used to make up clipping paths, but only the PostScript fonts will currently work for this purpose.

```

size 10 5
begin clip      ! Save current clipping path
  begin path clip stroke ! Define new clipping region
    amove 2 2
    box 3 3
    amove 6 2
    box 3 3
  end path
  amove 2 2
  set hei 3
  text Here is clipped text
end clip      ! Restore original clipping path

```

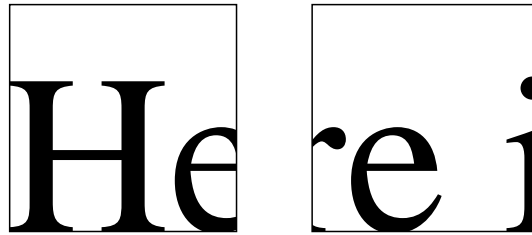

## 7.4 Colour

Internally GLE treats color and fill identically, they are simply an intensity of red, green and blue. Each of the predefined color names (yellow, grey20, orange, red) simply define the ratio of red, green and blue. A sample of the predefined color names is included in Appendix A.7.

There are two ways to use variables to show color, one is for shades of grey:

```

for i = 0 to 10
  box 3 .2 fill (i/10)
  rmove 0 .2
next i

```

The other is for passing a color **name** as a variable:

```

sub stick c$
  box .2 2 fill c$
end sub
stick "green"

```

A color can also be defined based on its RGB values with the `rgb255` primitive.

```
mycolor$ = "rgb255(38,38,134)"
```

Remember a fill pattern completely obscures what is behind it, so the following command would produce a box with a shadow:

```

amove 4 4
box 3 2 fill grey10
rmove -.1 .1
box 3 2 fill white
rmove .4 .4
text hellow

```

## 7.5 GLE's Configuration File

GLE reads two configuration files during initialization. The first configuration file is the file “glerc” located in the root of your GLE installation. This location is usually referred to as `$GLE_TOP`. To find out where your `$GLE_TOP` is, run “`gle -info`”. The second configuration file is the file “.glerc” located in your home directory (Unix and Mac OS/X only). The commands in this second file override the commands in `$GLE_TOP/glerc`.

The configuration files can be used to set various options, such as the paper size and margins. To set the paper size and margins, add the following block to the configuration file.

```
begin config paper
  size = letterpaper
  margins = 2.54 2.54 2.54 2.54
end config
```

The supported paper sizes are listed with the description of the “papersize” command on page 15. The configuration file can also be used to override default locations of external tools such as GhostScript and LaTeX.

```
begin config tools
  ghostscript = $HOME/bin/gs
  pdflatex = /usr/bin/pdflatex
  latex = /usr/bin/latex
  dvips = /usr/bin/dvips
  dvips_options = "-j0"
end config
```

Note that GLE expands environment variables in the tool locations. If I'm john, then GLE will search for GhostScript in `/home/john/bin/gs` in the above example. It is also possible to specify additional command line options to be passed to the tools by means of `ghostscript_options`, `pdflatex_options`, `latex_options`, and `dvips_options`. In the above example, the option “-j0” will be passed to dvips. As a result, it will not subset fonts.

# Chapter 8

## Surface and Contour Plots

### 8.1 Surface Primitives

#### 8.1.1 Overview

Surface plots three dimensional data using a wire frame with hidden line removal. The simplest surface code would look like this.

```
begin surface
  data "myfile.z" 5 5
end surface
```

The surface block can contain the following commands:

```
size x y
cube [off] [xlen v] [ylen v] [zlen v] [nofront] [lstyle l] [color c]
data myfile.z [xsample n1] [ysample n2] [sample n3] [nx n1] [ny n2]
harray n
xlines — ylines [off]
xaxis — yaxis — zaxis [min v] [max v] [step v] [color c] [lstyle l] [hei v] [off]
xtitle — ytitle — ztitle "title" [dist v] [color c] [hei v]
title "main title" [dist v] [color c] [hei v]
rotate  $\theta \phi x$ 
view x y p
top — underneath [off] [lstyle n] [color c]
back [zstep v] [ystep v] [lstyle l] [color c] [nohidden]
base [xstep v] [ystep v] [lstyle l] [color c] [nohidden]
right [zstep v] [xstep v] [lstyle l] [color c] [nohidden]
skirt on
points myfile.dat
marker circle [hei v] [color c]
droplines — riselines [color c] [lstyle n]
zclip [min v1] [max v2]
```

#### 8.1.2 Surface Commands

size *x y*

Specifies the size in cm to draw the surface. The 3d cube will fit inside this box. The default is 18cm x 18cm e.g. `size 10 10`

cube [off] [xlen *v*] [ylen *v*] [zlen *v*] [nofront] [lstyle *l*] [COLOR *c*]

Surface is drawing a 3d cube.

off	Stops GLE from drawing the cube.
xlen	The length of the cubes x dimension in cm.
nofront	Removes the front three lines of the cube.
lstyle	Sets the line style to use drawing the cube.
color	Sets the color of lines to use drawing the cube.

```
begin surface
  size 7 7
  data "jack.z"
  cube zlen 13
  top color orange
  underneath color red
end surface
```

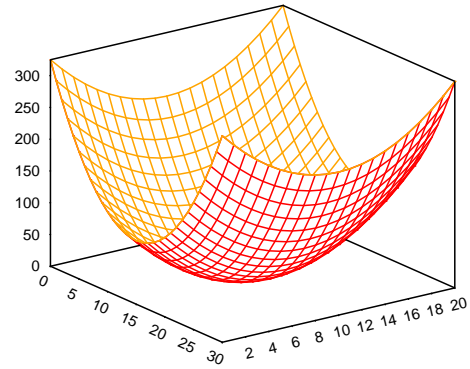

```
data myfile.z [xsample n1] [ysample n2] [sample n3] [nx n1] [ny n2]
```

Loads a file of Z values in. The NX and NY dimensions are optional, normally the dimensions of the data will be defined on the first line of the data file. e.g.

```
! nx 10 ny 20 xmin 1 xmax 10 ymin 1 ymax 20
1 2 42 4 5 2 31 4 3 2 4
1 2 42 4 5 2 31 4 3 2 4 etc...
```

```
y1,x1, y1,x2 ... y1,xn
y2,x1, y2,x2 ... y2,xn
.
.
yn,x1, yn,x2 ... yn,xn
```

Data files can be created using LETZ or FITZ. LETZ will create a data file from an x,y function. FITZ will create a data file from a list of x,y,z data points.

`xsample` Tells surface to only read every n'th data point from the data file. This speeds things up while you are messing around.

`ysample` Tells surface to only read every n'th line from the data file.

(see also POINTS)

`sample` Sets both `xsample` and `ysample`

```
begin surface
  size 5 5
  xtitle "X-axis"
  ytitle "Y-axis"
  data "surf1.z"
end surface
```

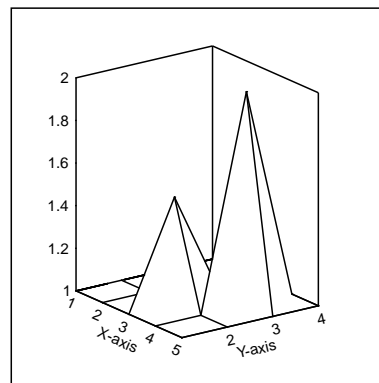

`harray n`

The hidden line removal is accomplished with the help of an array of heights which record the current horizon, the quality of the output is proportional to the width of this array. (also the speed of output)

To get good quality you may want to increase this from the default of about 900 to 2 or 3 thousand. e.g. `harray 2000`

`xlines off`

Stops SURF from drawing lines of constant X.

ylines off

Stops SURF from drawing lines of constant Y.

xaxis [min *v*] [max *v*] [step *v*] [color *c*] [lstyle *l*] [hei *v*] [off]

zaxis [min *v*] [max *v*] [step *v*] [color *c*] [lstyle *l*] [hei *v*] [off]

yaxis [min *v*] [max *v*] [step *v*] [color *c*] [lstyle *l*] [hei *v*] [off]

min,max Set the range used for labelling the axis.  
 step The distance between labels on the axis.  
 color The color of the axis ticks and labels.  
 lstyle The line style used for drawing the ticks.  
 ticklen The length of the ticks.  
 hei The height of text used for labelling.  
 off Stops GLE from drawing the axis.

```
begin surface
  size 5 5
  data "surf1.z"
  zaxis min -1 max 3
  base xstep 0.5 ystep 0.5
  back ystep 1 zstep 1
  right xstep 0.5 zstep 0.5 lstyle 2
  xtitle "X-axis" hei 0.3
  ytitle "Y-axis" hei 0.3
end surface
```

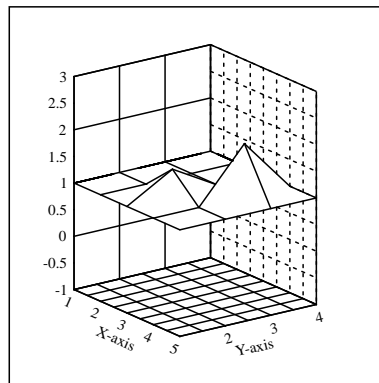

xtitle "x title" [dist *v*] [color *c*] [hei *v*]

ytitle "y title" [dist *v*] [color *c*] [hei *v*]

ztitle "z title" [dist *v*] [color *c*] [hei *v*]

dist Moves the title further away from the axis.  
 color Sets the color of the title.  
 hei Sets the hei in cm of the text used for the title.

title "*main title*" [dist *v*] [color *c*] [hei *v*]

dist Moves the title further away from the axis.  
 color Sets the color of the title.  
 hei Sets the hei in cm of the text used for the title.

rotate  $\theta$   $\phi$   $\times$

rotate 10 20 3

Imagine the unit cube is sitting on the front of your terminal screen, x along the bottom, y up the left hand side, and z coming towards you.

The first number (10) rotates the cube along the xaxis, ie hold the right hand side of the cube and rotate your hand clockwise 10 degrees.

The second number (20) rotates the cube along the yaxis, ie hold the top of the cube and rotate it 20 degrees clockwise.

The third number is currently ignored.

The default setting is 60 50 0.

view x y p

Sets the perspective, this is where the cube gets smaller as the lines disappear towards infinity.

x and y are the position of infinity on your screen. p is the degree of perspective, 0 = no perspective and with 1 the back edge of the box will be touching infinity. Good values are between 0 and 0.6

```
begin surface
  size 5 5
  data "surf1.z"
  zaxis min -1
  rotate 85 85 0
  view 0 5 0.7
end surface
```

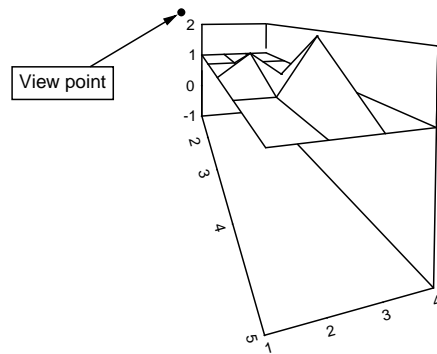

`top` [`off`] [`lstyle n`] [`color c`]

Sets the features of the top of the surface. By default the top is on.

(see also UNDERNEATH, XLINES, YLINES)

`underneath` [`off`] [`lstyle n`] [`color c`]

Sets the features of the under side of the surface. By default the underneath is off.

(see also TOP, XLINES, YLINES)

`back` [`zstep v`] [`ystep v`] [`lstyle l`] [`color c`] [`nohidden`]

Draws a grid on the back face of the cube.

By default hidden lines are removed but NOHIDDEN will stop this from happening.

`base` [`xstep v`] [`ystep v`] [`lstyle l`] [`color c`] [`nohidden`]

Draws a grid on the base of the cube.

By default hidden lines are removed but NOHIDDEN will stop this from happening.

`right` [`zstep v`] [`xstep v`] [`lstyle l`] [`color c`] [`nohidden`]

Draws a grid on the right face of the cube.

By default hidden lines are removed but NOHIDDEN will stop this from happening.

`skirt on`

Draws a skirt from the edge of the surface to ZMIN.

```
begin surface
  size 5 5
  data "surf1.z"
  zaxis min -1 max 3
  xtitle "X-axis"
  ytitle "Y-axis"
  ztitle "Z-axis"
  points "surf3.dat"
  riselines lstyle 2
  marker fcircle
  skirt on
  rotate 60 35 0
  view 2.5 3 0.6
end surface
```

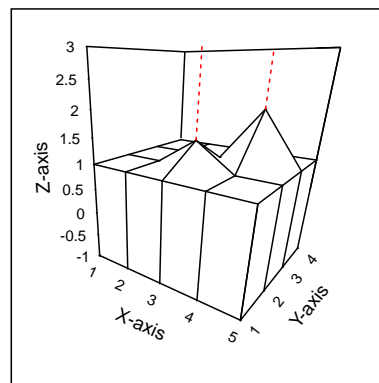

`points` *myfile.dat*

Reads in a data file which must have 3 columns (x,y,z)

This is then used for plotting markers and rise and drop lines.

`marker` *circle* [`hei v`] [`color c`]

Draws markers at the co-ordinates read from the POINTS file.

`droplines` [`color c`] [`lstyle n`]

Draws lines from the co-ordinates read from the POINTS file down to zmin.

`riselines` [`color c`] [`lstyle n`]

Draws lines from the co-ordinates read from the POINTS file up to zmax.

```
zclip [min v1] [max v2]
ZCLIP goes through the Z array and sets any Z value smaller than MIN to v1 and sets any value greater than MAX to v2.
```

## 8.2 Letz

LETZ generates a data file of z values given an expression in terms of x and y.

```
begin letz
  data "jack.z"
  z = x+sin(y^2)/pi+10.22
  x from 0 to 30 step 1
  y from 0 to 20 step 1
end letz
```

The file jack.z now contains the required data. The resulting file can be used to generate surface plots with the begin/end surface block discussed in the previous section.

## 8.3 Fitz

FITZ fits smooth curves based on a set of 3D data points. E.g., given some data points (note that each line has three values: an x, y, and z coordinate):

```
x y z
---- data file testf.dat ----
1 1 1
1 2 1
2 2 1
2 1 1
1.5 1.5 2
-----
```

Fitz creates a ".z" file that can be used in a surface block, a colormap or contour plot. The following example illustrates this.

```
begin fitz
  data "fitz.dat"
  x from 0 to 5 step 0.2
  y from 0 to 5 step 0.2
  ncontour 6
end fitz

begin surface
  size 7 7
  data "fitz.z"
  top color blue
  xaxis min 0 max 5 step 1
  yaxis min 0 max 5 step 1
  points "fitz.dat"
  droplines lstyle 1
  marker circle
  view 2.5 3 0.3
  harray 5000
end surface
```

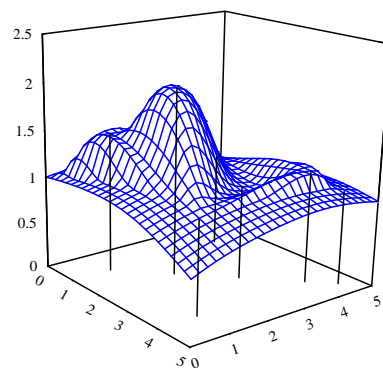

## 8.4 Contour

The contour block produces contour lines of a function  $z = f(x, y)$ .

The function  $f(x, y)$  is given by a .z file. The .z file format is discussed on page 64. Recall that a .z file can be created from sample data points, that is  $(x, y, z)$  tuples, with the fitz block (Section 8.3), or from an implicit definition of  $f(x, y)$  with a letz block (Section 8.2).



```
include "contour.gle"

begin contour
  data "saddle.z"
  values 0.5 1 1.5 2 3
end contour

begin graph
  title "Saddle Plot Contour Lines"
  data "saddle-cdata.dat"
  d1 line color blue
end graph

contour_labels "saddle-clabels.dat" "fix 1"
```

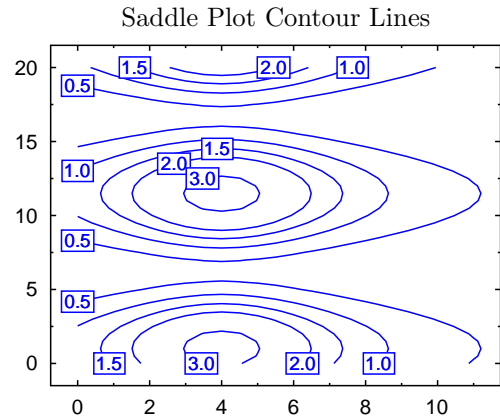

The contour block can contain the following commands:

`data file$`  
Specifies the name of the `.z` file.

`values  $v_1, \dots, v_n$`   
Specifies the  $z$ -values to contour at.

`values from  $v_1$  to  $v_n$  step  $s$`   
Specifies the  $z$ -values to contour at by means of from/to/step.

`smooth integer`  
Specifies the smoothing parameter.

The contour block creates the files “data-clabels.dat” and “data-cdata.dat” with the prefix “data” the name of the `.z` file. The file “data-clabels.dat” contains information for drawing labels on the contour plot. This is done by the subroutine `contour_labels` defined in the library “contour.gle” in the example above. The file “data-cdata.dat” contains the  $(x, y)$  values of the contour lines. This file can be used as input to a graph block and plotted with the “d1 line” command as shown in the example above.

## 8.5 Color Maps

Color maps plot a function  $z = f(x, y)$  by mapping  $z$  to a color range. The following example combines a color map with a contour plot.

```
begin contour
  data "volcano.z"
  values from 130 to 190 step 10
end contour

begin graph
  title "Auckland's Maunga Whau Volcano"
  data "volcano-cdata.dat"
  xaxis min 0 max 20
  yaxis min 0 max 20
  d1 line color black
  colormap "volcano.z" 100 100
end graph
```

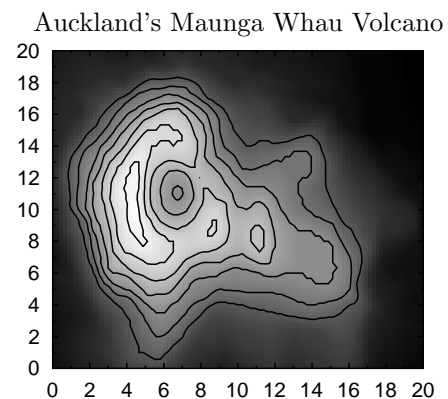

The options to the `colormap` command are as follows:

`colormap fcn pixels-x pixels-y [color] [invert] [zmin  $z_1$ ] [zmax  $z_2$ ] [palette pal]`

- `fcn` specifies the function to map. This can either be the name of a `.z` file, or it can be a function definition  $f(x, y)$ .

- *pixels-x*, *pixels-y* specify the dimension of the color map. A color map is stored as a bitmap image and (*pixels-x*, *pixels-y*) are the resolution of this bitmap. A larger resolution yields more detail, but at the cost of longer computation time and a larger file size.
- *color* is an optional argument and indicates that the color map should be drawn in color (as opposed to grayscale).
- *invert* is an optional argument that inverts the color map. That is, large function values will be drawn in black and small function values in white.
- *zmin*, *zmax* are optional arguments that specify the range of the function.
- *palette* is an optional argument that specifies the palette to use. A palette is a subroutine that maps *z* values to colors. A number of example palette subroutines are included in the library "color.gle".

The following example is a color map of a two dimensional Gaussian.

```
include "color.gle"

sub gauss x y
  s = 0.75
  return exp(-(x^2+y^2)/(2*s^2))
end sub

begin graph
  title "2D Gaussian"
  xaxis min -2 max 2
  yaxis min -2 max 2
  colormap gauss(x,y) 200 200 zmin 0 zmax 1 color
end graph

amove xg(xgmax)+0.3 yg(ygmin)
color_range_vertical 0 1 0.1 format "fix 1"
```

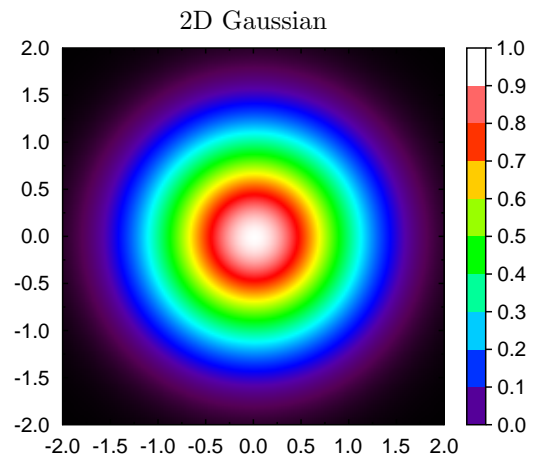



# Chapter 9

## GLE Utilities

### 9.1 Fitls

The FITLS utility allows an equation with  $n$  unknown constants to be fitted to experimental data. For example to fit a simple least squares regression line to a set of points you would give FITLS the equation:  $a*x+b$

FITLS would then solve the equation to find the *best* values for the constants  $a$  and  $b$ .

FITLS can work with non linear equations, it will ask for initial values for the parameters so that a solution around those initial guesses will be found.

FITLS writes out a GLE file containing commands to draw the data points and the equation it has fitted to them.

Here is a sample FITLS session:

```
$ fitls
Input data file (x and y columns optional) [test.dat,1,2] ? fitls.dat
Loading data from file, fitls.dat, xcolumn=1, ycolumn=2
Valid operators: +, -, *, /, ^ (power)
Valid functions:
    abs(), atn(), cos(), exp(), fix(), int()
    log(), log10(), not(), rnd(), sgn(), sin()
    sqr(), sqrt(), tan()

Enter a function of 'x' using constants 'a'...'z'
e.g.   a + b*x   (standard linear least squares fit)
       sin(x)*a+b
       a + b*x + c*x^2 + d*x^3
       log(a*x)+(b+x)*c+a

Equation ? sin(a*x)*b+c*x^2+d

Output file name to write gle file [fitls.gle] ?
Precision of fit required, [1e-4] ?
Initial value for constant a [1.0] ?
Initial value for constant b [1.0] ?
Initial value for constant c [1.0] ?
Initial value for constant d [1.0] ?
0 evaluations, 1 1 1 1 , fit = 1355.36
20 evaluations, 1.97005 1 1 1 , fit = 1281.95
40 evaluations, 1.97005 10.228 0.151285 1 , fit = 54.7694
60 evaluations, 2.01053 10.228 0.151285 1.06365 , fit = 54.1771
.
.
.
440 evaluations, -0.640525 -2.81525 0.13997 1.13871 , fit = 0.940192
460 evaluations, -0.638055 -2.82934 0.140971 1.10502 , fit = 0.93842
```

480 evaluations, -0.63808 -2.82357 0.140993 1.10452 , fit = 0.938389  
 a = -0.638262 b = -2.81719 c = 0.140722 d = 1.11256

10 Iterations, sum of squares devided by n = 0.938389  
 $y = \sin(-0.638262*x)*-2.81719+0.140722*x^2+1.11256$

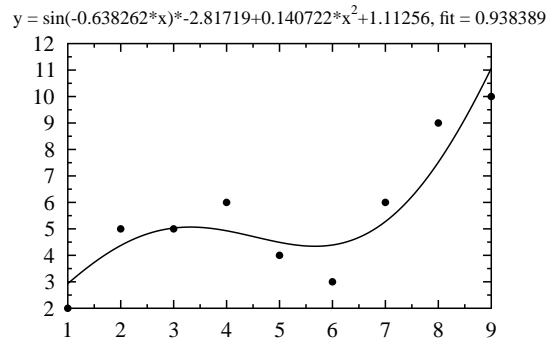

## 9.2 Manip

Manip is a data manipulation package. It reads in a text file of numbers and displays them like a spreadsheet. You can then do simple operations on the columns and write them out in any format you like.

### 9.2.1 Usage

MANIP infile.dat -recover -step -commands c.log -single -size x y

#### -recover

Manip logs everything you type to a file called MANIP\_.J1 When you use the -RECOVER option on the manip command it then reads keys from that file as if they were typed at the keyboard.

This will restore you to the point just before your pc crashed. The last three journal files are stored (.j1 .j2 .j3) simply copy the one you want to (.j1) to use it.

#### -step

Used with recover, press a space for each key you want to read from the journal file, press any other key to stop reading the journal.

#### -commands filename.man

This reads the commands in filename.man as if they were typed at the keyboard.

#### -single

This makes MANIP use single precision arithmetic and doesn't store strings at all, this enables three times as much data in the same amount of memory

#### -size x y

Sets the initial size of the spreadsheet. Use this with large datasets as it prevents the heap from becoming fragmented and thus lets you use much larger datasets.

### Range

Most manip commands accept a range as one or more of there parameters. A range is a rectangular section of your spreadsheet. A range can ether start with a 'c' or an 'r' and this will affect how the command operates.

If your spreadsheet has 5 columns and 10 rows then.

```

c1 == c1c1r1r10 == 1,1 1,2 1,3 1,4 1,5 1,6 ...
r1 == r1r1c1c5 == 1,1 2,1 3,1 4,1 5,1
c1c2 ==c1c2r1r10 == 1,1 2,1 1,2 2,2 3,1 3,2 ...
r1r2c3=r1r2c3c5 == 3,1 3,2 4,1 4,2 5,1 5,2

```

### Arrows

The arrow keys normally move the data cursor, however if you are half way thru typing a command then, the left and right arrow keys allow you to edit the command. Use the PAGE-UP and PAGE-DOWN keys to recall your last command.

SHIFT arrow keys will jump 7 cells at a time for fast movement.

Further help is available on the following topics via the HELP command e.g. "HELP COPY"

## 9.2.2 Manip Primitives (a summary)

@mycmds

Arrows

BLANK

CLEAR

CLOSE

COPY [*range*] [*range*] IF [*exp*]

DATA [*range*]

DELETE [*range*] IF [*exp*]

EXIT *filename* [*range*] -TAB -SPACE -COMMA

FIT *c3*

Functions

GENERATE [*pattern*] [*destination*]

GOTO *x y*

INSERT [*Cn*] or [*Rn*]

LOAD *filename* [*range*] -0

LOAD *filename* [*range*]

LOGGING *mycmds.man*

MOVE [*range*] [*range*] IF [*exp*]

NEW

PARSUM [*range1*] [*range2*]

PROP [*range*] [*range*]

QUIT

Recover (recovering from power failure or crash)

SAVE *filename* [*range*] -TAB -SPACE -COMMA

SET SIZE *ncols nrows*

SET BETWEEN " "

SET COLTYPE

SET COLWIDTH

SET NCOL *n*

SET DPOINTS *n*

SET DIGITS *n*

SET WIDTH *n*

SHELL

SORT [*range*] on [*exp*]

SUM [*range*]

SWAP *CnCn* — *RnRn*

## 9.2.3 Manip Primitives (in detail)

COPY [*range1*] [*range2*] if [*exp*]

For copying a section to another section. They do not have to be the same shape. The pointers to both rangers are increased even if the number is not copied e.g.

```

"% COPY r4r2 r1r2"
"% COPY c1c3r6r100 c6c8 if c1<c2"

"% COPY C1 C2 IF C1<4"
c1 c2
1 1
2 2
5 -
3 3
9 -

```

**DELETE** [*range*] IF [*exp*]

For deleting entire rows or columns. e.g.

```

"% DELETE c1c3 IF r1>3.and.r2=0
"% DELETE r1"

```

Numbers are shuffled in from the right to take the place of the deleted range.

**DATA** [*range*]

Data entry mode is useful for entering data. After typing in "% DATA c1c3" or "% DATA C2" you can then enter data and pressing *jr* will move you to the next valid data position. In this mode text or numbers can be entered. Press ESC to get back to command mode.

**FIT** *c3*

"FIT C3" will fit a least squares regression line to the data in columns c3 and c4 (x values taken from c3) and print out the results.

**EXIT**

EXIT saves the data in your input file spec and exits to DOS. You can optionally specify an output file as well. eg. "% EXIT myfile.dat"

The command "EXIT myfile.dat c3c5r1r3" will write out that range of numbers to the file.

By default manip will write columns separated by spaces.

The command "EXIT myfile.dat -TAB" will put a single tab between each column of numbers and "EXIT myfile.dat -COMMA" will put a comma and a space between each number. (these two options are useful if your data file is very big and you don't want to waste disk space with the space characters.) Note: The settings stay in effect for future saves and exits.

You can make it line up the columns on the decimal point by typing in the command. "SET DPOINTS 3"

You change the width of each column or completely remove the spaces between columns with the command. "SET WIDTH 10" (or set width 0)

You can change the number of significant digits displayed with the command "SET DIGITS 4"

**SAVE** *myfile.dat*

Saves all or part of your data. The command "SAVE myfile.dat c3c5r1r3" will write out that range of numbers to the file.

By default manip will write columns separated by spaces.

The command "SAVE myfile.dat -TAB" will put a single tab between each column of numbers and "SAVE myfile.dat -COMMA" will put a comma and a space between each number. (these two options are useful if your data file is very big and you don't want to waste disk space with the space characters).

Further options are the same like EXIT

**GOTO**

For moving the cursor directly to a point in your array. e.g. "% GOTO x y"

**CLEAR**

"% CLEAR C2C3" Clears the given range of all values

**BLANK**

"% BLANK C2C3" Clears the given range of all values

**NEW**

Clears the spread sheet of all data and frees memory.

**INSERT**

Inserts a new column or row and shifts all others over. e.g. "% INSERT c5" or "% INSERT r2".

**LOAD**

Load data into columns. eg. "% LOAD filename" loads all data into corresponding columns. "% LOAD filename c3" load first column of data into c3 etc.

"LOAD myfile.dat c3 -LIST" This command will load the the data into a single column or range (even if it is several columns wide in the data file)

**MOVE** [*range1*] [*range2*] if [*exp*]

For copying a section to another section. They do not have to be the same shape. The pointer to the destination is only increased if the line or column is copied e.g.

```
"% MOVE c1 c2c3"
"% MOVE r4r2 r1r2"
"% MOVE c1c3r6r100 c6c8 if c1<c2"
```

```
"% MOVE C1 C2 IF C1<4"
```

```
c1 c2
1 1
2 2
5 3
3 -
9 -
```

(See COPY command)

**SORT** [*range*] ON [*exp*]

Sort entire rows of the data based on the data in a particular column. e.g.

```
"% SORT c8 on c9"
"% SORT c1c8 on -c8"
"% SORT c1c3 on c2 " !for sorting strings
```

This command works out how to sort the column (or exp) specified in the ON part of the command. It then does that operation to the range specified. e.g. "SORT C1 ON C1" will sort column one.

Use the additional qualifier -STRINGS if you want to sort a column with strings in it. e.g. "sort c1 on c2 -strings"

**SWAP**

Swap over two columns or rows. e.g.

```
"% SWAP c1c2"
"% SWAP r3r1"
```

**SET SIZE** *ncols nrows*

"SIZE 3 4" Truncates the spreadsheet to 3 columns and 4 rows. This also sets the values to use for default ranges.

**SET BETWEEN** " "

"SET BETWEEN ###" Defines the string to be printed between each column of numbers when written to a file. This is normally set to a single space.



**SET COLWIDTH**

Set the width of each column when displayed. e.g. "% SET COLWIDTH 12"

**SET COLTYPE [*n*] DECIMAL — EXP — BOTH — DPOINTS *n***

This commands allows all or individual columns to be set to different output types. If colnumber is missing then that setting is applied to all columns.

SET COLTYPE Ccolnumber TYPE Where TYPE is one of:

```
DECIMAL produces 123.456
EXP produces 1.23456e02
BOTH produces whichever is more suitable
DPOINTS n produces a fixed number of decimal places.
```

e.g.

```
SET COLTYPE c2 DECIMAL
SET COLTYPE c1 EXP
SET COLTYPE c3 DPOINTS 4
```

Would print out: 1.2e02 1.2 1.2000

```
SET COLTYPE EXP (column number missed out)
```

Would print out: 1.2e02 1.2e02 1.2e02

**SET NCOL *n***

Set the number of columns to display. e.g. "% SET NCOL 3"

**SET DPOINTS *n***

Sets the number of decimal places to print. This is used for producing columns which line up on the decimal point. e.g. with DPOINTS 3.

```
2.2 -> 2.200
234 -> 234.000
```

(See also SET COLTYPE)

**SET DIGITS *n***

Sets the number of significant digits to be displayed, e.g. with DIGITS 3.

```
123456 becomes 123000
0.12345 becomes 0.123
```

**SET WIDTH *n***

Sets the width of padding to use for the columns when they are written to a file. The columns usually one space wider than this setting as the BETWEEN string is usually set to one space by default.

**LOGGING**

For creating command files. e.g.

```
"% LOG sin.man"
"% c2=sin(c1)
"% c3=c2+2
"% close"
```

Then type in "@sin" to execute these commands.

**PROPAGATE [*source*] [*destination*]**

This command has the same format as move. The difference is that the source is copied as many times as possible to fill up the destination. e.g. "% PROP c1r1r7 c2"

**SUM [*range*]**

Adds up all the numbers in a range and displays the total and average. e.g. "% SUM C1C3"

**PARSUM** [*range1*] [*range2*]

Adds up one column, putting the partial sum's into another column. e.g. 1,2,3,4 becomes 1,3,6,10.

**GENERATE** [*pattern*] [*destination*]

For generating a pattern of data e.g. 1 1 2 2 5 5 1 1 2 2 5 5 etc.

"% GEN 2(1,2,5)30 c4" !1 1 2 2 5 5 repeated 30 times

"% GEN (1:100:5)5 c1" !1 to 100 step 5, 5 times

"% GEN (1,2,\*,3:5)5 c1" !missing values included

**Functions**

Calculations can be performed on rows or columns. eg "% C1=C2\*3+R" where "R" stands for row-number and C1 and C2 are columns. They can also be performed on ROWS. eg

r1=sin(r2)+log10(c)

c1 = cell(c+1,r)+cell(c+2,r)

cell(1,3) = 33.3

3+4\*COS(PI/180)^(3+1/30)+C1+R

Valid operators and functions:

,	+	-	^	*	/	<=
>=	<>	<	>	=	)AND(	)OR(
ABS(	ATN(	COS(	EXP(	FIX(	INT(	LOG(
LOG10(	SGN(	SIN(	SQR(	TAN(	NOT(	RND(
SQRT(	.NE.	.EQ.	.LT.	.GT.	.LE.	.GE.
.NOT.	.AND.	.OR.				

**QUIT**

Abandon file.

**SHELL**









































Gives access to DOS.



# Appendix A

## Tables

### A.1 Markers

 triangle	 fcircle	 odot	 flower	 handpen
 wtriangle	 diamond	 ominus	 club	 letter
 ftriangle	 wdiamond	 oplus	 heart	 phone
 square	 fdiamond	 otimes	 spade	 plane
 wsquare	 cross	 star	 dag	 scircle
 fsquare	 plus	 star2	 ddag	 ssquare
 circle	 minus	 star3	 snake	 trianglez
 wcircle	 asterisk	 star4	 dot	 diamondz

### A.2 Functions and Variables

Function name	Returns ...
<code>abs(exp)</code>	absolute value of expression
<code>acos(exp)</code>	arccosine
<code>acosh(exp)</code>	inverse hyperbolic cosine
<code>acot(exp)</code>	$1/\text{atan}(\text{exp})$
<code>acoth(exp)</code>	$1/\text{atanh}(\text{exp})$
<code>acsc(exp)</code>	$1/\text{asin}(\text{exp})$
<code>acsch(exp)</code>	$1/\text{asinh}(\text{exp})$
<code>arg(i)</code>	i-th command line argument
<code>arg\$(i)</code>	i-th command line argument
<code>asec(exp)</code>	$1/\text{acos}(\text{exp})$
<code>asech(exp)</code>	$1/\text{acosh}(\text{exp})$
<code>asin(exp)</code>	arcsine
<code>asinh(exp)</code>	inverse hyperbolic sine
<code>atan(exp)</code>	arctan
<code>atanh(exp)</code>	inverse hyperbolic tangent
<code>atn(exp)</code>	same as <code>ATAN(exp)</code>
<code>cos(exp)</code>	cosine
<code>cosh(exp)</code>	hyperbolic cosine
<code>cot(exp)</code>	$1/\text{tan}(\text{exp})$
<code>coth(exp)</code>	$1/\text{tanh}(\text{exp})$
<code>csc()</code>	$1/\text{sin}(\text{exp})$

<code>csch(exp)</code>	$1/\sinh(\text{exp})$
<code>dataxvalue(ds,i)</code>	$x$ -value of $i$ -th point in <code>ds</code> (p. 48)
<code>datayvalue(ds,i)</code>	$y$ -value of $i$ -th point in <code>ds</code> (p. 48)
<code>date\$()</code>	current date e.g. "Tue Apr 09 1991"
<code>device\$()</code>	available devices e.g. "HARDCOPY, PS"
<code>eval(str)</code>	evaluates given GLE expression
<code>exp(exp)</code>	exponent
<code>\expr(exp)</code>	substitute result of evaluating "exp"
<code>file\$()</code>	returns GLE file name (without extension)
<code>fix(exp)</code>	<code>exp</code> rounded towards 0
<code>format\$(exp,format)</code>	format <code>exp</code> as specified in <code>format</code> (p. 48)
<code>height(name\$)</code>	the height of the object <code>name\$</code>
<code>int(exp)</code>	integer part of <code>exp</code>
<code>left\$(str\$,exp)</code>	left <code>exp</code> characters of <code>str\$</code>
<code>len(str\$)</code>	the length of <code>str\$</code>
<code>log(exp)</code>	log to base $e$ of <code>exp</code>
<code>log10(exp)</code>	log to base 10 of <code>exp</code>
<code>nargs()</code>	number of command line arguments
<code>ndata(ds)</code>	number of points in data set <code>ds</code> (p. 48)
<code>not(exp)</code>	logical not of <code>exp</code>
<code>num1\$(exp)</code>	as above but with no spaces
<code>num\$(exp)</code>	string representation of <code>exp</code>
<code>pageheight()</code>	the height of the page (from size command)
<code>pagewidth()</code>	the width of the page (from size command)
<code>path\$()</code>	returns the directory where the script is located
<code>pointx(pt)</code>	the $x$ value of named point <code>pt</code>
<code>pointy(pt)</code>	the $y$ value of named point <code>pt</code>
<code>pos(str1\$,str2\$,exp)</code>	position of <code>str2\$</code> in <code>str1\$</code> from <code>exp</code>
<code>ptx(pt)</code>	the $x$ value of named point <code>pt</code> (abbreviation for <code>pointx</code> )
<code>pty(pt)</code>	the $y$ value of named point <code>pt</code> (abbreviation for <code>pointy</code> )
<code>rgb(red,green,blue)</code>	create color given RGB values
<code>rgb255(red,green,blue)</code>	create color given RGB values
<code>right\$(str\$,exp)</code>	rest of <code>str\$</code> starting at <code>exp</code>
<code>rnd(exp)</code>	random number between 0 and <code>exp</code>
<code>sdiv(x,y)</code>	return $x/y$ or 0 if $y = 0$
<code>sec(exp)</code>	$1/\cos(\text{exp})$
<code>sech(exp)</code>	$1/\cosh(\text{exp})$
<code>seg\$(str\$,exp1,exp2)</code>	<code>str\$</code> from <code>exp1</code> to <code>exp2</code>
<code>sgn(exp)</code>	returns 1 if <code>exp</code> is positive, -1 if <code>exp</code> is negative
<code>sin(exp)</code>	sine of <code>exp</code>
<code>sinh(exp)</code>	hyperbolic sine
<code>sqr(exp)</code>	<code>exp</code> squared
<code>sqrt(exp)</code>	square root of <code>exp</code>
<code>tan(exp)</code>	tangent of <code>exp</code>
<code>tanh(exp)</code>	hyperbolic tangent
<code>tdepth(str\$)</code>	the depth of <code>str\$</code> assuming current the font, size
<code>theight(str\$)</code>	the height of <code>str\$</code> assuming current font, size
<code>time\$()</code>	current time e.g. "11:44:27"
<code>todeg(exp)</code>	convert from radians to degrees
<code>torad(exp)</code>	convert from degrees to radians
<code>twidth(str\$)</code>	the width of <code>str\$</code> assuming current font, size
<code>val(str\$)</code>	value of the string <code>str\$</code>

<code>width(name\$)</code>	the width of the object <code>name\$</code>
<code>xbar(x,i)</code>	the absolute x coordinate of the i-th bar at point x on the graph
<code>xend()</code>	the x end point of a text string when drawn
<code>xg(xexp)</code>	converts units of last graph to abs cm.
<code>xpos()</code>	the current x point
<code>xy2angle(dx,dy)</code>	convert rectangular coordinates to polar angle (in degrees)
<code>yend()</code>	the y end point of a text string when drawn
<code>yg(yexp)</code>	converts units of last graph to abs cm.
<code>ypos()</code>	the current y point

Variable name	Returns ...
<code>pi</code>	3.14...
<code>xgmin</code>	the minimum x-coordinate of the graph
<code>xgmax</code>	the maximum x-coordinate of the graph
<code>xg2min</code>	the minimum x2-coordinate of the graph
<code>xg2max</code>	the maximum x2-coordinate of the graph
<code>ygmin</code>	the minimum y-coordinate of the graph
<code>ygmax</code>	the maximum y-coordinate of the graph
<code>yg2min</code>	the minimum y2-coordinate of the graph
<code>yg2max</code>	the maximum y2-coordinate of the graph

### A.3 L<sup>A</sup>T<sub>E</sub>X Macros and Symbols

There are several L<sup>A</sup>T<sub>E</sub>X like commands which can be used within text, they are:

<code>\ \' \v \u \= \^</code>	Implemented TeX accents
<code>\. \H \~ \'</code>	
<code>^{}</code>	Superscript
<code>_{} </code>	Subscript
<code>\\</code>	Forced Newline
<code>\_</code>	Underscore character
<code>\,</code>	.5em (em = width of the letter 'm')
<code>\:</code>	1em space
<code>\;</code>	2em space
<code>\tex{expression}</code>	Any LaTeX expression
<code>\char{22}</code>	Any character in current font
<code>\chardef{a}{hello}</code>	Define a character as a macro
<code>\def\v{hello}</code>	Defines a macro
<code>\movexy{2}{3}</code>	Moves the current text point
<code>\glass</code>	Makes move/space work on beginning of line
<code>\rule{2}{4}</code>	Draws a filled in box, 2cm by 4cm
<code>\setfont{rmb}</code>	Sets the current text font
<code>\sethei{.3}</code>	Sets the font height (in cm)
<code>\setstretch{2}</code>	Scales the quantity of glue between words
<code>\lineskip{.1}</code>	Sets the default distance between lines of text
<code>\linegap{-1}</code>	Sets the minimum required gap between lines

[	<code>\lbrack</code>	β	<code>\ss</code>	≥	<code>\geq</code>	†	<code>\dag</code>	‡	<code>\ddag</code>
§	<code>\S</code>	¶	<code>\P</code>	©	<code>\copyright</code>	α	<code>\alpha</code>	β	<code>\beta</code>
γ	<code>\gamma</code>	δ	<code>\delta</code>	ε	<code>\epsilon</code>	ζ	<code>\zeta</code>	η	<code>\eta</code>
θ	<code>\theta</code>	ι	<code>\iota</code>	κ	<code>\kappa</code>	λ	<code>\lambda</code>	μ	<code>\mu</code>
ν	<code>\nu</code>	ξ	<code>\xi</code>	π	<code>\pi</code>	ρ	<code>\rho</code>	σ	<code>\sigma</code>
τ	<code>\tau</code>	υ	<code>\upsilon</code>	φ	<code>\phi</code>	χ	<code>\chi</code>	ψ	<code>\psi</code>
ω	<code>\omega</code>	ε	<code>\varepsilon</code>	ϑ	<code>\vartheta</code>	ϖ	<code>\varpi</code>	ϱ	<code>\varrho</code>
ς	<code>\varsigma</code>	φ	<code>\varphi</code>	ℵ	<code>\aleph</code>	ι	<code>\imath</code>	ℵ	<code>\jmath</code>
ℓ	<code>\ell</code>	ϕ	<code>\wp</code>	ℜ	<code>\Re</code>	ℑ	<code>\Im</code>	∂	<code>\partial</code>
∞	<code>\infty</code>	′	<code>\prime</code>	∅	<code>\emptyset</code>	∇	<code>\nabla</code>	⊤	<code>\top</code>
⊥	<code>\bot</code>	△	<code>\triangle</code>	∀	<code>\forall</code>	∃	<code>\exists</code>	¬	<code>\neg</code>
♭	<code>\flat</code>	♮	<code>\natural</code>	♯	<code>\sharp</code>	♣	<code>\clubsuit</code>	♠	<code>\spadesuit</code>
♥	<code>\heartsuit</code>	♠	<code>\spadesuit</code>	∏	<code>\coprod</code>	∨	<code>\bigvee</code>	∧	<code>\bigwedge</code>
⊕	<code>\biguplus</code>	∩	<code>\bigcap</code>	∪	<code>\bigcup</code>	∏	<code>\prod</code>	∑	<code>\sum</code>
⊗	<code>\bigotimes</code>	⊕	<code>\bigoplus</code>	⊙	<code>\bigodot</code>	∏	<code>\bigsqcup</code>	∫	<code>\smallint</code>
∫	<code>\intop</code>	∫	<code>\ointop</code>	◁	<code>\triangleleft</code>	▷	<code>\triangleright</code>	△	<code>\bigtriangleup</code>
▽	<code>\bigtriangledown</code>	∧	<code>\wedge</code>	∧	<code>\land</code>	∨	<code>\vee</code>	∨	<code>\lor</code>
∩	<code>\cap</code>	∪	<code>\cup</code>	‡	<code>\ddagger</code>	†	<code>\dagger</code>	∏	<code>\sqcap</code>
∪	<code>\sqcup</code>	⊕	<code>\uplus</code>	∏	<code>\amalg</code>	◇	<code>\diamond</code>	•	<code>\bullet</code>
∷	<code>\wr</code>	÷	<code>\div</code>	⊙	<code>\odot</code>	⊗	<code>\oslash</code>	⊗	<code>\otimes</code>
⊖	<code>\ominus</code>	⊕	<code>\oplus</code>	∓	<code>\mp</code>	±	<code>\pm</code>	○	<code>\circ</code>
○	<code>\bigcirc</code>	∖	<code>\setminus</code>	⋅	<code>\cdot</code>	*	<code>\ast</code>	×	<code>\times</code>
*	<code>\star</code>	Å	<code>\AA</code>						

## A.4 Installing GLE

### A.5 Fonts

rm	Roman	pstr	Times-Roman
rmb	<b>Roman Bold</b>	pstb	<b>Times-Bold</b>
rmi	<i>Roman Italic</i>	psti	<i>Times-Italic</i>
ss	Sans Serif	pstbi	<b><i>Times-BoldItalic</i></b>
ssb	<b>Sans Serif Bold</b>	psc	Courier
ssi	<i>Sans Serif Italic</i>	pscb	<b>Courier-Bold</b>
tt	Typewriter	psco	<i>Courier-Oblique</i>
ttb	<b>Typewriter Bold</b>	pscbo	<b><i>Courier-BoldOblique</i></b>
tti	<i>Typewriter Italic</i>	psh	Helvetica
		pshb	<b>Helvetica-Bold</b>
		psho	<i>Helvetica-Oblique</i>
texcmr	Computer Modern Roman	pshbo	<b><i>Helvetica-BoldOblique</i></b>
texcmb	<b>Computer Modern Bold</b>	pshc	Helvetica-Condensed
texcmti	<i>Computer Modern Text Italic</i>	pshcb	<b>Helvetica-Condensed-Bold</b>
texcmmi	<i>ComputerModernMathsItalic</i>	pshcdo	<i>Helvetica-Condensed-Oblique</i>
texcmss	Computer Modern Sans Serif	pshn	Helvetica-Narrow
texcmssb	<b>Computer Modern Sans Serif Bold</b>	pshnb	<b>Helvetica-Narrow-Bold</b>
texcmssi	<i>Computer Modern Sans Serif Italic</i>	pshno	<i>Helvetica-NarrowOblique</i>
texcmtt	Computer Modern Typewriter Text	pshnbo	<b><i>Helvetica-Narrow-BoldOblique</i></b>
texcmitt	<i>Computer Modern Italic Typewriter</i>	psagb	AvantGarde-Book
		psagd	<b>AvantGarde-Demi</b>
		psagbo	<i>AvantGarde-BookOblique</i>
		psagdo	<b><i>AvantGarde-DemiOblique</i></b>
plsr	Simplex Roman	psbl	Bookman-Light
pldr	Duplex Roman	psbd	<b>Bookman-Demi</b>
pltr	<b>Triplex Roman</b>	psbli	<i>Bookman-LightItalic</i>
plti	<i>Triplex Italic</i>	psbdi	<b><i>Bookman-DemiItalic</i></b>
plcr	Complex Roman	psncsr	NewCenturySchlbk-Roman
plci	<i>Complex Italic</i>	psncsb	<b>NewCenturySchlbk-Bold</b>
plss	<i>Simplex Script</i>	psncsi	<i>NewCenturySchlbk-Italic</i>
plcs	<i>Complex Script</i>	psncsbi	<b><i>NewCenturySchlbk-BoldItalic</i></b>
plsa	Simplex ASCII	pspr	Palatino-Roman
plba	<b>Block Ascii</b>	pspb	<b>Palatino-Bold</b>
plge	<b>Gothic English</b>	pspi	<i>Palatino-Italic</i>
plgg	<b>Gothic German</b>	pspbi	<b><i>Palatino-BoldItalic</i></b>
plgi	<b>Gothic Italian</b>	pssym	ΠοστΣχριπτ Συμβολ
plsg	Τυπμεω Ησσελ	pszcmi	<i>ZapfChancery-Medium Italic</i>
		pszd	⦿☐⦿⦿⦿⦿⦿⦿⦿⦿⦿⦿⦿⦿



### A.6 Font Tables

Roman (rm)

0	1	2	3	4	5	6	7	8	9	10	11	12	13	14	15	16	17	18	19		
0	p																				
2												!	"	#	\$	%	&	'			
4	(	)	*	+	,	-	.	/	0	1	2	3	4	5	6	7	8	9	:	;	
6	<	=	>	?	@	A	B	C	D	E	F	G	H	I	J	K	L	M	N	O	
8	P	Q	R	S	T	U	V	W	X	Y	Z	[	\	]	^	-	'	a	b	c	
10	d	e	f	g	h	i	j	k	l	m	n	o	p	q	r	s	t	u	v	w	
12	x	y	z	{		}	~														
14																					
16	i	¢	£	/	¥	f	§	¤	•	“	«	<	>	fi	fl	°	-	†	‡		
18	·	µ	¶	•	,	”	»	»	…	%	¾	¿	À	,	ˆ	˜	-	˘	˙		
20	..	È	˚	˘	˙	˚	˛	˜	—	N	Ó	Ô	Õ	Ö	×	Ø	Ù	Ú	Û		
22	Ü	Ý	Þ	ß	à	Æ	â	ä	å	ä	å	æ	ç	Ł	Ø	Œ	ø	ì	í	î	ï
24	ð	æ	ò	ó	ô	ı	ö	÷	ı	ø	œ	ß	ü	ý	þ	ÿ	Á				

Roman Bold (rmb)

0	1	2	3	4	5	6	7	8	9	10	11	12	13	14	15	16	17	18	19		
0	p																				
2													!	"	#	\$	%	&	'		
4	(	)	*	+	,	-	.	/	0	1	2	3	4	5	6	7	8	9	:	;	
6	<	=	>	?	@	A	B	C	D	E	F	G	H	I	J	K	L	M	N	O	
8	P	Q	R	S	T	U	V	W	X	Y	Z	[	\	]	^	-	'	a	b	c	
10	d	e	f	g	h	i	j	k	l	m	n	o	p	q	r	s	t	u	v	w	
12	x	y	z	{		}	~														
14																					
16	i	¢	£	/	¥	f	§	¤	•	“	«	<	>	fi	fl	°	-	†	‡		
18	·	µ	¶	•	,	”	»	»	…	%	¾	¿	À	,	ˆ	˜	-	˘	˙		
20	..	È	˚	˘	˙	˚	˛	˜	—	N	Ó	Ô	Õ	Ö	×	Ø	Ù	Ú	Û		
22	Ü	Ý	Þ	ß	à	Æ	â	ä	å	ä	å	æ	ç	Ł	Ø	Œ	ø	ì	í	î	ï
24	ð	æ	ò	ó	ô	ı	ö	÷	ı	ø	œ	ß	ü	ý	þ	ÿ	Á				

Roman Italic (rmi)

0	1	2	3	4	5	6	7	8	9	10	11	12	13	14	15	16	17	18	19		
0	p																				
2													!	"	#	\$	%	&	'		
4	(	)	*	+	,	-	.	/	0	1	2	3	4	5	6	7	8	9	:	;	
6	<	=	>	?	@	A	B	C	D	E	F	G	H	I	J	K	L	M	N	O	
8	P	Q	R	S	T	U	V	W	X	Y	Z	[	\	]	^	-	'	a	b	c	
10	d	e	f	g	h	i	j	k	l	m	n	o	p	q	r	s	t	u	v	w	
12	x	y	z	{		}	~														
14																					
16	i	¢	£	/	¥	f	§	¤	•	“	«	<	>	fi	fl	°	-	†	‡		
18	·	µ	¶	•	,	”	»	»	…	%	¾	¿	À	,	ˆ	˜	-	˘	˙		
20	..	È	˚	˘	˙	˚	˛	˜	—	N	Ó	Ô	Õ	Ö	×	Ø	Ù	Ú	Û		
22	Ü	Ý	Þ	ß	à	Æ	â	ä	å	ä	å	æ	ç	Ł	Ø	Œ	ø	ì	í	î	ï
24	ð	æ	ò	ó	ô	ı	ö	÷	ı	ø	œ	ß	ü	ý	þ	ÿ	Á				

San Serif (ss)

0	1	2	3	4	5	6	7	8	9	10	11	12	13	14	15	16	17	18	19		
0	p																				
2													!	"	#	\$	%	&	'		
4	(	)	*	+	,	-	.	/	0	1	2	3	4	5	6	7	8	9	:	;	
6	<	=	>	?	@	A	B	C	D	E	F	G	H	I	J	K	L	M	N	O	
8	P	Q	R	S	T	U	V	W	X	Y	Z	[	\	]	^	-	'	a	b	c	
10	d	e	f	g	h	i	j	k	l	m	n	o	p	q	r	s	t	u	v	w	
12	x	y	z	{		}	~														
14																					
16	i	¢	£	/	¥	f	§	¤	•	“	«	<	>	fi	fl	°	-	†	‡		
18	·	µ	¶	•	,	”	»	»	…	%	¾	¿	À	,	ˆ	˜	-	˘	˙		
20	..	È	˚	˘	˙	˚	˛	˜	—	N	Ó	Ô	Õ	Ö	×	Ø	Ù	Ú	Û		
22	Ü	Ý	Þ	ß	à	Æ	â	ä	å	ä	å	æ	ç	Ł	Ø	Œ	ø	ì	í	î	ï
24	ð	æ	ò	ó	ô	ı	ö	÷	ı	ø	œ	ß	ü	ý	þ	ÿ	Á				

San Serif Bold (ssb)

0	1	2	3	4	5	6	7	8	9	10	11	12	13	14	15	16	17	18	19		
0	p																				
2													!	"	#	\$	%	&	'		
4	(	)	*	+	,	-	.	/	0	1	2	3	4	5	6	7	8	9	:	;	
6	<	=	>	?	@	A	B	C	D	E	F	G	H	I	J	K	L	M	N	O	
8	P	Q	R	S	T	U	V	W	X	Y	Z	[	\	]	^	-	'	a	b	c	
10	d	e	f	g	h	i	j	k	l	m	n	o	p	q	r	s	t	u	v	w	
12	x	y	z	{		}	~														
14																					
16	i	¢	£	/	¥	f	§	¤	•	“	«	<	>	fi	fl	°	-	†	‡		
18	·	µ	¶	•	,	”	»	»	…	%	¾	¿	À	,	ˆ	˜	-	˘	˙		
20	..	È	˚	˘	˙	˚	˛	˜	—	N	Ó	Ô	Õ	Ö	×	Ø	Ù	Ú	Û		
22	Ü	Ý	Þ	ß	à	Æ	â	ä	å	ä	å	æ	ç	Ł	Ø	Œ	ø	ì	í	î	ï
24	ð	æ	ò	ó	ô	ı	ö	÷	ı	ø	œ	ß	ü	ý	þ	ÿ	Á				

San Serif Italic (ssi)

0	1	2	3	4	5	6	7	8	9	10	11	12	13	14	15	16	17	18	19		
0	p																				
2													!	"	#	\$	%	&	'		
4	(	)	*	+	,	-	.	/	0	1	2	3	4	5	6	7	8	9	:	;	
6	<	=	>	?	@	A	B	C	D	E	F	G	H	I	J	K	L	M	N	O	
8	P	Q	R	S	T	U	V	W	X	Y	Z	[	\	]	^	-	'	a	b	c	
10	d	e	f	g	h	i	j	k	l	m	n	o	p	q	r	s	t	u	v	w	
12	x	y	z	{		}	~														
14																					
16	i	¢	£	/	¥	f	§	¤	•	“	«	<	>	fi	fl	°	-	†	‡		
18	·	µ	¶	•	,	”	»	»	…	%	¾	¿	À	,	ˆ	˜	-	˘	˙		
20	..	È	˚	˘	˙	˚	˛	˜	—	N	Ó	Ô	Õ	Ö	×	Ø	Ù	Ú	Û		
22	Ü	Ý	Þ	ß	à	Æ	â	ä	å	ä	å	æ	ç	Ł	Ø	Œ	ø	ì	í	î	ï
24	ð	æ	ò	ó	ô	ı	ö	÷	ı	ø	œ	ß	ü	ý	þ	ÿ	Á				

Typewriter (tt)

Font table for Typewriter (tt) showing characters from 0 to 24 across columns 0 to 19.

Typewriter Bold (ttb)

Font table for Typewriter Bold (ttb) showing characters from 0 to 24 across columns 0 to 19.

Typewriter Italic (tti)

Font table for Typewriter Italic (tti) showing characters from 0 to 24 across columns 0 to 19.

TEXComputer Modern Roman (texcmr)

Font table for TEXComputer Modern Roman (texcmr) showing characters from 0 to 24 across columns 0 to 19.

TEXComputer Modern Bold (texcmb)

Font table for TEXComputer Modern Bold (texcmb) showing characters from 0 to 24 across columns 0 to 19.

TEXComputer Modern Text Italic (texcmi)

Font table for TEXComputer Modern Text Italic (texcmi) showing characters from 0 to 24 across columns 0 to 19.



TEXComputer Modern Symbol (texcmsy)

	0	1	2	3	4	5	6	7	8	9	10	11	12	13	14	15	16	17	18	19
0	—	·	×	*	÷	◊	±	∓	⊕	⊖	⊗	⊘	⊙	○	◦	•	×	≡	⊆	⊇
2	≤	≥	≲	≳	≈	≅	⊂	⊃	⊂⊂	⊃⊃	↔	↔	↔	↔	↔	↔	↔	↔	↔	↔
4	⇐	⇒	⇑	⇓	⇔	↗	↘	∞	∕	∞	∞	∞	∞	∞	∞	∞	∞	∞	∞	∞
6	℔	℔	℔	℔	℔	℔	℔	℔	℔	℔	℔	℔	℔	℔	℔	℔	℔	℔	℔	℔
8	℔	℔	℔	℔	℔	℔	℔	℔	℔	℔	℔	℔	℔	℔	℔	℔	℔	℔	℔	℔
10	℔	℔	℔	℔	℔	℔	℔	℔	℔	℔	℔	℔	℔	℔	℔	℔	℔	℔	℔	℔
12	§	†	‡	♣	♠	♠	♠	♠	♠	♠	♠	♠	♠	♠	♠	♠	♠	♠	♠	♠
14																				
16																				
18																				
20																				
22																				
24																				

TEXComputer Modern Extensible (texcmex)

	0	1	2	3	4	5	6	7	8	9	10	11	12	13	14	15	16	17	18	19	
0	{	}	[	]	[	]	[	]	[	]	[	]	[	]	[	]	[	]	[	]	[
2	{	}	[	]	[	]	[	]	[	]	[	]	[	]	[	]	[	]	[	]	[
4	{	}	[	]	[	]	[	]	[	]	[	]	[	]	[	]	[	]	[	]	[
6	{	}	[	]	[	]	[	]	[	]	[	]	[	]	[	]	[	]	[	]	[
8	Σ	Π	∫	∫	∫	∫	∫	∫	∫	∫	∫	∫	∫	∫	∫	∫	∫	∫	∫	∫	
10	~	~	~	~	~	~	~	~	~	~	~	~	~	~	~	~	~	~	~	~	
12	↑	↓	↖	↗	↖	↗	↖	↗	↖	↗	↖	↗	↖	↗	↖	↗	↖	↗	↖	↗	
14	(	(	(	(	(	(	(	(	(	(	(	(	(	(	(	(	(	(	(	(	
16	(	(	(	(	(	(	(	(	(	(	(	(	(	(	(	(	(	(	(	(	
18	(	(	(	(	(	(	(	(	(	(	(	(	(	(	(	(	(	(	(	(	
20	(	(	(	(	(	(	(	(	(	(	(	(	(	(	(	(	(	(	(	(	
22	(	(	(	(	(	(	(	(	(	(	(	(	(	(	(	(	(	(	(	(	
24	(	(	(	(	(	(	(	(	(	(	(	(	(	(	(	(	(	(	(	(	

PostScript Symbol (pssym)

	0	1	2	3	4	5	6	7	8	9	10	11	12	13	14	15	16	17	18	19
0																				
2																				
4	(	)	*	+	,	-	·	/	0	1	2	3	4	5	6	7	8	9	:	;
6	<	=	>	?	≡	A	B	X	Δ	E	Φ	Γ	H	I	∂	K	Λ	M	N	O
8	Π	Θ	P	S	T	Y	ζ	Ω	Ξ	Ψ	Z	[	∴	]	⊥	-	-	α	β	χ
10	δ	ε	φ	γ	η	ι	φ	κ	λ	μ	ν	ο	π	θ	ρ	σ	τ	υ	ω	ω
12	ξ	ψ	ζ	{		}	~													
14																				
16	€	Υ	,	≤	/	∞	f	♣	♦	♥	♠	↔	←	↑	→	↓	◦	±	”	≥
18	×	∞	∂	·	÷	≠	≡	≈	…		—	⌘	⌘	⌘	⌘	⊗	⊕	⊖	⊃	⊂
20	∪	∩	⊃	⊆	⊆	⊆	⊆	∠	∇	⊗	⊗	⊗	⊗	⊗	⊗	⊗	⊗	⊗	⊗	⊗
22	⇐	⇑	⇒	⇓	⇔	◊	⊗	⊗	⊗	⊗	⊗	⊗	⊗	⊗	⊗	⊗	⊗	⊗	⊗	⊗
24	>	∫	∫	∫	∫	∫	∫	∫	∫	∫	∫	∫	∫	∫	∫	∫	∫	∫	∫	∫

PostScript ZapfDingbats (pszd)

	0	1	2	3	4	5	6	7	8	9	10	11	12	13	14	15	16	17	18	19
0	➤																			
2																				
4	☞	☞	☞	☞	☞	☞	☞	☞	☞	☞	☞	☞	☞	☞	☞	☞	☞	☞	☞	☞
6	♣	†	†	†	♠	♠	♠	♠	♠	♠	♠	♠	♠	♠	♠	♠	♠	♠	♠	♠
8	☆	★	★	★	★	★	★	★	★	★	★	★	★	★	★	★	★	★	★	★
10	✱	✱	✱	✱	✱	✱	✱	✱	✱	✱	✱	✱	✱	✱	✱	✱	✱	✱	✱	✱
12																				
14																				
16	☺	☺	☺	☺	☺	☺	☺	☺	☺	☺	☺	☺	☺	☺	☺	☺	☺	☺	☺	☺
18	①	②	③	④	⑤	⑥	⑦	⑧	⑨	⑩	⑪	⑫	⑬	⑭	⑮	⑯	⑰	⑱	⑲	⑳
20	①	②	③	④	⑤	⑥	⑦	⑧	⑨	⑩	➔	➔	➔	➔	➔	➔	➔	➔	➔	➔
22	➔	➔	➔	➔	➔	➔	➔	➔	➔	➔	➔	➔	➔	➔	➔	➔	➔	➔	➔	➔
24	➔	➔	➔	➔	➔	➔	➔	➔	➔	➔	➔	➔	➔	➔	➔	➔	➔	➔	➔	➔

PostScript Times-Roman (pstr)

	0	1	2	3	4	5	6	7	8	9	10	11	12	13	14	15	16	17	18	19
0	p																			
2																				
4	(	)	*	+	,	-	·	/	0	1	2	3	4	5	6	7	8	9	:	;
6	<	=	>	?	@	A	B	C	D	E	F	G	H	I	J	K	L	M	N	O
8	P	Q	R	S	T	U	V	W	X	Y	Z	[	\	]	^	-	·	a	b	c
10	d	e	f	g	h	i	j	k	l	m	n	o	p	q	r	s	t	u	v	w
12	x	y	z	{		}	~													
14																				
16	i	¢	£	/	¥	f	§	¤	’	“	«	<	>	fi	fl	°	-	†	‡	
18	·	μ	¶	•	’	”	»	»	»	»	»	»	»	»	»	»	»	»	»	»
20	..	È	·	·	·	·	·	·	·	·	·	·	·	·	·	·	·	·	·	·
22	Û	Ÿ	ß	à	Æ	â	ä	ä	ä	æ	ç	Ł	Ø	œ	·	·	·	·	·	·
24	ð	æ	ò	ó	ô	ı	ö	÷	ı	ø	œ	β	ü	ý	þ	ÿ	Á			

PostScript Times-Bold (pstb)

	0	1	2	3	4	5	6	7	8	9	10	11	12	13	14	15	16	17	18	19
0	p																			
2																				
4	(	)	*	+	,	-	·	/	0	1	2	3	4	5	6	7	8	9	:	;
6	<	=	>	?	@	A	B	C	D	E	F	G	H	I	J	K	L	M	N	O
8	P	Q	R	S	T	U	V	W	X	Y	Z	[	\	]	^	-	·	a	b	c
10	d	e	f	g	h	i	j	k	l	m	n	o	p	q	r	s	t	u	v	w
12	x	y	z	{		}	~													
14																				
16	i	¢	£	/	¥	f	§	¤	’	“	«	<	>	fi	fl	°	-	†	‡	
18	·	μ	¶	•	’	”	»	»	»	»	»	»	»	»	»	»	»	»	»	»
20	..	È	·	·	·	·	·	·	·	·	·	·	·	·	·	·	·	·	·	·
22	Û	Ÿ	ß	à	Æ	â	ä	ä	ä	æ	ç	Ł	Ø	œ	·	·	·	·	·	·
24	ð	æ	ò	ó	ô	ı	ö	÷	ı	ø	œ	β	ü	ý	þ	ÿ	Á			

PostScript Times-Italic (psti)

	0	1	2	3	4	5	6	7	8	9	10	11	12	13	14	15	16	17	18	19
0	p																			
2														!	"	#	\$	%	&	'
4	(	)	*	+	,	-	.	/	0	1	2	3	4	5	6	7	8	9	:	;
6	<	=	>	?	@	A	B	C	D	E	F	G	H	I	J	K	L	M	N	O
8	P	Q	R	S	T	U	V	W	X	Y	Z	[	\	]	^	-	`	a	b	c
10	d	e	f	g	h	i	j	k	l	m	n	o	p	q	r	s	t	u	v	w
12	x	y	z	{		}	~													
14																				
16	i	¢	£	/	¥	f	§	¤	'	"	«	<	>	fi	fl	°	-	†	‡	
18	·	µ	¶	•	,	"	"	»	...	‰	¼	½	¾	À	-	^	~	-	˘	·
20	..	È	·	˘	˙	˚	¸	˜	—	N	Ó	Ô	Õ	Ö	×	Ø	Ù	Ú	Û	
22	Ü	Ý	Þ	ß	à		â													
24																				¡

PostScript Times-BoldItalic (pstbi)

	0	1	2	3	4	5	6	7	8	9	10	11	12	13	14	15	16	17	18	19
0	p																			
2														!	"	#	\$	%	&	'
4	(	)	*	+	,	-	.	/	0	1	2	3	4	5	6	7	8	9	:	;
6	<	=	>	?	@	A	B	C	D	E	F	G	H	I	J	K	L	M	N	O
8	P	Q	R	S	T	U	V	W	X	Y	Z	[	\	]	^	-	`	a	b	c
10	d	e	f	g	h	i	j	k	l	m	n	o	p	q	r	s	t	u	v	w
12	x	y	z	{		}	~													
14																				
16	i	¢	£	/	¥	f	§	¤	'	"	«	<	>	fi	fl	°	-	†	‡	
18	·	µ	¶	•	,	"	"	»	...	‰	¼	½	¾	À	-	^	~	-	˘	·
20	..	È	·	˘	˙	˚	¸	˜	—	N	Ó	Ô	Õ	Ö	×	Ø	Ù	Ú	Û	
22	Ü	Ý	Þ	ß	à		â													
24																				¡

PostScript Courier (psc)

	0	1	2	3	4	5	6	7	8	9	10	11	12	13	14	15	16	17	18	19
0	p																			
2														!	"	#	\$	%	&	'
4	(	)	*	+	,	-	.	/	0	1	2	3	4	5	6	7	8	9	:	;
6	<	=	>	?	@	A	B	C	D	E	F	G	H	I	J	K	L	M	N	O
8	P	Q	R	S	T	U	V	W	X	Y	Z	[	\	]	^	-	`	a	b	c
10	d	e	f	g	h	i	j	k	l	m	n	o	p	q	r	s	t	u	v	w
12	x	y	z	{		}	~													
14																				
16	i	¢	£	/	¥	f	§	¤	'	"	«	<	>	fi	fl	°	-	†	‡	
18	·	µ	¶	•	,	"	"	»	...	‰	¼	½	¾	À	-	^	~	-	˘	·
20	..	È	·	˘	˙	˚	¸	˜	—	N	Ó	Ô	Õ	Ö	×	Ø	Ù	Ú	Û	
22	Ü	Ý	Þ	ß	à		â													
24																				¡

PostScript Courier-Bold (pscb)

	0	1	2	3	4	5	6	7	8	9	10	11	12	13	14	15	16	17	18	19
0	p																			
2														!	"	#	\$	%	&	'
4	(	)	*	+	,	-	.	/	0	1	2	3	4	5	6	7	8	9	:	;
6	<	=	>	?	@	A	B	C	D	E	F	G	H	I	J	K	L	M	N	O
8	P	Q	R	S	T	U	V	W	X	Y	Z	[	\	]	^	-	`	a	b	c
10	d	e	f	g	h	i	j	k	l	m	n	o	p	q	r	s	t	u	v	w
12	x	y	z	{		}	~													
14																				
16	i	¢	£	/	¥	f	§	¤	'	"	«	<	>	fi	fl	°	-	†	‡	
18	·	µ	¶	•	,	"	"	»	...	‰	¼	½	¾	À	-	^	~	-	˘	·
20	..	È	·	˘	˙	˚	¸	˜	—	N	Ó	Ô	Õ	Ö	×	Ø	Ù	Ú	Û	
22	Ü	Ý	Þ	ß	à		â													
24																				¡

PostScript Courier-Oblique (psco)

	0	1	2	3	4	5	6	7	8	9	10	11	12	13	14	15	16	17	18	19
0	p																			
2														!	"	#	\$	%	&	'
4	(	)	*	+	,	-	.	/	0	1	2	3	4	5	6	7	8	9	:	;
6	<	=	>	?	@	A	B	C	D	E	F	G	H	I	J	K	L	M	N	O
8	P	Q	R	S	T	U	V	W	X	Y	Z	[	\	]	^	-	`	a	b	c
10	d	e	f	g	h	i	j	k	l	m	n	o	p	q	r	s	t	u	v	w
12	x	y	z	{		}	~													
14																				
16	i	¢	£	/	¥	f	§	¤	'	"	«	<	>	fi	fl	°	-	†	‡	
18	·	µ	¶	•	,	"	"	»	...	‰	¼	½	¾	À	-	^	~	-	˘	·
20	..	È	·	˘	˙	˚	¸	˜	—	N	Ó	Ô	Õ	Ö	×	Ø	Ù	Ú	Û	
22	Ü	Ý	Þ	ß	à		â													
24																				¡

PostScript Courier-BoldOblique (pscbo)

	0	1	2	3	4	5	6	7	8	9	10	11	12	13	14	15	16	17	18	19
0	p																			
2														!	"	#	\$	%	&	'
4	(	)	*	+	,	-	.	/	0	1	2	3	4	5	6	7	8	9	:	;
6	<	=	>	?	@	A	B	C	D	E	F	G	H	I	J	K	L	M	N	O
8	P	Q	R	S	T	U	V	W	X	Y	Z	[	\	]	^	-	`	a	b	c
10	d	e	f	g	h	i	j	k	l	m	n	o	p	q	r	s	t	u	v	w
12	x	y	z	{		}	~													
14																				
16	i	¢	£	/	¥	f	§	¤	'	"	«	<	>	fi	fl	°	-	†	‡	
18	·	µ	¶	•	,	"	"	»	...	‰	¼	½	¾	À	-	^	~	-	˘	·
20	..	È	·	˘	˙	˚	¸	˜	—	N	Ó	Ô	Õ	Ö	×	Ø	Ù	Ú	Û	
22	Ü	Ý	Þ	ß	à		â													
24																				¡



















PostScript ZapfChancery-MediumItalic (pszcmi)

	0	1	2	3	4	5	6	7	8	9	10	11	12	13	14	15	16	17	18	19
0																				
2													!	,	#	\$	%	€	,	
4	(	)	*	+	'	-	·	/	0	1	2	3	4	5	6	7	8	9	:	;
6	<	=	>	?	@	À	Á	Â	Ã	Ä	Å	Æ	Ç	È	É	Ê	Ë	Ì	Í	Î
8	Ð	Ñ	Ò	Ó	Ô	Õ	Ö	×	Ý	Þ	ß	à	á	â	ã	ä	å	æ	ç	è
10	é	ê	ë	ì	í	î	ï	ê	ë	ì	í	î	ï	ê	ë	ì	í	î	ï	ê
12	ø	ÿ	z	{		}	~													
14																				
16	ı	ı	ı	ı	ı	ı	ı	ı	ı	ı	ı	ı	ı	ı	ı	ı	ı	ı	ı	ı
18	·	•	•	•	•	•	•	•	•	•	•	•	•	•	•	•	•	•	•	•
20	-	°	'	ˆ	˙	˚	—													
22				Æ	š							£	Ø	œ	ε					
24	æ			ı			ł	ø	æ	ß							Ä			

## A.7 Predefined Colors

GLE supports these SVG/X11 standard colors (sorted by color)

	indianred		mediumpurple		darkturquoise		azure
	lightcoral		blueviolet		cadetblue		aliceblue
	salmon		darkviolet		steelblue		ghostwhite
	darksalmon		darkorchid		lightsteelblue		whitesmoke
	lightsalmon		darkmagenta		powderblue		seashell
	crimson		purple		lightblue		beige
	red		indigo		skyblue		oldlace
	firebrick		slateblue		lightskyblue		floralwhite
	darkred		darkslateblue		deepskyblue		ivory
	pink		greenyellow		dodgerblue		antiquewhite
	lightpink		chartreuse		cornflowerblue		linen
	hotpink		lawngreen		mediumslateblue		lavenderblush
	deeppink		lime		royalblue		mistyrose
	mediumvioletred		limegreen		blue		gainsboro
	palevioletred		palegreen		mediumblue		lightgray
	coral		lightgreen		darkblue		silver
	tomato		mediumspringgreen		navy		darkgray
	orangered		springgreen		midnightblue		gray
	darkorange		mediumseagreen		cornsilk		dimgray
	orange		seagreen		blanchedalmond		lightslategray
	gold		forestgreen		bisque		slategray
	yellow		green		navajowhite		darkslategray
	lightyellow		darkgreen		wheat		black
	lemonchiffon		yellowgreen		burlywood		gray1
	lightgoldenrodyellow		olivedrab		tan		gray5
	papayawhip		olive		rosybrown		gray10
	moccasin		darkolivegreen		sandybrown		gray20
	peachpuff		mediumaquamarine		goldenrod		gray30
	palegoldenrod		darkseagreen		darkgoldenrod		gray40
	khaki		lightseagreen		peru		gray50
	darkkhaki		darkcyan		chocolate		gray60
	lavender		teal		saddlebrown		gray70
	thistle		aqua		sienna		gray80
	plum		cyan		brown		gray90
	violet		lightcyan		maroon		
	orchid		paleturquoise		white		
	fuchsia		aquamarine		snow		
	magenta		turquoise		honeydew		
	mediumorchid		mediumturquoise		mintcream		

GLE supports these SVG/X11 standard colors (alphabetical order)

 aliceblue	 deepskyblue	 linen	 salmon
 antiquewhite	 dimgray	 magenta	 sandybrown
 aqua	 dodgerblue	 maroon	 seagreen
 aquamarine	 firebrick	 mediumaquamarine	 seashell
 azure	 floralwhite	 mediumblue	 sienna
 beige	 forestgreen	 mediumorchid	 silver
 bisque	 fuchsia	 mediumpurple	 skyblue
 black	 gainsboro	 mediumseagreen	 slateblue
 blanchedalmond	 ghostwhite	 mediumslateblue	 slategray
 blue	 gold	 mediumspringgreen	 snow
 blueviolet	 goldenrod	 mediumturquoise	 springgreen
 brown	 gray	 mediumvioletred	 steelblue
 burlywood	 green	 midnightblue	 tan
 cadetblue	 greenyellow	 mintcream	 teal
 chartreuse	 honeydew	 mistyrose	 thistle
 chocolate	 hotpink	 moccasin	 tomato
 coral	 indianred	 navajowhite	 turquoise
 cornflowerblue	 indigo	 navy	 violet
 cornsilk	 ivory	 oldlace	 wheat
 crimson	 khaki	 olive	 white
 cyan	 lavender	 olivedrab	 whitesmoke
 darkblue	 lavenderblush	 orange	 yellow
 darkcyan	 lawngreen	 orangered	 yellowgreen
 darkgoldenrod	 lemonchiffon	 orchid	 gray1
 darkgray	 lightblue	 palegoldenrod	 gray5
 darkgreen	 lightcoral	 palegreen	 gray10
 darkkhaki	 lightcyan	 paleturquoise	 gray20
 darkmagenta	 lightgoldenrodyellow	 palevioletred	 gray30
 darkolivegreen	 lightgray	 papayawhip	 gray40
 darkorange	 lightgreen	 peachpuff	 gray50
 darkorchid	 lightpink	 peru	 gray60
 darkred	 lightsalmon	 pink	 gray70
 darksalmon	 lightseagreen	 plum	 gray80
 darkseagreen	 lightskyblue	 powderblue	 gray90
 darkslateblue	 lightslategray	 purple	
 darkslategray	 lightsteelblue	 red	
 darkturquoise	 lightyellow	 rosybrown	
 darkviolet	 lime	 royalblue	
 deeppink	 limegreen	 saddlebrown	

# A.8 Wall Reference

## GLE Wall Reference

_____	0	_____	5
_____	1	_____	6
.....	2	_____	7
_____	3	_____	8
.....	4	_____	9
--- --	9229		

	lwidth 0.2
	lwidth 0.1
	lwidth 0.05
	lwidth 0.02
	lwidth 0.01
	lwidth 0.0001
	lwidth 0

	circle		dag
	triangle		ddag
	square		asterisk
	diamond		oplus
	fcircle		ominus
	ftriangle		otimes
	fsquare		odot
	fdiamond		trianglez
	dot		diamondz
	cross		wcircle
	club		wtriangle
	heart		wsquare
	star		wdiamond
	snake		

rm	Roman
rmi	<i>Roman Italic</i>
rmb	<b>Roman Bold</b>
rmbi	<b><i>Roman Bold Italic</i></b>
tt	Typewriter
ttb	<b>Typewriter Bold</b>
ss	Sans Serif
ssb	<b>Sans Serif Bold</b>
ssi	<i>Sans Serif Italic</i>
psc	PostScript Courier
psh	PostScript Helvetica
psbl	PostScript Bookman
psncsr	PostScript New Century Schlbk Roman
pszcmi	<i>PostScript ZapfChancery-Medium Italic</i>
pszd	
pltr	Plotter Triplex Roman
pldr	Plotter Duplex Roman
plsr	Plotter Simplex Roman
plge	<b>Plotter Gothic English</b>
plci	<i>Plotter Complex Italic</i>
plss	<i>Plotter Simplex Script</i>

The GRID and SHADE patterns should only be used for filling on PostScript printers, the gray levels and colors will work for both filling and color settings on any device.

	Grid5		Gray80
	Grid4		Gray60
	Grid3		Gray40
	Grid2		Gray20
	Grid1		White
	Grid		Black
	Shade5		Yellow
	Shade4		Magenta
	Shade3		Blue
	Shade2		Green
	Shade1		Red
	Shade		

# Index

- !, 8, 25
- `\expr(exp)`, 80
- .z file, 67
- ?, 25
- @, 8
- L<sup>A</sup>T<sub>E</sub>X, 11, 82
  - macros, 82
- L<sup>A</sup>T<sub>E</sub>X expression, 58
- 3d bar
  - notop, 38
  - offset, 38
  - side, 38
  - top, 38
  
- abound, 8
- `abs()`, 79
- `acos()`, 79
- `acosh()`, 79
- `acot()`, 79
- `acoth()`, 79
- `acsc()`, 79
- `acsch()`, 79
- add, 9
- `alabeldist`, 17, 34
- `alabelscale`, 17, 34
- `aline`, 9
- `aline (closepath)`, 12
- `amove`, 9
- `amove (origin)`, 10
- angle, 10
- arc, 9
- `arcto`, 9
- `arg()`, 47, 79
- `arg$()`, 47
- arrow, 9, 17
- `arrowangle`, 17
- `arrowsize`, 17
- `arrowstyle`, 18
- `asec()`, 79
- `asech()`, 79
- `asin()`, 79
- `asinh()`, 79
- `atan()`, 79
- `atanh()`, 79
- `atitledist`, 18, 36
- `atitlescale`, 18, 36
- `atn()`, 79
  
- back, 66
- bar
  - color, 37
  - dist, 37
  - fill, 37
  - from, 37
  - width, 37
- bar graphs, 36
- bar graphs 3d, 38
- base, 66
- `baselineskip`, 11
- `begin`
  - box, 9
  - clip, 10
  - name, 10
  - object, 10
  - origin, 10
  - path, 10
  - rotate, 10
  - scale, 10
  - table, 10
  - text, 11
  - text (single line), 21
  - translate, 11
- bevel, 20
- bezier, 12
- bezier (rbezier), 17
- Bezier curve, 9
- bitmap, 12
- `bitmap_info`, 12
- BLANK, 75
- border, 31
- box, 12
  
- cap, 18
- center, 24
- char, 11
- character size, 20
- `chardef`, 11
- circle, 12
- clear, 74
- clip, 10, 60
- clipping, 60
- `closepath`, 12
- color, 18
- color (graph lines), 26
- color (title), 32
- color (variables), 61
- color-variables, 61
- `colormap`, 68
  - command, 12
  - graph block, 24

- commands, 72
- comment, 8, 25
- contour, 67
- copy, 73
- cos(), 79
- cosh(), 79
- cot(), 79
- coth(), 79
- csc(), 79
- csch(), 80
- curve, 9, 12
- cvtrgb(), 61
  
- dashlen, 19
- data, 5, 24, 64, 68, 74
- data (example file), 24
- data (order), 39
- dataxvalue, 48, 80
- datayvalue, 48, 80
- date\$(), 80
- def, 11
- define marker, 12
- delete, 74
- deresolve, 26
- device control, 53
- device\$(), 80
- diagrams, 55
- dn, 26
  - color, 26
  - deresolve, 26
  - err, 26
  - errdown, 26
  - errup, 26
  - errwidth, 26
  - file, 28
  - herr, 26
  - herrleft, 26
  - herrright, 26
  - herrwidth, 26
  - key, 26
  - line, 26
  - lstyle, 26
  - lwidth, 26
  - marker, 27
  - msize, 27
  - nomiss, 27
  - smooth, 27
  - svg\_smooth, 28
  - xmax, 28
  - xmin, 28
  - ymax, 28
  - ymin, 28
- droplines, 66
- dsubticks, 33
- dticks, 33
  
- ellipse, 13
- elliptical\_arc, 13
- elliptical\_narc, 13
  
- else, 14, 51
- end if, 14
- end path, 10
- error bars (see dn err) , 26
- eval(), 47, 80
- example data file, 24
- exit, 74
- exp(), 80
- expressions, 47
  
- fclose, 52
- fgetline, 52
- file (dataset), 28
- file\$(), 80
- files, 5, 24
- fill, 19
  - color, 38
  - xmax, 38
  - xmin, 38
  - ymax, 38
  - ymin, 38
- fill patterns, 61
- filling, 61
- filling areas, 38
- fit, 74
- Fitls, 71
- fitz, 67
- fix(), 80
- font, 19
- font (line width), 19
- font (title), 32
- font-examples, 83
- fontlwidth, 19
- fonts, 83
- fopen, 52
- for, 13, 50
- format\$(), 48, 80
- fread, 52
- freadln, 52
- ftokenizer, 52
- fullsize, 28
- Functions, 77
- functions, 50, 79
- fwrite, 52
- fwriteln, 52
  
- generate, 77
- GLE\_USRLIB, 14
- goto, 74
- graphing, 23
- graphing functions, 28
- greek characters, 11
- grestore, 14
- grid, 33
- gsave, 14
  
- harray, 64
- hei, 20
- height(), 49, 80

- histogram, 30
- horiz, 37
- horizontal error bars, 26
- hscale, 28
  
- I/O-functions, 52
- if, 14, 51
- ignore, 25
- include, 14, 52
- insert, 75
- int(), 80
  
- join, 14, 20
- join (set join), 20
- joining, 55
- just, 20
- justify (box), 12
- justify (join), 14
- justify (set), 20
- justify (text), 11
  
- key, 26
  - data based, 25
  - hei, 28
  - nobox, 28
  - offset, 28
  - pos, 28
- key (module), 41
- key module
  - absolute, 42
  - boxcolor, 42
  - coldist, 42
  - color, 43
  - compact, 42
  - dist, 42
  - fill, 43
  - hei, 42
  - justify, 43
  - line, 43
  - llen, 43
  - lpos, 43
  - lstyle, 43
  - lwidth, 43
  - margins, 43
  - marker, 43
  - mscale, 43
  - msize, 43
  - nobox, 43
  - off, 43
  - offset, 43
  - pattern, 43
  - position, 43
  - row, 42
  - separator, 44
  - text, 44
  
- LaTeX packages, 59
- left\$(), 80
- len(), 80
  
- let, 28
  - hist, 30
  - nsteps, 30
  - range, 31
- let (order), 39
- line, 26
- line width (graphs), 39
- lineskip, 11
- linfit, 29
- load, 75
- local, 15, 52
- log, 33
- log(), 80
- log10(), 80
- log10fit, 29
- logfit, 29
- logging, 76
- loops, 50
- lstyle, 20
- lstyle (graph lines), 26
- lstyle (set), 20
- lwidth, 20
- lwidth (graph lines), 26
- lwidth (graphs), 39
  
- Manip, 72
  - Arrows, 73
  - Range, 72
  - usage, 72
- marker, 15, 27, 66
- markers, 79
- mathchar, 11
- mathchardef, 11
- mathcode, 11
- missing, 26
- missing value, 25
- mitre, 20
- move, 75
- movexy, 11
  
- name (box), 9, 12
- name (join), 14
- name (point), 17
- narc, 9
- nargs(), 47, 80
- ndata, 48, 80
- negate, 36
- new, 75
- next, 13, 50
- noborder, 31
- nobox, 9, 12, 31
- nofirst, 33
- nolast, 33
- nomiss, 27
- not(), 80
- nsteps, 30
- nsubticks, 33
- nticks, 33
- num1\$(), 80



- num\$(), 80
- orientation, 15
- pageheight(), 49, 80
- pagewidth(), 49, 80
- papersize, 15
- parsum, 77
- path, 10
- path\$(), 80
- paths, 60
- pattern, 20
  - bar, 37
- pi, 81
- points, 66
- pointx(), 80
- pointy(), 80
- pos(), 80
- postscript, 16
- powxfit, 29
- print, 16
- propagate, 76
- psbbtweak, 16
- pscomment, 16
- ptx(), 80
- pty(), 80
- quit, 77
- radius, 12
- range, 31
- rbezier, 17
- recover, 72
- return, 17, 52
- reverse, 17
- RGB, 61
- rgb(), 18, 80
- rgb255(), 18, 61, 80
- right, 66
- right\$(), 80
- riselines, 66
- rline, 17
- rmove, 17
- rnd(), 80
- rotate, 10, 65
- rotate (y2title), 36
- round, 20
- round (cap), 18
- round (join), 20
- save, 17, 74
- Savitsky Golay smoothing, 28
- scale, 10, 32
- scale (marker), 15
- sdvi(), 80
- sec(), 80
- sech(), 80
- seg\$(), 80
- set between, 75
- set coltype, 76
- set colwidth, 76
- set digits, 76
- set dpoints, 76
- set ncol, 76
- set size, 75
- set width, 76
- setfont, 11
- sethei, 11
- setstretch, 11
- sgn(), 80
- shell, 77
- sin(), 80
- single, 72
- sinh(), 80
- size, 31, 63
- size  $x y$ , 72
- skirt, 66
- smooth, 27, 68
- smoothm, 27
- sort, 75
- sqr(), 80
- sqrt(), 80
- step, 13, 72
- stroke, 10
- stroking, 60
- sub, 21
- subroutines, 51
- sum, 76
- Surface, 63
- svg\_smooth, 28
- swap, 75
- symbols, 82
- table, 10
- tan(), 80
- tanh(), 80
- tdepth(), 80
- TeX, 11
- tex, 21, 58
- texscale, 21
- text, 21
- text (begin), 11
- text (width), 11
- theight(), 49, 80
- then, 14, 51
- ticksscale, 21
- time\$(), 80
- title, 32, 65
  - color, 32
  - dist, 32
  - font, 32
  - hei, 32
- titlescale, 21, 32
- todeg(), 80
- top, 66
- torad(), 80
- translate, 11
- twidth(), 49, 80

- under, 32
- underneath, 66
- Unicode, 59
- until, 51
- UTF-8, 59
  
- val(), 80
- values, 68
- variables, 47, 50
- view, 65
- vscale, 32
  
- while, 51
- width(), 49, 81
- wmarker, 15
- write, 21
  
- x2axis (see xaxis), 33
- x2labels
  - on, 32
- x2side (see xside), 35
- xaxis, 33, 65
  - base, 33
  - color, 33
  - dsubticks, 33
  - dticks, 33
  - font, 33
  - grid, 33
  - hei, 33
  - log, 33
  - lwidth, 33
  - max, 33
  - min, 33
  - neagte, 36
  - nofirst, 33
  - nolast, 33
  - nsubticks, 33
  - nticks, 33
  - off, 34
  - shift, 34
- xbar(), 81
- xend(), 49, 81
- xg(), 50, 81
- xg2max, 81
- xg2min, 81
- xgmax, 81
- xgmin, 81
- xlabels, 34
  - color, 34
  - dist, 34
  - font, 34
  - hei, 34
  - log, 34
  - off, 34
  - on, 34
- xlines, 64
- xnames, 34
- xnoticks, 35
- xoffset, 38
- xplaces, 35
- xpos(), 50, 81
- xside, 35
  - color, 35
  - lwidth, 35
- xsubticks, 35
  - length, 35
  - lstyle, 35
  - lwidth, 35
  - off, 35
- xticks, 36
  - length, 36
  - lstyle, 36
  - lwidth, 36
  - off, 36
- xtitle, 36, 65
  - adist, 36
  - color, 36
  - dist, 36
  - font, 36
  - hei, 36
- xy2angle(), 81
  
- y2axis (see xaxis), 33
- y2side (see xside), 35
- y2title rotate, 36
- yaxis, 65
- yaxis (see xaxis), 33
- yend(), 49, 81
- yg(), 50, 81
- yg2max, 81
- yg2min, 81
- ygmax, 81
- ygmin, 81
- ylines, 65
- ynames (see xnames), 34
- yoffset, 38
- ypos(), 50, 81
- yside (see xside), 35
- yticks (see xticks), 36
- yttitle, 65
- yttitle (see xtitle), 36
  
- zaxis, 65
- zclip, 67
- ztitle, 65