

1. Ice Manual	17
1.1 Ice Overview	19
1.1.1 Ice Architecture	20
1.1.1.1 Terminology	21
1.1.1.2 Slice (Specification Language for Ice)	28
1.1.1.3 Language Mappings	29
1.1.1.4 Client and Server Structure	30
1.1.1.5 Overview of the Ice Protocol	32
1.1.2 Ice Services	33
1.1.3 Architectural Benefits of Ice	35
1.2 Hello World Application	37
1.2.1 Writing a Slice Definition	38
1.2.2 Writing an Ice Application with C++	39
1.2.3 Writing an Ice Application with Java	47
1.2.4 Writing an Ice Application with C-Sharp	54
1.2.5 Writing an Ice Application with Visual Basic	61
1.2.6 Writing an Ice Application with Objective-C	69
1.2.7 Writing an Ice Application with Python	77
1.2.8 Writing an Ice Application with Ruby	83
1.2.9 Writing an Ice Application with PHP	86
1.3 The Slice Language	89
1.3.1 Slice Compilation	90
1.3.2 Slice Source Files	93
1.3.3 Lexical Rules	96
1.3.4 Modules	98
1.3.5 Basic Types	100
1.3.6 User-Defined Types	102
1.3.6.1 Enumerations	103
1.3.6.2 Structures	105
1.3.6.3 Sequences	107
1.3.6.4 Dictionaries	109
1.3.6.5 Constants and Literals	111
1.3.7 Interfaces, Operations, and Exceptions	115
1.3.7.1 Operations	117
1.3.7.2 User Exceptions	122
1.3.7.3 Run-Time Exceptions	127
1.3.7.4 Proxies	131
1.3.7.5 Interface Inheritance	133
1.3.8 Classes	141
1.3.8.1 Simple Classes	142
1.3.8.2 Class Inheritance	144
1.3.8.3 Class Inheritance Semantics	146
1.3.8.4 Classes as Unions	148
1.3.8.5 Self-Referential Classes	149
1.3.8.6 Classes Versus Structures	152
1.3.8.7 Classes with Operations	153
1.3.8.8 Architectural Implications of Classes	155
1.3.8.9 Classes Implementing Interfaces	157
1.3.8.10 Class Inheritance Limitations	160
1.3.8.11 Pass-by-Value Versus Pass-by-Reference	161
1.3.8.12 Passing Interfaces by Value	163
1.3.8.13 Classes with Compact Type IDs	164
1.3.9 Forward Declarations	165
1.3.10 Optional Data Members	166
1.3.11 Type IDs	169
1.3.12 Operations on Object	170
1.3.13 Local Types	172
1.3.14 Names and Scoping	173
1.3.15 Metadata	180
1.3.16 Serializable Objects	181
1.3.17 Deprecating Slice Definitions	183

1.3.18 Using the Slice Compilers	184
1.3.19 Slice Checksums	186
1.3.20 Generating Slice Documentation	187
1.3.21 Slice Keywords	193
1.3.22 Slice Metadata Directives	194
1.3.23 Slice for a Simple File System	200
1.4 C++ Mapping	203
1.4.1 Client-Side Slice-to-C++ Mapping	204
1.4.1.1 C++ Mapping for Identifiers	205
1.4.1.2 C++ Mapping for Modules	206
1.4.1.3 C++ Mapping for Built-In Types	207
1.4.1.4 C++ Mapping for Enumerations	209
1.4.1.5 C++ Mapping for Structures	210
1.4.1.6 C++ Mapping for Sequences	214
1.4.1.7 C++ Mapping for Dictionaries	223
1.4.1.8 C++ Mapping for Constants	226
1.4.1.9 C++ Mapping for Exceptions	227
1.4.1.10 C++ Mapping for Interfaces	233
1.4.1.11 C++ Mapping for Operations	242
1.4.1.12 C++ Mapping for Classes	252
1.4.1.13 C++ Mapping for Optional Values	261
1.4.1.14 Smart Pointers for Classes	264
1.4.1.15 Asynchronous Method Invocation (AMI) in C++	277
1.4.1.16 slice2cpp Command-Line Options	294
1.4.1.17 Using Slice Checksums in C++	300
1.4.1.18 Example of a File System Client in C++	301
1.4.2 Server-Side Slice-to-C++ Mapping	306
1.4.2.1 The Server-Side main Function in C++	307
1.4.2.2 Server-Side C++ Mapping for Interfaces	320
1.4.2.3 Parameter Passing in C++	323
1.4.2.4 Raising Exceptions in C++	325
1.4.2.5 Object Incarnation in C++	326
1.4.2.6 Asynchronous Method Dispatch (AMD) in C++	331
1.4.2.7 Example of a File System Server in C++	337
1.4.3 The C++ Utility Library	356
1.4.3.1 The C++ AbstractMutex Class	357
1.4.3.2 The C++ Cache Template	360
1.4.3.3 The C++ Exception Class	363
1.4.3.4 The C++ generateUUID Function	364
1.4.3.5 The C++ Handle Template	365
1.4.3.6 The C++ Handle Template Adaptors	369
1.4.3.7 The C++ ScopedArray Template	375
1.4.3.8 The C++ Shared and SimpleShared Classes	378
1.4.3.9 The C++ Time Class	379
1.4.3.10 The C++ Timer and TimerTask Classes	383
1.4.3.11 Unicode and UTF-8 Conversion Functions in C++	385
1.4.3.12 Version Information in C++	386
1.4.4 Windows Store Applications	387
1.5 Java Mapping	389
1.5.1 Client-Side Slice-to-Java Mapping	390
1.5.1.1 Java Mapping for Identifiers	391
1.5.1.2 Java Mapping for Modules	392
1.5.1.3 Java Mapping for Built-In Types	393
1.5.1.4 Java Mapping for Enumerations	394
1.5.1.5 Java Mapping for Structures	396
1.5.1.6 Java Mapping for Sequences	399
1.5.1.7 Java Mapping for Dictionaries	400
1.5.1.8 Java Mapping for Constants	401
1.5.1.9 Java Mapping for Exceptions	403
1.5.1.10 Java Mapping for Interfaces	407
1.5.1.11 Java Mapping for Operations	417

1.5.1.12	Java Mapping for Classes	427
1.5.1.13	Java Mapping for Optional Data Members	436
1.5.1.14	Serializable Objects in Java	439
1.5.1.15	Customizing the Java Mapping	441
1.5.1.16	Asynchronous Method Invocation (AMI) in Java	451
1.5.1.17	Using the Slice Compiler for Java	464
1.5.1.18	Using Slice Checksums in Java	468
1.5.1.19	Example of a File System Client in Java	469
1.5.2	Server-Side Slice-to-Java Mapping	474
1.5.2.1	The Server-Side main Method in Java	475
1.5.2.2	Server-Side Java Mapping for Interfaces	482
1.5.2.3	Parameter Passing in Java	485
1.5.2.4	Raising Exceptions in Java	488
1.5.2.5	Tie Classes in Java	489
1.5.2.6	Object Incarnation in Java	494
1.5.2.7	Asynchronous Method Dispatch (AMD) in Java	498
1.5.2.8	Example of a File System Server in Java	503
1.5.3	The Java Utility Library	513
1.6	C-Sharp Mapping	517
1.6.1	Client-Side Slice-to-C-Sharp Mapping	518
1.6.1.1	C-Sharp Mapping for Identifiers	519
1.6.1.2	C-Sharp Mapping for Modules	520
1.6.1.3	C-Sharp Mapping for Built-In Types	522
1.6.1.4	C-Sharp Mapping for Enumerations	523
1.6.1.5	C-Sharp Mapping for Structures	524
1.6.1.6	C-Sharp Mapping for Sequences	530
1.6.1.7	C-Sharp Mapping for Dictionaries	537
1.6.1.8	C-Sharp Collection Comparison	542
1.6.1.9	C-Sharp Mapping for Constants	543
1.6.1.10	C-Sharp Mapping for Exceptions	546
1.6.1.11	C-Sharp Mapping for Interfaces	551
1.6.1.12	C-Sharp Mapping for Operations	559
1.6.1.13	C-Sharp Mapping for Classes	568
1.6.1.14	C-Sharp Mapping for Optional Values	579
1.6.1.15	Serializable Objects in C-Sharp	581
1.6.1.16	C-Sharp Specific Metadata Directives	583
1.6.1.17	Asynchronous Method Invocation (AMI) in C-Sharp	584
1.6.1.18	slice2cs Command-Line Options	598
1.6.1.19	Using Slice Checksums in C-Sharp	599
1.6.1.20	Example of a File System Client in C-Sharp	600
1.6.2	Server-Side Slice-to-C-Sharp Mapping	605
1.6.2.1	The Server-Side main Method in C-Sharp	606
1.6.2.2	Server-Side C-Sharp Mapping for Interfaces	612
1.6.2.3	Parameter Passing in C-Sharp	616
1.6.2.4	Raising Exceptions in C-Sharp	618
1.6.2.5	Tie Classes in C-Sharp	619
1.6.2.6	Object Incarnation in C-Sharp	623
1.6.2.7	Asynchronous Method Dispatch (AMD) in C-Sharp	627
1.6.2.8	Example of a File System Server in C-Sharp	632
1.6.3	Silverlight and .NET Compact Framework Support	642
1.6.4	The .NET Utility Library	644
1.6.5	Silverlight Security Policies	646
1.7	Objective-C Mapping	648
1.7.1	Client-Side Slice-to-Objective-C Mapping	649
1.7.1.1	Objective-C Mapping for Modules	650
1.7.1.2	Objective-C Mapping for Identifiers	652
1.7.1.3	Objective-C Mapping for Built-In Types	654
1.7.1.4	Objective-C Mapping for Enumerations	655
1.7.1.5	Objective-C Mapping for Structures	656
1.7.1.6	Objective-C Mapping for Sequences	660
1.7.1.7	Objective-C Mapping for Dictionaries	664

1.7.1.8 Objective-C Mapping for Constants	666
1.7.1.9 Objective-C Mapping for Exceptions	667
1.7.1.10 Objective-C Mapping for Interfaces	675
1.7.1.11 Objective-C Mapping for Operations	680
1.7.1.12 Objective-C Mapping for Local Interfaces	693
1.7.1.13 Objective-C Mapping for Classes	694
1.7.1.14 Objective-C Mapping for Interfaces by Value	704
1.7.1.15 Objective-C Mapping for Optional Data Members	705
1.7.1.16 Asynchronous Method Invocation (AMI) in Objective-C	706
1.7.1.17 slice2objc Command-Line Options	715
1.7.1.18 Example of a File System Client in Objective-C	716
1.7.2 Server-Side Slice-to-Objective-C Mapping	721
1.7.2.1 The Server-Side main Function in Objective-C	722
1.7.2.2 Server-Side Objective-C Mapping for Interfaces	725
1.7.2.3 Parameter Passing in Objective-C	729
1.7.2.4 Raising Exceptions in Objective-C	731
1.7.2.5 Object Incarnation in Objective-C	732
1.7.2.6 Example of a File System Server in Objective-C	736
1.8 Python Mapping	751
1.8.1 Client-Side Slice-to-Python Mapping	752
1.8.1.1 Python Mapping for Identifiers	753
1.8.1.2 Python Mapping for Modules	754
1.8.1.3 Python Mapping for Built-In Types	755
1.8.1.4 Python Mapping for Enumerations	756
1.8.1.5 Python Mapping for Structures	758
1.8.1.6 Python Mapping for Sequences	760
1.8.1.7 Python Mapping for Dictionaries	763
1.8.1.8 Python Mapping for Constants	764
1.8.1.9 Python Mapping for Exceptions	765
1.8.1.10 Python Mapping for Interfaces	769
1.8.1.11 Python Mapping for Operations	775
1.8.1.12 Python Mapping for Classes	782
1.8.1.13 Asynchronous Method Invocation (AMI) in Python	789
1.8.1.14 Code Generation in Python	798
1.8.1.15 Using Slice Checksums in Python	808
1.8.1.16 Example of a File System Client in Python	809
1.8.2 Server-Side Slice-to-Python Mapping	814
1.8.2.1 The Server-Side main Program in Python	815
1.8.2.2 Server-Side Python Mapping for Interfaces	822
1.8.2.3 Parameter Passing in Python	825
1.8.2.4 Raising Exceptions in Python	827
1.8.2.5 Object Incarnation in Python	828
1.8.2.6 Asynchronous Method Dispatch (AMD) in Python	832
1.8.2.7 Example of a File System Server in Python	836
1.9 Ruby Mapping	846
1.9.1 Client-Side Slice-to-Ruby Mapping	847
1.9.1.1 Ruby Mapping for Identifiers	848
1.9.1.2 Ruby Mapping for Modules	849
1.9.1.3 Ruby Mapping for Built-In Types	850
1.9.1.4 Ruby Mapping for Enumerations	851
1.9.1.5 Ruby Mapping for Structures	854
1.9.1.6 Ruby Mapping for Sequences	856
1.9.1.7 Ruby Mapping for Dictionaries	858
1.9.1.8 Ruby Mapping for Constants	859
1.9.1.9 Ruby Mapping for Exceptions	860
1.9.1.10 Ruby Mapping for Interfaces	864
1.9.1.11 Ruby Mapping for Operations	870
1.9.1.12 Ruby Mapping for Classes	876
1.9.1.13 Code Generation in Ruby	885
1.9.1.14 The main Program in Ruby	891
1.9.1.15 Using Slice Checksums in Ruby	896

1.9.1.16 Example of a File System Client in Ruby	897
1.10 PHP Mapping	902
1.10.1 Client-Side Slice-to-PHP Mapping	903
1.10.1.1 PHP Mapping for Identifiers	904
1.10.1.2 PHP Mapping for Modules	905
1.10.1.3 PHP Mapping for Built-In Types	906
1.10.1.4 PHP Mapping for Enumerations	907
1.10.1.5 PHP Mapping for Structures	909
1.10.1.6 PHP Mapping for Sequences	910
1.10.1.7 PHP Mapping for Dictionaries	911
1.10.1.8 PHP Mapping for Constants	912
1.10.1.9 PHP Mapping for Exceptions	914
1.10.1.10 PHP Mapping for Interfaces	918
1.10.1.11 PHP Mapping for Operations	925
1.10.1.12 PHP Mapping for Classes	931
1.10.1.13 slice2php Command-Line Options	939
1.10.1.14 Application Notes for PHP	940
1.10.1.15 Using Slice Checksums in PHP	947
1.10.1.16 Example of a File System Client in PHP	948
1.11 Properties and Configuration	953
1.11.1 Properties Overview	954
1.11.2 Configuration File Syntax	956
1.11.3 Setting Properties on the Command Line	958
1.11.4 Using Configuration Files	959
1.11.5 Alternate Property Stores	962
1.11.6 Command-Line Parsing and Initialization	963
1.11.7 The Properties Interface	966
1.11.8 Reading Properties	968
1.11.9 Setting Properties	970
1.11.10 Parsing Properties	975
1.12 Threads and Concurrency with C++	980
1.12.1 The C++ Mutex Class	981
1.12.2 The C++ RecMutex Class	989
1.12.3 The C++ Monitor Class	992
1.12.4 The C++ Cond Class	1000
1.12.5 The C++ Thread Classes	1003
1.12.6 Priority Inversion in C++	1012
1.12.7 Portable Signal Handling in C++	1013
1.13 The Ice Run Time in Detail	1014
1.13.1 Communicators	1015
1.13.2 Communicator Initialization	1019
1.13.3 Object Adapters	1021
1.13.3.1 The Active Servant Map	1022
1.13.3.2 Creating an Object Adapter	1024
1.13.3.3 Servant Activation and Deactivation	1025
1.13.3.4 Object Adapter States	1027
1.13.3.5 Object Adapter Endpoints	1030
1.13.3.6 Creating Proxies with an Object Adapter	1034
1.13.3.7 Using Multiple Object Adapters	1036
1.13.4 Object Identity	1037
1.13.5 The Current Object	1040
1.13.6 Servant Locators	1042
1.13.6.1 The ServantLocator Interface	1043
1.13.6.2 Threading Guarantees for Servant Locators	1046
1.13.6.3 Registering a Servant Locator	1047
1.13.6.4 Servant Locator Example	1049
1.13.6.5 Using Identity Categories with Servant Locators	1053
1.13.6.6 Using Cookies with Servant Locators	1057
1.13.7 Default Servants	1059
1.13.8 Server Implementation Techniques	1063
1.13.9 Servant Evictors	1070

1.13.9.1 Implementing a Servant Evictor in C++	1072
1.13.9.2 Implementing a Servant Evictor in Java	1080
1.13.9.3 Implementing a Servant Evictor in C-Sharp	1088
1.13.10 The Ice Threading Model	1098
1.13.10.1 Thread Pools	1099
1.13.10.2 Object Adapter Thread Pools	1102
1.13.10.3 Thread Pool Design Considerations	1103
1.13.10.4 Nested Invocations	1105
1.13.10.5 Thread Safety	1107
1.13.10.6 Dispatching Invocations to User Threads	1113
1.13.11 Using Proxies	1129
1.13.11.1 Obtaining Proxies	1130
1.13.11.2 Proxy Methods	1133
1.13.11.3 Proxy Endpoints	1139
1.13.11.4 Filtering Proxy Endpoints	1140
1.13.11.5 Proxy Defaults and Overrides	1141
1.13.11.6 Proxy and Endpoint Syntax	1143
1.13.12 Request Contexts	1150
1.13.12.1 Explicit Request Contexts	1151
1.13.12.2 Per-Proxy Request Contexts	1153
1.13.12.3 Implicit Request Contexts	1154
1.13.12.4 Design Considerations for Request Contexts	1156
1.13.13 Connection Timeouts	1158
1.13.14 Oneway Invocations	1160
1.13.15 Datagram Invocations	1164
1.13.16 Batched Invocations	1166
1.13.17 Locators	1168
1.13.17.1 Locator Semantics for Clients	1169
1.13.17.2 Locator Configuration for a Client	1173
1.13.17.3 Locator Semantics for Servers	1174
1.13.17.4 Locator Configuration for a Server	1175
1.13.18 Administrative Facility	1177
1.13.18.1 The admin Object	1178
1.13.18.2 The Administrative Object Adapter	1179
1.13.18.3 Using the admin Object	1180
1.13.18.4 The Process Facet	1182
1.13.18.5 The Properties Facet	1185
1.13.18.6 The Metrics Facet	1189
1.13.18.7 Filtering Administrative Facets	1194
1.13.18.8 Custom Administrative Facets	1195
1.13.18.9 Security Considerations for Administrative Facets	1196
1.13.19 Instrumentation Facility	1198
1.13.20 Logger Facility	1203
1.13.20.1 The Default Logger	1204
1.13.20.2 Custom Loggers	1205
1.13.20.3 Built-in Loggers	1206
1.13.20.4 Logger Plug-ins	1207
1.13.20.5 The Per-Process Logger	1212
1.13.20.6 C++ Logger Utility Classes	1213
1.13.21 Location Transparency	1215
1.13.22 Automatic Retries	1217
1.13.23 Dispatch Interceptors	1222
1.13.24 C++ Strings and Character Encoding	1227
1.13.24.1 Installing String Converters	1228
1.13.24.2 UTF-8 Conversion	1229
1.13.24.3 String Parameters in Local Calls	1230
1.13.24.4 Built-in String Converters	1231
1.13.24.5 String Conversion Convenience Functions	1232
1.13.24.6 The iconv String Converter	1233
1.13.24.7 The Ice String Converter Plug-in	1234
1.13.24.8 Custom String Converter Plug-ins	1235

1.13.25 Plug-in Facility	1236
1.13.25.1 Plug-in API	1237
1.13.25.2 Plug-in Configuration	1240
1.13.25.3 Advanced Plug-in Topics	1241
1.13.26 Custom Class Loaders	1244
1.13.27 Understanding Objects and Exceptions	1245
1.13.28 Optional Values	1257
1.14 Facets and Versioning	1264
1.14.1 Facet Concepts	1265
1.14.2 The Versioning Problem	1273
1.14.3 Versioning with Facets	1278
1.15 Object Life Cycle	1284
1.15.1 Understanding Object Life Cycle	1285
1.15.2 Object Existence and Non-Existence	1286
1.15.3 Life Cycle of Proxies, Servants, and Ice Objects	1290
1.15.4 Object Creation	1292
1.15.5 Object Destruction	1296
1.15.5.1 Idempotency and Life Cycle Operations	1298
1.15.5.2 Implementing a destroy Operation	1299
1.15.5.3 Cleaning Up a Destroyed Servant	1301
1.15.5.4 Life Cycle and Collection Operations	1303
1.15.5.5 Life Cycle and Normal Operations	1308
1.15.6 Removing Cyclic Dependencies	1314
1.15.6.1 Acquiring Locks without Deadlocks	1316
1.15.6.2 Reaping Objects	1317
1.15.7 Object Identity and Uniqueness	1322
1.15.8 Object Life Cycle for the File System Application	1324
1.15.8.1 Implementing Object Life Cycle in C++	1326
1.15.8.2 Implementing Object Life Cycle in Java	1336
1.15.9 Avoiding Server-Side Garbage	1346
1.16 Dynamic Ice	1353
1.16.1 Streaming Interfaces	1354
1.16.1.1 C++ Streaming Interfaces	1355
1.16.1.1.1 The InputStream Interface in C++	1356
1.16.1.1.2 The OutputStream Interface in C++	1365
1.16.1.1.3 Intercepting Object Insertion and Extraction in C++	1371
1.16.1.1.4 Intercepting User Exception Insertion and Extraction in C++	1373
1.16.1.2 Java Streaming Interfaces	1376
1.16.1.2.1 The InputStream Interface in Java	1377
1.16.1.2.2 The OutputStream Interface in Java	1383
1.16.1.2.3 Stream Helper Functions in Java	1388
1.16.1.2.4 Intercepting Object Insertion and Extraction in Java	1391
1.16.1.2.5 Intercepting User Exception Insertion and Extraction in Java	1393
1.16.1.3 C-Sharp Streaming Interfaces	1395
1.16.1.3.1 The InputStream Interface in C-Sharp	1396
1.16.1.3.2 The OutputStream Interface in C-Sharp	1402
1.16.1.3.3 Stream Helper Functions in C-Sharp	1407
1.16.1.3.4 Intercepting Object Insertion and Extraction in C-Sharp	1410
1.16.1.3.5 Intercepting User Exception Insertion and Extraction in C-Sharp	1412
1.16.2 Dynamic Invocation and Dispatch	1414
1.16.2.1 Dynamic Invocation and Dispatch Overview	1415
1.16.2.2 Dynamic Invocation and Dispatch in C++	1418
1.16.2.3 Dynamic Invocation and Dispatch in Java	1424
1.16.2.4 Dynamic Invocation and Dispatch in C-Sharp	1430
1.16.3 Asynchronous Dynamic Invocation and Dispatch	1436
1.16.3.1 Asynchronous Dynamic Invocation and Dispatch in C++	1437
1.16.3.2 Asynchronous Dynamic Invocation and Dispatch in Java	1443
1.16.3.3 Asynchronous Dynamic Invocation and Dispatch in C-Sharp	1447
1.17 Connection Management	1450
1.17.1 Connection Establishment	1451
1.17.2 Active Connection Management	1455

1.17.3 Using Connections	1457
1.17.4 Connection Closure	1464
1.17.5 Bidirectional Connections	1465
1.18 The Ice Protocol	1469
1.18.1 Data Encoding	1470
1.18.1.1 Basic Data Encoding	1471
1.18.1.2 Data Encoding for Exceptions	1476
1.18.1.3 Data Encoding for Classes	1481
1.18.1.3.1 Data Encoding for Class Type IDs	1485
1.18.1.3.2 Simple Example of Class Encoding	1487
1.18.1.3.3 Data Encoding for Class Graphs	1494
1.18.1.4 Data Encoding for Interfaces	1503
1.18.1.5 Data Encoding for Proxies	1505
1.18.1.6 Data Encoding for Optional Values	1510
1.18.2 Protocol Messages	1516
1.18.3 Protocol Compression	1547
1.18.4 Protocol and Encoding Versions	1549
1.19 IceGrid	1551
1.19.1 IceGrid Architecture	1553
1.19.2 Getting Started with IceGrid	1555
1.19.3 Using IceGrid Deployment	1560
1.19.4 Well-Known Objects	1568
1.19.5 IceGrid Templates	1577
1.19.6 IceBox Integration with IceGrid	1583
1.19.7 Object Adapter Replication	1588
1.19.8 Load Balancing	1592
1.19.9 Resource Allocation using IceGrid Sessions	1595
1.19.10 Registry Replication	1603
1.19.11 Application Distribution	1607
1.19.12 IceGrid Administrative Sessions	1614
1.19.13 Glacier2 Integration with IceGrid	1621
1.19.14 IceGrid XML Reference	1625
1.19.14.1 Adapter Descriptor Element	1626
1.19.14.2 Allocatable Descriptor Element	1628
1.19.14.3 Application Descriptor Element	1629
1.19.14.4 DbEnv Descriptor Element	1630
1.19.14.5 DbProperty Descriptor Element	1631
1.19.14.6 Description Descriptor Element	1632
1.19.14.7 Directory Descriptor Element	1633
1.19.14.8 Distrib Descriptor Element	1634
1.19.14.9 IceBox Descriptor Element	1635
1.19.14.10 IceGrid Descriptor Element	1636
1.19.14.11 Load-Balancing Descriptor Element	1637
1.19.14.12 Log Descriptor Element	1638
1.19.14.13 Node Descriptor Element	1639
1.19.14.14 Object Descriptor Element	1640
1.19.14.15 Parameter Descriptor Element	1641
1.19.14.16 Properties Descriptor Element	1642
1.19.14.17 Property Descriptor Element	1644
1.19.14.18 Replica-Group Descriptor Element	1645
1.19.14.19 Server Descriptor Element	1646
1.19.14.20 Server-Instance Descriptor Element	1649
1.19.14.21 Server-Template Descriptor Element	1650
1.19.14.22 Service Descriptor Element	1651
1.19.14.23 Service-Instance Descriptor Element	1652
1.19.14.24 Service-Template Descriptor Element	1653
1.19.14.25 Variable Descriptor Element	1654
1.19.14.26 Using Command Line Options in Descriptors	1655
1.19.14.27 Setting Environment Variables in Descriptors	1656
1.19.15 Using Descriptor Variables and Parameters	1658
1.19.16 IceGrid Property Set Semantics	1664

1.19.17 IceGrid XML Features	1669
1.19.18 IceGrid Server Reference	1672
1.19.18.1 icegridregistry	1673
1.19.18.2 icegridnode	1676
1.19.18.3 Well-Known Registry Objects	1678
1.19.18.4 IceGrid Persistent Data	1679
1.19.18.5 Promoting a Registry Slave	1681
1.19.19 IceGrid and the Administrative Facility	1682
1.19.20 Securing IceGrid	1689
1.19.21 icegridadmin Command Line Tool	1693
1.19.22 IceGrid Admin Graphical Tool	1699
1.19.22.1 Getting Started with IceGrid Admin	1700
1.19.22.2 Live Deployment Tab	1703
1.19.22.2.1 Connection to an IceGrid Registry	1704
1.19.22.2.2 Log File Dialog	1716
1.19.22.2.3 Run Time Components	1718
1.19.22.2.4 Application Component	1733
1.19.22.2.5 Metrics Graph	1734
1.19.22.3 Application Tabs	1737
1.19.22.3.1 Editing and Saving IceGrid Descriptors	1738
1.19.22.3.2 Navigation within an Application Tab	1741
1.19.22.3.3 IceGrid Descriptors	1742
1.19.23 IceGrid Server Activation	1762
1.19.24 IceGrid Troubleshooting	1765
1.20 Freeze	1768
1.20.1 Freeze Evictors	1769
1.20.1.1 Freeze Evictor Concepts	1770
1.20.1.2 Background Save Evictor	1776
1.20.1.3 Transactional Evictor	1780
1.20.1.4 Using a Freeze Evictor in the File System Server	1785
1.20.1.4.1 Adding an Evictor to the C++ File System Server	1789
1.20.1.4.2 Adding an Evictor to the Java File System Server	1799
1.20.2 Freeze Maps	1808
1.20.2.1 Freeze Map Concepts	1809
1.20.2.2 Using a Freeze Map in C++	1817
1.20.2.3 Using a Freeze Map in Java	1827
1.20.2.4 Using a Freeze Map in the File System Server	1843
1.20.2.4.1 Adding a Freeze Map to the C++ File System Server	1845
1.20.2.4.2 Adding a Freeze Map to the Java File System Server	1859
1.20.3 Freeze Catalogs	1873
1.20.4 Backing Up Freeze Databases	1875
1.21 FreezeScript	1876
1.21.1 Migrating a Freeze Database	1877
1.21.1.1 Automatic Database Migration	1878
1.21.1.2 Custom Database Migration	1882
1.21.1.3 FreezeScript Transformation XML Reference	1887
1.21.1.4 Using transformdb	1895
1.21.2 Inspecting a Freeze Database	1901
1.21.2.1 Using dumpdb	1902
1.21.2.2 FreezeScript Inspection XML Reference	1908
1.21.3 FreezeScript Descriptor Expression Language	1915
1.22 IceSSL	1918
1.22.1 Using IceSSL	1920
1.22.2 Configuring IceSSL	1923
1.22.3 Programming IceSSL	1935
1.22.3.1 Programming IceSSL in C++	1936
1.22.3.2 Programming IceSSL in Java	1943
1.22.3.3 Programming IceSSL in .NET	1948
1.22.4 Advanced IceSSL Topics	1953
1.22.5 Setting up a Certificate Authority	1961
1.23 Glacier2	1966

1.23.1 Common Firewall Traversal Issues	1967
1.23.2 About Glacier2	1968
1.23.3 How Glacier2 Works	1969
1.23.4 Getting Started with Glacier2	1970
1.23.5 Callbacks through Glacier2	1976
1.23.6 Glacier2 Helper Classes	1979
1.23.7 Securing a Glacier2 Router	1988
1.23.8 Glacier2 Session Management	1996
1.23.9 Dynamic Request Filtering with Glacier2	1999
1.23.10 Glacier2 Request Buffering	2001
1.23.11 How Glacier2 uses Request Contexts	2002
1.23.12 Configuring Glacier2 behind an External Firewall	2004
1.23.13 Advanced Glacier2 Client Configurations	2005
1.23.14 IceGrid and Glacier2 Integration	2007
1.23.15 Glacier2 Metrics	2009
1.24 IceBox	2011
1.24.1 Developing IceBox Services	2012
1.24.2 Configuring IceBox Services	2018
1.24.3 Starting the IceBox Server	2022
1.24.4 IceBox Administration	2024
1.25 IceStorm	2029
1.25.1 IceStorm Concepts	2030
1.25.2 IceStorm Interfaces	2032
1.25.3 Using IceStorm	2035
1.25.3.1 Implementing an IceStorm Publisher	2036
1.25.3.2 Using an IceStorm Publisher Object	2041
1.25.3.3 Implementing an IceStorm Subscriber	2043
1.25.3.4 Publishing to a Specific Subscriber	2050
1.25.4 Highly Available IceStorm	2052
1.25.5 IceStorm Administration	2056
1.25.6 Topic Federation	2058
1.25.7 IceStorm Quality of Service	2062
1.25.8 IceStorm Delivery Modes	2064
1.25.9 Configuring IceStorm	2066
1.25.10 IceStorm Metrics	2071
1.26 IcePatch2	2073
1.26.1 Using icepatch2calc	2074
1.26.2 Running the IcePatch2 Server	2077
1.26.3 Running the IcePatch2 Client	2078
1.26.4 IcePatch2 Object Identities	2080
1.26.5 IcePatch2 Client Utility Library	2081
1.27 Property Reference	2085
1.27.1 Ice Configuration Property	2086
1.27.2 Ice Trace Properties	2087
1.27.3 Ice Warning Properties	2090
1.27.4 Ice Object Adapter Properties	2092
1.27.5 Ice Administrative Properties	2096
1.27.6 Ice Plug-In Properties	2098
1.27.7 Ice Thread Pool Properties	2102
1.27.8 Ice Default and Override Properties	2105
1.27.9 Ice Proxy Properties	2110
1.27.10 Ice Transport Properties	2113
1.27.11 Ice Miscellaneous Properties	2116
1.27.12 IceSSL Properties	2125
1.27.13 IceBox Properties	2139
1.27.14 IceBoxAdmin Properties	2143
1.27.15 IceGrid Properties	2144
1.27.16 IceGrid Administrative Client Properties	2158
1.27.17 IceMX Metrics Properties	2160
1.27.18 IceStorm Properties	2162
1.27.19 Glacier2 Properties	2169

1.27.20 Freeze Properties	2180
1.27.21 IcePatch2 Properties	2187
1.27.22 IcePatch2Client Properties	2188
1.28 Windows Services	2190
1.28.1 Installing a Windows Service	2191
1.28.2 Using the Ice Service Installer	2192
1.28.3 Manually Installing a Service	2196
1.28.4 Troubleshooting Windows Services	2203
1.29 Binary Distributions	2205
1.29.1 Ice Developer Kits	2206
1.29.2 Guidelines for Distributing Ice Applications	2207
1.30 Deprecated AMI Mapping	2210
1.30.1 Overview of Deprecated AMI Mapping	2211
1.30.2 Deprecated AMI Language Mappings	2215
1.30.3 Advanced Topics for Deprecated AMI Mapping	2224
1.31 IDE Integration	2232
1.31.1 Visual Studio Add-in	2233
1.31.2 Eclipse Plug-in	2236
1.31.3 Xcode Plug-in	2238
2. Slice API Reference	2240
2.1 Ice Slice API	2241
2.1.1 Ice-AdapterAlreadyActiveException	2247
2.1.2 Ice-AdapterNotFoundException	2248
2.1.3 Ice-AlreadyRegisteredException	2249
2.1.4 Ice-BadMagicException	2250
2.1.5 Ice-CloneNotImplementedException	2251
2.1.6 Ice-CloseConnectionException	2252
2.1.7 Ice-CloseTimeoutException	2253
2.1.8 Ice-CollocationOptimizationException	2254
2.1.9 Ice-Communicator	2255
2.1.10 Ice-CommunicatorDestroyedException	2264
2.1.11 Ice-CompressionException	2265
2.1.12 Ice-ConnectFailedException	2266
2.1.13 Ice-Connection	2267
2.1.14 Ice-ConnectionInfo	2270
2.1.15 Ice-ConnectionLostException	2271
2.1.16 Ice-ConnectionNotValidatedException	2272
2.1.17 Ice-ConnectionRefusedException	2273
2.1.18 Ice-ConnectionTimeoutException	2274
2.1.19 Ice-ConnectTimeoutException	2275
2.1.20 Ice-Current	2276
2.1.21 Ice-DatagramLimitException	2278
2.1.22 Ice-DNSException	2279
2.1.23 Ice-EncapsulationException	2280
2.1.24 Ice-EncodingVersion	2281
2.1.25 Ice-Endpoint	2282
2.1.26 Ice-EndpointInfo	2283
2.1.27 Ice-EndpointParseException	2284
2.1.28 Ice-EndpointSelectionType	2285
2.1.29 Ice-EndpointSelectionTypeParseException	2286
2.1.30 Ice-FacetNotExistException	2287
2.1.31 Ice-FeatureNotSupportedException	2288
2.1.32 Ice-FileException	2289
2.1.33 Ice-FixedProxyException	2290
2.1.34 Ice-ForcedCloseConnectionException	2291
2.1.35 Ice-Identity	2292
2.1.36 Ice-IdentityParseException	2294
2.1.37 Ice-IllegalIdentityException	2295
2.1.38 Ice-IllegalMessageSizeException	2296
2.1.39 Ice-ImplicitContext	2297
2.1.40 Ice-InitializationException	2299

2.1.41 Ice-InvalidReplicaGroupIdException	2300
2.1.42 Ice-IPConnectionInfo	2301
2.1.43 Ice-IPEndpointInfo	2302
2.1.44 Ice-Locator	2303
2.1.45 Ice-LocatorRegistry	2305
2.1.46 Ice-Logger	2307
2.1.47 Ice-MarshallException	2309
2.1.48 Ice-MemoryLimitException	2310
2.1.49 Ice-NoEndpointException	2311
2.1.50 Ice-NoObjectFactoryException	2312
2.1.51 Ice-NotRegisteredException	2313
2.1.52 Ice-ObjectAdapter	2314
2.1.53 Ice-ObjectAdapterDeactivatedException	2325
2.1.54 Ice-ObjectAdapterIdInUseException	2326
2.1.55 Ice-ObjectFactory	2327
2.1.56 Ice-ObjectNotExistException	2328
2.1.57 Ice-ObjectNotFoundException	2329
2.1.58 Ice-OpaqueEndpointInfo	2330
2.1.59 Ice-OperationMode	2331
2.1.60 Ice-OperationNotExistException	2332
2.1.61 Ice-Plugin	2333
2.1.62 Ice-PluginInitializationException	2334
2.1.63 Ice-PluginManager	2335
2.1.64 Ice-Process	2337
2.1.65 Ice-Properties	2338
2.1.66 Ice-PropertiesAdmin	2342
2.1.67 Ice-ProtocolException	2343
2.1.68 Ice-ProtocolVersion	2344
2.1.69 Ice-ProxyParseException	2345
2.1.70 Ice-ProxyUnmarshalException	2346
2.1.71 Ice-RequestFailedException	2347
2.1.72 Ice-ResponseSentException	2348
2.1.73 Ice-Router	2349
2.1.74 Ice-SecurityException	2351
2.1.75 Ice-ServantLocator	2352
2.1.76 Ice-ServerNotFoundException	2354
2.1.77 Ice-SocketException	2355
2.1.78 Ice-Stats	2356
2.1.79 Ice-StringConversionException	2357
2.1.80 Ice-SyscallException	2358
2.1.81 Ice-TCPConnectionInfo	2359
2.1.82 Ice-TCPEndpointInfo	2360
2.1.83 Ice-TimeoutException	2361
2.1.84 Ice-TwoWayOnlyException	2362
2.1.85 Ice-UDPCConnectionInfo	2363
2.1.86 Ice-UDPEndpointInfo	2364
2.1.87 Ice-UnexpectedObjectException	2365
2.1.88 Ice-UnknownException	2366
2.1.89 Ice-UnknownLocalException	2367
2.1.90 Ice-UnknownMessageException	2368
2.1.91 Ice-UnknownReplyStatusException	2369
2.1.92 Ice-UnknownRequestIdException	2370
2.1.93 Ice-UnknownUserException	2371
2.1.94 Ice-UnmarshalOutOfBoundsException	2372
2.1.95 Ice-UnsupportedEncodingException	2373
2.1.96 Ice-UnsupportedProtocolException	2374
2.1.97 Ice-VersionMismatchException	2375
2.1.98 Ice-VersionParseException	2376
2.1.99 Ice-Instrumentation	2377
2.1.99.1 Ice-Instrumentation-CommunicatorObserver	2378
2.1.99.2 Ice-Instrumentation-ConnectionObserver	2380

2.1.99.3 Ice-Instrumentation-ConnectionState	2381
2.1.99.4 Ice-Instrumentation-DispatchObserver	2382
2.1.99.5 Ice-Instrumentation-InvocationObserver	2383
2.1.99.6 Ice-Instrumentation-Observer	2384
2.1.99.7 Ice-Instrumentation-ObserverUpdater	2385
2.1.99.8 Ice-Instrumentation-RemoteObserver	2386
2.1.99.9 Ice-Instrumentation-ThreadObserver	2387
2.1.99.10 Ice-Instrumentation-ThreadState	2388
2.2 IceGrid Slice API	2389
2.2.1 IceGrid-AdapterDescriptor	2395
2.2.2 IceGrid-AccessDeniedException	2397
2.2.3 IceGrid-AdapterDynamicInfo	2398
2.2.4 IceGrid-AdapterInfo	2399
2.2.5 IceGrid-AdapterNotExistException	2400
2.2.6 IceGrid-AdapterObserver	2401
2.2.7 IceGrid-AdaptiveLoadBalancingPolicy	2402
2.2.8 IceGrid-Admin	2403
2.2.9 IceGrid-AdminSession	2416
2.2.10 IceGrid-AllocationException	2421
2.2.11 IceGrid-AllocationTimeoutException	2422
2.2.12 IceGrid-ApplicationDescriptor	2423
2.2.13 IceGrid-ApplicationInfo	2425
2.2.14 IceGrid-ApplicationNotExistException	2426
2.2.15 IceGrid-ApplicationObserver	2427
2.2.16 IceGrid-ApplicationUpdateDescriptor	2428
2.2.17 IceGrid-ApplicationUpdateInfo	2430
2.2.18 IceGrid-BadSignalException	2431
2.2.19 IceGrid-BoxedDistributionDescriptor	2432
2.2.20 IceGrid-BoxedString	2433
2.2.21 IceGrid-CommunicatorDescriptor	2434
2.2.22 IceGrid-DbEnvDescriptor	2435
2.2.23 IceGrid-DeploymentException	2436
2.2.24 IceGrid-DistributionDescriptor	2437
2.2.25 IceGrid-FileIterator	2438
2.2.26 IceGrid-FileNotAvailableException	2439
2.2.27 IceGrid-FileParser	2440
2.2.28 IceGrid-IceBoxDescriptor	2441
2.2.29 IceGrid-LoadBalancingPolicy	2442
2.2.30 IceGrid-LoadInfo	2443
2.2.31 IceGrid-Locator	2444
2.2.32 IceGrid-NodeDescriptor	2445
2.2.33 IceGrid-NodeDynamicInfo	2446
2.2.34 IceGrid-NodeInfo	2447
2.2.35 IceGrid-NodeNotExistException	2449
2.2.36 IceGrid-NodeObserver	2450
2.2.37 IceGrid-NodeUnreachableException	2452
2.2.38 IceGrid-NodeUpdateDescriptor	2453
2.2.39 IceGrid-ObjectDescriptor	2455
2.2.40 IceGrid-ObjectExistsException	2456
2.2.41 IceGrid-ObjectInfo	2457
2.2.42 IceGrid-ObjectNotRegisteredException	2458
2.2.43 IceGrid-ObjectObserver	2459
2.2.44 IceGrid-ObserverAlreadyRegisteredException	2460
2.2.45 IceGrid-OrderedLoadBalancingPolicy	2461
2.2.46 IceGrid-ParseException	2462
2.2.47 IceGrid-PatchException	2463
2.2.48 IceGrid-PermissionDeniedException	2464
2.2.49 IceGrid-PropertyDescriptor	2465
2.2.50 IceGrid-PropertySetDescriptor	2466
2.2.51 IceGrid-Query	2467
2.2.52 IceGrid-RandomLoadBalancingPolicy	2469

2.2.53	IceGrid-Registry	2470
2.2.54	IceGrid-RegistryInfo	2472
2.2.55	IceGrid-RegistryNotExistException	2473
2.2.56	IceGrid-RegistryObserver	2474
2.2.57	IceGrid-RegistryUnreachableException	2475
2.2.58	IceGrid-ReplicaGroupDescriptor	2476
2.2.59	IceGrid-RoundRobinLoadBalancingPolicy	2477
2.2.60	IceGrid-ServerDescriptor	2478
2.2.61	IceGrid-ServerDynamicInfo	2480
2.2.62	IceGrid-ServerInfo	2481
2.2.63	IceGrid-ServerInstanceDescriptor	2482
2.2.64	IceGrid-ServerNotExistException	2483
2.2.65	IceGrid-ServerStartException	2484
2.2.66	IceGrid-ServerState	2485
2.2.67	IceGrid-ServerStopException	2486
2.2.68	IceGrid-ServerUnreachableException	2487
2.2.69	IceGrid-ServiceDescriptor	2488
2.2.70	IceGrid-ServiceInstanceDescriptor	2489
2.2.71	IceGrid-Session	2490
2.2.72	IceGrid-TemplateDescriptor	2492
2.2.73	IceGrid-UserAccountMapper	2493
2.2.74	IceGrid-UserAccountNotFoundException	2494
2.2.75	IceGrid-LoadSample	2495
2.3	Freeze Slice API	2496
2.3.1	Freeze-BackgroundSaveEvictor	2497
2.3.2	Freeze-CatalogData	2499
2.3.3	Freeze-Connection	2500
2.3.4	Freeze-DatabaseException	2502
2.3.5	Freeze-DeadlockException	2503
2.3.6	Freeze-Evictor	2504
2.3.7	Freeze-EvictorDeactivatedException	2508
2.3.8	Freeze-EvictorIterator	2509
2.3.9	Freeze-IndexNotFoundException	2510
2.3.10	Freeze-InvalidPositionException	2511
2.3.11	Freeze-NoSuchElementException	2512
2.3.12	Freeze-NotFoundException	2513
2.3.13	Freeze-ObjectRecord	2514
2.3.14	Freeze-ServantInitializer	2515
2.3.15	Freeze-Statistics	2516
2.3.16	Freeze-Transaction	2517
2.3.17	Freeze-TransactionalEvictor	2518
2.3.18	Freeze-TransactionAlreadyInProgressException	2519
2.4	IceSSL Slice API	2520
2.4.1	IceSSL-ConnectionInfo	2521
2.4.2	IceSSL-EndpointInfo	2522
2.5	Glacier2 Slice API	2523
2.5.1	Glacier2-Admin	2524
2.5.2	Glacier2-CannotCreateSessionException	2525
2.5.3	Glacier2-SSLSessionManager	2526
2.5.4	Glacier2-IdentitySet	2527
2.5.5	Glacier2-PermissionDeniedException	2528
2.5.6	Glacier2-PermissionsVerifier	2529
2.5.7	Glacier2-Router	2530
2.5.8	Glacier2-Session	2532
2.5.9	Glacier2-SessionControl	2533
2.5.10	Glacier2-SessionManager	2535
2.5.11	Glacier2-SessionNotExistException	2536
2.5.12	Glacier2-SSLInfo	2537
2.5.13	Glacier2-SSLPermissionsVerifier	2538
2.5.14	Glacier2-StringSet	2539
2.6	IceBox Slice API	2540

2.6.1	IceBox-AlreadyStoppedException	2541
2.6.2	IceBox-AlreadyStartedException	2542
2.6.3	IceBox-ServiceManager	2543
2.6.4	IceBox-FailureException	2545
2.6.5	IceBox-NoSuchServiceException	2546
2.6.6	IceBox-Service	2547
2.6.7	IceBox-ServiceObserver	2548
2.7	IceStorm Slice API	2549
2.7.1	IceStorm-BadQoS	2551
2.7.2	IceStorm-AlreadySubscribed	2552
2.7.3	IceStorm-LinkExists	2553
2.7.4	IceStorm-LinkInfo	2554
2.7.5	IceStorm-NoSuchTopic	2555
2.7.6	IceStorm-Topic	2556
2.7.7	IceStorm-NoSuchLink	2559
2.7.8	IceStorm-TopicExists	2560
2.7.9	IceStorm-TopicManager	2561
2.8	IcePatch2 Slice API	2563
2.8.1	IcePatch2-Admin	2564
2.8.2	IcePatch2-FileAccessException	2565
2.8.3	IcePatch2-FileInfo	2566
2.8.4	IcePatch2-FileServer	2567
2.8.5	IcePatch2-PartitionOutOfRangeException	2569
2.9	IceMX Slice API	2570
2.9.1	IceMX-ConnectionMetrics	2572
2.9.2	IceMX-DispatchMetrics	2573
2.9.3	IceMX-InvocationMetrics	2574
2.9.4	IceMX-Metrics	2575
2.9.5	IceMX-MetricsAdmin	2576
2.9.6	IceMX-MetricsFailures	2578
2.9.7	IceMX-RemoteMetrics	2579
2.9.8	IceMX-SessionMetrics	2580
2.9.9	IceMX-SubscriberMetrics	2581
2.9.10	IceMX-ThreadMetrics	2582
2.9.11	IceMX-TopicMetrics	2583
2.9.12	IceMX-UnknownMetricsView	2584
3.	Release Notes	2585
3.1	New Features in Ice 3.5	2586
3.2	Encoding Changes in Ice 3.5	2591
3.3	Upgrading your Application from Ice 3.5.0	2592
3.4	Upgrading your Application from Ice 3.4	2596
3.5	Upgrading your Application from Ice 3.3	2604
3.6	Upgrading your Application from Ice 3.2 or Earlier Releases	2623
3.7	Platform Notes for Ice 3.5	2630
3.8	Known Problems in Ice 3.5	2632
3.9	Using the Windows Binary Distribution	2634
3.10	Using the Linux Binary Distributions	2643
3.11	Using the OS X Binary Distribution	2650
3.12	Using the Solaris Binary Distribution	2654
3.13	Sample Programs	2657
3.13.1	Using the Sample Programs	2658
3.13.2	Using the Sample Programs on Windows	2663
3.14	Building Ice from Source	2668
3.14.1	Building Ice for C++ on Linux	2669
3.14.2	Building Ice for C++ on OS X	2671
3.14.3	Building Ice for C++ on Solaris	2673
3.14.4	Building Ice for C++ on Windows	2675
3.14.4.1	Building Ice for C++ for Windows Applications	2676
3.14.4.2	Building Ice for C++ for WinRT Applications	2678
3.14.4.3	Building Ice for C++ with MinGW	2680
3.14.5	Building Ice for Java	2682

3.14.6 Building Ice for .NET with Visual Studio	2687
3.14.7 Building Ice for .NET with Mono	2692
3.14.8 Building Ice for PHP	2695
3.14.9 Building Ice for Python	2700
3.14.10 Building Ice for Ruby	2702
3.14.11 Building the Visual Studio Add-in	2706

Ice Manual

Distributed Programming with Ice

The Internet Communications Engine (Ice) is a modern object-oriented toolkit that enables you to build distributed applications with minimal effort. Ice allows you to focus your efforts on your application logic, and it takes care of all interactions with low-level network programming interfaces. With Ice, there is no need to worry about details such as opening network connections, serializing and deserializing data for network transmission, or retrying failed connection attempts.

The main design goals of Ice are:

- Provide an object-oriented middleware platform suitable for use in heterogeneous environments.
- Provide a full set of features that support development of realistic distributed applications for a wide variety of domains.
- Avoid unnecessary complexity, making the platform easy to learn and to use.
- Provide an implementation that is efficient in network bandwidth, memory use, and CPU overhead.
- Provide an implementation that has built-in security, making it suitable for use over insecure public networks.

In simpler terms, the Ice design goals could be stated as "Let's build a powerful middleware platform that makes the developer's life easier."



The acronym "Ice" is pronounced as a single syllable, like the word for frozen water.

Getting Help with Ice

If you have a question and you cannot find an answer in this manual, you can visit our [developer forums](#) to see if another developer has encountered the same issue. If you still need help, feel free to post your question on the forum, which ZeroC's developers monitor regularly. Note, however, that we can provide only limited free support in our forums. For guaranteed response and problem resolution times, we highly recommend purchasing [commercial support](#).

Feedback about the Manual

We would very much like to hear from you in case you find any bugs (however minor) in this manual. We also would like to hear your opinion on the contents, and any suggestions as to how it might be improved. You can contact us via e-mail at icebook@zeroc.com.

Legal Notices

Many of the designations used by manufacturers and sellers to distinguish their products are claimed as trademarks. Where those designations appear in this book and ZeroC was aware of the trademark claim, the designations have been printed in initial caps or all caps. The authors and publisher have taken care in the preparation of this book, but make no expressed or implied warranty of any kind and assume no responsibility for errors or omissions. No liability is assumed for incidental or consequential damages in connection with or arising out of the use of the information or programs contained herein.

License

This manual is provided under one of two licenses, whichever you prefer:

- [Creative Commons Attribution-No Derivative Works 3.0 Unported License](#).
This license does not permit you to make modifications.
- [Creative Commons Attribution-Noncommercial-Share Alike 3.0 Unported License](#).

This license permits you to make modifications, but for non-commercial use only. If you distribute this manual under this license, you must prominently include the following text:

*This document is derived from ZeroC's Ice Manual, Copyright © ZeroC, Inc. 2003-2013.
You can find the latest version of this document at:
<http://doc.zeroc.com/display/Ice/Ice+Manual>*

Copyright

Copyright © 2003-2013 by ZeroC, Inc.
<mailto:info@zeroc.com>
<http://www.zeroc.com>

Ice Overview

The following topics provide a high-level overview of Ice:

- [Ice Architecture](#) introduces fundamental concepts and terminology, and outlines how Slice definitions, language mappings, and the Ice run time and protocol work in concert to create clients and servers.
- [Ice Services](#) briefly presents the object services provided by Ice.
- [Architectural Benefits of Ice](#) outlines the benefits that result from the Ice architecture.

Topics

- [Ice Architecture](#)
- [Ice Services](#)
- [Architectural Benefits of Ice](#)

Ice Architecture

Ice is an object-oriented middleware platform. Fundamentally, this means that Ice provides tools, APIs, and library support for building object-oriented client-server applications. Ice applications are suitable for use in heterogeneous environments: client and server can be written in different programming languages, can run on different operating systems and machine architectures, and can communicate using a variety of networking technologies. The source code for these applications is portable regardless of the deployment environment.

Topics:

- [Terminology](#)
- [Slice \(Specification Language for Ice\)](#)
- [Language Mappings](#)
- [Client and Server Structure](#)
- [Overview of the Ice Protocol](#)

See Also

- [Ice Services](#)
- [Architectural Benefits of Ice](#)

Terminology

Every computing technology creates its own vocabulary as it evolves. Ice is no exception. However, the amount of new jargon used by Ice is minimal. Rather than inventing new terms, we have used existing terminology as much as possible. If you have used another middleware technology in the past, you will be familiar with much of what follows. (However, we suggest you at least skim the material because a few terms used by Ice *do* differ from the corresponding terms used by other middleware.)

On this page:

- [Clients and Servers](#)
- [Ice Objects](#)
- [Proxies](#)
- [Stringified Proxies](#)
- [Direct Proxies](#)
- [Indirect Proxies](#)
- [Direct Versus Indirect Binding](#)
- [Fixed Proxies](#)
- [Routed Proxies](#)
- [Replication](#)
- [Replica Groups](#)
- [Servants](#)
- [At-Most-Once Semantics](#)
- [Synchronous Method Invocation](#)
- [Asynchronous Method Invocation](#)
- [Asynchronous Method Dispatch](#)
- [Oneway Method Invocation](#)
- [Batched Oneway Method Invocation](#)
- [Datagram Invocations](#)
- [Batched Datagram Invocations](#)
- [Run-Time Exceptions](#)
- [User Exceptions](#)
- [Properties](#)

Clients and Servers

The terms *client* and *server* are not firm designations for particular parts of an application; rather, they denote roles that are taken by parts of an application for the duration of a request:

- Clients are active entities. They issue requests for service to servers.
- Servers are passive entities. They provide services in response to client requests.

Frequently, servers are not "pure" servers, in the sense that they never issue requests and only respond to requests. Instead, servers often act as a server on behalf of some client but, in turn, act as a client to another server in order to satisfy their client's request.

Similarly, clients often are not "pure" clients, in the sense that they only request service from an object. Instead, clients are frequently client-server hybrids. For example, a client might start a long-running operation on a server; as part of starting the operation, the client can provide a *callback object* to the server that is used by the server to notify the client when the operation is complete. In that case, the client acts as a client when it starts the operation, and as a server when it is notified that the operation is complete.

Such role reversal is common in many systems, so, frequently, client-server systems could be more accurately described as *peer-to-peer* systems.

Ice Objects

An *Ice object* is a conceptual entity, or abstraction. An Ice object can be characterized by the following points:

- An Ice object is an entity in the local or a remote address space that can respond to client requests.
- A single Ice object can be instantiated in a single server or, redundantly, in multiple servers. If an object has multiple simultaneous instantiations, it is still a single Ice object.
- Each Ice object has one or more *interfaces*. An interface is a collection of named *operations* that are supported by an object. Clients

issue requests by invoking operations.

- An operation has zero or more *parameters* as well as a *return value*. Parameters and return values have a specific *type*. Parameters are named and have a direction: in-parameters are initialized by the client and passed to the server; out-parameters are initialized by the server and passed to the client. (The return value is simply a special out-parameter.)
- An Ice object has a distinguished interface, known as its *main interface*. In addition, an Ice object can provide zero or more alternate interfaces, known as *facets*. Clients can select among the facets of an object to choose the interface they want to work with.
- Each Ice object has a unique *object identity*. An object's identity is an identifying value that distinguishes the object from all other objects. The Ice object model assumes that object identities are globally unique, that is, no two objects within an Ice communication domain can have the same object identity.

In practice, you need not use object identities that are globally unique, such as [UUIDs](#), only identities that do not clash with any other identity within your domain of interest. However, there are architectural advantages to using globally unique identifiers, which we explore in our discussion of [object life cycle](#).

Proxies

For a client to be able to contact an Ice object, the client must hold a *proxy* for the Ice object. A *proxy* is an artifact that is local to the client's address space; it represents the (possibly remote) Ice object for the client. A proxy acts as the local ambassador for an Ice object: when the client invokes an operation on the proxy, the Ice run time:

1. Locates the Ice object
2. Activates the Ice object's server if it is not running
3. Activates the Ice object within the server
4. Transmits any in-parameters to the Ice object
5. Waits for the operation to complete
6. Returns any out-parameters and the return value to the client (or throws an exception in case of an error)

A proxy encapsulates all the necessary information for this sequence of steps to take place. In particular, a proxy contains:

- Addressing information that allows the client-side run time to contact the correct server
- An object identity that identifies which particular object in the server is the target of a request
- An optional facet identifier that determines which particular facet of an object the proxy refers to

Stringified Proxies

The information in a proxy can be expressed as a string. For example, the string:

```
SimplePrinter:default -p 10000
```

is a human-readable representation of a proxy. The Ice run time provides API calls that allow you to convert a proxy to its stringified form and vice versa. This is useful, for example, to store proxies in database tables or text files.

Provided that a client knows the identity of an Ice object and its addressing information, it can create a proxy "out of thin air" by supplying that information. In other words, no part of the information inside a proxy is considered opaque; a client needs to know only an object's identity, addressing information, and (to be able to invoke an operation) the object's type in order to contact the object.

Direct Proxies

A *direct proxy* is a proxy that embeds an object's identity, together with the address at which its server runs. The address is completely specified by:

- a protocol identifier (such TCP/IP or UDP)
- a protocol-specific address (such as a host name and port number)

To contact the object denoted by a direct proxy, the Ice run time uses the addressing information in the proxy to contact the server; the identity of the object is sent to the server with each request made by the client.

Indirect Proxies

An *indirect proxy* has two forms. It may provide only an object's identity, or it may specify an identity together with an object adapter identifier. An object that is accessible using only its identity is called a well-known object. For example, the string:

```
SimplePrinter
```

is a valid proxy for a well-known object with the identity `SimplePrinter`.

An indirect proxy that includes an object adapter identifier has the stringified form

```
SimplePrinter@PrinterAdapter
```

Any object of the object adapter can be accessed using such a proxy, regardless of whether that object is also a well-known object.

Notice that an indirect proxy contains no addressing information. To determine the correct server, the client-side run time passes the proxy information to a [location service](#). In turn, the location service uses the object identity or the object adapter identifier as the key in a lookup table that contains the address of the server and returns the current server address to the client. The client-side run time now knows how to contact the server and dispatches the client request as usual.

The entire process is similar to the mapping from Internet domain names to IP address by the Domain Name Service (DNS): when we use a domain name, such as `www.zeroc.com`, to look up a web page, the host name is first resolved to an IP address behind the scenes and, once the correct IP address is known, the IP address is used to connect to the server. With Ice, the mapping is from an object identity or object adapter identifier to a protocol-address pair, but otherwise very similar. The client-side run time knows how to contact the location service via configuration (just as web browsers know which DNS server to use via configuration).

Direct Versus Indirect Binding

The process of resolving the information in a proxy to protocol-address pair is known as *binding*. Not surprisingly, *direct binding* is used for direct proxies, and *indirect binding* is used for indirect proxies.

The main advantage of indirect binding is that it allows us to move servers around (that is, change their address) without invalidating existing proxies that are held by clients. In other words, direct proxies avoid the extra lookup to locate the server but no longer work if a server is moved to a different machine. On the other hand, indirect proxies continue to work even if we move (or *migrate*) a server.

Fixed Proxies

A *fixed proxy* is a proxy that is bound to a particular connection: instead of containing addressing information or an adapter name, the proxy contains a connection handle. The connection handle stays valid only for as long as the connection stays open so, once the connection is closed, the proxy no longer works (and will never work again). Fixed proxies cannot be marshaled, that is, they cannot be passed as parameters on operation invocations. Fixed proxies are used to allow [bidirectional communication](#), so a server can make callbacks to a client without having to open a new connection.

Routed Proxies

A *routed proxy* is a proxy that forwards all invocations to a specific target object, instead of sending invocations directly to the actual target. Routed proxies are useful for implementing services such as [Glacier2](#), which enables clients to communicate with servers that are behind a firewall.

Replication

In Ice, *replication* involves making object adapters (and their objects) available at multiple addresses. The goal of replication is usually to provide redundancy by running the same server on several computers. If one of the computers should happen to fail, a server still remains available on the others.

The use of replication implies that applications are designed for it. In particular, it means a client can access an object via one address and obtain the same result as from any other address. Either these objects are stateless, or their implementations are designed to synchronize

with a database (or each other) in order to maintain a consistent view of each object's state.

Ice supports a limited form of replication when a proxy specifies multiple addresses for an object. The Ice run time selects one of the addresses at random for its [initial connection attempt](#) and tries all of them in the case of a failure. For example, consider this proxy:

```
SimplePrinter:tcp -h server1 -p 10001:tcp -h server2 -p 10002
```

The proxy states that the object with identity `SimplePrinter` is available using TCP at two addresses, one on the host `server1` and another on the host `server2`. The burden falls to users or system administrators to ensure that the servers are actually running on these computers at the specified ports.

Replica Groups

In addition to the proxy-based replication described above, Ice supports a more useful form of replication known as *replica groups* that requires the use of a [location service](#).

A replica group has a unique identifier and consists of any number of object adapters. An object adapter may be a member of at most one replica group; such an adapter is considered to be a *replicated object adapter*.

After a replica group has been established, its identifier can be used in an indirect proxy in place of an adapter identifier. For example, a replica group identified as `PrinterAdapters` can be used in a proxy as shown below:

```
SimplePrinter@PrinterAdapters
```

The replica group is treated by the location service as a "virtual object adapter." The behavior of the location service when resolving an indirect proxy containing a replica group id is an implementation detail. For example, the location service could decide to return the addresses of all object adapters in the group, in which case the client's Ice run time would select one of the addresses at random using the limited form of replication discussed earlier. Another possibility is for the location service to return only one address, which it decided upon using some heuristic.

Regardless of the way in which a location service resolves a replica group, the key benefit is indirection: the location service as a middleman can add more intelligence to the binding process.

Servants

As we mentioned, an [Ice Object](#) is a conceptual entity that has a type, identity, and addressing information. However, client requests ultimately must end up with a concrete server-side processing entity that can provide the behavior for an operation invocation. To put this differently, a client request must ultimately end up executing code inside the server, with that code written in a specific programming language and executing on a specific processor.

The server-side artifact that provides behavior for operation invocations is known as a *servant*. A servant provides substance for (or *incarnates*) one or more Ice objects. In practice, a servant is simply an instance of a class that is written by the server developer and that is registered with the server-side run time as the servant for one or more Ice objects. Methods on the class correspond to the operations on the Ice object's interface and provide the behavior for the operations.

A single servant can incarnate a single Ice object at a time or several Ice objects simultaneously. If the former, the identity of the Ice object incarnated by the servant is implicit in the servant. If the latter, the servant is provided the identity of the Ice object with each request, so it can decide which object to incarnate for the duration of the request.

Conversely, a single Ice object can have multiple servants. For example, we might choose to create a proxy for an Ice object with two different addresses for different machines. In that case, we will have two servers, with each server containing a servant for the same Ice object. When a client invokes an operation on such an Ice object, the client-side run time sends the request to exactly one server. In other words, multiple servants for a single Ice object allow you to build redundant systems: the client-side run time attempts to send the request to one server and, if that attempt fails, sends the request to the second server. An error is reported back to the client-side application code only if that second attempt also fails.

At-Most-Once Semantics

Ice requests have *at-most-once* semantics: the Ice run time does its best to deliver a request to the correct destination and, depending on the exact circumstances, may retry a failed request. Ice guarantees that it will either deliver the request, or, if it cannot deliver the request, inform the client with an appropriate exception; under no circumstances is a request delivered twice, that is, retries are attempted only if it is known that a previous attempt definitely failed.



One exception to this rule are datagram invocations over UDP transports. For these, duplicated UDP packets can lead to a violation of at-most-once semantics.

At-most-once semantics are important because they guarantee that operations that are not *idempotent* can be used safely. An idempotent operation is an operation that, if executed twice, has the same effect as if executed once. For example, $x = 1$; is an idempotent operation: if we execute the operation twice, the end result is the same as if we had executed it once. On the other hand, $x++$; is not idempotent: if we execute the operation twice, the end result is not the same as if we had executed it once.

Without at-most-once semantics, we can build distributed systems that are more robust in the presence of network failures. However, realistic systems require non-idempotent operations, so at-most-once semantics are a necessity, even though they make the system less robust in the presence of network failures. Ice permits you to mark individual operations as idempotent. For such operations, the Ice run time uses a more aggressive error recovery mechanism than for non-idempotent operations.

Synchronous Method Invocation

By default, the request dispatch model used by Ice is a synchronous remote procedure call: an operation invocation behaves like a local procedure call, that is, the client thread is suspended for the duration of the call and resumes when the call completes (and all its results are available).

Asynchronous Method Invocation

Ice also supports *asynchronous method invocation (AMI)*: clients can invoke operations *asynchronously*, that is, the client uses a proxy as usual to invoke an operation but, in addition to passing the normal parameters, also passes a *callback object* and the client invocation returns immediately. Once the operation completes, the client-side run time invokes a method on the callback object passed initially, passing the results of the operation to the callback object (or, in case of failure, passing exception information).

The server cannot distinguish an asynchronous invocation from a synchronous one — either way, the server simply sees that a client has invoked an operation on an object.

Asynchronous Method Dispatch

Asynchronous method dispatch (AMD) is the server-side equivalent of AMI. For synchronous dispatch (the default), the server-side run time up-calls into the application code in the server in response to an operation invocation. While the operation is executing (or sleeping, for example, because it is waiting for data), a thread of execution is tied up in the server; that thread is released only when the operation completes.

With asynchronous method dispatch, the server-side application code is informed of the arrival of an operation invocation. However, instead of being forced to process the request immediately, the server-side application can choose to delay processing of the request and, in doing so, releases the execution thread for the request. The server-side application code is now free to do whatever it likes. Eventually, once the results of the operation are available, the server-side application code makes an API call to inform the server-side Ice run time that a request that was dispatched previously is now complete; at that point, the results of the operation are returned to the client.

Asynchronous method dispatch is useful if, for example, a server offers operations that block clients for an extended period of time. For example, the server may have an object with a `get` operation that returns data from an external, asynchronous data source and that blocks clients until the data becomes available. With synchronous dispatch, each client waiting for data to arrive ties up an execution thread in the server. Clearly, this approach does not scale beyond a few dozen clients. With asynchronous dispatch, hundreds or thousands of clients can be blocked in the same operation invocation without tying up any threads in the server.

Another way to use asynchronous method dispatch is to complete an operation, so the results of the operation are returned to the client, but to keep the execution thread of the operation beyond the duration of the operation invocation. This allows you to continue processing after results have been returned to the client, for example, to perform cleanup or write updates to persistent storage.

Synchronous and asynchronous method dispatch are transparent to the client, that is, the client cannot tell whether a server chose to process a request synchronously or asynchronously.

Oneway Method Invocation

Clients can invoke an operation as a *oneway* operation. A oneway invocation has "best effort" semantics. For a oneway invocation, the client-side run time hands the invocation to the local transport, and the invocation completes on the client side as soon as the local transport has buffered the invocation. The actual invocation is then sent asynchronously by the operating system. The server does not reply to oneway invocations, that is, traffic flows only from client to server, but not vice versa.

Oneway invocations are unreliable. For example, the target object may not exist, in which case the invocation is simply lost. Similarly, the operation may be dispatched to a servant in the server, but the operation may fail (for example, because parameter values are invalid); if so, the client receives no notification that something has gone wrong.

Oneway invocations are possible only on [operations](#) that do not have a return value, do not have out-parameters, and do not throw user exceptions.

To the application code on the server-side, oneway invocations are transparent, that is, there is no way to distinguish a twoway invocation from a oneway invocation.

Oneway invocations are available only if the target object offers a stream-oriented transport, such as TCP/IP or SSL.

Note that, even though oneway operations are sent over a stream-oriented transport, they may be processed out of order in the server. This can happen because each invocation may be dispatched in its own thread: even though the invocations are *initiated* in the order in which the invocations arrive at the server, this does not mean that they will be *processed* in that order — the vagaries of thread scheduling can result in a oneway invocation completing before other oneway invocations that were received earlier.

Batched Oneway Method Invocation

Each oneway invocation sends a separate message to the server. For a series of short messages, the overhead of doing so is considerable: the client- and server-side run time each must switch between user mode and kernel mode for each message and, at the networking level, each message incurs the overheads of flow-control and acknowledgement.

Batched oneway invocations allow you to send a series of oneway invocations as a single message: every time you invoke a batched oneway operation, the invocation is buffered in the client-side run time. Once you have accumulated all the oneway invocations you want to send, you make a separate API call to send all the invocations at once. The client-side run time then sends all of the buffered invocations in a single message, and the server receives all of the invocations in a single message. This avoids the overhead of repeatedly trapping into the kernel for both client and server, and is much easier on the network between them because one large message can be transmitted more efficiently than many small ones.

The individual invocations in a batched oneway message are dispatched by a single thread in the order in which they were placed into the batch. This guarantees that the individual operations in a batched oneway message are processed in order in the server.

Batched oneway invocations are particularly useful for messaging services, such as [IceStorm](#), and for fine-grained interfaces that offer `set` operations for small attributes.

Datagram Invocations

Datagram invocations have "best effort" semantics similar to oneway invocations. However, datagram invocations require the object to offer UDP as a transport (whereas oneway invocations require TCP/IP).

Like a oneway invocation, a datagram invocation can be made only if the operation does not have a return value, out-parameters, or user exceptions. A datagram invocation uses UDP to invoke the operation. The operation returns as soon as the local UDP stack has accepted the message; the actual operation invocation is sent asynchronously by the network stack behind the scenes.

Datagrams, like oneway invocations, are unreliable: the target object may not exist in the server, the server may not be running, or the operation may be invoked in the server but fail due to invalid parameters sent by the client. As for oneway invocations, the client receives no notification of such errors.

However, unlike oneway invocations, datagram invocations have a number of additional error scenarios:

- Individual invocations may simply be lost in the network.

This is due to the unreliable delivery of UDP packets. For example, if you invoke three operations in sequence, the middle invocation may be lost. (The same thing cannot happen for oneway invocations — because they are delivered over a connection-oriented transport, individual invocations cannot be lost.)

- Individual invocations may arrive out of order.

Again, this is due to the nature of UDP datagrams. Because each invocation is sent as a separate datagram, and individual datagrams can take different paths through the network, it can happen that invocations arrive in an order that differs from the order in which they were sent.

Datagram invocations are well suited for small messages on LANs, where the likelihood of loss is small. They are also suited to situations in which low latency is more important than reliability, such as for fast, interactive internet applications. Finally, datagram invocations can be used to multicast messages to multiple servers simultaneously.

Batched Datagram Invocations

As for batched oneway invocations, *batched datagram invocations* allow you to accumulate a number of invocations in a buffer and then send the entire buffer as a single datagram by making an API call to flush the buffer. Batched datagrams reduce the overhead of repeated system calls and allow the underlying network to operate more efficiently. However, batched datagram invocations are useful only for batched messages whose total size does not substantially exceed the PDU limit of the network: if the size of a batched datagram gets too large, UDP fragmentation makes it more likely that one or more fragments are lost, which results in the loss of the entire batched message. However, you are guaranteed that either all invocations in a batch will be delivered, or none will be delivered. It is impossible for individual invocations within a batch to be lost.

Batched datagrams use a single thread in the server to dispatch the individual invocations in a batch. This guarantees that the invocations are made in the order in which they were queued — invocations cannot appear to be reordered in the server.

Run-Time Exceptions

Any operation invocation can raise a *run-time exception*. Run-time exceptions are pre-defined by the Ice run time and cover common error conditions, such as connection failure, connection timeout, or resource allocation failure. Run-time exceptions are presented to the application as native exceptions and so integrate neatly with the native exception handling capabilities of languages that support exception handling.

User Exceptions

A server indicates application-specific error conditions by raising *user exceptions* to clients. User exceptions can carry an arbitrary amount of complex data and can be arranged into inheritance hierarchies, which makes it easy for clients to handle categories of errors generically, by catching an exception that is further up the inheritance hierarchy. Like run-time exceptions, user exceptions map to native exceptions.

Properties

Much of the Ice run time is configurable via *properties*. Properties are name-value pairs, such as `Ice.Default.Protocol=tcp`. Properties are typically stored in text files and parsed by the Ice run time to configure various options, such as the thread pool size, the level of tracing, and various other configuration parameters.

See Also

- [The Slice Language](#)
- [Proxies](#)
- [Locators](#)
- [Object Life Cycle](#)
- [Bidirectional Connections](#)
- [Glacier2](#)
- [IceStorm](#)

Slice (Specification Language for Ice)

Each [Ice object](#) has an interface with a number of operations. Interfaces, operations, and the types of data that are exchanged between client and server are defined using the [Slice language](#). Slice allows you to define the client-server contract in a way that is independent of a specific programming language, such as C++, Java, or C#. The Slice definitions are compiled by a compiler into an API for a specific programming language, that is, the part of the API that is specific to the interfaces and types you have defined consists of generated code.

See Also

- [The Slice Language](#)

Language Mappings

The rules that govern how each Slice construct is translated into a specific programming language are known as *language mappings*. For example, for the [C++ mapping](#), a Slice sequence appears as an STL vector, whereas, for the [Java mapping](#), a Slice sequence appears as a Java array. In order to determine what the API for a specific Slice construct looks like, you only need the Slice definition and knowledge of the language mapping rules. The rules are simple and regular enough to make it unnecessary to read the generated code to work out how to use the generated API.

Of course, you are free to peruse the generated code. However, as a rule, that is inefficient because the generated code is not necessarily suitable for human consumption. We recommend that you familiarize yourself with the language mapping rules; that way, you can mostly ignore the generated code and need to refer to it only when you are interested in some specific detail.

Currently, Ice provides language mappings for C++, Java, C#, Python, Objective-C, and, for the client side, PHP and Ruby.

See Also

- [C++ Mapping](#)
- [Java Mapping](#)
- [C# Mapping](#)
- [Objective-C Mapping](#)
- [Python Mapping](#)
- [Ruby Mapping](#)
- [PHP Mapping](#)

Client and Server Structure

Ice clients and servers have the logical internal structure:

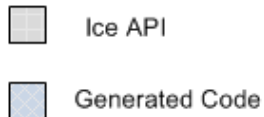
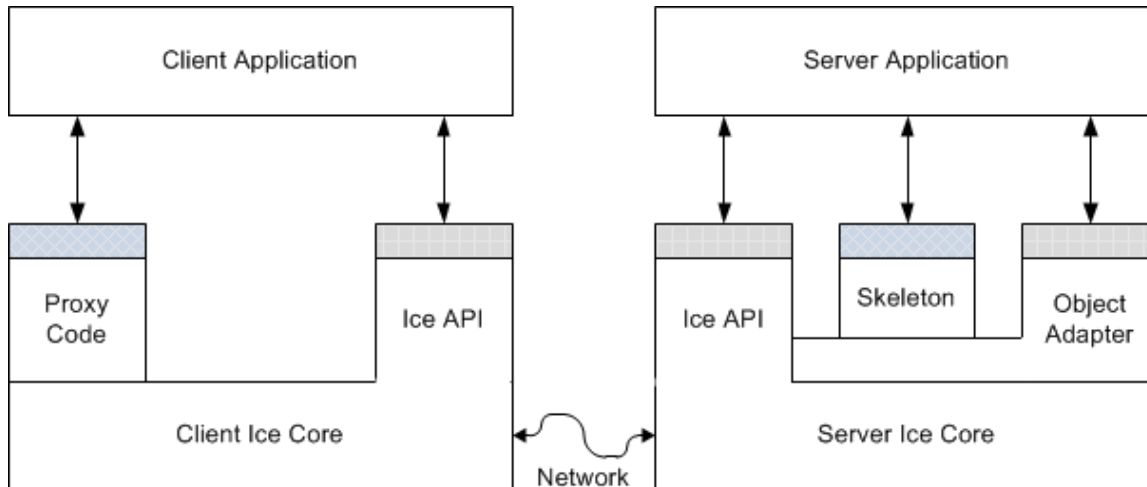

Ice Client and Server Structure

Both client and server consist of a mixture of application code, library code, and code generated from Slice definitions:

- The Ice core contains the client- and server-side run-time support for remote communication. Much of this code is concerned with the details of networking, threading, byte ordering, and many other networking-related issues that we want to keep away from application code. The Ice core is provided as a number of libraries that client and server use.
- The generic part of the Ice core (that is, the part that is independent of the specific types you have defined in Slice) is accessed through the Ice API. You use the Ice API to take care of administrative chores, such as initializing and finalizing the Ice run time. The Ice API is identical for clients and servers (although servers use a larger part of the API than clients).
- The proxy code is generated from your Slice definitions and, therefore, specific to the types of objects and data you have defined in Slice. The proxy code has two major functions:
 - It provides a down-call interface for the client. Calling a function in the generated proxy API ultimately ends up sending an RPC message to the server that invokes a corresponding function on the target object.
 - It provides *marshaling* and *unmarshaling* code. Marshaling is the process of serializing a complex data structure, such as a sequence or a dictionary, for transmission on the wire. The marshaling code converts data into a form that is standardized for transmission and independent of the endian-ness and padding rules of the local machine. Unmarshaling is the reverse of marshaling, that is, deserializing data that arrives over the network and reconstructing a local representation of the data in types that are appropriate for the programming language in use.
- The skeleton code is also generated from your Slice definition and, therefore, specific to the types of objects and data you have defined in Slice. The skeleton code is the server-side equivalent of the client-side proxy code: it provides an up-call interface that permits the Ice run time to transfer the thread of control to the application code you write. The skeleton also contains marshaling and unmarshaling code, so the server can receive parameters sent by the client, and return parameters and exceptions to the client.
- The object adapter is a part of the Ice API that is specific to the server side: only servers use object adapters. An object adapter has several functions:
 - The object adapter maps incoming requests from clients to specific methods on programming-language objects. In other words, the object adapter tracks which servants with what object identity are in memory.
 - The object adapter is associated with one or more transport endpoints. If more than one transport endpoint is associated with an adapter, the servants incarnating objects within the adapter can be reached via multiple transports. For example,

you can associate both a TCP/IP and a UDP endpoint with an adapter, to provide alternate quality-of-service and performance characteristics.

- The object adapter is responsible for the creation of proxies that can be passed to clients. The object adapter knows about the type, identity, and transport details of each of its objects and embeds the correct details when the server-side application code requests the creation of a proxy.

Note that, as far as the process view is concerned, there are only two processes involved: the client and the server. All the run time support for distributed communication is provided by the Ice libraries and the code that is generated from Slice definitions. (For indirect proxies, a third process, [IceGrid](#), is required to resolve proxies to transport endpoints.)

See Also

- [Hello World Application](#)
- [IceGrid](#)

Overview of the Ice Protocol

Ice provides an [RPC protocol](#) that can use either TCP/IP or UDP as an underlying transport. In addition, Ice also allows you to use [SSL](#) as a transport, so all communication between client and server is encrypted.

The Ice protocol defines:

- a number of message types, such as request and reply message types,
- a protocol state machine that determines in what sequence different message types are exchanged by client and server, together with the associated connection establishment and tear-down semantics for TCP/IP,
- encoding rules that determine how each type of data is represented on the wire,
- a header for each message type that contains details such as the message type, the message size, and the protocol and encoding version in use.

Ice also supports compression on the wire: by setting a configuration parameter, you can arrange for all network traffic to be compressed to conserve bandwidth. This is useful if your application exchanges large amounts of data between client and server.

The Ice protocol is suitable for building highly-efficient event forwarding mechanisms because it permits forwarding of a message without knowledge of the details of the information inside a message. This means that messaging switches need not do any unmarshaling and remarshaling of messages — they can forward a message by simply treating it as an opaque buffer of bytes.

The Ice protocol also supports [bidirectional operation](#): if a server wants to send a message to a callback object provided by the client, the callback can be made over the connection that was originally created by the client. This feature is especially important when the client is behind a firewall that permits outgoing connections, but not incoming connections.

See Also

- [The Ice Protocol](#)
- [IceSSL](#)
- [Bidirectional Connections](#)

Ice Services

The Ice core provides a sophisticated client-server platform for distributed application development. However, realistic applications usually require more than just a remoting capability: typically, you also need a way to start servers on demand, distribute proxies to clients, distribute asynchronous events, configure your application, distribute patches for an application, and so on.

Ice ships with a number of services that provide these and other features. The services are implemented as Ice servers to which your application acts as a client. None of the services use Ice-internal features that are hidden from application developers so, in theory, you could develop equivalent services yourself. However, having these services available as part of the platform allows you to focus on application development instead of having to build a lot of infrastructure first. Moreover, building such services is not a trivial effort, so it pays to know what is available and use it instead of reinventing your own wheel.

On this page:

- [Freeze and FreezeScript](#)
- [IceGrid Service](#)
- [IceBox Server](#)
- [IceStorm](#)
- [IcePatch2](#)
- [Glacier2](#)

Freeze and FreezeScript

Ice has a built-in object persistence service, known as *Freeze*. Freeze makes it easy to store object state in a database: you define the state stored by your objects in Slice, and the Freeze compiler generates code that stores and retrieves object state to and from a database. Freeze uses [Berkeley DB](#) as its database.

Ice also offers a tool set collectively called *FreezeScript* that makes it easier to maintain databases and to migrate the contents of existing databases to a new schema if the type definitions of objects change.

IceGrid Service

IceGrid is an implementation of an Ice [location service](#) that resolves the symbolic information in an indirect proxy to a protocol-address pair for indirect binding. A location service is only the beginning of IceGrid's capabilities.

IceGrid:

- allows you to register servers for automatic start-up: instead of requiring a server to be running at the time a client issues a request, IceGrid starts servers on demand, when the first client request arrives.
- provides tools that make it easy to configure complex applications containing several servers.
- supports replication and load-balancing.
- automates the distribution and patching of server executables and dependent files.
- provides a simple query service that allows clients to obtain proxies for objects they are interested in.

IceBox Server

IceBox is a simple application server that can orchestrate the starting and stopping of a number of application components. Application components can be deployed as a dynamic library instead of as a process. This reduces overall system load, for example, by allowing you to run several application components in a single Java virtual machine instead of having multiple processes, each with its own virtual machine.

IceStorm

IceStorm is a publish-subscribe service that decouples clients and servers. Fundamentally, IceStorm acts as a distribution switch for events. Publishers send events to the service, which, in turn, passes the events to subscribers. In this way, a single event published by a publisher can be sent to multiple subscribers. Events are categorized by topic, and subscribers specify the topics they are interested in. Only events that match a subscriber's topic are sent to that subscriber. The service permits selection of a number of quality-of-service criteria to allow applications to choose the appropriate trade-off between reliability and performance.

IceStorm is particularly useful if you have a need to distribute information to large numbers of application components. (A typical example is

a stock ticker application with a large number of subscribers.) IceStorm decouples the publishers of information from subscribers and takes care of the redistribution of the published events. In addition, IceStorm can be run as a *federated* service, that is, multiple instances of the service can be run on different machines to spread the processing load over a number of CPUs.

IcePatch2

[IcePatch2](#) is a software patching service. It allows you to easily distribute software updates to clients. Clients simply connect to the IcePatch2 server and request updates for a particular application. The service automatically checks the version of the client's software and downloads any updated application components in a compressed format to conserve bandwidth. Software patches can be secured using the Glacier2 service, so only authorized clients can download software updates.



IcePatch2 supersedes IcePatch, which was a previous version of this service.

Glacier2

[Glacier2](#) is the Ice firewall traversal service: it allows clients and servers to securely communicate through a firewall without compromising security. Client-server traffic is SSL-encrypted using public key certificates and is bidirectional. Glacier2 offers support for mutual authentication as well as secure session management.



Glacier2 supersedes Glacier, which was a previous version of this service

See Also

- [IceGrid](#)
- [Freeze](#)
- [FreezeScript](#)
- [Glacier2](#)
- [IceBox](#)
- [IceStorm](#)
- [IcePatch2](#)

Architectural Benefits of Ice

The Ice architecture provides a number of benefits to application developers:

- **Object-oriented semantics**
Ice fully preserves the object-oriented paradigm "across the wire." All operation invocations use late binding, so the implementation of an operation is chosen depending on the actual run-time (not static) type of an object.
- **Support for synchronous and asynchronous messaging**
Ice provides both synchronous and asynchronous operation invocation and dispatch, as well as publish-subscribe messaging via IceStorm. This allows you to choose a communication model according to the needs of your application instead of having to shoe-horn the application to fit a single model.
- **Support for multiple interfaces**
With facets, objects can provide multiple, unrelated interfaces while retaining a single object identity across these interfaces. This provides great flexibility, particularly as an application evolves but needs to remain compatible with older, already deployed clients.
- **Machine independence**
Clients and servers are shielded from idiosyncrasies of the underlying machine architecture. Issues such as byte ordering and padding are hidden from application code.
- **Language independence**
Client and server can be developed independently and in different programming languages. The Slice definition used by both client and server establishes the interface contract between them and is the only thing they need to agree on.
- **Implementation independence**
Clients are unaware of how servers implement their objects. This means that the implementation of a server can be changed after clients are deployed, for example, to use a different persistence mechanism or even a different programming language.
- **Operating system independence**
The Ice APIs are fully portable, so the same source code compiles and runs under both Windows and Unix.
- **Threading support**
The Ice run time is fully threaded and APIs are thread-safe. No effort (beyond synchronizing access to shared data) is required on part of the application developer to develop threaded, high-performance clients and servers.
- **Transport independence**
Ice currently offers both TCP/IP and UDP as transport protocols. Neither client nor server code are aware of the underlying transport. (The desired transport can be chosen by a configuration parameter.)
- **Location and server transparency**
The Ice run time takes care of locating objects and managing the underlying transport mechanism, such as opening and closing connections. Interactions between client and server appear connection-less. Via IceGrid, you can arrange for servers to be started on demand if they are not running at the time a client invokes an operation. Servers can be migrated to different physical addresses without breaking proxies held by clients, and clients are completely unaware how object implementations are distributed over server processes.
- **Security**
Communications between client and server can be fully secured with strong encryption over SSL, so applications can use unsecured public networks to communicate securely. Via Glacier2, you can implement secure forwarding of requests through a firewall, with full support for callbacks.
- **Built-in persistence**
With Freeze, creating persistent object implementations becomes trivial. Ice comes with built-in support for [Berkeley DB](#), which is a high-performance database.
- **Source code availability**
The source code for Ice is available. While it is not necessary to have access to the source code to use the platform, it allows you to see how things are implemented or port the code to a new operating system.

Overall, Ice provides a state-of-the art development and deployment environment for distributed computing that is more complete than any other platform we are aware of.

See Also

- [Ice Architecture](#)
- [Ice Services](#)

Hello World Application

This section presents a very simple (but complete) client and server.

Writing an Ice application involves the following steps:

1. Write a Slice definition and compile it.
2. Write a server and compile it.
3. Write a client and compile it.

If someone else has written the server already and you are only writing a client, you do not need to write the Slice definition, only compile it (and, obviously, you do not need to write the server in that case).

The application described here enables remote printing: a client sends the text to be printed to a server, which in turn sends that text to a printer. For simplicity (and because we do not want to concern ourselves with the idiosyncrasies of print spoolers for various platforms), our printer will simply print to a terminal instead of a real printer. This is no great loss: the purpose of the exercise is to show how a client can communicate with a server; once the thread of control has reached the server application code, that code can of course do anything it likes (including sending the text to a real printer). How to do this is independent of Ice and therefore not relevant here.



Much of the detail of the source code will remain unexplained for now. The intent is to show you how to get started and give you a feel for what the development environment looks like; we will provide all the detail throughout the remainder of this manual.

Topics

- [Writing a Slice Definition](#)
- [Writing an Ice Application with C++](#)
- [Writing an Ice Application with Java](#)
- [Writing an Ice Application with C-Sharp](#)
- [Writing an Ice Application with Visual Basic](#)
- [Writing an Ice Application with Objective-C](#)
- [Writing an Ice Application with Python](#)
- [Writing an Ice Application with Ruby](#)
- [Writing an Ice Application with PHP](#)

Writing a Slice Definition

The first step in writing any Ice application is to write a [Slice](#) definition containing the interfaces that are used by the application. For our minimal printing application, we write the following Slice definition:

```

Slice



```
module Demo {
 interface Printer {
 void printString(string s);
 };
};
```

```

We save this text in a file called `Printer.ice`.

Our Slice definitions consist of the module `Demo` containing a single interface called `Printer`. For now, the interface is very simple and provides only a single operation, called `printString`. The `printString` operation accepts a string as its sole input parameter; the text of that string is what appears on the (possibly remote) printer.

See Also

- [The Slice Language](#)

Writing an Ice Application with C++

This page shows how to create an Ice application with C++.

On this page:

- [Compiling a Slice Definition for C++](#)
- [Writing and Compiling a Server in C++](#)
- [Writing and Compiling a Client in C++](#)
- [Running Client and Server in C++](#)

Compiling a Slice Definition for C++

The first step in creating our C++ application is to compile our [Slice definition](#) to generate C++ proxies and skeletons. Under Unix, you can compile the definition as follows:

```
$ slice2cpp Printer.ice
```



Whenever we show Unix commands, we assume a Bourne or Bash shell. The commands for Windows are essentially identical and therefore not shown.

The `slice2cpp` compiler produces two C++ source files from this definition, `Printer.h` and `Printer.cpp`.

- `Printer.h`
The `Printer.h` header file contains C++ type definitions that correspond to the Slice definitions for our `Printer` interface. This header file must be included in both the client and the server source code.
- `Printer.cpp`
The `Printer.cpp` file contains the source code for our `Printer` interface. The generated source contains type-specific run-time support for both clients and servers. For example, it contains code that marshals parameter data (the string passed to the `printString` operation) on the client side and unmarshals that data on the server side. The `Printer.cpp` file must be compiled and linked into both client and server.

Writing and Compiling a Server in C++

The source code for the server takes only a few lines and is shown in full here:

C++

```

#include <Ice/Ice.h>
#include <Printer.h>

using namespace std;
using namespace Demo;

class PrinterI : public Printer {
public:
    virtual void printString(const string& s, const Ice::Current&);
};

void
PrinterI::
printString(const string& s, const Ice::Current&)
{
    cout << s << endl;
}

int
main(int argc, char* argv[])
{
    int status = 0;
    Ice::CommunicatorPtr ic;
    try {
        ic = Ice::initialize(argc, argv);
        Ice::ObjectAdapterPtr adapter =

ic->createObjectAdapterWithEndpoints("SimplePrinterAdapter", "default -
p 10000");
        Ice::ObjectPtr object = new PrinterI;
        adapter->add(object, ic->stringToIdentity("SimplePrinter"));
        adapter->activate();
        ic->waitForShutdown();
    } catch (const Ice::Exception& e) {
        cerr << e << endl;
        status = 1;
    } catch (const char* msg) {
        cerr << msg << endl;
        status = 1;
    }
    if (ic) {
        try {
            ic->destroy();
        } catch (const Ice::Exception& e) {
            cerr << e << endl;
            status = 1;
        }
    }
    return status;
}

```

There appears to be a lot of code here for something as simple as a server that just prints a string. Do not be concerned by this: most of the preceding code is boiler plate that never changes. For this very simple server, the code is dominated by this boiler plate.

Every Ice source file starts with an include directive for `Ice.h`, which contains the definitions for the Ice run time. We also include `Printer.h`, which was generated by the Slice compiler and contains the C++ definitions for our printer interface, and we import the contents of the `std` and `Demo` namespaces for brevity in the code that follows:

```
C++
```

```
#include <Ice/Ice.h>
#include <Printer.h>

using namespace std;
using namespace Demo;
```

Our server implements a single printer servant, of type `PrinterI`. Looking at the generated code in `Printer.h`, we find the following (tidied up a little to get rid of irrelevant detail):

```
C++
```

```
namespace Demo {
    class Printer : virtual public Ice::Object {
    public:
        virtual void printString(const std::string&, const Ice::Current&
= Ice::Current()) = 0;
    };
};
```

The `Printer` skeleton class definition is generated by the Slice compiler. (Note that the `printString` method is pure virtual so the skeleton class cannot be instantiated.) Our servant class inherits from the skeleton class to provide an implementation of the pure virtual `printString` method. (By convention, we use an `I`-suffix to indicate that the class implements an interface.)

```
C++
```

```
class PrinterI : public Printer {
public:
    virtual void printString(const string& s, const Ice::Current&);
};
```

The implementation of the `printString` method is trivial: it simply writes its string argument to `stdout`:

C++

```

void
PrinterI::
printString(const string& s, const Ice::Current&)
{
    cout << s << endl;
}

```

Note that `printString` has a second parameter of type `Ice::Current`. As you can see from the definition of `Printer::printString`, the Slice compiler generates a default argument for this parameter, so we can leave it unused in our implementation. (We will examine the purpose of the `Ice::Current` parameter later.)

What follows is the server main program. Note the general structure of the code:

C++

```

int
main(int argc, char* argv[])
{
    int status = 0;
    Ice::CommunicatorPtr ic;
    try {

        // Server implementation here...

    } catch (const Ice::Exception& e) {
        cerr << e << endl;
        status = 1;
    } catch (const char* msg) {
        cerr << msg << endl;
        status = 1;
    }
    if (ic) {
        try {
            ic->destroy();
        } catch (const Ice::Exception& e) {
            cerr << e << endl;
            status = 1;
        }
    }
    return status;
}

```

The body of `main` contains the declaration of two variables, `status` and `ic`. The `status` variable contains the exit status of the program and the `ic` variable, of type `Ice::CommunicatorPtr`, contains the main handle to the Ice run time.

Following these declarations is a `try` block in which we place all the server code, followed by two `catch` handlers. The first handler catches all exceptions that may be thrown by the Ice run time; the intent is that, if the code encounters an unexpected Ice run-time exception

anywhere, the stack is unwound all the way back to `main`, which prints the exception and then returns failure to the operating system. The second handler catches string constants; the intent is that, if we encounter a fatal error condition somewhere in our code, we can simply throw a string literal with an error message. Again, this unwinds the stack all the way back to `main`, which prints the error message and then returns failure to the operating system.

Following the `try` block, we see a bit of cleanup code that calls the `destroy` method on the communicator (provided that the communicator was initialized). The cleanup call is outside the first `try` block for a reason: we must ensure that the Ice run time is finalized whether the code terminates normally or terminates due to an exception.

 Failure to call `destroy` on the communicator before the program exits results in undefined behavior.

The body of the first `try` block contains the actual server code:

```

C++

    ic = Ice::initialize(argc, argv);
    Ice::ObjectAdapterPtr adapter =

    ic->createObjectAdapterWithEndpoints("SimplePrinterAdapter", "default -
    p 10000");
    Ice::ObjectPtr object = new PrinterI;
    adapter->add(object, ic->stringToIdentity("SimplePrinter"));
    adapter->activate();
    ic->waitForShutdown();

```

The code goes through the following steps:

1. We initialize the Ice run time by calling `Ice::initialize`. (We pass `argc` and `argv` to this call because the server may have command-line arguments that are of interest to the run time; for this example, the server does not require any command-line arguments.) The call to `initialize` returns a smart pointer to an `Ice::Communicator` object, which is the main object in the Ice run time.
2. We create an object adapter by calling `createObjectAdapterWithEndpoints` on the `Communicator` instance. The arguments we pass are `"SimplePrinterAdapter"` (which is the name of the adapter) and `"default -p 10000"`, which instructs the adapter to listen for incoming requests using the default protocol (TCP/IP) at port number 10000.
3. At this point, the server-side run time is initialized and we create a servant for our `Printer` interface by instantiating a `PrinterI` object.
4. We inform the object adapter of the presence of a new servant by calling `add` on the adapter; the arguments to `add` are the servant we have just instantiated, plus an identifier. In this case, the string `"SimplePrinter"` is the name of the servant. (If we had multiple printers, each would have a different name or, more correctly, a different *object identity*.)
5. Next, we activate the adapter by calling its `activate` method. (The adapter is initially created in a holding state; this is useful if we have many servants that share the same adapter and do not want requests to be processed until after all the servants have been instantiated.) The server starts to process incoming requests from clients as soon as the adapter is activated.
6. Finally, we call `waitForShutdown`. This call suspends the calling thread until the server implementation terminates, either by making a call to shut down the run time, or in response to a signal. (For now, we will simply interrupt the server on the command line when we no longer need it.)

Note that, even though there is quite a bit of code here, that code is essentially the same for all servers. You can put that code into a helper class and, thereafter, will not have to bother with it again. (Ice provides such a helper class, called `Ice::Application`.) As far as actual application code is concerned, the server contains only a few lines: six lines for the definition of the `PrinterI` class, plus three lines to instantiate a `PrinterI` object and register it with the object adapter.

Assuming that we have the server code in a file called `Server.cpp`, we can compile it as follows:

```
$ c++ -I. -I$ICE_HOME/include -c Printer.cpp Server.cpp
```

This compiles both our application code and the code that was generated by the Slice compiler. We assume that the `ICE_HOME` environment variable is set to the top-level directory containing the Ice run time. (For example, if you have installed Ice in `/opt/Ice`, set `ICE_HOME` to that path.) Depending on your platform, you may have to add additional include directives or other options to the compiler; please see the demo programs that ship with Ice for the details.

Finally, we need to link the server into an executable:

```
$ c++ -o server Printer.o Server.o -L$ICE_HOME/lib -lIce -lIceUtil
```

Again, depending on the platform, the actual list of libraries you need to link against may be longer. The demo programs that ship with Ice contain all the detail. The important point to note here is that the Ice run time is shipped in two libraries, `libIce` and `libIceUtil`.

Writing and Compiling a Client in C++

The client code looks very similar to the server. Here it is in full:

C++

```

#include <Ice/Ice.h>
#include <Printer.h>

using namespace std;
using namespace Demo;

int
main(int argc, char* argv[])
{
    int status = 0;
    Ice::CommunicatorPtr ic;
    try {
        ic = Ice::initialize(argc, argv);
        Ice::ObjectPrx base = ic->stringToProxy("SimplePrinter:default
-p 10000");
        PrinterPrx printer = PrinterPrx::checkedCast(base);
        if (!printer)
            throw "Invalid proxy";

        printer->printString("Hello World!");
    } catch (const Ice::Exception& ex) {
        cerr << ex << endl;
        status = 1;
    } catch (const char* msg) {
        cerr << msg << endl;
        status = 1;
    }
    if (ic)
        ic->destroy();
    return status;
}

```

Note that the overall code layout is the same as for the server: we include the headers for the Ice run time and the header generated by the Slice compiler, and we use the same `try` block and `catch` handlers to deal with errors.

The code in the `try` block does the following:

1. As for the server, we initialize the Ice run time by calling `Ice::initialize`.
2. The next step is to obtain a proxy for the remote printer. We create a proxy by calling `stringToProxy` on the communicator, with the string `"SimplePrinter:default -p 10000"`. Note that the string contains the object identity and the port number that were used by the server. (Obviously, hard-coding object identities and port numbers into our applications is a bad idea, but it will do for now; we will see more architecturally sound ways of doing this when we discuss [IceGrid](#).)
3. The proxy returned by `stringToProxy` is of type `Ice::ObjectPrx`, which is at the root of the inheritance tree for interfaces and classes. But to actually talk to our printer, we need a proxy for a `Printer` interface, not an `Object` interface. To do this, we need to do a down-cast by calling `PrinterPrx::checkedCast`. A checked cast sends a message to the server, effectively asking "is this a proxy for a `Printer` interface?" If so, the call returns a proxy to a `Printer`; otherwise, if the proxy denotes an interface of some other type, the call returns a null proxy.
4. We test that the down-cast succeeded and, if not, throw an error message that terminates the client.
5. We now have a live proxy in our address space and can call the `printString` method, passing it the time-honored "Hello

World!" string. The server prints that string on its terminal.

Compiling and linking the client looks much the same as for the server:

```
$ g++ -I. -I$ICE_HOME/include -c Printer.cpp Client.cpp
$ g++ -o client Printer.o Client.o -L$ICE_HOME/lib -lIce -lIceUtil
```

Running Client and Server in C++

To run client and server, we first start the server in a separate window:

```
$ ./server
```

At this point, we won't see anything because the server simply waits for a client to connect to it. We run the client in a different window:

```
$ ./client
$
```

The client runs and exits without producing any output; however, in the server window, we see the "Hello World!" that is produced by the printer. To get rid of the server, we interrupt it on the command line for now. (We will see cleaner ways to terminate a server in our discussion of [Ice::Application](#).)

If anything goes wrong, the client will print an error message. For example, if we run the client without having first started the server, we get:

```
Network.cpp:471: Ice::ConnectFailedException:
connect failed: Connection refused
```

Note that, to successfully run client and server, you will have to set some platform-dependent environment variables. For example, under Linux, you need to add the Ice library directory to your `LD_LIBRARY_PATH`. Please have a look at the demo applications that ship with Ice for the details for your platform.

See Also

- [Client-Side Slice-to-C++ Mapping](#)
- [Server-Side Slice-to-C++ Mapping](#)
- [The Ice::Application Class](#)
- [The Current Object](#)
- [IceGrid](#)

Writing an Ice Application with Java

This page shows how to create an Ice application with Java.

On this page:

- [Compiling a Slice Definition for Java](#)
- [Writing and Compiling a Server in Java](#)
- [Writing and Compiling a Client in Java](#)
- [Running Client and Server in Java](#)

Compiling a Slice Definition for Java

The first step in creating our Java application is to compile our [Slice definition](#) to generate Java proxies and skeletons. Under Unix, you can compile the definition as follows:

```
$ mkdir generated
$ slice2java --output-dir generated Printer.ice
```



Whenever we show Unix commands, we assume a Bourne or Bash shell. The commands for Windows are essentially identical and therefore not shown.

The `--output-dir` option instructs the compiler to place the generated files into the `generated` directory. This avoids cluttering the working directory with the generated files. The `slice2java` compiler produces a number of Java source files from this definition. The exact contents of these files do not concern us for now — they contain the generated code that corresponds to the `Printer` interface we defined in `Printer.ice`.

Writing and Compiling a Server in Java

To implement our `Printer` interface, we must create a servant class. By convention, a servant class uses the name of its interface with an `I`-suffix, so our servant class is called `PrinterI` and placed into a source file `PrinterI.java`:

```

Java
public class PrinterI extends Demo._PrinterDisp {
    public void
    printString(String s, Ice.Current current)
    {
        System.out.println(s);
    }
}

```

The `PrinterI` class inherits from a base class called `_PrinterDisp`, which is generated by the `slice2java` compiler. The base class is abstract and contains a `printString` method that accepts a string for the printer to print and a parameter of type `Ice.Current`. (For now we will ignore the `Ice.Current` parameter.) Our implementation of the `printString` method simply writes its argument to the terminal.

The remainder of the server code is in a source file called `Server.java`, shown in full here:

Java

```

public class Server {
    public static void
    main(String[] args)
    {
        int status = 0;
        Ice.Communicator ic = null;
        try {
            ic = Ice.Util.initialize(args);
            Ice.ObjectAdapter adapter =
                ic.createObjectAdapterWithEndpoints("SimplePrinterAdapt
er", "default -p 10000");
            Ice.Object object = new PrinterI();
            adapter.add(object, ic.stringToIdentity("SimplePrinter"));
            adapter.activate();
            ic.waitForShutdown();
        } catch (Ice.LocalException e) {
            e.printStackTrace();
            status = 1;
        } catch (Exception e) {
            System.err.println(e.getMessage());
            status = 1;
        }
        if (ic != null) {
            // Clean up
            //
            try {
                ic.destroy();
            } catch (Exception e) {
                System.err.println(e.getMessage());
                status = 1;
            }
        }
        System.exit(status);
    }
}

```

Note the general structure of the code:

Java

```

public class Server {
    public static void
    main(String[] args)
    {
        int status = 0;
        Ice.Communicator ic = null;
        try {

            // Server implementation here...

        } catch (Ice.LocalException e) {
            e.printStackTrace();
            status = 1;
        } catch (Exception e) {
            System.err.println(e.getMessage());
            status = 1;
        }
        if (ic != null) {
            // Clean up
            //
            try {
                ic.destroy();
            } catch (Exception e) {
                System.err.println(e.getMessage());
                status = 1;
            }
        }
        System.exit(status);
    }
}

```

The body of `main` contains a `try` block in which we place all the server code, followed by two `catch` blocks. The first block catches all exceptions that may be thrown by the Ice run time; the intent is that, if the code encounters an unexpected Ice run-time exception anywhere, the stack is unwound all the way back to `main`, which prints the exception and then returns failure to the operating system. The second block catches `Exception` exceptions; the intent is that, if we encounter a fatal error condition somewhere in our code, we can simply throw an exception with an error message. Again, this unwinds the stack all the way back to `main`, which prints the error message and then returns failure to the operating system.

Before the code exits, it destroys the communicator (if one was created successfully). Doing this is essential in order to correctly finalize the Ice run time: the program *must* call `destroy` on any communicator it has created; otherwise, undefined behavior results.

The body of our `try` block contains the actual server code:

Java

```

ic = Ice.Util.initialize(args);
Ice.ObjectAdapter adapter =
    ic.createObjectAdapterWithEndpoints("SimplePrinterAdapter",
    "default -p 10000");
Ice.Object object = new PrinterI();
adapter.add(object, ic.stringToIdentity("SimplePrinter"));
adapter.activate();
ic.waitForShutdown();

```

The code goes through the following steps:

1. We initialize the Ice run time by calling `Ice.Util.initialize`. (We pass `args` to this call because the server may have command-line arguments that are of interest to the run time; for this example, the server does not require any command-line arguments.) The call to `initialize` returns an `Ice.Communicator` reference, which is the main object in the Ice run time.
2. We create an object adapter by calling `createObjectAdapterWithEndpoints` on the `Communicator` instance. The arguments we pass are `"SimplePrinterAdapter"` (which is the name of the adapter) and `"default -p 10000"`, which instructs the adapter to listen for incoming requests using the default protocol (TCP/IP) at port number 10000.
3. At this point, the server-side run time is initialized and we create a servant for our `Printer` interface by instantiating a `PrinterI` object.
4. We inform the object adapter of the presence of a new servant by calling `add` on the adapter; the arguments to `add` are the servant we have just instantiated, plus an identifier. In this case, the string `"SimplePrinter"` is the name of the servant. (If we had multiple printers, each would have a different name or, more correctly, a different *object identity*.)
5. Next, we activate the adapter by calling its `activate` method. (The adapter is initially created in a holding state; this is useful if we have many servants that share the same adapter and do not want requests to be processed until after all the servants have been instantiated.)
6. Finally, we call `waitForShutdown`. This call suspends the calling thread until the server implementation terminates, either by making a call to shut down the run time, or in response to a signal. (For now, we will simply interrupt the server on the command line when we no longer need it.)

Note that, even though there is quite a bit of code here, that code is essentially the same for all servers. You can put that code into a helper class and, thereafter, will not have to bother with it again. (Ice provides such a helper class, called `Ice.Application`.) As far as actual application code is concerned, the server contains only a few lines: seven lines for the definition of the `PrinterI` class, plus three lines to instantiate a `PrinterI` object and register it with the object adapter.

We can compile the server code as follows:

```

$ mkdir classes
$ javac -d classes -classpath classes:$ICE_HOME/lib/Ice.jar \
  Server.java PrinterI.java generated/Demo/*.java

```

This compiles both our application code and the code that was generated by the Slice compiler. We assume that the `ICE_HOME` environment variable is set to the top-level directory containing the Ice run time. (For example, if you have installed Ice in `/opt/Ice`, set `ICE_HOME` to that path.) Note that Ice for Java uses the `ant` build environment to control building of source code. (`ant` is similar to `make`, but more flexible for Java applications.) You can have a look at the demo code that ships with Ice to see how to use this tool.

Writing and Compiling a Client in Java

The client code, in `Client.java`, looks very similar to the server. Here it is in full:

```

public class Client {
    public static void
    main(String[] args)
    {
        int status = 0;
        Ice.Communicator ic = null;
        try {
            ic = Ice.Util.initialize(args);
            Ice.ObjectPrx base = ic.stringToProxy("SimplePrinter:default
t -p 10000");
            Demo.PrinterPrx printer
= Demo.PrinterPrxHelper.checkedCast(base);
            if (printer == null)
                throw new Error("Invalid proxy");

            printer.printString("Hello World!");
        } catch (Ice.LocalException e) {
            e.printStackTrace();
            status = 1;
        } catch (Exception e) {
            System.err.println(e.getMessage());
            status = 1;
        }
        if (ic != null) {
            // Clean up
            //
            try {
                ic.destroy();
            } catch (Exception e) {
                System.err.println(e.getMessage());
                status = 1;
            }
        }
        System.exit(status);
    }
}

```

Note that the overall code layout is the same as for the server: we use the same `try` and `catch` blocks to deal with errors. The code in the `try` block does the following:

1. As for the server, we initialize the Ice run time by calling `Ice.Util.initialize`.
2. The next step is to obtain a proxy for the remote printer. We create a proxy by calling `stringToProxy` on the communicator, with the string `"SimplePrinter:default -p 10000"`. Note that the string contains the object identity and the port number that were used by the server. (Obviously, hard-coding object identities and port numbers into our applications is a bad idea, but it will do for now; we will see more architecturally sound ways of doing this when we discuss [IceGrid](#).)
3. The proxy returned by `stringToProxy` is of type `Ice.ObjectPrx`, which is at the root of the inheritance tree for interfaces and classes. But to actually talk to our printer, we need a proxy for a `Printer` interface, not an `Object` interface. To do this, we need to

do a down-cast by calling `PrinterPrxHelper.checkedCast`. A checked cast sends a message to the server, effectively asking "is this a proxy for a `Printer` interface?" If so, the call returns a proxy of type `Demo::Printer`; otherwise, if the proxy denotes an interface of some other type, the call returns null.

4. We test that the down-cast succeeded and, if not, throw an error message that terminates the client.
5. We now have a live proxy in our address space and can call the `printString` method, passing it the time-honored "Hello World!" string. The server prints that string on its terminal.

Compiling the client looks much the same as for the server:

```
$ javac -d classes -classpath classes:$ICE_HOME/lib/Ice.jar \
Client.java PrinterI.java generated/Demo/*.java
```

Running Client and Server in Java

To run client and server, we first start the server in a separate window:

```
$ java Server
```

At this point, we won't see anything because the server simply waits for a client to connect to it. We run the client in a different window:

```
$ java Client
$
```

The client runs and exits without producing any output; however, in the server window, we see the "Hello World!" that is produced by the printer. To get rid of the server, we interrupt it on the command line for now. (We will see cleaner ways to terminate a server in our discussion of [Ice.Application](#).)

If anything goes wrong, the client will print an error message. For example, if we run the client without having first started the server, we get something like the following:

```
Ice.ConnectionRefusedException
    error = 0
    at
IceInternal.ConnectRequestHandler.getConnection(ConnectRequestHandler.j
ava:240)
    at
IceInternal.ConnectRequestHandler.sendRequest(ConnectRequestHandler.jav
a:138)
    at IceInternal.Outgoing.invoke(Outgoing.java:66)
    at Ice._ObjectDelM.ice_isA(_ObjectDelM.java:30)
    at Ice.ObjectPrxHelperBase.ice_isA(ObjectPrxHelperBase.java:111)
    at Ice.ObjectPrxHelperBase.ice_isA(ObjectPrxHelperBase.java:77)
    at Demo.HelloPrxHelper.checkedCast(HelloPrxHelper.java:228)
    at Client.run(Client.java:65)
Caused by: java.net.ConnectException: Connection refused
    ...
```

Note that, to successfully run client and server, your `CLASSPATH` must include the Ice library and the classes directory, for example:

```
$ export CLASSPATH=$CLASSPATH:./classes:$ICE_HOME/lib/Ice.jar
```

Please have a look at the demo applications that ship with Ice for the details for your platform.

See Also

- [Client-Side Slice-to-Java Mapping](#)
- [Server-Side Slice-to-Java Mapping](#)
- [The `Ice.Application` Class](#)
- [The Current Object](#)
- [IceGrid](#)

Writing an Ice Application with C-Sharp

This page shows how to create an Ice application with C#.

On this page:

- [Compiling a Slice Definition for C#](#)
- [Writing and Compiling a Server in C#](#)
- [Writing and Compiling a Client in C#](#)
- [Running Client and Server in C#](#)

Compiling a Slice Definition for C#

The first step in creating our C# application is to compile our `Slice` definition to generate C# proxies and skeletons. You can compile the definition as follows:

```
$ mkdir generated
$ slice2cs --output-dir generated Printer.ice
```



Whenever we show Unix commands, we assume a Bourne or Bash shell. The commands for Windows are essentially identical and therefore not shown.

The `--output-dir` option instructs the compiler to place the generated files into the `generated` directory. This avoids cluttering the working directory with the generated files. The `slice2cs` compiler produces a single source file, `Printer.cs`, from this definition. The exact contents of this file do not concern us for now — it contains the generated code that corresponds to the `Printer` interface we defined in `Printer.ice`.

Writing and Compiling a Server in C#

To implement our `Printer` interface, we must create a servant class. By convention, a servant class uses the name of its interface with an `I`-suffix, so our servant class is called `PrinterI` and placed into a source file `Server.cs`:

```
C#
```

```
using System;

public class PrinterI : Demo.PrinterDisp_
{
    public override void printString(string s, Ice.Current current)
    {
        Console.WriteLine(s);
    }
}
```

The `PrinterI` class inherits from a base class called `PrinterDisp_`, which is generated by the `slice2cs` compiler. The base class is abstract and contains a `printString` method that accepts a string for the printer to print and a parameter of type `Ice.Current`. (For now we will ignore the `Ice.Current` parameter.) Our implementation of the `printString` method simply writes its argument to the terminal.

The remainder of the server code follows in `Server.cs` and is shown in full here:

C#

```

public class Server
{
    public static void Main(string[] args)
    {
        int status = 0;
        Ice.Communicator ic = null;
        try {
            ic = Ice.Util.initialize(ref args);
            Ice.ObjectAdapter adapter =
                ic.createObjectAdapterWithEndpoints("SimplePrinterAdapt
er", "default -p 10000");
            Ice.Object obj = new PrinterI();
            adapter.add(obj, ic.stringToIdentity("SimplePrinter"));
            adapter.activate();
            ic.waitForShutdown();
        } catch (Exception e) {
            Console.Error.WriteLine(e);
            status = 1;
        }
        if (ic != null) {
            // Clean up
            //
            try {
                ic.destroy();
            } catch (Exception e) {
                Console.Error.WriteLine(e);
                status = 1;
            }
        }
        Environment.Exit(status);
    }
}

```

Note the general structure of the code:

C#

```

public class Server
{
    public static void Main(string[] args)
    {
        int status = 0;
        Ice.Communicator ic = null;
        try {

            // Server implementation here...

        } catch (Exception e) {
            Console.Error.WriteLine(e);
            status = 1;
        }
        if (ic != null) {
            // Clean up
            //
            try {
                ic.destroy();
            } catch (Exception e) {
                Console.Error.WriteLine(e);
                status = 1;
            }
        }
        Environment.Exit(status);
    }
}

```

The body of `Main` contains a `try` block in which we place all the server code, followed by a `catch` block. The catch block catches all exceptions that may be thrown by the code; the intent is that, if the code encounters an unexpected run-time exception anywhere, the stack is unwound all the way back to `Main`, which prints the exception and then returns failure to the operating system.

Before the code exits, it destroys the communicator (if one was created successfully). Doing this is essential in order to correctly finalize the Ice run time: the program *must* call `destroy` on any communicator it has created; otherwise, undefined behavior results.

The body of our `try` block contains the actual server code:

C#

```

        ic = Ice.Util.initialize(ref args);
        Ice.ObjectAdapter adapter =
            ic.createObjectAdapterWithEndpoints("SimplePrinterAdapter", "default -p 10000");
        Ice.Object obj = new PrinterI();
        adapter.add(obj, ic.stringToIdentity("SimplePrinter"));
        adapter.activate();
        ic.waitForShutdown();

```

The code goes through the following steps:

1. We initialize the Ice run time by calling `Ice.Util.initialize`. (We pass `args` to this call because the server may have command-line arguments that are of interest to the run time; for this example, the server does not require any command-line arguments.) The call to `initialize` returns an `Ice.Communicator` reference, which is the main object in the Ice run time.
2. We create an object adapter by calling `createObjectAdapterWithEndpoints` on the `Communicator` instance. The arguments we pass are `"SimplePrinterAdapter"` (which is the name of the adapter) and `"default -p 10000"`, which instructs the adapter to listen for incoming requests using the default protocol (TCP/IP) at port number 10000.
3. At this point, the server-side run time is initialized and we create a servant for our `Printer` interface by instantiating a `PrinterI` object.
4. We inform the object adapter of the presence of a new servant by calling `add` on the adapter; the arguments to `add` are the servant we have just instantiated, plus an identifier. In this case, the string `"SimplePrinter"` is the name of the servant. (If we had multiple printers, each would have a different name or, more correctly, a different *object identity*.)
5. Next, we activate the adapter by calling its `activate` method. (The adapter is initially created in a holding state; this is useful if we have many servants that share the same adapter and do not want requests to be processed until after all the servants have been instantiated.)
6. Finally, we call `waitForShutdown`. This call suspends the calling thread until the server implementation terminates, either by making a call to shut down the run time, or in response to a signal. (For now, we will simply interrupt the server on the command line when we no longer need it.)

Note that, even though there is quite a bit of code here, that code is essentially the same for all servers. You can put that code into a helper class and, thereafter, will not have to bother with it again. (Ice provides such a helper class, called `Ice.Application`.) As far as actual application code is concerned, the server contains only a few lines: seven lines for the definition of the `PrinterI` class, plus three lines to instantiate a `PrinterI` object and register it with the object adapter.

We can compile the server code as follows:

```
$ csc /reference:Ice.dll /lib:%ICE_HOME%\bin Server.cs
generated\Printer.cs
```

This compiles both our application code and the code that was generated by the Slice compiler. We assume that the `ICE_HOME` environment variable is set to the top-level directory containing the Ice run time. (For example, if you have installed Ice in `C:\Ice`, set `ICE_HOME` to that path.)

Writing and Compiling a Client in C#

The client code, in `Client.cs`, looks very similar to the server.

Here it is in full:

C#

```

using System;
using Demo;

public class Client
{
    public static void Main(string[] args)
    {
        int status = 0;
        Ice.Communicator ic = null;
        try {
            ic = Ice.Util.initialize(ref args);
            Ice.ObjectPrx obj = ic.stringToProxy("SimplePrinter:default
-p 10000");
            PrinterPrx printer = PrinterPrxHelper.checkedCast(obj);
            if (printer == null)
                throw new ApplicationException("Invalid proxy");

            printer.printString("Hello World!");
        } catch (Exception e) {
            Console.Error.WriteLine(e);
            status = 1;
        }
        if (ic != null) {
            // Clean up
            //
            try {
                ic.destroy();
            } catch (Exception e) {
                Console.Error.WriteLine(e);
                status = 1;
            }
        }
        Environment.Exit(status);
    }
}

```

Note that the overall code layout is the same as for the server: we use the same `try` and `catch` blocks to deal with errors. The code in the `try` block does the following:

1. As for the server, we initialize the Ice run time by calling `Ice.Util.initialize`.
2. The next step is to obtain a proxy for the remote printer. We create a proxy by calling `stringToProxy` on the communicator, with the string `"SimplePrinter:default -p 10000"`. Note that the string contains the object identity and the port number that were used by the server. (Obviously, hard-coding object identities and port numbers into our applications is a bad idea, but it will do for now; we will see more architecturally sound ways of doing this when we discuss `IceGrid`.)
3. The proxy returned by `stringToProxy` is of type `Ice.ObjectPrx`, which is at the root of the inheritance tree for interfaces and classes. But to actually talk to our printer, we need a proxy for a `Printer` interface, not an `Object` interface. To do this, we need to

do a down-cast by calling `PrinterPrxHelper.checkedCast`. A checked cast sends a message to the server, effectively asking "is this a proxy for a `Printer` interface?" If so, the call returns a proxy of type `Demo::Printer`; otherwise, if the proxy denotes an interface of some other type, the call returns null.

4. We test that the down-cast succeeded and, if not, throw an error message that terminates the client.
5. We now have a live proxy in our address space and can call the `printString` method, passing it the time-honored "Hello World!" string. The server prints that string on its terminal.

Compiling the client looks much the same as for the server:

```
$ csc /reference:Ice.dll /lib:%ICE_HOME%\bin Client.cs
generated\Printer.cs
```

Running Client and Server in C#

To run client and server, we first start the server in a separate window:

```
$ server.exe
```

At this point, we won't see anything because the server simply waits for a client to connect to it. We run the client in a different window:

```
$ client.exe
$
```

The client runs and exits without producing any output; however, in the server window, we see the "Hello World!" that is produced by the printer. To get rid of the server, we interrupt it on the command line for now. (We will see cleaner ways to terminate a server in our discussion of [Ice.Application](#).)

If anything goes wrong, the client will print an error message. For example, if we run the client without having first started the server, we get something like the following:

```
Ice.ConnectionRefusedException
  error = 0
  at IceInternal.ProxyFactory.checkRetryAfterException(LocalException
ex, Reference ref, Int32 cnt)
  at Ice.ObjectPrxHelperBase.handleException__(ObjectDel_ delegate, Lo
calException ex, Int32 cnt)
  at Ice.ObjectPrxHelperBase.ice_isA(String id__, Dictionary`2 context
__, Boolean explicitContext__)
  at Ice.ObjectPrxHelperBase.ice_isA(String id__)
  at Demo.PrinterPrxHelper.checkedCast(ObjectPrx b)
  at Client.Main(String[] args)
Caused by: System.ComponentModel.Win32Exception: No connection could be
made because the target machine actively refused
it
```

Note that, to successfully run client and server, the C# run time must be able to locate the `Ice.dll` library. (Under Windows, one way to ensure this is to copy the library into the current directory. Please consult the documentation for your C# run time to see how it locates libraries.)

See Also

- [Client-Side Slice-to-C-Sharp Mapping](#)
- [Server-Side Slice-to-C-Sharp Mapping](#)
- [The `Ice.Application` Class](#)
- [The Current Object](#)
- [IceGrid](#)

Writing an Ice Application with Visual Basic

This page shows how to create an Ice application with Visual Basic.

On this page:

- [Visual Basic Development Process](#)
- [Compiling a Slice Definition for Visual Basic](#)
- [Writing and Compiling a Server in Visual Basic](#)
- [Writing and Compiling a Client in Visual Basic](#)
- [Running Client and Server in Visual Basic](#)

Visual Basic Development Process

As of version 3.3, Ice no longer includes a separate compiler to create Visual Basic source code from Slice definitions. Instead, you need to use the Slice-to-C# compiler `slice2cs` to create C# source code and compile the generated C# source code with a C# compiler into a DLL that contains the compiled generated code for your Slice definitions. Your Visual Basic application then links with this DLL and the Ice for .NET DLL (`Ice.dll`).

i This approach works not only with Visual Basic, but with any language that targets the .NET run time. However, ZeroC does not provide support for languages other than C# and Visual Basic.

The following illustration demonstrates this development process:

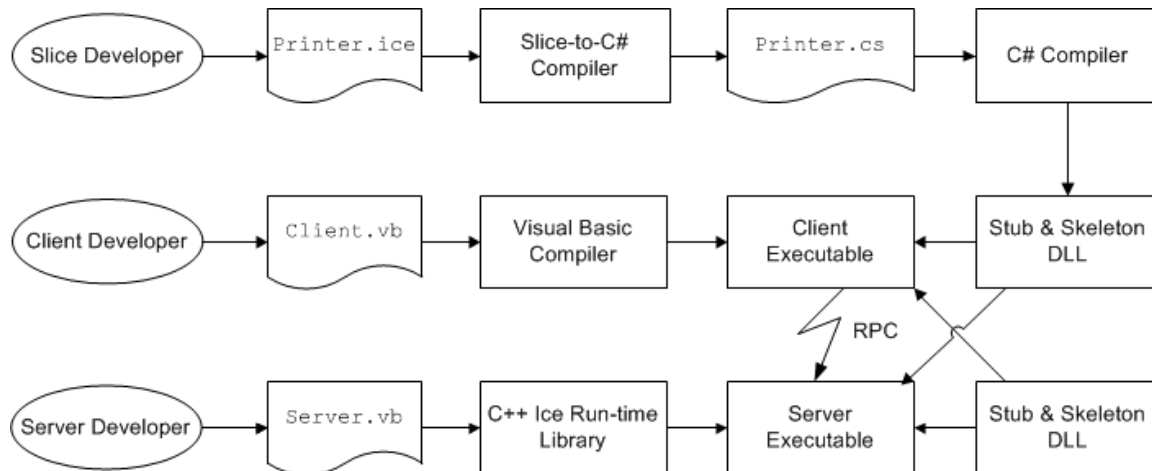

Developing a Visual Basic application with Ice.

Compiling a Slice Definition for Visual Basic

The first step in creating our VB application is to compile our [Slice definition](#) to generate proxies and skeletons. You can compile the definition as follows:

```
> mkdir generated
> slice2cs --output-dir generated Printer.ice
```

The `--output-dir` option instructs the compiler to place the generated files into the `generated` directory. This avoids cluttering the working directory with the generated files. The `slice2cs` compiler produces a single source file, `Printer.cs`, from this definition. The exact contents of this file do not concern us for now — it contains the generated code that corresponds to the `Printer` interface we defined in `Printer.ice`.

We now need to compile this generated code into a DLL:

```
> csc /reference:Ice.dll /lib:%ICE_HOME%\bin /t:library /out:Printer.dll
generated\Printer.cs
```

This creates a DLL called `Printer.dll` that contains the code we generated from the Slice definitions.

Writing and Compiling a Server in Visual Basic

To implement our `Printer` interface, we must create a servant class. By convention, a servant class uses the name of its interface with an `I`-suffix, so our servant class is called `PrinterI` and placed into a source file `Server.vb`:

```

Visual Basic

Imports System
Imports Demo

Public Class PrinterI
    Inherits PrinterDisp_

    Public Overloads Overrides Sub printString( _
        ByVal s As String, _
        ByVal current As Ice.Current)

        Console.WriteLine(s)
    End Sub

End Class
```

The `PrinterI` class inherits from a base class called `PrinterDisp_`, which is generated by the `slice2cs` compiler. The base class is abstract and contains a `printString` method that accepts a string for the printer to print and a parameter of type `Ice.Current`. (For now we will ignore the `Ice.Current` parameter.) Our implementation of the `printString` method simply writes its argument to the terminal.

The remainder of the server code follows in `Server.vb` and is shown in full here:

Visual Basic

Module Server

```

Public Sub Main(ByVal args() As String)

    Dim status As Integer = 0
    Dim ic As Ice.Communicator = Nothing
    Try
        ic = Ice.Util.initialize(args)
        Dim adapter As Ice.ObjectAdapter = _
            ic.createObjectAdapterWithEndpoints("SimplePrinterAdapt
er", "default -p 10000")
        Dim obj As Ice.Object = New PrinterI
        adapter.add(obj, ic.stringToIdentity("SimplePrinter"))
        adapter.activate()
        ic.waitForShutdown()
    Catch e As Exception
        Console.Error.WriteLine(e)
        status = 1
    End Try
    If Not ic Is Nothing Then
        ' Clean up
        '
        Try
            ic.destroy()
        Catch e As Exception
            Console.Error.WriteLine(e)
            status = 1
        End Try
    End If
    Environment.Exit(status)
End Sub

End module

```

Note the general structure of the code:

Visual Basic

Module Server

```

Public Sub Main(ByVal args() As String)

    Dim status As Integer = 0
    Dim ic As Ice.Communicator = Nothing
    Try

        ' Server implementation here...

    Catch e As Exception
        Console.Error.WriteLine(e)
        status = 1
    End Try
    If Not ic Is Nothing Then
        ' Clean up
        '
        Try
            ic.destroy()
        Catch e As Exception
            Console.Error.WriteLine(e)
            status = 1
        End Try
    End If
    Environment.Exit(status)
End Sub

End module

```

The body of `Main` contains a `Try` block in which we place all the server code, followed by a `Catch` block. The catch block catches all exceptions that may be thrown by the code; the intent is that, if the code encounters an unexpected run-time exception anywhere, the stack is unwound all the way back to `Main`, which prints the exception and then returns failure to the operating system.

Before the code exits, it destroys the communicator (if one was created successfully). Doing this is essential in order to correctly finalize the Ice run time: the program *must* call `destroy` on any communicator it has created; otherwise, undefined behavior results.

The body of our `Try` block contains the actual server code:

Visual Basic

```

ic = Ice.Util.initialize(args)
Dim adapter As Ice.ObjectAdapter = _
    ic.createObjectAdapterWithEndpoints("SimplePrinterAdapter", "default -p 10000")
Dim obj As Ice.Object = New PrinterI
adapter.add(obj, ic.stringToIdentity("SimplePrinter"))
adapter.activate()
ic.waitForShutdown()

```

The code goes through the following steps:

1. We initialize the Ice run time by calling `Ice.Util.initialize`. (We pass `args` to this call because the server may have command-line arguments that are of interest to the run time; for this example, the server does not require any command-line arguments.) The call to `initialize` returns an `Ice::Communicator` reference, which is the main object in the Ice run time.
2. We create an object adapter by calling `createObjectAdapterWithEndpoints` on the `Communicator` instance. The arguments we pass are `"SimplePrinterAdapter"` (which is the name of the adapter) and `"default -p 10000"`, which instructs the adapter to listen for incoming requests using the default protocol (TCP/IP) at port number 10000.
3. At this point, the server-side run time is initialized and we create a servant for our `Printer` interface by instantiating a `PrinterI` object.
4. We inform the object adapter of the presence of a new servant by calling `add` on the adapter; the arguments to `add` are the servant we have just instantiated, plus an identifier. In this case, the string `"SimplePrinter"` is the name of the servant. (If we had multiple printers, each would have a different name or, more correctly, a different *object identity*.)
5. Next, we activate the adapter by calling its `activate` method. (The adapter is initially created in a holding state; this is useful if we have many servants that share the same adapter and do not want requests to be processed until after all the servants have been instantiated.)
6. Finally, we call `waitForShutdown`. This call suspends the calling thread until the server implementation terminates, either by making a call to shut down the run time, or in response to a signal. (For now, we will simply interrupt the server on the command line when we no longer need it.)

Note that, even though there is quite a bit of code here, that code is essentially the same for all servers. You can put that code into a helper class and, thereafter, will not have to bother with it again. (Ice provides such a helper class, called `Ice.Application`.) As far as actual application code is concerned, the server contains only a few lines: ten lines for the definition of the `PrinterI` class, plus three lines to instantiate a `PrinterI` object and register it with the object adapter.

We can compile the server code as follows:

```

> vbc /reference:Ice.dll /libpath:%ICE_HOME%\bin /reference:Printer.dll
/out:server.exe Server.vb

```

This compiles our application code and links it with the Ice run time and the DLL we generated earlier. We assume that the `ICE_HOME` environment variable is set to the top-level directory containing the Ice run time. (For example, if you have installed Ice in `C:\Ice`, set `ICE_HOME` to that path.)

Writing and Compiling a Client in Visual Basic

The client code, in `Client.vb`, looks very similar to the server. Here it is in full:

Visual Basic

```
Imports System
Imports Demo

Module Client

    Public Sub Main(ByVal args() As String)
        Dim status As Integer = 0
        Dim ic As Ice.Communicator = Nothing
        Try
            ic = Ice.Util.initialize(args)
            Dim obj As Ice.ObjectPrx = ic.stringToProxy("SimplePrinter:
default -p 10000")
            Dim printer As PrinterPrx = PrinterPrxHelper.checkedCast(obj)

            If printer Is Nothing Then
                Throw New ApplicationException("Invalid proxy")
            End If

            printer.printString("Hello World!")
        Catch e As Exception
            Console.Error.WriteLine(e)
            status = 1
        End Try
        If Not ic Is Nothing Then
            ' Clean up
            '
            Try
                ic.destroy()
            Catch e As Exception
                Console.Error.WriteLine(e)
                status = 1
            End Try
        End If
        Environment.Exit(status)
    End Sub

End Module
```

Note that the overall code layout is the same as for the server: we use the same `Try` and `Catch` blocks to deal with errors. The code in the `Try` block does the following:

1. As for the server, we initialize the Ice run time by calling `Ice.Util.initialize`.
2. The next step is to obtain a proxy for the remote printer. We create a proxy by calling `stringToProxy` on the communicator, with the string `"SimplePrinter:default -p 10000"`. Note that the string contains the object identity and the port number that were used by the server. (Obviously, hard-coding object identities and port numbers into our applications is a bad idea, but it will do for now; we will see more architecturally sound ways of doing this when we discuss [IceGrid](#).)
3. The proxy returned by `stringToProxy` is of type `Ice.ObjectPrx`, which is at the root of the inheritance tree for interfaces and classes. But to actually talk to our printer, we need a proxy for a `Printer` interface, not an `Object` interface. To do this, we need to

do a down-cast by calling `PrinterPrxHelper.checkedCast`. A checked cast sends a message to the server, effectively asking "is this a proxy for a `Printer` interface?" If so, the call returns a proxy of type `Demo::Printer`; otherwise, if the proxy denotes an interface of some other type, the call returns null.

4. We test that the down-cast succeeded and, if not, throw an error message that terminates the client.
5. We now have a live proxy in our address space and can call the `printString` method, passing it the time-honored "Hello World!" string. The server prints that string on its terminal.

Compiling the client looks much the same as for the server:

```
> vbc /reference:Ice.dll /libpath:%ICE_HOME%\bin /reference:Printer.dll
/out:client.exe Client.vb
```

Running Client and Server in Visual Basic

To run client and server, we first start the server in a separate window:

```
> server.exe
```

At this point, we won't see anything because the server simply waits for a client to connect to it. We run the client in a different window:

```
> client.exe
>
```

The client runs and exits without producing any output; however, in the server window, we see the "Hello World!" that is produced by the printer. To get rid of the server, we interrupt it on the command line for now. (We will see cleaner ways to terminate a server in our discussion of [Ice.Application](#).)

If anything goes wrong, the client will print an error message. For example, if we run the client without having first started the server, we get something like the following:

```
Ice.ConnectionRefusedException
  error = 0
  at IceInternal.ProxyFactory.checkRetryAfterException(LocalException
ex, Reference ref, Int32 cnt)
  at Ice.ObjectPrxHelperBase.handleException__(ObjectDel_ delegate, Lo
calException ex, Int32 cnt)
  at Ice.ObjectPrxHelperBase.ice_isA(String id__, Dictionary`2 context
__, Boolean explicitContext__)
  at Ice.ObjectPrxHelperBase.ice_isA(String id__)
  at Demo.PrinterPrxHelper.checkedCast(ObjectPrx b)
  at Client.Main(String[] args)
Caused by: System.ComponentModel.Win32Exception: No connection could be
made because the target machine actively refused
it
```

Note that, to successfully run client and server, the VB run time must be able to locate the `Ice.dll` library. (Under Windows, one way to ensure this is to copy the library into the current directory. Please consult the documentation for your VB run time to see how it locates libraries.)

See Also

- [Client-Side Slice-to-C-Sharp Mapping](#)
- [Server-Side Slice-to-C-Sharp Mapping](#)
- [The `Ice.Application` Class](#)
- [The Current Object](#)
- [IceGrid](#)

Writing an Ice Application with Objective-C

This page shows how to create an Ice application with Objective-C.

On this page:

- [Compiling a Slice Definition for Objective-C](#)
- [Writing and Compiling a Server in Objective-C](#)
- [Writing and Compiling a Client in Objective-C](#)
- [Running Client and Server in Objective-C](#)

Compiling a Slice Definition for Objective-C

The first step in creating our Objective-C application is to compile our [Slice definition](#) to generate Objective-C proxies and skeletons. Under Unix, you can compile the definition as follows:

```
$ slice2objc Printer.ice
```

The `slice2objc` compiler produces two Objective-C source files from this definition, `Printer.h` and `Printer.m`.

- `Printer.h`
The `Printer.h` header file contains Objective-C type definitions that correspond to the Slice definitions for our `Printer` interface. This header file must be included in both the client and the server source code.
- `Printer.m`
The `Printer.m` file contains the source code for our `Printer` interface. The generated source contains type-specific run-time support for both clients and servers. For example, it contains code that marshals parameter data (the string passed to the `printString` operation) on the client side and unmarshals that data on the server side. The `Printer.m` file must be compiled and linked into both client and server.

Writing and Compiling a Server in Objective-C

The source code for the server takes only a few lines and is shown in full here:

```

Objective-C



```

#import <Ice/Ice.h>
#import <Printer.h>

#import <Foundation/NSAutoreleasePool.h>
#import <stdio.h>

@interface PrinterI : DemoPrinter <DemoPrinter>
@end

@implementation PrinterI
-(void) printString:(NSMutableString *)s
 current:(ICECurrent *)current
{
 printf("%s\n", [s UTF8String]);
}
@end

```

```

```

int
main(int argc, char* argv[])
{
    NSAutoreleasePool * pool = [[NSAutoreleasePool alloc] init];

    int status = 1;
    id<ICECommunicator> communicator = nil;
    @try {
        communicator = [ICEUtil createCommunicator:&argc argv:argv];

        id<ICEObjectAdapter> adapter =
            [communicator createObjectAdapterWithEndpoints:
             @"SimplePrinterAdapter"
             endpoints:@"default -p 10000"];

        ICEObject *object = [[[PrinterI alloc] init] autorelease];
        [adapter add:object identity:[communicator
stringToIdentity:@"SimplePrinter"]];
        [adapter activate];

        [communicator waitForShutdown];

        status = 0;
    } @catch (NSEException* ex) {
        NSLog(@"%@", ex);
    }

    @try {
        [communicator destroy];
    } @catch (NSEException* ex) {
        NSLog(@"%@", ex);
    }

    [pool release];
}

```

```

    return status;
}

```

There appears to be a lot of code here for something as simple as a server that just prints a string. Do not be concerned by this: most of the preceding code is boiler plate that never changes. For this very simple server, the code is dominated by this boiler plate.

Every Ice source file starts with an include directive for `Ice.h`, which contains the definitions for the Ice run time. We also include `Printer.h`, which was generated by the Slice compiler and contains the Objective-C definitions for our printer interface. In addition, we import headers to allow us to use an autorelease pool and to produce output:

Objective-C

```

#import <Ice/Ice.h>
#import <Printer.h>

#import <Foundation/NSAutoreleasePool.h>
#import <stdio.h>

```

Our server implements a single printer servant, of type `PrinterI`. Looking at the generated code in `Printer.h`, we find the following (tidied up a little to get rid of irrelevant detail):

Objective-C

```

@protocol DemoPrinter <ICEObject>
-(void) printString:(NSMutableString *)s
                current:(ICECurrent *)current;
@end

@interface DemoPrinter : ICEObject
// ...
@end

```

The `DemoPrinter` protocol and class definitions are generated by the Slice compiler. The protocol defines the `printString` method, which we must implement in our servant. The `DemoPrinter` class contains methods that are internal to the mapping, so we are not concerned with these. However, our servant must derive from this skeleton class:

Objective-C

```

@interface PrinterI : DemoPrinter <DemoPrinter>
@end

@implementation PrinterI
-(void) printString:(NSMutableString *)s
                current:(ICECurrent *)current
{
    printf("%s\n", [s UTF8String]);
}
@end

```

As you can see, the implementation of the `printString` method is trivial: it simply writes its string argument to `stdout`.

Note that `printString` has a second parameter of type `ICECurrent`. The Ice run time passes additional information about an incoming request to the servant in this parameter. For now, we will ignore it.

What follows is the server main program. Note the general structure of the code:

Objective-C

```

int
main(int argc, char* argv[])
{
    NSAutoreleasePool * pool = [[NSAutoreleasePool alloc] init];

    int status = 1;
    id<ICECommunicator> communicator = nil;
    @try {
        communicator = [ICEUtil createCommunicator:&argc argv:argv];

        // Server implementation here...

        status = 0;
    } @catch (NSEException* ex) {
        NSLog(@"%@", ex);
    }

    @try {
        [communicator destroy];
    } @catch (NSEException* ex) {
        NSLog(@"%@", ex);
    }

    [pool release];
    return status;
}

```

The body of `main` instantiates an autorelease pool, which it releases before returning to ensure that the program does not leak memory. `main` contains the declaration of two variables, `status` and `communicator`. The `status` variable contains the exit status of the program and the `communicator` variable, of type `id<ICECommunicator>`, contains the main handle to the Ice run time.

Following these declarations is a `try` block in which we place all the server code, followed by a `catch` handler that logs any unhandled exceptions.

Before returning, `main` executes a bit of cleanup code that calls the `destroy` method on the communicator. The cleanup call is outside the first `try` block for a reason: we must ensure that the Ice run time is finalized whether the code terminates normally or terminates due to an exception.



Failure to call `destroy` on the communicator before the program exits results in undefined behavior.

The body of the first `try` block contains the actual server code:

```

Objective-C

communicator = [ICEUtil createCommunicator:&argc argv:argv];

id<ICEObjectAdapter> adapter =
    [communicator createObjectAdapterWithEndpoints:
     @"SimplePrinterAdapter"
     endpoints:@"default -p 10000"];

ICEObject *object = [[[PrinterI alloc] init] autorelease];
[adapter add:object identity:[communicator
stringToIdentity:@"SimplePrinter"]];
[adapter activate];

[communicator waitForShutdown];

```

The code goes through the following steps:

1. We initialize the Ice run time by calling `createCommunicator`. (We pass `argc` and `argv` to this call because the server may have command-line arguments that are of interest to the run time; for this example, the server does not require any command-line arguments.) The call to `createCommunicator` returns a value of type `id<ICECommunicator>`, which is the main object in the Ice run time.
2. We create an object adapter by calling `createObjectAdapterWithEndpoints` on the `Communicator` instance. The arguments we pass are `"SimplePrinterAdapter"` (which is the name of the adapter) and `"default -p 10000"`, which instructs the adapter to listen for incoming requests using the default protocol (TCP/IP) at port number 10000.
3. At this point, the server-side run time is initialized and we create a servant for our `Printer` interface by instantiating a `PrinterI` object.
4. We inform the object adapter of the presence of a new servant by calling `add` on the adapter; the arguments to `add` are the servant we have just instantiated, plus an identifier. In this case, the string `"SimplePrinter"` is the name of the servant. (If we had multiple printers, each would have a different name or, more correctly, a different *object identity*.)
5. Next, we activate the adapter by calling its `activate` method. (The adapter is initially created in a holding state; this is useful if we have many servants that share the same adapter and do not want requests to be processed until after all the servants have been instantiated.) The server starts to process incoming requests from clients as soon as the adapter is activated.
6. Finally, we call `waitForShutdown`. This call suspends the calling thread until the server implementation terminates, either by making a call to shut down the run time, or in response to a signal. (For now, we will simply interrupt the server on the command line when we no longer need it.)

Note that, even though there is quite a bit of code here, that code is essentially the same for all servers. You can put that code into a helper class and, thereafter, will not have to bother with it again. As far as actual application code is concerned, the server contains only a few lines:

nine lines for the definition of the `PrinterI` class, plus three lines to instantiate a `PrinterI` object and register it with the object adapter.

Assuming that we have the server code in a file called `Server.m`, we can compile it as follows:

```
$ cc -c -I. -I$ICE_HOME/include Printer.m Server.m
```

This compiles both our application code and the code that was generated by the Slice compiler. We assume that the `ICE_HOME` environment variable is set to the top-level directory containing the Ice run time. (For example, if you have installed Ice in `/opt/Ice`, set `ICE_HOME` to that path.) Depending on your platform, you may have to add additional include directives or other options to the compiler; please see the demo programs that ship with Ice for the details.

Finally, we need to link the server into an executable:

```
$ c++ Printer.o Server.o -o server -L$ICE_HOME/lib -lIceObjC -framework  
Foundation
```

Again, depending on the platform, the actual list of libraries you need to link against may be longer. The demo programs that ship with Ice contain all the detail.

Writing and Compiling a Client in Objective-C

The client code looks very similar to the server. Here it is in full:

Objective-C

```

#import <Ice/Ice.h>
#import <Printer.h>

#import <Foundation/NSAutoreleasePool.h>
#import <stdio.h>

int
main(int argc, char* argv[])
{
    NSAutoreleasePool * pool = [[NSAutoreleasePool alloc] init];

    int status = 1;
    id<ICECommunicator> communicator = nil;
    @try {
        communicator = [ICEUtil createCommunicator:&argc argv:argv];
        id<ICEObjectPrx> base = [communicator
stringToProxy:@"SimplePrinter:default -p 10000"];
        id<DemoPrinterPrx> printer = [DemoPrinterPrx checkedCast:base];
        if(!printer)
            [NSEException raise:@"Invalid proxy" format:nil];

        [printer printString:@"Hello World!"];

        status = 0;
    } @catch (NSEException* ex) {
        NSLog(@"%@", ex);
    }

    @try {
        [communicator destroy];
    } @catch (NSEException* ex) {
        NSLog(@"%@", ex);
    }

    [pool release];
    return status;
}

```

Note that the overall code layout is the same as for the server: we include the headers for the Ice run time and the header generated by the Slice compiler, and we use the same `try` block and `catch` handlers to deal with errors.

The code in the `try` block does the following:

1. As for the server, we initialize the Ice run time by calling `createCommunicator`.
2. The next step is to obtain a proxy for the remote printer. We create a proxy by calling `stringToProxy` on the communicator, with the string `"SimplePrinter:default -p 10000"`. Note that the string contains the object identity and the port number that were used by the server. (Obviously, hard-coding object identities and port numbers into our applications is a bad idea, but it will do for now; we will see more architecturally sound ways of doing this when we discuss [IceGrid](#).)

3. The proxy returned by `stringToProxy` is of type `id<ICEObjectPrx>`, which is at the root of the inheritance tree for interfaces and classes. But to actually talk to our printer, we need a proxy for a `Printer` interface, not an `Object` interface. To do this, we need to do a down-cast by calling the `checkedCast` class method on the `DemoPrinterPrx` class. A checked cast sends a message to the server, effectively asking "is this a proxy for a `Printer` interface?" If so, the call returns a proxy to a `Printer`; otherwise, if the proxy denotes an interface of some other type, the call returns a null proxy.
4. We test that the down-cast succeeded and, if not, throw an error message that terminates the client.
5. We now have a live proxy in our address space and can call the `printString` method, passing it the time-honored "Hello World!" string. The server prints that string on its terminal.

Compiling and linking the client looks much the same as for the server:

```
$ cc -c -I. -I$ICE_HOME/include Printer.m Client.m
$ c++ Printer.o Client.o -o client -L$ICE_HOME/lib -lIceObjC -framework
Foundation
```

Running Client and Server in Objective-C

To run client and server, we first start the server in a separate window:

```
$ ./server
```

At this point, we won't see anything because the server simply waits for a client to connect to it. We run the client in a different window:

```
$ ./client
$
```

The client runs and exits without producing any output; however, in the server window, we see the "Hello World!" that is produced by the printer. To get rid of the server, we interrupt it on the command line for now.

If anything goes wrong, the client will print an error message. For example, if we run the client without having first started the server, we get:

```
Network.cpp:1218: Ice::ConnectionRefusedException:
connection refused: Connection refused
```

Note that, to successfully run client and server, you may have to set `DYLD_LIBRARY_PATH` to include the Ice library directory. Please see the installation instructions and the demo applications that ship with Ice Touch for details.

See Also

- [Client-Side Slice-to-Objective-C Mapping](#)
- [Server-Side Slice-to-Objective-C Mapping](#)
- [The Current Object](#)
- [IceGrid](#)

Writing an Ice Application with Python

This page shows how to create an Ice application with Python.

On this page:

- [Compiling a Slice Definition for Python](#)
- [Writing a Server in Python](#)
- [Writing a Client in Python](#)
- [Running Client and Server in Python](#)

Compiling a Slice Definition for Python

The first step in creating our Python application is to compile our [Slice definition](#) to generate Python proxies and skeletons. You can compile the definition as follows:

```
$ slice2py Printer.ice
```



Whenever we show Unix commands, we assume a Bourne or Bash shell. The commands for Windows are essentially identical and therefore not shown.

The `slice2py` compiler produces a single source file, `Printer_ice.py`, from this definition. The compiler also creates a Python package for the `Demo` module, resulting in a subdirectory named `Demo`. The exact contents of the source file do not concern us for now — it contains the generated code that corresponds to the `Printer` interface we defined in `Printer.ice`.

Writing a Server in Python

To implement our `Printer` interface, we must create a servant class. By convention, a servant class uses the name of its interface with an `I`-suffix, so our servant class is called `PrinterI`:

Python

```
class PrinterI(Demo.Printer):
    def printString(self, s, current=None):
        print s
```

The `PrinterI` class inherits from a base class called `Demo.Printer`, which is generated by the `slice2py` compiler. The base class is abstract and contains a `printString` method that accepts a string for the printer to print and a parameter of type `Ice.Current`. (For now we will ignore the `Ice.Current` parameter.) Our implementation of the `printString` method simply writes its argument to the terminal.

The remainder of the server code, in `Server.py`, follows our servant class and is shown in full here:

Python

```

import sys, traceback, Ice
import Demo

class PrinterI(Demo.Printer):
    def printString(self, s, current=None):
        print s

status = 0
ic = None
try:
    ic = Ice.initialize(sys.argv)
    adapter = ic.createObjectAdapterWithEndpoints("SimplePrinterAdapter", "default -p 10000")
    object = PrinterI()
    adapter.add(object, ic.stringToIdentity("SimplePrinter"))
    adapter.activate()
    ic.waitForShutdown()
except:
    traceback.print_exc()
    status = 1

if ic:
    # Clean up
    try:
        ic.destroy()
    except:
        traceback.print_exc()
        status = 1

sys.exit(status)

```

Note the general structure of the code:

Python

```

status = 0
ic = None
try:

    # Server implementation here...

except:
    traceback.print_exc()
    status = 1

if ic:
    # Clean up
    try:
        ic.destroy()
    except:
        traceback.print_exc()
        status = 1

sys.exit(status)

```

The body of the main program contains a `try` block in which we place all the server code, followed by an `except` block. The `except` block catches all exceptions that may be thrown by the code; the intent is that, if the code encounters an unexpected run-time exception anywhere, the stack is unwound all the way back to the main program, which prints the exception and then returns failure to the operating system.

Before the code exits, it destroys the communicator (if one was created successfully). Doing this is essential in order to correctly finalize the Ice run time: the program *must* call `destroy` on any communicator it has created; otherwise, undefined behavior results.

The body of our `try` block contains the actual server code:

Python

```

ic = Ice.initialize(sys.argv)
adapter = ic.createObjectAdapterWithEndpoints("SimplePrinterAdapter", "
default -p 10000")
object = PrinterI()
adapter.add(object, ic.stringToIdentity("SimplePrinter"))
adapter.activate()
ic.waitForShutdown()

```

The code goes through the following steps:

1. We initialize the Ice run time by calling `Ice.initialize`. (We pass `sys.argv` to this call because the server may have command-line arguments that are of interest to the run time; for this example, the server does not require any command-line arguments.) The call to `initialize` returns an `Ice.Communicator` reference, which is the main object in the Ice run time.
2. We create an object adapter by calling `createObjectAdapterWithEndpoints` on the `Communicator` instance. The arguments we pass are `"SimplePrinterAdapter"` (which is the name of the adapter) and `"default -p 10000"`, which instructs the adapter to listen for incoming requests using the default protocol (TCP/IP) at port number 10000.
3. At this point, the server-side run time is initialized and we create a servant for our `Printer` interface by instantiating a `PrinterI` object.

bject.

4. We inform the object adapter of the presence of a new servant by calling `add` on the adapter; the arguments to `add` are the servant we have just instantiated, plus an identifier. In this case, the string `"SimplePrinter"` is the name of the servant. (If we had multiple printers, each would have a different name or, more correctly, a different *object identity*.)
5. Next, we activate the adapter by calling its `activate` method. (The adapter is initially created in a holding state; this is useful if we have many servants that share the same adapter and do not want requests to be processed until after all the servants have been instantiated.)
6. Finally, we call `waitForShutdown`. This call suspends the calling thread until the server implementation terminates, either by making a call to shut down the run time, or in response to a signal. (For now, we will simply interrupt the server on the command line when we no longer need it.)

Note that, even though there is quite a bit of code here, that code is essentially the same for all servers. You can put that code into a helper class and, thereafter, will not have to bother with it again. (Ice provides such a helper class, called `Ice.Application`.) As far as actual application code is concerned, the server contains only a few lines: three lines for the definition of the `PrinterI` class, plus two lines to instantiate a `PrinterI` object and register it with the object adapter.

Writing a Client in Python

The client code, in `Client.py`, looks very similar to the server. Here it is in full:

```

Python

import sys, traceback, Ice
import Demo

status = 0
ic = None
try:
    ic = Ice.initialize(sys.argv)
    base = ic.stringToProxy("SimplePrinter:default -p 10000")
    printer = Demo.PrinterPrx.checkedCast(base)
    if not printer:
        raise RuntimeError("Invalid proxy")

    printer.printString("Hello World!")
except:
    traceback.print_exc()
    status = 1

if ic:
    # Clean up
    try:
        ic.destroy()
    except:
        traceback.print_exc()
        status = 1

sys.exit(status)
```

Note that the overall code layout is the same as for the server: we use the same `try` and `except` blocks to deal with errors. The code in the `try` block does the following:

1. As for the server, we initialize the Ice run time by calling `Ice.initialize`.
2. The next step is to obtain a proxy for the remote printer. We create a proxy by calling `stringToProxy` on the communicator, with the string `"SimplePrinter:default -p 10000"`. Note that the string contains the object identity and the port number that were used by the server. (Obviously, hard-coding object identities and port numbers into our applications is a bad idea, but it will do for now; we will see more architecturally sound ways of doing this when we discuss [IceGrid](#).)
3. The proxy returned by `stringToProxy` is of type `Ice.ObjectPrx`, which is at the root of the inheritance tree for interfaces and classes. But to actually talk to our printer, we need a proxy for a `Demo::Printer` interface, not an `Object` interface. To do this, we need to do a down-cast by calling `Demo.PrinterPrx.checkedCast`. A checked cast sends a message to the server, effectively asking "is this a proxy for a `Demo::Printer` interface?" If so, the call returns a proxy of type `Demo.PrinterPrx`; otherwise, if the proxy denotes an interface of some other type, the call returns `None`.
4. We test that the down-cast succeeded and, if not, throw an error message that terminates the client.
5. We now have a live proxy in our address space and can call the `printString` method, passing it the time-honored `"Hello World!"` string. The server prints that string on its terminal.

Running Client and Server in Python

To run client and server, we first start the server in a separate window:

```
$ python Server.py
```

At this point, we won't see anything because the server simply waits for a client to connect to it. We run the client in a different window:

```
$ python Client.py
$
```

The client runs and exits without producing any output; however, in the server window, we see the `"Hello World!"` that is produced by the printer. To get rid of the server, we interrupt it on the command line for now. (We will see cleaner ways to terminate a server in our discussion of [Ice.Application](#).)

If anything goes wrong, the client will print an error message. For example, if we run the client without having first started the server, we get something like the following:

```
Traceback (most recent call last):
  File "Client.py", line 10, in ?
    printer = Demo.PrinterPrx.checkedCast(base)
  File "Printer_ice.py", line 43, in checkedCast
    return Demo.PrinterPrx.ice_checkedCast(proxy, '::Demo::Printer', fa
    cet)
ConnectionRefusedException: Ice.ConnectionRefusedException:
Connection refused
```

Note that, to successfully run the client and server, the Python interpreter must be able to locate the Ice extension for Python. See the [Ice for Python installation instructions](#) for more information.

See Also

- [Client-Side Slice-to-Python Mapping](#)
- [Server-Side Slice-to-Python Mapping](#)
- [The Ice.Application Class](#)
- [The Current Object](#)

- [IceGrid](#)

Writing an Ice Application with Ruby

This page shows how to create an Ice client application with Ruby.

On this page:

- [Compiling a Slice Definition for Ruby](#)
- [Writing a Client in Ruby](#)
- [Running the Client in Ruby](#)

Compiling a Slice Definition for Ruby

The first step in creating our Ruby application is to compile our [Slice definition](#) to generate Ruby proxies. You can compile the definition as follows:

```
$ slice2rb Printer.ice
```



Whenever we show Unix commands, we assume a Bourne or Bash shell. The commands for Windows are essentially identical and therefore not shown.

The `slice2rb` compiler produces a single source file, `Printer.rb`, from this definition. The exact contents of the source file do not concern us for now — it contains the generated code that corresponds to the `Printer` interface we defined in `Printer.ice`.

Writing a Client in Ruby

The client code, in `Client.rb`, is shown below in full:

Ruby

```
require 'Printer.rb'

status = 0
ic = nil
begin
  ic = Ice::initialize(ARGV)
  base = ic.stringToProxy("SimplePrinter:default -p 10000")
  printer = Demo::PrinterPrx::checkedCast(base)
  if not printer
    raise "Invalid proxy"
  end

  printer.printString("Hello World!")
rescue
  puts $!
  puts $!.backtrace.join("\n")
  status = 1
end

if ic
  # Clean up
  begin
    ic.destroy()
  rescue
    puts $!
    puts $!.backtrace.join("\n")
    status = 1
  end
end

exit(status)
```

The program begins with a `require` statement, which loads the Ruby code we generated from our Slice definition in the previous section. It is not necessary for the client to explicitly load the `Ice` module because `Printer.rb` does that for you.

The body of the main program contains a `begin` block in which we place all the client code, followed by a `rescue` block. The `rescue` block catches all exceptions that may be thrown by the code; the intent is that, if the code encounters an unexpected run-time exception anywhere, the stack is unwound all the way back to the main program, which prints the exception and then returns failure to the operating system.

The body of our `begin` block goes through the following steps:

1. We initialize the Ice run time by calling `Ice::initialize`. (We pass `ARGV` to this call because the client may have command-line arguments that are of interest to the run time; for this example, the client does not require any command-line arguments.) The call to `initialize` returns an `Ice::Communicator` reference, which is the main object in the Ice run time.
2. The next step is to obtain a proxy for the remote printer. We create a proxy by calling `stringToProxy` on the communicator, with the string `"SimplePrinter:default -p 10000"`. Note that the string contains the object identity and the port number that were used by the server. (Obviously, hard-coding object identities and port numbers into our applications is a bad idea, but it will do for now; we will see more architecturally sound ways of doing this when we discuss [IceGrid](#).)
3. The proxy returned by `stringToProxy` is of type `Ice::ObjectPrx`, which is at the root of the inheritance tree for interfaces and

classes. But to actually talk to our printer, we need a proxy for a `Demo::Printer` interface, not an `Object` interface. To do this, we need to do a down-cast by calling `Demo::PrinterPrx::checkedCast`. A checked cast sends a message to the server, effectively asking "is this a proxy for a `Demo::Printer` interface?" If so, the call returns a proxy of type `Demo::PrinterPrx`; otherwise, if the proxy denotes an interface of some other type, the call returns `nil`.

4. We test that the down-cast succeeded and, if not, throw an error message that terminates the client.
5. We now have a live proxy in our address space and can call the `printString` method, passing it the time-honored "Hello World!" string. The server prints that string on its terminal.

Before the code exits, it destroys the communicator (if one was created successfully). Doing this is essential in order to correctly finalize the Ice run time: the program *must* call `destroy` on any communicator it has created; otherwise, undefined behavior results.

Running the Client in Ruby

The server must be started before the client. Since Ice for Ruby does not support server-side behavior, we need to use a server from another language mapping. In this case, we will use the [C++ server](#):

```
$ server
```

At this point, we won't see anything because the server simply waits for a client to connect to it. We run the client in a different window:

```
$ ruby Client.rb
$
```

The client runs and exits without producing any output; however, in the server window, we see the "Hello World!" that is produced by the printer. To get rid of the server, we interrupt it on the command line.

If anything goes wrong, the client will print an error message. For example, if we run the client without having first started the server, we get something like the following:

```
exception ::Ice::ConnectionRefusedException
{
  error = 111
}
```

Note that, to successfully run the client, the Ruby interpreter must be able to locate the Ice extension for Ruby. See the [Ice for Ruby installation instructions](#) for more information.

See Also

- [Client-Side Slice-to-Ruby Mapping](#)
- [IceGrid](#)

Writing an Ice Application with PHP

This page shows how to create an Ice client application with PHP.

On this page:

- [Compiling a Slice Definition for PHP](#)
- [Writing a Client in PHP](#)
- [Running the Client in PHP](#)

Compiling a Slice Definition for PHP

The first step in creating our PHP application is to compile our `Slice` definition to generate PHP code. You can compile the definition as follows:

```
$ slice2php Printer.ice
```



Whenever we show Unix commands, we assume a Bourne or Bash shell. The commands for Windows are essentially identical and therefore not shown.

The `slice2php` compiler produces a single source file, `Printer.php`, from this definition. The exact contents of the source file do not concern us for now — it contains the generated code that corresponds to the `Printer` interface we defined in `Printer.ice`.

Writing a Client in PHP

The client code, in `Client.php`, is shown below in full:

PHP

```

<?php
require 'Ice.php';
require 'Printer.php';

$ic = null;
try
{
    $ic = Ice_initialize();
    $base = $ic->stringToProxy("SimplePrinter:default -p 10000");
    $printer = Demo_PrinterPrxHelper::checkedCast($base);
    if(!$printer)
        throw new RuntimeException("Invalid proxy");

    $printer->printString("Hello World!");
}
catch(Exception $ex)
{
    echo $ex;
}

if($ic)
{
    // Clean up
    try
    {
        $ic->destroy();
    }
    catch(Exception $ex)
    {
        echo $ex;
    }
}
?>

```

The program begins with `require` statements to load the Ice run-time definitions (`Ice.php`) and the code we generated from our Slice definition in the previous section (`Printer.php`).

The body of the main program contains a `try` block in which we place all the client code, followed by a `catch` block. The `catch` block catches all exceptions that may be thrown by the code; the intent is that, if the code encounters an unexpected run-time exception anywhere, the stack is unwound all the way back to the main program, which prints the exception and then returns failure to the operating system.

The body of our `try` block goes through the following steps:

1. We initialize the Ice run time by calling `Ice_initialize`. The call to `initialize` returns an `Ice_Communicator` reference, which is the main object in the Ice run time.
2. The next step is to obtain a proxy for the remote printer. We create a proxy by calling `stringToProxy` on the communicator, with the string `"SimplePrinter:default -p 10000"`. Note that the string contains the object identity and the port number that were used by the server. (Obviously, hard-coding object identities and port numbers into our applications is a bad idea, but it will do for now; we will see more architecturally sound ways of doing this when we discuss `IceGrid`.)

3. The proxy returned by `stringToProxy` is of type `Ice_ObjectPrx`, which is at the root of the inheritance tree for interfaces and classes. But to actually talk to our printer, we need a proxy for a `Demo::Printer` interface, not an `Object` interface. To do this, we need to do a down-cast by calling `Demo_PrinterPrxHelper::checkedCast`. A checked cast sends a message to the server, effectively asking "is this a proxy for a `Demo::Printer` interface?" If so, the call returns a proxy narrowed to the `Printer` interface; otherwise, if the proxy denotes an interface of some other type, the call returns `null`.
4. We test that the down-cast succeeded and, if not, throw an exception that terminates the client.
5. We now have a live proxy in our address space and can call the `printString` method, passing it the time-honored "Hello World!" string. The server prints that string on its terminal.

Before the code exits, it destroys the communicator (if one was created successfully). Doing this is essential in order to correctly finalize the Ice run time. If a script neglects to destroy the communicator, Ice destroys it automatically.

Running the Client in PHP

The server must be started before the client. Since Ice for PHP does not support server-side behavior, we need to use a server from another language mapping. In this case, we will use the [C++ server](#):

```
$ server
```

At this point, we won't see anything because the server simply waits for a client to connect to it. We run the client in a different window using PHP's command-line interpreter:

```
$ php -f Client.php
$
```

The client runs and exits without producing any output; however, in the server window, we see the "Hello World!" that is produced by the printer. To get rid of the server, we interrupt it on the command line.

If anything goes wrong, the client will print an error message. For example, if we run the client without having first started the server, we get something like the following:

```
exception ::Ice::ConnectionRefusedException
{
    error = 111
}
```

Note that, to successfully run the client, the PHP interpreter must be able to locate the Ice extension for PHP. See the [Ice for PHP installation instructions](#) for more information.

See Also

- [Client-Side Slice-to-PHP Mapping](#)
- [IceGrid](#)

The Slice Language

Here, we present the Slice language. Slice (Specification Language for Ice) is the fundamental abstraction mechanism for separating object interfaces from their implementations. Slice establishes a contract between client and server that describes the types and object interfaces used by an application. This description is independent of the implementation language, so it does not matter whether the client is written in the same language as the server.

 Even though Slice is an acronym, it is pronounced as a single syllable, like a slice of bread.

Slice definitions are compiled for a particular implementation language by a compiler. The compiler translates the language-independent definitions into language-specific type definitions and APIs. These types and APIs are used by the developer to provide application functionality and to interact with Ice. The translation algorithms for various implementation languages are known as *language mappings*. Currently, Ice defines language mappings for C++, Java, C#, Python, Objective-C, Ruby, and PHP.

Because Slice describes interfaces and types (but not implementations), it is a purely declarative language; there is no way to write executable statements in Slice.

Slice definitions focus on object interfaces, the operations supported by those interfaces, and exceptions that may be raised by operations. In addition, Slice offers features for [object persistence](#). This requires quite a bit of supporting machinery; in particular, much of Slice is concerned with the definition of data types. This is because data can be exchanged between client and server only if their types are defined in Slice. You cannot exchange arbitrary C++ data between client and server because it would destroy the language independence of Ice. However, you can always create a Slice type definition that corresponds to the C++ data you want to send, and then you can transmit the Slice type.

We present the full syntax and semantics of Slice here. Because much of Slice is based on C++ and Java, we focus on those areas where Slice differs from C++ or Java or constrains the equivalent C++ or Java feature in some way. Slice features that are identical to C++ and Java are mentioned mostly by example.

Topics

- [Slice Compilation](#)
- [Slice Source Files](#)
- [Lexical Rules](#)
- [Modules](#)
- [Basic Types](#)
- [User-Defined Types](#)
- [Interfaces, Operations, and Exceptions](#)
- [Classes](#)
- [Forward Declarations](#)
- [Optional Data Members](#)
- [Type IDs](#)
- [Operations on Object](#)
- [Local Types](#)
- [Names and Scoping](#)
- [Metadata](#)
- [Serializable Objects](#)
- [Deprecating Slice Definitions](#)
- [Using the Slice Compilers](#)
- [Slice Checksums](#)
- [Generating Slice Documentation](#)
- [Slice Keywords](#)
- [Slice Metadata Directives](#)
- [Slice for a Simple File System](#)

Slice Compilation

On this page:

- [Compilation](#)
- [Single Development Environment for Client and Server](#)
- [Different Development Environments for Client and Server](#)

Compilation

A Slice compiler produces source files that must be combined with application code to produce client and server executables.

The outcome of the development process is a client executable and a server executable. These executables can be deployed anywhere, whether the target environments use the same or different operating systems and whether the executables are implemented using the same or different languages. The only constraint is that the host machines must provide the necessary run-time environment, such as any required dynamic libraries, and that connectivity can be established between them.

Single Development Environment for Client and Server

The figure below shows the situation when both client and server are developed in C++. The Slice compiler generates two files from a Slice definition in a source file `Printer.ice`: a header file (`Printer.h`) and a source file (`Printer.cpp`)

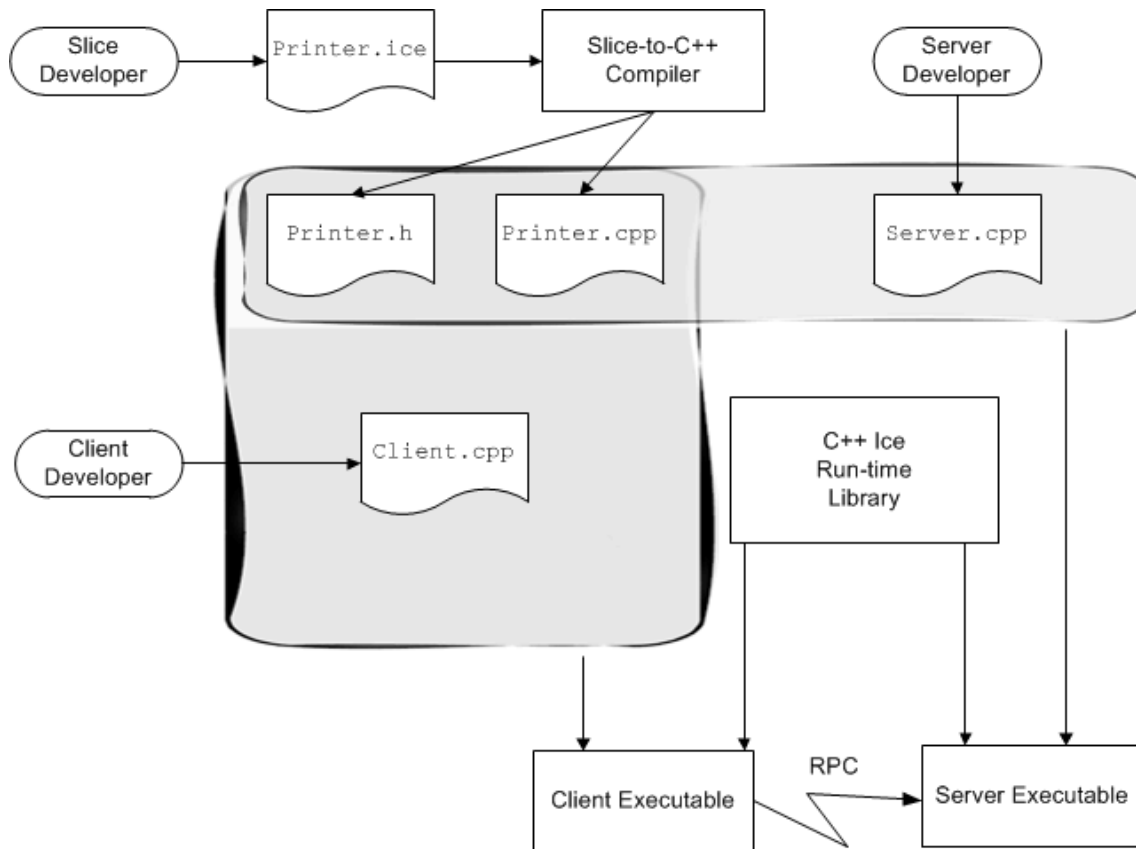

Development process if client and server share the same development environment.

- The `Printer.h` header file contains definitions that correspond to the types used in the Slice definition. It is included in the source code of both client and server to ensure that client and server agree about the types and interfaces used by the application.
- The `Printer.cpp` source file provides an API to the client for sending messages to remote objects. The client source code (`Client.cpp`, written by the client developer) contains the client-side application logic. The generated source code and the client code are compiled and linked into the client executable.

The `Printer.cpp` source file also contains source code that provides an up-call interface from the Ice run time into the server code written by the developer and provides the connection between the networking layer of Ice and the application code. The server implementation file (`Server.cpp`, written by the server developer) contains the server-side application logic (the object implementations, properly termed *servants*). The generated source code and the implementation source code are compiled and linked into the server executable.

Both client and server also link with an Ice library that provides the necessary run-time support.

You are not limited to a single implementation of a client or server. For example, you can build multiple servers, each of which implements the same interfaces but uses different implementations (for example, with different performance characteristics). Multiple such server implementations can coexist in the same system. This arrangement provides one fundamental scalability mechanism in Ice: if you find that a server process starts to bog down as the number of objects increases, you can run an additional server for the same interfaces on a different machine. Such *federated* servers provide a single logical service that is distributed over a number of processes on different machines. Each server in the federation implements the same interfaces but hosts different object instances. (Of course, federated servers must somehow ensure consistency of any databases they share across the federation.)

Ice also provides support for *replicated* servers. Replication permits multiple servers to each implement the same set of object instances. This improves performance and scalability (because client load can be shared over a number of servers) as well as redundancy (because each object is implemented in more than one server).

Different Development Environments for Client and Server

Client and server cannot share any source or binary components if they are developed in different languages. For example, a client written in Java cannot include a C++ header file.

This figure shows the situation when a client written in Java and the corresponding server is written in C++. In this case, the client and server developers are completely independent, and each uses his or her own development environment and language mapping. The only link between client and server developers is the Slice definition each one uses.

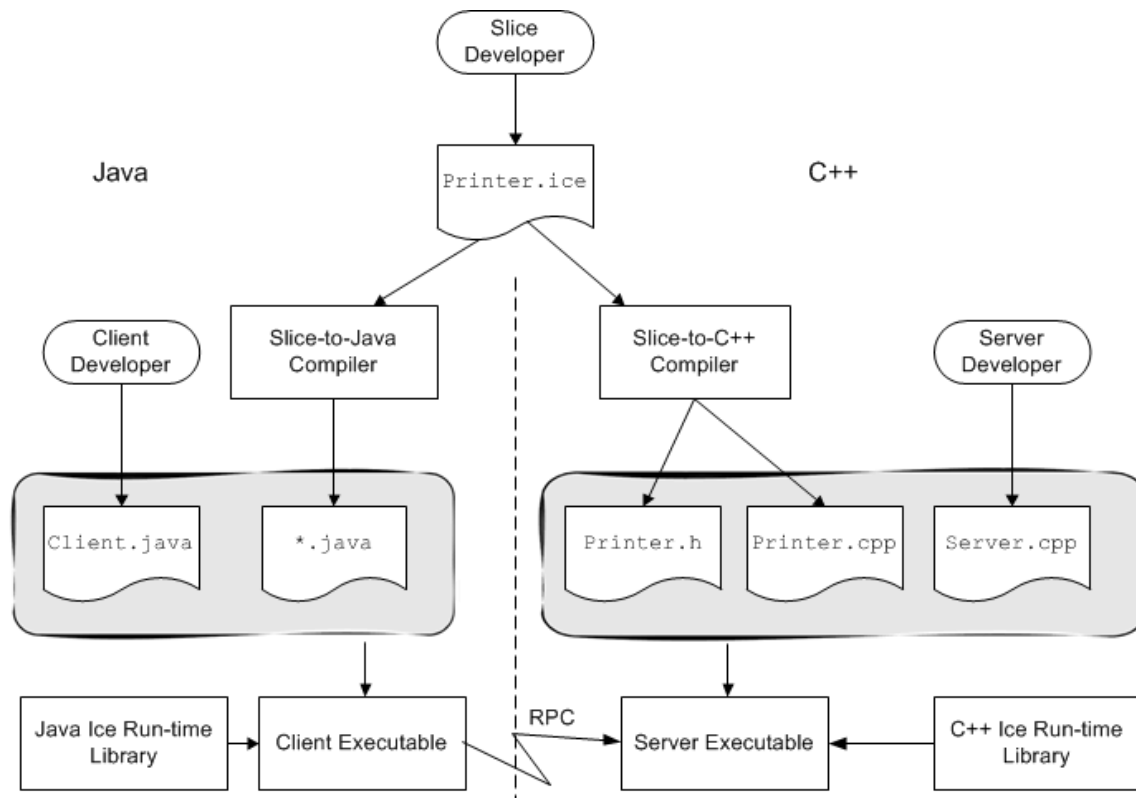

Development process for different development environments.

For Java, the slice compiler creates a number of files whose names depend on the names of various Slice constructs. (These files are collectively referred to as `*.java` in the above figure.)

See Also

- [Using the Slice Compilers](#)

Slice Source Files

Slice defines a number of rules for the naming and contents of Slice source files.

On this page:

- [File Naming](#)
- [File Format](#)
- [Preprocessing](#)
 - [Detecting Ice Versions](#)
- [Definition Order](#)

File Naming

Files containing Slice definitions must end in a `.ice` file extension, for example, `Clock.ice` is a valid file name. Other file extensions are rejected by the compilers.

For case-insensitive file systems (such as DOS), the file extension may be written as uppercase or lowercase, so `Clock.ICE` is legal. For case-sensitive file systems (such as Unix), `Clock.ICE` is illegal. (The extension must be in lowercase.)

File Format

Slice is a free-form language so you can use spaces, horizontal and vertical tab stops, form feeds, and newline characters to lay out your code in any way you wish. (White space characters are token separators). Slice does not attach semantics to the layout of a definition. You may wish to follow the style we have used for the Slice examples throughout this book.

Slice files can be ASCII text files or use the UTF-8 character encoding with a byte order marker (BOM) at the beginning of each file. However, Slice identifiers are limited to ASCII letters and digits; non-ASCII letters can appear only in comments.

Preprocessing

Slice supports the same preprocessor directives as C++, so you can use directives such as `#include` and macro definitions. However, Slice permits `#include` directives only at the beginning of a file, before any Slice definitions.

If you use `#include` directives, it is a good idea to protect them with guards to prevent double inclusion of a file:

Slice
<pre>// File Clock.ice #ifdef _CLOCK_ICE #define _CLOCK_ICE // #include directives here... // Definitions here... #endif _CLOCK_ICE</pre>

The following `#pragma` directive offers a simpler way to achieve the same result:

Slice

```
// File Clock.ice
#pragma once

// #include directives here...
// Definitions here...
```

`#include` directives permit a Slice definition to use types defined in a different source file. The Slice compilers parse all of the code in a source file, including the code in subordinate `#include` files. However, the compilers generate code only for the top-level file(s) nominated on the command line. You must separately compile subordinate `#include` files to obtain generated code for all the files that make up your Slice definition.

Note that you should avoid `#include` with double quotes:

Slice

```
#include "Clock.ice" // Not recommended!
```

While double quotes will work, the directory in which the preprocessor tries to locate the file can vary depending on the operating system, so the included file may not always be found where you expect it. Instead, use angle brackets (`<>`); you can control which directories are searched for the file with the `-I` option of the Slice compiler.

Also note that, if you include a path separator in a `#include` directive, you must use a forward slash:

Slice

```
#include <SliceDefs/Clock.ice> // OK
```

You cannot use a backslash in `#include` directives:

Slice

```
#include <SliceDefs\Clock.ice> // Illegal
```

Detecting Ice Versions

As of Ice 3.5, the Slice compilers define the preprocessor macro `ICE_VERSION` with a numeric representation of the Ice version. The value of this macro is the same as the C++ macro `ICE_INT_VERSION`. You can use this macro to make your Slice definitions backward-compatible with older Ice releases, while still taking advantage of newer Ice features when possible. For example, the Slice definition shown below makes use of custom enumerator values:

Slice

```
#if defined(ICE_VERSION) && ICE_VERSION >= 030500
enum Fruit { Apple, Pear = 3, Orange };
#else
enum Fruit { Apple, Pear, Orange };
#endif
```

Although this example is intended to show how to use the `ICE_VERSION` macro, it also highlights a potential pitfall that you must be aware of when trying to maintain backward compatibility: the two definitions of `Fruit` are not wire-compatible.

Definition Order

Slice constructs, such as modules, interfaces, or type definitions, can appear in any order you prefer. However, identifiers must be declared before they can be used.

See Also

- [Using the Slice Compilers](#)

Lexical Rules

Slice's lexical rules are very similar to those of C++ and Java, except for some differences for identifiers.

On this page:

- [Comments](#)
- [Keywords](#)
- [Identifiers](#)
 - [Case Sensitivity](#)
 - [Identifiers That Are Keywords](#)
 - [Escaped Identifiers](#)
 - [Reserved Identifiers](#)

Comments

Slice definitions permit both the C and the C++ style of writing comments:

Slice
<pre> /* * C-style comment. */ // C++-style comment extending to the end of this line.</pre>

Keywords

Slice uses a number of [keywords](#), which must be spelled in lowercase. For example, `class` and `dictionary` are keywords and must be spelled as shown. There are two exceptions to this lowercase rule: `Object` and `LocalObject` are keywords and must be capitalized as shown.

Identifiers

Identifiers begin with an alphabetic character followed by any number of alphabetic characters or digits. Underscores are also permitted in identifiers with the following limitations:

- an identifier cannot begin or end with an underscore
- an identifier cannot contain multiple consecutive underscores

Given these rules, the identifier `get_account_name` is legal but not `_account`, `account_`, or `get__account`.

Slice identifiers are restricted to the ASCII range of alphabetic characters and cannot contain non-English letters, such as Å. (Supporting non-ASCII identifiers would make it very difficult to map Slice to target languages that lack support for this feature.)

Case Sensitivity

Identifiers are case-insensitive but must be capitalized consistently. For example, `TimeOfDay` and `TIMEOFDAY` are considered the same identifier within a naming scope. However, Slice enforces consistent capitalization. After you have introduced an identifier, you must capitalize it consistently throughout; otherwise, the compiler will reject it as illegal. This rule exists to permit mappings of Slice to languages that ignore case in identifiers as well as to languages that treat differently capitalized identifiers as distinct.

Identifiers That Are Keywords

You can define Slice identifiers that are keywords in one or more implementation languages. For example, `switch` is a perfectly good Slice

identifier but is a C++ and Java keyword. Each language mapping defines rules for dealing with such identifiers. The solution typically involves using a prefix to map away from the keyword. For example, the Slice identifier `switch` is mapped to `_cpp_switch` in C++ and `_switch` in Java.

The rules for dealing with keywords can result in hard-to-read source code. Identifiers such as `native`, `throw`, or `export` will clash with C++ or Java keywords (or both). To make life easier for yourself and others, try to avoid Slice identifiers that are implementation language keywords. Keep in mind that mappings for new languages may be added to Ice in the future. While it is not reasonable to expect you to compile a list of all keywords in all popular programming languages, you should make an attempt to avoid at least common keywords. Slice identifiers such as `self`, `import`, and `while` are definitely not a good idea.

Escaped Identifiers

It is possible to use a Slice keyword as an identifier by prefixing the keyword with a backslash, for example:

Slice
<pre>struct dictionary { // Error! // ... }; struct \dictionary { // OK // ... }; struct \foo { // Legal, same as "struct foo" // ... };</pre>

The backslash escapes the usual meaning of a keyword; in the preceding example, `\dictionary` is treated as the identifier `dictionary`. The escape mechanism exists to permit keywords to be added to the Slice language over time with minimal disruption to existing specifications: if a pre-existing specification happens to use a newly-introduced keyword, that specification can be fixed by simply prepending a backslash to the new keyword. Note that, as a matter of style, you should avoid using Slice keywords as identifiers (even though the backslash escapes allow you to do this).

It is legal (though redundant) to precede an identifier that is not a keyword with a backslash — the backslash is ignored in that case.

Reserved Identifiers

Slice reserves the identifier `Ice` and all identifiers beginning with `Ice` (in any capitalization) for the Ice implementation. For example, if you try to define a type named `Icecream`, the Slice compiler will issue an error message.



You can suppress this behavior by using the `--ice` compiler option, which enables definition of identifiers beginning with `Ice`. However, do not use this option unless you are compiling the Slice definitions for the Ice run time itself.

Slice identifiers ending in any of the suffixes `Helper`, `Holder`, `Prx`, and `Ptr` are also reserved. These endings are used by the various language mappings and are reserved to prevent name clashes in the generated code.

See Also

- [Slice Keywords](#)

Modules

On this page:

- [Modules Reduce Clutter](#)
- [Modules are Mandatory](#)
- [Reopening Modules](#)
- [Module Mapping](#)
- [The Ice Module](#)

Modules Reduce Clutter

A common problem in large systems is pollution of the global namespace: over time, as isolated systems are integrated, name clashes become quite likely. Slice provides the `module` construct to alleviate this problem:

```

Slice
module ZeroC {
    module Client {
        // Definitions here...
    };
    module Server {
        // Definitions here...
    };
};

```

A module can contain any legal Slice construct, including other module definitions. Using modules to group related definitions together avoids polluting the global namespace and makes accidental name clashes quite unlikely. (You can use a well-known name, such as a company or product name, as the name of the outermost module.)

Modules are Mandatory

Slice requires all definitions to be nested inside a module, that is, you cannot define anything other than a module at global scope. For example, the following is illegal:

```

Slice
interface I { // Error: only modules can appear at global scope
    // ...
};

```

Definitions at global scope are prohibited because they cause problems with some implementation languages (such as Python, which does not have a true global scope).



Throughout the Ice manual, you will occasionally see Slice definitions that are not nested inside a module. This is to keep the examples short and free of clutter. Whenever you see such a definition, assume that it is nested in a module.

Reopening Modules

Modules can be reopened:

Slice

```
module ZeroC {
    // Definitions here...
};

// Possibly in a different source file:

module ZeroC { // OK, reopened module
    // More definitions here...
};
```

Reopened modules are useful for larger projects: they allow you to split the contents of a module over several different [source files](#). The advantage of doing this is that, when a developer makes a change to one part of the module, only files dependent on the changed part need be recompiled (instead of having to recompile all files that use the module).

Module Mapping

Modules map to a corresponding scoping construct in each programming language. (For example, for C++ and C#, Slice modules map to namespaces whereas, for Java, they map to packages.) This allows you to use an appropriate C++ `using` or Java `import` declaration to avoid excessively long identifiers in your source code.

The Ice Module

APIs for the Ice run time, apart from a small number of language-specific calls that cannot be expressed in Ice, are defined in the `Ice` module. In other words, most of the Ice API is actually expressed as Slice definitions. The advantage of doing this is that a single Slice definition is sufficient to define the API for the Ice run time for all supported languages. The respective language mapping rules then determine the exact shape of each Ice API for each implementation language.

We will incrementally explore the contents of the `Ice` module throughout this manual.

See Also

- [Slice Source Files](#)

Basic Types

On this page:

- [Built-In Basic Types](#)
- [Integer Types](#)
- [Floating-Point Types](#)
- [Strings](#)
- [Booleans](#)
- [Bytes](#)

Built-In Basic Types

Slice provides a number of built-in basic types, as shown in this table:

Type	Range of Mapped Type	Size of Mapped Type
<code>bool</code>	false or true	1 bit
<code>byte</code>	-128-127 or 0-255 ^a	8 bits
<code>short</code>	-2^{15} to $2^{15} - 1$	16 bits
<code>int</code>	-2^{31} to $2^{31} - 1$	32 bits
<code>long</code>	-2^{63} to $2^{63} - 1$	64 bits
<code>float</code>	IEEE single-precision	32 bits
<code>double</code>	IEEE double-precision	64 bits
<code>string</code>	All Unicode characters, excluding the character with all bits zero.	Variable-length

^a The range depends on whether `byte` maps to a signed or an unsigned type.

All the basic types (except `byte`) are subject to changes in representation as they are transmitted between clients and servers. For example, a `long` value is byte-swapped when sent from a little-endian to a big-endian machine. Similarly, strings undergo translation in representation if they are sent, for example, from an EBCDIC to an ASCII implementation, and the characters of a string may also change in size. (Not all architectures use 8-bit characters). However, these changes are transparent to the programmer and do exactly what is required.

Integer Types

Slice provides integer types `short`, `int`, and `long`, with 16-bit, 32-bit, and 64-bit ranges, respectively. Note that, on some architectures, any of these types may be mapped to a native type that is wider. Also note that no unsigned types are provided. (This choice was made because unsigned types are difficult to map into languages without native unsigned types, such as Java. In addition, the unsigned integers add little value to a language. (See [\[1\]](#) for a good treatment of the topic.)

Floating-Point Types

These types follow the IEEE specification for single- and double-precision floating-point representation [\[2\]](#). If an implementation cannot support IEEE format floating-point values, the Ice run time converts values into the native floating-point representation (possibly at a loss of precision or even magnitude, depending on the capabilities of the native floating-point format).

Strings

Slice strings use the Unicode character set. The only character that cannot appear inside a string is the zero character.





This decision was made as a concession to C++, with which it becomes impossibly difficult to manipulate strings with embedded zero characters using standard library routines, such as `strlen` or `strcat`.

The Slice data model does not have the concept of a null string (in the sense of a C++ null pointer). This decision was made because null strings are difficult to map to languages without direct support for this concept (such as Python). Do not design interfaces that depend on a null string to indicate "not there" semantics. If you need the notion of an optional string, use a [class](#), a [sequence](#) of strings, or use an empty string to represent the idea of a null string. (Of course, the latter assumes that the empty string is not otherwise used as a legitimate string value by your application.)

Booleans

Boolean values can have only the values `false` and `true`. Language mappings use the corresponding native boolean type if one is available.

Bytes

The Slice type `byte` is an (at least) 8-bit type that is guaranteed not to undergo any changes in representation as it is transmitted between address spaces. This guarantee permits exchange of binary data such that it is not tampered with in transit. All other Slice types are subject to changes in representation during transmission.

See Also

- [Sequences](#)
- [Classes](#)

References

1. Lakos, J. 1996. [Large-Scale C++ Software Design](#). Reading, MA: Addison-Wesley.
2. Institute of Electrical and Electronics Engineers. 1985. *IEEE 754-1985 Standard for Binary Floating-Point Arithmetic*. Piscataway, NJ: Institute of Electrical and Electronic Engineers.

User-Defined Types

In addition to providing the built-in basic types, Slice allows you to define complex types: enumerations, structures, sequences, and dictionaries.

Topics

- [Enumerations](#)
- [Structures](#)
- [Sequences](#)
- [Dictionaries](#)
- [Constants and Literals](#)

Enumerations

Enumeration Syntax and Semantics

A Slice enumerated type definition looks identical to C++:

```
enum Fruit { Apple, Pear, Orange };
```

This definition introduces a type named `Fruit` that becomes a new type in its own right. Slice guarantees that the values of enumerators increase from left to right, so `Apple` compares less than `Pear` in every language mapping. By default, the first enumerator has a value of zero, with sequentially increasing values for subsequent enumerators.

Slice enumerators enter the enclosing namespace, so the following is illegal:

```
enum Fruit { Apple, Pear, Orange };
enum ComputerBrands { Apple, IBM, Sun, HP }; // Apple redefined
```

Slice does not permit empty enumerations.

Custom Enumerator Values

Slice also permits you to assign custom values to enumerators:

```
const int PearValue = 7;
enum Fruit { Apple = 0, Pear = PearValue, Orange };
```

Custom values must be unique and non-negative, and may refer to Slice constants of integer types. If no custom value is specified for an enumerator, its value is one greater than the enumerator that immediately precedes it. In the example above, `Orange` has the value 8.

Slice does not require custom enumerator values to be declared in increasing order:

```
enum Fruit { Apple = 5, Pear = 3, Orange = 1 }; // Legal
```

Note however that when there is an inconsistency between the declaration order and the numerical order of the enumerators, the behavior of comparison operations may vary between language mappings.



For an application that is still using version 1.0 of the [Ice encoding](#), changing the definition of an enumerated type may break backward compatibility with existing applications. For more information, please refer to the encoding rules for enumerated types.

See Also

- [Structures](#)

- Sequences
- Dictionaries
- Constants and Literals

Structures

Slice supports structures containing one or more named members of arbitrary type, including user-defined complex types. For example:

```

Slice
struct TimeOfDay {
    short hour;           // 0 - 23
    short minute;        // 0 - 59
    short second;        // 0 - 59
};

```

As in C++, this definition introduces a new type called `TimeOfDay`. Structure definitions form a namespace, so the names of the structure members need to be unique only within their enclosing structure.

Data member definitions using a named type are the only construct that can appear inside a structure. It is impossible to, for example, define a structure inside a structure:

```

Slice
struct TwoPoints {
    struct Point {      // Illegal!
        short x;
        short y;
    };
    Point coord1;
    Point coord2;
};

```

This rule applies to Slice in general: type definitions cannot be nested (except for [modules](#), which do support nesting). The reason for this rule is that nested type definitions can be difficult to implement for some target languages and, even if implementable, greatly complicate the scope resolution rules. For a specification language, such as Slice, nested type definitions are unnecessary – you can always write the above definitions as follows (which is stylistically cleaner as well):

```

Slice
struct Point {
    short x;
    short y;
};

struct TwoPoints {      // Legal (and cleaner!)
    Point coord1;
    Point coord2;
};

```

You can specify a default value for a data member that has one of the following types:

- An **integral** type (byte, short, int, long)
- A **floating point** type (float or double)

- `string`
- `bool`
- `enum`

For example:

```

Slice



```
struct Location {
 string name;
 Point pt;
 bool display = true;
 string source = "GPS";
};
```

```

The legal syntax for literal values is the same as for Slice [constants](#), and you may also use a constant as a default value. The language mapping guarantees that data members are initialized to their declared default values using a language-specific mechanism.

See Also

- [Modules](#)
- [Basic Types](#)
- [Enumerations](#)
- [Sequences](#)
- [Dictionaries](#)
- [Constants and Literals](#)

Sequences

On this page:

- [Sequence Syntax and Semantics](#)
- [Using Sequences for Optional Values](#)

Sequence Syntax and Semantics

Sequences are variable-length collections of elements:

Slice

```
sequence<Fruit> FruitPlatter;
```

A sequence can be empty—that is, it can contain no elements, or it can hold any number of elements up to the memory limits of your platform.

Sequences can contain elements that are themselves sequences. This arrangement allows you to create lists of lists:

Slice

```
sequence<FruitPlatter> FruitBanquet;
```

Sequences are used to model a variety of collections, such as vectors, lists, queues, sets, bags, or trees. (It is up to the application to decide whether or not order is important; by discarding order, a sequence serves as a set or bag.)

Using Sequences for Optional Values



Using a sequence to model an optional value is unnecessary with the introduction of [optional data members](#) and [optional parameters](#) in Ice 3.5.

One particular use of sequences has become idiomatic, namely, the use of a sequence to indicate an optional value. For example, we might have a `Part` structure that records the details of the parts that go into a car. The structure could record things such as the name of the part, a description, weight, price, and other details. Spare parts commonly have a serial number, which we can model as a `long` value. However, some parts, such as simple screws, often do not have a serial number, so what are we supposed to put into the serial number field of a screw? There are a number of options for dealing with this situation:

- **Use a sentinel value, such as zero, to indicate the "no serial number" condition.**
This approach is workable, provided that a sentinel value is actually available. While it may seem unlikely that anyone would use a serial number of zero for a part, it is not impossible. And, for other values, such as a temperature value, all values in the range of their type can be legal, so no sentinel value is available.
- **Change the type of the serial number from `long` to `string`.**
Strings come with their own built-in sentinel value, namely the empty string, so we can use an empty string to indicate the "no serial number" case. This is workable but not ideal: we should not have to change the natural data type of something to `string` just so we get a sentinel value.
- **Add an indicator as to whether the contents of the serial number are valid:**

Slice

```
struct Part {
    string name;
    string description;
    // ...
    bool   serialIsValid; // true if part has serial number
    long   serialNumber;
};
```

This is guaranteed to get you into trouble eventually: sooner or later, some programmer will forget to check whether the serial number is valid before using it and create havoc.

- **Use a sequence to model the optional field.**

This technique uses the following convention:

Slice

```
sequence<long> SerialOpt;

struct Part {
    string   name;
    string   description;
    // ...
    SerialOpt serialNumber; // optional: zero or one element
};
```

By convention, the `Opt` suffix is used to indicate that the sequence is used to model an optional value. If the sequence is empty, the value is obviously not there; if it contains a single element, that element is the value. The obvious drawback of this scheme is that someone could put more than one element into the sequence. This could be rectified by adding a special-purpose Slice construct for optional values. However, optional values are not used frequently enough to justify the complexity of adding a dedicated language feature. (As we will see in [Classes](#), you can also use class hierarchies to model optional fields.)

See Also

- [Enumerations](#)
- [Structures](#)
- [Dictionaries](#)
- [Constants and Literals](#)
- [Classes](#)

Dictionaries

On this page:

- [Dictionary Syntax and Semantics](#)
- [Allowable Types for Dictionary Keys and Values](#)

Dictionary Syntax and Semantics

A dictionary is a mapping from a key type to a value type.

For example:

Slice
<pre> struct Employee { long number; string firstName; string lastName; }; dictionary<long, Employee> EmployeeMap; </pre>

This definition creates a dictionary named `EmployeeMap` that maps from an employee number to a structure containing the details for an employee. Whether or not the key type (the employee number, of type `long` in this example) is also part of the value type (the `Employee` structure in this example) is up to you — as far as Slice is concerned, there is no need to include the key as part of the value.

Dictionaries can be used to implement sparse arrays, or any lookup data structure with non-integral key type. Even though a sequence of structures containing key-value pairs could be used to model the same thing, a dictionary is more appropriate:

- A dictionary clearly signals the intent of the designer, namely, to provide a mapping from a domain of values to a range of values. (A sequence of structures of key-value pairs does not signal that same intent as clearly.)
- At the programming language level, sequences are implemented as vectors (or possibly lists), that is, they are not well suited to model sparsely populated domains and require a linear search to locate an element with a particular value. On the other hand, dictionaries are implemented as a data structure (typically a hash table or red-black tree) that supports efficient searching in $O(\log n)$ average time or better.

Allowable Types for Dictionary Keys and Values

The key type of a dictionary need not be an integral type. For example, we could use the following definition to translate the names of the days of the week:

Slice
<pre> dictionary<string, string> WeekdaysEnglishToGerman; </pre>

The server implementation would take care of initializing this map with the key-value pairs `Monday-Montag`, `Tuesday-Dienstag`, and so on.

The value type of a dictionary can be any Slice type. However, the key type of a dictionary is limited to one of the following types:

- `Integral` types (`byte`, `short`, `int`, `long`, `bool`)
- `string`
- `enum`

- [Structures](#) containing only data members of integral type or `string`

Complex nested types, such as nested structures, sequences, or dictionaries, and floating-point types (`float` and `double`) cannot be used as the key type. Complex nested types are disallowed because they complicate the language mappings for dictionaries, and floating-point types are disallowed because representational changes of values as they cross machine boundaries can lead to ill-defined semantics for equality.

See Also

- [Basic Types](#)
- [Enumerations](#)
- [Structures](#)
- [Sequences](#)
- [Constants and Literals](#)

Constants and Literals

On this page:

- [Allowable Types for Constants](#)
- [Boolean constants](#)
- [Integer literals](#)
- [Floating-point literals](#)
- [String literals](#)

Allowable Types for Constants

Slice allows you to define constants for the following types:

- An **integral type** (`bool`, `byte`, `short`, `int`, `long`)
- A **floating point type** (`float` or `double`)
- `string`
- `enum`

Here are a few examples:

Slice	
<code>const bool</code>	<code>AppendByDefault = true;</code>
<code>const byte</code>	<code>LowerNibble = 0x0f;</code>
<code>const string</code>	<code>Advice = "Don't Panic!";</code>
<code>const short</code>	<code>TheAnswer = 42;</code>
<code>const double</code>	<code>PI = 3.1416;</code>
<code>enum Fruit { Apple, Pear, Orange };</code>	
<code>const Fruit</code>	<code>FavoriteFruit = Pear;</code>

The syntax for literals is the same as for C++ and Java (with a few minor exceptions).

Boolean constants

Boolean constants can only be initialized with the keywords `false` and `true`. (You cannot use `0` and `1` to represent `false` and `true`.)

Integer literals

Integer literals can be specified in decimal, octal, or hexadecimal notation.

For example:

Slice	
<code>const byte</code>	<code>TheAnswer = 42;</code>
<code>const byte</code>	<code>TheAnswerInOctal = 052;</code>
<code>const byte</code>	<code>TheAnswerInHex = 0x2A; // or 0x2a</code>

Be aware that, if you interpret `byte` as a number instead of a bit pattern, you may get different results in different languages. For example, for C++, `byte` maps to `unsigned char` whereas, for Java, `byte` maps to `byte`, which is a signed type.

Note that suffixes to indicate long and unsigned constants (`l`, `L`, `u`, `U`, used by C++) are illegal:

Slice

```
const long Wrong = 0u;           // Syntax error
const long WrongToo = 1000000L; // Syntax error
```

The value of an integer literal must be within the range of its constant type, as shown in the [Built-In Basic Types table](#); otherwise the compiler will issue a diagnostic.

Floating-point literals

Floating-point literals use C++ syntax, except that you cannot use an `l` or `L` suffix to indicate an extended floating-point constant; however, `f` and `F` are legal (but are ignored).

Here are a few examples:

Slice

```
const float P1 = -3.14f; // Integer & fraction, with suffix
const float P2 = +3.1e-3; // Integer, fraction, and exponent
const float P3 = .1; // Fraction part only
const float P4 = 1.; // Integer part only
const float P5 = .9E5; // Fraction part and exponent
const float P6 = 5e2; // Integer part and exponent
```

Floating-point literals must be within the range of the constant type (`float` or `double`); otherwise, the compiler will issue a diagnostic.

String literals

String literals support the same escape sequences as C++.

Here are some examples:

Slice

```

const string AnOrdinaryString = "Hello World!";

const string DoubleQuote =    "\"";
const string TwoSingleQuotes = "'\''";    // ' and \ are OK
const string Newline =      "\n";
const string CarriageReturn = "\r";
const string HorizontalTab = "\t";
const string VerticalTab =   "\v";
const string FormFeed =     "\f";
const string Alert =        "\a";
const string Backspace =    "\b";
const string QuestionMark = "\?";
const string Backslash =    "\\";

const string OctalEscape =   "\007";    // Same as \a
const string HexEscape =    "\x07";    // Ditto

```

Note that Slice has no concept of a null string:

Slice

```
const string nullString = 0;    // Illegal!
```

Null strings simply do not exist in Slice and, therefore, do not exist as a legal value for a string anywhere in the Ice platform. The reason for this decision is that null strings do not exist in many programming languages.



Many languages other than C and C++ use a byte array as the internal string representation. Null strings do not exist (and would be very difficult to map) in such languages.

A constant definition may also refer to another constant. It is not necessary for both constants to have the same Slice type, but the value of the existing constant must be compatible with the type of the constant being defined.

Consider the examples below:

Slice

```

const int SIZE = 500;

const int DEFAULT_SIZE = SIZE; // OK
const short SHORT_SIZE = SIZE; // OK
const byte BYTE_SIZE = SIZE;   // ERROR

```

The `DEFAULT_SIZE` constant is legal because it has the same type as `SIZE`, and `SHORT_SIZE` is legal because the value of `SIZE` (500) is within the range of the Slice `short` type. However, `BYTE_SIZE` is illegal because the value of `SIZE` is outside the range of the `byte` type.

See Also

- [Enumerations](#)
- [Structures](#)
- [Sequences](#)
- [Dictionaries](#)

Interfaces, Operations, and Exceptions

The central focus of Slice is on defining interfaces, for example:

```

Slice



```

struct TimeOfDay {
 short hour; // 0 - 23
 short minute; // 0 - 59
 short second; // 0 - 59
};

interface Clock {
 TimeOfDay getTime();
 void setTime(TimeOfDay time);
};

```

```

This definition defines an interface type called `clock`. The interface supports two operations: `getTime` and `setTime`. Clients access an object supporting the `clock` interface by invoking an operation on the proxy for the object: to read the current time, the client invokes the `getTime` operation; to set the current time, the client invokes the `setTime` operation, passing an argument of type `TimeOfDay`.

Invoking an operation on a proxy instructs the Ice run time to send a message to the target object. The target object can be in another address space or can be collocated (in the same process) as the caller — the location of the target object is transparent to the client. If the target object is in another (possibly remote) address space, the Ice run time invokes the operation via a remote procedure call; if the target is collocated with the client, the Ice run time uses an ordinary function call instead, to avoid the overhead of marshaling.

You can think of an interface definition as the equivalent of the public part of a C++ class definition or as the equivalent of a Java interface, and of operation definitions as (virtual) member functions. Note that nothing but operation definitions are allowed to appear inside an interface definition. In particular, you cannot define a type, an exception, or a data member inside an interface. This does not mean that your object implementation cannot contain state — it can, but how that state is implemented (in the form of data members or otherwise) is hidden from the client and, therefore, need not appear in the object's interface definition.

An Ice object has exactly one (most derived) Slice interface type (or *class type*). Of course, you can create multiple Ice objects that have the same type; to draw the analogy with C++, a Slice interface corresponds to a C++ class definition, whereas an Ice object corresponds to a C++ class instance (but Ice objects can be implemented in multiple different address spaces).

Ice also provides multiple interfaces via a feature called *facets*.

A Slice interface defines the smallest grain of distribution in Ice: each Ice object has a unique identity (encapsulated in its proxy) that distinguishes it from all other Ice objects; for communication to take place, you must invoke operations on an object's proxy. There is no other notion of an addressable entity in Ice. You cannot, for example, instantiate a Slice structure and have clients manipulate that structure remotely. To make the structure accessible, you must create an interface that allows clients to access the structure.

The partition of an application into interfaces therefore has profound influence on the overall architecture. Distribution boundaries must follow interface (or class) boundaries; you can spread the implementation of interfaces over multiple address spaces (and you can implement multiple interfaces in the same address space), but you cannot implement parts of interfaces in different address spaces.

Topics

- [Operations](#)
- [User Exceptions](#)
- [Run-Time Exceptions](#)
- [Proxies](#)
- [Interface Inheritance](#)

See Also

- [Classes](#)
- [Facets and Versioning](#)

Operations

On this page:

- [Parameters and Return Values](#)
- [Optional Parameters and Return Values](#)
- [Style of Operation Definition](#)
- [Overloading Operations](#)
- [Idempotent Operations](#)

Parameters and Return Values

An operation definition must contain a return type and zero or more parameter definitions. For example, in the `clock` interface, the `getTime` operation has a return type of `TimeOfDay` and the `setTime` operation has a return type of `void`. You must use `void` to indicate that an operation returns no value — there is no default return type for Slice operations.

An operation can have one or more input parameters. For example, `setTime` accepts a single input parameter of type `TimeOfDay` called `time`. Of course, you can use multiple input parameters:

Slice
<pre>interface CircadianRhythm { void setSleepPeriod(TimeOfDay startTime, TimeOfDay stopTime); // ... };</pre>

Note that the parameter name (as for Java) is mandatory. You cannot omit the parameter name, so the following is in error:

Slice
<pre>interface CircadianRhythm { void setSleepPeriod(TimeOfDay, TimeOfDay); // Error! // ... };</pre>

By default, parameters are sent from the client to the server, that is, they are input parameters. To pass a value from the server to the client, you can use an output parameter, indicated by the `out` keyword. For example, an alternative way to define the `getTime` operation in the `clock` interface would be:

Slice
<pre>void getTime(out TimeOfDay time);</pre>

This achieves the same thing but uses an output parameter instead of the return value. As with input parameters, you can use multiple output parameters:

Slice

```
interface CircadianRhythm {
    void setSleepPeriod(TimeOfDay startTime, TimeOfDay stopTime);
    void getSleepPeriod(out TimeOfDay startTime,
out TimeOfDay stopTime);
    // ...
};
```

If you have both input and output parameters for an operation, the output parameters must follow the input parameters:

Slice

```
void changeSleepPeriod(    TimeOfDay startTime,
TimeOfDay stopTime,      // OK
                        out TimeOfDay prevStartTime,
out TimeOfDay prevStopTime);

void changeSleepPeriod(out TimeOfDay prevStartTime, out TimeOfDay prevS
topTime, // Error
                        TimeOfDay startTime,
TimeOfDay stopTime);
```

Slice does not support parameters that are both input and output parameters (call by reference). The reason is that, for remote calls, reference parameters do not result in the same savings that one can obtain for call by reference in programming languages. (Data still needs to be copied in both directions and any gains in marshaling efficiency are negligible.) Also, reference (or input-output) parameters result in more complex language mappings, with concomitant increases in code size.

Optional Parameters and Return Values

As of Ice 3.5, an operation's return value and parameters may be declared as *optional* to indicate that a program can leave their values unset. Parameters not declared as optional are known as *required* parameters; a program must supply legal values for all required parameters. In the discussion below, we use *parameter* to refer to input parameters, output parameters, and return values.

A unique, non-negative integer *tag* must be assigned to each optional parameter:

Slice

```
optional(3) bool example(optional(2) string name, out optional(1) int
value);
```

The scope of a tag is limited to its operation and has no effect on other operations.

An operation's signature can include any combination of required and optional parameters, but output parameters still must follow input parameters:

Slice

```
bool example(string name, optional(3) string referrer, out optional(1)
string promo, out int id);
```

Language mappings specify an API for passing optional parameters and testing whether a parameter is present. Refer to the language mapping sections for more details on the optional parameter API.

 A well-behaved program must test for the presence of an optional parameter and not assume that it is always set. Dereferencing an unset optional parameter causes a run-time error.

Style of Operation Definition

As you would expect, language mappings follow the style of operation definition you use in Slice: Slice return types map to programming language return types, and Slice parameters map to programming language parameters.

For operations that return only a single value, it is common to return the value from the operation instead of using an out-parameter. This style maps naturally into all programming languages. Note that, if you use an out-parameter instead, you impose a different API style on the client: most programming languages permit the return value of a function to be ignored whereas it is typically not possible to ignore an output parameter.

For operations that return multiple values, it is common to return all values as out-parameters and to use a return type of `void`. However, the rule is not all that clear-cut because operations with multiple output values can have one particular value that is considered more "important" than the remainder. A common example of this is an iterator operation that returns items from a collection one-by-one:

Slice

```
bool next(out RecordType r);
```

The `next` operation returns two values: the record that was retrieved and a Boolean to indicate the end-of-collection condition. (If the return value is `false`, the end of the collection has been reached and the parameter `r` has an undefined value.) This style of definition can be useful because it naturally fits into the way programmers write control structures. For example:

```
while (next(record))
    // Process record...

if (next(record))
    // Got a valid record...
```

Overloading Operations

Slice does not support any form of overloading of operations. For example:

Slice

```
interface CircadianRhythm {
    void modify(TimeOfDay startTime, TimeOfDay endTime);
    void modify(    TimeOfDay startTime,        // Error
                 TimeOfDay endTime,
                 out timeOfDay prevStartTime,
                 out TimeOfDay prevEndTime);
};
```

Operations in the same interface must have different names, regardless of what type and number of parameters they have. This restriction exists because overloaded functions cannot sensibly be mapped to languages without built-in support for overloading.



Name mangling is not an option in this case: while it works fine for compilers, it is unacceptable to humans.

Idempotent Operations

Some operations, such as `getTime` in the `Clock` interface, do not modify the state of the object they operate on. They are the conceptual equivalent of C++ `const` member functions. Similarly, `setTime` does modify the state of the object, but is idempotent. You can indicate this in Slice as follows:

Slice

```
interface Clock {
    idempotent TimeOfDay getTime();
    idempotent void setTime(TimeOfDay time);
};
```

This marks the `getTime` and `setTime` operations as idempotent. An operation is idempotent if two successive invocations of the operation have the same effect as a single invocation. For example, `x = 1;` is an idempotent operation because it does not matter whether it is executed once or twice — either way, `x` ends up with the value 1. On the other hand, `x += 1;` is not an idempotent operation because executing it twice results in a different value for `x` than executing it once. Obviously, any read-only operation is idempotent.

The `idempotent` keyword is useful because it allows the Ice run time to be more aggressive when performing [automatic retries](#) to recover from errors. Specifically, Ice guarantees *at-most-once* semantics for operation invocations:

- For normal (not idempotent) operations, the Ice run time has to be conservative about how it deals with errors. For example, if a client sends an operation invocation to a server and then loses connectivity, there is no way for the client-side run time to find out whether the request it sent actually made it to the server. This means that the run time cannot attempt to recover from the error by re-establishing a connection and sending the request a second time because that could cause the operation to be invoked a second time and violate *at-most-once* semantics; the run time has no option but to report the error to the application.
- For `idempotent` operations, on the other hand, the client-side run time can attempt to re-establish a connection to the server and safely send the failed request a second time. If the server can be reached on the second attempt, everything is fine and the application never notices the (temporary) failure. Only if the second attempt fails need the run time report the error back to the application. (The number of retries can be increased with an Ice configuration parameter.)

See Also

- [Interfaces, Operations, and Exceptions](#)
- [User Exceptions](#)
- [Run-Time Exceptions](#)

- [Proxies](#)
- [Interface Inheritance](#)
- [Automatic Retries](#)
- [Optional Values](#)

User Exceptions

On this page:

- [User Exception Syntax and Semantics](#)
 - [Default Values for User Exception Members](#)
 - [Declaring User Exceptions in Operations](#)
 - [Restrictions for User Exceptions](#)
- [User Exception Inheritance](#)

User Exception Syntax and Semantics

Looking at the `setTime` operation in the `clock` interface, we find a potential problem: given that the `TimeOfDay` structure uses `short` as the type of each field, what will happen if a client invokes the `setTime` operation and passes a `TimeOfDay` value with meaningless field values, such as `-199` for the minute field, or `42` for the hour? Obviously, it would be nice to provide some indication to the caller that this is meaningless. Slice allows you to define user exceptions to indicate error conditions to the client. For example:

```

Slice
exception Error {}; // Empty exceptions are legal

exception RangeError {
    TimeOfDay errorTime;
    TimeOfDay minTime;
    TimeOfDay maxTime;
};

```

A user exception is much like a structure in that it contains a number of data members. However, unlike structures, exceptions can have zero data members, that is, be empty. Like classes, user exceptions support inheritance and may include [optional data members](#).

Default Values for User Exception Members

You can specify a default value for an exception data member that has one of the following types:

- An [integral](#) type (`byte`, `short`, `int`, `long`)
- A [floating point](#) type (`float` or `double`)
- `string`
- `bool`
- `enum`

For example:

```

Slice
exception RangeError {
    TimeOfDay errorTime;
    TimeOfDay minTime;
    TimeOfDay maxTime;
    string reason = "out of range";
};

```

The legal syntax for literal values is the same as for [Slice constants](#), and you may also use a constant as a default value. The language mapping guarantees that data members are initialized to their declared default values using a language-specific mechanism.

Declaring User Exceptions in Operations

Exceptions allow you to return an arbitrary amount of error information to the client if an error condition arises in the implementation of an operation. Operations use an exception specification to indicate the exceptions that may be returned to the client:

Slice

```
interface Clock {
    idempotent TimeOfDay getTime();
    idempotent void setTime(TimeOfDay time)
        throws RangeError, Error;
};
```

This definition indicates that the `setTime` operation may throw either a `RangeError` or an `Error` user exception (and no other type of exception). If the client receives a `RangeError` exception, the exception contains the `TimeOfDay` value that was passed to `setTime` and caused the error (in the `errorTime` member), as well as the minimum and maximum time values that can be used (in the `minTime` and `maxTime` members). If `setTime` failed because of an error not caused by an illegal parameter value, it throws `Error`. Obviously, because `Error` does not have data members, the client will have no idea what exactly it was that went wrong — it simply knows that the operation did not work.

An operation can throw only those user exceptions that are listed in its exception specification. If, at run time, the implementation of an operation throws an exception that is not listed in its exception specification, the client receives a [run-time exception](#) to indicate that the operation did something illegal. To indicate that an operation does not throw any user exception, simply omit the exception specification. (There is no empty exception specification in `Slice`.)

Restrictions for User Exceptions

Exceptions are not first-class data types and first-class data types are not exceptions:

- You cannot pass an exception as a parameter value.
- You cannot use an exception as the type of a data member.
- You cannot use an exception as the element type of a sequence.
- You cannot use an exception as the key or value type of a dictionary.
- You cannot throw a value of non-exception type (such as a value of type `int` or `string`).

The reason for these restrictions is that some implementation languages use a specific and separate type for exceptions (in the same way as `Slice` does). For such languages, it would be difficult to map exceptions if they could be used as an ordinary data type. (C++ is somewhat unusual among programming languages by allowing arbitrary types to be used as exceptions.)

User Exception Inheritance

Exceptions support inheritance. For example:

Slice

```

exception ErrorBase {
    string reason;
};

enum RLError {
    DivideByZero, NegativeRoot, IllegalNull /* ... */
};

exception RuntimeError extends ErrorBase {
    RLError err;
};

enum LLError { ValueOutOfRange, ValuesInconsistent, /* ... */ };

exception LogicError extends ErrorBase {
    LLError err;
};

exception RangeError extends LogicError {
    TimeOfDay errorTime;
    TimeOfDay minTime;
    TimeOfDay maxTime;
};

```

These definitions set up a simple exception hierarchy:

- `ErrorBase` is at the root of the tree and contains a string explaining the cause of the error.
- Derived from `ErrorBase` are `RuntimeError` and `LogicError`. Each of these exceptions contains an enumerated value that further categorizes the error.
- Finally, `RangeError` is derived from `LogicError` and reports the details of the specific error.

Setting up exception hierarchies such as this not only helps to create a more readable specification because errors are categorized, but also can be used at the language level to good advantage. For example, the Slice C++ mapping preserves the exception hierarchy so you can catch exceptions generically as a base exception, or set up exception handlers to deal with specific exceptions.

Looking at the exception hierarchy, it is not clear whether, at run time, the application will only throw most derived exceptions, such as `RangeError`, or if it will also throw base exceptions, such as `LogicError`, `RuntimeError`, and `ErrorBase`. If you want to indicate that a base exception, interface, or class is abstract (will not be instantiated), you can add a comment to that effect.

Note that, if the exception specification of an operation indicates a specific exception type, at run time, the implementation of the operation may also throw more derived exceptions. For example:

Slice

```

exception Base {
    // ...
};

exception Derived extends Base {
    // ...
};

interface Example {
    void op() throws Base;    // May throw Base or Derived
};

```

In this example, `op` may throw a `Base` or a `Derived` exception, that is, any exception that is compatible with the exception types listed in the exception specification can be thrown at run time.

As a system evolves, it is quite common for new, derived exceptions to be added to an existing hierarchy. Assume that we initially construct clients and server with the following definitions:

Slice

```

exception Error {
    // ...
};

interface Application {
    void doSomething() throws Error;
};

```

Also assume that a large number of clients are deployed in field, that is, when you upgrade the system, you cannot easily upgrade all the clients. As the application evolves, a new exception is added to the system and the server is redeployed with the new definition:

Slice

```

exception Error {
    // ...
};

exception FatalApplicationError extends Error {
    // ...
};

interface Application {
    void doSomething() throws Error;
};

```

This raises the question of what should happen if the server throws a `FatalApplicationError` from `doSomething`. The answer

depends whether the client was built using the old or the updated definition:

- If the client was built using the same definition as the server, it simply receives a `FatalApplicationError`.
- If the client was built with the original definition, that client has no knowledge that `FatalApplicationError` even exists. In this case, the Ice run time automatically slices the exception to the most-derived type that is understood by the receiver (`Error`, in this case) and discards the information that is specific to the derived part of the exception. (This is exactly analogous to catching C++ exceptions by value — the exception is sliced to the type used in the `catch`-clause.)

Exceptions support single inheritance only. (Multiple inheritance would be difficult to map into many programming languages.)

See Also

- [Constants and Literals](#)
- [Operations](#)
- [Run-Time Exceptions](#)
- [Proxies](#)
- [Interface Inheritance](#)
- [Optional Data Members](#)

Run-Time Exceptions

In addition to any [user exceptions](#) that are listed in an operation's exception specification, an operation can also throw Ice *run-time exceptions*. Run-time exceptions are predefined exceptions that indicate platform-related run-time errors. For example, if a networking error interrupts communication between client and server, the client is informed of this by a run-time exception, such as `ConnectTimeoutException` or `SocketException`.

The exception specification of an operation must not list any run-time exceptions. (It is understood that all operations can raise run-time exceptions and you are not allowed to restate that.)

On this page:

- [Inheritance Hierarchy for Exceptions](#)
- [Local Versus Remote Exceptions](#)
 - [Common Exceptions](#)
 - `ObjectNotExistException`
 - `FacetNotExistException`
 - `OperationNotExistException`
 - [Unknown Exceptions](#)
 - `UnknownUserException`
 - `UnknownLocalException`
 - `UnknownException`

Inheritance Hierarchy for Exceptions

All the Ice run-time and user exceptions are arranged in an inheritance hierarchy, as shown below:

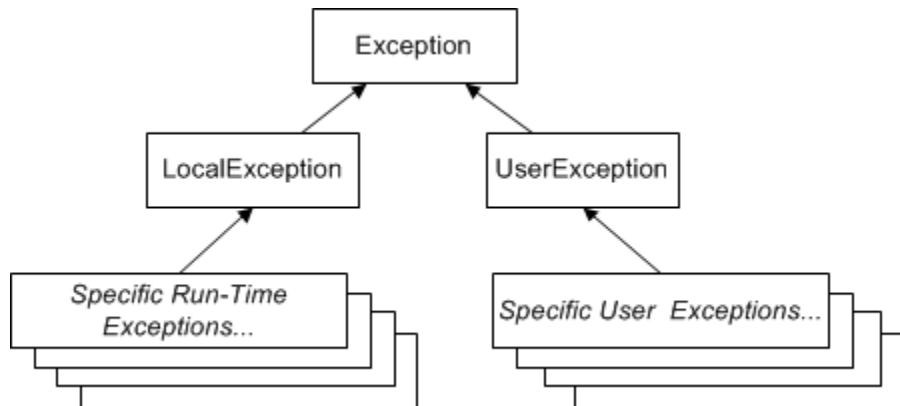

Inheritance structure for exceptions.

`Ice::Exception` is at the root of the inheritance hierarchy. Derived from that are the (abstract) types `Ice::LocalException` and `Ice::UserException`. In turn, all run-time exceptions are derived from `Ice::LocalException`, and all user exceptions are derived from `Ice::UserException`.

This figure shows the complete hierarchy of the Ice run-time exceptions:

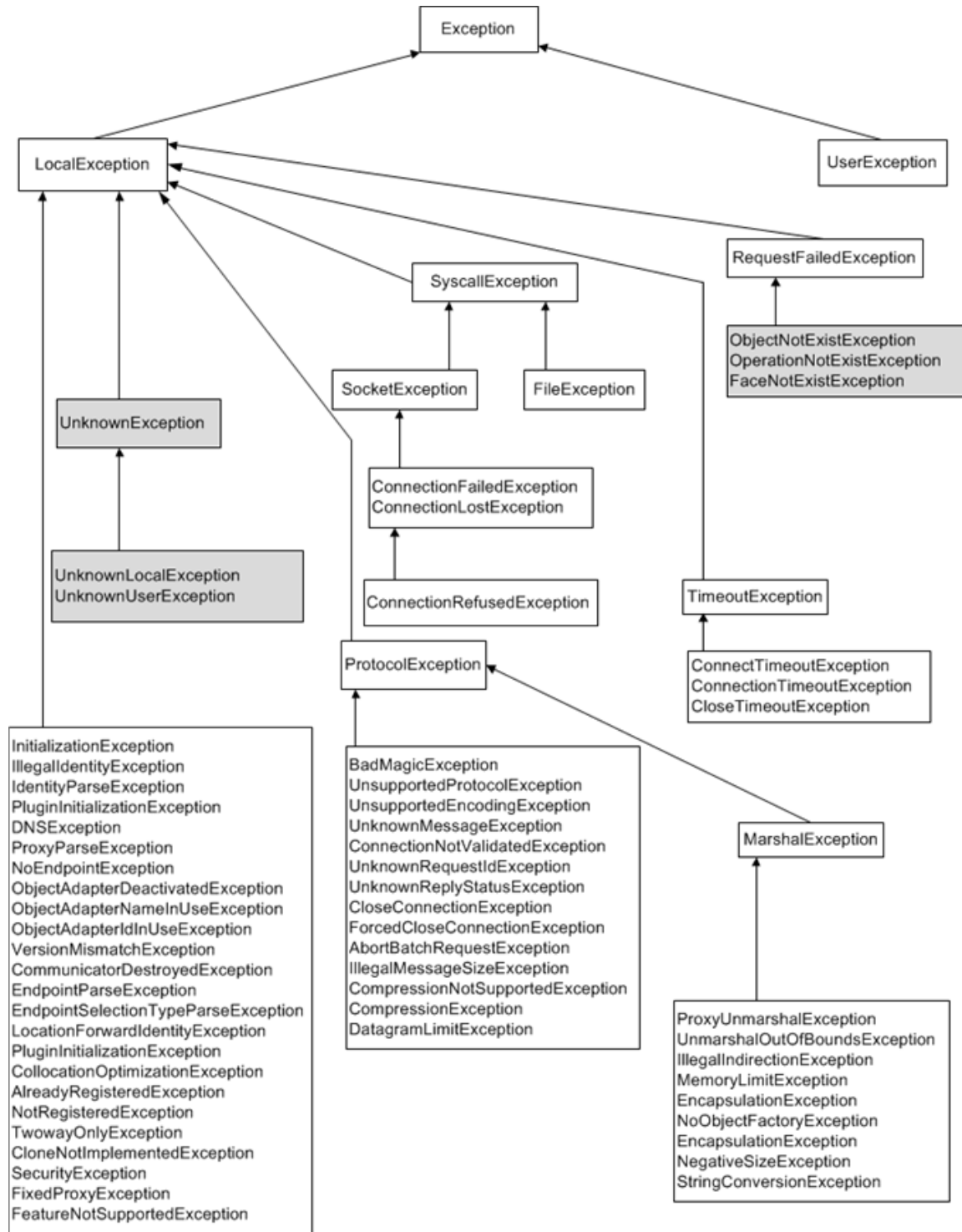

Ice run-time exception hierarchy. (Shaded exceptions can be sent by the server.)



We use the Unified Modeling Language (UML) for the object model diagrams (see [1] and [2] for details).

Note that Ice run-time exception hierarchy groups several exceptions into a single box to save space (which, strictly, is incorrect UML syntax). Also note that some run-time exceptions have data members, which, for brevity, we have omitted in the Ice run-time exception hierarchy. These data members provide additional information about the precise cause of an error.

Many of the run-time exceptions have self-explanatory names, such as `MemoryLimitException`. Others indicate problems in the Ice run time, such as `EncapsulationException`. Still others can arise only through application programming errors, such as `TwowayOnlyException`. In practice, you will likely never see most of these exceptions. However, there are a few run-time exceptions you will encounter and whose meaning you should know.

Local Versus Remote Exceptions

Common Exceptions

Most error conditions are detected on the client side. For example, if an attempt to contact a server fails, the client-side run time raises a `ConnectTimeoutException`. However, there are three specific error conditions (shown as shaded in the [Ice run-time exception hierarchy diagram](#)) that are detected by the server and made known explicitly to the client-side run time via the Ice protocol: `ObjectNotExistException`, `FacetNotExistException`, and `OperationNotExistException`.

ObjectNotExistException

This exception indicates that a request was delivered to the server but the server could not locate a servant with the identity that is embedded in the proxy. In other words, the server could not find an object to dispatch the request to.

An `ObjectNotExistException` is a death certificate: it indicates that the target object in the server does not exist.



The Ice run time raises `ObjectNotExistException` only if there are no `facets` in existence with a matching identity; otherwise, it raises `FacetNotExistException`.

Most likely, this is the case because the object existed some time in the past and has since been destroyed, but the same exception is also raised if a client uses a proxy with the identity of an object that has never been created. If you receive this exception, you are expected to clean up whatever resources you might have allocated that relate to the specific object for which you receive this exception.

FacetNotExistException

The client attempted to contact a non-existent `facets` of an object, that is, the server has at least one servant with the given identity, but no servant with a matching facet name.

OperationNotExistException

This exception is raised if the server could locate an object with the correct identity but, on attempting to dispatch the client's operation invocation, the server found that the target object does not have such an operation. You will see this exception in only two cases:

- You have used an unchecked down-cast on a proxy of the incorrect type.
- Client and server have been built with Slice definitions for an interface that disagree with each other, that is, the client was built with an interface definition for the object that indicates that an operation exists, but the server was built with a different version of the interface definition in which the operation is absent.

Unknown Exceptions

Any error condition on the server side that is not described by one of the three preceding exceptions is made known to the client as one of three generic exceptions (shown as shaded in the [Ice run-time exception hierarchy figure diagram](#)): `UnknownUserException`, `UnknownLocalException`, or `UnknownException`.

UnknownUserException

This exception indicates that an operation implementation has thrown a Slice exception that is not declared in the operation's exception specification (and is not derived from one of the exceptions in the operation's exception specification).

UnknownLocalException

If an operation implementation raises a run-time exception other than `ObjectNotExistException`, `FacetNotExistException`, or `OperationNotExistException` (such as a `NotRegisteredException`), the client receives an `UnknownLocalException`. In other

words, the Ice protocol does not transmit the exact exception that was encountered in the server, but simply returns a bit to the client in the reply to indicate that the server encountered a run-time exception.

A common cause for a client receiving an `UnknownLocalException` is failure to catch and handle all exceptions in the server. For example, if the implementation of an operation encounters an exception it does not handle, the exception propagates all the way up the call stack until the stack is unwound to the point where the Ice run time invoked the operation. The Ice run time catches all Ice exceptions that "escape" from an operation invocation and returns them to the client as an `UnknownLocalException`.

UnknownException

An operation has thrown a non-Ice exception. For example, if the operation in the server throws a C++ exception, such as a `char*`, or a Java exception, such as a `ClassCastException`, the client receives an `UnknownException`.

All other run-time exceptions (not shaded in the [Ice run-time exception hierarchy](#)) are detected by the client-side run time and are raised locally.

It is possible for the implementation of an operation to throw Ice run-time exceptions (as well as user exceptions). For example, if a client holds a proxy to an object that no longer exists in the server, your server application code is required to throw an `ObjectNotExistException`. If you do throw run-time exceptions from your application code, you should take care to throw a run-time exception only if appropriate, that is, do not use run-time exceptions to indicate something that really should be a user exception. Doing so can be very confusing to the client: if the application "hijacks" some run-time exceptions for its own purposes, the client can no longer decide whether the exception was thrown by the Ice run time or by the server application code. This can make debugging very difficult.

See Also

- [User Exceptions](#)
- [Interfaces, Operations, and Exceptions](#)
- [Operations](#)
- [Proxies](#)
- [Interface Inheritance](#)
- [Facets and Versioning](#)

References

1. Booch, G., et al. 1998. *Unified Modeling Language User Guide*. Reading, MA: Addison-Wesley.
2. Object Management Group. 2001. *Unified Modeling Language Specification*. Framingham, MA: Object Management Group.

Proxies

Building on the [Clock](#) example, we can create definitions for a world-time server:

```

Slice

exception GenericError {
    string reason;
};

struct TimeOfDay {
    short hour;           // 0 - 23
    short minute;        // 0 - 59
    short second;        // 0 - 59
};

exception BadTimeVal extends GenericError {};

interface Clock {
    idempotent TimeOfDay getTime();
    idempotent void setTime(TimeOfDay time) throws BadTimeVal;
};

dictionary<string, Clock*> TimeMap; // Time zone name to clock map

exception BadZoneName extends GenericError {};

interface WorldTime {
    idempotent void addZone(string zoneName, Clock* zoneClock);
    void removeZone(string zoneName) throws BadZoneName;
    idempotent Clock* findZone(string zoneName) throws BadZoneName;
    idempotent TimeMap listZones();
    idempotent void setZones(TimeMap zones);
};

```

The `WorldTime` interface acts as a collection manager for clocks, one for each time zone. In other words, the `WorldTime` interface manages a collection of pairs. The first member of each pair is a time zone name; the second member of the pair is the clock that provides the time for that zone. The interface contains operations that permit you to add or remove a clock from the map (`addZone` and `removeZone`), to search for a particular time zone by name (`findZone`), and to read or write the entire map (`listZones` and `setZones`).

The `WorldTime` example illustrates an important `Slice` concept: note that `addZone` accepts a parameter of type `Clock*` and `findZone` returns a parameter of type `Clock*`. In other words, interfaces are types in their own right and can be passed as parameters. The `*` operator is known as the *proxy operator*. Its left-hand argument must be an interface (or `class`) and its return type is a proxy. A proxy is like a pointer that can denote an object. The semantics of proxies are very much like those of C++ class instance pointers:

- A proxy can be `null`.
- A proxy can dangle (point at an object that is no longer there).
- Operations dispatched via a proxy use late binding: if the actual run-time type of the object denoted by the proxy is more derived than the proxy's type, the implementation of the most-derived interface will be invoked.

When a client passes a `Clock` proxy to the `addZone` operation, the proxy denotes an actual `Clock` object in a server. The `Clock` *Ice object* denoted by that proxy may be implemented in the same server process as the `WorldTime` interface, or in a different server process. Where

the `clock` object is physically implemented matters neither to the client nor to the server implementing the `WorldTime` interface; if either invokes an operation on a particular clock, such as `getTime`, an RPC call is sent to whatever server implements that particular clock. In other words, a proxy acts as a local "ambassador" for the remote object; invoking an operation on the proxy forwards the invocation to the actual object implementation. If the object implementation is in a different address space, this results in a remote procedure call; if the object implementation is collocated in the same address space, the Ice run time uses an ordinary local function call from the proxy to the object implementation.

Note that proxies also act very much like pointers in their sharing semantics: if two clients have a proxy to the same object, a state change made by one client (such as setting the time) will be visible to the other client.

Proxies are strongly typed (at least for statically typed languages, such as C++ and Java). This means that you cannot pass something other than a `clock` proxy to the `addZone` operation; attempts to do so are rejected at compile time.

See Also

- [Classes](#)
- [Interfaces, Operations, and Exceptions](#)
- [User Exceptions](#)
- [Run-Time Exceptions](#)
- [Interface Inheritance](#)

Interface Inheritance

On this page:

- [Interface Inheritance](#)
- [Interface Inheritance Limitations](#)
- [Implicit Inheritance from Object](#)
- [Null Proxies](#)
- [Self-Referential Interfaces](#)
- [Empty Interfaces](#)
- [Interface Versus Implementation Inheritance](#)

Interface Inheritance

Interfaces support inheritance. For example, we could extend our [world-time server](#) to support the concept of an alarm clock:

```

Slice
interface AlarmClock extends Clock {
    idempotent TimeOfDay getAlarmTime();
    idempotent void setAlarmTime(TimeOfDay alarmTime)
        throws BadTimeVal;
};

```

The semantics of this are the same as for C++ or Java: `AlarmClock` is a subtype of `Clock` and an `AlarmClock` proxy can be substituted wherever a `Clock` proxy is expected. Obviously, an `AlarmClock` supports the same `getTime` and `setTime` operations as a `Clock` but also supports the `getAlarmTime` and `setAlarmTime` operations.

Multiple interface inheritance is also possible. For example, we can construct a radio alarm clock as follows:

```

Slice
interface Radio {
    void setFrequency(long hertz) throws GenericError;
    void setVolume(long dB) throws GenericError;
};

enum AlarmMode { RadioAlarm, BeepAlarm };

interface RadioClock extends Radio, AlarmClock {
    void setMode(AlarmMode mode);
    AlarmMode getMode();
};

```

`RadioClock` extends both `Radio` and `AlarmClock` and can therefore be passed where a `Radio`, an `AlarmClock`, or a `Clock` is expected. The inheritance diagram for this definition looks as follows:

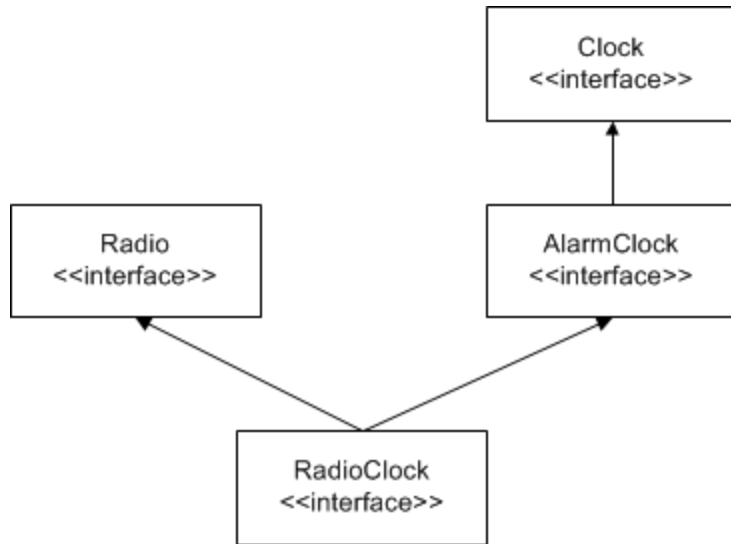

Inheritance diagram for RadioClock.

Interfaces that inherit from more than one base interface may share a common base interface. For example, the following definition is legal:

Slice
<pre> interface B { /* ... */ }; interface I1 extends B { /* ... */ }; interface I2 extends B { /* ... */ }; interface D extends I1, I2 { /* ... */ }; </pre>

This definition results in the familiar diamond shape:

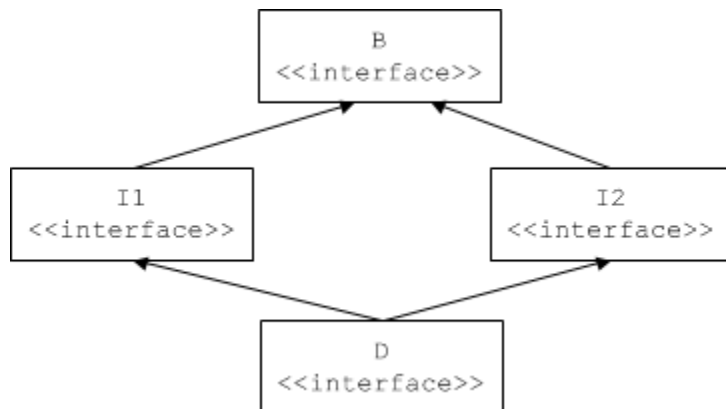

Diamond-shaped inheritance.

Interface Inheritance Limitations

If an interface uses multiple inheritance, it must not inherit the same operation name from more than one base interface. For example, the following definition is illegal:

```

Slice

interface Clock {
    void set(TimeOfDay time);           // set time
};

interface Radio {
    void set(long hertz);              // set frequency
};

interface RadioClock extends Radio, Clock { // Illegal!
    // ...
};

```

This definition is illegal because `RadioClock` inherits two `set` operations, `Radio::set` and `Clock::set`. The Slice compiler makes this illegal because (unlike C++) many programming languages do not have a built-in facility for disambiguating the different operations. In Slice, the simple rule is that all inherited operations must have unique names. (In practice, this is rarely a problem because inheritance is rarely added to an interface hierarchy "after the fact". To avoid accidental clashes, we suggest that you use descriptive operation names, such as `setTime` and `setFrequency`. This makes accidental name clashes less likely.)

Implicit Inheritance from Object

All Slice interfaces are ultimately derived from `Object`. For example, the [inheritance hierarchy](#) would be shown more correctly as:

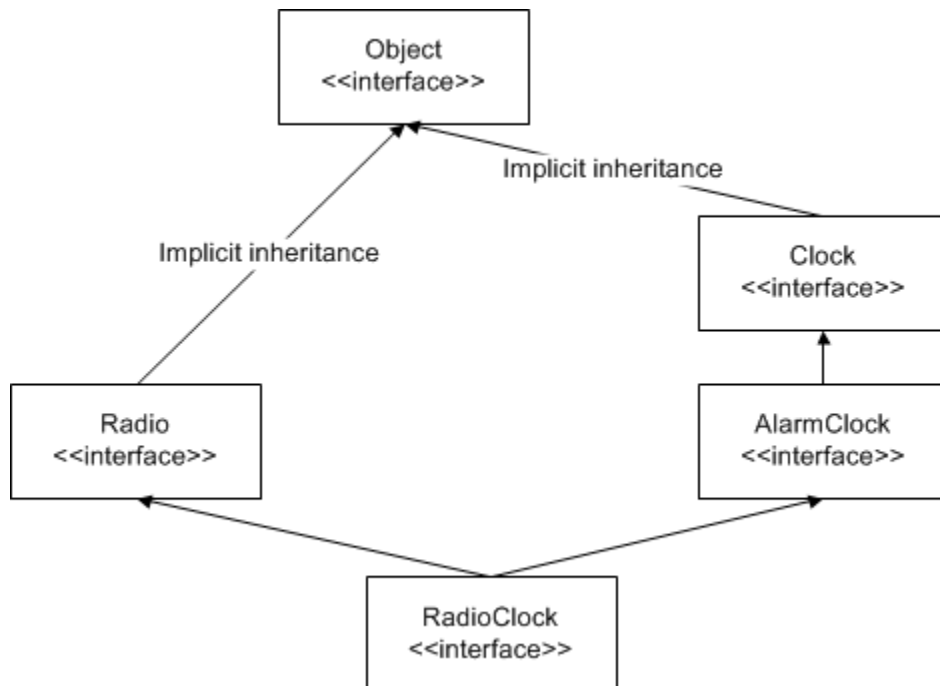

Implicit inheritance from Object.

Because all interfaces have a common base interface, we can pass any type of interface as that type. For example:

Slice

```
interface ProxyStore {
    idempotent void putProxy(string name, Object* o);
    idempotent Object* getProxy(string name);
};
```

`Object` is a Slice keyword (note the capitalization) that denotes the root type of the inheritance hierarchy. The `ProxyStore` interface is a generic proxy storage facility: the client can call `putProxy` to add a proxy of any type under a given name and later retrieve that proxy again by calling `getProxy` and supplying that name. The ability to generically store proxies in this fashion allows us to build general-purpose facilities, such as a [naming service](#) that can store proxies and deliver them to clients. Such a service, in turn, allows us to avoid hard-coding proxy details into clients and servers.

Inheritance from type `Object` is always implicit. For example, the following Slice definition is illegal:

Slice

```
interface MyInterface extends Object { /* ... */ }; // Error!
```

It is understood that all interfaces inherit from type `Object`; you are not allowed to restate that.

Type `Object` is mapped to an abstract type by the various language mappings, so you cannot instantiate an Ice object of that type.

Null Proxies

Looking at the `ProxyStore` interface once more, we notice that `getProxy` does not have an exception specification. The question then is what should happen if a client calls `getProxy` with a name under which no proxy is stored? Obviously, we could add an exception to indicate this condition to `getProxy`. However, another option is to return a *null proxy*. Ice has the built-in notion of a null proxy, which is a proxy that "points nowhere". When such a proxy is returned to the client, the client can test the value of the returned proxy to check whether it is null or denotes a valid object.

A more interesting question is: "which approach is more appropriate, throwing an exception or returning a null proxy?" The answer depends on the expected usage pattern of an interface. For example, if, in normal operation, you do not expect clients to call `getProxy` with a non-existent name, it is better to throw an exception. (This is probably the case for our `ProxyStore` interface: the fact that there is no `list` operation makes it clear that clients are expected to know which names are in use.)

On the other hand, if you expect that clients will occasionally try to look up something that is not there, it is better to return a null proxy. The reason is that throwing an exception breaks the normal flow of control in the client and requires special handling code. This means that you should throw exceptions only in exceptional circumstances. For example, throwing an exception if a database lookup returns an empty result set is wrong; it is expected and normal that a result set is occasionally empty.

It is worth paying attention to such design issues: well-designed interfaces that get these details right are easier to use and easier to understand. Not only do such interfaces make life easier for client developers, they also make it less likely that latent bugs cause problems later.

Self-Referential Interfaces

Proxies have pointer semantics, so we can define self-referential interfaces. For example:

Slice

```
interface Link {
    idempotent SomeType getValue();
    idempotent Link* next();
};
```

The `Link` interface contains a `next` operation that returns a proxy to a `Link` interface. Obviously, this can be used to create a chain of interfaces; the final link in the chain returns a null proxy from its `next` operation.

Empty Interfaces

The following Slice definition is legal:

Slice

```
interface Empty {};
```

The Slice compiler will compile this definition without complaint. An interesting question is: "why would I need an empty interface?" In most cases, empty interfaces are an indication of design errors. Here is one example:

Slice

```
interface ThingBase {};
```

```
interface Thing1 extends ThingBase {
    // Operations here...
};
```

```
interface Thing2 extends ThingBase {
    // Operations here...
};
```

Looking at this definition, we can make two observations:

- `Thing1` and `Thing2` have a common base and are therefore related.
- Whatever is common to `Thing1` and `Thing2` can be found in interface `ThingBase`.

Of course, looking at `ThingBase`, we find that `Thing1` and `Thing2` do not share any operations at all because `ThingBase` is empty. Given that we are using an object-oriented paradigm, this is definitely strange: in the object-oriented model, the *only* way to communicate with an object is to send a message to the object. But, to send a message, we need an operation. Given that `ThingBase` has no operations, we cannot send a message to it, and it follows that `Thing1` and `Thing2` are *not* related because they have no common operations. But of course, seeing that `Thing1` and `Thing2` have a common base, we conclude that they *are* related, otherwise the common base would not exist. At this point, most programmers begin to scratch their head and wonder what is going on here.

One common use of the above design is a desire to treat `Thing1` and `Thing2` polymorphically. For example, we might continue the previous definition as follows:

Slice

```
interface ThingUser {
    void putThing(ThingBase* thing);
};
```

Now the purpose of having the common base becomes clear: we want to be able to pass both `Thing1` and `Thing2` proxies to `putThing`. Does this justify the empty base interface? To answer this question, we need to think about what happens in the implementation of `putThing`. Obviously, `putThing` cannot possibly invoke an operation on a `ThingBase` because there are no operations. This means that `putThing` can do one of two things:

1. `putThing` can simply remember the value of `thing`.
2. `putThing` can try to down-cast to either `Thing1` or `Thing2` and then invoke an operation. The pseudo-code for the implementation of `putThing` would look something like this:

```
void putThing(ThingBase thing)
{
    if (is_a(Thing1, thing)) {
        // Do something with Thing1...
    } else if (is_a(Thing2, thing)) {
        // Do something with Thing2...
    } else {
        // Might be a ThingBase?
        // ...
    }
}
```

The implementation tries to down-cast its argument to each possible type in turn until it has found the actual run-time type of the argument. Of course, any object-oriented text book worth its price will tell you that this is an abuse of inheritance and leads to maintenance problems.

If you find yourself writing operations such as `putThing` that rely on artificial base interfaces, ask yourself whether you really need to do things this way. For example, a more appropriate design might be:

Slice

```
interface Thing1 {
    // Operations here...
};

interface Thing2 {
    // Operations here...
};

interface ThingUser {
    void putThing1(Thing1* thing);
    void putThing2(Thing2* thing);
};
```

With this design, `Thing1` and `Thing2` are not related, and `ThingUser` offers a separate operation for each type of proxy. The implementation of these operations does not need to use any down-casts, and all is well in our object-oriented world.

Another common use of empty base interfaces is the following:

Slice

```
interface PersistentObject {}

interface Thing1 extends PersistentObject {
    // Operations here...
};

interface Thing2 extends PersistentObject {
    // Operations here...
};
```

Clearly, the intent of this design is to place persistence functionality into the `PersistentObject` base *implementation* and require objects that want to have persistent state to inherit from `PersistentObject`. On the face of things, this is reasonable: after all, using inheritance in this way is a well-established design pattern, so what can possibly be wrong with it? As it turns out, there are a number of things that are wrong with this design:

- The above inheritance hierarchy is used to add *behavior* to `Thing1` and `Thing2`. However, in a strict OO model, behavior can be invoked only by sending messages. But, because `PersistentObject` has no operations, no messages can be sent. This raises the question of how the implementation of `PersistentObject` actually goes about doing its job; presumably, it knows something about the implementation (that is, the internal state) of `Thing1` and `Thing2`, so it can write that state into a database. But, if so, `PersistentObject`, `Thing1`, and `Thing2` can no longer be implemented in different address spaces because, in that case, `PersistentObject` can no longer get at the state of `Thing1` and `Thing2`. Alternatively, `Thing1` and `Thing2` use some functionality provided by `PersistentObject` in order to make their internal state persistent. But `PersistentObject` does not have any operations, so how would `Thing1` and `Thing2` actually go about achieving this? Again, the only way that can work is if `PersistentObject`, `Thing1`, and `Thing2` are implemented in a single address space and share implementation state behind the scenes, meaning that they cannot be implemented in different address spaces.
- The above inheritance hierarchy splits the world into two halves, one containing persistent objects and one containing non-persistent ones. This has far-reaching ramifications:
 - Suppose you have an existing application with already implemented, non-persistent objects. Requirements change over time and you find that you now would like to make some of your objects persistent. With the above design, you cannot do this unless you change the type of your objects because they now must inherit from `PersistentObject`. Of course, this is extremely bad news: not only do you have to change the implementation of your objects in the server, you also need to locate and update all the clients that are currently using your objects because they suddenly have a completely new type. What is worse, there is no way to keep things backward compatible: either all clients change with the server, or none of them do. It is impossible for some clients to remain "unupgraded".
 - The design does not scale to multiple features. Imagine that we have a number of additional behaviors that objects can inherit, such as serialization, fault-tolerance, persistence, and the ability to be searched by a search engine. We quickly end up in a mess of multiple inheritance. What is worse, each possible combination of features creates a completely separate type hierarchy. This means that you can no longer write operations that generically operate on a number of object types. For example, you cannot pass a persistent object to something that expects a non-persistent object, *even if the receiver of the object does not care about the persistence aspects of the object*. This quickly leads to fragmented and hard-to-maintain type systems. Before long, you will either find yourself rewriting your application or end up with something that is both difficult to use and difficult to maintain.

The foregoing discussion will hopefully serve as a warning: Slice is an *interface* definition language that has nothing to do with *implementation* (but empty interfaces almost always indicate that implementation state is shared via mechanisms other than defined interfaces). If you find yourself writing an empty interface definition, at least step back and think about the problem at hand; there may be a more appropriate design that expresses your intent more cleanly. If you do decide to go ahead with an empty interface regardless, be aware that, almost

certainly, you will lose the ability to later change the distribution of the object model over physical server processes because you cannot place an address space boundary between interfaces that share hidden state.

Interface Versus Implementation Inheritance

Keep in mind that Slice interface inheritance applies only to *interfaces*. In particular, if two interfaces are in an inheritance relationship, this in no way implies that the implementations of those interfaces must also inherit from each other. You can choose to use implementation inheritance when you implement your interfaces, but you can also make the implementations independent of each other. (To C++ programmers, this often comes as a surprise because C++ uses implementation inheritance by default, and interface inheritance requires extra effort to implement.)

In summary, Slice inheritance simply establishes type compatibility. It says nothing about how interfaces are implemented and, therefore, keeps implementation choices open to whatever is most appropriate for your application.

See Also

- [Interfaces, Operations, and Exceptions](#)
- [Operations](#)
- [User Exceptions](#)
- [Run-Time Exceptions](#)
- [Proxies](#)
- [IceGrid](#)

Classes

In addition to [interfaces](#), Slice permits the definition of classes. Classes are like interfaces in that they can have operations and are like structures in that they can have data members. This leads to hybrid objects that can be treated as interfaces and passed by reference, or can be treated as values and passed by value.

Classes support inheritance and are therefore polymorphic: at run time, you can pass a class instance to an operation as long as the actual class type is derived from the formal parameter type in the operation's signature. This also permits classes to be used as type-safe unions, similarly to Pascal's discriminated variant records.

Topics

- [Simple Classes](#)
- [Class Inheritance](#)
- [Class Inheritance Semantics](#)
- [Classes as Unions](#)
- [Self-Referential Classes](#)
- [Classes Versus Structures](#)
- [Classes with Operations](#)
- [Architectural Implications of Classes](#)
- [Classes Implementing Interfaces](#)
- [Class Inheritance Limitations](#)
- [Pass-by-Value Versus Pass-by-Reference](#)
- [Passing Interfaces by Value](#)
- [Classes with Compact Type IDs](#)

Simple Classes

A Slice class definition is similar to a structure definition, but uses the `class` keyword. For example:

```

class TimeOfDay {
    short hour;           // 0 - 23
    short minute;        // 0 - 59
    short second;        // 0 - 59
};

```

Apart from the keyword `class`, this definition is identical to the [structure](#) example. You can use a Slice class wherever you can use a Slice structure (but, as we will see shortly, for performance reasons, you should not use a class where a structure is sufficient). Unlike structures, classes can be empty:

```

class EmptyClass {}; // OK
struct EmptyStruct {}; // Error

```

Much the same design considerations as for [empty interfaces](#) apply to empty classes: you should at least stop and rethink your approach before committing yourself to an empty class.

A class can define any number of data members, including [optional data members](#). You can also specify a default value for a data member if its type is one of the following:

- An [integral](#) type (byte, short, int, long)
- A [floating point](#) type (float or double)
- `string`
- `bool`
- `enum`

For example:

```

class Location {
    string name;
    Point pt;
    bool display = true;
    string source = "GPS";
};

```

The legal syntax for literal values is the same as for [Slice constants](#), and you may also use a constant as a default value. The language mapping guarantees that data members are initialized to their declared default values using a language-specific mechanism.

See Also

- [Structures](#)
- [Constants and Literals](#)
- [Optional Data Members](#)

Class Inheritance

Unlike [structures](#), classes support inheritance. For example:

Slice
<pre>class TimeOfDay { short hour; // 0 - 23 short minute; // 0 - 59 short second; // 0 - 59 }; class DateTime extends TimeOfDay { short day; // 1 - 31 short month; // 1 - 12 short year; // 1753 onwards };</pre>

This example illustrates one major reason for using a class: a class can be extended by inheritance, whereas a structure is not extensible. The previous example defines `DateTime` to extend the `TimeOfDay` class with a date.

 If you are puzzled by the comment about the year 1753, search the Web for "1752 date change". The intricacies of calendars for various countries prior to that year can keep you occupied for months...

Classes only support single inheritance. The following is illegal:

Slice
<pre>class TimeOfDay { short hour; // 0 - 23 short minute; // 0 - 59 short second; // 0 - 59 }; class Date { short day; short month; short year; }; class DateTime extends TimeOfDay, Date { // Error! // ... };</pre>

A derived class also cannot redefine a data member of its base class:

Slice

```
class Base {
    int integer;
};

class Derived extends Base {
    int integer;           // Error, integer redefined
};
```

See Also

- [Structures](#)

Class Inheritance Semantics

Classes use the same pass-by-value semantics as [structures](#). If you pass a class instance to an operation, the class and all its members are passed. The usual type compatibility rules apply: you can pass a derived instance where a base instance is expected. If the receiver has static type knowledge of the actual derived run-time type, it receives the derived instance; otherwise, if the receiver does not have static type knowledge of the derived type, the instance is sliced to the base type. For an example, suppose we have the following definitions:

Slice
<pre> // In file Clock.ice: class TimeOfDay { short hour; // 0 - 23 short minute; // 0 - 59 short second; // 0 - 59 }; interface Clock { TimeOfDay getTime(); void setTime(TimeOfDay time); }; // In file DateTime.ice: #include <Clock.ice> class DateTime extends TimeOfDay { short day; // 1 - 31 short month; // 1 - 12 short year; // 1753 onwards }; </pre>

Because `DateTime` is a sub-class of `TimeOfDay`, the server can return a `DateTime` instance from `getTime`, and the client can pass a `DateTime` instance to `setTime`. In this case, if both client and server are linked to include the code generated for both `Clock.ice` and `DateTime.ice`, they each receive the actual derived `DateTime` instance, that is, the actual run-time type of the instance is preserved.

Contrast this with the case where the server is linked to include the code generated for both `Clock.ice` and `DateTime.ice`, but the client is linked only with the code generated for `Clock.ice`. In other words, the server understands the type `DateTime` and can return a `DateTime` instance from `getTime`, but the client only understands `TimeOfDay`. In this case, the derived `DateTime` instance returned by the server is sliced to its `TimeOfDay` base type in the client. (The information in the derived part of the instance is simply lost to the client.)

Class hierarchies are useful if you need polymorphic *values* (instead of polymorphic *interfaces*). For example:

Slice

```

class Shape {
    // Definitions for shapes, such as size, center, etc.
};

class Circle extends Shape {
    // Definitions for circles, such as radius...
};

class Rectangle extends Shape {
    // Definitions for rectangles, such as width and length...
};

sequence<Shape> ShapeSeq;

interface ShapeProcessor {
    void processShapes(ShapeSeq ss);
};

```

Note the definition of `ShapeSeq` and its use as a parameter to the `processShapes` operation: the class hierarchy allows us to pass a polymorphic sequence of shapes (instead of having to define a separate operation for each type of shape).

The receiver of a `ShapeSeq` can iterate over the elements of the sequence and down-cast each element to its actual run-time type. (The receiver can also ask each element for its [type ID](#) to determine its type.)

See Also

- [Structures](#)
- [Type IDs](#)

Classes as Unions

Slice does not offer a dedicated union construct because it is redundant. By deriving classes from a common base class, you can create the same effect as with a union:

Slice
<pre>interface ShapeShifter { Shape translate(Shape s, long xDistance, long yDistance); };</pre>

The parameter `s` of the `translate` operation can be viewed as a union of two members: a `Circle` and a `Rectangle`. The receiver of a `Shape` instance can use the `type ID` of the instance to decide whether it received a `Circle` or a `Rectangle`. Alternatively, if you want something more along the lines of a conventional discriminated union, you can use the following approach:

Slice
<pre>class UnionDiscriminator { int d; }; class Member1 extends UnionDiscriminator { // d == 1 string s; float f; }; class Member2 extends UnionDiscriminator { // d == 2 byte b; int i; };</pre>

With this approach, the `UnionDiscriminator` class provides a discriminator value. The "members" of the union are the classes that are derived from `UnionDiscriminator`. For each derived class, the discriminator takes on a distinct value. The receiver of such a union uses the discriminator value in a `switch` statement to select the active union member.

See Also

- [Type IDs](#)

Self-Referential Classes

Classes can be self-referential.

For example:

Slice
<pre>class Link { SomeType value; Link next; };</pre>

This looks very similar to the [self-referential interface example](#), but the semantics are very different. Note that `value` and `next` are data members, not operations, and that the type of `next` is `Link` (*not* `Link*`). As you would expect, this forms the same linked list arrangement as the `Link` interface in [Self-Referential Interfaces](#): each instance of a `Link` class contains a `next` member that points at the next link in the chain; the final link's `next` member contains a null value. So, what looks like a class including itself really expresses pointer semantics: the `next` data member contains a pointer to the next link in the chain.

You may be wondering at this point what the difference is then between the `Link` interface in [Self-Referential Interfaces](#) and the `Link` class shown above. The difference is that classes have *value* semantics, whereas proxies have *reference* semantics. To illustrate this, consider the `Link` *interface* from [Self-Referential Interfaces](#) once more:

Slice
<pre>interface Link { idempotent SomeType getValue(); idempotent Link* next(); };</pre>

Here, `getValue` and `next` are both operations and the return value of `next` is `Link*`, that is, `next` returns a *proxy*. A proxy has *reference* semantics, that is, it denotes an object somewhere. If you invoke the `getValue` operation on a `Link` proxy, a message is sent to the (possibly remote) servant for that proxy. In other words, for proxies, the object stays put in its server process and we access the state of the object via remote procedure calls. Compare this with the definition of our `Link` *class*:

Slice
<pre>class Link { SomeType value; Link next; };</pre>

Here, `value` and `next` are data members and the type of `next` is `Link`, which has *value* semantics. In particular, while `next` looks and feels like a pointer, *it cannot denote an instance in a different address space*. This means that if we have a chain of `Link` instances, all of the instances are in our local address space and, when we read or write a value data member, we are performing local address space operations. This means that an operation that returns a `Link` instance, such as `getHead`, does not just return the head of the chain, *but the entire chain*, as shown:

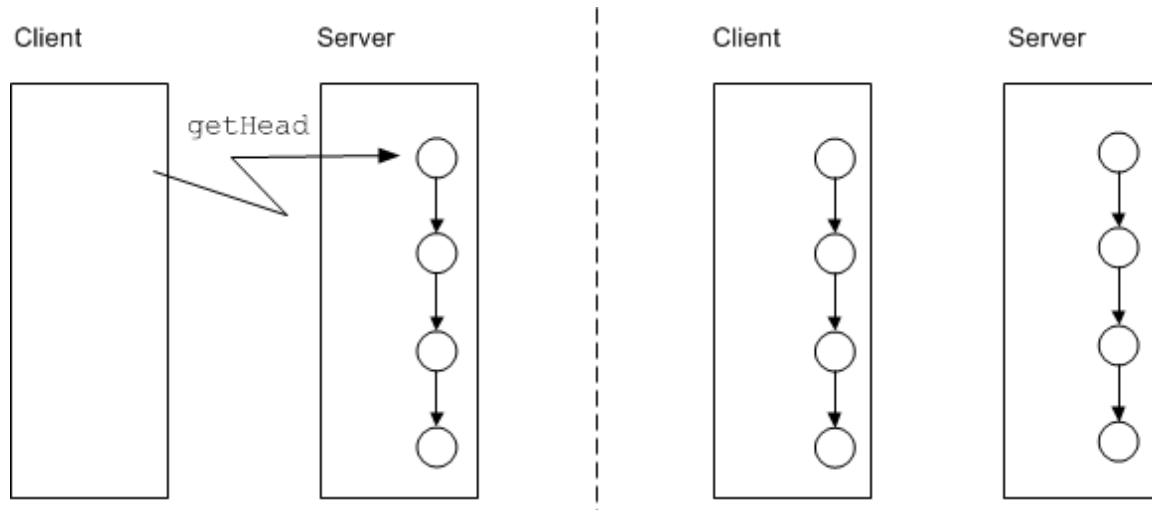

Class version of `Link` before and after calling `getHead`.

On the other hand, for the interface version of `Link`, we do not know where all the links are physically implemented. For example, a chain of four links could have each object instance in its own physical server process; those server processes could be each in a different continent. If you have a proxy to the head of this four-link chain and traverse the chain by invoking the `next` operation on each link, you will be sending four remote procedure calls, one to each object.

Self-referential classes are particularly useful to model graphs. For example, we can create a simple expression tree along the following lines:

```

Slice
enum UnaryOp { UnaryPlus, UnaryMinus, Not };
enum BinaryOp { Plus, Minus, Multiply, Divide, And, Or };

class Node {};

class UnaryOperator extends Node {
    UnaryOp operator;
    Node operand;
};

class BinaryOperator extends Node {
    BinaryOp op;
    Node operand1;
    Node operand2;
};

class Operand extends Node {
    long val;
};

```

The expression tree consists of leaf nodes of type `Operand`, and interior nodes of type `UnaryOperator` and `BinaryOperator`, with one or two descendants, respectively. All three of these classes are derived from a common base class `Node`. Note that `Node` is an empty class. This is one of the few cases where an empty base class is justified. (See the discussion on [empty interfaces](#); once we add [operations](#) to this class hierarchy, the base class is no longer empty.)

If we write an operation that, for example, accepts a `Node` parameter, passing that parameter results in transmission of the entire tree to the server:

Slice

```
interface Evaluator {
    long eval(Node expression); // Send entire tree for evaluation
};
```

Self-referential classes are not limited to acyclic graphs; the Ice run time permits loops: it ensures that no resources are leaked and that infinite loops are avoided during marshaling.

See Also

- [Classes with Operations](#)
- [Self-Referential Interfaces](#)

Classes Versus Structures

One obvious question to ask is: why does Ice provide [structures](#) as well as classes, when classes obviously can be used to model structures? The answer has to do with the cost of implementation: classes provide a number of features that are absent for structures:

- Classes support inheritance.
- Classes can be self-referential.
- Classes can have [operations](#).
- Classes can [implement interfaces](#).

Obviously, an implementation cost is associated with the additional features of classes, both in terms of the size of the generated code and the amount of memory and CPU cycles consumed at run time. On the other hand, structures are simple collections of values ("plain old structs") and are implemented using very efficient mechanisms. This means that, if you use structures, you can expect better performance and smaller memory footprint than if you would use classes (especially for languages with direct support for "plain old structures", such as C++ and C#). Use a class only if you need at least one of its more powerful features.

See Also

- [Structures](#)
- [Classes with Operations](#)
- [Classes Implementing Interfaces](#)

Classes with Operations

Classes, in addition to data members, can have operations. The syntax for operation definitions in classes is identical to the syntax for operations in interfaces. For example, we can modify the expression tree from [Self-Referential Classes](#) as follows:

```

Slice

enum UnaryOp { UnaryPlus, UnaryMinus, Not };
enum BinaryOp { Plus, Minus, Multiply, Divide, And, Or };

class Node {
    idempotent long eval();
};

class UnaryOperator extends Node {
    UnaryOp operator;
    Node operand;
};

class BinaryOperator extends Node {
    BinaryOp op;
    Node operand1;
    Node operand2;
};

class Operand {
    long val;
};
```

The only change compared to the version in [Self-Referential Classes](#) is that the `Node` class now has an `eval` operation. The semantics of this are as for a virtual member function in C++: each derived class inherits the operation from its base class and can choose to override the operation's definition. For our expression tree, the `Operand` class provides an implementation that simply returns the value of its `val` member, and the `UnaryOperator` and `BinaryOperator` classes provide implementations that compute the value of their respective subtrees. If we call `eval` on the root node of an expression tree, it returns the value of that tree, regardless of whether we have a complex expression or a tree that consists of only a single `Operand` node.

Operations on classes are normally executed in the caller's address space, that is, operations on classes are *local* operations that do not result in a remote procedure call.

 It is also possible to invoke an operation on a [remote class instance](#).

Of course, this immediately raises an interesting question: what happens if a client receives a class instance with operations from a server, but client and server are implemented in different languages? Classes with operations require the receiver to supply a factory for instances of the class. The Ice run time only marshals the data members of the class. If a class has operations, the receiver of the class must provide a class factory that can instantiate the class in the receiver's address space, and the receiver is responsible for providing an implementation of the class's operations.

Therefore, if you use classes with operations, it is understood that client and server each have access to an implementation of the class's operations. No code is shipped over the wire (which, in an environment of heterogeneous nodes using different operating systems and languages is infeasible).

See Also

- [Self-Referential Classes](#)
- [Pass-by-Value Versus Pass-by-Reference](#)

Architectural Implications of Classes

Classes have a number of architectural implications that are worth exploring in some detail.

On this page:

- [Classes without Operations](#)
- [Classes with Operations](#)
- [Classes for Persistence](#)

Classes without Operations

Classes that do not use inheritance and only have data members (whether self-referential or not) pose no architectural problems: they simply are values that are marshaled like any other value, such as a sequence, structure, or dictionary. Classes using derivation also pose no problems: if the receiver of a derived instance has knowledge of the derived type, it simply receives the derived type; otherwise, the instance is sliced to the most-derived type that is understood by the receiver. This makes class inheritance useful as a system is extended over time: you can create derived class without having to upgrade all parts of the system at once.

Classes with Operations

Classes with operations require additional thought. Here is an example: suppose that you are creating an Ice application. Also assume that the Slice definitions use quite a few classes with operations. You sell your clients and servers (both written in Java) and end up with thousands of deployed systems.

As time passes and requirements change, you notice a demand for clients written in C++.

For commercial reasons, you would like to leave the development of C++ clients to customers or a third party but, at this point, you discover a glitch: your application has lots of classes with operations along the following lines:

Slice
<pre>class ComplexThingForExpertsOnly { // Lots of arcane data members here... MysteriousThing mysteriousOperation(/* parameters */); ArcaneThing arcaneOperation(/* parameters */); ComplexThing complexOperation(/* parameters */); // etc... };</pre>

It does not matter what exactly these operations do. (Presumably, you decided to off-load some of the processing for your application onto the client side for performance reasons.) Now that you would like other developers to write C++ clients, it turns out that your application will work only if these developers provide implementations of all the client-side operations and, moreover, if the semantics of these operations exactly match the semantics of your Java implementations. Depending on what these operations do, providing exact semantic equivalents in a different language may not be trivial, so you decide to supply the C++ implementations yourself.

But now, you discover another problem: the C++ clients need to be supported for a variety of operating systems that use a variety of different C++ compilers. Suddenly, your task has become quite daunting: you really need to supply implementations for all the combinations of operating systems and compiler versions that are used by clients. Given the different state of compliance with the ISO C++ standard of the various compilers, and the idiosyncrasies of different operating systems, you may find yourself facing a development task that is much larger than anticipated. And, of course, the same scenario will arise again should you need client implementations in yet another language.

The moral of this story is not that classes with operations should be avoided; they can provide significant performance gains and are not necessarily bad. But, keep in mind that, once you use classes with operations, you are, in effect, using client-side native code and, therefore, you can no longer enjoy the implementation transparencies that are provided by interfaces. This means that classes with operations should be used only if you can tightly control the deployment environment of clients. If not, you are better off using interfaces and classes without operations. That way, all the processing stays on the server and the contract between client and server is provided solely by the Slice definitions, not by the semantics of the additional client-side code that is required for classes with operations.

Classes for Persistence

Ice also provides a built-in [persistence mechanism](#) that allows you to store the state of a class in a database with very little implementation effort. To get access to these persistence features, you must define a Slice class whose members store the state of the class.

See Also

- [Freeze](#)

Classes Implementing Interfaces

A Slice class can also be used as a servant in a server, that is, an instance of a class can be used to provide the behavior for an interface, for example:

Slice
<pre>interface Time { idempotent TimeOfDay getTime(); idempotent void setTime(TimeOfDay time); }; class Clock implements Time { TimeOfDay time; };</pre>

The `implements` keyword indicates that the class `Clock` provides an *implementation* of the `Time` interface. The class can provide data members and operations of its own; in the preceding example, the `Clock` class stores the current time that is accessed via the `Time` interface. A class can implement several interfaces, for example:

Slice
<pre>interface Time { idempotent TimeOfDay getTime(); idempotent void setTime(TimeOfDay time); }; interface Radio { idempotent void setFrequency(long hertz); idempotent void setVolume(long dB); }; class RadioClock implements Time, Radio { TimeOfDay time; long hertz; };</pre>

The class `RadioClock` implements both `Time` and `Radio` interfaces.

A class, in addition to implementing an interface, can also extend another class:

Slice

```

interface Time {
    idempotent TimeOfDay getTime();
    idempotent void setTime(TimeOfDay time);
};

class Clock implements Time {
    TimeOfDay time;
};

interface AlarmClock extends Time {
    idempotent TimeOfDay getAlarmTime();
    idempotent void setAlarmTime(TimeOfDay alarmTime);
};

interface Radio {
    idempotent void setFrequency(long hertz);
    idempotent void setVolume(long dB);
};

class RadioAlarmClock extends Clock
                        implements AlarmClock, Radio {
    TimeOfDay alarmTime;
    long hertz;
};

```

These definitions result in the following inheritance graph:

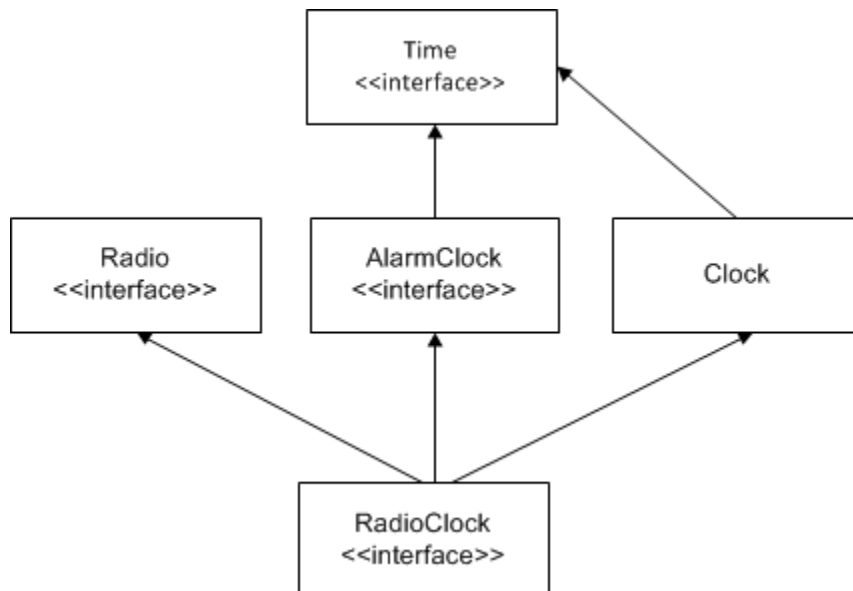

A Class using implementation and interface inheritance.

For this definition, **Radio** and **AlarmClock** are abstract interfaces, and **Clock** and **RadioAlarmClock** are concrete classes. As for Java,

a class can implement multiple interfaces, but can extend at most one class.

See Also

- [Architectural Implications of Classes](#)
- [Class Inheritance Limitations](#)

Class Inheritance Limitations

As for [interface inheritance](#), a class cannot redefine an operation or data member that it inherits from a base interface or class. For example:

```

Slice



```
interface BaseInterface {
 void op();
};

class BaseClass {
 int member;
};

class DerivedClass extends BaseClass implements BaseInterface {
 void someOperation(); // OK
 int op(); // Error!
 int someMember; // OK
 long member; // Error!
};
```

```

See Also

- [Interface Inheritance](#)

Pass-by-Value Versus Pass-by-Reference

As we saw in [Self-Referential Classes](#), classes naturally support pass-by-value semantics: passing a class transmits the data members of the class to the receiver. Any changes made to these data members by the receiver affect only the receiver's copy of the class; the data members of the sender's class are not affected by the changes made by the receiver.

In addition to passing a class by value, you can pass a class by reference. For example:

Slice
<pre>class TimeOfDay { short hour; short minute; short second; string format(); }; interface Example { TimeOfDay* get(); // Note: returns a proxy! };</pre>

Note that the `get` operation returns a *proxy* to a `TimeOfDay` class and not a `TimeOfDay` instance itself. The semantics of this are as follows:

- When the client receives a `TimeOfDay` proxy from the `get` call, it holds a proxy that differs in no way from an ordinary proxy for an interface.
- The client can invoke operations via the proxy, but *cannot* access the data members. This is because proxies do not have the concept of data members, but represent interfaces: even though the `TimeOfDay` class has data members, only its *operations* can be accessed via a the proxy.

The net effect is that, in the preceding example, the server holds an instance of the `TimeOfDay` class. A proxy for that instance was passed to the client. The only thing the client can do with this proxy is to invoke the `format` operation. The implementation of that operation is provided by the server and, when the client invokes `format`, it sends an RPC message to the server just as it does when it invokes an operation on an interface. The implementation of the `format` operation is entirely up to the server. (Presumably, the server will use the data members of the `TimeOfDay` instance it holds to return a string containing the time to the client.)

The preceding example looks somewhat contrived for classes only. However, it makes perfect sense if classes implement interfaces: parts of your application can exchange class instances (and, therefore, state) by value, whereas other parts of the system can treat these instances as remote interfaces.

For example:

Slice

```

interface Time {
    string format();
    // ...
};

class TimeOfDay implements Time {
    short hour;
    short minute;
    short second;
};

interface I1 {
    TimeOfDay get();           // Pass by value
    void put(TimeOfDay time); // Pass by value
};

interface I2 {
    Time* get();              // Pass by reference
};

```

In this example, clients dealing with interface `I1` are aware of the `TimeOfDay` class and pass it by value whereas clients dealing with interface `I2` deal only with the `Time` interface. However, the actual implementation of the `Time` interface in the server uses `TimeOfDay` instances.

Be careful when designing systems that use such mixed pass-by-value and pass-by-reference semantics. Unless you are clear about what parts of the system deal with the interface (pass by reference) aspects and the class (pass by value) aspects, you can end up with something that is more confusing than helpful.

A good example of putting this feature to use can be found in [Freeze](#), which allows you to add classes to an existing interface to implement persistence.

See Also

- [Self-Referential Classes](#)
- [Freeze](#)

Passing Interfaces by Value

Consider the following definitions:

Slice
<pre> interface Time { idempotent TimeOfDay getTime(); // ... }; interface Record { void addTimeStamp(Time t); // Note: Time t, not Time* t // ... }; </pre>

Note that `addTimeStamp` accepts a parameter of type `Time`, not of type `Time*`. The question is, what does it mean to pass an interface *by value*? Obviously, at run time, we cannot pass an actual interface to this operation because interfaces are abstract and cannot be instantiated. Neither can we pass a proxy to a `Time` object to `addTimeStamp` because a proxy cannot be passed where an interface is expected.

However, what we *can* pass to `addTimeStamp` is something that is not abstract and derives from the `Time` interface. For example, at run time, we could pass an instance of the `TimeOfDay` class we saw [earlier](#). Because the `TimeOfDay` class derives from the `Time` interface, the class type is compatible with the formal parameter type `Time` and, at run time, what is sent over the wire to the server is the `TimeOfDay` class instance.

See Also

- [Pass-by-Value Versus Pass-by-Reference](#)

Classes with Compact Type IDs

As of Ice 3.5, you can optionally associate a numeric identifier with a class. The Ice run time substitutes this value, known as a *compact type ID*, in place of its equivalent *string type ID* during marshaling to conserve space. The compact type ID follows immediately after the class name, enclosed in parentheses:

```



Slice



```
module MyModule {
 class CompactExample(4) {
 // ...
 };
};
```

```

In this example, the Ice run time marshals the value 4 instead of its string equivalent "`::MyModule::CompactExample`". The specified value must be a non-negative integer that is unique within the translation unit.

 Using values less than 255 produces the most efficient [encoding](#).

See Also

- [Classes](#)
- [Type IDs](#)
- [Data Encoding for Class Type IDs](#)

Forward Declarations

Both [interfaces](#) and [classes](#) can be forward declared. Forward declarations permit the creation of mutually dependent objects, for example:

Slice
<pre> module Family { interface Child; // Forward declaration sequence<Child*> Children; // OK interface Parent { Children getChildren(); // OK }; interface Child { // Definition Parent* getMother(); Parent* getFather(); }; }; </pre>

Without the forward declaration of `Child`, the definition obviously could not compile because `Child` and `Parent` are mutually dependent interfaces. You can use forward-declared interfaces and classes to define types (such as the `Children` sequence in the previous example). Forward-declared interfaces and classes are also legal as the type of a structure, exception, or class member, as the value type of a dictionary, and as the parameter and return type of an operation. However, you cannot inherit from a forward-declared interface or class until after its definition has been seen by the compiler:

Slice
<pre> interface Base; // Forward declaration interface Derived1 extends Base {}; // Error! interface Base {}; // Definition interface Derived2 extends Base {}; // OK, definition was seen </pre>

Not inheriting from a forward-declared base interface or class until its definition is seen is necessary because, otherwise, the compiler could not enforce that derived interfaces must not redefine operations that appear in base interfaces.



A multi-pass compiler could be used, but the added complexity is not worth it.

See Also

- [Interfaces, Operations, and Exceptions](#)
- [Classes](#)

Optional Data Members

On this page:

- [Overview of Optional Data Members](#)
- [Declaring Optional Data Members](#)
- [Optional Data Members with Default Values](#)

Overview of Optional Data Members

As of Ice 3.5, a data member of a Slice [class](#) or [exception](#) may be declared as [optional](#) to indicate that a program can leave its value unset. Data members not declared as optional are known as *required* members; a program must supply legal values for all required members.

Declaring Optional Data Members

Each optional data member in a type must be assigned a unique, non-negative integer *tag*:

Slice
<pre>class C { string name; bool active; optional(2) string alternateName; optional(5) int overrideCode; };</pre>

It is legal for a base type's tag to be reused by a derived type:

Slice
<pre>exception Base { optional(1) int systemCode; }; exception Derived extends Base { optional(1) string diagnostic; // OK };</pre>

The scope of a tag is limited to its enclosing type and has no effect on base or derived types.

Language mappings specify an API for setting an optional member and testing whether a member is set. Here is an example in C++:

C++

```

CPtr c = new C;
c->name = "xyz";           // required
c->active = true;         // required
c->alternateName = "abc"; // optional
c->overrideCode = 42;     // optional

if(c->alternateName)
    cout << "alt name = " << c->alternateName << endl;

```

As you can see, the C++ language mapping makes setting an optional member as simple as assigning it a value. Refer to the language mapping sections for more details on the optional data member API.



A well-behaved program must test for the presence of an optional member and not assume that it is always set. Dereferencing an unset optional member causes a run-time error.

In all supported language mappings, an optional data member's initial condition is unset if not otherwise assigned during construction. Again using C++ as an example:

C++

```

CPtr c = new C;           // default constructor
assert(!c->alternateName); // not set

c = new C("xyz", true, "abc", 42); // one-shot constructor
assert(c->alternateName);           // set by constructor

```

Optional Data Members with Default Values

You can declare a default value for optional members just as you can for required members:

Slice

```

class C
{
    string name;
    bool active = true;
    optional(2) string alternateName;
    optional(5) int overrideCode = -1;
};

```

An optional data member with a default value is considered to be set by default:

C++

```
CPtr c = new C;           // default constructor
assert(!c->alternateName); // not set
assert(c->overrideCode);  // set to default value
```

Each language mapping provides an API for resetting an optional data member to its unset condition.

See Also

- [Classes](#)
- [User Exceptions](#)
- [Optional Values](#)

Type IDs

Each user-defined Slice type has an internal type identifier, known as its *type ID*. The type ID is simply the fully-qualified name of each type. For example, the type ID of the `Child` interface in the [preceding example](#) is `::Family::Children::Child`. All type IDs for user-defined types start with a leading `::`, so the type ID of the `Family` module is `::Family` (not `Family`). In general, a type ID is formed by starting with the global scope (`::`) and forming the fully-qualified name of a type by appending each module name in which the type is nested, and ending with the name of the type itself; the components of the type ID are separated by `::`.

The type ID of a proxy is formed by appending a `*` to the type ID of an interface or class. For example, the type ID of a `Child` proxy is `::Family::Children::Child*`.

The type ID of the Slice `Object` type is `::Ice::Object` and the type ID of an `Object` proxy is `::Ice::Object*`.

The type IDs for the remaining built-in types, such as `int`, `bool`, and so on, are the same as the corresponding keyword. For example, the type ID of `int` is `int`, and the type ID of `string` is `string`.

Type IDs are used internally by the Ice run time as a unique identifier for each type. For example, when an exception is raised, the marshaled form of the exception that is returned to the client is preceded by its type ID on the wire. The client-side run time first reads the type ID and, based on that, unmarshals the remainder of the data as appropriate for the type of the exception.

Type IDs are also used by the [ice_isA](#) operation.

See Also

- [ice_isA](#)

Operations on Object

The `Object` interface has a number of operations. We cannot define type `Object` in `Slice` because `Object` is a keyword; regardless, here is what (part of) the definition of `Object` would look like if it were legal:

```

Slice



```

sequence<string> StrSeq;

interface Object { // "Pseudo" Slice!
 idempotent void ice_ping();
 idempotent bool ice_isA(string typeID);
 idempotent string ice_id();
 idempotent StrSeq ice_ids();
 // ...
};

```

```

Note that, apart from the illegal use of the keyword `Object` as the interface name, the operation names all contain the `ice_` prefix. This prefix is reserved for use by Ice and cannot clash with a user-defined operation. This means that all `Slice` interfaces can inherit from `Object` without name clashes. We discuss these built-in operations below.

On this page:

- [ice_ping](#)
- [ice_isA](#)
- [ice_id](#)
- [ice_ids](#)

ice_ping

All interfaces support the `ice_ping` operation. That operation is useful for debugging because it provides a basic reachability test for an object: if the object exists and a message can successfully be dispatched to the object, `ice_ping` simply returns without error. If the object cannot be reached or does not exist, `ice_ping` throws a run-time exception that provides the reason for the failure.

ice_isA

The `ice_isA` operation accepts a type identifier (such as the identifier returned by `ice_id`) and tests whether the target object supports the specified type, returning `true` if it does. You can use this operation to check whether a target object supports a particular type. For example, referring to the diagram [Implicit Inheritance from Object](#) once more, assume that you are holding a proxy to a target object of type `AlarmClock`. The table below illustrates the result of calling `ice_isA` on that proxy with various arguments. (We assume that all types in the [Implicit inheritance from Object](#) diagram are defined in a module `Times`):

Argument	Result
<code>::Ice::Object</code>	<code>true</code>
<code>::Times::Clock</code>	<code>true</code>
<code>::Times::AlarmClock</code>	<code>true</code>
<code>::Times::Radio</code>	<code>false</code>
<code>::Times::RadioClock</code>	<code>false</code>

Calling `ice_isA` on a proxy denoting an object of type `AlarmClock`.

As expected, `ice_isA` returns true for `::Times::Clock` and `::Times::AlarmClock` and also returns true for `::Ice::Object` (because all interfaces support that type). Obviously, an `AlarmClock` supports neither the `Radio` nor the `RadioClock` interfaces, so `ice_isA` returns false for these types.

`ice_id`

The `ice_id` operation returns the [type ID](#) of the most-derived type of an interface.

`ice_ids`

The `ice_ids` operation returns a sequence of [type IDs](#) that contains all of the type IDs supported by an interface. For example, for the `RadioClock` interface in [Implicit inheritance from Object](#), `ice_ids` returns a sequence containing the type IDs `::Ice::Object`, `::Times::Clock`, `::Times::AlarmClock`, `::Times::Radio`, and `::Times::RadioClock`.

See Also

- [Type IDs](#)
- [Interface Inheritance](#)
- [Implicit inheritance from Object](#)

Local Types

In order to access certain features of the Ice run time, you must use APIs that are provided by libraries. However, instead of defining an API that is specific to each implementation language, Ice defines its APIs in Slice using the `local` keyword. The advantage of defining APIs in Slice is that a single definition suffices to define the API for all possible implementation languages. The actual language-specific API is then generated by the Slice compiler for each implementation language. Types that are provided by Ice libraries are defined using the Slice `local` keyword.

For example:

```

Slice
module Ice {
    local interface ObjectAdapter {
        // ...
    };
};

```

Any Slice definition (not just interfaces) can have a `local` modifier. If the `local` modifier is present, the Slice compiler does not generate marshaling code for the corresponding type. This means that a local type can *never* be accessed remotely because it cannot be transmitted between client and server. (The Slice compiler prevents use of `local` types in non-`local` contexts.)

In addition, local interfaces and local classes do *not* inherit from `Ice::Object`. Instead, local interfaces and classes have their own, completely separate inheritance hierarchy. At the root of this hierarchy is the type `Ice::LocalObject`, as shown:

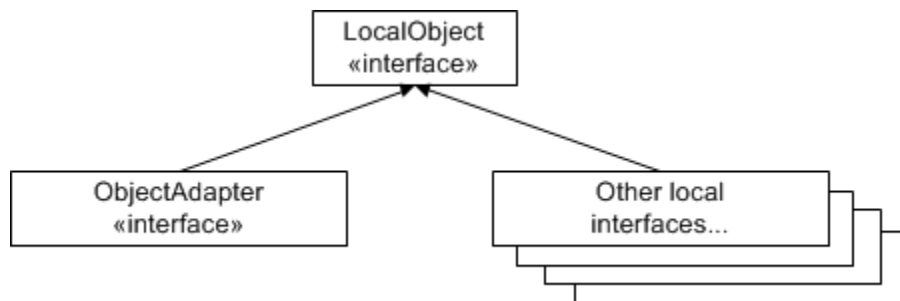

Inheritance from LocalObject.

Because local interfaces form a completely separate inheritance hierarchy, you cannot pass a local interface where a non-local interface is expected, and vice-versa.

You rarely need to define local types for your own applications — the `local` keyword exists mainly to allow definition of APIs for the Ice run time. (Because local objects cannot be invoked remotely, there is little point for an application to define local objects; it might as well define ordinary programming-language objects instead.) However, there is one exception to this rule: [servant locators](#) must be implemented as local objects.

See Also

- [Servant Locators](#)

Names and Scoping

Slice has a number of rules regarding identifiers. You will typically not have to concern yourself with these. However, occasionally, it is good to know how Slice uses naming scopes and resolves identifiers.

On this page:

- [Naming Scope](#)
- [Case Sensitivity](#)
- [Qualified Names](#)
- [Names in Nested Scopes](#)
- [Introduced Identifiers](#)
- [Name Lookup Rules](#)

Naming Scope

The following Slice constructs establish a naming scope:

- the global (file) scope
- modules
- interfaces
- classes
- structures
- exceptions
- parameter lists

Within a naming scope, identifiers must be unique, that is, you cannot use the same identifier for different purposes. For example:

Slice
<pre>interface Bad { void op(int p, string p); // Error! };</pre>

Because a parameter list forms a naming scope, it is illegal to use the same identifier `p` for different parameters. Similarly, data members, operation names, interface and class names, etc. must be unique within their enclosing scope.

Case Sensitivity

Identifiers that differ only in case are considered identical, so you must use identifiers that differ not only in capitalization within a naming scope. For example:

Slice
<pre>struct Bad { int m; string M; // Error! };</pre>

The Slice compiler also enforces consistent capitalization for identifiers. Once you have defined an identifier, you must use the same capitalization for that identifier thereafter. For example, the following is in error:

Slice

```
sequence<string> StringSeq;

interface Bad {
    stringSeq op();    // Error!
};
```

Note that identifiers must not differ from a Slice keyword in case only. For example, the following is in error:

Slice

```
interface Module {    // Error, "module" is a keyword
    // ...
};
```

Qualified Names

The scope-qualification operator `::` allows you to refer to a type in a non-local scope. For example:

Slice

```
module Types {
    sequence<long> LongSeq;
};

module MyApp {
    sequence<Types::LongSeq> NumberTree;
};
```

Here, the qualified name `Types::LongSeq` refers to `LongSeq` defined in module `Types`. The global scope is denoted by a leading `::`, so we could also refer to `LongSeq` as `::Types::LongSeq`.

The scope-qualification operator also allows you to create mutually dependent interfaces that are defined in different modules. The obvious attempt to do this fails:

Slice

```

module Parents {
    interface Children::Child; // Syntax error!
    interface Mother {
        Children::Child* getChild();
    };
    interface Father {
        Children::Child* getChild();
    };
};

module Children {
    interface Child {
        Parents::Mother* getMother();
        Parents::Father* getFather();
    };
};

```

This fails because it is syntactically illegal to forward-declare an interface in a different module. To make it work, we must use a reopened module:

Slice

```

module Children {
    interface Child; // Forward declaration
};

module Parents {
    interface Mother {
        Children::Child* getChild(); // OK
    };
    interface Father {
        Children::Child* getChild(); // OK
    };
};

module Children { // Reopen module
    interface Child { // Define Child
        Parents::Mother* getMother();
        Parents::Father* getFather();
    };
};

```

While this technique works, it is probably of dubious value: mutually dependent interfaces are, by definition, tightly coupled. On the other hand, modules are meant to be used to place related definitions into the same module, and unrelated definitions into different modules. Of course, this begs the question: if the interfaces are so closely related that they depend on each other, why are they defined in different modules? In the interest of clarity, you probably should avoid this construct, even though it is legal.

Names in Nested Scopes

Names defined in an enclosing scope can be redefined in an inner scope. For example, the following is legal:

Slice
<pre> module Outer { sequence<string> Seq; module Inner { sequence<short> Seq; }; }; </pre>

Within module `Inner`, the name `Seq` refers to a sequence of `short` values and hides the definition of `Outer::Seq`. You can still refer to the other definition by using explicit scope qualification, for example:

Slice
<pre> module Outer { sequence<string> Seq; module Inner { sequence<short> Seq; struct Confusing { Seq a; // Sequence of short ::Outer::Seq b; // Sequence of string }; }; }; </pre>

Needless to say, you should try to avoid such redefinitions — they make it harder for the reader to follow the meaning of a specification.

Same-named constructs cannot be nested inside each other. For example, a module named `M` cannot (recursively) contain any construct also named `M`. The same is true for interfaces, classes, structures, exceptions, and operations. For example, the following examples are all in error:

Slice

```

module M {
    interface M { /* ... */ }; // Error!

    interface I {
        void I(); // Error!
        void op(string op); // Error!
    };

    struct S {
        long s; // Error, even if case differs!
    };
};

module Outer {
    module Inner {
        interface Outer { // Error!
            // ...
        };
    };
};

```

The reason for this restriction is that nested types that have the same name are difficult to map into some languages. For example, C++ and Java reserve the name of a class as the name of the constructor, so an interface `I` could not contain an operation named `I` without artificial rules to avoid the name clash.

Similarly, some languages (such as C# prior to version 2.0) do not permit a qualified name to be anchored at the global scope. If a nested module or type is permitted to have the same name as the name of an enclosing module, it can become impossible to generate legal code in some cases.

In the interest of simplicity, Slice prohibits the name of a nested module or type to be the same as the name of one of its enclosing modules.

Introduced Identifiers

Within a naming scope, an identifier is introduced at the point of first use; thereafter, within that naming scope, the identifier cannot change meaning.

For example:

Slice

```

module M {
    sequence<string> Seq;

    interface Bad {
        Seq op1();    // Seq and op1 introduced here
        int Seq();    // Error, Seq has changed meaning
    };
};

```

The declaration of `op1` uses `Seq` as its return type, thereby introducing `Seq` into the scope of interface `Bad`. Thereafter, `Seq` can only be used as a type name that denotes a sequence of strings, so the compiler flags the declaration of the second operation as an error.

Note that fully-qualified identifiers are not introduced into the current scope:

Slice

```

module M {
    sequence<string> Seq;

    interface Bad {
        ::M::Seq op1(); // Only op1 introduced here
        int Seq();      // OK
    };
};

```

In general, a fully-qualified name (one that is anchored at the global scope and, therefore, begins with a `::` scope resolution operator) does not introduce any name into the current scope. On the other hand, a qualified name that is not anchored at the global scope introduces only the first component of the name:

Slice

```

module M {
    sequence<string> Seq;

    interface Bad {
        M::Seq op1(); // M and op1 introduced here, but not Seq
        int Seq();    // OK
    };
};

```

Name Lookup Rules

When searching for the definition of a name that is not anchored at the global scope, the compiler first searches backward in the current scope of a definition of the name. If it can find the name in the current scope, it uses that definition. Otherwise, the compiler successively searches enclosing scopes for the name until it reaches the global scope. Here is an example to illustrate this:

Slice

```

module M1 {
    sequence<double> Seq;

    module M2 {
        sequence<string> Seq;    // OK, hides ::M1::Seq

        interface Base {
            Seq op1();          // Returns sequence of string
        };
    };

    module M3 {
        interface Derived extends M2::Base {
            Seq op2();          // Returns sequence of double
        };

        sequence<bool> Seq;     // OK, hides ::M1::Seq

        interface I {
            Seq op();           // Returns sequence of bool
        };

        interface I {
            Seq op();           // Returns sequence of double
        };
    };
};

```

Note that `M2::Derived::op2` returns a sequence of `double`, even though `M1::Base::op1` returns a sequence of `string`. That is, the meaning of a type in a base interface is irrelevant to determining its meaning in a derived interface — the compiler always searches for a definition only in the current scope and enclosing scopes, and never takes the meaning of a name from a base interface or class.

See Also

- [Lexical Rules](#)

Metadata

Slice has the concept of a *metadata* directive. For example:

Slice
<pre>["java:type:java.util.LinkedList"] sequence<int> IntSeq;</pre>

A metadata directive can appear as a prefix to any Slice definition. Metadata directives appear in a pair of square brackets and contain one or more string literals separated by commas. For example, the following is a syntactically valid metadata directive containing two strings:

Slice
<pre>["a", "b"] interface Example {};</pre>

Metadata directives are not part of the Slice language per se: the presence of a metadata directive has no effect on the client-server contract, that is, metadata directives do not change the Slice type system in any way. Instead, metadata directives are targeted at specific back-ends, such as the code generator for a particular language mapping. In the preceding example, the `java:` prefix indicates that the directive is targeted at the Java code generator.

Metadata directives permit you to provide supplementary information that does not change the Slice types being defined, but somehow influences how the compiler will generate code for these definitions. For example, a metadata directive `java:type:java.util.LinkedList` instructs the Java code generator to map a sequence to a linked list instead of an array (which is the default).

Metadata directives are also used to create skeletons that support *Asynchronous Method Dispatch (AMD)*.

Apart from metadata directives that are attached to a specific definition, there are also global metadata directives. For example:

Slice
<pre>[["java:package:com.acme"]]</pre>

Note that a global metadata directive is enclosed by double square brackets, whereas a local metadata directive (one that is attached to a specific definition) is enclosed by single square brackets. Global metadata directives are used to pass instructions that affect the entire compilation unit. For example, the preceding metadata directive instructs the Java code generator to generate the contents of the source file into the Java package `com.acme`. Global metadata directives must precede any definitions in a file (but can appear following any `#include` directives).

We discuss specific metadata directives in the relevant chapters to which they apply.

You can find a summary of all metadata directives in [Slice Metadata Directives](#).

See Also

- [Slice Metadata Directives](#)

Serializable Objects

Ice for Java and Ice for .NET allow you to send native Java and CLR objects as operation parameters. The Ice run time automatically serializes and deserializes the objects as part of an invocation. This mechanism allows you to transmit Java and CLR objects that do not have a corresponding Slice definition.

On this page:

- [The `serializable` Metadata Directive](#)
- [Architectural Implications](#)

The `serializable` Metadata Directive

To enable serialization, the parameter type must be a byte sequence with appropriate metadata. For example:

Slice
<pre>["java:serializable:SomePackage.JavaClass"] sequence<byte> JavaObj; interface JavaExample { void sendJavaObj(JavaObj o); }; ["clr:serializable:SomeNamespace.CLRClass"] sequence<byte> CLRObj; interface CLRExample { void sendCLRObj(CLRObj o); };</pre>

The `java:serializable` metadata indicates that the corresponding byte sequence holds a [Java serializable type](#) named `SomePackage.JavaClass`. Your program must provide an implementation of this class; the class must implement `java.io.Serializable`.

Similarly, the `clr:serializable` metadata indicates that the corresponding byte sequences holds a [CLR serializable type](#) named `SomeNamespace.CLRClass`. Your program must provide an implementation of this class; the class must be marked with the `Serializable` attribute.

Architectural Implications

The `serializable` metadata directive permits you to transmit arbitrary Java and CLR objects across the network without the need to define corresponding Slice classes or structures. This is mainly a convenience feature: you could achieve the same thing by using ordinary Slice byte sequences and explicitly serializing your Java or CLR objects into byte sequences at the sending end, and deserializing them at the receiving end. The `serializable` metadata conveniently takes care of these chores for you and so is simpler to use.

Despite its convenience, you should use this feature with caution because it destroys language transparency. For example, a serialized Java object is useless to a C++ server. All the C++ server can do with such an object is to pass it on to some other process as a byte sequence. (Of course, if that receiving process is a Java process, it can deserialize the byte sequence.)

Further, similar to [Slice classes with methods](#), a serialized object can be deserialized only if client and server agree on the definition of the serialized class. In Java, this is enforced by the `serialVersionUID` field of each instance; in the CLR, client and server must reference identical assembly versions. This creates much tighter coupling of client and server than exchanging Slice-defined types.

And, of course, if you build a system that relies on, for example, the exchange of serialized Java objects and you later find that you need to add C++ or C# components to the system, these components cannot do anything with the serialized Java objects other than pass them

around as a blob of bytes.

So, if you do use these features, be clear that this implies tighter coupling between client and server, and that it creates additional library versioning and distribution issues because all parts of the system must agree on the implementation of the serialized objects.

See Also

- [Serializable Objects in Java](#)
- [Serializable Objects in C#](#)
- [Architectural Implications of Classes](#)

Deprecating Slice Definitions

All Slice compilers support a metadata directive that allows you to deprecate a Slice definition. For example:

```

Slice



```
interface Example {
 ["deprecated:someOperation() has been deprecated, use alternativeOp
eration() instead."]
 void someOperation();

 void alternativeOperation();
};
```

```

The ["deprecated"] metadata directive causes the compiler to emit code that generates a warning if you compile application code that uses a deprecated feature. This is useful if you want to remove a feature from a Slice definition but do not want to cause a hard error.

The message that follows the colon is optional; if you omit the message and use ["deprecated"], the Slice compilers insert a default message into the generated code.

You can apply the ["deprecated"] metadata directive to Slice constructs other than operations (for example, a structure or sequence definition).

See Also

- [Generating Slice Documentation](#)

Using the Slice Compilers

Ice provides a separate Slice compiler for each language mapping, as shown below:

Language	Compiler
C++	<code>slice2cpp</code>
Java	<code>slice2java</code>
C#	<code>slice2cs</code>
Objective-C	<code>slice2objc</code>
Python	<code>slice2py</code>
Ruby	<code>slice2rb</code>
PHP	<code>slice2php</code>

The Slice compilers.

The compilers share a similar command-line syntax:

```
<compiler-name> [options] file...
```

Regardless of which compiler you use, a number of command-line options are common to the compilers for any language mapping. (See the appropriate language mapping chapter for options that are specific to a particular language mapping.) The common command-line options are:

- `-h, --help`
Displays a help message.
- `-v, --version`
Displays the compiler version.
- `-DNAME`
Defines the preprocessor symbol *NAME*.
- `-DNAME=DEF`
Defines the preprocessor symbol *NAME* with the value *DEF*.
- `-UNAME`
Undefines the preprocessor symbol *{NAME}*.
- `-IDIR`
Add the directory *DIR* to the search path for `#include` directives.
- `-E`
Print the preprocessor output on `stdout`.
- `--output-dir DIR`
Place the generated files into directory *DIR*.
- `-d, --debug`
Print debug information showing the operation of the Slice parser.
- `--ice`
Permit use of the normally reserved prefix `Ice` for identifiers. Use this option only when compiling the source code for the Ice run time.

- `--underscore`
Permit use of underscores in Slice identifiers.

The Slice compilers permit you to compile more than a single source file, so you can compile several Slice definitions at once, for example:

```
slice2cpp -I. file1.ice file2.ice file3.ice
```

See Also

- [Slice Compilation](#)

Slice Checksums

As distributed applications evolve, developers and system administrators must be careful to ensure that deployed components are using the same client-server contract. Unfortunately, mistakes do happen, and it is not always readily apparent when they do.

To minimize the chances of this situation, the Slice compilers support an option that generates checksums for Slice definitions, thereby enabling two peers to verify that they share an identical client-server contract. The checksum for a Slice definition includes details such as parameter and member names and the order in which operations are defined, but ignores information that is not relevant to the client-server contract, such as metadata, comments, and formatting.

This option causes the Slice compiler to construct a dictionary that maps Slice type identifiers to checksums. A server typically supplies an operation that returns its checksum dictionary for the client to compare with its local version, at which point the client can take action if it discovers a mismatch.

The dictionary type is defined in the file `Ice/SliceChecksumDict.ice` as follows:

```

Slice
module Ice {
    dictionary<string, string> SliceChecksumDict;
};

```

This type can be incorporated into an application's Slice definitions like this:

```

Slice
#include <Ice/SliceChecksumDict.ice>

interface MyServer {
    idempotent Ice::SliceChecksumDict getSliceChecksums();
    // ...
};

```

The key of each element in the dictionary is a Slice [type ID](#), and the value is the checksum of that type.

 For more information on generating and using Slice checksums, see the appropriate language mapping chapter.

See Also

- [Type IDs](#)

Generating Slice Documentation

On this page:

- [Generating Slice Documentation](#)
- [Documentation Comments](#)
 - [Hyperlinks](#)
 - [Explicit Cross-References](#)
 - [Markup for Operations](#)
 - [General HTML Markup](#)
- [Using `slice2html`](#)

Generating Slice Documentation

If you look at the online [Slice API reference](#), you will find reference documentation for all the Slice definitions used by Ice and its services. In the binary distributions of Ice, you will also find HTML documentation that contains the same information. The HTML documentation is generated from special comments in the Slice definitions using `slice2html`, a tool that scans Slice definitions for special comments and generates HTML pages for those comments.

As an example of documentation comments, here is the definition of `Ice::Current`:

Slice
<pre> /** * * Information about the current method invocation for servers. Each * operation on the server has a <tt>Current</tt> as its implicit final * parameter. <tt>Current</tt> is mostly used for Ice services. Most * applications ignore this parameter. * **/ local struct Current { /** * The object adapter. **/ ObjectAdapter adapter; /** * Information about the connection over which the current * method invocation was received. If the invocation is direct * due to collocation optimization, this value is set to null. **/ Connection con; /** * The Ice object identity. **/ Identity id; /** * The facet. ***/ string facet; </pre>

```
/**
 * The operation name.
 **/
string operation;

/**
 * The mode of the operation.
 **/
OperationMode mode;

/**
 * The request context, as received from the client.
 **/
Context ctx;

/**
 * The request id unless oneway (0) or collocated (-1).
 **/
int requestId;

/**
 * The encoding version used to encode the input and output
parameters.
 **/
```

```
Ice::EncodingVersion encoding;
};
```

If you look at the comments, you will see these reflected in the documentation for `Ice::Current` in the online [Slice API reference](#).

Documentation Comments

A documentation comment:

- starts with `/**`
- ends with `**/`

Such a comment can precede any Slice construct, such as a module, interface, structure, operation, and so on. Within a documentation comment, you can either start each line with a `*`, or you can leave the beginning of the line blank — `slice2html` can handle either convention:

Slice
<pre>/** * * This is a documentation comment for which every line * starts with a '*' character. **/ /** This is a documentation comment without a leading '*' for each line. Either style of comment is fine. **/</pre>

The first sentence of the documentation comment for a Slice construct should be a summary sentence. `slice2html` generates an index of all Slice constructs; the first sentence of the comments for each Slice construct is used as a summary in that index.

Hyperlinks

Any Slice identifier enclosed in `{@link ...}` is presented as a hyperlink in code font. For example:

Slice
<pre>/** * An empty {@link name} denotes a null object. **/</pre>

This generates a hyperlink for the `name` markup that points at the definition of the corresponding Slice symbol. (The symbol can denote any Slice construct, such as a type, interface, parameter, or structure member.)

Explicit Cross-References

The directive `@see` is recognized by `slice2html`. Where it appears, the generated HTML contains a separate section titled "See Also",

followed by a list of Slice identifiers. For example:

Slice
<pre> /** * The object adapter, which is responsible for receiving requests * from endpoints, and for mapping between servants, identities, * and proxies. * * @see Communicator * @see ServantLocator */ </pre>

The Slice identifiers are listed in the corresponding "See Also" section as hyperlinks in code font.

Markup for Operations

There are three directives specifically to document Slice operations: `@param`, `@return`, and `@throws`. For example:

Slice
<pre> /** * Look for an item with the specified * primary and secondary key. * * @param p The primary search key. * * @param s The secondary search key. * * @return The item that matches the specified keys. * * @throws NotFound Raised if no item matches the specified keys. */ Item findItem(Key p, Key s) throws NotFound; </pre>

`slice2html` generates separate "Parameters", "Return Value", and "Exceptions" sections for these directives. Parameters are listed in the same order as they appear in the comments. (For clarity, that order should match the order of declaration of parameters for the corresponding operation.)

General HTML Markup

A documentation comment can contain any markup that is permitted by HTML in that place. For example, you can create separate paragraphs with `<P>` and `</P>` elements:

Slice

```
/**
 * This is a comment for some Slice construct.</p>
 *
 * <p>This comment appears in a separate paragraph.
 **/
```

Note that you must neither begin a documentation comment with a `<p>` element nor end it with a `</p>` element because, in the generated HTML, documentation comments are already surrounded by `<p>` and `</p>` elements.

There are various other ways to create markup — for example, you can use `<table>` or `` elements. Please see the [HTML specification](#) for details.

Using `slice2html`

`slice2html` uses the following syntax:

```
slice2html [options] slice_file...
```

If you have cross-references that span Slice files, you must compile all of the Slice files with a single invocation of `slice2html`.

The command supports the following options:

- `-h, --help`
Displays a help message.
- `-v, --version`
Displays the compiler version.
- `-DNAME`
Defines the preprocessor symbol `NAME`.
- `-DNAME=DEF`
Defines the preprocessor symbol `NAME` with the value `DEF`.
- `-UNAME`
Undefines the preprocessor symbol `{NAME}`.
- `-IDIR`
Add the directory `DIR` to the search path for `#include` directives.
- `-E`
Print the preprocessor output on `stdout`.
- `--output-dir DIR`
Place the generated files into directory `DIR`.
- `-d, --debug`
Print debug information showing the operation of the Slice parser.
- `--ice`
Permit use of the normally reserved prefix `Ice` for identifiers. Use this option only when compiling the source code for the Ice run time.

- `--underscore`
Permit use of underscores in Slice identifiers.
- `--hdr FILE`
Prepend *FILE* to each generated HTML file (except for `_sindex.html`). This allows you to replace the HTML header and other preamble information with a custom version, so you can connect style sheets to the generated pages. The specified file must include the `<body>` tag (but need not end with a `<body>` tag). *FILE* is expected to contain the string `TITLE` on a line by itself, starting in column one. `slice2html` replaces the `TITLE` string with the fully-scoped name of the Slice symbol that is documented on the corresponding page.
- `--ftr FILE`
Append *FILE* to each generated HTML file (except for `_sindex.html`). This allows you to add, for example, a custom footer to each generated page. *FILE* must end with a `</body>` tag.
- `--indexhdr FILE`
`slice2html` generates a file `_sindex.html` that contains a table of contents of all Slice symbols that hyperlink to the corresponding page. This option allows you to replace the standard header with a custom header, for example, to attach a JavaScript. The specified file must include the `<body>` tag (but need not end with a `<body>` tag). The default value is the setting of `--hdr` (if any).
- `--indexftr FILE`
Append *FILE* to the generated `sindex.html` page. This allows you to add, for example, a custom footer to the table of contents, or to invoke a JavaScript. *FILE* must end with a `</body>` tag. The default value is the setting of `--ftr` (if any).
- `--image-dir DIR`
With this option, `slice2html` looks in the specified directory for images to use for the generated navigation hyperlinks. (Without this option, text links are used instead.) Please see the generated HTML for the names of the various image files. (They can easily be found by looking for `img` elements.)
- `--logo-url URL`
Use the specified URL as a hyperlink for the company logo that is added to each page (if `--image-dir` is specified). The company logo is expected to be in `<image_dir>/logo.gif`.
- `--search ACTION`
If this option is specified, the generated pages contain a search box that allows you to connect the generated pages to a search engine. On pressing the "Search" button, the specified *ACTION* is carried out.
- `--index NUM`
`slice2html` generates sub-indexes for various Slice symbols. This option controls how many entries must be present before a sub-index is generated. For example, if *NUM* is set to 3, a sub-index will be generated only if there are three or more symbols that appear in that index. The default settings is 1, meaning that a sub-index is always generated. To disable sub-indexes entirely, set *NUM* to 0.
- `--summary NUM`
If this option is set, summary sentences that exceed *NUM* characters generate a warning.

See Also

- [Slice API reference](#)
- [HTML specification](#)

Slice Keywords

The following identifiers are Slice keywords:

<code>bool</code>	<code>extends</code>	<code>LocalObject</code>	<code>string</code>
<code>byte</code>	<code>false</code>	<code>long</code>	<code>struct</code>
<code>class</code>	<code>float</code>	<code>module</code>	<code>throws</code>
<code>const</code>	<code>idempotent</code>	<code>Object</code>	<code>true</code>
<code>dictionary</code>	<code>implements</code>	<code>optional</code>	<code>void</code>
<code>double</code>	<code>int</code>	<code>out</code>	
<code>enum</code>	<code>interface</code>	<code>sequence</code>	
<code>exception</code>	<code>local</code>	<code>short</code>	

Keywords must be capitalized as shown.

See Also

- [Lexical Rules](#)

Slice Metadata Directives

On this page:

- [General Metadata Directives](#)
- [Metadata Directives for C++](#)
- [Metadata Directives for Java](#)
- [Metadata Directives for C#](#)
- [Metadata Directives for .NET and Mono](#)
- [Metadata Directives for Objective-C](#)
- [Metadata Directives for Python](#)
- [Metadata Directives for Freeze](#)

General Metadata Directives

`ami`

This directive applies to interfaces, classes, and individual operations. It enable code generation for asynchronous method invocation.



This directive applies to the [deprecated AMI mapping](#). For the new AMI mapping there is no need for this directive.

`amd`

This directive applies to interfaces, classes, and individual operations. It enables code generation for asynchronous method dispatch. (See the relevant language mapping chapter for details.)

`deprecated`

This directive allows you to emit a [deprecation warning](#) for Slice constructs.

`format`

This directive defines the [encoding format](#) used for any classes or exceptions marshaled as the arguments or results of an operation. The tag can be applied to an interface, which affects all of its operations, or to individual operations. Legal values for the tag are `format:sliced`, `format:compact`, and `format:default`. A tag specified for an operation overrides any setting applied to its enclosing interface. The `Ice.Default.SlicedFormat` property defines the behavior when no tag is present.

`preserve-slice`

This directive applies to classes and exceptions, allowing an intermediary to [forward an instance](#) of the annotated type, or any of its subtypes, with all of its slices intact. Operations that transfer such types must be annotated with `format:sliced`. It is not necessary to repeat the `preserve-slice` tag on derived types, but you may wish to do so for documentation purposes.

`protected`

This directive applies to data members of classes and changes code generation to make these members protected. See class mapping of the relevant language mapping chapter for more information.

`UserException`

This directive applies only to operations on local interfaces. The metadata directive indicates that the operation can throw any user exception, regardless of its specific definition. (This directive is used for the `locate` and `finished` operations on servant locators, which can throw any user exception.)

Metadata Directives for C++

cpp:array and cpp:range:array

These directives apply to sequences. They direct the code generator to create zerocopy APIs for [passing sequences as parameters](#).

cpp:class

This directive applies to [structures](#). It directs the code generator to create a C++ class (instead of a C++ structure) to represent a Slice structure.

cpp:comparable

This directive applies to [structures](#). It directs the code generator to generate comparison operators for a structure regardless of whether it qualifies as a legal dictionary key type.

cpp:const

This directive applies to operations. It directs the code generator to create a `const` pure virtual member function for the [skeleton class](#).

cpp:header-ext

This global directive allows you to use a [file extension for C++ header files](#) other than the default `.h` extension.

cpp:ice_print

This directive applies to exceptions. It directs the code generator to declare (but not implement) an `ice_print` member function that overrides the `ice_print` virtual function in `Ice::Exception`. The application must provide the implementation of this `ice_print` function.

cpp:include

This global directive allows you inject additional `#include` directives into the generated code. This is useful for [custom types](#).

cpp:type:wstring

This directive applies to data members of type `string` as well as to containers, such as structures, classes, and exceptions. It changes the [default mapping for strings](#) from `std::string` to `std::wstring`.

cpp:virtual

This directive applies to classes. If the directive is present and a class has base classes, the generated C++ class derives virtually from its bases; without this directive, `slice2cpp` generates the class so it derives non-virtually from its bases.

This directive is useful if you use Slice classes as servants and want to inherit the implementation of operations in the base class in the derived class. For example:

Slice
<pre>class Base { int baseOp(); }; ["cpp:virtual"] class Derived extends Base { string derivedOp(); };</pre>

The metadata directive causes `slice2cpp` to generate the class definition for `Derived` using virtual inheritance:

C++

```
class Base : virtual public Ice::Object {
    // ...
};

class Derived : virtual public Base {
    // ...
};
```

This allows you to reuse the implementation of `baseOp` in the servant for `Derived` using ladder inheritance:

C++

```
class BaseI : public virtual Base {
    Ice::Int baseOp(const Ice::Current&);
    // ...
};

class DerivedI : public virtual Derived, public virtual BaseI {
    // Re-use inherited baseOp()
};
```

Note that, if you have data member in classes and use virtual inheritance, you need to take care to correctly call base class constructors if you implement your own one-shot constructor. For example:

Slice

```
class Base {
    int baseInt;
};

class Derived extends Base {
    int derivedInt;
};
```

The generated one-shot constructor for `Derived` initializes both `baseInt` and `derivedInt`:

C++

```
Derived::Derived(Ice::Int __ice_baseInt, Ice::Int __ice_derivedInt)
    : M::Base(__ice_baseInt),
      derivedInt(__ice_derivedInt)
{
}
```

If you derive your own class from `Derived` and add a one-shot constructor to your class, you must explicitly call the constructor of all the base classes, including `Base`. Failure to call the `Base` constructor will result in `Base` being default-constructed instead of getting a defined value. For example:

```
C++
```

```
class DerivedI : public virtual Derived {
public:
    DerivedI(int baseInt, int derivedInt, const string& s)
        : Base(baseInt), Derived(baseInt, derivedInt), _s(s)
    {
    }

private:
    string _s;
};
```

This code correctly initializes the `baseInt` member of the `Base` part of the class. Note that the following does not work as intended and leaves the `Base` part default-constructed (meaning that `baseInt` is not initialized):

```
C++
```

```
class DerivedI : public virtual Derived {
public:
    DerivedI(int baseInt, int derivedInt, const string& s)
        : Derived(baseInt, derivedInt), _s(s)
    {
        // WRONG: Base::baseInt is not initialized.
    }

private:
    string _s;
};
```

Metadata Directives for Java

`java:package`

This global directive instructs the code generator to place the generated classes into a [specific package](#).

`java:getset`

This directive applies to data members and structures, classes, and exceptions. It adds accessor and modifier methods ([JavaBean methods](#)) for data members.

`java:optional`

This directive forces [optional output parameters](#) to use the optional mapping instead of the default required mapping in servants.

`java:serializable`

This directive allows you to use Ice to transmit [serializable Java classes](#) as native objects, without having to define corresponding Slice definitions for these classes.

```
java:serialVersionUID
```

This directive [overrides](#) the default (generated) value of `serialVersionUID` for a Slice type.

```
java:type
```

This directive allows you to use [custom types](#) for sequences and dictionaries.

Metadata Directives for C#

Note that C# (and other Common Language Runtime languages) are also affected by metadata with a `clr:` prefix. (See [#Metadata Directives for .NET and Mono.](#))

```
cs:attribute
```

This directive can be used both as a global directive and as directive for specific Slice constructs. It injects C# attribute definitions into the generated code. (See [C-Sharp Specific Metadata Directives.](#))

Metadata Directives for .NET and Mono

```
clr:class
```

This directive applies to Slice structures. It directs the code generator to emit a [C# class](#) instead of a structure.

```
clr:collection
```

This directive applies to [sequences](#) and [dictionaries](#) and maps them to types that are derived from `CollectionBase` and `DictionaryBase`, respectively.

```
clr:generic:List, clr:generic:LinkedList, clr:generic:Queue and clr:generic:Stack
```

These directives apply to [sequences](#) and map them to the specified sequence type.

```
clr:generic:SortedDictionary
```

This directive applies to [dictionaries](#) and maps them to `SortedDictionary`.

```
clr:generic
```

This directive applies to [sequences](#) and allows you map them to custom types.

```
clr:property
```

This directive applies to Slice structures and classes. It directs the code generator to create [C# property definitions](#) for data members.

```
clr:serializable
```

This directive allows you to use Ice to transmit [serializable CLR classes as native objects](#), without having to define corresponding Slice definitions for these classes.

Metadata Directives for Objective-C

```
objc:prefix
```

This directive applies to modules and changes the [default mapping for modules](#) to use a specified prefix.

Metadata Directives for Python

`python:package`

This global directive instructs the code generator to place the generated code into a [specified Python package](#).

`python:seq:default`, `python:seq:list` and `python:seq:tuple`

These directives allow you to change the [mapping for Slice sequences](#).

Metadata Directives for Freeze

`freeze:read` and `freeze:write`

These directives inform a Freeze evictor whether an operation [updates the state](#) of an object, so the evictor knows whether it must save an object before evicting it.

See Also

- [Metadata](#)

Slice for a Simple File System

For this manual, we use a file system application to illustrate various aspects of Ice. Throughout, we progressively improve and modify the application such that it evolves into an application that is realistic and illustrates the architectural and coding aspects of Ice. This allows us to explore the capabilities of the platform to a realistic degree of complexity without overwhelming you with an inordinate amount of detail early on.

In this section:

- [#File System Application](#) outlines the file system functionality
- [#Slice Definitions for the File System](#) develops the data types and interfaces that are required for the file system
- [#Complete Definition](#) presents the complete Slice definition for the application.

File System Application

Our file system application implements a simple hierarchical file system, similar to the file systems we find in Windows or Unix. To keep code examples to manageable size, we ignore many aspects of a real file system, such as ownership, permissions, symbolic links, and a number of other features. However, we build enough functionality to illustrate how you could implement a fully-featured file system, and we pay attention to things such as performance and scalability. In this way, we can create an application that presents us with real-world complexity without getting buried in large amounts of code.

Our file system consists of directories and files. Directories are containers that can contain either directories or files, meaning that the file system is hierarchical. A dedicated directory is at the root of the file system. Each directory and file has a name. Files and directories with a common parent directory must have different names (but files and directories with different parent directories can have the same name). In other words, directories form a naming scope, and entries with a single directory must have unique names. Directories allow you to list their contents.

For now, we do not have a concept of pathnames, or the creation and destruction of files and directories. Instead, the server provides a fixed number of directories and files. (We will address the creation and destruction of files and directories in [Object Life Cycle](#).)

Files can be read and written but, for now, reading and writing always replace the entire contents of a file; it is impossible to read or write only parts of a file.

Slice Definitions for the File System

Given the very simple requirements we just outlined, we can start designing interfaces for the system. Files and directories have something in common: they have a name and both files and directories can be contained in directories. This suggests a design that uses a base type that provides the common functionality, and derived types that provide the functionality specific to directories and files, as shown:

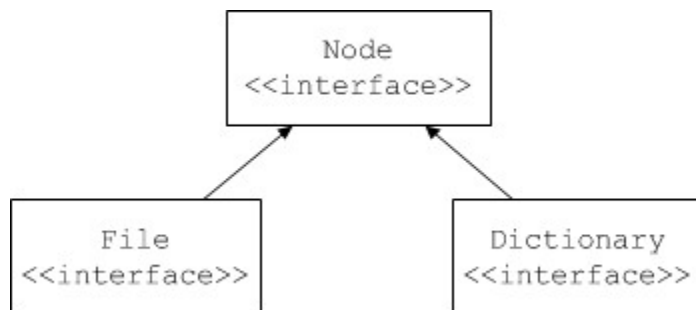

Inheritance Diagram of the File System.

The Slice definitions for this look as follows:

Slice

```
interface Node {
    // ...
};

interface File extends Node {
    // ...
};

interface Directory extends Node {
    // ...
};
```

Next, we need to think about what operations should be provided by each interface. Seeing that directories and files have names, we can add an operation to obtain the name of a directory or file to the `Node` base interface:

Slice

```
interface Node {
    idempotent string name();
};
```

The `File` interface provides operations to read and write a file. For simplicity, we limit ourselves to text files and we assume that `read` operations never fail and that only `write` operations can encounter error conditions. This leads to the following definitions:

Slice

```
exception GenericError {
    string reason;
};

sequence<string> Lines;

interface File extends Node {
    idempotent Lines read();
    idempotent void write (Lines text) throws GenericError;
};
```

Note that `read` and `write` are marked idempotent because either operation can safely be invoked with the same parameter value twice in a row: the net result of doing so is the same as having (successfully) called the operation only once.

The `write` operation can raise an exception of type `GenericError`. The exception contains a single `reason` data member, of type `string`. If a `write` operation fails for some reason (such as running out of file system space), the operation throws a `GenericError` exception, with an explanation of the cause of the failure provided in the `reason` data member.

Directories provide an operation to list their contents. Because directories can contain both directories and files, we take advantage of the polymorphism provided by the `Node` base interface:

Slice

```
sequence<Node*> NodeSeq;

interface Directory extends Node {
    idempotent NodeSeq list();
};
```

The `NodeSeq` sequence contains elements of type `Node*`. Because `Node` is a base interface of both `Directory` and `File`, the `NodeSeq` sequence can contain proxies of either type. (Obviously, the receiver of a `NodeSeq` must down-cast each element to either `File` or `Directory` in order to get at the operations provided by the derived interfaces; only the `name` operation in the `Node` base interface can be invoked directly, without doing a down-cast first. Note that, because the elements of `NodeSeq` are of type `Node*` (not `Node`), we are using pass-by-reference semantics: the values returned by the `list` operation are proxies that each point to a remote node on the server.

These definitions are sufficient to build a simple (but functional) file system. Obviously, there are still some unanswered questions, such as how a client obtains the proxy for the root directory. We will address these questions in the relevant implementation chapter.

Complete Definition

We wrap our definitions in a module, resulting in the final definition as follows:

Slice

```
module Filesystem {
    interface Node {
        idempotent string name();
    };

    exception GenericError {
        string reason;
    };

    sequence<string> Lines;

    interface File extends Node {
        idempotent Lines read();
        idempotent void write(Lines text) throws GenericError;
    };

    sequence<Node*> NodeSeq;

    interface Directory extends Node {
        idempotent NodeSeq list();
    };
};
```

See Also

- [Object Life Cycle](#)

C++ Mapping

Topics

- [Client-Side Slice-to-C++ Mapping](#)
- [Server-Side Slice-to-C++ Mapping](#)
- [The C++ Utility Library](#)
- [Windows Store Applications](#)

Client-Side Slice-to-C++ Mapping

The client-side Slice-to-C++ mapping defines how Slice data types are translated to C++ types, and how clients invoke operations, pass parameters, and handle errors. Much of the C++ mapping is intuitive. For example, Slice sequences map to STL vectors, so there is essentially nothing new you have to learn in order to use Slice sequences in C++.

The rules that make up the C++ mapping are simple and regular. In particular, the mapping is free from the potential pitfalls of memory management: all types are self-managed and automatically clean up when instances go out of scope. This means that you cannot accidentally introduce a memory leak by, for example, ignoring the return value of an operation invocation or forgetting to deallocate memory that was allocated by a called operation.

The C++ mapping is fully thread-safe. For example, the [reference counting mechanism](#) for classes is interlocked against parallel access, so reference counts cannot be corrupted if a class instance is shared among a number of threads. Obviously, you must still synchronize access to data from different threads. For example, if you have two threads sharing a sequence, you cannot safely have one thread insert into the sequence while another thread is iterating over the sequence. However, you only need to concern yourself with concurrent access to your own data — the Ice run time itself is fully thread safe, and none of the Ice API calls require you to acquire or release a lock before you safely can make the call.

Much of what appears in this chapter is reference material. We suggest that you skim the material on the initial reading and refer back to specific sections as needed. However, we recommend that you read at least the mappings for [exceptions](#), [interfaces](#), and [operations](#) in detail because these sections cover how to call operations from a client, pass parameters, and handle exceptions.



In order to use the C++ mapping, you should need no more than the Slice definition of your application and knowledge of the C++ mapping rules. In particular, looking through the generated header files in order to discern how to use the C++ mapping is likely to be confusing because the header files are not necessarily meant for human consumption and, occasionally, contain various cryptic constructs to deal with operating system and compiler idiosyncrasies. Of course, occasionally, you may want to refer to a header file to confirm a detail of the mapping, but we recommend that you otherwise use the material presented here to see how to write your client-side code.



The Ice Namespace

All of the APIs for the Ice run time are nested in the `Ice` namespace, to avoid clashes with definitions for other libraries or applications. Some of the contents of the `Ice` namespace are generated from Slice definitions; other parts of the `Ice` namespace provide special-purpose definitions that do not have a corresponding Slice definition. We will incrementally cover the contents of the `Ice` namespace throughout the remainder of the manual.

Topics

- [C++ Mapping for Identifiers](#)
- [C++ Mapping for Modules](#)
- [C++ Mapping for Built-In Types](#)
- [C++ Mapping for Enumerations](#)
- [C++ Mapping for Structures](#)
- [C++ Mapping for Sequences](#)
- [C++ Mapping for Dictionaries](#)
- [C++ Mapping for Constants](#)
- [C++ Mapping for Exceptions](#)
- [C++ Mapping for Interfaces](#)
- [C++ Mapping for Operations](#)
- [C++ Mapping for Classes](#)
- [C++ Mapping for Optional Values](#)
- [Smart Pointers for Classes](#)
- [Asynchronous Method Invocation \(AMI\) in C++](#)
- [slice2cpp Command-Line Options](#)
- [Using Slice Checksums in C++](#)
- [Example of a File System Client in C++](#)

C++ Mapping for Identifiers

A Slice [identifier](#) maps to an identical C++ identifier. For example, the Slice identifier `clock` becomes the C++ identifier `clock`. There is one exception to this rule: if a Slice identifier is the same as a C++ keyword, the corresponding C++ identifier is prefixed with `_cpp_`. For example, the Slice identifier `while` is mapped as `_cpp_while`.

A single Slice identifier often results in several C++ identifiers. For example, for a Slice interface named `Foo`, the generated C++ code uses the identifiers `Foo` and `FooPrx` (among others). If the interface has the name `while`, the generated identifiers are `_cpp_while` and `whilePrx` (*not* `_cpp_whilePrx`), that is, the prefix is applied only to those generated identifiers that actually require it.



You should try to [avoid such identifiers](#) as much as possible.

See Also

- [Lexical Rules](#)
- [C++ Mapping for Modules](#)
- [C++ Mapping for Built-In Types](#)
- [C++ Mapping for Enumerations](#)
- [C++ Mapping for Structures](#)
- [C++ Mapping for Sequences](#)
- [C++ Mapping for Dictionaries](#)
- [C++ Mapping for Constants](#)
- [C++ Mapping for Exceptions](#)

C++ Mapping for Modules

A Slice `module` maps to a C++ namespace. The mapping preserves the nesting of the Slice definitions. For example:

Slice
<pre> module M1 { module M2 { // ... }; // ... }; // ... module M1 { // Reopen M1 // ... }; </pre>

This definition maps to the corresponding C++ definition:

C++
<pre> namespace M1 { namespace M2 { // ... } // ... } // ... namespace M1 { // Reopen M1 // ... } </pre>

If a Slice module is reopened, the corresponding C++ namespace is reopened as well.

See Also

- [Modules](#)
- [C++ Mapping for Identifiers](#)
- [C++ Mapping for Built-In Types](#)
- [C++ Mapping for Enumerations](#)
- [C++ Mapping for Structures](#)
- [C++ Mapping for Sequences](#)
- [C++ Mapping for Dictionaries](#)
- [C++ Mapping for Constants](#)
- [C++ Mapping for Exceptions](#)

C++ Mapping for Built-In Types

On this page:

- [Mapping of Slice Built-In Types to C++ Types](#)
- [Alternative String Mapping for C++](#)

Mapping of Slice Built-In Types to C++ Types

The Slice built-in types are mapped to C++ types as shown in this table:

Slice	C++
bool	bool
byte	Ice::Byte
short	Ice::Short
int	Ice::Int
long	Ice::Long
float	Ice::Float
double	Ice::Double
string	std::string

Slice `bool` and `string` map to C++ `bool` and `std::string`. The remaining built-in Slice types map to C++ type definitions instead of C++ native types. This allows the Ice run time to provide a definition as appropriate for each target architecture. (For example, `Ice::Int` might be defined as `long` on one architecture and as `int` on another.)



Note that `Ice::Byte` is a typedef for `unsigned char`. This guarantees that byte values are always in the range 0..255.

All the basic types are guaranteed to be distinct C++ types, that is, you can safely overload functions that differ in only the types listed in the table above.

Alternative String Mapping for C++

You can use a metadata directive, `["cpp:type:wstring"]`, to map strings to C++ `std::wstring`. This is useful for applications that use languages with alphabets that cannot be represented in 8-bit characters. The metadata directive can be applied to any Slice construct. For containers (such as modules, interfaces, or structures), the metadata directive applies to all strings within the container. A corresponding metadata directive, `["cpp:type:string"]`, can be used to selectively override the mapping defined by the enclosing container. For example:

Slice

```

["cpp:type:wstring"]
struct S1 {
    string x;           // Maps to std::wstring
    ["cpp:type:wstring"]
    string y;           // Maps to std::wstring
    ["cpp:type:string"]
    string z;           // Maps to std::string
};

struct S2 {
    string x;           // Maps to std::string
    ["cpp:type:string"]
    string y;           // Maps to std::string
    ["cpp:type:wstring"]
    string z;           // Maps to std::wstring
};

```

With these metadata directives, the strings are mapped as indicated by the comments. By default, narrow strings are encoded as UTF-8, and wide strings use Unicode in an encoding that is appropriate for the platform on which the application executes. You can override the encoding for narrow and wide strings by registering a [string converter](#) with the Ice run time.

See Also

- [Basic Types](#)
- [C++ Mapping for Identifiers](#)
- [C++ Mapping for Modules](#)
- [C++ Mapping for Enumerations](#)
- [C++ Mapping for Structures](#)
- [C++ Mapping for Sequences](#)
- [C++ Mapping for Dictionaries](#)
- [C++ Mapping for Constants](#)
- [C++ Mapping for Exceptions](#)
- [C++ Strings and Character Encoding](#)

C++ Mapping for Enumerations

A Slice [enumeration](#) maps to the corresponding enumeration in C++. For example:

```
Slice  
enum Fruit { Apple, Pear, Orange };
```

Not surprisingly, the generated C++ definition is identical:

```
C++  
enum Fruit { Apple, Pear, Orange };
```

Suppose we modify the Slice definition to include a custom enumerator value:

```
Slice  
enum Fruit { Apple, Pear = 3, Orange };
```

The generated C++ definition now includes an explicit initializer for every enumerator:

```
C++  
enum Fruit { Apple = 0, Pear = 3, Orange = 4 };
```

See Also

- [Enumerations](#)
- [C++ Mapping for Structures](#)
- [C++ Mapping for Sequences](#)
- [C++ Mapping for Dictionaries](#)

C++ Mapping for Structures

A Slice [structure](#) maps to a C++ structure by default. In addition, you can use a metadata directive to map structures to C++ [classes](#).

On this page:

- [Default Mapping for Structures in C++](#)
- [Class Mapping for Structures in C++](#)
- [Default Constructors for Structures in C++](#)

Default Mapping for Structures in C++

Slice structures map to C++ structures with the same name. For each Slice data member, the C++ structure contains a public data member. For example, here is our [Employee](#) structure once more:

Slice
<pre>struct Employee { long number; string firstName; string lastName; };</pre>

The Slice-to-C++ compiler generates the following definition for this structure:

C++
<pre>struct Employee { Ice::Long number; std::string firstName; std::string lastName; bool operator==(const Employee&) const; bool operator!=(const Employee&) const; bool operator<(const Employee&) const; bool operator<=(const Employee&) const; bool operator>(const Employee&) const; bool operator>=(const Employee&) const; };</pre>

For each data member in the Slice definition, the C++ structure contains a corresponding public data member of the same name. Constructors are intentionally omitted so that the C++ structure qualifies as a *plain old datatype* (POD).

The structure may also contain comparison operators to allow its use as the key type of [Slice dictionaries](#), which are mapped to `std::map` in C++. These operators have the following behavior:

- `operator==`
Two structures are equal if (recursively), all its members are equal.
- `operator!=`
Two structures are not equal if (recursively), one or more of its members are not equal.
- `operator<`
`operator<=`
`operator>`

`operator>=`

The comparison operators treat the members of a structure as sort order criteria: the first member is considered the first criterion, the second member the second criterion, and so on. Assuming that we have two `Employee` structures, `s1` and `s2`, this means that the generated code uses the following algorithm to compare `s1` and `s2`:

C++

```
bool Employee::operator<(const Employee& rhs) const
{
    if (this == &rhs)    // Short?cut self?comparison
        return false;

    // Compare first members
    //
    if (number < rhs.number)
        return true;
    else if (rhs.number < number)
        return false;

    // First members are equal, compare second members
    //
    if (firstName < rhs.firstName)
        return true;
    else if (rhs.firstName < firstName)
        return false;

    // Second members are equal, compare third members
    //
    if (lastName < rhs.lastName)
        return true;
    else if (rhs.lastName < lastName)
        return false;

    // All members are equal, so return false
    return false;
}
```

As of Ice 3.5, the comparison operators are only generated for structures that qualify as [legal dictionary keys](#). You can force the Slice compiler to generate the comparison operators for non-qualifying structures by using the `cpp:comparable` metadata:

Slice

```
["cpp:comparable"]
struct NoKey
{
    float f;
};
```

Note that the ordering behavior for non-qualifying structures may not be deterministic.

Copy construction and assignment always have deep-copy semantics. You can freely assign structures or structure members to each other without having to worry about memory management. The following code fragment illustrates both comparison and deep-copy semantics:

```

C++

Employee e1, e2;
e1.firstName = "Bjarne";
e1.lastName = "Stroustrup";
e2 = e1; // Deep copy
assert(e1 == e2);
e2.firstName = "Andrew"; // Deep copy
e2.lastName = "Koenig"; // Deep copy
assert(e2 < e1);
```

Because strings are mapped to `std::string`, there are no memory management issues in this code and structure assignment and copying work as expected. (The default member-wise copy constructor and assignment operator generated by the C++ compiler do the right thing.)

Class Mapping for Structures in C++

Occasionally, the mapping of Slice structures to C++ structures can be inefficient. For example, you may need to pass structures around in your application, but want to avoid having to make expensive copies of the structures. (This overhead becomes noticeable for structures with many complex data members, such as sequences or strings.) Of course, you could pass the structures by const reference, but that can create its own share of problems, such as tracking the life time of the structures to avoid ending up with dangling references.

For this reason, you can enable an alternate mapping that maps Slice structures to C++ classes. Classes (as opposed to structures) are reference-counted. Because the Ice C++ mapping provides [smart pointers for classes](#), you can keep references to a class instance in many places in the code without having to worry about either expensive copying or life time issues.

The alternate mapping is enabled by a metadata directive, ["cpp:class"]. Here is our Employee structure once again, but this time with the additional metadata directive:

```

Slice

["cpp:class"] struct Employee {
    long number;
    string firstName;
    string lastName;
};
```

Here is the generated class:

C++

```

class Employee : public IceUtil::Shared {
public:
    Employee() {}
    Employee(::Ice::Long,
            const ::std::string&,
            const ::std::string&);
    ::Ice::Long number;
    ::std::string firstName;
    ::std::string lastName;

    bool operator==(const Employee&) const;
    bool operator!=(const Employee&) const;
    bool operator<(const Employee&) const;
    bool operator<=(const Employee&) const;
    bool operator>(const Employee&) const;
    bool operator>=(const Employee&) const;
};

```

Note that the generated class, apart from a default constructor, has a constructor that accepts one argument for each member of the structure. This allows you to instantiate and initialize the class in a single statement (instead of having to first instantiate the class and then assign to its members).

As for the default structure mapping, the class contains one public data member for each data member of the corresponding Slice structure.

The comparison operators behave as for the default structure mapping.

You can learn how to [instantiate classes](#), and how to access them via [smart pointers](#), in the sections describing the mapping for Slice classes — the API described there applies equally to Slice structures that are mapped to classes.

Default Constructors for Structures in C++

Structures have an implicit default constructor that default-constructs each data member. Members having a complex type, such as strings, sequences, and dictionaries, are initialized by their own default constructor. However, the default constructor performs no initialization for members having one of the simple built-in types boolean, integer, floating point, or enumeration. For such a member, it is not safe to assume that the member has a reasonable default value. This is especially true for enumerated types as the member's default value may be outside the legal range for the enumeration, in which case an exception will occur during marshaling unless the member is explicitly set to a legal value.

To ensure that data members of primitive types are initialized to reasonable values, you can declare default values in your [Slice definition](#). The default constructor initializes each of these data members to its declared value.

If you declare a default value for at least one member of a structure, or use the class mapping for the structure, the Slice compiler also generates a second constructor. This *one-shot* constructor has one parameter for each data member, allowing you to construct and initialize an instance in a single statement (instead of first having to construct the instance and then assign to its members).

See Also

- [Structures](#)
- [C++ Mapping for Enumerations](#)
- [C++ Mapping for Sequences](#)
- [C++ Mapping for Dictionaries](#)

C++ Mapping for Sequences

On this page:

- [Default Sequence Mapping in C++](#)
- [Custom Sequence Mapping in C++](#)
 - [Custom Type Mapping for Sequences](#)
 - [Array Mapping for Sequences in C++](#)
 - [Range Mapping for Sequences in C++](#)

Default Sequence Mapping in C++

Here is the definition of our `FruitPlatter` sequence once more:

```

Slice

sequence<Fruit> FruitPlatter;
```

The Slice compiler generates the following definition for the `FruitPlatter` sequence:

```

C++

typedef std::vector<Fruit> FruitPlatter;
```

As you can see, the sequence simply maps to a standard `std::vector`, so you can use the sequence like any other vector. For example:

```

C++

// Make a small platter with one Apple and one Orange
//
FruitPlatter p;
p.push_back(Apple);
p.push_back(Orange);
```

Custom Sequence Mapping in C++

In addition to the default mapping of sequences to vectors, Ice supports three additional custom mappings for sequences.

Custom Type Mapping for Sequences

You can override the default mapping of Slice sequences to C++ vectors with a metadata directive, for example:

Slice

```

[["cpp:include:list"]]

module Food {

    enum Fruit { Apple, Pear, Orange };

    ["cpp:type:std::list< ::Food::Fruit>"]
    sequence<Fruit> FruitPlatter;

};

```

With this metadata directive, the sequence now maps to a C++ `std::list`:

C++

```

#include <list>

namespace Food {

    typedef std::list< Food::Fruit> FruitPlatter;

    // ...

}

```

The `cpp:type` metadata directive can be applied to a sequence or dictionary definition; anything following the `cpp:type:` prefix is taken to be the name of the type. For example, we could use `["cpp:type::std::list< ::Food::Fruit>"]`. In that case, the compiler would use a fully-qualified name to define the type:

C++

```

typedef ::std::list< ::Food::Fruit> FruitPlatter;

```

Note that the code generator inserts whatever string you specify following the `cpp:type:` prefix literally into the generated code. This means that, to avoid C++ compilation failures due to unknown symbols, you should use a qualified name for the type.

Also note that, to avoid compilation errors in the generated code, you must instruct the compiler to generate an appropriate include directive with the `cpp:include` global metadata directive. This causes the compiler to add the line

C++

```

#include <list>

```

to the generated header file.

Instead of `std::list`, you can specify a type of your own as the sequence type, for example:

Slice

```

[[ "cpp:include:FruitBowl.h" ]]

module Food {

    enum Fruit { Apple, Pear, Orange };

    [ "cpp:type:FruitBowl" ]
    sequence<Fruit> FruitPlatter;

};

```

With these metadata directives, the compiler will use a C++ type `FruitBowl` as the sequence type, and add an include directive for the header file `FruitBowl.h` to the generated code.

The class or template class you provide must meet the following requirements:

- The class must have a default constructor.
- The class must have a copy constructor.

If you use a class that also meets the following requirements

- The class has a single-argument constructor that takes the size of the sequence as an argument of unsigned integral type.
- The class has a member function `size` that returns the number elements in the sequence as an unsigned integral type.
- The class provides a member function `swap` that swaps the contents of the sequence with another sequence of the same type.
- The class defines `iterator` and `const_iterator` types and provides `begin` and `end` member functions with the usual semantics; its iterators are comparable for equality and inequality.

then you do not need to provide code to marshal and unmarshal your custom sequence—Ice will do it automatically.

Less formally, this means that if the provided class looks like a `vector`, `list`, or `deque` with respect to these points, you can use it as a custom sequence implementation without any additional coding.

You can also use a custom class that does not meet these requirements if you tell Ice how to handle this class. First, you need to define a `StreamHelperCategory` and `StreamableTraits` specialization or partial specialization for each category of type that shares the same marshaling and unmarshaling code. For example:

```

namespace Ice
{
    //
    // A new category for all Google Protocol Buffers, to be
    // marshaled/unmarshaled to/from a sequence<byte>.
    //
    const StreamHelperCategory StreamHelperCategoryProtobuf = 100;

    //
    // All classes derived from ::google::protobuf::MessageLite will use
    // this StreamableTraits
    //
    template<typename T>
    struct StreamableTraits<T, typename std::enable_if<std::is_base_of<
    ::google::protobuf::MessageLite, T>::value >::type>
    {
        static const StreamHelperCategory helper =
        StreamHelperCategoryProtobuf;
        static const int minWireSize = 1;
        static const bool fixedLength = false;
    };
}

```

`StreamHelperCategory` is an integer (int). Values between 0 and 20 are reserved for Ice.

Your `StreamableTraits` specialization must be defined in namespace `Ice` and must provide the following static const members:

- `static const StreamHelperCategory helper`
The helper category you defined earlier.
- `static const int minWireSize`
The minimum size (in bytes) of a marshal object of this type. This value should be one for sequences and dictionaries, since an empty sequence or dictionary is marshaled as a single byte (size = 0).
- `static const bool fixedLength`
`true` when this object is always encoded on the same number of bytes, and `false` otherwise. For sequences and dictionaries, it should be `false`.

As shown in the example above, the second template parameter of `StreamableTraits` allows you to define a specialization for a family of types, such as all the types derived from `::google::protobuf::MessageLite`. If you want to provide a specialization for a single type, you can ignore this second template parameter (it defaults to `void` in the `StreamableTraits` base template).

Then, you need to provide a `StreamHelper` specialization or partial specialization in namespace `Ice` with `read` and `write` template member functions, for example:

```

namespace Ice
{
    //
    // This helper marshals a Protobuf into a sequence<byte>, and unmarshals
    // a sequence<byte>
    // into a Protobuf
    //
    template<typename T>
    struct StreamHelper<T, StreamHelperCategoryProtobuf>
    {
        template<class S> static inline void
        write(S* stream, const T& v)
        {
            std::vector<Byte> data(v.ByteSize());
            // ... marshal v into a sequence of bytes...
            stream->write(&data[0], &data[0] + data.size());
        }

        template<class S> static inline void
        read(S* stream, T& v)
        {
            std::pair<const Byte*, const Byte*> data;
            stream->read(data);
            //... unmarshal data into v...
        }
    };
}

```

Your `write` function is responsible to marshal the parameter into the provided `stream`. You can assume that `S` is an `Ice::OutputStream`, even though Ice may not instantiate your `write` function with this type.

Likewise, your `read` function reads from the provided `stream`, and unmarshals into the provided parameter. You can assume that `S` is an `Ice::InputStream` in your implementation of `read`, even though Ice may not instantiate your `read` function with this type.

i If your application uses a single custom type, you can skip the definition of a new `StreamHelperCategory` value and associated `StreamableTraits` specialization, and simply use `StreamHelperCategoryUnknown` as the second template parameter of your `StreamHelper` specialization or partial specialization.

Finally, if you intend to define optional data members or optional parameters with this custom type, you need to tell Ice how to encode such optional members with this type, for example:

```

namespace Ice
{
template<>
struct GetOptionalFormat<StreamHelperCategoryProtobuf, 1, false>
{
    static const OptionalFormat value = OptionalFormatVSize;
};
}

```

`GetOptionalFormat` is specialized using the constants you provided in the `StreamableTraits` specialization or partial specialization of your custom type. The static const `OptionalFormat` value represents the optional format described in the [data encoding](#).

i The `OptionalFormat` provided by `GetOptionalFormat` for `StreamHelperCategoryUnknown` and its default `StreamableTraits` is `OptionalFormatVSize`, like in the example above.

In addition to modifying the type of a sequence itself, you can also modify the mapping for particular [return values](#) or [parameters](#). For example:

```

Slice

[[ "cpp:include:list" ]]
[[ "cpp:include:deque" ]]

module Food {

    enum Fruit { Apple, Pear, Orange };

    sequence<Fruit> FruitPlatter;

    interface Market {
        [ "cpp:type:list< ::Food::Fruit>" ]
        FruitPlatter
    }

    barter([ "cpp:type:deque< ::Food::Fruit>" ] FruitPlatter offer);
};
};

```

With this definition, the default mapping of `FruitPlatter` to a C++ vector still applies but the return value of `barter` is mapped as a list, and the `offer` parameter is mapped as a deque.

Array Mapping for Sequences in C++

The array mapping for sequences applies to [input parameters](#) and to [out parameters](#) of [AMI](#) and [AMD](#) operations. For example:

Slice

```
interface File {
    void write(["cpp:array"] Ice::ByteSeq contents);
};
```

The `cpp:array` metadata directive instructs the compiler to map the `contents` parameter to a pair of pointers. With this directive, the `write` method on the proxy has the following signature:

C++

```
void write(const std::pair<const Ice::Byte*,
const Ice::Byte*>& contents);
```

To pass a byte sequence to the server, you pass a pair of pointers; the first pointer points at the beginning of the sequence, and the second pointer points one element past the end of the sequence.

Similarly, for the server side, the `write` method on the skeleton has the following signature:

C++

```
virtual void write(const ::std::pair<const ::Ice::Byte*,
const ::Ice::Byte*>&,
const ::Ice::Current& = ::Ice::Current()) = 0;
```

The passed pointers denote the beginning and end of the sequence as a range `[first, last)` (that is, they use the usual semantics for iterators).

The array mapping is useful to achieve zero-copy passing of sequences. The pointers point directly into the server-side transport buffer; this allows the server-side run time to avoid creating a `vector` to pass to the operation implementation, thereby avoiding both allocating memory for the sequence and copying its contents into that memory.

- i** You can use the array mapping for any sequence type. However, it provides a performance advantage only for byte sequences (on all platforms) and for sequences of integral or floating point types (x86 platforms only).

The called operation in the server must not store a pointer into the passed sequence because the transport buffer into which the pointer points is deallocated as soon as the operation completes.

Range Mapping for Sequences in C++

The range mapping for sequences is similar to the array mapping and exists for the same purpose, namely, to enable zero-copy of sequence parameters:

Slice

```
interface File {
    void write(["cpp:range"] Ice::ByteSeq contents);
};
```

The `cpp:range` metadata directive instructs the compiler to map the `contents` parameter to a pair of `const_iterator`. With this directive, the `write` method on the proxy has the following signature:

```
C++
```

```
void write(const std::pair<Ice::ByteSeq::const_iterator,
Ice::ByteSeq::const_iterator>& contents);
```

Similarly, for the server side, the `write` method on the skeleton has the following signature:

```
C++
```

```
virtual void write(
    const ::std::pair<::Ice::ByteSeq::const_iterator,
    ::Ice::ByteSeq::const_iterator>&,
    const ::Ice::Current& = ::Ice::Current()) = 0;
```

The passed iterators denote the beginning and end of the sequence as a range [`first`, `last`) (that is, they use the usual semantics for iterators).

The motivation for the range mapping is the same as for the array mapping: the passed iterators point directly into the server-side transport buffer and so avoid the need to create a temporary `vector` to pass to the operation.

i As for the array mapping, the range mapping can be used with any sequence type, but offers a performance advantage only for byte sequences (on all platforms) and for sequences of integral type (x86 platforms only).

The operation must not store an iterator into the passed sequence because the transport buffer into which the iterator points is deallocated as soon as the operation completes.

You can optionally add a type name to the `cpp:range` metadata directive, for example:

```
Slice
```

```
interface File {
    void write(["cpp:range:std::deque<Ice::Byte>"]
Ice::ByteSeq contents);
};
```

This instructs the compiler to generate a pair of `const_iterator` for the specified type:

```
C++
```

```
virtual void write(
    const ::std::pair<std::deque<Ice::Byte>::const_iterator,
    std::deque<Ice::Byte>::const_iterator>&,
    const ::Ice::Current& = ::Ice::Current()) = 0;
```

This is useful if you want to combine the range mapping with a custom sequence type that behaves like an standard container.

See Also

- [Sequences](#)
- [Asynchronous Method Dispatch \(AMD\) in C++](#)
- [C++ Mapping for Enumerations](#)
- [C++ Mapping for Structures](#)
- [C++ Mapping for Dictionaries](#)
- [C++ Mapping for Operations](#)

C++ Mapping for Dictionaries

On this page:

- [Default Dictionary Mapping in C++](#)
- [Custom Dictionary Mapping in C++](#)

Default Dictionary Mapping in C++

Here is the definition of our `EmployeeMap` once more:

Slice
<pre>dictionary<long, Employee> EmployeeMap;</pre>

The following code is generated for this definition:

C++
<pre>typedef std::map<Ice::Long, Employee> EmployeeMap;</pre>

Again, there are no surprises here: a Slice dictionary simply maps to a standard `std::map`. As a result, you can use the dictionary like any other `map`, for example:

C++
<pre>EmployeeMap em; Employee e; e.number = 42; e.firstName = "Stan"; e.lastName = "Lippman"; em[e.number] = e; e.number = 77; e.firstName = "Herb"; e.lastName = "Sutter"; em[e.number] = e;</pre>

Custom Dictionary Mapping in C++

You can override the default mapping of Slice dictionaries to C++ maps with a metadata directive, for example:

Slice

```
[[ "cpp:include:unordered_map" ]]

["cpp:type:std::unordered_map<Ice::Long, Employee>"] dictionary<long,
Employee> EmployeeMap;
```

With this metadata directive, the dictionary now maps to a C++ `std::unordered_map`:

C++

```
#include <unordered_map>

typedef std::unordered_map<Ice::Long, Employee> EmployeeMap;

}
```

The `cpp:type` metadata directive can be applied to a sequence or dictionary definition; anything following the `cpp:type:` prefix is taken to be the name of the type. For example, we could use `["cpp:type::std::unordered_map<int, std::string>"]`. In that case, the compiler would use a fully-qualified name to define the type:

C++

```
typedef ::std::unordered_map<int, std::string> IntStringDict;
```

To avoid compilation errors in the generated code, you must instruct the compiler to generate an appropriate include directive with the `cpp:include` global metadata directive. This causes the compiler to add the line

C++

```
#include <unordered_map>
```

to the generated header file.

Instead of `std::unordered_map`, you can specify a type of your own as the dictionary type, for example:

Slice

```
[[ "cpp:include:CustomMap.h" ]]

["cpp:type:MyCustomMap<Ice::Long, Employee>"] dictionary<long, Employee>
EmployeeMap;
```

With these metadata directives, the compiler will use a C++ type `MyCustomMap` as the dictionary type, and add an include directive for the header file `CustomMap.h` to the generated code.

The class or template class you provide must meet the following requirements:

- The class must have a default constructor.
- The class must have a copy constructor.
- The class must provide nested types named `key_type`, `mapped_type` and `value_type`.
- The class must provide `iterator` and `const_iterator` types and provides `begin` and `end` member functions with the usual semantics; these iterators must be comparable for equality and inequality.
- The class must provide a `clear` function.
- The class must provide an `insert` function that takes an `iterator` (as location hint) plus a `value_type` parameter, and returns an `iterator` to the new entry or to the existing entry with the given key.

Less formally, this means you can use any class or template class that looks like a standard `map` or `unordered_map` as your custom dictionary type.

In addition to modifying the type of a dictionary itself, you can also modify the mapping for particular return values or parameters. For example:

```

Slice



```

[["cpp:include:unordered_map"]]

module HR {

 struct Employee {
 long number;
 string firstName;
 string lastName;
 };
 dictionary<long, Employee> EmployeeMap;

 interface Office {
 ["cpp:type:std::unordered_map<Ice::Long, Employee>"] EmployeeMap
 getAllEmployees();
 };
};

```

```

With this definition, `getAllEmployees` returns an `unordered_map`, while other unqualified parameters of type `EmployeeMap` would use the default mapping (to a `std::map`).

See Also

- [Dictionaries](#)
- [C++ Mapping for Enumerations](#)
- [C++ Mapping for Structures](#)
- [C++ Mapping for Sequences](#)

C++ Mapping for Constants

Slice `constant` definitions map to corresponding C++ constant definitions. For example:

Slice	
<code>const bool</code>	<code>AppendByDefault = true;</code>
<code>const byte</code>	<code>LowerNibble = 0x0f;</code>
<code>const string</code>	<code>Advice = "Don't Panic!";</code>
<code>const short</code>	<code>TheAnswer = 42;</code>
<code>const double</code>	<code>PI = 3.1416;</code>
<code>enum Fruit { Apple, Pear, Orange };</code>	
<code>const Fruit</code>	<code>FavoriteFruit = Pear;</code>

Here are the generated definitions for these constants:

C++	
<code>const bool</code>	<code>AppendByDefault = true;</code>
<code>const Ice::Byte</code>	<code>LowerNibble = 15;</code>
<code>const std::string</code>	<code>Advice = "Don't Panic!";</code>
<code>const Ice::Short</code>	<code>TheAnswer = 42;</code>
<code>const Ice::Double</code>	<code>PI = 3.1416;</code>
<code>enum Fruit { Apple, Pear, Orange };</code>	
<code>const Fruit</code>	<code>FavoriteFruit = Pear;</code>

All constants are initialized directly in the header file, so they are compile-time constants and can be used in contexts where a compile-time constant expression is required, such as to dimension an array or as the `case` label of a `switch` statement.

See Also

- [Constants and Literals](#)
- [C++ Mapping for Identifiers](#)
- [C++ Mapping for Modules](#)
- [C++ Mapping for Built-In Types](#)
- [C++ Mapping for Enumerations](#)
- [C++ Mapping for Structures](#)
- [C++ Mapping for Sequences](#)
- [C++ Mapping for Dictionaries](#)
- [C++ Mapping for Exceptions](#)

C++ Mapping for Exceptions

On this page:

- [C++ Mapping for User Exceptions](#)
- [C++ Default Constructors for Exceptions](#)
- [C++ Mapping for Run-Time Exceptions](#)

C++ Mapping for User Exceptions

Here is a fragment of the `Slice` definition for our world time server once more:

```

Slice



```
exception GenericError {
 string reason;
};
exception BadTimeVal extends GenericError {};
exception BadZoneName extends GenericError {};
```

```

These exception definitions map as follows:

C++

```

class GenericError: public Ice::UserException {
public:
    std::string reason;

    GenericError() {}
    explicit GenericError(const string&);

    virtual const std::string& ice_name() const;
    virtual Ice::Exception* ice_clone() const;
    virtual void ice_throw() const;
    // Other member functions here...
};

class BadTimeVal: public GenericError {
public:
    BadTimeVal() {}
    explicit BadTimeVal(const string&);

    virtual const std::string& ice_name() const;
    virtual Ice::Exception* ice_clone() const;
    virtual void ice_throw() const;
    // Other member functions here...
};

class BadZoneName: public GenericError {
public:
    BadZoneName() {}
    explicit BadZoneName(const string&);

    virtual const std::string& ice_name() const;
    virtual Ice::Exception* ice_clone() const;
    virtual void ice_throw() const;
};

```

Each Slice exception is mapped to a C++ class with the same name. For each exception member, the corresponding class contains a public data member. (Since `BadTimeVal` and `BadZoneName` do not have members, the generated classes for these exceptions also do not have members.) [Optional data members](#) are mapped to instances of the `IceUtil::Optional` template.

The inheritance structure of the Slice exceptions is preserved for the generated classes, so `BadTimeVal` and `BadZoneName` inherit from `GenericError`.

Each exception has three additional member functions:

- `ice_name`

As the name suggests, this member function returns the name of the exception. For example, if you call the `ice_name` member function of a `BadZoneName` exception, it (not surprisingly) returns the string `"BadZoneName"`. The `ice_name` member function is useful if you catch exceptions generically and want to produce a more meaningful diagnostic, for example:

C++

```
try {
    // ...
} catch (const GenericError& e) {
    cerr << "Caught an exception: " << e.ice_name() << endl;
}
```

If an exception is raised, this code prints the name of the actual exception (`BadTimeVal` or `BadZoneName`) because the exception is being caught by reference (to avoid slicing).

- `ice_clone`

This member function allows you to polymorphically clone an exception. For example:

C++

```
try {
    // ...
} catch (const Ice::UserException& e) {
    Ice::UserException* copy = e.clone();
}
```

`ice_clone` is useful if you need to make a copy of an exception without knowing its precise run-time type. This allows you to remember the exception and throw it later by calling `ice_throw`.

- `ice_throw`

`ice_throw` allows you to throw an exception without knowing its precise run-time type. It is implemented as:

C++

```
void
GenericError::ice_throw() const
{
    throw *this;
}
```

You can call `ice_throw` to throw an exception that you previously cloned with `ice_clone`.

Each exception has a default constructor. Members having a complex type, such as strings, sequences, and dictionaries, are initialized by their own default constructor. However, the default constructor performs no initialization for members having one of the simple built-in types boolean, integer, floating point, or enumeration. For such a member, it is not safe to assume that the member has a reasonable default value. This is especially true for enumerated types as the member's default value may be outside the legal range for the enumeration, in which case an exception will occur during marshaling unless the member is explicitly set to a legal value.

To ensure that data members of primitive types are initialized to reasonable values, you can declare default values in your [Slice definition](#). The default constructor initializes each of these data members to its declared value. Optional data members are unset unless they declare default values.

An exception also has a second constructor that accepts one argument for each exception member. This constructor allows you to instantiate and initialize an exception in a single statement, instead of having to first instantiate the exception and then assign to its members. For each optional data member, its corresponding constructor parameter uses the same mapping as for [operation parameters](#),

allowing you to pass its initial value or `IceUtil::None` to indicate an unset value.

For derived exceptions, the constructor accepts one argument for each base exception member, plus one argument for each derived exception member, in base-to-derived order.

Note that the generated exception classes contain other member functions that are not shown here. However, those member functions are internal to the C++ mapping and are not meant to be called by application code.

All user exceptions ultimately inherit from `Ice::UserException`. In turn, `Ice::UserException` inherits from `Ice::Exception` (which is an alias for `IceUtil::Exception`):

```

C++

namespace IceUtil {
    class Exception {
        virtual const std::string& ice_name() const;
        Exception* ice_clone() const;
        void ice_throw() const;
        virtual void ice_print(std::ostream&) const;
        // ...
    };
    std::ostream& operator<<(std::ostream&, const Exception&);
    // ...
}

namespace Ice {
    typedef IceUtil::Exception Exception;

    class UserException: public Exception {
    public:
        virtual const std::string& ice_name() const = 0;
        // ...
    };
}

```

`Ice::Exception` forms the root of the exception inheritance tree. Apart from the usual `ice_name`, `ice_clone`, and `ice_throw` member functions, it contains the `ice_print` member functions. `ice_print` prints the name of the exception. For example, calling `ice_print` on a `BadTimeVal` exception prints:

```
BadTimeVal
```

To make printing more convenient, `operator<<` is overloaded for `Ice::Exception`, so you can also write:

```

C++

try {
    // ...
} catch (const Ice::Exception& e) {
    cerr << e << endl;
}

```

This produces the same output because `operator<<` calls `ice_print` internally. You can optionally provide your own `ice_print` implem

entation using the `cpp::ice_print` metadata directive.

For Ice run time exceptions, `ice_print` also shows the file name and line number at which the exception was thrown.

C++ Default Constructors for Exceptions

Exceptions have a default constructor that default-constructs each data member. Members having a complex type, such as strings, sequences, and dictionaries, are initialized by their own default constructor. However, the default constructor performs no initialization for members having one of the simple built-in types boolean, integer, floating point, or enumeration. For such a member, it is not safe to assume that the member has a reasonable default value. This is especially true for enumerated types as the member's default value may be outside the legal range for the enumeration, in which case an exception will occur during marshaling unless the member is explicitly set to a legal value.

To ensure that data members of primitive types are initialized to reasonable values, you can declare [default values](#) in your Slice definition. The default constructor initializes each of these data members to its declared value.

Exceptions also have a second constructor that has one parameter for each data member. This allows you to construct and initialize a class instance in a single statement (instead of first having to construct the instance and then assign to its members). For derived exceptions, this constructor has one parameter for each of the base class's data members, plus one parameter for each of the derived class's data members, in base-to-derived order.

C++ Mapping for Run-Time Exceptions

The Ice run time throws run-time exceptions for a number of pre-defined error conditions. All run-time exceptions directly or indirectly derive from `Ice::LocalException` (which, in turn, derives from `Ice::Exception`). `Ice::LocalException` has the usual member functions: `ice_name`, `ice_clone`, `ice_throw`, and (inherited from `Ice::Exception`), `ice_print`, `ice_file`, and `ice_line`.

Recall the [inheritance diagram](#) for user and run-time exceptions. By catching exceptions at the appropriate point in the hierarchy, you can handle exceptions according to the category of error they indicate:

- `Ice::Exception`
This is the root of the complete inheritance tree. Catching `Ice::Exception` catches both user and run-time exceptions.
- `Ice::UserException`
This is the root exception for all user exceptions. Catching `Ice::UserException` catches all user exceptions (but not run-time exceptions).
- `Ice::LocalException`
This is the root exception for all run-time exceptions. Catching `Ice::LocalException` catches all run-time exceptions (but not user exceptions).
- `Ice::TimeoutException`
This is the base exception for both operation-invocation and connection-establishment timeouts.
- `Ice::ConnectTimeoutException`
This exception is raised when the initial attempt to establish a connection to a server times out.

For example, a `ConnectTimeoutException` can be handled as `ConnectTimeoutException`, `TimeoutException`, `LocalException`, or `Exception`.

You will probably have little need to catch run-time exceptions as their most-derived type and instead catch them as `LocalException`; the fine-grained error handling offered by the remainder of the hierarchy is of interest mainly in the implementation of the Ice run time. Exceptions to this rule are the exceptions related to [facet](#) and [object](#) life cycles, which you may want to catch explicitly. These exceptions are `FacetNotExistException` and `ObjectNotExistException`, respectively.

See Also

- [User Exceptions](#)
- [Run-Time Exceptions](#)
- [C++ Mapping for Identifiers](#)

- C++ Mapping for Modules
- C++ Mapping for Built-In Types
- C++ Mapping for Enumerations
- C++ Mapping for Structures
- C++ Mapping for Sequences
- C++ Mapping for Dictionaries
- C++ Mapping for Constants
- C++ Mapping for Optional Values
- Facets and Versioning
- Object Life Cycle

C++ Mapping for Interfaces

The mapping of Slice [interfaces](#) revolves around the idea that, to invoke a remote operation, you call a member function on a local class instance that is a [proxy](#) for the remote object. This makes the mapping easy and intuitive to use because making a remote procedure call is no different from making a local procedure call (apart from error semantics).

On this page:

- [Proxy Classes and Proxy Handles](#)
 - [Inheritance from `Ice::Object`](#)
 - [Proxy Handles](#)
 - [ProxyType and PointerType](#)
- [Methods on Proxy Handles](#)
 - [Default constructor](#)
 - [Copy constructor](#)
 - [Assignment operator](#)
 - [Checked cast](#)
 - [Unchecked cast](#)
 - [Stream insertion and stringification](#)
- [Using Proxy Methods in C++](#)
- [Object Identity and Proxy Comparison in C++](#)

Proxy Classes and Proxy Handles

On the client side, a Slice interface maps to a class with member functions that correspond to the operations on that interface. Consider the following simple interface:

Slice

```

module M {
    interface Simple {
        void op();
    };
};

```

The Slice compiler generates the following definitions for use by the client:

C++

```

namespace IceProxy {
    namespace M {
        class Simple;
    }
}

namespace M {
    class Simple;
    typedef IceInternal::ProxyHandle< ::IceProxy::M::Simple> SimplePrx;
    typedef IceInternal::Handle< ::M::Simple> SimplePtr;
}

namespace IceProxy {
    namespace M {
        class Simple : public virtual IceProxy::Ice::Object {
        public:
            typedef ::M::SimplePrx ProxyType;
            typedef ::M::SimplePtr PointerType;

            void op();
            void op(const Ice::Context&);
            // ...
        };
    };
}

```

As you can see, the compiler generates a *proxy class* `Simple` in the `IceProxy::M` namespace, as well as a *proxy handle* `M::SimplePrx`. In general, for a module `M`, the generated names are `::IceProxy::M::<interface?name>` and `::M::<interface?name>Prx`.

In the client's address space, an instance of `IceProxy::M::Simple` is the local ambassador for a remote instance of the `Simple` interface in a server and is known as a *proxy class instance*. All the details about the server-side object, such as its address, what protocol to use, and its object identity are encapsulated in that instance.

Inheritance from `Ice::Object`

`Simple` inherits from `IceProxy::Ice::Object`, reflecting the fact that all Ice interfaces implicitly inherit from `Ice::Object`. For each operation in the interface, the proxy class has two overloaded member functions of the same name. For the preceding example, we find that the operation `op` has been mapped to two member functions `op`.

One of the overloaded member functions has a trailing parameter of type `Ice::Context`. This parameter is for use by the Ice run time to store information about how to deliver a request; normally, you do not need to supply a value here and can pretend that the trailing parameter does not exist. (The parameter is also used by [IceStorm](#).)

Proxy Handles

Client-side application code never manipulates proxy class instances directly. In fact, you are not allowed to instantiate a proxy class directly. The following code will not compile because `Ice::Object` is an abstract base class with a protected constructor and destructor:

C++

```
IceProxy::M::Simple s; // Compile-time error!
```

Proxy instances are always instantiated on behalf of the client by the Ice run time, so client code never has any need to instantiate a proxy directly. When the client receives a proxy from the run time, it is given a *proxy handle* to the proxy, of type `<interface-name>Prx` (`SimplePrx` for the preceding example). The client accesses the proxy via its proxy handle; the handle takes care of forwarding operation invocations to its underlying proxy, as well as reference-counting the proxy. This means that no memory-management issues can arise: deallocation of a proxy is automatic and happens once the last handle to the proxy disappears (goes out of scope).

Because the application code always uses proxy handles and never touches the proxy class directly, we usually use the term proxy to denote both proxy handle and proxy class. This reflects the fact that, in actual use, the proxy handle looks and feels like the underlying proxy class instance. If the distinction is important, we use the terms *proxy class*, *proxy class instance*, and *proxy handle*.

ProxyType and PointerType

The generated proxy class contains type definitions for `ProxyType` and `PointerType`. These are provided so you can refer to the proxy type and [smart pointer type](#) in template definitions without having to resort to preprocessor trickery, for example:

C++

```
template<typename T>
class ProxyWrapper {
public:
    T::ProxyType proxy() const;
    // ...
};
```

Methods on Proxy Handles

As we saw for the preceding example, the handle is actually a template of type `IceInternal::ProxyHandle` that takes the proxy class as the template parameter. This template has the usual default constructor, copy constructor, and assignment operator.

Default constructor

You can default-construct a proxy handle. The default constructor creates a proxy that points nowhere (that is, points at no object at all). If you invoke an operation on such a null proxy, you get an `IceUtil::NullHandleException`:

C++

```
try {
    SimplePrx s;           // Default-constructed proxy
    s->op();               // Call via nil proxy
    assert(0);           // Can't get here
} catch (const IceUtil::NullHandleException&) {
    cout << "As expected, got a NullHandleException" << endl;
}
```

Copy constructor

The copy constructor ensures that you can construct a proxy handle from another proxy handle. Internally, this increments a reference count on the proxy; the destructor decrements the reference count again and, once the count drops to zero, deallocates the underlying proxy class instance. That way, memory leaks are avoided:

```

C++
{
    SimplePrx s1 = ...;           // Get a proxy from somewhere
    SimplePrx s2(s1);           // Copy?construct s2
    assert(s1 == s2);          // Assertion passes
}
// Leave scope; s1, s2, and the
// underlying proxy instance
// are deallocated

```

Note the assertion in this example: [proxy handles support comparison](#).

Assignment operator

You can freely assign proxy handles to each other. The handle implementation ensures that the appropriate memory-management activities take place. Self-assignment is safe and you do not have to guard against it:

```

C++
SimplePrx s1 = ...;           // Get a proxy from somewhere
SimplePrx s2;                // s2 is nil
s2 = s1;                     // both point at the same object
s1 = 0;                      // s1 is nil
s2 = 0;                      // s2 is nil

```

Widening assignments work implicitly. For example, if we have two interfaces, `Base` and `Derived`, we can widen a `DerivedPrx` to a `BasePrx` implicitly:

```

C++
BasePrx base;
DerivedPrx derived;
base = derived;              // Fine, no problem
derived = base;             // Compile?time error

```

Implicit narrowing conversions result in a compile error, so the usual C++ semantics are preserved: you can always assign a derived type to a base type, but not vice versa.

Checked cast

Proxy handles provide a `checkedCast` method:

C++

```

namespace IceInternal {
    template<typename T>
    class ProxyHandle : public IceUtil::HandleBase<T> {
    public:
        template<class Y>
        static ProxyHandle checkedCast(const ProxyHandle<Y>& r);

        template<class Y>

    static ProxyHandle checkedCast(const ProxyHandle<Y>& r, const ::Ice::Co
ntext& c);

        // ...
    };
}

```

A checked cast has the same function for proxies as a C++ `dynamic_cast` has for pointers: it allows you to assign a base proxy to a derived proxy. If the base proxy's actual run-time type is compatible with the derived proxy's static type, the assignment succeeds and, after the assignment, the derived proxy denotes the same object as the base proxy. Otherwise, if the base proxy's run-time type is incompatible with the derived proxy's static type, the derived proxy is set to null. Here is an example to illustrate this:

C++

```

BasePrx base = ...; // Initialize base proxy
DerivedPrx derived;
derived = DerivedPrx::checkedCast(base);
if (derived) {
    // Base has run?time type Derived,
    // use derived...
} else {
    // Base has some other, unrelated type
}

```

The expression `DerivedPrx::checkedCast(base)` tests whether `base` points at an object of type `Derived` (or an object with a type that is derived from `Derived`). If so, the cast succeeds and `derived` is set to point at the same object as `base`. Otherwise, the cast fails and `derived` is set to the null proxy.

Note that `checkedCast` is a static member function so, to do a down-cast, you always use the syntax `<interface-name>Prx::checkedCast`.

Also note that you can use proxies in boolean contexts. For example, `if (proxy)` returns true if the proxy is not null.

A `checkedCast` typically results in a remote message to the server. The message effectively asks the server "is the object denoted by this reference of type `Derived`?"



In some cases, the Ice run time can optimize the cast and avoid sending a message. However, the optimization applies only in narrowly-defined circumstances, so you cannot rely on a `checkedCast` not sending a message.

The reply from the server is communicated to the application code in form of a successful (non-null) or unsuccessful (null) result. Sending a remote message is necessary because, as a rule, there is no way for the client to find out what the actual run-time type of a proxy is without confirmation from the server. (For example, the server may replace the implementation of the object for an existing proxy with a more derived one.) This means that you have to be prepared for a `checkedCast` to fail. For example, if the server is not running, you will receive a `ConnectFailedException`; if the server is running, but the object denoted by the proxy no longer exists, you will receive an `ObjectNotExistException`.

Unchecked cast

In some cases, it is known that an object supports a more derived interface than the static type of its proxy. For such cases, you can use an unchecked down-cast:

```

C++

namespace IceInternal {
    template<typename T>
    class ProxyHandle : public IceUtil::HandleBase<T> {
    public:
        template<class Y>
        static ProxyHandle uncheckedCast(const ProxyHandle<Y>& r);
        // ...
    };
}
```

An `uncheckedCast` provides a down-cast *without* consulting the server as to the actual run-time type of the object, for example:

```

C++

BasePrx base = ...; // Initialize to point at a Derived
DerivedPrx derived;
derived = DerivedPrx::uncheckedCast(base);
// Use derived...
```

You should use an `uncheckedCast` only if you are certain that the proxy indeed supports the more derived type: an `uncheckedCast`, as the name implies, is not checked in any way; it does not contact the object in the server and, if it fails, it does not return null. (An unchecked cast is implemented internally like a C++ `static_cast`, no checks of any kind are made). If you use the proxy resulting from an incorrect `uncheckedCast` to invoke an operation, the behavior is undefined. Most likely, you will receive an `OperationNotExistException`, but, depending on the circumstances, the Ice run time may also report an exception indicating that unmarshaling has failed, or even silently return garbage results.

Despite its dangers, `uncheckedCast` is still useful because it avoids the cost of sending a message to the server. And, particularly during [initialization](#), it is common to receive a proxy of static type `Ice::Object`, but with a known run-time type. In such cases, an `uncheckedCast` saves the overhead of sending a remote message.

Stream insertion and stringification

For convenience, proxy handles also support insertion of a proxy into a stream, for example:

C++

```
Ice::ObjectPrx p = ...;
cout << p << endl;
```

This code is equivalent to writing:

C++

```
Ice::ObjectPrx p = ...;
cout << p->ice_toString() << endl;
```

Either code prints the *stringified proxy*. You could also achieve the same thing by writing:

C++

```
Ice::ObjectPrx p = ...;
cout << communicator->proxyToString(p) << endl;
```

The advantage of using the `ice_toString` member function instead of `proxyToString` is that you do not need to have the communicator available at the point of call.

Using Proxy Methods in C++

The base proxy class `ObjectPrx` supports a variety of [methods for customizing a proxy](#). Since proxies are immutable, each of these "factory methods" returns a copy of the original proxy that contains the desired modification. For example, you can obtain a proxy configured with a ten second timeout as shown below:

C++

```
Ice::ObjectPrx proxy = communicator->stringToProxy(...);
proxy = proxy->ice_timeout(10000);
```

A factory method returns a new proxy object if the requested modification differs from the current proxy, otherwise it returns the current proxy. With few exceptions, factory methods return a proxy of the same type as the current proxy, therefore it is generally not necessary to repeat a down-cast after using a factory method. The example below demonstrates these semantics:

C++

```
Ice::ObjectPrx base = communicator->stringToProxy(...);
HelloPrx hello = HelloPrx::checkedCast(base);
hello = hello->ice_timeout(10000); // Type is preserved
hello->sayHello();
```

The only exceptions are the factory methods `ice_facet` and `ice_identity`. Calls to either of these methods may produce a proxy for an object of an unrelated type, therefore they return a base proxy that you must subsequently down-cast to an appropriate type.

Object Identity and Proxy Comparison in C++

Proxy handles support comparison using the following operators:

- `operator==`
`operator!=`

These operators permit you to compare proxies for equality and inequality. To test whether a proxy is null, use a comparison with the literal `0`, for example:

```

C++

if (proxy == 0)
    // It's a nil proxy
else
    // It's a non?nil proxy
```

- `operator<`
`operator<=`
`operator>`
`operator>=`

Proxies support comparison. This allows you to place proxies into STL containers such as maps or sorted lists.

- Boolean comparison

Proxies have a conversion operator to `bool`. The operator returns true if a proxy is not null, and false otherwise. This allows you to write:

```

C++

BasePrx base = ...;
if (base)
    // It's a non?nil proxy
else
    // It's a nil proxy
```

Note that proxy comparison uses *all* of the information in a proxy for the comparison. This means that not only the object identity must match for a comparison to succeed, but other details inside the proxy, such as the protocol and endpoint information, must be the same. In other words, comparison with `==` and `!=` tests for *proxy* identity, *not* object identity. A common mistake is to write code along the following lines:

```

C++

Ice::ObjectPrx p1 = ...;           // Get a proxy...
Ice::ObjectPrx p2 = ...;           // Get another proxy...

if (p1 != p2) {
    // p1 and p2 denote different objects           // WRONG!
} else {
    // p1 and p2 denote the same object             // Correct
}
```

Even though `p1` and `p2` differ, they may denote the same Ice object. This can happen because, for example, both `p1` and `p2` embed the same object identity, but each use a different protocol to contact the target object. Similarly, the protocols may be the same, but denote

different endpoints (because a single Ice object can be contacted via several different transport endpoints). In other words, if two proxies compare equal with `==`, we know that the two proxies denote the same object (because they are identical in all respects); however, if two proxies compare unequal with `==`, we know absolutely nothing: the proxies may or may not denote the same object.

To compare the object identities of two proxies, you can use helper functions in the `Ice` namespace:

```

C++

namespace Ice {

    bool proxyIdentityLess(const ObjectPrx&, const ObjectPrx&);
    bool proxyIdentityEqual(const ObjectPrx&, const ObjectPrx&);
    bool proxyIdentityAndFacetLess(const ObjectPrx&, const ObjectPrx&);
    bool proxyIdentityAndFacetEqual(const ObjectPrx&, const ObjectPrx&);

}

```

The `proxyIdentityEqual` function returns true if the object identities embedded in two proxies are the same and ignores other information in the proxies, such as facet and transport information. To include the `facet name` in the comparison, use `proxyIdentityAndFacetEqual` instead.

The `proxyIdentityLess` function establishes a total ordering on proxies. It is provided mainly so you can use object identity comparison with STL sorted containers. (The function uses `name` as the major ordering criterion, and `category` as the minor ordering criterion.) The `proxyIdentityAndFacetLess` function behaves similarly to `proxyIdentityLess`, except that it also compares the facet names of the proxies when their identities are equal.

`proxyIdentityEqual` and `proxyIdentityAndFacetLess` allow you to correctly compare proxies for object identity. The example below demonstrates how to use `proxyIdentityEqual`:

```

C++

Ice::ObjectPrx p1 = ...;           // Get a proxy...
Ice::ObjectPrx p2 = ...;           // Get another proxy...

if (!Ice::proxyIdentityEqual(p1, p2) {
    // p1 and p2 denote different objects           // Correct
} else {
    // p1 and p2 denote the same object             // Correct
}

```

See Also

- [Interfaces, Operations, and Exceptions](#)
- [Proxies](#)
- [C++ Mapping for Operations](#)
- [Example of a File System Client in C++](#)
- [Using Proxies](#)
- [Facets and Versioning](#)
- [IceStorm](#)

C++ Mapping for Operations

On this page:

- [Basic C++ Mapping for Operations](#)
- [Normal and idempotent Operations in C++](#)
- [Passing Parameters in C++](#)
 - [In-Parameters in C++](#)
 - [Out-Parameters in C++](#)
 - [Optional Parameters in C++](#)
 - [Chained Invocations in C++](#)
- [Exception Handling in C++](#)
 - [Exceptions and Out-Parameters in C++](#)
 - [Exceptions and Return Values in C++](#)

Basic C++ Mapping for Operations

As we saw in the [C++ mapping for interfaces](#), for each [operation](#) on an interface, the proxy class contains a corresponding member function with the same name. To invoke an operation, you call it via the proxy handle. For example, here is part of the definitions for our [file system](#):

Slice
<pre> module Filesystem { interface Node { idempotent string name(); }; // ... }; </pre>

The proxy class for the `Node` interface, tidied up to remove irrelevant detail, is as follows:

C++
<pre> namespace IceProxy { namespace Filesystem { class Node : virtual public IceProxy::Ice::Object { public: std::string name(); // ... }; typedef IceInternal::ProxyHandle<Node> NodePrx; // ... } // ... } </pre>

The `name` operation returns a value of type `string`. Given a proxy to an object of type `Node`, the client can invoke the operation as follows:

C++

```
NodePrx node = ...;           // Initialize proxy
string name = node->name();    // Get name via RPC
```

The proxy handle overloads `operator->` to forward method calls to the underlying proxy class instance which, in turn, sends the operation invocation to the server, waits until the operation is complete, and then unmarshals the return value and returns it to the caller.

Because the return value is of type `string`, it is safe to ignore the return value. For example, the following code contains no memory leak:

C++

```
NodePrx node = ...;           // Initialize proxy
node->name();                  // Useless, but no leak
```

This is true for all mapped Slice types: you can safely ignore the return value of an operation, no matter what its type — return values are always returned by value. If you ignore the return value, no memory leak occurs because the destructor of the returned value takes care of deallocating memory as needed.

Normal and idempotent Operations in C++

You can add an `idempotent` qualifier to a Slice operation. As far as the signature for the corresponding proxy methods is concerned, `idempotent` has no effect. For example, consider the following interface:

Slice

```
interface Example {
    string op1();
    idempotent string op2();
    idempotent void op3(string s);
};
```

The proxy class for this interface looks like this:

C++

```
namespace IceProxy {
    class Example : virtual public IceProxy::Ice::Object {
    public:
        std::string op1();
        std::string op2();           // idempotent
        void op3(const std::string&); // idempotent
        // ...
    };
}
```

Because `idempotent` affects an aspect of call dispatch, not interface, it makes sense for the mapping to be unaffected by the `idempotent` keyword.

Passing Parameters in C++

In-Parameters in C++

The parameter passing rules for the C++ mapping are very simple: parameters are passed either by value (for small values) or by `const` reference (for values that are larger than a machine word). Semantically, the two ways of passing parameters are identical: it is guaranteed that the value of a parameter will not be changed by the invocation (with some caveats — see [Out-Parameters](#) below and [Location Transparency](#)).

Here is an interface with operations that pass parameters of various types from client to server:

Slice
<pre> struct NumberAndString { int x; string str; }; sequence<string> StringSeq; dictionary<long, StringSeq> StringTable; interface ClientToServer { void op1(int i, float f, bool b, string s); void op2(NumberAndString ns, StringSeq ss, StringTable st); void op3(ClientToServer* proxy); }; </pre>

The Slice compiler generates the following code for this definition:

C++

```

struct NumberAndString {
    Ice::Int x;
    std::string str;
    // ...
};

typedef std::vector<std::string> StringSeq;

typedef std::map<Ice::Long, StringSeq> StringTable;

namespace IceProxy {
    class ClientToServer : virtual public IceProxy::Ice::Object {
    public:
        void op1(Ice::Int, Ice::Float, bool, const std::string&);
        void op2(const NumberAndString&, const StringSeq&,
const StringTable&);
        void op3(const ClientToServerPrx&);
        // ...
    };
}

```

Given a proxy to a `ClientToServer` interface, the client code can pass parameters as in the following example:

C++

```

ClientToServerPrx p = ...; // Get proxy...

p->op1(42, 3.14, true, "Hello world!"); // Pass simple literals

int i = 42;
float f = 3.14;
bool b = true;
string s = "Hello world!";
p->op1(i, f, b, s); // Pass simple variables

NumberAndString ns = { 42, "The Answer" };
StringSeq ss;
ss.push_back("Hello world!");
StringTable st;
st[0] = ss;
p->op2(ns, ss, st); // Pass complex variables

p->op3(p); // Pass proxy

```

You can pass either literals or variables to the various operations. Because everything is passed by value or `const` reference, there are no memory-management issues to consider.

Out-Parameters in C++

The C++ mapping passes out-parameters by reference. Here is the [Slice definition](#) once more, modified to pass all parameters in the out direction:

Slice
<pre> struct NumberAndString { int x; string str; }; sequence<string> StringSeq; dictionary<long, StringSeq> StringTable; interface ServerToClient { void op1(out int i, out float f, out bool b, out string s); void op2(out NumberAndString ns, out StringSeq ss, out StringTable st); void op3(out ServerToClient* proxy); }; </pre>

The Slice compiler generates the following code for this definition:

C++
<pre> namespace IceProxy { class ServerToClient : virtual public IceProxy::Ice::Object { public: void op1(Ice::Int&, Ice::Float&, bool&, std::string&); void op2(NumberAndString&, StringSeq&, StringTable&); void op3(ServerToClientPrx&); // ... }; } </pre>

Given a proxy to a `ServerToClient` interface, the client code can pass parameters as in the following example:

C++

```

ServerToClientPrx p = ...;      // Get proxy...

int i;
float f;
bool b;
string s;

p->op1(i, f, b, s);
// i, f, b, and s contain updated values now

NumberAndString ns;
StringSeq ss;
StringTable st;

p->op2(ns, ss, st);
// ns, ss, and st contain updated values now

p->op3(p);
// p has changed now!

```

Again, there are no surprises in this code: the caller simply passes variables to an operation; once the operation completes, the values of those variables will be set by the server.

It is worth having another look at the final call:

C++

```

p->op3(p);      // Weird, but well?defined

```

Here, `p` is the proxy that is used to dispatch the call. That same variable `p` is also passed as an out-parameter to the call, meaning that the server will set its value. In general, passing the same parameter as both an input and output parameter is safe: the Ice run time will correctly handle all locking and memory-management activities.

Another, somewhat pathological example is the following:

Slice

```

sequence<int> Row;
sequence<Row> Matrix;

interface MatrixArithmetic {
    void multiply(Matrix m1, Matrix m2, out Matrix result);
};

```

Given a proxy to a `MatrixArithmetic` interface, the client code could do the following:

C++

```
MatrixArithmeticPrx ma = ...;    // Get proxy...
Matrix m1 = ...;                // Initialize one matrix
Matrix m2 = ...;                // Initialize second matrix
ma->squareAndCubeRoot(m1, m2, m1); // !!!
```

This code is technically legal, in the sense that no memory corruption or locking issues will arise, but it has surprising behavior: because the same variable `m1` is passed as an input parameter as well as an output parameter, the final value of `m1` is indeterminate — in particular, if client and server are collocated in the same address space, the implementation of the operation will overwrite parts of the input matrix `m1` in the process of computing the result because the result is written to the same physical memory location as one of the inputs. In general, you should take care when passing the same variable as both an input and output parameter and only do so if the called operation guarantees to be well-behaved in this case.

Optional Parameters in C++

The mapping for [optional parameters](#) is the same as for required parameters, except each optional parameter is encapsulated in an `IceUtil::Optional` value. Consider the following operation:

Slice

```
optional(1) int execute(optional(2) string params, out optional(3) float
value);
```

The C++ mapping for this operation is shown below:

C++

```
IceUtil::Optional<Ice::Int>
execute(const IceUtil::Optional<std::string>& params,
IceUtil::Optional<Ice::Float>& value, ...);
```

The constructors provided by the `IceUtil::Optional` template simplify the use of optional parameters:

C++

```
IceUtil::Optional<Ice::Int> i;
IceUtil::Optional<Ice::Float> v;

i = proxy->execute("--file log.txt", v); // string converted to
Optional<string>
i = proxy->execute(IceUtil::None, v);    // params is unset

if(v)
    cout << "value = " << v.get() << endl;
```

For an optional output parameter, the Ice run time resets the client's `Optional` instance if the server does not supply a value for the parameter, therefore it is safe to pass an `Optional` instance that already has a value.

A well-behaved program must not assume that an optional parameter always has a value.

Chained Invocations in C++

Consider the following simple interface containing two operations, one to set a value and one to get it:

Slice
<pre>interface Name { string getName(); void setName(string name); };</pre>

Suppose we have two proxies to interfaces of type `Name`, `p1` and `p2`, and chain invocations as follows:

C++
<pre>p2->setName(p1->getName());</pre>

This works exactly as intended: the value returned by `p1` is transferred to `p2`. There are no memory-management or exception safety issues with this code.

Exception Handling in C++

Any operation invocation may throw a [run-time exception](#) and, if the operation has an exception specification, may also throw [user exceptions](#). Suppose we have the following simple interface:

Slice
<pre>exception Tantrum { string reason; }; interface Child { void askToCleanUp() throws Tantrum; };</pre>

Slice exceptions are thrown as C++ exceptions, so you can simply enclose one or more operation invocations in a `try-catch` block:

C++

```

ChildPrx child = ...;           // Get proxy...
try {
    child->askToCleanUp();       // Give it a try...
} catch (const Tantrum& t) {
    cout << "The child says: " << t.reason << endl;
}

```

Typically, you will catch only a few exceptions of specific interest around an operation invocation; other exceptions, such as unexpected run-time errors, will typically be dealt with by exception handlers higher in the hierarchy. For example:

C++

```

void run()
{
    ChildPrx child = ...;       // Get proxy...
    try {
        child->askToCleanUp();   // Give it a try...
    } catch (const Tantrum& t) {
        cout << "The child says: " << t.reason << endl;

        child->scold();         // Recover from error...
    }
    child->praise();            // Give positive feedback...
}

int
main(int argc, char* argv[])
{
    int status = 1;
    try {
        // ...
        run();
        // ...
        status = 0;
    } catch (const Ice::Exception& e) {
        cerr << "Unexpected run?time error: " << e << endl;
    }
    // ...
    return status;
}

```

This code handles a specific exception of local interest at the point of call and deals with other exceptions generically. (This is also the strategy we used for our [first simple application](#).)

For efficiency reasons, you should always catch exceptions by `const` reference. This permits the compiler to avoid calling the exception's copy constructor (and, of course, prevents the exception from being sliced to a base type).

Exceptions and Out-Parameters in C++

The Ice run time makes no guarantees about the state of out-parameters when an operation throws an exception: the parameter may have still have its original value or may have been changed by the operation's implementation in the target object. In other words, for out-parameters, Ice provides the weak exception guarantee [1] but does not provide the strong exception guarantee.

 This is done for reasons of efficiency: providing the strong exception guarantee would require more overhead than can be justified.

Exceptions and Return Values in C++

For return values, C++ provides the guarantee that a variable receiving the return value of an operation will not be overwritten if an exception is thrown. (Of course, this guarantee holds only if you do not use the same variable as both an out-parameter and to receive the [return value of an invocation](#)).

See Also

- [Operations](#)
- [Slice for a Simple File System](#)
- [C++ Mapping for Interfaces](#)

References

1. Sutter, H. 1999. [Exceptional C++: 47 Engineering Puzzles, Programming Problems, and Solutions](#). Reading, MA: Addison-Wesley.

C++ Mapping for Classes

On this page:

- [Basic C++ Mapping for Classes](#)
- [Inheritance from `Ice::Object` in C++](#)
- [Class Data Members in C++](#)
- [Class Constructors in C++](#)
- [Class Operations in C++](#)
- [Class Factories in C++](#)

Basic C++ Mapping for Classes

A Slice `class` is mapped to a C++ class with the same name. The generated class contains a public data member for each Slice data member (just as for `structures` and `exceptions`), and a virtual member function for each operation. Consider the following class definition:

Slice	
<pre>class TimeOfDay { short hour; // 0 - 23 short minute; // 0 - 59 short second; // 0 - 59 string format(); // Return time as hh:mm:ss };</pre>	

The Slice compiler generates the following code for this definition:

C++

```

class TimeOfDay;

typedef IceInternal::ProxyHandle<IceProxy::TimeOfDay> TimeOfDayPrx;
typedef IceInternal::Handle<TimeOfDay> TimeOfDayPtr;

class TimeOfDay : virtual public Ice::Object {
public:
    Ice::Short hour;
    Ice::Short minute;
    Ice::Short second;

    virtual std::string format() = 0;

    TimeOfDay() {};
    TimeOfDay(Ice::Short, Ice::Short, Ice::Short);

    virtual bool ice_isA(const std::string&);
    virtual const std::string& ice_id();
    static const std::string& ice_staticId();

    typedef TimeOfDayPrx ProxyType;
    typedef TimeOfDayPtr PointerType;

    // ...
};

```

 The `ProxyType` and `PointerType` definitions are for template programming.

There are a number of things to note about the generated code:

1. The generated class `TimeOfDay` inherits from `Ice::Object`. This means that all classes implicitly inherit from `Ice::Object`, which is the ultimate ancestor of all classes. Note that `Ice::Object` is *not* the same as `IceProxy::Ice::Object`. In other words, you *cannot* pass a class where a proxy is expected and vice versa.
2. The generated class contains a public member for each Slice data member.
3. The generated class has a constructor that takes one argument for each data member, as well as a default constructor.
4. The generated class contains a pure virtual member function for each Slice operation.
5. The generated class contains additional member functions: `ice_isA`, `ice_id`, `ice_staticId`, and `ice_factory`.
6. The compiler generates a type definition `TimeOfDayPtr`. This type implements a smart pointer that wraps dynamically-allocated instances of the class. In general, the name of this type is `<class-name>Ptr`. Do not confuse this with `<class-name>Prx` — that type exists as well, but is the proxy handle for the class, not a smart pointer.

There is quite a bit to discuss here, so we will look at each item in turn.

Inheritance from `Ice::Object` in C++

Like interfaces, classes implicitly inherit from a common base class, `Ice::Object`. However, as shown in the figure below, classes inherited from `Ice::Object` instead of `Ice::ObjectPrx` (which is at the base of the inheritance hierarchy for proxies). As a result, you cannot pass a class where a proxy is expected (and vice versa) because the base types for classes and proxies are not compatible.

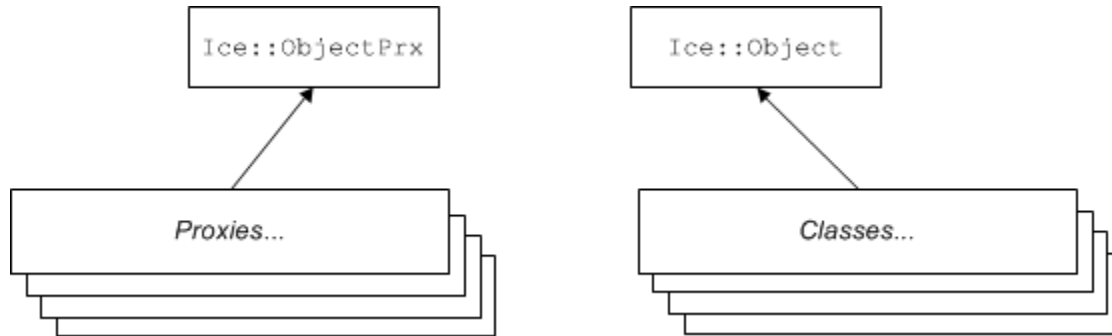

Inheritance from Ice::ObjectPrx and Ice::Object.

Ice::Object contains a number of member functions:

```

C++
namespace Ice {
  class Object : public virtual IceInternal::GCShared {
  public:
    virtual bool ice_isA(const std::string&,
      const Current& = Current()) const;
    virtual void ice_ping(const Current& = Current()) const;
    virtual std::vector<std::string> ice_ids(const Current& = Current()) const;
    virtual const std::string& ice_id(const Current& = Current()) const;
    static const std::string& ice_staticId();
    virtual ObjectPtr ice_clone() const;

    virtual void ice_preMarshal();
    virtual void ice_postUnmarshal();

    virtual DispatchStatus ice_dispatch(
      Ice::Request&,
      const DispatchInterceptorAsyncCallbackPtr& = 0);

    virtual bool operator==(const Object&) const;
    virtual bool operator!=(const Object&) const;
    virtual bool operator<(const Object&) const;
    virtual bool operator<=(const Object&) const;
    virtual bool operator>(const Object&) const;
    virtual bool operator>=(const Object&) const;
  };
}

```

The member functions of Ice::Object behave as follows:

- `ice_isA`
This function returns `true` if the object supports the given `type ID`, and `false` otherwise.
- `ice_ping`

As for interfaces, `ice_ping` provides a basic reachability test for the class. Note that `ice_ping` is normally only invoked on the proxy for a class that might be remote because a class instance that is local (in the caller's address space) can always be reached.

- `ice_ids`
This function returns a string sequence representing all of the [type IDs](#) supported by this object, including `::Ice::Object`.
- `ice_id`
This function returns the actual run-time [type ID](#) for a class. If you call `ice_id` through a smart pointer to a base instance, the returned type id is the actual (possibly more derived) type ID of the instance.
- `ice_staticId`
This function returns the static type ID of a class.
- `ice_clone`
This function makes a [polymorphic shallow copy of a class](#).
- `ice_preMarshal`
The Ice run time invokes this function prior to marshaling the object's state, providing the opportunity for a subclass to validate its declared data members.
- `ice_postUnmarshal`
The Ice run time invokes this function after unmarshaling an object's state. A subclass typically overrides this function when it needs to perform additional initialization using the values of its declared data members.
- `ice_dispatch`
This function dispatches an incoming request to a servant. It is used in the implementation of [dispatch interceptors](#).
- `operator==`
`operator!=`
`operator<`
`operator<=`
`operator>`
`operator>=`
The comparison operators permit you to use classes as elements of STL sorted containers. Note that sort order, unlike for [structures](#), is based on the memory address of the class, not on the contents of its data members of the class.

Class Data Members in C++

By default, data members of classes are mapped exactly as for structures and exceptions: for each data member in the Slice definition, the generated class contains a corresponding public data member. [Optional data members](#) are mapped to instances of the `IceUtil::Optional` template.

If you wish to restrict access to a data member, you can modify its visibility using the `protected` metadata directive. The presence of this directive causes the Slice compiler to generate the data member with protected visibility. As a result, the member can be accessed only by the class itself or by one of its subclasses. For example, the `TimeOfDay` class shown below has the `protected` metadata directive applied to each of its data members:

Slice
<pre>class TimeOfDay { ["protected"] short hour; // 0 - 23 ["protected"] short minute; // 0 - 59 ["protected"] short second; // 0 - 59 string format(); // Return time as hh:mm:ss };</pre>

The Slice compiler produces the following generated code for this definition:

C++

```
class TimeOfDay : virtual public Ice::Object {
public:

    virtual std::string format() = 0;

    // ...

protected:

    Ice::Short hour;
    Ice::Short minute;
    Ice::Short second;
};
```

For a class in which all of the data members are protected, the metadata directive can be applied to the class itself rather than to each member individually. For example, we can rewrite the `TimeOfDay` class as follows:

Slice

```
["protected"] class TimeOfDay {
    short hour;           // 0 - 23
    short minute;        // 0 - 59
    short second;        // 0 - 59
    string format();     // Return time as hh:mm:ss
};
```

Class Constructors in C++

Classes have a default constructor that default-constructs each data member. Members having a complex type, such as strings, sequences, and dictionaries, are initialized by their own default constructor. However, the default constructor performs no initialization for members having one of the simple built-in types boolean, integer, floating point, or enumeration. For such a member, it is not safe to assume that the member has a reasonable default value. This is especially true for enumerated types as the member's default value may be outside the legal range for the enumeration, in which case an exception will occur during marshaling unless the member is explicitly set to a legal value.

To ensure that data members of primitive types are initialized to reasonable values, you can declare default values in your [Slice definition](#). The default constructor initializes each of these data members to its declared value. [Optional data members](#) are unset unless they declare default values.

Classes also have a second constructor that has one parameter for each data member. This allows you to construct and initialize a class instance in a single statement. For each optional data member, its corresponding constructor parameter uses the same mapping as for [operation parameters](#), allowing you to pass its initial value or `IceUtil::None` to indicate an unset value.

For derived classes, the constructor has one parameter for each of the base class's data members, plus one parameter for each of the derived class's data members, in base-to-derived order. For example:

Slice

```
class Base {
    int i;
};

class Derived extends Base {
    string s;
};
```

This generates:

C++

```
class Base : virtual public ::Ice::Object
{
public:
    ::Ice::Int i;

    Base() {};
    explicit Base(::Ice::Int);

    // ...
};

class Derived : public Base
{
public:
    ::std::string s;

    Derived() {};
    Derived(::Ice::Int, const ::std::string&);

    // ...
};
```

Note that single-parameter constructors are defined as `explicit`, to prevent implicit argument conversions.

By default, derived classes derive non-virtually from their base class. If you need virtual inheritance, you can enable it using the `["cpp:virtual"]` metadata directive.

Class Operations in C++

Operations of classes are mapped to pure virtual member functions in the generated class. This means that, if a class contains operations (such as the `format` operation of our `TimeOfDay` class), you must provide an implementation of the operation in a class that is derived from the generated class. For example:

C++

```

class TimeOfDayI : virtual public TimeOfDay {
public:
    virtual std::string format() {
        std::ostringstream s;
        s << setw(2) << setfill('0') << hour << ":";
        s << setw(2) << setfill('0') << minute << ":";
        s << setw(2) << setfill('0') << second;
        return s.c_str();
    }

protected:
    virtual ~TimeOfDayI() {} // Optional
};

```



We discuss the motivation for the protected destructor in [Preventing Stack-Allocation of Class Instances](#).

Class Factories in C++

Having created a class such as `TimeOfDayI`, we have an implementation and we can instantiate the `TimeOfDayI` class, but we cannot receive it as the return value or as an out-parameter from an operation invocation. To see why, consider the following simple interface:

Slice

```

interface Time {
    TimeOfDay get();
};

```

When a client invokes the `get` operation, the Ice run time must instantiate and return an instance of the `TimeOfDay` class. However, `TimeOfDay` is an abstract class that cannot be instantiated. Unless we tell it, the Ice run time cannot magically know that we have created a `TimeOfDayI` class that implements the abstract `format` operation of the `TimeOfDay` abstract class. In other words, we must provide the Ice run time with a factory that knows that the `TimeOfDay` abstract class has a `TimeOfDayI` concrete implementation. The `Ice::CommunicatorI` interface provides us with the necessary operations:

Slice

```

module Ice {
    local interface ObjectFactory {
        Object create(string type);
        void destroy();
    };

    local interface Communicator {
        void addObjectFactory(ObjectFactory factory, string id);
        ObjectFactory findObjectFactory(string id);
        // ...
    };
};

```

To supply the Ice run time with a factory for our `TimeOfDayI` class, we must implement the `ObjectFactory` interface:

Slice

```

module Ice {
    local interface ObjectFactory {
        Object create(string type);
        void destroy();
    };
};

```

The object factory's `create` operation is called by the Ice run time when it needs to instantiate a `TimeOfDay` class. The factory's `destroy` operation is called by the Ice run time when its communicator is destroyed. A possible implementation of our object factory is:

C++

```

class ObjectFactory : public Ice::ObjectFactory {
public:
    virtual Ice::ObjectPtr create(const std::string& type) {
        assert(type == M::TimeOfDay::ice_staticId());
        return new TimeOfDayI;
    }
    virtual void destroy() {}
};

```

The `create` method is passed the [type ID](#) of the class to instantiate. For our `TimeOfDay` class, the type ID is `"::M::TimeOfDay"`. Our implementation of `create` checks the type ID: if it matches, the method instantiates and returns a `TimeOfDayI` object. For other type IDs, the method asserts because it does not know how to instantiate other types of objects.

Note that we used the `ice_staticId` method to obtain the type ID rather than embedding a literal string. Using a literal type ID string in your code is discouraged because it can lead to errors that are only detected at run time. For example, if a Slice class or one of its enclosing

modules is renamed and the literal string is not changed accordingly, a receiver will fail to unmarshal the object and the Ice run time will raise `NoObjectFactoryException`. By using `ice_staticId` instead, we avoid any risk of a misspelled or obsolete type ID, and we can discover at compile time if a Slice class or module has been renamed.

Given a factory implementation, such as our `ObjectFactory`, we must inform the Ice run time of the existence of the factory:

C++

```
Ice::CommunicatorPtr ic = ...;
ic->addObjectFactory(new ObjectFactory, M::TimeOfDay::ice_staticId());
```

Now, whenever the Ice run time needs to instantiate a class with the type ID `"::M::TimeOfDay"`, it calls the `create` method of the registered `ObjectFactory` instance.

The `destroy` operation of the object factory is invoked by the Ice run time when the communicator is destroyed. This gives you a chance to clean up any resources that may be used by your factory. Do not call `destroy` on the factory while it is registered with the communicator — if you do, the Ice run time has no idea that this has happened and, depending on what your `destroy` implementation is doing, may cause undefined behavior when the Ice run time tries to next use the factory.

The run time guarantees that `destroy` will be the last call made on the factory, that is, `create` will not be called concurrently with `destroy`, and `create` will not be called once `destroy` has been called. However, calls to `create` can be made concurrently.

Note that you cannot register a factory for the same type ID twice: if you call `addObjectFactory` with a type ID for which a factory is registered, the Ice run time throws an `AlreadyRegisteredException`.

Finally, keep in mind that if a class has only data members, but no operations, you need not create and register an object factory to transmit instances of such a class. Only if a class has operations do you have to define and register an object factory.

See Also

- [Classes](#)
- [Smart Pointers for Classes](#)
- [C++ Mapping for Operations](#)
- [C++ Mapping for Optional Values](#)
- [Asynchronous Method Invocation \(AMI\) in C++](#)
- [Dispatch Interceptors](#)

C++ Mapping for Optional Values

On this page:

- [The `IceUtil::Optional` Template](#)
- [The `IceUtil::None` Value](#)

The `IceUtil::Optional` Template

The C++ mapping uses a template to hold the values of optional [data members](#) and [parameters](#):

C++

```

namespace IceUtil {
template<typename T>
class Optional {
public:
    typedef T element_type;

    Optional();
    Optional(NoneType);
    Optional(const T&);

    template<typename Y>
    Optional(const Optional<Y>&);

    Optional(const Optional& r);

    Optional& operator=(NoneType);
    Optional& operator=(const T&);

    template<typename Y>
    Optional& operator=(const Optional<Y>&);
    Optional& operator=(const Optional&);

    const T& get() const;
    T& get();
    const T* operator->() const;
    T* operator->();
    const T& operator*() const;
    T& operator*();

    operator bool() const;
    bool operator!() const;

    void swap(Optional& other);

    ...
};
}

```

The `IceUtil::Optional` template provides constructors and assignment operators that allow you to initialize an instance using the element type or an existing optional value. The default constructor initializes an instance to an unset condition. The `get` method and dereference operators retrieve the current value held by the instance, or throw `IceUtil::OptionalNotSetException` if no value is currently set. Use the `bool` or `!` operators to test whether the instance has a value prior to dereferencing it. Finally, the `swap` method exchanges the state of two instances.

The `IceUtil::None` Value

The template includes a constructor and assignment operator that accept `NoneType`. Ice defines an instance of this type, `IceUtil::None`,

that you can use to initialize (or reset) an `Optional` instance to an unset condition:

C++

```
IceUtil::Optional<int> i = 5;  
i = IceUtil::None;  
assert(!i); // true
```



You can pass `IceUtil::None` anywhere an `IceUtil::Optional` value is expected.

See Also

- [Optional Data Members](#)
- [Operations](#)
- [C++ Mapping for Operations](#)

Smart Pointers for Classes

On this page:

- [Automatic Memory Management with Smart Pointers](#)
- [Copying and Assignment of Classes](#)
- [Polymorphic Copying of Classes](#)
- [Null Smart Pointers](#)
- [Preventing Stack-Allocation of Class Instances](#)
- [Smart Pointers and Constructors](#)
- [Smart Pointers and Exception Safety](#)
- [Smart Pointers and Cycles](#)
- [Garbage Collection of Class Instances](#)
- [Smart Pointer Comparison](#)

Automatic Memory Management with Smart Pointers

A recurring theme for C++ programmers is the need to deal with memory allocations and deallocations in their programs. The difficulty of doing so is well known: in the face of exceptions, multiple return paths from functions, and callee-allocated memory that must be deallocated by the caller, it can be extremely difficult to ensure that a program does not leak resources. This is particularly important in multi-threaded programs: if you do not rigorously track ownership of dynamic memory, a thread may delete memory that is still used by another thread, usually with disastrous consequences.

To alleviate this problem, Ice provides smart pointers for classes. These smart pointers use reference counting to keep track of each class instance and, when the last reference to a class instance disappears, automatically delete the instance.



Smart pointer classes are an example of the *RAII (Resource Acquisition Is Initialization)* idiom [1].

Smart pointers are generated by the Slice compiler for each class type. For a Slice class `<class-name>`, the compiler generates a C++ smart pointer called `<class-name>Ptr`. Rather than showing all the details of the generated class, here is the basic usage pattern: whenever you allocate a class instance on the heap, you simply assign the pointer returned from `new` to a smart pointer for the class. Thereafter, memory management is automatic and the class instance is deleted once the last smart pointer for it goes out of scope:

```

C++
{
    TimeOfDayPtr tod = new TimeOfDayI; // Allocate instance
    // Initialize...
    tod->hour = 18;
    tod->minute = 11;
    tod->second = 15;
    // ...
} // No memory leak here!
```

As you can see, you use `operator->` to access the members of the class via its smart pointer. When the `tod` smart pointer goes out of scope, its destructor runs and, in turn, the destructor takes care of calling `delete` on the underlying class instance, so no memory is leaked.

A smart pointer performs reference counting of its underlying class instance:

- The constructor of a class sets its reference count to zero.
- Initializing a smart pointer with a dynamically-allocated class instance causes the smart pointer to increment the reference count of the instance by one.
- Copy-constructing a smart pointer increments the reference count of the instance by one.
- Assigning one smart pointer to another increments the target's reference count and decrements the source's reference count. (Self-assignment is safe.)

- The destructor of a smart pointer decrements the reference count by one and calls `delete` on its class instance if the reference count drops to zero.

Suppose that we default-construct a smart pointer as follows:

```

C++
TimeOfDayPtr tod;
```

This creates a smart pointer with an internal null pointer.

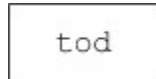

Newly initialized smart pointer.

Constructing a class instance creates that instance with a reference count of zero; the assignment to the smart pointer causes the smart pointer to increment the instance's reference count:

```

C++
tod = new TimeOfDayI; // Refcount == 1
```

The resulting situation is shown below:

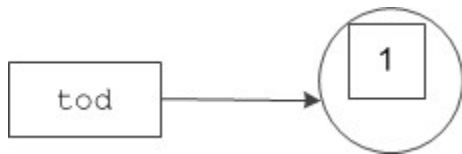

Initialized smart pointer.

Assigning or copy-constructing a smart pointer assigns and copy-constructs the smart pointer (not the underlying instance) and increments the reference count of the instance:

```

C++
TimeOfDayPtr tod2(tod); // Copy-construct tod2
TimeOfDayPtr tod3;
tod3 = tod;             // Assign to tod3
```

Here is the situation after executing these statements:

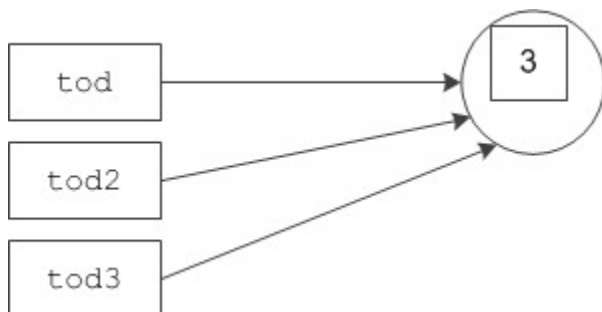

Three smart pointers pointing at the same class instance.

Continuing the example, we can construct a second class instance and assign it to one of the original smart pointers, `tod2`:

```

C++
tod2 = new TimeOfDayI;
```

This decrements the reference count of the instance originally denoted by `tod2` and increments the reference count of the instance that is assigned to `tod2`. The resulting situation becomes the following:

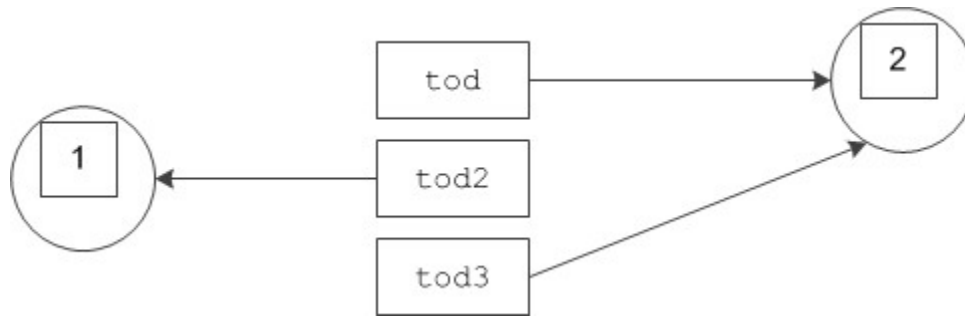

Three smart pointers and two instances.

You can clear a smart pointer by assigning zero to it:

```

C++
tod = 0;      // Clear handle
```

As you would expect, this decrements the reference count of the instance, as shown here:

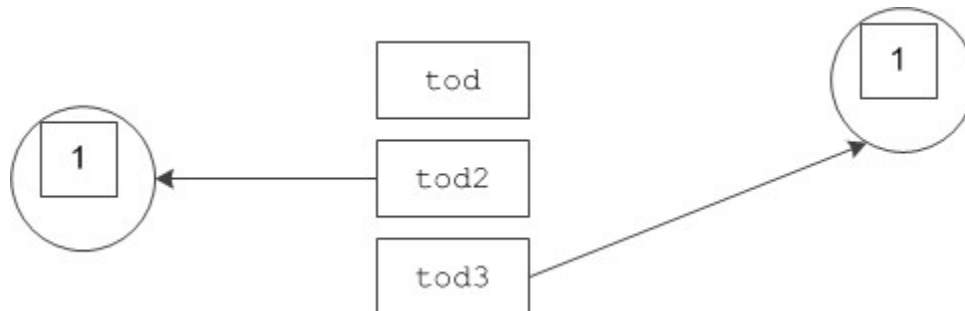

Decrementated reference count after clearing a smart pointer.

If a smart pointer goes out of scope, is cleared, or has a new instance assigned to it, the smart pointer decrements the reference count of its instance; if the reference count drops to zero, the smart pointer calls `delete` to deallocate the instance. The following code snippet deallocates the instance on the right by assigning `tod2` to `tod3`:

```

C++
tod3 = tod2;
```

This results in the following situation:

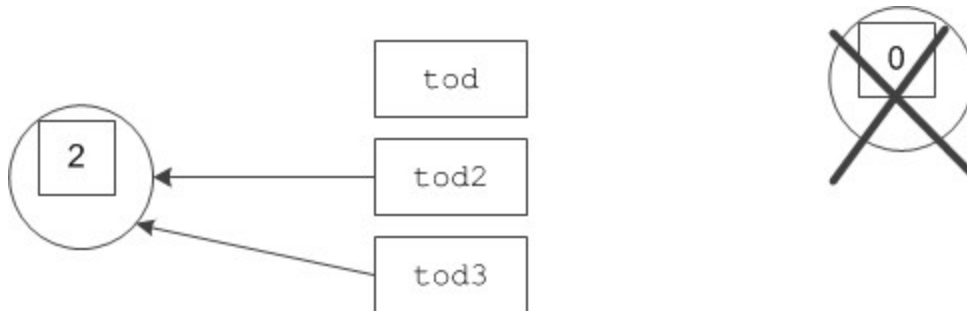

Deallocation of an instance with a reference count of zero.

Copying and Assignment of Classes

Classes have a default memberwise copy constructor and assignment operator, so you can copy and assign class instances:

```

C++
TimeOfDayPtr tod = new TimeOfDayI(2, 3, 4); // Create instance
TimeOfDayPtr tod2 = new TimeOfDayI(*tod);   // Copy instance

TimeOfDayPtr tod3 = new TimeOfDayI;
*tod3 = *tod;                               // Assign instance
```

Copying and assignment in this manner performs a memberwise shallow copy or assignment, that is, the source members are copied into the target members; if a class contains class members (which are mapped as smart pointers), what is copied or assigned is the smart pointer, not the target of the smart pointer.

To illustrate this, consider the following Slice definitions:

```

Slice

class Node {
    int i;
    Node next;
};
```

Assume that we initialize two instances of type `Node` as follows:

```

C++
NodePtr p1 = new Node(99, new Node(48, 0));
NodePtr p2 = new Node(23, 0);

// ...

*p2 = *p1; // Assignment
```

After executing the first two statements, we have the situation shown below:

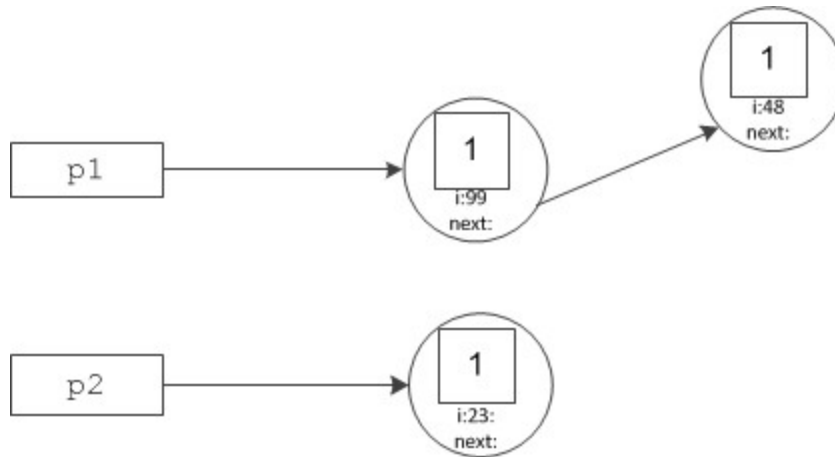

Class instances prior to assignment.

After executing the assignment statement, we end up with this result:

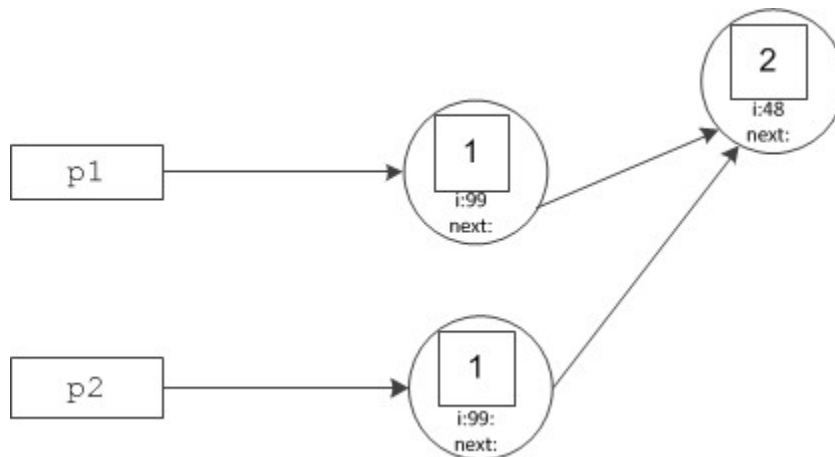

Class instances after assignment.

Note that copying and assignment also works for the implementation of abstract classes, such as our `TimeOfDayI` class, for example:

```

C++
class TimeOfDayI;

typedef IceUtil::Handle<TimeOfDayI> TimeOfDayIPtr;

class TimeOfDayI : virtual public TimeOfDay {
    // As before...
};
  
```

The default copy constructor and assignment operator will perform a memberwise copy or assignment of your implementation class:

C++

```
TimeOfDayIPtr tod1 = new TimeOfDayI;
TimeOfDayIPtr tod2 = new TimeOfDayI(*tod1);    // Make copy
```

Of course, if your implementation class contains raw pointers (for which a memberwise copy would almost certainly be inappropriate), you must implement your own copy constructor and assignment operator that take the appropriate action (and probably call the base copy constructor or assignment operator to take care of the base part).

Note that the preceding code uses `TimeOfDayIPtr` as a typedef for `IceUtil::Handle<TimeOfDayI>`. This class is a template that contains the smart pointer implementation. If you want smart pointers for the implementation of an abstract class, you must define a smart pointer type as illustrated by this type definition.

Copying and assignment of classes also works correctly for derived classes: you can assign a derived class to a base class, but not vice-versa; during such an assignment, the derived part of the source class is sliced, as per the usual C++ assignment semantics.

Polymorphic Copying of Classes

As shown in [Inheritance from `Ice::Object`](#), the C++ mapping generates an `ice_clone` member function for every class:

C++

```
class TimeOfDay : virtual public Ice::Object {
public:
    // ...

    virtual Ice::ObjectPtr ice_clone() const;
};
```

This member function makes a polymorphic shallow copy of a class: members that are not class members are deep copied; all members that are class members are shallow copied. To illustrate, consider the following class definition:

Slice

```
class Node {
    Node n1;
    Node n2;
};
```

Assume that we have an instance of this class, with the `n1` and `n2` members initialized to point at separate instances, as shown below:

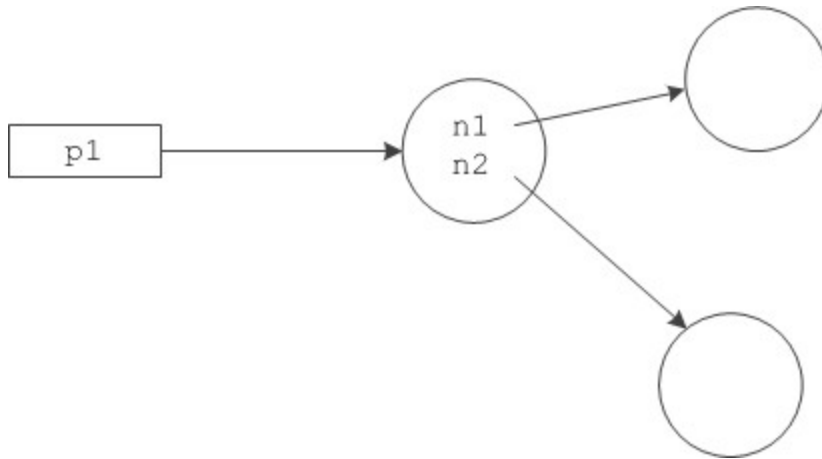

A class instance pointing at two other instances.

If we call `ice_clone` on the instance on the left, we end up with this situation:

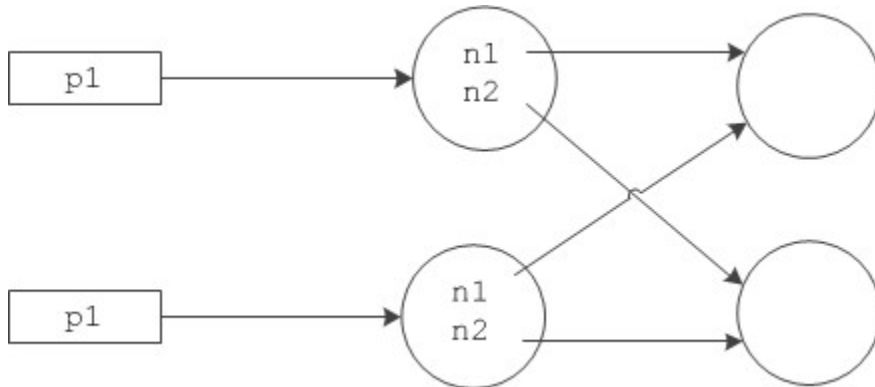

Resulting graph after calling `ice_clone` on the left-most instance.

As you can see, class members are shallow copied, that is, `ice_clone` makes a copy of the class instance on which it is invoked, but does not copy any class instances that are pointed at by the copied instance.

Note that `ice_clone` returns a value of type `Ice::ObjectPtr`, to avoid problems with compilers that do not support covariant return types. The generated `Ptr` classes contain a `dynamicCast` member that allows you to safely down-cast the return value of `ice_clone`. For example, the code to achieve the situation shown in the illustration above, looks as follows:

```

C++
NodePtr p1 = new Node(new Node, new Node);
NodePtr p2 = NodePtr::dynamicCast(p1->ice_clone());
```

`ice_clone` is generated by the Slice compiler for concrete classes (that is, classes that do not have operations). However, because classes with operations are abstract, the generated `ice_clone` for abstract classes cannot know how to instantiate an instance of the derived concrete class (because the name of the derived class is not known). This means that, for abstract classes, the generated `ice_clone` throw s a `CloneNotImplementedException`.

If you want to clone the implementation of an abstract class, you must override the virtual `ice_clone` member in your concrete implementation class. For example:

C++

```
class TimeOfDayI : public TimeOfDay {
public:
    virtual Ice::ObjectPtr ice_clone() const
    {
        return new TimeOfDayI(*this);
    }
};
```

Null Smart Pointers

A null smart pointer contains a null C++ pointer to its underlying instance. This means that if you attempt to dereference a null smart pointer, you get an `IceUtil::NullHandleException`:

C++

```
TimeOfDayPtr tod; // Construct null handle

try {
    tod->minute = 0; // Dereference null handle
    assert(false); // Cannot get here
} catch (const IceUtil::NullHandleException&) {
    ; // OK, expected
} catch (...) {
    assert(false); // Must get NullHandleException
}
```

Preventing Stack-Allocation of Class Instances

The Ice C++ mapping expects class instances to be allocated on the heap. Allocating class instances on the stack or in static variables is pragmatically useless because all the Ice APIs expect parameters that are smart pointers, not class instances. This means that, to do anything with a stack-allocated class instance, you must initialize a smart pointer for the instance. However, doing so does not work because it inevitably leads to a crash:

C++

```
{ // Enter scope
    TimeOfDayI t; // Stack-allocated class instance
    TimeOfDayPtr todp; // Handle for a TimeOfDay instance

    todp = &t; // Legal, but dangerous
    // ...

} // Leave scope, looming crash!
```

This goes badly wrong because, when `todp` goes out of scope, it decrements the reference count of the class to zero, which then calls `delete` on itself. However, the instance is stack-allocated and cannot be deleted, and we end up with undefined behavior (typically, a core

dump).

The following attempt to fix this is also doomed to failure:

```

C++
{
    TimeOfDayI t;           // Enter scope
    TimeOfDayPtr todp;     // Stack-allocated class instance
                          // Handle for a TimeOfDay instance

    todp = &t;             // Legal, but dangerous
    // ...
    todp = 0;              // Crash imminent!
}

```

This code attempts to circumvent the problem by clearing the smart pointer explicitly. However, doing so also causes the smart pointer to drop the reference count on the class to zero, so this code ends up with the same call to `delete` on the stack-allocated instance as the previous example.

The upshot of all this is: **never allocate a class instance on the stack or in a static variable**. The C++ mapping assumes that all class instances are allocated on the heap and no amount of coding trickery will change this.

 You could abuse the `__setNoDelete` member to disable deallocation, but we strongly discourage you from doing this.

You can prevent allocation of class instances on the stack or in static variables by adding a protected destructor to your implementation of the class: if a class has a protected destructor, allocation must be made with `new`, and static or stack allocation causes a compile-time error. In addition, explicit calls to `delete` on a heap-allocated instance also are flagged at compile time.

 **Tip**
You may want to habitually add a protected destructor to your implementation of abstract Slice classes to protect yourself from accidental heap allocation, as shown in [Class Operations](#). (For Slice classes that do not have operations, the Slice compiler automatically adds a protected destructor.)

Smart Pointers and Constructors

Slice classes inherit their reference-counting behavior from the `IceUtil::Shared` class, which ensures that reference counts are managed in a thread-safe manner. When a stack-allocated smart pointer goes out of scope, the smart pointer invokes the `__decRef` function on the reference-counted object. Ignoring thread-safety issues, `__decRef` is implemented like this:

```

C++
void
IceUtil::Shared::__decRef()
{
    if (--_ref == 0 && !_noDelete)
        delete this;
}

```

In other words, when the smart pointer calls `__decRef` on the pointed-at instance and the reference count reaches zero (which happens when the last smart pointer for a class instance goes out of scope), the instance self-destructs by calling `delete this`.

However, as you can see, the instance self-destructs only if `_noDelete` is false (which it is by default, because the constructor initializes it to false). You can call `__setNoDelete(true)` to prevent this self-destruction and, later, call `__setNoDelete(false)` to enable it again. This is necessary if, for example, a class in its constructor needs to pass `this` to another function:

```

C++

void someFunction(const TimeOfDayPtr& t)
{
    // ...
}

TimeOfDayI::TimeOfDayI()
{
    someFunction(this); // Trouble looming here!
}

```

At first glance, this code looks innocuous enough. While `TimeOfDayI` is being constructed, it passes `this` to `someFunction`, which expects a smart pointer. The compiler constructs a temporary smart pointer at the point of call (because the smart pointer template has a single-argument constructor that accepts a pointer to a heap-allocated instance, so the constructor acts as a conversion function). However, this code fails badly. The `TimeOfDayI` instance is constructed with a statement such as:

```

C++

TimeOfDayPtr tod = new TimeOfDayI;

```

The constructor of `TimeOfDayI` is called by operator `new` and, when the constructor starts executing, the reference count of the instance is zero (because that is what the reference count is initialized to by the `Shared` base class of `TimeOfDayI`). When the constructor calls `someFunction`, the compiler creates a temporary smart pointer, which increments the reference count of the instance and, once `someFunction` completes, the compiler dutifully destroys that temporary smart pointer again. But, of course, that drops the reference count back to zero and causes the `TimeOfDayI` instance to self-destruct by calling `delete this`. The net effect is that the call to `new TimeOfDayI` returns a pointer to an already deleted object, which is likely to cause the program to crash.

To get around the problem, you can call `__setNoDelete`:

```

C++

TimeOfDayI::TimeOfDayI()
{
    __setNoDelete(true);
    someFunction(this);
    __setNoDelete(false);
}

```

The code disables self-destruction while `someFunction` uses its temporary smart pointer by calling `__setNoDelete(true)`. By doing this, the reference count of the instance is incremented before `someFunction` is called and decremented back to zero when `someFunction` completes without causing the object to self-destruct. The constructor then re-enables self-destruction by calling `__setNoDelete(false)` before returning, so the statement

C++

```
TimeOfDayPtr tod = new TimeOfDayI;
```

does the usual thing, namely to increment the reference count of the object to 1, despite the fact that a temporary smart pointer existed while the constructor ran.



In general, whenever a class constructor passes `this` to a function or another class that accepts a smart pointer, you must temporarily disable self-destruction.

Smart Pointers and Exception Safety

Smart pointers are exception safe: if an exception causes the thread of execution to leave a scope containing a stack-allocated smart pointer, the C++ run time ensures that the smart pointer's destructor is called, so no resource leaks can occur:

C++

```
{ // Enter scope...

    TimeOfDayPtr tod = new TimeOfDayI; // Allocate instance

    someFuncThatMightThrow();          // Might throw...

    // ...

} // No leak here, even if an exception is thrown
```

If an exception is thrown, the destructor of `tod` runs and ensures that it deallocates the underlying class instance.

There is one potential pitfall you must be aware of though: if a constructor of a base class throws an exception, and another class instance holds a smart pointer to the instance being constructed, you can end up with a double deallocation. You can use the `__setNoDelete` mechanism to temporarily disable self-destruction in this case, as described [above](#).

Smart Pointers and Cycles

One thing you need to be aware of is the inability of reference counting to deal with cyclic dependencies. For example, consider the following simple self-referential class:

Slice

```
class Node {
    int val;
    Node next;
};
```

Intuitively, this class implements a linked list of nodes. As long as there are no cycles in the list of nodes, everything is fine, and our smart pointers will correctly deallocate the class instances. However, if we introduce a cycle, we have a problem:

```

C++
{
    // Open scope...

    NodePtr n1 = new Node; // N1 refcount == 1
    NodePtr n2 = new Node; // N2 refcount == 1
    n1->next = n2;        // N2 refcount == 2
    n2->next = n1;        // N1 refcount == 2

} // Destructors run:    // N2 refcount == 1,
                        // N1 refcount == 1, memory leak!

```

The nodes pointed to by `n1` and `n2` do not have names but, for the sake of illustration, let us assume that `n1`'s node is called N1, and `n2`'s node is called N2. When we allocate the N1 instance and assign it to `n1`, the smart pointer `n1` increments N1's reference count to 1. Similarly, N2's reference count is 1 after allocating the node and assigning it to `n2`. The next two statements set up a cyclic dependency between `n1` and `n2` by making their `next` pointers point at each other. This sets the reference count of both N1 and N2 to 2. When the enclosing scope closes, the destructor of `n2` is called first and decrements N2's reference count to 1, followed by the destructor of `n1`, which decrements N1's reference count to 1. The net effect is that neither reference count ever drops to zero, so both N1 and N2 are leaked.

Garbage Collection of Class Instances

The previous example illustrates a problem that is generic to using reference counts for deallocation: if a cyclic dependency exists anywhere in a graph (possibly via many intermediate nodes), all nodes in the cycle are leaked.

To avoid memory leaks due to such cycles, Ice for C++ contains a garbage collector. The collector identifies class instances that are part of one or more cycles but are no longer reachable from the program and deletes such instances:

- By default, garbage is collected whenever you destroy a communicator. This means that no memory is leaked when your program exits. (Of course, this assumes that you correctly [destroy your communicators](#).)
- You can also explicitly run the garbage collector by calling `Ice::collectGarbage`. For example, the leak caused by the preceding example can be avoided as follows:

```

C++
{
    // Open scope...

    NodePtr n1 = new Node; // N1 refcount == 1
    NodePtr n2 = new Node; // N2 refcount == 1
    n1->next = n2;        // N1 refcount == 2
    n2->next = n1;        // N2 refcount == 2

} // Destructors run:    // N2 refcount == 1,
                        // N1 refcount == 1

Ice::collectGarbage(); // Deletes N1 and N2

```

The call to `Ice::collectGarbage` deletes the no longer reachable instances N1 and N2 (as well as any other non-reachable instances that may have accumulated earlier).

- Deleting leaked memory with explicit calls to the garbage collector can be inconvenient because it requires polluting the code with calls to the collector. You can ask the Ice run time to run a garbage collection thread that periodically cleans up leaked memory by

setting the property `Ice.GC.Interval` to a non-zero value. For example, setting `Ice.GC.Interval` to 5 causes the collector thread to run the garbage collector once every five seconds. You can trace the execution of the collector by setting `Ice.Trace.GC` to a non-zero value.

Note that the garbage collector is useful only if your program actually creates cyclic class graphs. There is no point in running the garbage collector in programs that do not create such cycles. (For this reason, the collector thread is disabled by default and runs only if you explicitly set `Ice.GC.Interval` to a non-zero value.)

Smart Pointer Comparison

As for [proxy handles](#), class handles support the comparison operators `==`, `!=`, and `<`. This allows you to use class handles in STL sorted containers. Be aware that, for smart pointers, object identity is not used for the comparison, because class instances do not have identity. Instead, these operators simply compare the memory address of the classes they point to. This means that `operator==` returns true only if two smart pointers point at the same physical class instance:

```

C++

// Create a class instance and initialize
//
TimeOfDayIPtr p1 = new TimeOfDayI;
p1->hour = 23;
p1->minute = 10;
p1->second = 18;

// Create another class instance with
// the same member values
//
TimeOfDayIPtr p2 = new TimeOfDayI;
p2->hour = 23;
p2->minute = 10;
p2->second = 18;

assert(p1 != p2);          // The two do not compare equal

TimeOfDayIPtr p3 = p1;    // Point at first class again

assert(p1 == p3);        // Now they compare equal
```

See Also

- [Classes](#)
- [C++ Mapping for Classes](#)
- [Asynchronous Method Invocation \(AMI\) in C++](#)
- [The Server-Side main Function in C++](#)
- [Properties and Configuration](#)
- [The C++ Shared and SimpleShared Classes](#)

References

1. Stroustrup, B. 1997. *The C++ Programming Language*. Reading, MA: Addison-Wesley.

Asynchronous Method Invocation (AMI) in C++

Asynchronous Method Invocation (AMI) is the term used to describe the client-side support for the asynchronous programming model. AMI supports both oneway and twoway requests, but unlike their synchronous counterparts, AMI requests never block the calling thread. When a client issues an AMI request, the Ice run time hands the message off to the local transport buffer or, if the buffer is currently full, queues the request for later delivery. The application can then continue its activities and poll or wait for completion of the invocation, or receive a callback when the invocation completes.

AMI is transparent to the server: there is no way for the server to tell whether a client sent a request synchronously or asynchronously.

 As of version 3.4, Ice provides a new API for asynchronous method invocation. This page describes the new API. Note that the old API is deprecated and will be removed in a future release.

On this page:

- [Basic Asynchronous API in C++](#)
 - [Asynchronous Proxy Methods in C++](#)
 - [Asynchronous Exception Semantics in C++](#)
- [AsyncResult Class in C++](#)
- [Polling for Completion in C++](#)
- [Generic Completion Callbacks in C++](#)
 - [Using Cookies for Generic Completion Callbacks in C++](#)
- [Type-Safe Completion Callbacks in C++](#)
 - [Using Cookies for Type-Safe Completion Callbacks in C++](#)
- [Lambda Completion Callbacks in C++](#)
- [Asynchronous Oneway Invocations in C++](#)
- [Flow Control in C++](#)
- [Asynchronous Batch Requests in C++](#)
- [Concurrency Semantics for AMI in C++](#)
- [AMI Limitations in C++](#)

Basic Asynchronous API in C++

Consider the following simple Slice definition:

Slice

```

module Demo {
    interface Employees {
        string getName(int number);
    };
};

```

Asynchronous Proxy Methods in C++

Besides the synchronous proxy methods, `slice2cpp` generates the following asynchronous proxy methods:

C++

```
Ice::AsyncResultPtr begin_getName(Ice::Int number);
Ice::AsyncResultPtr begin_getName(Ice::Int number,
const Ice::Context& __ctx)

std::string end_getName(const Ice::AsyncResultPtr&);
```



Four additional overloads of `begin_getName` are generated for use with [generic callbacks](#) and [type-safe callbacks](#).

As you can see, the single `getName` operation results in `begin_getName` and `end_getName` methods. (The `begin_` method is overloaded so you can pass a [per-invocation context](#).)

- The `begin_getName` method sends (or queues) an invocation of `getName`. This method does not block the calling thread.
- The `end_getName` method collects the result of the asynchronous invocation. If, at the time the calling thread calls `end_getName`, the result is not yet available, the calling thread blocks until the invocation completes. Otherwise, if the invocation completed some time before the call to `end_getName`, the method returns immediately with the result.

A client could call these methods as follows:

C++

```
EmployeesPrx e = ...;
Ice::AsyncResultPtr r = e->begin_getName(99);

// Continue to do other things here...

string name = e->end_getName(r);
```

Because `begin_getName` does not block, the calling thread can do other things while the operation is in progress.

Note that `begin_getName` returns a value of type `AsyncResultPtr`. The `AsyncResult` associated with this smart pointer contains the state that the Ice run time requires to keep track of the asynchronous invocation. You must pass the `AsyncResultPtr` that is returned by the `begin_` method to the corresponding `end_` method.

The `begin_` method has one parameter for each in-parameter of the corresponding Slice operation. Similarly, the `end_` method has one out-parameter for each out-parameter of the corresponding Slice operation (plus the `AsyncResultPtr` parameter). For example, consider the following operation:

Slice

```
double op(int inp1, string inp2, out bool outp1, out long outp2);
```

The `begin_op` and `end_op` methods have the following signature:

C++

```
Ice::AsyncResultPtr begin_op(Ice::Int inp1, const ::std::string& inp2)

Ice::Double end_op(bool& outp1, Ice::Long& outp2,
const Ice::AsyncResultPtr&);
```

Asynchronous Exception Semantics in C++

If an invocation raises an exception, the exception is thrown by the `end_` method, even if the actual error condition for the exception was encountered during the `begin_` method ("on the way out"). The advantage of this behavior is that all exception handling is located with the code that calls the `end_` method (instead of being present twice, once where the `begin_` method is called, and again where the `end_` method is called).

There is one exception to the above rule: if you destroy the communicator and then make an asynchronous invocation, the `begin_` method throws `CommunicatorDestroyedException`. This is necessary because, once the run time is finalized, it can no longer throw an exception from the `end_` method.

The only other exception that is thrown by the `begin_` and `end_` methods is `IceUtil::IllegalArgumentException`. This exception indicates that you have used the API incorrectly. For example, the `begin_` method throws this exception if you call an operation that has a return value or out-parameters on a oneway proxy. Similarly, the `end_` method throws this exception if you use a different proxy to call the `end_` method than the proxy you used to call the `begin_` method, or if the `AsyncResult` you pass to the `end_` method was obtained by calling the `begin_` method for a different operation.

AsyncResult Class in C++

The `AsyncResult` that is returned by the `begin_` method encapsulates the state of the asynchronous invocation:

C++

```

class AsyncResult : virtual public IceUtil::Shared,
private IceUtil::noncopyable {
public:
    virtual bool operator==(const AsyncResult&) const;
    virtual bool operator<(const AsyncResult&) const;

    virtual Int getHash() const;

    virtual CommunicatorPtr getCommunicator() const;
    virtual ConnectionPtr getConnection() const;
    virtual ObjectPrx getProxy() const;
    const string& getOperation() const;
    LocalObjectPtr getCookie() const;

    bool isCompleted() const;
    void waitForCompleted();

    bool isSent() const;
    void waitForSent();

    void throwLocalException() const;

    bool sentSynchronously() const;
};

```

The methods have the following semantics:

- `bool operator==(const AsyncResult&) const`
`bool operator<(const AsyncResult&) const`
`Int getHash() const`

These methods allow you to create ordered or hashed collections of pending asynchronous invocations. This is useful, for example, if you can have a number of outstanding requests, and need to pass state between the `begin_` and the `end_` methods. In this case, you can use the returned `AsyncResult` objects as keys into a map that stores the state for each call.

- `CommunicatorPtr getCommunicator() const`
This method returns the communicator that sent the invocation.
- `virtual ConnectionPtr getConnection() const`
This method returns the connection that was used for the invocation. Note that, for typical asynchronous proxy invocations, this method returns a nil value because the possibility of automatic retries means the connection that is currently in use could change unexpectedly. The `getConnection` method only returns a non-nil value when the `AsyncResult` object is obtained by calling `begin_flushBatchRequests` on a `Connection` object.
- `virtual ObjectPrx getProxy() const`
This method returns the proxy that was used to call the `begin_` method, or nil if the `AsyncResult` object was not obtained via an asynchronous proxy invocation.
- `const string& getOperation() const`
This method returns the name of the operation.
- `LocalObjectPtr getCookie() const`

This method returns the `cookie` that was passed to the `begin_` method. If you did not pass a cookie to the `begin_` method, the return value is null.

- `bool isCompleted() const`
This method returns true if, at the time it is called, the result of an invocation is available, indicating that a call to the `end_` method will not block the caller. Otherwise, if the result is not yet available, the method returns false.
- `void waitForCompleted()`
This method blocks the caller until the result of an invocation becomes available.
- `bool isSent() const`
When you call the `begin_` method, the Ice run time attempts to write the corresponding request to the client-side transport. If the transport cannot accept the request, the Ice run time queues the request for later transmission. `isSent` returns true if, at the time it is called, the request has been written to the local transport (whether it was initially queued or not). Otherwise, if the request is still queued or an exception occurred before the request could be sent, `isSent` returns false.
- `void waitForSent()`
This method blocks the calling thread until a request has been written to the client-side transport, or an exception occurs. After `waitForSent` returns, `isSent` returns true if the request was successfully written to the client-side transport, or false if an exception occurred. In the case of a failure, you can call the corresponding `end_` method or `throwLocalException` to obtain the exception.
- `void throwLocalException() const`
This method throws the local exception that caused the invocation to fail. If no exception has occurred yet, `throwLocalException` does nothing.
- `bool sentSynchronously() const`
This method returns true if a request was written to the client-side transport without first being queued. If the request was initially queued, `sentSynchronously` returns false (independent of whether the request is still in the queue or has since been written to the client-side transport).

Polling for Completion in C++

The `AsyncResult` methods allow you to poll for call completion. Polling is useful in a variety of cases. As an example, consider the following simple interface to transfer files from client to server:

Slice

```
interface FileTransfer
{
    void send(int offset, ByteSeq bytes);
};
```

The client repeatedly calls `send` to send a chunk of the file, indicating at which offset in the file the chunk belongs. A naïve way to transmit a file would be along the following lines:

C++

```
FileHandle file = open(...);
FileTransferPrx ft = ...;
const int chunkSize = ...;

Ice::Int offset = 0;
while (!file.eof()) {
    ByteSeq bs;
    bs = file.read(chunkSize); // Read a chunk
    ft->send(offset, bs);      // Send the chunk
    offset += bs.size();
}
```

This works, but not very well: because the client makes synchronous calls, it writes each chunk on the wire and then waits for the server to receive the data, process it, and return a reply before writing the next chunk. This means that both client and server spend much of their time doing nothing — the client does nothing while the server processes the data, and the server does nothing while it waits for the client to send the next chunk.

Using asynchronous calls, we can improve on this considerably:

C++

```

FileHandle file = open(...);
FileTransferPrx ft = ...;
const int chunkSize = ...;
Ice::Int offset = 0;

list<Ice::AsyncResultPtr> results;
const int numRequests = 5;

while (!file.eof()) {
    ByteSeq bs;
    bs = file.read(chunkSize);

    // Send up to numRequests + 1 chunks asynchronously.
    Ice::AsyncResultPtr r = ft->begin_send(offset, bs);
    offset += bs.size();

    // Wait until this request has been passed to the transport.
    r->waitForSent();
    results.push_back(r);

    // Once there are more than numRequests, wait for the least
    // recent one to complete.
    while (results.size() > numRequests) {
        Ice::AsyncResultPtr r = results.front();
        results.pop_front();
        r->waitForCompleted();
    }
}

// Wait for any remaining requests to complete.
while (!results.empty()) {
    Ice::AsyncResultPtr r = results.front();
    results.pop_front();
    r->waitForCompleted();
}

```

With this code, the client sends up to `numRequests + 1` chunks before it waits for the least recent one of these requests to complete. In other words, the client sends the next request without waiting for the preceding request to complete, up to the limit set by `numRequests`. In effect, this allows the client to "keep the pipe to the server full of data": the client keeps sending data, so both client and server continuously do work.

Obviously, the correct chunk size and value of `numRequests` depend on the bandwidth of the network as well as the amount of time taken by the server to process each request. However, with a little testing, you can quickly zoom in on the point where making the requests larger or queuing more requests no longer improves performance. With this technique, you can realize the full bandwidth of the link to within a percent or two of the theoretical bandwidth limit of a native socket connection.

Generic Completion Callbacks in C++

The `begin_` method is overloaded to allow you to provide completion callbacks. Here are the corresponding methods for the `getName` operation:

```
C++
```

```
Ice::AsyncResultPtr begin_getName(
    Ice::Int number,
    const Ice::CallbackPtr& __del,
    const Ice::LocalObjectPtr& __cookie = 0);

Ice::AsyncResultPtr begin_getName(
    Ice::Int number,
    const Ice::Context& __ctx,
    const Ice::CallbackPtr& __del,
    const Ice::LocalObjectPtr& __cookie = 0);
```

The second version of `begin_getName` lets you override the default context. (We discuss the purpose of the `cookie` parameter in the next section.) Following the in-parameters, the `begin_` method accepts a parameter of type `Ice::CallbackPtr`. This is a smart pointer to a callback class that is provided by the Ice run time. This class stores an instance of a callback class that you implement. The Ice run time invokes a method on your callback instance when an asynchronous operation completes. Your callback class must provide a method that returns `void` and accepts a single parameter of type `const AsyncResultPtr&`, for example:

```
C++
```

```
class MyCallback : public IceUtil::Shared {
public:
    void finished(const Ice::AsyncResultPtr& r) {
        EmployeesPrx e = EmployeesPrx::uncheckedCast(r->getProxy());
        try {
            string name = e->end_getName(r);
            cout << "Name is: " << name << endl;
        } catch (const Ice::Exception& ex) {
            cerr << "Exception is: " << ex << endl;
        }
    }
};

typedef IceUtil::Handle<MyCallback> MyCallbackPtr;
```

Note that your callback class must derive from `IceUtil::Shared`. The callback method can have any name you prefer but its signature must match the preceding example.

The implementation of your callback method must call the `end_` method. The proxy for the call is available via the `getProxy` method on the `AsyncResult` that is passed by the Ice run time. The return type of `getProxy` is `Ice::ObjectPrx`, so you must down-cast the proxy to its correct type. (You should always use an `uncheckedCast` to do this, otherwise you will send an additional message to the server to verify the proxy type.)

Your callback method should catch and handle any exceptions that may be thrown by the `end_` method. If you allow an exception to escape from the callback method, the Ice run time produces a log entry by default and ignores the exception. (You can disable the log message by setting the property `Ice.Warn.AMICallback` to zero.)

To inform the Ice run time that you want to receive a callback for the completion of the asynchronous call, you pass the callback instance to the `begin_` method:

C++

```

EmployeesPrx e = ...;

MyCallbackPtr cb = new MyCallback;
Ice::CallbackPtr d = Ice::newCallback(cb, &MyCallback::finished);

e->begin_getName(99, d);

```

Note the call to `Ice::newCallback` in this example. This helper function expects a smart pointer to your callback instance and a member function pointer that specifies your callback method.

Using Cookies for Generic Completion Callbacks in C++

It is common for the `end_` method to require access to some state that is established by the code that calls the `begin_` method. As an example, consider an application that asynchronously starts a number of operations and, as each operation completes, needs to update different user interface elements with the results. In this case, the `begin_` method knows which user interface element should receive the update, and the `end_` method needs access to that element.

The API allows you to pass such state by providing a cookie. A cookie is an instance of a class that you write; the class can contain whatever data you want to pass, as well as any methods you may want to add to manipulate that data.

The only requirement on the cookie class is that it must derive from `Ice::LocalObject`. Here is an example implementation that stores a `WidgetHandle`. (We assume that this class provides whatever methods are needed by the `end_` method to update the display.)

C++

```

class Cookie : public Ice::LocalObject
{
public:
    Cookie(WidgetHandle h) : _h(h) {}
    WidgetHandle getWidget() { return _h; }

private:
    WidgetHandle _h;
};
typedef IceUtil::Handle<Cookie> CookiePtr;

```

When you call the `begin_` method, you pass the appropriate cookie instance to inform the `end_` method how to update the display:

C++

```
// Make cookie for call to getName(99).
CookiePtr cookie1 = new Cookie(widgetHandle1);

// Make cookie for call to getName(42);
CookiePtr cookie2 = new Cookie(widgetHandle2);

// Invoke the getName operation with different cookies.
e->begin_getName(99, getNameCB, cookie1);
e->begin_getName(24, getNameCB, cookie2);
```

The `end_` method can retrieve the cookie from the `AsyncResult` by calling `getCookie`. For this example, we assume that widgets have a `writeString` method that updates the relevant UI element:

C++

```
void
MyCallback::getName(const Ice::AsyncResultPtr& r)
{
    EmployeesPrx e = EmployeesPrx::uncheckedCast(r->getProxy());
    CookiePtr cookie = CookiePtr::dynamicCast(r->getCookie());
    try {
        string name = e->end_getName(r);
        cookie->getWidget()->writeString(name);
    } catch (const Ice::Exception& ex) {
        handleException(ex);
    }
}
```

The cookie provides a simple and effective way for you to pass state between the point where an operation is invoked and the point where its results are processed. Moreover, if you have a number of operations that share common state, you can pass the same cookie instance to multiple invocations.

Type-Safe Completion Callbacks in C++

The [generic callback API](#) is not entirely type-safe:

- You must down-cast the return value of `getProxy` to the correct proxy type before you can call the `end_` method.
- You must call the correct `end_` method to match the operation called by the `begin_` method.
- If you use a cookie, you must down-cast the cookie to the correct type before you can access the data inside the cookie.
- You must remember to catch exceptions when you call the `end_` method; if you forget to do this, you will not know that the operation failed.

`slice2cpp` generates an additional type-safe API that takes care of these chores for you. The type-safe API is provided as a template that works much like the `Ice::Callback` class of the generic API, but requires strongly-typed method signatures.

To use type-safe callbacks, you must implement a callback class that provides two callback methods:

- A success callback that is called if the operation succeeds
- A failure callback that is called if the operation raises an exception

As for the generic API, your callback class must derive from `IceUtil::Shared`. Here is a callback class for an invocation of the `getName` operation:

```
C++
```

```
class MyCallback : public IceUtil::Shared
{
public:
    void getNameCB(const string& name) {
        cout << "Name is: " << name << endl;
    }

    void failureCB(const Ice::Exception& ex) {
        cerr << "Exception is: " << ex << endl;
    }
};
```

The callback methods can have any name you prefer and must have `void` return type. The failure callback always has a single parameter of type `const Ice::Exception&`. The success callback parameters depend on the operation signature. If the operation has non-`void` return type, the first parameter of the success callback is the return value. The return value (if any) is followed by a parameter for each out-parameter of the corresponding Slice operation, in the order of declaration.

To receive these callbacks, you instantiate your callback instance and specify the methods you have defined before passing a smart pointer to a callback wrapper instance to the `begin_` method:

```
C++
```

```
MyCallbackPtr cb = new MyCallback;

Callback_Employees_getNamePtr getNameCB =
    newCallback_Employees_getName(cb, &MyCallback::getNameCB, &MyCallback::failureCB);

Callback_Employees_getNumberPtr getNumberCB =
    newCallback_Employees_getNumber(cb, &MyCallback::getNumberCB, &MyCallback::failureCB);

e->begin_getName(99, getNameCB);
e->begin_getNumber("Fred", getNumberCB);
```

Note how this code creates instances of two smart pointer types generated by `slice2cpp` named `Callback_Employees_getNamePtr` and `Callback_Employees_getNumberPtr`. Each smart pointer points to a template instance that encapsulates your callback instance and two member function pointers for the callback methods. The name of this smart pointer type is formed as follows:

```
<module>::Callback_<interface>_<operation>Ptr
```

Also note that the code uses helper functions to initialize the smart pointers. The first argument to the helper function is your callback instance, and the two following arguments are the success and failure member function pointers, respectively. The name of this helper function is formed as follows:

```
<module>::newCallback_<interface>_<operation>
```

It is legal to pass a null pointer as the success or failure callback. For the success callback, this is legal only for operations that have `void` return type and no out-parameters. This is useful if you do not care when the operation completes but want to know if the call failed. If you pass a null exception callback, the Ice run time will ignore any exception that is raised by the invocation.

The type of the success and exception member function pointers is provided as `Response` and `Exception` typedefs by the callback template. For example, you can ignore exceptions for an invocation of `getName` as follows:

```
C++
```

```
Callback_Employees_op::Exception nullException = 0;

MyCallbackPtr cb = new MyCallback;

Callback_Employees_getNamePtr getNameCB =
    newCallback_Employees_getName(cb, &MyCallback::getNameCB, nullException);

e->begin_getName(99, getNameCB); // Ignores exceptions
```

Using Cookies for Type-Safe Completion Callbacks in C++

The `begin_` method optionally accepts a cookie as a trailing parameter. As for the generic API, you can use the cookie to share state between the `begin_` and `end_` methods. However, with the type-safe API, there is no need to down-cast the cookie. Instead, the cookie parameter that is passed to the `end_` method is strongly typed. Assuming that you have defined a `Cookie` class and `CookiePtr` smart pointer, you can pass a cookie to the `begin_` method as follows:

```
C++
```

```
MyCallbackPtr cb = new MyCallback;

Callback_Employees_getNamePtr getNameCB =
    newCallback_Employees_getName(cb, &MyCallback::getNameCB, &MyCallback::failureCB);

CookiePtr cookie = new Cookie(widgetHandle);
e->begin_getName(99, getNameCB, cookie);
```

The callback methods of your callback class simply add the cookie parameter:

C++

```
class MyCallback : public IceUtil::Shared
{
public:
    void getNameCB(const string& name, const CookiePtr& cookie) {
        cookie->getWidget()->writeString(name);
    }

    void failureCB(const Ice::Exception& ex, const CookiePtr& cookie) {
        cookie->getWidget()->writeError(ex.what());
    }
};
```

Lambda Completion Callbacks in C++

`slice2cpp` generates overloaded versions of the `begin_` methods that accept lambda functions, eliminating the need to create a separate callback object. The Slice compiler generates the following methods for the `getName` operation:

C++

```

Ice::AsyncResultPtr
begin_getName(Ice::Int number,
              const Function<void (const std::string*)>& response,
              const Function<void (const Ice::Exception*)>& exception =
...
              const Function<void (bool)>& sent = ...);

Ice::AsyncResultPtr
begin_getName(Ice::Int number, const Ice::Context& ctx,
              const Function<void (const std::string*)>& response,
              const Function<void (const Ice::Exception*)>& exception =
...
              const Function<void (bool)>& sent = ...);

Ice::AsyncResultPtr
begin_getName(Ice::Int number,
              const Function<void (const Ice::AsyncResultPtr*)>&
completed,
              const Function<void (const Ice::AsyncResultPtr*)>& sent =
...);

Ice::AsyncResultPtr
begin_getName(Ice::Int number, const Ice::Context& ctx,
              const Function<void (const Ice::AsyncResultPtr*)>&
completed,
              const Function<void (const Ice::AsyncResultPtr*)>& sent =
...);

```

The overloaded versions of `begin_getName` allow you to use the type-safe and generic styles, with and without a context argument. Notice that default values are provided for the `exception` and `sent` arguments, meaning you can omit these arguments if you wish to ignore their events. The first two functions above correspond to the type-safe API and the second two have generic API semantics.



These `begin_` methods are generated by default, but can only be used with a compiler that supports C++11 lambda functions, and with an Ice installation that was built with C++11 features enabled.

We can invoke `begin_getName` as shown below:

C++

```

EmployeesPrx e = ...;

// Type-safe
e->begin_getName(42, [](const std::string& name) { cout << "name = " <<
name << endl; });

// Generic
e->begin_getName(42, [=](const Ice::AsyncResultPtr& r) {
    cout << "name = " << e->end_getName(r) << endl;
});

```

For the sake of brevity we have omitted the error handling that would normally be necessary.

Asynchronous Oneway Invocations in C++

You can invoke operations via oneway proxies asynchronously, provided the operation has `void` return type, does not have any out-parameters, and does not raise user exceptions. If you call the `begin_` method on a oneway proxy for an operation that returns values or raises a user exception, the `begin_` method throws an `IceUtil::IllegalArgumentException`.

For the generic API, the callback method looks exactly as for a twoway invocation. However, for oneway invocations, the Ice run time does not call the callback method unless the invocation raised an exception during the `begin_` method ("on the way out").

For the type-safe API, the `newCallback` helper for `void` operations is overloaded so you can omit the success callback. For example, here is how you could call `ice_ping` asynchronously:

C++

```

MyCallbackPtr cb = new MyCallback;

Ice::Callback_Object_ice_pingPtr callback =
    Ice::newCallback_Object_ice_ping(cb, &MyCallback::failureCB);

p->begin_opVoid(callback);

```

Flow Control in C++

Asynchronous method invocations never block the thread that calls the `begin_` method: the Ice run time checks to see whether it can write the request to the local transport. If it can, it does so immediately in the caller's thread. (In that case, `AsyncResult::sentSynchronously` returns true.) Alternatively, if the local transport does not have sufficient buffer space to accept the request, the Ice run time queues the request internally for later transmission in the background. (In that case, `AsyncResult::sentSynchronously` returns false.)

This creates a potential problem: if a client sends many asynchronous requests at the time the server is too busy to keep up with them, the requests pile up in the client-side run time until, eventually, the client runs out of memory.

The API provides a way for you to implement flow control by counting the number of requests that are queued so, if that number exceeds some threshold, the client stops invoking more operations until some of the queued operations have drained out of the local transport.

For the generic API, you can create an additional callback method:

C++

```
class MyCallback : public IceUtil::Shared {
public:
    void finished(const Ice::AsyncResultPtr&);
    void sent(const Ice::AsyncResultPtr&);
};
typedef IceUtil::Handle<MyCallback> MyCallbackPtr;
```

As with any other callback method, you are free to choose any name you like. For this example, the name of the callback method is `sent`. You inform the Ice run time that you want to be informed when a call has been passed to the local transport by specifying the `sent` method as an additional parameter when you create the `Ice::Callback`:

C++

```
EmployeesPrx e = ...;

MyCallbackPtr cb = new MyCallback;
Ice::CallbackPtr d = Ice::newCallback(cb, &MyCallback::finished,
&MyCallback::sent);

e->begin_getName(99, d);
```

If the Ice run time can immediately pass the request to the local transport, it does so and invokes the `sent` method from the thread that calls the `begin_` method. On the other hand, if the run time has to queue the request, it calls the `sent` method from a different thread once it has written the request to the local transport. In addition, you can find out from the `AsyncResult` that is returned by the `begin_` method whether the request was sent synchronously or was queued, by calling `sentSynchronously`.

For the generic API, the `sent` method has the following signature:

C++

```
void sent(const Ice::AsyncResult&);
```

For the type-safe API, there are two versions, one without and one with a cookie:

C++

```
void sent(bool sentSynchronously);
void sent(bool sentSynchronously, const <CookiePtr>& cookie);
```

For the version with a cookie, `<CookiePtr>` is replaced with the actual type of the cookie smart pointer you passed to the `begin_` method.

The `sent` methods allow you to limit the number of queued requests by counting the number of requests that are queued and decrementing the count when the Ice run time passes a request to the local transport.

Asynchronous Batch Requests in C++

Applications that send [batched requests](#) can either flush a batch explicitly or allow the Ice run time to flush automatically. The proxy method `ice_flushBatchRequests` performs an immediate flush using the synchronous invocation model and may block the calling thread until the entire message can be sent. Ice also provides asynchronous versions of this method so you can flush batch requests asynchronously.

`begin_ice_flushBatchRequests` and `end_ice_flushBatchRequests` are proxy methods that flush any batch requests queued by that proxy.

In addition, similar methods are available on the communicator and the `Connection` object that is returned by `AsyncResult::getConnection`. These methods flush batch requests sent via the same communicator and via the same connection, respectively.

Concurrency Semantics for AMI in C++

The Ice run time always invokes your callback methods from a separate thread. This means that you can safely use a non-recursive mutex without risking deadlock. There is one exception to this rule: the run time calls the `sent` callback from the thread calling the `begin_` method if the request could be sent synchronously. In the `sent` callback, you know which thread is calling the callback by looking at the `sentSynchronously` member or parameter, so you can take appropriate action to avoid a self-deadlock.

AMI Limitations in C++

AMI invocations cannot be sent using collocated optimization. If you attempt to invoke an AMI operation using a proxy that is configured to use [collocation optimization](#), the Ice run time raises `CollocationOptimizationException` if the servant happens to be collocated; the request is sent normally if the servant is not collocated. You can disable this optimization if necessary.

See Also

- [C++ Mapping for Classes](#)
- [Smart Pointers for Classes](#)
- [Request Contexts](#)
- [Batched Invocations](#)
- [Location Transparency](#)

slice2cpp Command-Line Options

On this page:

- [slice2cpp Command-Line Options](#)
 - `--header-ext` *EXT*
 - `--source-ext` *EXT*
 - `--add-header` *HDR* [*,GUARD*]
 - `--include-dir` *DIR*
 - `--impl`
 - `--depend`
 - `--dll-export` *SYMBOL*
 - `--checksum`
 - `--stream`
- [Include Directives](#)
 - [Header Files](#)
 - [Source Files](#)

slice2cpp Command-Line Options

The Slice-to-C++ compiler, `slice2cpp`, offers the following command-line options in addition to the [standard options](#).

`--header-ext` *EXT*

Changes the file extension for the generated header files from the default `h` to the extension specified by *EXT*.

You can also change the header file extension with a global metadata directive:

```

Slice

[[ "cpp:header-ext:hpp" ]]

// ...
```

Only one such directive can appear in each source file. If you specify a header extension on both the command line and with a metadata directive, the metadata directive takes precedence. This ensures that included Slice files that were compiled separately get the correct header extension (provided that the included Slice files contain a corresponding metadata directive). For example:

```

Slice

// File example.ice
#include <Ice/BuiltinSequences.ice>

// ...
```

Compiling this file with

```

$ slice2cpp --header-ext=hpp -I/opt/Ice/include example.ice
```

generates `example.hpp`, but the `#include` directive in that file is for `Ice/BuiltinSequences.h` (not `Ice/BuiltinSequences.hpp`) because `BuiltinSequences.ice` contains the metadata directive `[["cpp:header-ext:h"]]`.

You normally will not need to use this metadata directive. The directive is necessary only if:

- You `#include` a Slice file in one of your own Slice files.
- The included Slice file is part of a library you link against.
- The library ships with the included Slice file's header.
- The library header uses a different header extension than your own code.

For example, if the library uses `.hpp` as the header extension, but your own code uses `.h`, the library's Slice file should contain a `[["cpp:header?ext:hpp"]]` directive. (If the directive is missing, you can add it to the library's Slice file.)

`--source-ext EXT`

Changes the file extension for the generated source files from the default `cpp` to the extension specified by `EXT`.

`--add-header HDR[,GUARD]`

This option adds an include directive for the specified header at the beginning of the generated source file (preceding any other include directives). If `GUARD` is specified, the include directive is protected by the specified guard. For example, `--add-header precompiled.h, __PRECOMPILED_H__` results in the following directives at the beginning of the generated source file:

C++

```
#ifndef __PRECOMPILED_H__
#define __PRECOMPILED_H__
#include <precompiled.h>
#endif
```

The option can be repeated to create include directives for several files.

As suggested by the preceding example, this option is useful mainly to integrate the generated code with a compiler's precompiled header mechanism.

`--include-dir DIR`

Modifies `#include` directives in source files to prepend the path name of each header file with the directory `DIR`.

`--impl`

Generate sample implementation files. This option will not overwrite an existing file.

`--depend`

Prints makefile dependency information to standard output. No code is generated when this option is specified. The output generally needs to be filtered before it can be included in a makefile; the Ice build system uses the script `config/makedepend.py` for this purpose.

`--dll-export SYMBOL`

Use `SYMBOL` to control DLL exports or imports. This option allows you to selectively export or import global symbols in the generated code. As an example, compiling a Slice definition with:

```
$ slice2cpp --dll-export ENABLE_DLL x.ice
```

results in the following additional code being generated into `x.h`:

C++

```

#ifndef ENABLE_DLL
#   ifdef ENABLE_DLL_EXPORTS
#       define ENABLE_DLL ICE_DECLSPEC_EXPORT
#   else
#       define ENABLE_DLL ICE_DECLSPEC_IMPORT
#   endif
#endif

```

`ICE_DECLSPEC_EXPORT` and `ICE_DECLSPEC_IMPORT` are platform-specific macros. For example, for Windows, they are defined as `declspec(dllexport)` and `declspec(dllimport)`, respectively; for Solaris using CC version 5.5 or later, `ICE_DECLSPEC_EXPORT` is defined as `global`, and `ICE_DECLSPEC_IMPORT` is empty.



Similar definitions exist for other platforms. For platforms that do not have any concept of explicit export or import of shared library symbols, both macros are empty.

The symbol name you specify on the command line (`ENABLE_DLL` in this example) is used by the generated code to export or import any symbols that must be visible to code outside the generated compilation unit. The net effect is that, if you want to create a DLL that includes `x.cpp`, but also want to use the generated types in compilation units outside the DLL, you can arrange for the relevant symbols to be exported by compiling `x.cpp` with `-DENABLE_DLL_EXPORTS`.

--checksum

Generate [checksums](#) for Slice definitions.

--stream

Generate [streaming helper functions](#) for Slice types.

Include Directives

The `#include` directives generated by the Slice-to-C++ compiler can be a source of confusion if the semantics governing their generation are not well-understood. The generation of `#include` directives is influenced by the command-line options `-I` and `--include-dir`; these options are discussed in more detail below. The `--output-dir` option directs the translator to place all generated files in a particular directory, but has no impact on the contents of the generated code.

Given that the `#include` directives in header files and source files are generated using different semantics, we describe them in separate sections.

Header Files

In most cases, the compiler generates the appropriate `#include` directives by default. As an example, suppose file `A.ice` includes `B.ice` using the following statement:

Slice

```

// A.ice
#include <B.ice>

```

Assuming both files are in the current working directory, we run the compiler as shown below:

```
$ slice2cpp -I. A.ice
```

The generated file `A.h` contains this `#include` directive:

```
C++
// A.h
#include <B.h>
```

If the proper include paths are specified to the C++ compiler, everything should compile correctly.

Similarly, consider the common case where `A.ice` includes `B.ice` from a subdirectory:

```
Slice
// A.ice
#include <inc/B.ice>
```

Assuming both files are in the `inc` subdirectory, we run the compiler as shown below:

```
$ slice2cpp -I. inc/A.ice
```

The default output of the compiler produces this `#include` directive in `A.h`:

```
C++
// A.h
#include <inc/B.h>
```

Again, it is the user's responsibility to ensure that the C++ compiler is configured to find `inc/B.h` during compilation.

Now let us consider a more complex example, in which we do not want the `#include` directive in the header file to match that of the Slice file. This can be necessary when the organizational structure of the Slice files does not match the application's C++ code. In such a case, the user may need to relocate the generated files from the directory in which they were created, and the `#include` directives must be aligned with the new structure.

For example, let us assume that `B.ice` is located in the subdirectory `slice/inc`:

```
Slice
// A.ice
#include <slice/inc/B.ice>
```

However, we do not want the `slice` subdirectory to appear in the `#include` directive generated in the header file, therefore we specify the additional compiler option `-Islice`:

```
$ slice2cpp -I. -Islice slice/inc/A.ice
```

The generated code demonstrates the impact of this extra option:

```
C++
// A.h
#include <inc/B.h>
```

As you can see, the `#include` directives generated in header files are affected by the include paths that you specify when running the compiler. Specifically, the include paths are used to abbreviate the path name in generated `#include` directives.

When translating an `#include` directive from a Slice file to a header file, the compiler compares each of the include paths against the path of the included file. If an include path matches the leading portion of the included file, the compiler removes that leading portion when generating the `#include` directive in the header file. If more than one include path matches, the compiler selects the one that results in the shortest path for the included file.

For example, suppose we had used the following options when compiling `A.ice`:

```
$ slice2cpp -I. -Islice -Islice/inc slice/inc/A.ice
```

In this case, the compiler compares all of the include paths against the included file `slice/inc/B.ice` and generates the following directive:

```
C++
// A.h
#include <B.h>
```

The option `-Islice/inc` produces the shortest result, therefore the default path for the included file (`slice/inc/B.h`) is replaced with `B.h`.

In general, the `-I` option plays two roles: it enables the preprocessor to locate included Slice files, and it provides you with a certain amount of control over the generated `#include` directives. In the last example above, the preprocessor locates `slice/inc/B.ice` using the include path specified by the `-I.` option. The remaining `-I` options do not help the preprocessor locate included files; they are simply hints to the compiler.

Finally, we recommend using caution when specifying include paths. If the preprocessor is able to locate an included file via multiple include paths, it always uses the first include path that successfully locates the file. If you intend to modify the generated `#include` directives by specifying extra `-I` options, you must ensure that your include path hints match the include path selected by the preprocessor to locate the included file. As a general rule, you should avoid specifying include paths that enable the preprocessor to locate a file in multiple ways.

Source Files

By default, the compiler generates `#include` directives in source files using only the base name of the included file. This behavior is usually appropriate when the source file and header file reside in the same directory.

For example, suppose `A.ice` includes `B.ice` from a subdirectory, as shown in the following snippet of `A.ice`:

Slice

```
// A.ice
#include <inc/B.ice>
```

We generate the source file using this command:

```
$ slice2cpp -I. inc/A.ice
```

Upon examination, we see that the source file contains the following `#include` directive:

C++

```
// A.cpp
#include <B.h>
```

However, suppose that we wish to enforce a particular standard for generated `#include` directives so that they are compatible with our C++ compiler's existing include path settings. In this case, we use the `--include-dir` option to modify the generated code. For example, consider the compiler command shown below:

```
$ slice2cpp --include-dir src -I. inc/A.ice
```

The source file now contains the following `#include` directive:

C++

```
// A.cpp
#include <src/B.h>
```

Any leading path in the included file is discarded as usual, and the value of the `--include-dir` option is prepended.

See Also

- [Using the Slice Compilers](#)
- [Using Slice Checksums in C++](#)
- [Streaming Interfaces](#)

Using Slice Checksums in C++

The Slice compilers can optionally generate [checksums](#) of Slice definitions. For `slice2cpp`, the `--checksum` option causes the compiler to generate code in each C++ source file that accumulates checksums in a global map. A copy of this map can be obtained by calling a function defined in the header file `Ice/SliceChecksums.h`:

```

C++

namespace Ice {
    Ice::SliceChecksumDict sliceChecksums();
}

```

In order to verify a server's checksums, a client could simply compare the dictionaries using the equality operator. However, this is not feasible if it is possible that the server might be linked with more Slice definitions than the client. A more general solution is to iterate over the local checksums as demonstrated below:

```

C++

Ice::SliceChecksumDict serverChecksums = ...
Ice::SliceChecksumDict localChecksums = Ice::sliceChecksums();

for (Ice::SliceChecksumDict::const_iterator p = localChecksums.begin();
     p != localChecksums.end(); ++p) {

    Ice::SliceChecksumDict::const_iterator q
= serverChecksums.find(p->first);
    if (q == serverChecksums.end()) {
        // No match found for type id!
    } else if (p->second != q->second) {
        // Checksum mismatch!
    }
}
}

```

In this example, the client first verifies that the server's dictionary contains an entry for each Slice type ID, and then it proceeds to compare the checksums.

See Also

- [Slice Checksums](#)
- [slice2cpp Command-Line Options](#)

Example of a File System Client in C++

This page presents a very simple client to access a server that implements the file system we developed in [Slice for a Simple File System](#). The C++ code shown here hardly differs from the code you would write for an ordinary C++ program. This is one of the biggest advantages of using Ice: accessing a remote object is as easy as accessing an ordinary, local C++ object. This allows you to put your effort where you should, namely, into developing your application logic instead of having to struggle with arcane networking APIs. This is true for the [server side](#) as well, meaning that you can develop distributed applications easily and efficiently.

We now have seen enough of the client-side C++ mapping to develop a complete client to access our remote file system. For reference, here is the Slice definition once more:

```

Slice

module Filesystem {
    interface Node {
        idempotent string name();
    };

    exception GenericError {
        string reason;
    };

    sequence<string> Lines;

    interface File extends Node {
        idempotent Lines read();
        idempotent void write(Lines text) throws GenericError;
    };

    sequence<Node*> NodeSeq;

    interface Directory extends Node {
        idempotent NodeSeq list();
    };
};
```

To exercise the file system, the client does a recursive listing of the file system, starting at the root directory. For each node in the file system, the client shows the name of the node and whether that node is a file or directory. If the node is a file, the client retrieves the contents of the file and prints them.

The body of the client code looks as follows:

```

C++

#include <Ice/Ice.h>
#include <Filesystem.h>
#include <iostream>
#include <iterator>

using namespace std;
using namespace Filesystem;
```

```

static void
listRecursive(const DirectoryPrx& dir, int depth = 0)
{
    // ...
}

int
main(int argc, char* argv[])
{
    int status = 0;
    Ice::CommunicatorPtr ic;
    try {
        // Create a communicator
        //
        ic = Ice::initialize(argc, argv);

        // Create a proxy for the root directory
        //
        Ice::ObjectPrx base
= ic->stringToProxy("RootDir:default -p 10000");
        if (!base)
            throw "Could not create proxy";

        // Down-cast the proxy to a Directory proxy
        //
        DirectoryPrx rootDir = DirectoryPrx::checkedCast(base);
        if (!rootDir)
            throw "Invalid proxy";

        // Recursively list the contents of the root directory
        //
        cout << "Contents of root directory:" << endl;
        listRecursive(rootDir);
    } catch (const Ice::Exception& ex) {
        cerr << ex << endl;
        status = 1;
    } catch (const char* msg) {
        cerr << msg << endl;
        status = 1;
    }

    // Clean up
    //
    if (ic)
        ic->destroy();
}

```

```
    return status;  
}
```

1. The code includes a few header files:

- `Ice/Ice.h`:
Always included in both client and server source files, provides definitions that are necessary for accessing the Ice run time.
- `Filesystem.h`:
The header that is generated by the Slice compiler from the Slice definitions in `Filesystem.ice`.
- `iostream`:
The client uses the `iostream` library to produce its output.
- `iterator`:
The implementation of `listRecursive` uses an STL iterator.

2. The code adds `using` declarations for the `std` and `Filesystem` namespaces.

3. The structure of the code in `main` follows what we saw in [Hello World Application](#). After initializing the run time, the client creates a proxy to the root directory of the file system. For this example, we assume that the server runs on the local host and listens using the default protocol (TCP/IP) at port 10000. The object identity of the root directory is known to be `RootDir`.

4. The client down-casts the proxy to `DirectoryPrx` and passes that proxy to `listRecursive`, which prints the contents of the file system.

Most of the work happens in `listRecursive`:

C++

```

// Recursively print the contents of directory "dir" in
// tree fashion. For files, show the contents of each file.
// The "depth" parameter is the current nesting level
// (for indentation).

static void
listRecursive(const DirectoryPrx& dir, int depth = 0)
{
    string indent(++depth, '\t');

    NodeSeq contents = dir->list();

    for (NodeSeq::const_iterator i = contents.begin();
         i != contents.end(); ++i) {
        DirectoryPrx dir = DirectoryPrx::checkedCast(*i);
        FilePrx file = FilePrx::uncheckedCast(*i);
        cout << indent << (*i)->name()
        << (dir ? " (directory):" : " (file):") << endl;
        if (dir) {
            listRecursive(dir, depth);
        } else {
            Lines text = file->read();
            for (Lines::const_iterator j = text.begin();
                 j != text.end(); ++j) {
                cout << indent << "\t" << *j << endl;
            }
        }
    }
}

```

The function is passed a proxy to a directory to list, and an indent level. (The indent level increments with each recursive call and allows the code to print the name of each node at an indent level that corresponds to the depth of the tree at that node.) `listRecursive` calls the `list` operation on the directory and iterates over the returned sequence of nodes:

1. The code does a `checkedCast` to narrow the `Node` proxy to a `Directory` proxy, as well as an `uncheckedCast` to narrow the `Node` proxy to a `File` proxy. Exactly one of those casts will succeed, so there is no need to call `checkedCast` twice: if the `Node` is a `Directory`, the code uses the `DirectoryPrx` returned by the `checkedCast`; if the `checkedCast` fails, we *know* that the `Node` is a `File` and, therefore, an `uncheckedCast` is sufficient to get a `FilePrx`. In general, if you know that a down-cast to a specific type will succeed, it is preferable to use an `uncheckedCast` instead of a `checkedCast` because an `uncheckedCast` does not incur any network traffic.
2. The code prints the name of the file or directory and then, depending on which cast succeeded, prints "`(directory)`" or "`(file)`" following the name.
3. The code checks the type of the node:
 - If it is a directory, the code recurses, incrementing the indent level.
 - If it is a file, the code calls the `read` operation on the file to retrieve the file contents and then iterates over the returned sequence of lines, printing each line.

Assume that we have a small file system consisting of two files and a directory as follows:

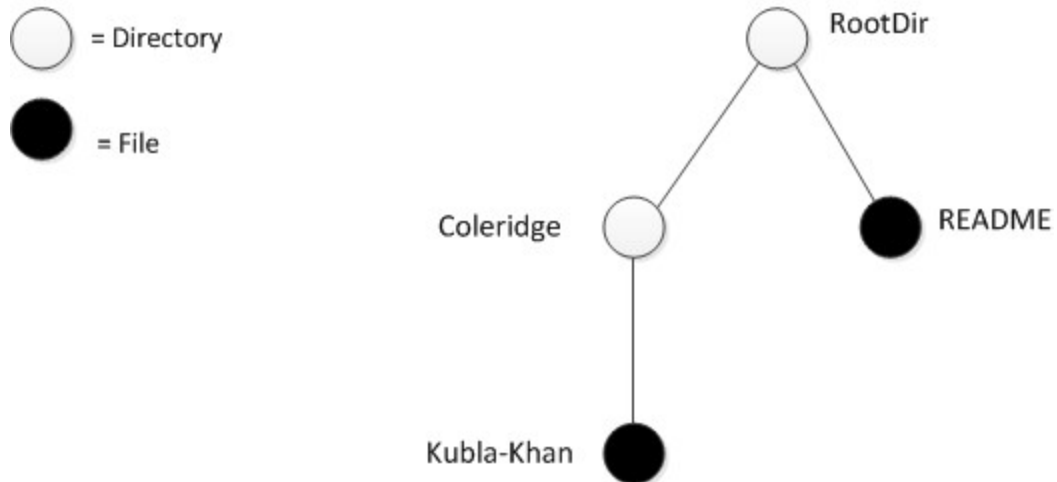

A small file system.

The output produced by the client for this file system is:

```

Contents of root directory:
  README (file):
    This file system contains a collection of poetry.
  Coleridge (directory):
    Kubla_Khan (file):
      In Xanadu did Kubla Khan
      A stately pleasure-dome decree:
      Where Alph, the sacred river, ran
      Through caverns measureless to man
      Down to a sunless sea.
  
```

Note that, so far, our client (and server) are not very sophisticated:

- The protocol and address information are hard-wired into the code.
- The client makes more remote procedure calls than strictly necessary; with minor redesign of the Slice definitions, many of these calls can be avoided.

We will see how to address these shortcomings in our discussions of [IceGrid](#) and [object life cycle](#).

See Also

- [Hello World Application](#)
- [Slice for a Simple File System](#)
- [Example of a File System Server in C++](#)
- [Object Life Cycle](#)
- [IceGrid](#)

Server-Side Slice-to-C++ Mapping

The mapping for Slice data types to C++ is identical on the client side and server side. This means that everything in [Client-Side Slice-to-C++ Mapping](#) also applies to the server side. However, for the server side, there are a few additional things you need to know — specifically how to:

- Initialize and finalize the server-side run time
- Implement servants
- Pass parameters and throw exceptions
- Create servants and register them with the Ice run time.

Because the mapping for Slice data types is identical for clients and servers, the server-side mapping only adds a few additional mechanisms to the client side: a small API to initialize and finalize the run time, plus a few rules for how to derive servant classes from skeletons and how to register servants with the server-side run time.

Although the examples we present are very simple, they accurately reflect the basics of writing an Ice server. Of course, for more sophisticated servers, you will be using [additional APIs](#), for example, to improve performance or scalability. However, these APIs are all described in [Slice](#), so, to use these APIs, you need not learn any C++ mapping rules beyond those we describe here.

Topics

- [The Server-Side main Function in C++](#)
- [Server-Side C++ Mapping for Interfaces](#)
- [Parameter Passing in C++](#)
- [Raising Exceptions in C++](#)
- [Object Incarnation in C++](#)
- [Asynchronous Method Dispatch \(AMD\) in C++](#)
- [Example of a File System Server in C++](#)

The Server-Side main Function in C++

On this page:

- [A Basic main Function in C++](#)
- [The `Ice::Application` Class](#)
 - [Using `Ice::Application` on the Client Side](#)
 - [Catching Signals in C++](#)
 - [Ice::Application and Properties](#)
 - [Limitations of `Ice::Application`](#)
- [The `Ice::Service` Class](#)
 - [Ice::Service Member Functions](#)
 - [Unix Daemons](#)
 - [Windows Services](#)
 - [Ice::Service Logging Considerations](#)

A Basic main Function in C++

The main entry point to the Ice run time is represented by the local Slice interface `Ice::Communicator`. As for the client side, you must initialize the Ice run time by calling `Ice::initialize` before you can do anything else in your server. `Ice::initialize` returns a smart pointer to an instance of an `Ice::Communicator`:

C++

```

int
main(int argc, char* argv[])
{
    Ice::CommunicatorPtr ic = Ice::initialize(argc, argv);
    // ...
}

```

`Ice::initialize` accepts a C++ reference to `argc` and `argv`. The function scans the argument vector for any [command-line options](#) that are relevant to the Ice run time; any such options are removed from the argument vector so, when `Ice::initialize` returns, the only options and arguments remaining are those that concern your application. If anything goes wrong during initialization, `initialize` throws an exception.

 `Ice::initialize` has [additional overloads](#) to permit other information to be passed to the Ice run time.

Before leaving your `main` function, you must call `Communicator::destroy`. The `destroy` operation is responsible for finalizing the Ice run time. In particular, `destroy` waits for any operation implementations that are still executing in the server to complete. In addition, `destroy` ensures that any outstanding threads are joined with and reclaims a number of operating system resources, such as file descriptors and memory. Never allow your `main` function to terminate without calling `destroy` first; doing so has undefined behavior.

The general shape of our server-side `main` function is therefore as follows:

C++

```

#include <Ice/Ice.h>

int
main(int argc, char* argv[])
{
    int status = 0;
    Ice::CommunicatorPtr ic;
    try {
        ic = Ice::initialize(argc, argv);

        // Server code here...

    } catch (const Ice::Exception& e) {
        cerr << e << endl;
        status = 1;
    } catch (const std::string& msg) {
        cerr << msg << endl;
        status = 1;
    } catch (const char* msg) {
        cerr << msg << endl;
        status = 1;
    }
    if (ic) {
        try {
            ic->destroy();
        } catch (const Ice::Exception& e) {
            cerr << e << endl;
            status = 1;
        }
    }
    return status;
}

```

Note that the code places the call to `Ice::initialize` in to a `try` block and takes care to return the correct exit status to the operating system. Also note that an attempt to destroy the communicator is made only if the initialization succeeded.

The `catch` handlers for `const std::string &` and `const char *` are in place as a convenience feature: if we encounter a fatal error condition anywhere in the server code, we can simply throw a string or a string literal containing an error message; this causes the stack to be unwound back to `main`, at which point the error message is printed and, after destroying the communicator, `main` terminates with non-zero exit status.

The `Ice::Application` Class

The preceding structure for the `main` function is so common that `Ice` offers a class, `Ice::Application`, that encapsulates all the correct initialization and finalization activities. The definition of the class is as follows (with some detail omitted for now):

C++

```

namespace Ice {
    enum SignalPolicy { HandleSignals, NoSignalHandling };

    class Application /* ... */ {
    public:
        Application(SignalPolicy = HandleSignals);
        virtual ~Application();

        int main(int argc, char*[] argv);
        int main(int argc, char*[] argv, const char* config);
        int main(int argc, char*[] argv,
const Ice::InitializationData& id);
        int main(int argc, char* const [] argv);
        int main(int argc, char* const [] argv, const char* config);
        int main(int argc, char* const [] argv,
const Ice::InitializationData& id);
        int main(const Ice::StringSeq&);
        int main(const Ice::StringSeq&, const char* config);
        int main(const Ice::StringSeq&,
const Ice::InitializationData& id);

#ifdef _WIN32
        int main(int argc, wchar_t*[] argv);
        int main(int argc, wchar_t*[] argv, const char* config);
        int main(int argc, wchar_t*[] argv,
const Ice::InitializationData& id);
#endif

        virtual int run(int, char*[]) = 0;

        static const char* appName();
        static CommunicatorPtr communicator();
        // ...
    };
}

```

The intent of this class is that you specialize `Ice::Application` and implement the pure virtual `run` method in your derived class. Whatever code you would normally place in `main` goes into the `run` method instead. Using `Ice::Application`, our program looks as follows:

C++

```

#include <Ice/Ice.h>

class MyApplication : virtual public Ice::Application {
public:
    virtual int run(int, char*[]) {

        // Server code here...

        return 0;
    }
};

int
main(int argc, char* argv[])
{
    MyApplication app;
    return app.main(argc, argv);
}

```

Note that `Application::main` is overloaded: you can pass a string sequence instead of an `argc/argv` pair. This is useful if you need to parse application-specific property settings on the command line. You also can call `main` with an optional file name or an `InitializationData` structure.

If you pass a [configuration file name](#) to `main`, the property settings in this file are overridden by settings in a file identified by the `ICE_CONFIG` environment variable (if defined). Property settings supplied on the [command line](#) take precedence over all other settings.

The `Application::main` function does the following:

1. It installs an exception handler for `Ice::Exception`. If your code fails to handle an Ice exception, `Application::main` prints the exception details on `stderr` before returning with a non-zero return value.
2. It installs exception handlers for `const std::string &` and `const char*`. This allows you to terminate your server in response to a fatal error condition by throwing a `std::string` or a string literal. `Application::main` prints the string on `stderr` before returning a non-zero return value.
3. It initializes (by calling `Ice::initialize`) and finalizes (by calling `Communicator::destroy`) a communicator. You can get access to the communicator for your server by calling the static `communicator()` member function.
4. It scans the argument vector for options that are relevant to the Ice run time and removes any such options. The argument vector that is passed to your `run` method therefore is free of Ice-related options and only contains options and arguments that are specific to your application.
5. It provides the name of your application via the static `appName` member function. The return value from this call is `argv[0]`, so you can get at `argv[0]` from anywhere in your code by calling `Ice::Application::appName` (which is often necessary for error messages).
6. It installs a [signal handler](#) that properly destroys the communicator.
7. It installs a [per-process logger](#) if the application has not already configured one. The per-process logger uses the value of the `Ice::ProgramName` property as a prefix for its messages and sends its output to the standard error channel. An application can also specify an [alternate logger](#).

Using `Ice::Application` ensures that your program properly finalizes the Ice run time, whether your server terminates normally or in response to an exception or signal. We recommend that all your programs use this class; doing so makes your life easier. In addition, `Ice::Application` also provides features for signal handling and configuration that you do not have to implement yourself when you use this class.

Using `Ice::Application` on the Client Side

You can use `Ice::Application` for your clients as well: simply implement a class that derives from `Ice::Application` and place the client code into its `run` method. The advantage of this approach is the same as for the server side: `Ice::Application` ensures that the communicator is destroyed correctly even in the presence of exceptions.

Catching Signals in C++

The simple server we developed in [Hello World Application](#) had no way to shut down cleanly: we simply interrupted the server from the command line to force it to exit. Terminating a server in this fashion is unacceptable for many real-life server applications: typically, the server has to perform some cleanup work before terminating, such as flushing database buffers or closing network connections. This is particularly important on receipt of a signal or keyboard interrupt to prevent possible corruption of database files or other persistent data.

To make it easier to deal with signals, `Ice::Application` encapsulates the platform-independent [signal handling capabilities](#) provided by the class `IceUtil::CtrlCHandler`. This allows you to cleanly shut down on receipt of a signal and to use the same source code regardless of the underlying operating system and threading package:

C++

```

namespace Ice {
    class Application : /* ... */ {
    public:
        // ...
        static void destroyOnInterrupt();
        static void shutdownOnInterrupt();
        static void ignoreInterrupt();
        static void callbackOnInterrupt();
        static void holdInterrupt();
        static void releaseInterrupt();
        static bool interrupted();

        virtual void interruptCallback(int);
    };
}

```

You can use `Ice::Application` under both Windows and Unix: for Unix, the member functions control the behavior of your application for `SIGINT`, `SIGHUP`, and `SIGTERM`; for Windows, the member functions control the behavior of your application for `CTRL_C_EVENT`, `CTRL_BREAK_EVENT`, `CTRL_CLOSE_EVENT`, `CTRL_LOGOFF_EVENT`, and `CTRL_SHUTDOWN_EVENT`.

The functions behave as follows:

- `destroyOnInterrupt`
This function creates an `IceUtil::CtrlCHandler` that destroys the communicator when one of the monitored signals is raised. This is the default behavior.
- `shutdownOnInterrupt`
This function creates an `IceUtil::CtrlCHandler` that shuts down the communicator when one of the monitored signals is raised.
- `ignoreInterrupt`
This function causes signals to be ignored.
- `callbackOnInterrupt`
This function configures `Ice::Application` to invoke `interruptCallback` when a signal occurs, thereby giving the subclass responsibility for handling the signal. Note that if the signal handler needs to terminate the program, you must call `_exit` (instead of

exit). This prevents global destructors from running which, depending on the activities of other threads in the program, could cause deadlock or assertion failures.

- `holdInterrupt`
This function causes signals to be held.
- `releaseInterrupt`
This function restores signal delivery to the previous disposition. Any signal that arrives after `holdInterrupt` was called is delivered when you call `releaseInterrupt`.
- `interrupted`
This function returns `true` if a signal caused the communicator to shut down, `false` otherwise. This allows us to distinguish intentional shutdown from a forced shutdown that was caused by a signal. This is useful, for example, for logging purposes.
- `interruptCallback`
A subclass overrides this function to respond to signals. The Ice run time may call this function concurrently with any other thread. If the function raises an exception, the Ice run time prints a warning on `cerr` and ignores the exception.

By default, `Ice::Application` behaves as if `destroyOnInterrupt` was invoked, therefore our server `main` function requires no change to ensure that the program terminates cleanly on receipt of a signal. (You can disable the signal-handling functionality of `Ice::Application` by passing the enumerator `NoSignalHandling` to the constructor. In that case, signals retain their default behavior, that is, terminate the process.) However, we add a diagnostic to report the occurrence of a signal, so our `main` function now looks like:

```

C++



```

#include <Ice/Ice.h>

class MyApplication : virtual public Ice::Application {
public:
 virtual int run(int, char*[]) {

 // Server code here...

 if (interrupted())
 cerr << appName() << ": terminating" << endl;

 return 0;
 }
};

int
main(int argc, char* argv[])
{
 MyApplication app;
 return app.main(argc, argv);
}

```

```

Note that, if your server is interrupted by a signal, the Ice run time waits for all currently executing operations to finish. This means that an operation that updates persistent state cannot be interrupted in the middle of what it was doing and cause partial update problems.

Under Unix, if you handle signals with your own handler (by deriving a subclass from `Ice::Application` and calling `callbackOnInterrupt`), the handler is invoked synchronously from a separate thread. This means that the handler can safely call into the Ice run time or make

system calls that are not async-signal-safe without fear of deadlock or data corruption. Note that `Ice::Application` blocks delivery of `SIGINT`, `SIGHUP`, and `SIGTERM`. If your application calls `exec`, this means that the child process will also ignore these signals; if you need the default behavior of these signals in the `exec'd` process, you must explicitly reset them to `SIG_DFL` before calling `exec`.

Ice::Application and Properties

Apart from the functionality shown in this section, `Ice::Application` also takes care of initializing the Ice run time with property values. [Properties](#) allow you to configure the run time in various ways. For example, you can use properties to control things such as the thread pool size or port number for a server.

Limitations of Ice::Application

`Ice::Application` is a singleton class that creates a single communicator. If you are using multiple communicators, you cannot use `Ice::Application`. Instead, you must structure your code as we saw in [Hello World Application](#) (taking care to always destroy the communicators).

The Ice::Service Class

The `Ice::Application` class is very convenient for general use by Ice client and server applications. In some cases, however, an application may need to run at the system level as a Unix daemon or Windows service. For these situations, Ice includes `Ice::Service`, a singleton class that is comparable to `Ice::Application` but also encapsulates the low-level, platform-specific initialization and shutdown procedures common to system services. The `Ice::Service` class is defined as follows:

```

C++

namespace Ice {
    class Service {
    public:
        Service();

        virtual bool shutdown();
        virtual void interrupt();

        int main(int& argc, char* argv[],
                const Ice::InitializationData& =
Ice::InitializationData());
        int main(Ice::StringSeq& args,
                const Ice::InitializationData& =
Ice::InitializationData());

        Ice::CommunicatorPtr communicator() const;

        static Service* instance();

        bool service() const;
        std::string name() const;
        bool checkSystem() const;

        int run(int& argc, char* argv[],
const Ice::InitializationData&);

#ifdef _WIN32
```

```
    int main(int& argc, wchar_t* argv[], const InitializationData& =
InitializationData());

    void configureService(const std::string& name);
#else
    void configureDaemon(bool changeDir, bool closeFiles,
const std::string& pidFile);
#endif

    virtual void handleInterrupt(int);

protected:
    virtual bool start(int argc, char* argv[], int& status) = 0;
    virtual void waitForShutdown();
    virtual bool stop();
    virtual Ice::CommunicatorPtr initializeCommunicator(
        int& argc, char* argv[],
        const Ice::InitializationData&);

    virtual void syserror(const std::string& msg);
    virtual void error(const std::string& msg);
    virtual void warning(const std::string& msg);
    virtual void trace(const std::string& msg);
    virtual void print(const std::string& msg);

    void enableInterrupt();
    void disableInterrupt();

    // ...
```

```

    };
}

```

At a minimum, an Ice application that uses the `Ice::Service` class must define a subclass and override the `start` member function, which is where the service must perform its startup activities, such as processing command-line arguments, creating an object adapter, and registering servants. The application's `main` function must instantiate the subclass and typically invokes its `main` member function, passing the program's argument vector as parameters. The example below illustrates a minimal `Ice::Service` subclass:

C++

```

#include <Ice/Service.h>

class MyService : public Ice::Service {
protected:
    virtual bool start(int, char*[], int&);
private:
    Ice::ObjectAdapterPtr _adapter;
};

bool
MyService::start(int argc, char* argv[], int& status)
{
    _adapter = communicator()->createObjectAdapter("MyAdapter");
    _adapter->addWithUUID(new MyServantI);
    _adapter->activate();
    status = EXIT_SUCCESS;
    return true;
}

int
main(int argc, char* argv[])
{
    MyService svc;
    return svc.main(argc, argv);
}

```

The `Service::main` member function performs the following sequence of tasks:

1. Scans the argument vector for reserved options that indicate whether the program should run as a system service and removes these options from the argument vector (`argc` is adjusted accordingly). Additional reserved options are supported for administrative tasks.
2. Configures the program for running as a system service (if necessary) by invoking `configureService` or `configureDaemon`, as appropriate for the platform.
3. Invokes the `run` member function and returns its result.

Note that, as for `Application::main`, `Service::main` is overloaded to accept a string sequence instead of an `argc/argv` pair. This is useful if you need to [parse application-specific property settings](#) on the command line.



For maximum portability, we strongly recommend that all initialization tasks be performed in the `start` member function and not in the global `main` function. For example, allocating resources in `main` can cause program instability for [Unix daemons](#).

The `Service::run` member function executes the service in the steps shown below:

1. Installs a [signal handler](#).
2. Invokes the `initializeCommunicator` member function to obtain a communicator. The communicator instance can be accessed using the `communicator` member function.
3. Invokes the `start` member function. If `start` returns `false` to indicate failure, `run` destroys the communicator and returns immediately using the exit status provided in `status`.
4. Invokes the `waitForShutdown` member function, which should block until `shutdown` is invoked.
5. Invokes the `stop` member function. If `stop` returns `true`, `run` considers the application to have terminated successfully.
6. Destroys the communicator.
7. Gracefully terminates the system service (if necessary).

If an unhandled exception is caught by `Service::run`, a descriptive message is logged, the communicator is destroyed and the service is terminated.

Ice::Service Member Functions

The virtual member functions in `Ice::Service` represent the points at which a subclass can intercept the service activities. All of the virtual member functions (except `start`) have default implementations.

- `void handleInterrupt(int sig)`
Invoked by the `CtrlCHandler` when a signal occurs. The default implementation ignores the signal if it represents a logoff event and the `Ice.Nohup` property is set to a value larger than zero, otherwise it invokes the `interrupt` member function.
- `Ice::CommunicatorPtr initializeCommunicator(int & argc, char * argv[], const Ice::InitializationData & data)`
Initializes a communicator. The default implementation invokes `Ice::initialize` and passes the given arguments.
- `void interrupt()`
Invoked by the signal handler to indicate a signal was received. The default implementation invokes the `shutdown` member function.
- `bool shutdown()`
Causes the service to begin the shutdown process. The default implementation invokes `shutdown` on the communicator. The subclass must return `true` if shutdown was started successfully, and `false` otherwise.
- `bool start(int argc, char * argv[], int & status)`
Allows the subclass to perform its startup activities, such as scanning the provided argument vector for recognized command-line options, creating an object adapter, and registering servants. The subclass must return `true` if startup was successful, and `false` otherwise. The subclass can set an exit status via the `status` parameter. This status is returned by `main`.
- `bool stop()`
Allows the subclass to clean up prior to termination. The default implementation does nothing but return `true`. The subclass must return `true` if the service has stopped successfully, and `false` otherwise.
- `void syserror(const std::string & msg)`
`void error(const std::string & msg)`
`void warning(const std::string & msg)`
`void trace(const std::string & msg)`
`void print(const std::string & msg)`
Convenience functions for logging messages to the communicator's [logger](#). The `syserror` member function includes a description of the system's current error code. You can also log messages to these functions using utility classes similar to the [C++ Logger Utility Classes](#): these classes are `ServiceSysError`, `ServiceError`, `ServiceWarning`, `ServiceTrace` and `ServicePrint`, all nested in the `Service` class.
- `void waitForShutdown()`
Waits indefinitely for the service to shut down. The default implementation invokes `waitForShutdown` on the communicator.

The non-virtual member functions shown in the class definition are described below:

- `bool checkSystem() const`
Returns true if the operating system supports Windows services or Unix daemons. This function returns false on Windows 95/98/ME.
- `Ice::CommunicatorPtr communicator() const`
Returns the communicator used by the service, as created by `initializeCommunicator`.
- `void configureDaemon(bool chdir, bool close, const std::string & pidFile)`
Configures the program to run as a Unix daemon. The `chdir` parameter determines whether the daemon changes its working directory to the root directory. The `close` parameter determines whether the daemon closes unnecessary file descriptors (i.e., `stdin`, `stdout`, etc.). If a non-empty string is provided in the `pidFile` parameter, the daemon writes its process ID to the given file.
- `void configureService(const std::string & name)`
Configures the program to run as a Windows service with the given name.
- `void disableInterrupt()`
Disables the signal handling behavior in `Ice::Service`. When disabled, signals are ignored.
- `void enableInterrupt()`
Enables the signal handling behavior in `Ice::Service`. When enabled, the occurrence of a signal causes the `handleInterrupt` member function to be invoked.
- `static Service * instance()`
Returns the singleton `Ice::Service` instance.
- `int main(int & argc, char * argv[],
const Ice::InitializationData & data = Ice::InitializationData())
int main(Ice::StringSeq& args,
const Ice::InitializationData& = Ice::InitializationData());
int main(int & argc, wchar_t * argv[],
const Ice::InitializationData & data = Ice::InitializationData())`
The primary entry point of the `Ice::Service` class. The tasks performed by this function are described earlier in this section. The function returns `EXIT_SUCCESS` for success, `EXIT_FAILURE` for failure. For Windows, this function is overloaded to allow you to pass a `wchar_t` argument vector.
- `std::string name() const`
Returns the name of the service. If the program is running as a Windows service, the return value is the Windows service name, otherwise it returns the value of `argv[0]`.
- `int run(int & argc, char * argv[], const Ice::InitializationData & data)`
Alternative entry point for applications that prefer a different style of service configuration. The program must invoke `configureService` (Windows) or `configureDaemon` (Unix) in order to run as a service. The tasks performed by this function were described earlier. The function normally returns `EXIT_SUCCESS` or `EXIT_FAILURE`, but the `start` method can also supply a different value via its `status` argument.
- `bool service() const`
Returns true if the program is running as a Windows service or Unix daemon, or false otherwise.

Unix Daemons

On Unix platforms, passing `--daemon` causes your program to run as a daemon. When this option is present, `Ice::Service` performs the following additional actions:

- Creates a background child process in which `Service::main` performs its tasks. The foreground process does not terminate until the child process has successfully invoked the `start` member function. This behavior avoids the uncertainty often associated with starting a daemon from a shell script by ensuring that the command invocation does not complete until the daemon is ready to

receive requests.

- Changes the current working directory of the child process to the root directory, unless `--nochdir` is specified.
- Closes all file descriptors, unless `--noclose` is specified. The standard input (stdin) channel is closed and reopened to `/dev/null`. Likewise, the standard output (stdout) and standard error (stderr) channels are also closed and reopened to `/dev/null` unless `Ice.StdOut` or `Ice.StdErr` are defined, respectively, in which case those channels use the designated log files.

 The file descriptors are not closed until after the communicator is initialized, meaning standard input, standard output, and standard error are available for use during this time. For example, the IceSSL plug-in may need to prompt for a passphrase on standard input, or Ice may print the child's process id on standard output if the property `Ice.PrintProcessId` is set.

The following additional command-line options can be specified in conjunction with the `--daemon` option:

- `--pidfile FILE`
This option writes the process ID of the service into the specified `FILE`.
- `--noclose`
Prevents `Ice::Service` from closing unnecessary file descriptors. This can be useful during debugging and diagnosis because it provides access to the output from the daemon's standard output and standard error.
- `--nochdir`
Prevents `Ice::Service` from changing the current working directory.

All of these options are removed from the argument vector that is passed to the `start` member function.

 We strongly recommend that you perform all initialization tasks in your service's `start` member function, and not in the global `main` function. This is especially important for process-specific resources such as file descriptors, threads, and mutexes, which can be affected by the use of the `fork` system call in `Ice::Service`. For example, any files opened in `main` are automatically closed by `Ice::Service` and therefore unusable in your service, unless the daemon is started with the `--noclose` option.

Windows Services

On Windows, `Ice::Service` recognizes the following command-line options:

- `--service NAME`
Run as a Windows service named `NAME`, which must already be installed. This option is removed from the argument vector that is passed to the `start` member function.

Installing and configuring a Windows service is outside the scope of the `Ice::Service` class. Ice includes a [utility](#) for installing its services which you can use as a model for your own applications.

The `Ice::Service` class supports the Windows service control codes `SERVICE_CONTROL_INTERROGATE` and `SERVICE_CONTROL_STOP`. Upon receipt of `SERVICE_CONTROL_STOP`, `Ice::Service` invokes the `shutdown` member function.

Ice::Service Logging Considerations

A service that uses a [custom logger](#) has several ways of configuring it:

- as a [process-wide logger](#),
- in the `InitializationData` argument that is passed to `main`,
- by overriding the `initializeCommunicator` member function.

On Windows, `Ice::Service` installs its own logger that uses the Windows `Application` event log if no custom logger is defined. The source name for the event log is the service's name unless a different value is specified using the property `Ice.EventLog.Source`.

On Unix, the default Ice logger (which logs to the standard error output) is used when no other logger is configured. For daemons, this is not appropriate because the output will be lost. To change this, you can either implement a custom logger or set the `Ice.UseSyslog` property,

which selects a logger implementation that logs to the `syslog` facility. Alternatively, you can set the `Ice.LogFile` property to write log messages to a file.

Note that `Ice::Service` may encounter errors before the communicator is initialized. In this situation, `Ice::Service` uses its default logger unless a process-wide logger is configured. Therefore, even if a failing service is configured to use a different logger implementation, you may find useful diagnostic information in the `Application` event log (on Windows) or sent to standard error (on Unix).

See Also

- [Hello World Application](#)
- [Properties and Configuration](#)
- [Communicator Initialization](#)
- [Logger Facility](#)
- [Portable Signal Handling in C++](#)
- [Windows Services](#)

Server-Side C++ Mapping for Interfaces

The server-side mapping for interfaces provides an up-call API for the Ice run time: by implementing virtual functions in a servant class, you provide the hook that gets the thread of control from the Ice server-side run time into your application code.

On this page:

- [Skeleton Classes in C++](#)
- [Servant Classes in C++](#)
 - [Normal and `idempotent` Operations in C++](#)

Skeleton Classes in C++

On the client side, interfaces map to [proxy classes](#). On the server side, interfaces map to *skeleton* classes. A skeleton is a class that has a pure virtual member function for each operation on the corresponding interface. For example, consider our [Slice definition](#) for the `Node` interface:

Slice
<pre> module Filesystem { interface Node { idempotent string name(); }; // ... }; </pre>

The Slice compiler generates the following definition for this interface:

C++
<pre> namespace Filesystem { class Node : virtual public Ice::Object { public: virtual std::string name(const Ice::Current& = Ice::Current()) = 0; // ... }; // ... } </pre>

For the moment, we will ignore a number of other member functions of this class. The important points to note are:

- As for the client side, Slice modules are mapped to C++ namespaces with the same name, so the skeleton class definition is nested in the namespace `Filesystem`.
- The name of the skeleton class is the same as the name of the Slice interface (`Node`).
- The skeleton class contains a pure virtual member function for each operation in the Slice interface.
- The skeleton class is an abstract base class because its member functions are pure virtual.
- The skeleton class inherits from `Ice::Object` (which forms the root of the Ice object hierarchy).

Servant Classes in C++

In order to provide an implementation for an Ice object, you must create a servant class that inherits from the corresponding skeleton class. For example, to create a servant for the `Node` interface, you could write:

```
C++
```

```
#include <Filesystem.h> // Slice-generated header

class NodeI : public virtual Filesystem::Node {
public:
    NodeI(const std::string&);
    virtual std::string name(const Ice::Current&);
private:
    std::string _name;
};
```

By convention, servant classes have the name of their interface with an `I`-suffix, so the servant class for the `Node` interface is called `NodeI`. (This is a convention only: as far as the Ice run time is concerned, you can choose any name you prefer for your servant classes.)

Note that `NodeI` inherits from `Filesystem::Node`, that is, it derives from its skeleton class. It is a good idea to always use virtual inheritance when defining servant classes. Strictly speaking, virtual inheritance is necessary only for servants that implement interfaces that use multiple inheritance; however, the `virtual` keyword does no harm and, if you add multiple inheritance to an interface hierarchy half-way through development, you do not have to go back and add a `virtual` keyword to all your servant classes.

As far as Ice is concerned, the `NodeI` class must implement only a single member function: the pure virtual `name` function that it inherits from its skeleton. This makes the servant class a concrete class that can be instantiated. You can add other member functions and data members as you see fit to support your implementation. For example, in the preceding definition, we added a `_name` member and a constructor. Obviously, the constructor initializes the `_name` member and the `name` function returns its value:

```
C++
```

```
NodeI::NodeI(const std::string& name) : _name(name)
{
}

std::string
NodeI::name(const Ice::Current&) const
{
    return _name;
}
```

Normal and idempotent Operations in C++

The `name` member function of the `NodeI` skeleton is not a `const` member function. However, given that the operation does not modify the state of its object, it really should be a `const` member function. We can achieve this by adding the `["cpp:const "]` metadata directive. For example:

Slice

```
interface Example {
    void normalOp();

    idempotent void idempotentOp();

    ["cpp:const"]
    idempotent void readonlyOp();
};
```

The skeleton class for this interface looks like this:

C++

```
class Example : virtual public Ice::Object {
public:
    virtual void normalOp(const Ice::Current& = Ice::Current()) = 0;
    virtual void idempotentOp(const Ice::Current& = Ice::Current()) = 0;
    virtual void readonlyOp(const Ice::Current&
= Ice::Current()) const = 0;
    // ...
};
```

Note that `readonlyOp` is mapped as a `const` member function due to the `["cpp:const"]` metadata directive; `normal` and `idempotent` operations (without the metadata directive) are mapped as ordinary, non-`const` member functions.

See Also

- [Slice for a Simple File System](#)
- [C++ Mapping for Interfaces](#)
- [Parameter Passing in C++](#)
- [Raising Exceptions in C++](#)

Parameter Passing in C++

For each parameter of a Slice operation, the C++ mapping generates a corresponding parameter for the virtual member function in the skeleton. In addition, every operation has a trailing parameter of type `Ice::Current`. For example, the `name` operation of the `Node` interface has no parameters, but the `name` member function of the `Node` skeleton class has a single parameter of type `Ice::Current`. We will ignore this parameter for now.

Parameter passing on the server side follows the rules for the [client side](#):

- in-parameters are passed by value or `const` reference
- out-parameters are passed by reference
- return values are passed by value
- optional parameters are enclosed in `IceUtil::Optional` values

To illustrate the rules, consider the following interface that passes string parameters in all possible directions:

```

Slice
module M {
    interface Example {
        string op(string sin, out string sout);
    };
};

```

The generated skeleton class for this interface looks as follows:

```

C++
namespace M {
    class Example : virtual public ::Ice::Object {
    public:
        virtual std::string op(const std::string&, std::string&,
const Ice::Current& = Ice::Current()) = 0;
        // ...
    };
}

```

As you can see, there are no surprises here. For example, we could implement `op` as follows:

```

C++
std::string
ExampleI::op(const std::string& sin, std::string& sout,
const Ice::Current&)
{
    cout << sin << endl;           // In parameters are initialized
    sout = "Hello World!";        // Assign out parameter
    return "Done";                // Return a string
}

```

This code is in no way different from what you would normally write if you were to pass strings to and from a function; the fact that remote procedure calls are involved does not impact on your code in any way. The same is true for parameters of other types, such as proxies, classes, or dictionaries: the parameter passing conventions follow normal C++ rules and do not require special-purpose API calls or memory management.

See Also

- [Server-Side C++ Mapping for Interfaces](#)
- [C++ Mapping for Operations](#)
- [C++ Mapping for Optional Values](#)
- [Raising Exceptions in C++](#)
- [The Current Object](#)

Raising Exceptions in C++

To throw an exception from an operation implementation, you simply instantiate the exception, initialize it, and throw it. For example:

```

C++

void
Filesystem::FileI::write(const Filesystem::Lines& text,
const Ice::Current&)
{
    // Try to write the file contents here...
    // Assume we are out of space...
    if (error) {
        Filesystem::GenericError e;
        e.reason = "file too large";
        throw e;
    }
};

```

No memory management issues arise in the presence of exceptions.

Note that the Slice compiler never generates exception specifications for operations, regardless of whether the corresponding Slice operation definition has an exception specification or not. This is deliberate: C++ exception specifications do not add any value and are therefore not used by the Ice C++ mapping [1].

If you throw an arbitrary C++ exception (such as an `int` or other unexpected type), the Ice run time catches the exception and then returns an `UnknownException` to the client. Similarly, if you throw an "impossible" user exception (a user exception that is not listed in the exception specification of the operation), the client receives an `UnknownUserException`.

If you throw a run-time exception, such as `MemoryLimitException`, the client receives an `UnknownLocalException`. For that reason, you should never throw system exceptions from operation implementations. If you do, all the client will see is an `UnknownLocalException`, which does not tell the client anything useful.

 Three run-time exceptions are treated specially and not changed to `UnknownLocalException` when returned to the client: `ObjectNotExistException`, `OperationNotExistException`, and `FacetNotExistException`.

See Also

- [Run-Time Exceptions](#)
- [C++ Mapping for Exceptions](#)
- [Server-Side C++ Mapping for Interfaces](#)
- [Parameter Passing in C++](#)

References

1. Sutter, H. 2002. [A Pragmatic Look at Exception Specifications](#). *C/C++ Users Journal* 20 (7): 59-64.

Object Incarnation in C++

Having created a servant class such as the rudimentary `NodeI` class, you can instantiate the class to create a concrete servant that can receive invocations from a client. However, merely instantiating a servant class is insufficient to incarnate an object. Specifically, to provide an implementation of an Ice object, you must follow the following steps:

1. [Instantiate a servant class.](#)
2. [Create an identity](#) for the Ice object incarnated by the servant.
3. Inform the Ice run time of the existence of the servant.
4. [Pass a proxy for the object](#) to a client so the client can reach it.

On this page:

- [Instantiating a C++ Servant](#)
- [Creating an Identity in C++](#)
- [Activating a C++ Servant](#)
 - [Servant Life Time and Reference Counts](#)
- [UUIDs as Identities in C++](#)
- [Creating Proxies in C++](#)
 - [Proxies and Servant Activation in C++](#)
 - [Direct Proxy Creation in C++](#)

Instantiating a C++ Servant

Instantiating a servant means to allocate an instance on the heap:

```
C++  
NodePtr servant = new NodeI("Fred");
```

This code creates a new `NodeI` instance [on the heap](#) and assigns its address to a smart pointer of type `NodePtr`. This works because `NodeI` is derived from `Node`, so a smart pointer of type `NodePtr` can also look after an instance of type `NodeI`. However, if we want to invoke a member function of the derived `NodeI` class at this point, we have a problem: we cannot access member functions of the derived `NodeI` class through a `NodePtr` smart pointer, only member functions of `Node` base class. (The C++ type rules prevent us from accessing a member of a derived class through a pointer to a base class.) To get around this, we can modify the code as follows:

```
C++  
typedef IceUtil::Handle<NodeI> NodeIPtr;  
NodeIPtr servant = new NodeI("Fred");
```

This code makes use of the [smart pointer template](#) by defining `NodeIPtr` as a smart pointer to `NodeI` instances. Whether you use a smart pointer of type `NodePtr` or `NodeIPtr` depends solely on whether you want to invoke a member function of the `NodeI` derived class; if you only want to invoke member functions that are defined in the `Node` skeleton base class, it is sufficient to use a `NodePtr` and you need not define the `NodeIPtr` type.

Whether you use `NodePtr` or `NodeIPtr`, the advantages of using a smart pointer class should be obvious from the [smart pointer discussion](#): they make it impossible to accidentally leak memory.

Creating an Identity in C++

Each Ice object requires an identity. That identity must be unique for all servants using the same object adapter.



The Ice object model assumes that all objects (regardless of their adapter) have a [globally unique identity](#).

An Ice object identity is a structure with the following Slice definition:

```

Slice
module Ice {
    struct Identity {
        string name;
        string category;
    };
    // ...
};

```

The full identity of an object is the combination of both the `name` and `category` fields of the `Identity` structure. For now, we will leave the `category` field as the empty string and simply use the `name` field. (The `category` field is most often used in conjunction with [servant locators](#).)

To create an identity, we simply assign a key that identifies the servant to the `name` field of the `Identity` structure:

```

C++
Ice::Identity id;
id.name = "Fred"; // Not unique, but good enough for now

```

Activating a C++ Servant

Merely creating a servant instance does nothing: the Ice run time becomes aware of the existence of a servant only once you explicitly tell the object adapter about the servant. To activate a servant, you invoke the `add` operation on the object adapter. Assuming that we have access to the object adapter in the `_adapter` variable, we can write:

```

C++
_adapter->add(servant, id);

```

Note the two arguments to `add`: the smart pointer to the servant and the object identity. Calling `add` on the object adapter adds the servant pointer and the servant's identity to the adapter's servant map and links the proxy for an Ice object to the correct servant instance in the server's memory as follows:

1. The proxy for an Ice object, apart from addressing information, contains the identity of the Ice object. When a client invokes an operation, the object identity is sent with the request to the server.
2. The object adapter receives the request, retrieves the identity, and uses the identity as an index into the servant map.
3. If a servant with that identity is active, the object adapter retrieves the servant pointer from the servant map and dispatches the incoming request into the correct member function on the servant.

Assuming that the object adapter is in the [active state](#), client requests are dispatched to the servant as soon as you call `add`.

Servant Life Time and Reference Counts

Putting the preceding points together, we can write a simple function that instantiates and activates one of our `NodeI` servants. For this example, we use a simple helper function called `activateServant` that creates and activates a servant with a given identity:

C++

```

void
activateServant(const string& name)
{
    NodePtr servant = new NodeI(name);           // Refcount == 1
    Ice::Identity id;
    id.name = name;
    _adapter->add(servant, id);                 // Refcount == 2
}                                              // Refcount == 1

```

Note that we create the servant on the heap and that, once `activateServant` returns, we lose the last remaining handle to the servant (because the `servant` variable goes out of scope). The question is, what happens to the heap-allocated servant instance? The answer lies in the smart pointer semantics:

- When the new servant is instantiated, its reference count is initialized to 0.
- Assigning the servant's address to the `servant` smart pointer increments the servant's reference count to 1.
- Calling `add` passes the `servant` smart pointer to the object adapter which keeps a copy of the handle internally. This increments the reference count of the servant to 2.
- When `activateServant` returns, the destructor of the `servant` variable decrements the reference count of the servant to 1.

The net effect is that the servant is retained on the heap with a reference count of 1 for as long as the servant is in the servant map of its object adapter. (If we deactivate the servant, that is, remove it from the servant map, the reference count drops to zero and the memory occupied by the servant is reclaimed; we discuss these life cycle issues in [Object Life Cycle](#).)

UUIDs as Identities in C++

The Ice object model assumes that object identities are globally unique. One way of ensuring that uniqueness is to use UUIDs (Universally Unique Identifiers) as identities. The `IceUtil` namespace contains a [helper function](#) to create such identities:

C++

```

#include <IceUtil/UUID.h>
#include <iostream>

using namespace std;

int
main()
{
    cout << IceUtil::generateUUID() << endl;
}

```

When executed, this program prints a unique string such as `5029a22c-e333-4f87-86b1-cd5e0fccc509`. Each call to `generateUUID` creates a string that differs from all previous ones.

You can use a UUID such as this to create object identities. For convenience, the object adapter has an operation `addWithUUID` that generates a UUID and adds a servant to the servant map in a single step. Using this operation, we can rewrite the code shown [earlier](#) like this:

C++

```

void
activateServant(const string& name)
{
    NodePtr servant = new NodeI(name);
    _adapter->addWithUUID(servant);
}

```

Creating Proxies in C++

Once we have activated a servant for an Ice object, the server can process incoming client requests for that object. However, clients can only access the object once they hold a proxy for the object. If a client knows the server's address details and the object identity, it can create a proxy from a string, as we saw in our first example in [Hello World Application](#). However, creation of proxies by the client in this manner is usually only done to allow the client access to initial objects for bootstrapping. Once the client has an initial proxy, it typically obtains further proxies by invoking operations.

The object adapter contains all the details that make up the information in a proxy: the addressing and protocol information, and the object identity. The Ice run time offers a number of ways to create proxies. Once created, you can pass a proxy to the client as the return value or as an out-parameter of an operation invocation.

Proxies and Servant Activation in C++

The `add` and `addWithUUID` servant activation operations on the object adapter return a proxy for the corresponding Ice object. This means we can write:

C++

```

typedef IceUtil::Handle<NodeI> NodeIPtr;
NodeIPtr servant = new NodeI(name);
NodePrx proxy = NodePrx::uncheckedCast(_adapter->addWithUUID(servant));

// Pass proxy to client...

```

Here, `addWithUUID` both activates the servant and returns a proxy for the Ice object incarnated by that servant in a single step.

Note that we need to use an `uncheckedCast` here because `addWithUUID` returns a proxy of type `Ice::ObjectPrx`.

Direct Proxy Creation in C++

The object adapter offers an operation to create a proxy for a given identity:

Slice

```

module Ice {
    local interface ObjectAdapter {
        Object* createProxy(Identity id);
        // ...
    };
};

```

Note that `createProxy` creates a proxy for a given identity whether a servant is activated with that identity or not. In other words, proxies have a life cycle that is quite independent from the life cycle of servants:

C++

```

Ice::Identity id;
id.name = IceUtil::generateUUID();
ObjectPrx o = _adapter->createProxy(id);

```

This creates a proxy for an Ice object with the identity returned by `generateUUID`. Obviously, no servant yet exists for that object so, if we return the proxy to a client and the client invokes an operation on the proxy, the client will receive an `ObjectNotExistException`. (We examine these life cycle issues in more detail in [Object Life Cycle](#).)

See Also

- [Hello World Application](#)
- [Object Adapter States](#)
- [Servant Locators](#)
- [Object Life Cycle](#)
- [The C++ generateUUID Function](#)

Asynchronous Method Dispatch (AMD) in C++

The number of simultaneous synchronous requests a server is capable of supporting is determined by the number of threads in the server's [thread pool](#). If all of the threads are busy dispatching long-running operations, then no threads are available to process new requests and therefore clients may experience an unacceptable lack of responsiveness.

Asynchronous Method Dispatch (AMD), the server-side equivalent of [AMI](#), addresses this scalability issue. Using AMD, a server can receive a request but then suspend its processing in order to release the dispatch thread as soon as possible. When processing resumes and the results are available, the server sends a response explicitly using a callback object provided by the Ice run time.

AMD is transparent to the client, that is, there is no way for a client to distinguish a request that, in the server, is processed synchronously from a request that is processed asynchronously.

In practical terms, an AMD operation typically queues the request data (i.e., the callback object and operation arguments) for later processing by an application thread (or thread pool). In this way, the server minimizes the use of dispatch threads and becomes capable of efficiently supporting thousands of simultaneous clients.

An alternate use case for AMD is an operation that requires further processing after completing the client's request. In order to minimize the client's delay, the operation returns the results while still in the dispatch thread, and then continues using the dispatch thread for additional work.

On this page:

- [Enabling AMD with Metadata in C++](#)
- [AMD Mapping in C++](#)
- [AMD Exceptions in C++](#)
- [AMD Example in C++](#)

Enabling AMD with Metadata in C++

To enable asynchronous dispatch, you must add an ["amd"] metadata directive to your Slice definitions. The directive applies at the interface and the operation level. If you specify ["amd"] at the interface level, all operations in that interface use asynchronous dispatch; if you specify ["amd"] for an individual operation, only that operation uses asynchronous dispatch. In either case, the metadata directive *replaces* synchronous dispatch, that is, a particular operation implementation must use synchronous or asynchronous dispatch and cannot use both.

Consider the following Slice definitions:

Slice
<pre> ["amd"] interface I { bool isValid(); float computeRate(); }; interface J { ["amd"] void startProcess(); int endProcess(); }; </pre>

In this example, both operations of interface `I` use asynchronous dispatch, whereas, for interface `J`, `startProcess` uses asynchronous dispatch and `endProcess` uses synchronous dispatch.

Specifying metadata at the operation level (rather than at the interface or class level) minimizes the amount of generated code and, more importantly, minimizes complexity: although the asynchronous model is more flexible, it is also more complicated to use. It is therefore in your best interest to limit the use of the asynchronous model to those operations that need it, while using the simpler synchronous model for the rest.

AMD Mapping in C++

The C++ mapping emits the following code for each AMD operation:

1. A callback class used by the implementation to notify the Ice run time about the completion of an operation. The name of this class is formed using the pattern `AMD_class_op`. For example, an operation named `foo` defined in interface `I` results in a class named `AMD_I_foo`. The class is generated in the same scope as the interface or class containing the operation. Several methods are provided:

This page contains macros or features from a plugin which requires a valid license.

You will need to:

- a. Install the [Plugin Licensing Manager](#).
- b. Visit the [Plugin Licensing Manager](#) and acquire the necessary licenses.

[Licensing Help?](#)

The Adaptavist Content Formatting Macros plugin requires a license.

This page contains macros or features from a plugin which requires a valid license.

You will need to:

- a. Install the [Plugin Licensing Manager](#).
- b. Visit the [Plugin Licensing Manager](#) and acquire the necessary licenses.

[Licensing Help?](#)

The Adaptavist Content Formatting Macros plugin requires a license.

- `void ice_response(<params>);`

The `ice_response` method allows the server to report the successful completion of the operation. If the operation has a non-void return type, the first parameter to `ice_response` is the return value. Parameters corresponding to the operation's `out` parameters follow the return value, in the order of declaration.

This page contains macros or features from a plugin which requires a valid license.

You will need to:

- a. Install the [Plugin Licensing Manager](#).
- b. Visit the [Plugin Licensing Manager](#) and acquire the necessary licenses.

[Licensing Help?](#)

The Adaptavist Content Formatting Macros plugin requires a license.

- `void ice_exception(const std::exception &);`

This version of `ice_exception` allows the server to raise any standard exception, Ice run-time exception, or Ice user exception.

This page contains macros or features from a plugin which requires a valid license.

You will need to:

- a. Install the [Plugin Licensing Manager](#).
- b. Visit the [Plugin Licensing Manager](#) and acquire the necessary licenses.

[Licensing Help?](#)

The Adaptavist Content Formatting Macros plugin requires a license.

- `void ice_exception();`

This version of `ice_exception` allows the server to report an `UnknownException`.

Neither `ice_response` nor `ice_exception` throw any exceptions to the caller.

2. The dispatch method, whose name has the suffix `_async`. This method has a `void` return type. The first parameter is a smart pointer to an instance of the callback class described above. The remaining parameters comprise the in-parameters of the operation, in the order of declaration.

For example, suppose we have defined the following operation:

```
Slice
```

```
interface I {
    ["amd"] int foo(short s, out long l);
};
```

The callback class generated for operation `foo` is shown below:

```
C++
```

```
class AMD_I_foo : public ... {
public:
    void ice_response(Ice::Int, Ice::Long);
    void ice_exception(const std::exception&);
    void ice_exception();
};
```

The dispatch method for asynchronous invocation of operation `foo` is generated as follows:

```
C++
```

```
void foo_async(const AMD_I_fooPtr&, Ice::Short);
```

AMD Exceptions in C++

There are two processing contexts in which the logical implementation of an AMD operation may need to report an exception: the dispatch thread (the thread that receives the invocation), and the response thread (the thread that sends the response).

 These are not necessarily two different threads: it is legal to send the response from the dispatch thread.

Although we recommend that the callback object be used to report all exceptions to the client, it is legal for the implementation to raise an exception instead, but only from the dispatch thread.

As you would expect, an exception raised from a response thread cannot be caught by the Ice run time; the application's run-time environment determines how such an exception is handled. Therefore, a response thread must ensure that it traps all exceptions and sends the appropriate response using the callback object. Otherwise, if a response thread is terminated by an uncaught exception, the request may never be completed and the client might wait indefinitely for a response.

Whether raised in a dispatch thread or reported via the callback object, user exceptions are [validated](#) and local exceptions may undergo [translation](#).

AMD Example in C++

To demonstrate the use of AMD in Ice, let us define the Slice interface for a simple computational engine:

Slice

```

module Demo {
    sequence<float> Row;
    sequence<Row> Grid;

    exception RangeError {};

    interface Model {
        ["amd"] Grid interpolate(Grid data, float factor)
            throws RangeError;
    };
};

```

Given a two-dimensional grid of floating point values and a factor, the `interpolate` operation returns a new grid of the same size with the values interpolated in some interesting (but unspecified) way.

Our servant class derives from `Demo::Model` and supplies a definition for the `interpolate_async` method:

C++

```

class ModelI : virtual public Demo::Model,
virtual public IceUtil::Mutex {
public:
    virtual void interpolate_async(
        const Demo::AMD_Model_interpolatePtr&,
        const Demo::Grid&,
        Ice::Float,
        const Ice::Current&);

private:
    std::list<JobPtr> _jobs;
};

```

The implementation of `interpolate_async` uses synchronization to safely record the callback object and arguments in a `Job` that is added to a queue:

C++

```

void ModelI::interpolate_async(
    const Demo::AMD_Model_interpolatePtr& cb,
    const Demo::Grid& data,
    Ice::Float factor,
    const Ice::Current& current)
{
    IceUtil::Mutex::Lock sync(*this);
    JobPtr job = new Job(cb, data, factor);
    _jobs.push_back(job);
}

```

After queuing the information, the operation returns control to the Ice run time, making the dispatch thread available to process another request. An application thread removes the next `Job` from the queue and invokes `execute` to perform the interpolation. `Job` is defined as follows:

C++

```

class Job : public IceUtil::Shared {
public:
    Job(const Demo::AMD_Model_interpolatePtr&, const Demo::Grid&,
        Ice::Float);
    void execute();

private:
    bool interpolateGrid();

    Demo::AMD_Model_interpolatePtr _cb;
    Demo::Grid _grid;
    Ice::Float _factor;
};
typedef IceUtil::Handle<Job> JobPtr;

```

The implementation of `execute` uses `interpolateGrid` (not shown) to perform the computational work:

C++

```

Job::Job(const Demo::AMD_Model_interpolatePtr& cb,
const Demo::Grid& grid, Ice::Float factor) :
    _cb(cb), _grid(grid), _factor(factor)
{
}

void Job::execute()
{
    if (!interpolateGrid()) {
        _cb->ice_exception(Demo::RangeError());
        return;
    }
    _cb->ice_response(_grid);
}

```

If `interpolateGrid` returns false, then `ice_exception` is invoked to indicate that a range error has occurred. The `return` statement following the call to `ice_exception` is necessary because `ice_exception` does not throw an exception; it only marshals the exception argument and sends it to the client.

If interpolation was successful, `ice_response` is called to send the modified grid back to the client.

See Also

- [Asynchronous Method Invocation \(AMI\) in C++](#)
- [The Ice Threading Model](#)
- [User Exceptions](#)
- [Run-Time Exceptions](#)

Example of a File System Server in C++

This page presents the source code for a C++ server that implements our [file system](#) and communicates with the [client](#) we wrote earlier. The code is fully functional, apart from the required [interlocking for threads](#).

The server is remarkably free of code that relates to distribution: most of the server code is simply application logic that would be present just the same for a non-distributed version. Again, this is one of the major advantages of Ice: distribution concerns are kept away from application code so that you can concentrate on developing application logic instead of networking infrastructure.

i The server code shown here is not quite correct as it stands: if two clients access the same file in parallel, each via a different thread, one thread may read the `_lines` data member while another thread updates it. Obviously, if that happens, we may write or return garbage or, worse, crash the server. However, it is trivial to make the `read` and `write` operations thread-safe: a single data member and two lines of source code are sufficient to achieve this. We discuss how to write thread-safe servant implementations in [Threads and Concurrency with C++](#).

On this page:

- [Implementing a File System Server in C++](#)
- [Server main Program in C++](#)
- [Servant Class Definitions in C++](#)
- [The Servant Implementation in C++](#)
 - [Implementing FileI](#)
 - [Implementing DirectoryI](#)
 - [Implementing NodeI](#)

Implementing a File System Server in C++

We have now seen enough of the server-side C++ mapping to implement a server for our [file system](#). (You may find it useful to review these [Slice definitions](#) before studying the source code.)

Our server is composed of two source files:

- `Server.cpp`
This file contains the server main program.
- `FilesystemI.cpp`
This file contains the implementation for the file system servants.

Server main Program in C++

Our server main program, in the file `Server.cpp`, uses the `Ice::Application` class. The `run` method installs a signal handler, creates an object adapter, instantiates a few servants for the directories and files in the file system, and then activates the adapter. This leads to a `main` program as follows:

```

C++
#include <Ice/Ice.h>
#include <FilesystemI.h>

using namespace std;
using namespace Filesystem;

class FilesystemApp : virtual public Ice::Application {
public:
    virtual int run(int, char*[]) {
        // Terminate cleanly on receipt of a signal

```

```

//
shutdownOnInterrupt();

// Create an object adapter.
//
Ice::ObjectAdapterPtr adapter =
communicator()->createObjectAdapterWithEndpoints(
    "SimpleFilesystem", "default -p 10000");

// Create the root directory (with name "/" and no parent)
//
DirectoryIPtr root = new DirectoryI(communicator(), "/", 0);
root->activate(adapter);

// Create a file called "README" in the root directory
//
FileIPtr file = new FileI(communicator(), "README", root);
Lines text;
text.push_back("This file system contains a collection of poetr
y.");
file->write(text);
file->activate(adapter);

// Create a directory called "Coleridge"
// in the root directory
//
DirectoryIPtr coleridge =
new DirectoryI(communicator(), "Coleridge", root);
coleridge->activate(adapter);

// Create a file called "Kubla_Khan"
// in the Coleridge directory
//
file = new FileI(communicator(), "Kubla_Khan", coleridge);
text.erase(text.begin(), text.end());
text.push_back("In Xanadu did Kubla Khan");
text.push_back("A stately pleasure-dome decree:");
text.push_back("Where Alph, the sacred river, ran");
text.push_back("Through caverns measureless to man");
text.push_back("Down to a sunless sea.");
file->write(text);
file->activate(adapter);

// All objects are created, allow client requests now
//
adapter->activate();

// Wait until we are done
//
communicator()->waitForShutdown();

```

```
        if (interrupted()) {
            cerr << appName()
<< ": received signal, shutting down" << endl;
        }

        return 0;
    };
};

int
main(int argc, char* argv[])
{
    FilesystemApp app;
```

```

    return app.main(argc, argv);
}

```

There is quite a bit of code here, so let us examine each section in detail:

C++

```

#include <FileSystemI.h>
#include <Ice/Application.h>

using namespace std;
using namespace FileSystem;

```

The code includes the header file `FileSystemI.h`. That file includes `Ice/Ice.h` as well as the header file that is generated by the Slice compiler, `FileSystem.h`. Because we are using `Ice::Application`, we need to include `Ice/Application.h` as well.

Two `using` declarations, for the namespaces `std` and `FileSystem`, permit us to be a little less verbose in the source code.

The next part of the source code is the definition of `FileSystemApp`, which derives from `Ice::Application` and contains the main application logic in its `run` method:

C++

```

class FileSystemApp : virtual public Ice::Application {
public:
    virtual int run(int, char*[]) {
        // Terminate cleanly on receipt of a signal
        //
        shutdownOnInterrupt();

        // Create an object adapter.
        //
        Ice::ObjectAdapterPtr adapter =
communicator()->createObjectAdapterWithEndpoints(
        "SimpleFileSystem", "default -p 10000");

        // Create the root directory (with name "/" and no parent)
        //
        DirectoryIPtr root = new DirectoryI(communicator(), "/", 0);
        root->activate(adapter);

        // Create a file called "README" in the root directory
        //
        FileIPtr file = new FileI(communicator(), "README", root);
        Lines text;
        text.push_back("This file system contains a collection of poetr
y.");
        file->write(text);
        file->activate(adapter);
    }
};

```

```
// Create a directory called "Coleridge"
// in the root directory
//
DirectoryIPtr coleridge =
new DirectoryI(communicator(), "Coleridge", root);
    coleridge->activate(adapter);

// Create a file called "Kubla_Khan"
// in the Coleridge directory
//
file = new FileI(communicator(), "Kubla_Khan", coleridge);
text.erase(text.begin(), text.end());
text.push_back("In Xanadu did Kubla Khan");
text.push_back("A stately pleasure-dome decree:");
text.push_back("Where Alph, the sacred river, ran");
text.push_back("Through caverns measureless to man");
text.push_back("Down to a sunless sea.");
file->write(text);
file->activate(adapter);

// All objects are created, allow client requests now
//
adapter->activate();

// Wait until we are done
//
communicator()->waitForShutdown();
if (interrupted()) {
    cerr << appName()
<< ": received signal, shutting down" << endl;
}

return 0;
```

```
};
};
```

Much of this code is boiler plate that we saw previously: we create an object adapter, and, towards the end, activate the object adapter and call `waitForShutdown`.

The interesting part of the code follows the adapter creation: here, the server instantiates a few nodes for our file system to create the structure shown below:

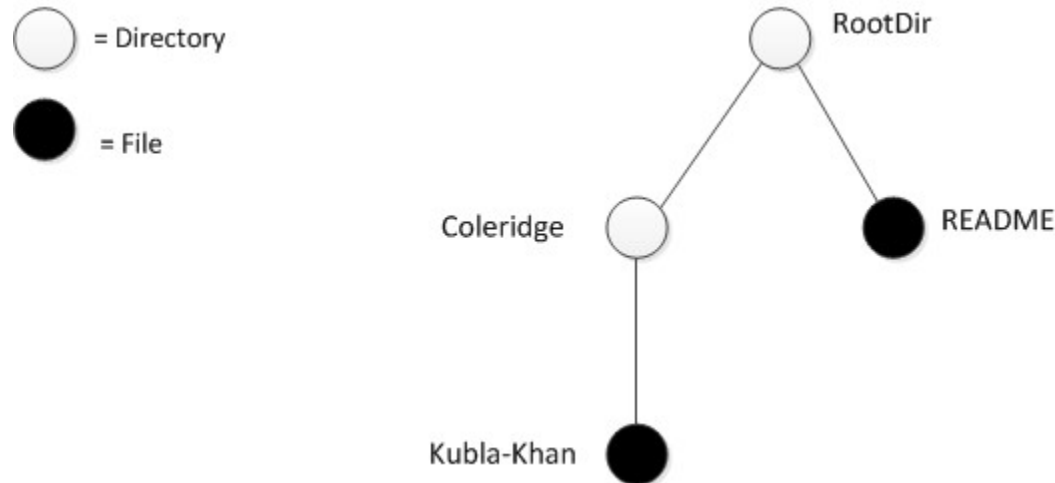

A small file system.

As we will see shortly, the servants for our directories and files are of type `DirectoryI` and `FileI`, respectively. The constructor for either type of servant accepts three parameters: the communicator, the name of the directory or file to be created, and a handle to the servant for the parent directory. (For the root directory, which has no parent, we pass a null parent handle.) Thus, the statement

```
C++
DirectoryIPtr root = new DirectoryI(communicator(), "/", 0);
```

creates the root directory, with the name `"/"` and no parent directory. Note that we use the [smart pointer class](#) to hold the return value from `new`; that way, we avoid any memory management issues. The types `DirectoryIPtr` and `FileIPtr` are defined as follows in a header file `FilesystemI.h`:

```
C++
typedef IceUtil::Handle<DirectoryI> DirectoryIPtr;
typedef IceUtil::Handle<FileI> FileIPtr;
```

Here is the code that establishes the structure in the illustration above.

C++

```

// Create the root directory (with name "/" and no parent)
//
DirectoryIPtr root = new DirectoryI(communicator(), "/", 0);
root->activate(adapter);

// Create a file called "README" in the root directory
//
FileIPtr file = new FileI(communicator(), "README", root);
Lines text;
text.push_back("This file system contains a collection of poetry.");
file->write(text);
file->activate(adapter);

// Create a directory called "Coleridge"
// in the root directory
//
DirectoryIPtr coleridge =
new DirectoryI(communicator(), "Coleridge", root);
coleridge->activate(adapter);

// Create a file called "Kubla_Khan"
// in the Coleridge directory
//
file = new FileI(communicator(), "Kubla_Khan", coleridge);
text.erase(text.begin(), text.end());
text.push_back("In Xanadu did Kubla Khan");
text.push_back("A stately pleasure-dome decree:");
text.push_back("Where Alph, the sacred river, ran");
text.push_back("Through caverns measureless to man");
text.push_back("Down to a sunless sea.");
file->write(text);
file->activate(adapter);

```

We first create the root directory and a file `README` within the root directory. (Note that we pass the handle to the root directory as the parent pointer when we create the new node of type `FileI`.)

After creating each servant, the code calls `activate` on the servant. (We will see the definition of this member function shortly.) The `activate` member function adds the servant to the ASM.

The next step is to fill the file with text:

C++

```
FileIPtr file = new FileI(communicator(), "README", root);
Lines text;
text.push_back("This file system contains a collection of poetry.");
file->write(text);
file->activate(adapter);
```

Recall that [Slice sequences](#) map to STL vectors. The Slice type `Lines` is a sequence of strings, so the C++ type `Lines` is a vector of strings; we add a line of text to our `README` file by calling `push_back` on that vector.

Finally, we call the Slice `write` operation on our `FileI` servant by simply writing:

C++

```
file->write(text);
```

This statement is interesting: the server code invokes an operation on one of its own servants. Because the call happens via a smart class pointer (of type `FilePtr`) and not via a proxy (of type `FilePrx`), the Ice run time does not know that this call is even taking place — such a direct call into a servant is not mediated by the Ice run time in any way and is dispatched as an ordinary C++ function call.

In similar fashion, the remainder of the code creates a subdirectory called `Coleridge` and, within that directory, a file called `Kubla_Khan` to complete the structure in the above illustration.

Servant Class Definitions in C++

We must provide servants for the concrete interfaces in our Slice specification, that is, we must provide servants for the `File` and `Directory` interfaces in the C++ classes `FileI` and `DirectoryI`. This means that our servant classes might look as follows:

C++

```
namespace Filesystem {
  class FileI : virtual public File {
    // ...
  };

  class DirectoryI : virtual public Directory {
    // ...
  };
}
```

This leads to the C++ class structure as shown:

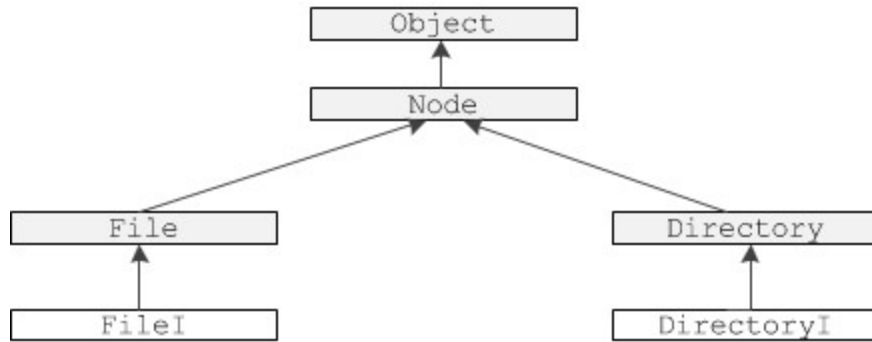

File system servants using interface inheritance.

The shaded classes in the illustration above are skeleton classes and the unshaded classes are our servant implementations. If we implement our servants like this, `FileI` must implement the pure virtual operations it inherits from the `File` skeleton (`read` and `write`), as well as the operation it inherits from the `Node` skeleton (`name`). Similarly, `DirectoryI` must implement the pure virtual function it inherits from the `Directory` skeleton (`list`), as well as the operation it inherits from the `Node` skeleton (`name`). Implementing the servants in this way uses interface inheritance from `Node` because no implementation code is inherited from that class.

Alternatively, we can implement our servants using the following definitions:

```

C++
namespace Filesystem {
    class NodeI : virtual public Node {
        // ...
    };

    class FileI : virtual public File, virtual public NodeI {
        // ...
    };

    class DirectoryI : virtual public Directory, virtual public NodeI {
        // ...
    };
}

```

This leads to the C++ class structure shown:

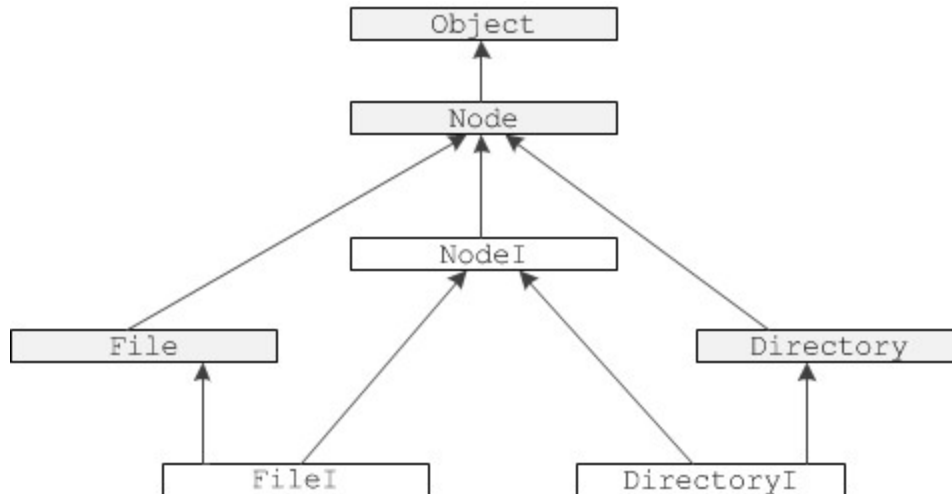

File system servants using implementation inheritance.

In this implementation, `NodeI` is a concrete base class that implements the `name` operation it inherits from the `Node` skeleton. `FileI` and `DirectoryI` use multiple inheritance from `NodeI` and their respective skeletons, that is, `FileI` and `DirectoryI` use implementation inheritance from their `NodeI` base class.

Either implementation approach is equally valid. Which one to choose simply depends on whether we want to re-use common code provided by `NodeI`. For the implementation that follows, we have chosen the second approach, using implementation inheritance.

Given the structure in the above illustration and the operations we have defined in the Slice definition for our file system, we can add these operations to the class definition for our servants:

```

C++
namespace Filesystem {
  class NodeI : virtual public Node {
  public:
    virtual std::string name(const Ice::Current&);
  };

  class FileI : virtual public File, virtual public NodeI {
  public:
    virtual Lines read(const Ice::Current&);
    virtual void write(const Lines&, const Ice::Current&);
  };

  class DirectoryI : virtual public Directory, virtual public NodeI {
  public:
    virtual NodeSeq list(const Ice::Current&);
  };
}

```

This simply adds signatures for the operation implementations to each class. Note that the signatures must exactly match the operation signatures in the generated skeleton classes — if they do not match exactly, you end up overloading the pure virtual function in the base class instead of overriding it, meaning that the servant class cannot be instantiated because it will still be abstract. To avoid signature mismatches, you can copy the signatures from the generated header file (`Filesystem.h`), or you can use the `--impl` option with `slice2cpp` to generate header and implementation files that you can add your application code to.

Now that we have the basic structure in place, we need to think about other methods and data members we need to support our servant implementation. Typically, each servant class hides the copy constructor and assignment operator, and has a constructor to provide initial state for its data members. Given that all nodes in our file system have both a name and a parent directory, this suggests that the `NodeI` class should implement the functionality relating to tracking the name of each node, as well as the parent-child relationships:

```
C++
```

```
namespace Filesystem {
    class DirectoryI;
    typedef IceUtil::Handle<DirectoryI> DirectoryIPtr;

    class NodeI : virtual public Node {
    public:
        virtual std::string name(const Ice::Current&);
        NodeI(const Ice::CommunicatorPtr&, const std::string&,
const DirectoryIPtr&);
        void activate(const Ice::ObjectAdapterPtr&);
    private:
        std::string _name;
        Ice::Identity _id;
        DirectoryIPtr _parent;
        NodeI(const NodeI&);           // Copy forbidden
        void operator=(const NodeI&); // Assignment forbidden
    };
}
```

The `NodeI` class has a private data member to store its name (of type `std::string`) and its parent directory (of type `DirectoryIPtr`). The constructor accepts parameters that set the value of these data members. For the root directory, by convention, we pass a null handle to the constructor to indicate that the root directory has no parent. The constructor also requires the communicator to be passed to it. This is necessary because the constructor creates the identity for the servant, which requires access to the communicator. The `activate` member function adds the servant to the ASM (which requires access to the object adapter) and connects the child to its parent.

The `FileI` servant class must store the contents of its file, so it requires a data member for this. We can conveniently use the generated `Lines` type (which is a `std::vector<std::string>`) to hold the file contents, one string for each line. Because `FileI` inherits from `NodeI`, it also requires a constructor that accepts the communicator, file name, and parent directory, leading to the following class definition:

```
C++
```

```
namespace Filesystem {
    class FileI : virtual public File, virtual public NodeI {
    public:
        virtual Lines read(const Ice::Current&);
        virtual void write(const Lines&, const Ice::Current&);
        FileI(const Ice::CommunicatorPtr&, const std::string&,
const DirectoryIPtr&);
    private:
        Lines _lines;
    };
}
```

For directories, each directory must store its list of child nodes. We can conveniently use the generated `NodeSeq` type (which is a `vector<NodePrx>`) to do this. Because `DirectoryI` inherits from `NodeI`, we need to add a constructor to initialize the directory name and its parent directory. As we will see shortly, we also need a private helper function, `addChild`, to make it easier to connect a newly created directory to its parent. This leads to the following class definition:

```

C++

namespace Filesystem {
    class DirectoryI : virtual public Directory, virtual public NodeI {
    public:
        virtual NodeSeq list(const Ice::Current&) const;
        DirectoryI(const Ice::CommunicatorPtr&, const std::string&,
const DirectoryIPtr&);
        void addChild(NodePrx child);
    private:
        NodeSeq _contents;
    };
}
```

Servant Header File Example

Putting all this together, we end up with a servant header file, `FilesystemI.h`, as follows:

C++

```

#include <Ice/Ice.h>
#include <Filesystem.h>

namespace Filesystem {
    class DirectoryI;
    typedef IceUtil::Handle<DirectoryI> DirectoryIPtr;

    class NodeI : virtual public Node {
    public:
        virtual std::string name(const Ice::Current&);
        NodeI(const Ice::CommunicatorPtr&, const std::string&,
const DirectoryIPtr&);
        void activate(const Ice::ObjectAdapterPtr&);
    private:
        std::string _name;
        Ice::Identity _id;
        DirectoryIPtr _parent;
        NodeI(const NodeI&);           // Copy forbidden
        void operator=(const NodeI&); // Assignment forbidden
    };

    typedef IceUtil::Handle<NodeI> NodeIPtr;

    class FileI : virtual public File, virtual public NodeI {
    public:
        virtual Lines read(const Ice::Current&);
        virtual void write(const Lines&,
const Ice::Current& = Ice::Current());
        FileI(const Ice::CommunicatorPtr&, const std::string&,
const DirectoryIPtr&);
    private:
        Lines _lines;
    };

    typedef IceUtil::Handle<FileI> FileIPtr;

    class DirectoryI : virtual public Directory, virtual public NodeI {
    public:
        virtual NodeSeq list(const Ice::Current&);
        DirectoryI(const Ice::CommunicatorPtr&, const std::string&,
const DirectoryIPtr&);
        void addChild(const Filesystem::NodePrx&);
    private:
        Filesystem::NodeSeq _contents;
    };
}

```

The Servant Implementation in C++

The implementation of our servants is mostly trivial, following from the class definitions in our `FilesystemI.h` header file.

Implementing `FileI`

The implementation of the `read` and `write` operations for files is trivial: we simply store the passed file contents in the `_lines` data member. The constructor is equally trivial, simply passing its arguments through to the `NodeI` base class constructor:

```

C++



```

Filesystem::Lines
Filesystem::FileI::read(const Ice::Current&)
{
 return _lines;
}

void
Filesystem::FileI::write(const Filesystem::Lines& text,
const Ice::Current&)
{
 _lines = text;
}

Filesystem::FileI::FileI(const Ice::CommunicatorPtr& communicator,
 const string& name,
 const DirectoryIPtr& parent)
 : NodeI(communicator, name, parent)
{
}

```

```

Implementing `DirectoryI`

The implementation of `DirectoryI` is equally trivial: the `list` operation simply returns the `_contents` data member and the constructor passes its arguments through to the `NodeI` base class constructor:

C++

```

Filesystem::NodeSeq
Filesystem::DirectoryI::list(const Ice::Current&)
{
    return _contents;
}

Filesystem::DirectoryI::DirectoryI(const
Ice::CommunicatorPtr& communicator,
                                   const string& name,
                                   const DirectoryIPtr& parent)
    : NodeI(name, parent)
{
}

void
Filesystem::DirectoryI::addChild(const NodePrx child)
{
    _contents.push_back(child);
}

```

The only noteworthy thing is the implementation of `addChild`: when a new directory or file is created, the constructor of the `NodeI` base class calls `addChild` on its own parent, passing it the proxy to the newly-created child. The implementation of `addChild` appends the passed reference to the contents list of the directory it is invoked on (which is the parent directory).

Implementing NodeI

The name operation of our `NodeI` class is again trivial: it simply returns the `_name` data member:

C++

```

std::string
Filesystem::NodeI::name(const Ice::Current&)
{
    return _name;
}

```

The `NodeI` constructor creates an identity for the servant:

C++

```

Filesystem::NodeI::NodeI(const Ice::CommunicatorPtr& communicator,
                        const string& name,
                        const DirectoryIPtr& parent)
    : _name(name), _parent(parent)
{
    _id.name = parent ? IceUtil::generateUUID() : "RootDir";
}

```

For the root directory, we use the fixed identity "RootDir". This allows the [client](#) to create a proxy for the root directory. For directories other than the root directory, we use a [UUID as the identity](#).

Finally, `NodeI` provides the `activate` member function that adds the servant to the ASM and connects the child node to its parent directory:

C++

```

void
Filesystem::NodeI::activate(const Ice::ObjectAdapterPtr& a)
{
    NodePrx thisNode = NodePrx::uncheckedCast(a->add(this, _id));
    if(_parent)
    {
        _parent->addChild(thisNode);
    }
}

```

This completes our servant implementation. The complete source code is shown here once more:

C++

```

#include <IceUtil/IceUtil.h>
#include <FilesystemI.h>

using namespace std;

// Slice Node::name() operation

std::string
Filesystem::NodeI::name(const Ice::Current&)
{
    return _name;
}

// NodeI constructor

Filesystem::NodeI::NodeI(const Ice::CommunicatorPtr& communicator,
                        const string& name,

```



```

        const DirectoryIPtr& parent)
    : _name(name), _parent(parent)
    {
        // Create an identity. The root directory has the fixed identity "RootDir"
        //
        _id.name = parent ? IceUtil::generateUUID() : "RootDir";
    }

// NodeI activate() member function

void
Filesystem::NodeI::activate(const Ice::ObjectAdapterPtr& a)
{
    NodePrx thisNode = NodePrx::uncheckedCast(a->add(this, _id));
    if(_parent)
    {
        _parent->addChild(thisNode);
    }
}

// Slice File::read() operation

Filesystem::Lines
Filesystem::FileI::read(const Ice::Current&)
{
    return _lines;
}

// Slice File::write() operation

void
Filesystem::FileI::write(const Filesystem::Lines& text, const Ice::Current&)
{
    _lines = text;
}

// FileI constructor

Filesystem::FileI::FileI(const Ice::CommunicatorPtr& communicator,
                        const string& name,
                        const DirectoryIPtr& parent)
    : NodeI(communicator, name, parent)
    {
    }

// Slice Directory::list() operation

Filesystem::NodeSeq

```

```
Filesystem::DirectoryI::list(const Ice::Current& c)
{
    return _contents;
}

// DirectoryI constructor

Filesystem::DirectoryI::DirectoryI(const Ice::CommunicatorPtr& communic
ator,
                                   const string& name,
                                   const DirectoryIPtr& parent)
    : NodeI(communicator, name, parent)
{
}

// addChild is called by the child in order to add
// itself to the _contents member of the parent

void
Filesystem::DirectoryI::addChild(const NodePrx& child)
{
```

```
    _contents.push_back(child);  
}
```

See Also

- [Slice for a Simple File System](#)
- [Example of a File System Client in C++](#)
- [The `Ice::Application` Class](#)
- [C++ Mapping for Sequences](#)
- [slice2cpp Command-Line Options](#)
- [UUIDs as Identities in C++](#)
- [Threads and Concurrency with C++](#)

The C++ Utility Library

Ice for C++ includes a number of utility classes and functions in the `IceUtil` namespace, which we summarize here for your reference. Many of the classes and functions in `IceUtil` are documented elsewhere in this manual so, where appropriate, the sections here simply reference the relevant pages.

Topics

- [The C++ AbstractMutex Class](#)
- [The C++ Cache Template](#)
- [The C++ Exception Class](#)
- [The C++ generateUUID Function](#)
- [The C++ Handle Template](#)
- [The C++ Handle Template Adaptors](#)
- [The C++ ScopedArray Template](#)
- [The C++ Shared and SimpleShared Classes](#)
- [The C++ Time Class](#)
- [The C++ Timer and TimerTask Classes](#)
- [Unicode and UTF-8 Conversion Functions in C++](#)
- [Version Information in C++](#)

The C++ AbstractMutex Class

`AbstractMutex` defines a mutex base interface used by the Freeze [background save evictor](#). The interface allows the evictor to synchronize with servants that are stored in a Freeze database. The class has the following definition:

```

C++

class AbstractMutex {
public:
    typedef LockT<AbstractMutex> Lock;
    typedef TryLockT<AbstractMutex> TryLock;

    virtual ~AbstractMutex();

    virtual void lock() const = 0;
    virtual void unlock() const = 0;
    virtual bool tryLock() const = 0;
};

```

This class definition is provided in `IceUtil/AbstractMutex.h`. The same header file also defines a few template implementation classes that specialize `AbstractMutex`, as described below.

`AbstractMutexI`

This template class implements `AbstractMutex` by forwarding all member functions to its template argument:

```

C++

template <typename T>
class AbstractMutexI : public AbstractMutex, public T {
public:
    typedef LockT<AbstractMutexI> Lock;
    typedef TryLockT<AbstractMutexI> TryLock;

    virtual void lock() const {
        T::lock();
    }

    virtual void unlock() const {
        T::unlock();
    }

    virtual bool tryLock() const {
        return T::tryLock();
    }

    virtual ~AbstractMutexI() {}
};

```

`AbstractMutexReadI`

This template class implements a read lock by forwarding the `lock` and `tryLock` functions to the `readLock` and `tryReadLock` functions of its template argument:

```

C++

template <typename T>
class AbstractMutexReadI : public AbstractMutex, public T {
public:
    typedef LockT<AbstractMutexReadI> Lock;
    typedef TryLockT<AbstractMutexReadI> TryLock;

    virtual void lock() const {
        T::readLock();
    }

    virtual void unlock() const {
        T::unlock();
    }

    virtual bool tryLock() const {
        return T::tryReadLock();
    }

    virtual ~AbstractMutexReadI() {}
};
```

`AbstractMutexWriteI`

This template class implements a write lock by forwarding the `lock` and `tryLock` functions to the `writeLock` and `tryWriteLock` functions of its template argument:

C++

```

template <typename T>
class AbstractMutexWriteI : public AbstractMutex, public T {
public:
    typedef LockT<AbstractMutexWriteI> Lock;
    typedef TryLockT<AbstractMutexWriteI> TryLock;

    virtual void lock() const {
        T::writeLock();
    }

    virtual void unlock() const {
        T::unlock();
    }

    virtual bool tryLock() const {
        return T::tryWriteLock();
    }

    virtual ~AbstractMutexWriteI() {}
};

```

Apart from use with Freeze servants, these templates are also useful if, for example, you want to implement your own evictor.

See Also

- [Background Save Evictor](#)

The C++ Cache Template

This class allows you to efficiently maintain a cache that is backed by secondary storage, such as a Berkeley DB database, without holding a lock on the entire cache while values are being loaded from the database. If you want to create [evictors](#) for servants that store their state in a database, the `Cache` class can simplify your evictor implementation considerably.

i You may also want to examine the implementation of the [Freeze background save evictor](#) in the source distribution; it uses `IceUtil::Cache` for its implementation.

The `Cache` class has the following interface:

```

C++
template<typename Key, typename Value>
class Cache {
public:
    typedef typename std::map< /* ... */ , /* ... */>::iterator Position;

    bool pin(const Key& k, const Handle<Value>& v);
    Handle<Value> pin(const Key& k);
    void unpin(Position p);

    Handle<Value> putIfAbsent(const Key& k, const Handle<Value>& v);

    Handle<Value> getIfPinned(const Key&, bool = false) const;

    void clear();
    size_t size() const;

protected:
    virtual Handle<Value> load(const Key& k) = 0;
    virtual void pinned(const Handle<Value>& v, Position p);

    virtual ~Cache();
};

```

Note that `Cache` is an abstract base class — you must derive a concrete implementation from `Cache` and provide an implementation of the `load` and, optionally, of the `pinned` member function.

Internally, a `Cache` maintains a map of name-value pairs. The key and value type of the map are supplied by the `Key` and `Value` template arguments, respectively. The implementation of `Cache` takes care of maintaining the map; in particular, it ensures that concurrent lookups by callers are possible without blocking even if some of the callers are currently loading values from the backing store. In turn, this is useful for evictor implementations, such as the [Freeze background save evictor](#). The `Cache` class does not limit the number of entries in the cache — it is the job of the evictor implementation to limit the map size by calling `unpin` on elements of the map that it wants to evict.

Your concrete implementation class must implement the `load` function, whose job it is to load the value for the key `k` from the backing store and return a handle to that value. Note that `load` returns a value of type `IceUtil::Handle`, that is, the value must be heap-allocated and support the usual reference-counting functions for smart pointers. (The easiest way to achieve this is to derive the value from `IceUtil::Shared`.)

If `load` cannot locate a record for the given key because no such record exists, it must return a null handle. If `load` fails for some other

reason, it can throw an exception, which is propagated back to the application code.

Your concrete implementation class typically will also override the `pinned` function (unless you want to have a cache that does not limit the number of entries; the provided default implementation of `pinned` is a no-op). The `Cache` implementation calls `pinned` whenever it has added a value to the map as a result of a call to `pin`; the `pinned` function is therefore a callback that allows the derived class to find out when a value has been added to the cache and informs the derived class of the value and its position in the cache.

The `Position` parameter is a `std::iterator` into the cache's internal map that records the position of the corresponding map entry. (Note that the element type of map is opaque, so you should not rely on knowledge of the cache's internal key and value types.) Your implementation of `pinned` must remember the position of the entry because that position is necessary to remove the corresponding entry from the cache again.

The public member functions of `Cache` behave as follows:

```
bool pin(const Key& k, const Handle<Value>& v);
```

To add a key-value pair to the cache, your evictor can call `pin`. The return value is true if the key and value were added; a false return value indicates that the map already contained an entry with the given key and the original value for that key is unchanged.

`pin` calls `pinned` if it adds an entry.

This version of `pin` does *not* call `load` to retrieve the entry from backing store if it is not yet in the cache. This is useful when you add a newly-created object to the cache.

Once an entry is in the cache, it is guaranteed to remain in the cache at the same position in memory, and without its value being overwritten by another thread, until that entry is unpinned by a call to `unpin`.

```
Handle<Value> pin(const Key& k);
```

A second version of `pin` looks for the entry with the given key in the cache. If the entry is already in the cache, `pin` returns the entry's value. If no entry with the given key is in the cache, `pin` calls `load` to retrieve the corresponding entry. If `load` returns an entry, `pin` adds it to the cache and returns the entry's value. If the entry cannot be retrieved from the backing store, `pin` returns null.

`pin` calls `pinned` if it adds an entry.

The function is thread-safe, that is, it calls `load` only once all other threads have unpinned the entry.

Once an entry is in the cache, it is guaranteed to remain in the cache at the same position in memory, and without its value being overwritten by another thread, until that entry is unpinned by a call to `unpin`.

```
Handle<Value> putIfAbsent(const Key& k, const Handle<Value>& v);
```

This function adds a key-value pair to the cache and returns a smart pointer to the value. If the map already contains an entry with the given key, that entry's value remains unchanged and `putIfAbsent` returns its value. If no entry with the given key is in the cache, `putIfAbsent` calls `load` to retrieve the corresponding entry. If `load` returns an entry, `putIfAbsent` adds it to the cache and returns the entry's value. If the entry cannot be retrieved from the backing store, `putIfAbsent` returns null.

`putIfAbsent` calls `pinned` if it adds an entry.

The function is thread-safe, that is, it calls `load` only once all other threads have unpinned the entry.

Once an entry is in the cache, it is guaranteed to remain in the cache at the same position in memory, and without its value being overwritten by another thread, until that entry is unpinned by a call to `unpin`.

```
Handle<Value> getIfPinned(const Key& k, bool wait = false) const;
```

This function returns the value stored for the key `k`.

- If an entry for the given key is in the map, the function returns the value immediately, regardless of the value of `wait`.
- If no entry for the given key is in the map and the `wait` parameter is false, the function returns a null handle.
- If no entry for the given key is in the map and the `wait` parameter is true, the function blocks the calling thread if another thread is currently attempting to load the same entry; once the other thread completes, `getIfPinned` completes and returns the value added by the other thread.

```
void unpin(Position p);
```

This function removes an entry from the map. The iterator `p` determines which entry to remove. (It must be an iterator that previously was

passed to `pinned`.) The iterator `p` is invalidated by this operation, so you must not use it again once `unpin` returns. (Note that the `Cache` implementation ensures that updates to the map never invalidate iterators to existing entries in the map; `unpin` invalidates only the iterator for the removed entry.)

```
void clear();
```

This function removes all entries in the map.

```
size_t size() const;
```

This function returns the number of entries in the map.

See Also

- [Servant Evictors](#)
- [The C++ Handle Template](#)
- [The C++ Shared and SimpleShared Classes](#)
- [Background Save Evictor](#)

The C++ Exception Class

This class is at the root of the derivation tree for [Ice exceptions](#) and encapsulates functionality that is common to all `Ice` and `IceUtil` exceptions:

C++
<pre> class Exception : public std::exception { public: Exception(); Exception(const char* file, int line); virtual ~Exception() throw(); virtual std::string ice_name() const; virtual void ice_print(std::ostream&) const; virtual const char* what() const throw(); virtual Exception* ice_clone() const; virtual void ice_throw() const; const char* ice_file() const; int ice_line() const; const std::string& ice_stackTrace() const; }; </pre>

The second constructor stores a file name and line number in the exception that are returned by the `ice_file` and `ice_line` member functions, respectively. This allows you to identify the source of an exception by passing the `__FILE__` and `__LINE__` preprocessor macros to the constructor.

The `what` member function is a synonym for `ice_print`. The default implementation of `ice_print` prints the file name, line number, and the name of the exception.

The `ice_stackTrace` function returns the full stack trace when the exception was constructed, or an empty string, depending on the value of the `Ice.PrintStackTraces` property.

The remaining member functions are described in the [C++ Mapping for Exceptions](#).

See Also

- [C++ Mapping for Exceptions](#)

The C++ generateUUID Function

Universally-unique identifiers (UUIDs) are often used in the [identities](#) of Ice objects. The C++ standard does not include a function for generating UUIDs, therefore Ice provides the `IceUtil::generateUUID` function for use in portable applications. The signature of `generateUUID` is:

```
C++  
std::string generateUUID();
```

The function returns a string like the following:

```
02b066f5-c762-431c-8dd3-9b1941355e41
```

Each invocation returns a new identifier that differs from all previous ones.

See Also

- [Object Identity](#)

The C++ Handle Template

`IceUtil::Handle` implements a smart reference-counted pointer type. [Smart pointers](#) are used to guarantee automatic deletion of heap-allocated class instances.

`Handle` is a template class with the following interface:

```

C++
template<typename T>
class Handle : /* ... */ {
public:

    typedef T element_type;

    T* _ptr;

    T* operator->() const;
    T& operator*() const;
    T* get() const;

    operator bool() const;

    void swap(HandleBase& other);

    Handle(T* p = 0);

    template<typename Y>
    Handle(const Handle<Y>& r);

    Handle(const Handle& r);

    ~Handle();

    Handle& operator=(T* p);

    template<typename Y>
    Handle& operator=(const Handle<Y>& r);

    Handle& operator=(const Handle& r);

    template<class Y>
    static Handle dynamicCast(const HandleBase<Y>& r);

    template<class Y>
    static Handle dynamicCast(Y* p);
};

template<typename T, typename U>
bool operator==(const Handle<T>& lhs, const Handle<U>& rhs);

```

```
template<typename T, typename U>
bool operator!=(const Handle<T>& lhs, const Handle<U>& rhs);

template<typename T, typename U>
bool operator<(const Handle<T>& lhs, const Handle<U>& rhs);

template<typename T, typename U>
bool operator<=(const Handle<T>& lhs, const Handle<U>& rhs);

template<typename T, typename U>
bool operator>(const Handle<T>& lhs, const Handle<U>& rhs);
```

```
template<typename T, typename U>
bool operator>=(const Handle<T>& lhs, const Handle<U>& rhs);
```

i Note that the actual implementation is split into a base and a derived class. For simplicity, we show the combined interface here. If you want to see the full implementation detail, it can be found in `IceUtil/Handle.h`.

The template argument must be a class that derives from `Shared` or `SimpleShared` (or that implements reference counting with the same interface as these classes).

This is quite a large interface, but all it really does is to faithfully mimic the behavior of ordinary C++ class instance pointers. Rather than discussing each member function in detail, we provide a simple overview here that outlines the most important points. Please see the discussion of [Ice objects](#) for more examples of using smart pointers.

`element_type`

This type definition follows the STL convention of defining the element type with the fixed name `element_type` so you can use it for template programming or the definition of generic containers.

`_ptr`

This data member stores the pointer to the underlying heap-allocated class instance.

Constructors, copy constructor, and assignment operators

These member functions allow you to construct, copy, and assign smart pointers as if they were ordinary pointers. In particular, the constructor and assignment operator are overloaded to work with raw C++ class instance pointers, which results in the "adoption" of the raw pointer by the smart pointer. For example, the following code works correctly and does not cause a memory leak:

C++

```
typedef Handle<MyClass> MyClassPtr;

void foo(const MyClassPtr&);

// ...

foo(new MyClass); // OK, no leak here.
```

`operator->`, `operator*`, and `get`

The arrow and indirection operators allow you to apply the usual pointer syntax to smart pointers to use the target of a smart pointer. The `get` member function returns the class instance pointer to the underlying reference-counted class instance; the return value is the value of `_ptr`.

`dynamicCast`

This member function works exactly like a C++ `dynamic_cast`: it tests whether the argument supports the specified type and, if so, returns a non-null pointer; if the target does not support the specified type, it returns null.

i The reason for not using an actual `dynamic_cast` and using a `dynamicCast` function instead is that `dynamic_cast` only operates on pointer types, but `IceUtil::Handle` is a class.

For example:

C++

```

MyClassPtr p = ...;
MyOtherClassPtr o = ...;

o = MyOtherClassPtr::dynamicCast(p);
if (o)
{
    // o points at an instance of type MyOtherClass.
}
else
{
    // p points at something that is
    // not compatible with MyOtherClass.
}

```

Note that this example also illustrates the use of `operator bool`: when used in a boolean context, a smart pointer returns true if it is non-null and false otherwise.

Comparison operators: `==`, `!=`, `<`, `<=`, `>`, `>=`

The comparison operators for smart pointers delegate to the operators of the underlying class, therefore the author of the reference-counted class defines the semantics of smart pointer comparison. For example, in the case of [Slice classes](#), the base class `Ice::Object` implements the comparison operators in terms of pointer addresses. On the other hand, the base class for [Slice proxies](#) implements comparison using value semantics.

See Also

- [Smart Pointers for Classes](#)
- [C++ Mapping for Interfaces](#)
- [The C++ Shared and SimpleShared Classes](#)

The C++ Handle Template Adaptors

`IceUtil` provides adaptors that support use of [smart pointers](#) with STL algorithms. Each template function returns a corresponding function object that is for use by an STL algorithm. The adaptors are defined in the header `IceUtil/Functional.h`.

Here is a list of the adaptors:

```
memFun
memFun1
voidMemFun
voidMemFun1

secondMemFun
secondMemFun1
secondVoidMemFun
secondVoidMemFun1

constMemFun
constMemFun1
constVoidMemFun
constVoidMemFun1

secondConstMemFun
secondConstMemFun1
secondConstVoidMemFun
secondConstVoidMemFun1
```

As you can see, the adaptors are in two groups. The first group operates on non-const smart pointers, whereas the second group operates on `const` smart pointers (for example, on smart pointers declared as `const MyClassPtr`).

Each group is further divided into two sub-groups. The adaptors in the first group operate on the target of a smart pointer, whereas the `second<name>` adaptors operate on the second element of a pair, where that element is a smart pointer.

Each of the four sub-groups contains four adaptors:

```
memFun
```

This adaptor is used for member functions that return a value and do not accept an argument. For example:

C++

```

class MyClass : public IceUtil::Shared {
public:
    MyClass(int i) : _i(i) {}
    int getVal() { return _i; }
private:
    int _i;
};

typedef IceUtil::Handle<MyClass> MyClassPtr;

// ...

vector<MyClassPtr> mcp;
mcp.push_back(new MyClass(42));
mcp.push_back(new MyClass(99));

transform(mcp.begin(), mcp.end(),
          ostream_iterator<int>(cout, " "),
          IceUtil::memFun(&MyClass::getVal));
cout << endl;

```

This code invokes the member function `getVal` on each instance that is pointed at by smart pointers in the vector `mcp` and prints the return value of `getVal` on `cout`, separated by spaces. The output from this code is:

```
42 99
```

`memFun1`

This adaptor is used for member functions that return a value and accept a single argument. For example:

C++

```

class MyClass : public IceUtil::Shared {
public:
    MyClass(int i) : _i(i) {}
    int plus(int v) { return _i + v; }
private:
    int _i;
};

typedef IceUtil::Handle<MyClass> MyClassPtr;

// ...

vector<MyClassPtr> mcp;
mcp.push_back(new MyClass(2));
mcp.push_back(new MyClass(4));
mcp.push_back(new MyClass(6));

int A[3] = { 5, 7, 9 };
transform(mcp.begin(), mcp.end(), A,
          ostream_iterator<int>(cout, " "),
          IceUtil::memFun1(&MyClass::plus));
cout << endl;

```

This code invokes the member function `plus` on each instance that is pointed at by smart pointers in the vector `mcp` and prints the return value of a call to `plus` on `cout`, separated by spaces. The calls to `plus` are successively passed the values stored in the array `A`. The output from this code is:

```
7 11 15
```

`voidMemFun`

This adaptor is used for member functions that do not return a value and do not accept an argument. For example:

C++

```

class MyClass : public IceUtil::Shared {
public:
    MyClass(int i) : _i(i) {}
    void print() { cout << _i << endl; }
private:
    int _i;
};

typedef IceUtil::Handle<MyClass> MyClassPtr;

// ...

vector<MyClassPtr> mcp;
mcp.push_back(new MyClass(2));
mcp.push_back(new MyClass(4));
mcp.push_back(new MyClass(6));

for_each(mcp.begin(), mcp.end(), IceUtil::voidMemFun(&MyClass::print));

```

This code invokes the member function `print` on each instance that is pointed at by smart pointers in the vector `mcp`. The output from this code is:

```

2
4
6

```

`voidMemFun1`

This adaptor is used for member functions that do not return a value and accept a single argument. For example:

C++

```

class MyClass : public IceUtil::Shared {
public:
    MyClass(int i) : _i(i) {}
    void printPlus(int v) { cout << _i + v << endl; }
private:
    int _i;
};

typedef IceUtil::Handle<MyClass> MyClassPtr;

vector<MyClassPtr> mcp;
mcp.push_back(new MyClass(2));
mcp.push_back(new MyClass(4));
mcp.push_back(new MyClass(6));

for_each(
    mcp.begin(), mcp.end(),
    bind2nd(IceUtil::voidMemFun1(&MyClass::printPlus), 3));

```

This code invokes the member function `printPlus` on each instance that is pointed at by smart pointers in the vector `mcp`. The output from this code is:

```

5
7
9

```

As mentioned earlier, the `second<name>` versions of the adaptors operate on the second element of a `std::pair<T1, T2>`, where `T2` must be a smart pointer. Most commonly, these adaptors are used to apply an algorithm to each lookup value of a map or multi-map. Here is an example:

C++

```

class MyClass : public IceUtil::Shared {
public:
    MyClass(int i) : _i(i) {}
    int plus(int v) { return _i + v; }
private:
    int _i;
};

typedef IceUtil::Handle<MyClass> MyClassPtr;

// ...

map<string, MyClassPtr> m;
m["two"] = new MyClass(2);
m["four"] = new MyClass(4);
m["six"] = new MyClass(6);

int A[3] = { 5, 7, 9 };
transform(
    m.begin(), m.end(), A,
    ostream_iterator<int>(cout, " "),
    IceUtil::secondMemFun1<int, string, MyClass>(&MyClass::plus));

```

This code invokes the `plus` member function on the class instance denoted by the `second` smart pointer member of each pair in the dictionary `m`. The output from this code is:

```
9 13 11
```

Note that `secondMemFun1` is a template that requires three arguments: the return type of the member function to be invoked, the key type of the dictionary, and the type of the class that is pointed at by the smart pointer.

In general, the `second<name>` adaptors require the following template arguments:

C++

```

secondMemFun<R, K, T>
secondMemFun1<R, K, T>
secondVoidMemFun<K, T>
secondVoidMemFun<K, T>

```

where `R` is the return type of the member function, `K` is the type of the first member of the pair, and `T` is the class that contains the member function.

See Also

- [The C++ Handle Template](#)

The C++ ScopedArray Template

`IceUtil::ScopedArray` is a smart pointer class similar to [Handle](#). However, instead of managing the memory for class instances, `ScopedArray` manages memory for an array. This class is provided mainly for use with the [stream API](#). However, you can use it with arrays for other purposes.

Here is the definition of the template in full:

C++

```

template<typename T>
class ScopedArray : private IceUtil::noncopyable
{
public:
    explicit ScopedArray(T* ptr = 0)
        : _ptr(ptr) { }

    ScopedArray(const ScopedArray& other) {
        _ptr = other._ptr;
        const_cast<ScopedArray&>(other)._ptr = 0;
    }

    ~ScopedArray() {
        if (_ptr != 0)
            delete[] _ptr;
    }

    void reset(T* ptr = 0) {
        assert(ptr == 0 || ptr != _ptr);
        if (_ptr != 0)
            delete[] _ptr;
        _ptr = ptr;
    }

    T& operator[](size_t i) const {
        assert(_ptr != 0);
        assert(i >= 0);
        return _ptr[i];
    }

    T* get() const {
        return _ptr;
    }

    void swap(ScopedArray& a) {
        T* tmp = a._ptr;
        a._ptr = _ptr;
        _ptr = tmp;
    }

private:
    T* _ptr;
};

```

The class allows you to allocate an array on the heap and assign its pointer to a `ScopedArray` instance. When the instance goes out of scope, it calls `delete[]` on the array, so you do not need to deallocate the array explicitly yourself. This greatly reduces the risk of a memory leak due to an early return or uncaught exception.

See Also

- [C++ Streaming Interfaces](#)

The C++ Shared and SimpleShared Classes

`IceUtil::Shared` and `IceUtil::SimpleShared` are base classes that implement the reference-counting mechanism for [smart pointers](#). The two classes provide identical interfaces; the difference between `Shared` and `SimpleShared` is that `SimpleShared` is not thread-safe and, therefore, can only be used if the corresponding class instances are accessed only by a single thread. (`SimpleShared` is marginally faster than `Shared` because it avoids the locking overhead that is incurred by `Shared`.)

The interface of `Shared` looks as follows. (Because `SimpleShared` has the same interface, we do not show it separately here.)

```

C++

class Shared {
public:
    Shared();
    Shared(const Shared&);
    virtual ~Shared();

    Shared& operator=(const Shared&);

    virtual void __incRef();
    virtual void __decRef();
    virtual int __getRef() const;
    virtual void __setNoDelete(bool);
};
```

The class maintains a reference that is initialized to zero by the constructor. `__incRef` increments the reference count and `__decRef` decrements it. If, during a call to `__decRef`, after decrementing the reference count, the reference count drops to zero, `__decRef` calls `delete this`, which causes the corresponding class instance to delete itself. The copy constructor increments the reference count of the copied instance, and the assignment operator increments the reference count of the source and decrements the reference count of the target.

The `__getRef` member function returns the value of the reference count and is useful mainly for debugging.

The `__setNoDelete` member function can be used to temporarily disable self-deletion and re-enable it again. This provides [exception safety](#) when you initialize a smart pointer with the `this` pointer of a class instance during construction.

To create a class that is reference-counted, you simply derive the class from `Shared` and define a smart pointer type for the class, for example:

```

C++

class MyClass : public IceUtil::Shared {
    // ...
};

typedef IceUtil::Handle<MyClass> MyClassPtr;
```

See Also

- [The C++ Handle Template](#)
- [Smart Pointers for Classes](#)

The C++ Time Class

The `Time` class provides basic facilities for getting the current time, constructing time intervals, adding and subtracting times, and comparing times:

```

C++
namespace IceUtil {

    typedef ... Int64;

    class Time {
    public:
        enum Clock { Realtime, Monotonic };
        Time(Clock = Realtime);
        static Time now();
        static Time seconds(Int64);
        static Time milliseconds(Int64);
        static Time microseconds(Int64);

        Int64 toSeconds() const;
        Int64 toMilliseconds() const;
        Int64 toMicroseconds() const;

        double toSecondsDouble() const;
        double toMillisecondsDouble() const;
        double toMicrosecondsDouble() const;

        std::string toDateTime() const;
        std::string toDuration() const;

        Time operator-() const;

        Time operator-(const Time&) const;
        Time operator+(const Time&) const;

        Time operator*(int) const;
        Time operator*(Int64) const;
        Time operator*(double) const;

        double operator/(const Time&) const;
        Time operator/(int) const;
        Time operator/(Int64) const;
        Time operator/(double) const;

        Time& operator--=(const Time&);
        Time& operator+=(const Time&);

        Time& operator*=(int);
        Time& operator*=(Int64);
        Time& operator*=(double);
    };
}

```

```
Time& operator/=(int);
Time& operator/=(Int64);
Time& operator/=(double);

bool operator<(const Time&) const;
bool operator<=(const Time&) const;
bool operator>(const Time&) const;
bool operator>=(const Time&) const;
bool operator==(const Time&) const;
bool operator!=(const Time&) const;

#ifdef _WIN32
operator timeval() const;
#endif
};
```

```

        std::ostream& operator<<(std::ostream&, const Time&);
    }

```

The member functions behave as follows:

`Time`

Internally, the `Time` class stores ticks in microsecond units. For absolute time, this is the number of microseconds since the Unix epoch (00:00:00 UTC on 1 Jan. 1970). For durations, this is the number of microseconds in the duration. The default constructor initializes the tick count to zero and selects the real-time clock. Constructing `Time` with an argument of `Monotonic` selects the monotonic clock on platforms that support it; the real-time clock is used on other platforms.

`now`

This function constructs a `Time` object that is initialized to the current time of day.

`seconds`, `milliSeconds`, `microSeconds`

These functions construct `Time` objects from the argument in the specified units. For example, the following statement creates a time duration of one minute:

C++

```
IceUtil::Time t = IceUtil::Time::seconds(60);
```

`toSeconds`, `toMilliSeconds`, `toMicroSeconds`

The member functions provide explicit conversion of a duration to seconds, milliseconds, and microseconds, respectively. The return value is a 64-bit signed integer (`IceUtil::Int64`). For example:

C++

```
IceUtil::Time t = IceUtil::Time::milliSeconds(2000);
IceUtil::Int64 secs = t.toSeconds(); // Returns 2
```

`toSecondsDouble`, `toMilliSecondsDouble`, `toMicroSecondsDouble`

The member functions provide explicit conversion of a duration to seconds, milliseconds, and microseconds, respectively. The return value is of type `double`.

`toDateTime`

This function returns a human-readable representation of a `Time` value as a date and time.

`toDuration`

This function returns a human-readable representation of a `Time` value as a duration.

Operators

`Time` provides operators that allow you to add, subtract, multiply, and divide times. For example:

C++

```
IceUtil::Time oneMinute = IceUtil::Time::seconds(60);
IceUtil::Time oneMinuteAgo = IceUtil::Time::now() - oneMinute;
```

The multiplication and division operators permit you to multiply and divide a duration. Note that these operators provide overloads for `int`, `l`

ong long, and double.

The comparison operators allow you to compare times and time intervals with each other, for example:

```
IceUtil::Time oneMinute = IceUtil::Time::seconds(60);
IceUtil::Time twoMinutes = IceUtil::Time::seconds(120);
assert(oneMinute < twoMinutes);
```

The `timeval` operator converts a `Time` object to a `struct timeval`, defined as follows:

```
C++
```

```
struct timeval {
    long tv_sec;
    long tv_usec;
};
```

The conversion is useful for API calls that require a `struct timeval` argument, such as `select`. To convert a duration into a `timeval` structure, simply assign a `Time` object to a `struct timeval`:

```
C++
```

```
IceUtil::Time oneMinute = IceUtil::Time::seconds(60);
struct timeval tv;
tv = t;
```

Note that this member function is not available under Windows.

```
std::ostream& operator<<(std::ostream&, Time&);
```

This operator prints the number of whole seconds since the epoch.

See Also

- [The C++ Timer and TimerTask Classes](#)

The C++ Timer and TimerTask Classes

The `Timer` class allows you to schedule some code for once-only or repeated execution after some time interval elapses. The code to be executed resides in a class you derive from `TimerTask`:

```

C++

class Timer;
typedef IceUtil::Handle<Timer> TimerPtr;

class TimerTask : virtual public IceUtil::Shared {
public:
    virtual ~TimerTask() { }
    virtual void runTimerTask() = 0;
};

typedef IceUtil::Handle<TimerTask> TimerTaskPtr;
```

Your derived class must override the `runTimerTask` member function; the code in this method is executed by the timer. If the code you want to run requires access to some program state, you can pass that state into the constructor of your class or, alternatively, set that state via member functions of your class before scheduling it with a timer.

The `Timer` class invokes the `runTimerTask` member function to run your code. The class has the following definition:

```

C++

class Timer : /* ... */ {
public:
    Timer();
    Timer(int priority);

    void schedule(const TimerTaskPtr& task,
const IceUtil::Time& interval);

    void scheduleRepeated(const TimerTaskPtr& task,
const IceUtil::Time& interval);

    bool cancel(const TimerTaskPtr& task);

    void destroy();
};

typedef IceUtil::Handle<Timer> TimerPtr;
```

Intervals are specified using `Time` objects.

The constructor is overloaded to allow you specify a `thread priority`. The priority controls the priority of the thread that executes your task.

The `schedule` member function schedules an instance of your timer task for once-only execution after the specified time interval has elapsed. Your code is executed by a separate thread that is created by the `Timer` class. The function throws an `IllegalArgumentException` if you invoke it on a destroyed timer.

The `scheduleRepeated` member function runs your task repeatedly, at the specified time interval. Your code is executed by a separate thread that is created by the `Timer` class; the same thread is used every time your code runs. The function throws an `IllegalArgumentException` if you invoke it on a destroyed timer.

If your code throws an exception, the `Timer` class ignores the exception, that is, for a task that is scheduled to run repeatedly, an exception in the current execution does not cancel the next execution.

If your code takes longer to execute than the time interval you have specified for repeated execution, the second execution is delayed accordingly. For example, if you ask for repeated execution once every five seconds, and your code takes ten seconds to complete, then the second execution of your task starts five seconds after the previous execution finishes, that is, the interval specifies the wait time between successive executions.

A `TimerTask` instance that has already been scheduled with a `Timer` instance cannot be scheduled again with the same `Timer` instance until the task has completed or been canceled.

For a single `Timer` instance, the execution of all registered tasks is serialized. The wait interval applies on a per-task basis so, if you schedule task A at an interval of five seconds, and task B at an interval of ten seconds, successive runs of task A start no sooner than five seconds after the previous task A has finished, and successive runs of task B start no sooner than ten seconds after the previous task B has finished. If, at the time a task is scheduled to run, another task is still running, the new task's execution is delayed until the previous task has finished.

If you want scheduled tasks to run concurrently, you can create several `Timer` instances; tasks then execute in as many threads concurrently as there are `Timer` instances.

The `cancel` member function removes a task from a timer's schedule. In other words, it stops a task that is scheduled from being executed. If you cancel a task while it is executing, `cancel` returns immediately and the currently running task is allowed to complete normally; that is, `cancel` does not wait for any currently running task to complete.

The return value is true if `cancel` removed the task from the schedule. This is the case if you invoke `cancel` on a task that is scheduled for repeated execution and this was the first time you cancelled that task; subsequent calls to `cancel` return false. Calling `cancel` on a task scheduled for once-only execution always returns false, as does calling `cancel` on a destroyed timer.

The `destroy` member function removes all tasks from the timer's schedule. If you call `destroy` from any thread other than the timer's own execution thread, it joins with the currently executing task (if any), so the function does not return until the current task has completed. If you call `destroy` from the timer's own execution thread, it instead detaches the timer's execution thread. Calling `destroy` a second time on the same `Timer` instance has no effect. Similarly, calling `cancel` on a destroyed timer has no effect.

Note that you must call `destroy` on a `Timer` instance before allowing it to go out of scope; failing to do so causes undefined behavior.

Calls to `schedule` or `scheduleRepeated` on a destroyed timer raises an `IceUtil::IllegalArgumentException`.

See Also

- [The C++ Time Class](#)
- [The C++ Thread Classes](#)

Unicode and UTF-8 Conversion Functions in C++

The `IceUtil` namespace contains two helper functions that allow you to convert between wide strings containing Unicode characters (either 16- or 32-bit, depending on your native `wchar_t` size) and narrow strings in UTF-8 encoding:

```
C++
```

```
enum ConversionFlags { strictConversion, lenientConversion };

std::string wstringToString(const std::wstring&,
    ConversionFlags = lenientConversion);
std::wstring stringToWstring(const std::string&,
    ConversionFlags = lenientConversion);
```

These functions always convert to and from UTF-8 encoding, that is, they ignore any locale setting that might specify a different encoding.

Byte sequences that are illegal, such as `0xF4908080`, result in a `UTFConversionException`. For other errors, the `ConversionFlags` parameter determines how rigorously the functions check for errors. When set to `lenientConversion` (the default), the functions tolerate isolated surrogates and irregular sequences, and substitute the UTF-32 replacement character `0x0000FFFD` for character values above `0x10FFFF`. When set to `strictConversion`, the functions do not tolerate such errors and throw a `UTFConversionException` instead:

```
C++
```

```
enum ConversionError { partialCharacter, badEncoding };

class UTFConversionException : public Exception {
public:
    UTFConversionException(const char* file, int line,
        ConversionError r);

    ConversionError conversionError() const;
    // ...
};
```

The `conversionError` member function returns the reason for the failure:

- `partialCharacter`
The UTF-8 source string contains a trailing incomplete UTF-8 byte sequence.
- `badEncoding`
The UTF-8 source string contains a byte sequence that is not a valid UTF-8 encoded character, or the Unicode source string contains a bit pattern that does not represent a valid Unicode character.

Version Information in C++

The header file `IceUtil/Config.h` defines two macros that expand to the version of the Ice run time:

```

C++

#define ICE_STRING_VERSION "3.4.2" // "<major>.<minor>.<patch>"  
#define ICE_INT_VERSION 30402     // AABBCC, with AA=major,  
                                 // BB=minor, CC=patch
```

`ICE_STRING_VERSION` is a string literal in the form `<major>.<minor>.<patch>`, for example, `3.4.2`. For beta releases, the version is `<major>.<minor>b`, for example, `3.4b`.

`INT_VERSION` is an integer literal in the form `AABBCC`, where `AA` is the major version number, `BB` is the minor version number, and `CC` is the patch level, for example, `30402` for version `3.4.2`. For beta releases, the patch level is set to `51` so, for example, for version `3.4b`, the value is `30451`.

Windows Store Applications

A Windows Store application that uses Ice must request certain capabilities in its manifest in order to access public and private networks. The image below shows the relevant settings in Visual Studio:

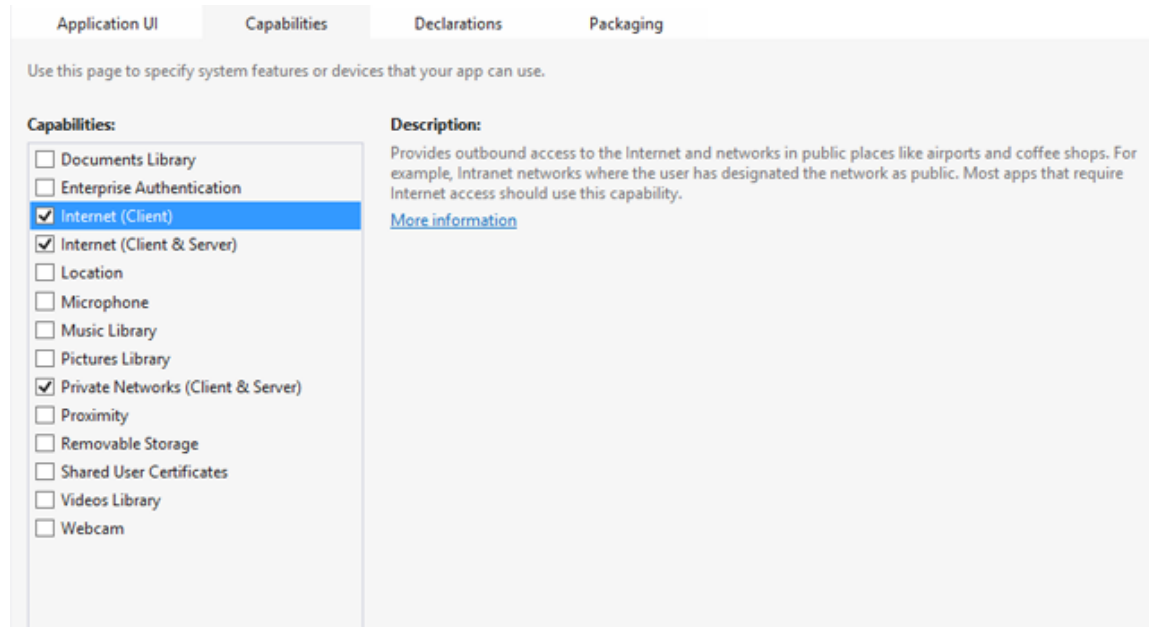

Neglecting to enable the proper capabilities can raise `Ice::SocketException` or, if you are debugging the application in Visual Studio at the time of the exception, it will likely break on `Platform::AccessDeniedException`.

If your application uses SSL, you can bundle certificates with the application by including them in the application's declarations:

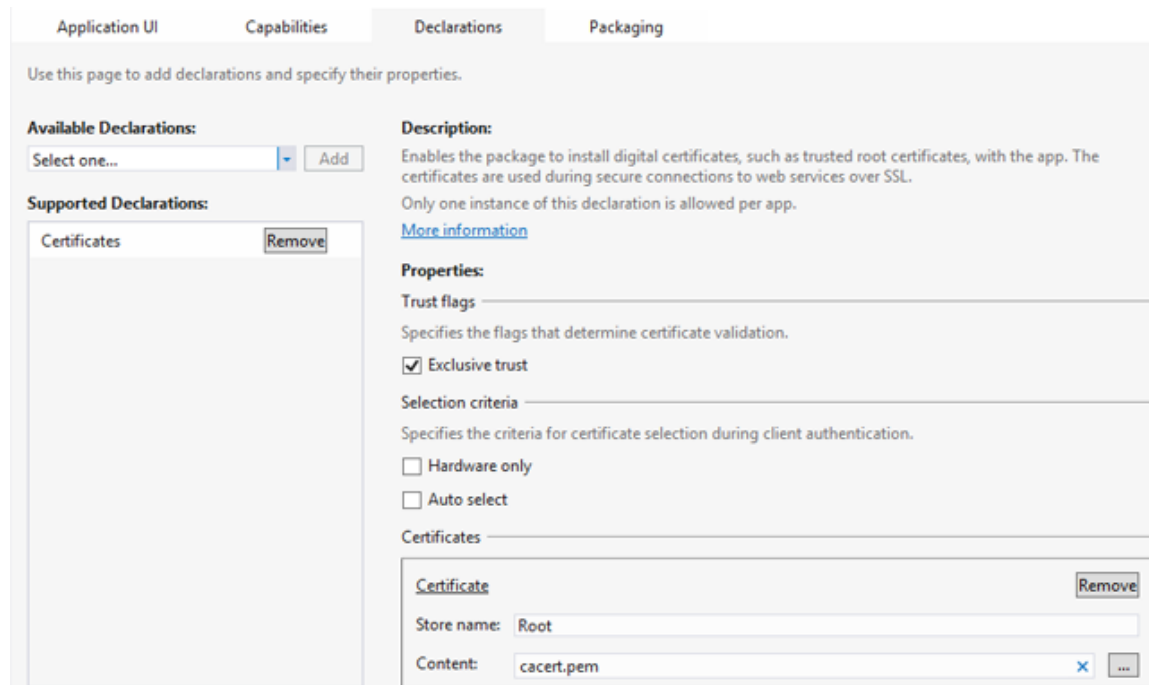

Example

The WinRT sample programs in the Ice distribution use capabilities and declarations.

Java Mapping

Topics

- [Client-Side Slice-to-Java Mapping](#)
- [Server-Side Slice-to-Java Mapping](#)
- [The Java Utility Library](#)

Client-Side Slice-to-Java Mapping

In this section, we present the client-side Slice-to-Java mapping. The client-side Slice-to-Java mapping defines how Slice data types are translated to Java types, and how clients invoke operations, pass parameters, and handle errors. Much of the Java mapping is intuitive. For example, Slice sequences map to Java arrays, so there is essentially nothing new you have to learn in order to use Slice sequences in Java.

The Java API to the Ice run time is fully thread-safe. Obviously, you must still synchronize access to data from different threads. For example, if you have two threads sharing a sequence, you cannot safely have one thread insert into the sequence while another thread is iterating over the sequence. However, you only need to concern yourself with concurrent access to your own data — the Ice run time itself is fully thread safe, and none of the Ice API calls require you to acquire or release a lock before you safely can make the call.

Much of what appears in this chapter is reference material. We suggest that you skim the material on the initial reading and refer back to specific sections as needed. However, we recommend that you read at least the mappings for [exceptions](#), [interfaces](#), and [operations](#) in detail because these sections cover how to call operations from a client, pass parameters, and handle exceptions.



In order to use the Java mapping, you should need no more than the Slice definition of your application and knowledge of the Java mapping rules. In particular, looking through the generated code in order to discern how to use the Java mapping is likely to be inefficient, due to the amount of detail. Of course, occasionally, you may want to refer to the generated code to confirm a detail of the mapping, but we recommend that you otherwise use the material presented here to see how to write your client-side code.



The Ice Package

All of the APIs for the Ice run time are nested in the `Ice` package, to avoid clashes with definitions for other libraries or applications. Some of the contents of the `Ice` package are generated from Slice definitions; other parts of the `Ice` package provide special-purpose definitions that do not have a corresponding Slice definition. We will incrementally cover the contents of the `Ice` package throughout the remainder of the manual.

Topics

- [Java Mapping for Identifiers](#)
- [Java Mapping for Modules](#)
- [Java Mapping for Built-In Types](#)
- [Java Mapping for Enumerations](#)
- [Java Mapping for Structures](#)
- [Java Mapping for Sequences](#)
- [Java Mapping for Dictionaries](#)
- [Java Mapping for Constants](#)
- [Java Mapping for Exceptions](#)
- [Java Mapping for Interfaces](#)
- [Java Mapping for Operations](#)
- [Java Mapping for Classes](#)
- [Java Mapping for Optional Data Members](#)
- [Serializable Objects in Java](#)
- [Customizing the Java Mapping](#)
- [Asynchronous Method Invocation \(AMI\) in Java](#)
- [Using the Slice Compiler for Java](#)
- [Using Slice Checksums in Java](#)
- [Example of a File System Client in Java](#)

Java Mapping for Identifiers

A Slice [identifier](#) maps to an identical Java identifier. For example, the Slice identifier `clock` becomes the Java identifier `clock`. There is one exception to this rule: if a Slice identifier is the same as a Java keyword or is an identifier reserved by the Ice run time (such as `checkedCast`), the corresponding Java identifier is prefixed with an underscore. For example, the Slice identifier `while` is mapped as `_while`.

 You should try to [avoid such identifiers](#) as much as possible.

A single Slice identifier often results in several Java identifiers. For example, for a Slice interface named `Foo`, the generated Java code uses the identifiers `Foo` and `FooPrx` (among others). If the interface has the name `while`, the generated identifiers are `_while` and `whilePrx` (*not* `_whilePrx`), that is, the underscore prefix is applied only to those generated identifiers that actually require it.

See Also

- [Lexical Rules](#)
- [Java Mapping for Modules](#)
- [Java Mapping for Built-In Types](#)
- [Java Mapping for Enumerations](#)
- [Java Mapping for Structures](#)
- [Java Mapping for Sequences](#)
- [Java Mapping for Dictionaries](#)
- [Java Mapping for Constants](#)
- [Java Mapping for Exceptions](#)

Java Mapping for Modules

A Slice `module` maps to a Java package with the same name as the Slice module. The mapping preserves the nesting of the Slice definitions. For example:

Slice
<pre>// Definitions at global scope here... module M1 { // Definitions for M1 here... module M2 { // Definitions for M2 here... }; }; // ... module M1 { // Reopen M1 // More definitions for M1 here... };</pre>

This definition maps to the corresponding Java definitions:

Java
<pre>package M1; // Definitions for M1 here... package M1.M2; // Definitions for M2 here... package M1; // Definitions for M1 here...</pre>

Note that these definitions appear in the appropriate source files; source files for definitions in module `M1` are generated in directory `M1` underneath the top-level directory, and source files for definitions for module `M2` are generated in directory `M1/M2` underneath the top-level directory. You can set the top-level output directory using the `--output-dir` option with `slice2java`.

See Also

- [Modules](#)
- [Using the Slice Compilers](#)
- [Java Mapping for Identifiers](#)
- [Java Mapping for Built-In Types](#)
- [Java Mapping for Enumerations](#)
- [Java Mapping for Structures](#)
- [Java Mapping for Sequences](#)
- [Java Mapping for Dictionaries](#)
- [Java Mapping for Constants](#)
- [Java Mapping for Exceptions](#)

Java Mapping for Built-In Types

The Slice [built-in types](#) are mapped to Java types as follows:

Slice	Java
bool	boolean
byte	byte
short	short
int	int
long	long
float	float
double	double
string	String

Mapping of Slice built-in types to Java.

See Also

- [Basic Types](#)
- [Java Mapping for Identifiers](#)
- [Java Mapping for Modules](#)
- [Java Mapping for Enumerations](#)
- [Java Mapping for Structures](#)
- [Java Mapping for Sequences](#)
- [Java Mapping for Dictionaries](#)
- [Java Mapping for Constants](#)
- [Java Mapping for Exceptions](#)

Java Mapping for Enumerations

A Slice [enumeration](#) maps to the corresponding enumeration in Java. For example:

Slice
<pre>enum Fruit { Apple, Pear, Orange };</pre>

The Java mapping for `Fruit` is shown below:

Java
<pre>public enum Fruit implements java.io.Serializable { Apple, Pear, Orange; public int value(); public static Fruit valueOf(int v); // ... }</pre>

Given the above definitions, we can use enumerated values as follows:

Java
<pre>Fruit f1 = Fruit.Apple; Fruit f2 = Fruit.Orange; if (f1 == Fruit.Apple) // Compare with constant // ... if (f1 == f2) // Compare two enums // ... switch (f2) { // Switch on enum case Fruit.Apple: // ... break; case Fruit.Pear: // ... break; case Fruit.Orange: // ... break; }</pre>

The Java mapping includes two methods of interest. The `value` method returns the Slice value of an enumerator, which is not necessarily the same as its ordinal value. The `valueOf` method translates a Slice value into its corresponding enumerator, or returns `null` if no match is found. Note that the generated class contains a number of other members, which we have not shown. These members are internal to the Ice run time and you must not use them in your application code (because they may change from release to release).

In the `Fruit` definition above, the Slice value of each enumerator matches its ordinal value. This will not be true if we modify the definition to include a custom enumerator value:

Slice

```
enum Fruit { Apple, Pear = 3, Orange };
```

The table below shows the new relationship between ordinal value and Slice value:

Enumerator	Ordinal	Slice
Apple	0	0
Pear	1	3
Orange	2	4



Java enumerated types inherit implicitly from `java.lang.Enum`, which defines methods such as `ordinal` and `compareTo` that operate on the *ordinal* value of an enumerator, not its Slice value.

See Also

- [Enumerations](#)
- [Java Mapping for Structures](#)
- [Java Mapping for Sequences](#)
- [Java Mapping for Dictionaries](#)

Java Mapping for Structures

On this page:

- [Basic Java Mapping for Structures](#)
- [Java Default Constructors for Structures](#)

Basic Java Mapping for Structures

A Slice `structure` maps to a Java class with the same name. For each Slice data member, the Java class contains a corresponding public data member. For example, here is our `Employee` structure once more:

Slice
<pre>struct Employee { long number; string firstName; string lastName; };</pre>

The Slice-to-Java compiler generates the following definition for this structure:

Java

```

public final class Employee implements java.lang.Cloneable,
java.io.Serializable {
    public long number;
    public String firstName;
    public String lastName;

    public Employee {}

    public Employee(long number, String firstName, String lastName) {
        this.number = number;
        this.firstName = firstName;
        this.lastName = lastName;
    }

    public boolean equals(java.lang.Object rhs) {
        // ...
    }
    public int hashCode() {
        // ...
    }

    public java.lang.Object clone()
        java.lang.Object o;
        try
        {
            o = super.clone();
        }
        catch(java.lang.CloneNotSupportedException ex)
        {
            assert false; // impossible
        }
        return o;
    }
}

```

For each data member in the Slice definition, the Java class contains a corresponding public data member of the same name. Note that you can optionally [customize the mapping](#) for data members to use getters and setters instead.

The `equals` member function compares two structures for equality. Note that the generated class also provides the usual `hashCode` and `clone` methods. (`clone` has the default behavior of making a shallow copy.)

Java Default Constructors for Structures

Structures have a default constructor that default-constructs each data member. This means members of primitive type are initialized to the equivalent of zero, and members of reference type are initialized to null. Note that applications must always explicitly initialize members of structure and enumerated types because the Ice run time does not accept null as a legal value for these types.

If you wish to ensure that data members of primitive and enumerated types are initialized to specific values, you can declare default values in your [Slice definition](#). The default constructor initializes each of these data members to its declared value.

Structures also have a second constructor that has one parameter for each data member. This allows you to construct and initialize a class instance in a single statement (instead of first having to construct the instance and then assign to its members).

See Also

- [Structures](#)
- [Java Mapping for Enumerations](#)
- [Java Mapping for Sequences](#)
- [Java Mapping for Dictionaries](#)
- [Customizing the Java Mapping](#)

Java Mapping for Sequences

A Slice [sequence](#) maps to a Java array. This means that the Slice-to-Java compiler does not generate a separate named type for a Slice sequence.

For example:

```

Slice

sequence<Fruit> FruitPlatter;
```

This definition simply corresponds to the Java type `Fruit[]`. Naturally, because Slice sequences are mapped to Java arrays, you can take advantage of all the array functionality provided by Java, such as initialization, assignment, cloning, and the `length` member. For example:

```

Java

Fruit[] platter = { Fruit.Apple, Fruit.Pear };  
assert(platter.length == 2);
```

Alternate mappings for sequence types are also possible.

See Also

- [Sequences](#)
- [Java Mapping for Enumerations](#)
- [Java Mapping for Structures](#)
- [Java Mapping for Dictionaries](#)
- [Customizing the Java Mapping](#)

Java Mapping for Dictionaries

Here is the definition of our `EmployeeMap` once more:

Slice
<code>dictionary<long, Employee> EmployeeMap;</code>

As for sequences, the Java mapping does not create a separate named type for this definition. Instead, the dictionary is simply an instance of the generic type `java.util.Map<K, V>`, where K is the mapping of the key type and V is the mapping of the value type. In the example above, `EmployeeMap` is mapped to the Java type `java.util.Map<Long, Employee>`. The following code demonstrates how to allocate and use an instance of `EmployeeMap`:

Java
<pre>java.util.Map<Long, Employee> em = new java.util.HashMap<Long, Employee>(); Employee e = new Employee(); e.number = 31; e.firstName = "James"; e.lastName = "Gosling"; em.put(e.number, e);</pre>

The type-safe nature of the mapping makes iterating over the dictionary quite convenient:

Java
<pre>for (java.util.Map.Entry<Long, Employee> i : em.entrySet()) { long num = i.getKey(); Employee emp = i.getValue(); System.out.println(emp.firstName + " was employee #" + num); }</pre>

Alternate mappings for dictionary types are also possible.

See Also

- [Dictionaries](#)
- [Java Mapping for Enumerations](#)
- [Java Mapping for Structures](#)
- [Java Mapping for Sequences](#)
- [Customizing the Java Mapping](#)

Java Mapping for Constants

Here are the sample [constant definitions](#) once more:

Slice	
<code>const bool</code>	<code>AppendByDefault = true;</code>
<code>const byte</code>	<code>LowerNibble = 0x0f;</code>
<code>const string</code>	<code>Advice = "Don't Panic!";</code>
<code>const short</code>	<code>TheAnswer = 42;</code>
<code>const double</code>	<code>PI = 3.1416;</code>
<code>enum Fruit { Apple, Pear, Orange };</code>	
<code>const Fruit</code>	<code>FavoriteFruit = Pear;</code>

Here are the generated definitions for these constants:

Java	
<code>public interface AppendByDefault {</code>	<code> boolean value = true;</code>
<code>}</code>	
<code>public interface LowerNibble {</code>	<code> byte value = 15;</code>
<code>}</code>	
<code>public interface Advice {</code>	<code> String value = "Don't Panic!";</code>
<code>}</code>	
<code>public interface TheAnswer {</code>	<code> short value = 42;</code>
<code>}</code>	
<code>public interface PI {</code>	<code> double value = 3.1416;</code>
<code>}</code>	
<code>public interface FavoriteFruit {</code>	<code> Fruit value = Fruit.Pear;</code>
<code>}</code>	

As you can see, each Slice constant is mapped to a Java interface with the same name as the constant. The interface contains a member named `value` that holds the value of the constant.

See Also

- [Constants and Literals](#)
- [Java Mapping for Identifiers](#)

- [Java Mapping for Modules](#)
- [Java Mapping for Built-In Types](#)
- [Java Mapping for Enumerations](#)
- [Java Mapping for Structures](#)
- [Java Mapping for Sequences](#)
- [Java Mapping for Dictionaries](#)
- [Java Mapping for Exceptions](#)

Java Mapping for Exceptions

On this page:

- [Java Mapping for User Exceptions](#)
- [Java Constructors for User Exceptions](#)
- [Java Mapping for Run-Time Exceptions](#)

Java Mapping for User Exceptions

Here is a fragment of the [Slice definition](#) for our world time server once more:

Slice
<pre>exception GenericError { string reason; }; exception BadTimeVal extends GenericError {}; exception BadZoneName extends GenericError {};</pre>

These exception definitions map as follows:

Java
<pre>public class GenericError extends Ice.UserException { public String reason; public GenericError() {} public GenericError(Throwable cause) { super(cause); } public GenericError(String reason) { this.reason = reason; } public GenericError(String reason, Throwable cause) { super(cause); this.reason = reason; } public String ice_name() { return "GenericError"; } }</pre>

```
public class BadTimeVal extends GenericError {
    public BadTimeVal() {}

    public BadTimeVal(Throwable cause)
    {
        super(cause);
    }

    public BadTimeVal(String reason)
    {
        super(reason);
    }

    public BadTimeVal(String reason, Throwable cause)
    {
        super(reason, cause);
    }

    public String ice_name()
    {
        return "BadTimeVal";
    }
}

public class BadZoneName extends GenericError {
    public BadZoneName() {}

    public BadZoneName(Throwable cause)
    {
        super(cause);
    }

    public BadZoneName(String reason)
    {
        super(reason);
    }

    public BadZoneName(String reason, Throwable cause)
    {
        super(reason, cause);
    }

    public String ice_name()
    {
        return "BadZoneName";
    }
}
```

```

    }
}

```

Each Slice exception is mapped to a Java class with the same name. For each data member, the corresponding class contains a public data member. (Obviously, because `BadTimeVal` and `BadZoneName` do not have members, the generated classes for these exceptions also do not have members.) A [JavaBean-style API](#) is used for optional data members, and you can [customize the mapping](#) to force required members to use this same API.

The inheritance structure of the Slice exceptions is preserved for the generated classes, so `BadTimeVal` and `BadZoneName` inherit from `GenericError`.

Each exception also defines the `ice_name` member function, which returns the name of the exception.

All user exceptions are derived from the base class `Ice.UserException`. This allows you to catch all user exceptions generically by installing a handler for `Ice.UserException`. `Ice.UserException`, in turn, derives from `java.lang.Exception`.

`Ice.UserException` implements a `clone` method that is inherited by its derived exceptions, so you can make memberwise shallow copies of exceptions.

Note that the generated exception classes contain other member functions that are not shown. However, those member functions are internal to the Java mapping and are not meant to be called by application code.

Java Constructors for User Exceptions

An exception has a default constructor that default-constructs each data member. This means the constructor initializes members of primitive type to the equivalent of zero, and members of reference type to null. Note that applications must always explicitly initialize members of structure and enumerated types because the Ice run time does not accept null as a legal value for these types.

If you wish to ensure that data members of primitive and enumerated types are initialized to specific values, you can declare default values in your [Slice definition](#). The default constructor initializes each of these data members to its declared value.

If an exception declares or inherits any data members, the generated class provides a second constructor that accepts one parameter for each data member so that you can construct and initialize an instance in a single statement (instead of first having to construct the instance and then assign to its members). For a derived exception, this constructor accepts one argument for each base exception member, plus one argument for each derived exception member, in base-to-derived order.

The generated class may include an additional constructor if the exception declares or inherits any [optional data members](#).

The Slice compiler generates overloaded versions of all constructors that accept a trailing `Throwable` argument for preserving an exception chain.

Java Mapping for Run-Time Exceptions

The Ice run time throws run-time exceptions for a number of pre-defined error conditions. All run-time exceptions directly or indirectly derive from `Ice.LocalException` (which, in turn, derives from `java.lang.RuntimeException`).

`Ice.LocalException` implements a `clone` method that is inherited by its derived exceptions, so you can make memberwise shallow copies of exceptions.

Recall the [inheritance diagram](#) for user and run-time exceptions. By catching exceptions at the appropriate point in the hierarchy, you can handle exceptions according to the category of error they indicate:

- `Ice.LocalException`
This is the root of the inheritance tree for run-time exceptions.
- `Ice.UserException`
This is the root of the inheritance tree for user exceptions.

- `Ice.TimeoutException`
This is the base exception for both operation-invocation and connection-establishment timeouts.
- `Ice.ConnectTimeoutException`
This exception is raised when the initial attempt to establish a connection to a server times out.

For example, a `ConnectTimeoutException` can be handled as `ConnectTimeoutException`, `TimeoutException`, `LocalException`, or `java.lang.Exception`.

You will probably have little need to catch run-time exceptions as their most-derived type and instead catch them as `LocalException`; the fine-grained error handling offered by the remainder of the hierarchy is of interest mainly in the implementation of the Ice run time. Exceptions to this rule are the exceptions related to `facet` and `object` life cycles, which you may want to catch explicitly. These exceptions are `FacetNotExistException` and `ObjectNotExistException`, respectively.

See Also

- [User Exceptions](#)
- [Run-Time Exceptions](#)
- [Java Mapping for Modules](#)
- [Java Mapping for Built-In Types](#)
- [Java Mapping for Enumerations](#)
- [Java Mapping for Structures](#)
- [Java Mapping for Sequences](#)
- [Java Mapping for Dictionaries](#)
- [Java Mapping for Constants](#)
- [Java Mapping for Optional Data Members](#)
- [JavaBean Mapping](#)
- [Facets and Versioning](#)
- [Object Life Cycle](#)

Java Mapping for Interfaces

The mapping of Slice [interfaces](#) revolves around the idea that, to invoke a remote operation, you call a member function on a local class instance that is a [proxy](#) for the remote object. This makes the mapping easy and intuitive to use because making a remote procedure call is no different from making a local procedure call (apart from error semantics).

On this page:

- [Java Classes Generated for an Interface](#)
- [Proxy Interfaces in Java](#)
- [The `Ice.ObjectPrx` Interface in Java](#)
- [Proxy Helpers in Java](#)
- [Using Proxy Methods in Java](#)
- [Object Identity and Proxy Comparison in Java](#)
- [Deserializing Proxies in Java](#)

Java Classes Generated for an Interface

The compiler generates quite a few source files for each Slice interface. In general, for an interface `<interface-name>`, the following source files are created by the compiler:

- `<interface-name>.java`
This source file declares the `<interface-name>` Java interface.
- `<interface-name>Holder.java`
This source file defines a [holder type](#) for the interface.
- `<interface-name>Prx.java`
This source file defines the [proxy interface](#) `<interface-name>Prx`.
- `<interface-name>PrxHelper.java`
This source file defines the [helper type](#) for the interface's proxy.
- `<interface-name>PrxHolder.java`
This source file defines the [holder type](#) for the interface's proxy.
- `__<interface-name>Operations.java`
`__<interface-name>OperationsNC.java`
These source files each define an interface that contains the operations corresponding to the Slice interface.

These are the files that contain code that is relevant to the client side. The compiler also generates a file that is specific to the server side, plus three additional files:

- `__<interface-name>Disp.java`
This file contains the definition of the [server-side skeleton class](#).
- `__<interface-name>Del.java`
- `__<interface-name>DelD.java`
- `__<interface-name>DelM.java`
These files contain code that is internal to the Java mapping; they do not contain any functions of relevance to application programmers.

Proxy Interfaces in Java

On the client side, a Slice interface maps to a Java interface with methods that correspond to the operations on that interface. Consider the following simple interface:

Slice

```
interface Simple {
    void op();
};
```

The Slice compiler generates the following definition for use by the client:

Java

```
public interface SimplePrx extends Ice.ObjectPrx {
    public void op();
    public void op(java.util.Map<String, String> __context);
}
```

As you can see, the compiler generates a *proxy interface* `SimplePrx`. In general, the generated name is `<interface-name>Prx`. If an interface is nested in a module `M`, the generated class is part of package `M`, so the fully-qualified name is `M.<interface-name>Prx`.

In the client's address space, an instance of `SimplePrx` is the local ambassador for a remote instance of the `Simple` interface in a server and is known as a proxy instance. All the details about the server-side object, such as its address, what protocol to use, and its object identity are encapsulated in that instance.

Note that `SimplePrx` inherits from `Ice.ObjectPrx`. This reflects the fact that all Ice interfaces implicitly inherit from `Ice::Object`.

For each operation in the interface, the proxy class has a method of the same name. For the preceding example, we find that the operation `op` has been mapped to the method `op`. Also note that `op` is overloaded: the second version of `op` has a parameter `__context` of type `java.util.Map<String, String>`. This parameter is for use by the Ice run time to store information about how to deliver a request. You normally do not need to use it. (We examine the `__context` parameter in detail in [Request Contexts](#). The parameter is also used by `IceStor` `m`.)

Because all the `<interface-name>Prx` types are interfaces, you cannot instantiate an object of such a type. Instead, proxy instances are always instantiated on behalf of the client by the Ice run time, so client code never has any need to instantiate a proxy directly. The proxy references handed out by the Ice run time are always of type `<interface-name>Prx`; the concrete implementation of the interface is part of the Ice run time and does not concern application code.

A value of `null` denotes the null proxy. The null proxy is a dedicated value that indicates that a proxy points "nowhere" (denotes no object).

The `Ice.ObjectPrx` Interface in Java

All Ice objects have `Object` as the ultimate ancestor type, so all proxies inherit from `Ice.ObjectPrx`. `ObjectPrx` provides a number of methods:

Java

```

package Ice;

public interface ObjectPrx {
    boolean equals(java.lang.Object r);
    Identity ice_getIdentity();
    boolean ice_isA(String __id);
    boolean ice_isA(String __id, java.util.Map<String, String> ctx);
    String[] ice_ids();
    String[] ice_ids(java.util.Map<String, String> ctx);
    String ice_id();
    String ice_id(java.util.Map<String, String> ctx);
    void ice_ping();
    void ice_ping(java.util.Map<String, String> ctx);
    // ...
}

```

The methods behave as follows:

- **equals**

This operation compares two proxies for equality. Note that all aspects of proxies are compared by this operation, such as the communication endpoints for the proxy. This means that, in general, if two proxies compare unequal, that does *not* imply that they denote different objects. For example, if two proxies denote the same Ice object via different transport endpoints, `equals` returns `false` even though the proxies denote the same object.

- **ice_getIdentity**

This method returns the identity of the object denoted by the proxy. The identity of an Ice object has the following Slice type:

Slice

```

module Ice {
    struct Identity {
        string name;
        string category;
    };
};

```

To see whether two proxies denote the same object, first obtain the identity for each object and then compare the identities:

Java

```
Ice.ObjectPrx o1 = ...;
Ice.ObjectPrx o2 = ...;
Ice.Identity i1 = o1.ice_getIdentity();
Ice.Identity i2 = o2.ice_getIdentity();

if (i1.equals(i2))
    // o1 and o2 denote the same object
else
    // o1 and o2 denote different objects
```

- **ice_isA**

The `ice_isA` method determines whether the object denoted by the proxy supports a specific interface. The argument to `ice_isA` is a [type ID](#). For example, to see whether a proxy of type `ObjectPrx` denotes a `Printer` object, we can write:

Java

```
Ice.ObjectPrx o = ...;
if (o != null && o.ice_isA("::Printer"))
    // o denotes a Printer object
else
    // o denotes some other type of object
```

Note that we are testing whether the proxy is null before attempting to invoke the `ice_isA` method. This avoids getting a `NullPointerException` if the proxy is null.

- **ice_ids**

The `ice_ids` method returns an array of strings representing all of the type IDs that the object denoted by the proxy supports.

- **ice_id**

The `ice_id` method returns the type ID of the object denoted by the proxy. Note that the type returned is the type of the actual object, which may be more derived than the static type of the proxy. For example, if we have a proxy of type `BasePrx`, with a static type ID of `::Base`, the return value of `ice_id` might be `::Base`, or it might something more derived, such as `::Derived`.

- **ice_ping**

The `ice_ping` method provides a basic reachability test for the object. If the object can physically be contacted (that is, the object exists and its server is running and reachable), the call completes normally; otherwise, it throws an exception that indicates why the object could not be reached, such as `ObjectNotExistException` or `ConnectTimeoutException`.

The `ice_isA`, `ice_ids`, `ice_id`, and `ice_ping` methods are remote operations and therefore support an additional overloading that accepts a [request context](#). Also note that there are [other methods](#) in `ObjectPrx`, not shown here. These methods provide different ways to dispatch a call and also provide access to an object's [facets](#).

Proxy Helpers in Java

For each Slice interface, apart from the proxy interface, the Slice-to-Java compiler creates a helper class: for an interface `Simple`, the name of the generated helper class is `SimplePrxHelper`. The helper classes contains two methods that support down-casting:

Java

```
public final class SimplePrxHelper
extends Ice.ObjectPrxHelper implements SimplePrx {
    public static SimplePrx checkedCast(Ice.ObjectPrx b) {
        // ...
    }

    public static SimplePrx checkedCast(Ice.ObjectPrx b,
Ice.Context ctx) {
        // ...
    }

    public static SimplePrx uncheckedCast(Ice.ObjectPrx b) {
        // ...
    }

    // ...
}
```

For `checkedCast`, if the passed proxy is for an object of type `Simple`, or a proxy for an object with a type derived from `Simple`, the cast returns a non-null reference to a proxy of type `SimplePrx`; otherwise, if the passed proxy denotes an object of a different type (or if the passed proxy is null), the cast returns a null reference.

Given a proxy of any type, you can use a `checkedCast` to determine whether the corresponding object supports a given type, for example:

Java

```
Ice.ObjectPrx obj = ...;           // Get a proxy from somewhere...

SimplePrx simple = SimplePrxHelper.checkedCast(obj);
if (simple != null)
    // Object supports the Simple interface...
else
    // Object is not of type Simple...
```

Note that a `checkedCast` contacts the server. This is necessary because only the implementation of an object in the server has definite knowledge of the type of an object. As a result, a `checkedCast` may throw a `ConnectTimeoutException` or an `ObjectNotExistException`. (This also explains the need for the helper class: the Ice run time must contact the server, so we cannot use a Java down-cast.)

In contrast, an `uncheckedCast` does not contact the server and unconditionally returns a proxy of the requested type. However, if you do use an `uncheckedCast`, you must be certain that the proxy really does support the type you are casting to; otherwise, if you get it wrong, you will most likely get a run-time exception when you invoke an operation on the proxy. The most likely error for such a type mismatch is `OperationNotExistException`. However, other exceptions, such as a marshaling exception are possible as well. And, if the object happens to have an operation with the correct name, but different parameter types, no exception may be reported at all and you simply end up sending the invocation to an object of the wrong type; that object may do rather nonsensical things. To illustrate this, consider the following two interfaces:

Slice

```
interface Process {
    void launch(int stackSize, int dataSize);
};

// ...

interface Rocket {
    void launch(float xCoord, float yCoord);
};
```

Suppose you expect to receive a proxy for a `Process` object and use an `uncheckedCast` to down-cast the proxy:

Java

```
Ice.ObjectPrx obj = ...; // Get proxy...
ProcessPrx process
= ProcessPrxHelper.uncheckedCast(obj); // No worries...
process.launch(40, 60); // Oops...
```

If the proxy you received actually denotes a `Rocket` object, the error will go undetected by the Ice run time: because `int` and `float` have the same size and because the Ice protocol does not tag data with its type on the wire, the implementation of `Rocket::launch` will simply misinterpret the passed integers as floating-point numbers.

In fairness, this example is somewhat contrived. For such a mistake to go unnoticed at run time, both objects must have an operation with the same name and, in addition, the run-time arguments passed to the operation must have a total marshaled size that matches the number of bytes that are expected by the unmarshaling code on the server side. In practice, this is extremely rare and an incorrect `uncheckedCast` typically results in a run-time exception.

A final warning about down-casts: you must use either a `checkedCast` or an `uncheckedCast` to down-cast a proxy. If you use a Java cast, the behavior is undefined.

Using Proxy Methods in Java

The base proxy class `ObjectPrx` supports a variety of [methods for customizing a proxy](#). Since proxies are immutable, each of these "factory methods" returns a copy of the original proxy that contains the desired modification. For example, you can obtain a proxy configured with a ten second timeout as shown below:

Java

```
Ice.ObjectPrx proxy = communicator.stringToProxy(...);
proxy = proxy.ice_timeout(10000);
```

A factory method returns a new proxy object if the requested modification differs from the current proxy, otherwise it returns the current proxy. With few exceptions, factory methods return a proxy of the same type as the current proxy, therefore it is generally not necessary to repeat a `checkedCast` or `uncheckedCast` after using a factory method. However, a regular cast is still required, as shown in the example below:

Java

```
Ice.ObjectPrx base = communicator.stringToProxy(...);
HelloPrx hello = HelloPrxHelper.checkedCast(base);
hello = (HelloPrx)hello.ice_timeout(10000); # Type is preserved
hello.sayHello();
```

The only exceptions are the factory methods `ice_facet` and `ice_identity`. Calls to either of these methods may produce a proxy for an object of an unrelated type, therefore they return a base proxy that you must subsequently down-cast to an appropriate type.

Object Identity and Proxy Comparison in Java

Proxies provide an `equals` method that compares proxies:

Java

```
interface ObjectPrx {
    boolean equals(java.lang.Object r);
}
```

Note that proxy comparison with `equals` uses *all* of the information in a proxy for the comparison. This means that not only the object identity must match for a comparison to succeed, but other details inside the proxy, such as the protocol and endpoint information, must be the same. In other words, comparison with `equals` tests for *proxy* identity, *not* object identity. A common mistake is to write code along the following lines:

Java

```
Ice.ObjectPrx p1 = ...;           // Get a proxy...
Ice.ObjectPrx p2 = ...;           // Get another proxy...

if (p1.equals(p2)) {
    // p1 and p2 denote different objects           // WRONG!
} else {
    // p1 and p2 denote the same object             // Correct
}
```

Even though `p1` and `p2` differ, they may denote the same Ice object. This can happen because, for example, both `p1` and `p2` embed the same object identity, but each use a different protocol to contact the target object. Similarly, the protocols may be the same, but denote different endpoints (because a single Ice object can be contacted via several different transport endpoints). In other words, if two proxies compare equal with `equals`, we know that the two proxies denote the same object (because they are identical in all respects); however, if two proxies compare unequal with `equals`, we know absolutely nothing: the proxies may or may not denote the same object.

To compare the object identities of two proxies, you can use a helper function in the `Ice.Util` class:

Java

```
package Ice;

public final class Util {
    public static int proxyIdentityCompare(ObjectPrx lhs,
    ObjectPrx rhs);
    public static int proxyIdentityAndFacetCompare(ObjectPrx lhs,
    ObjectPrx rhs);
    // ...
}
```

`proxyIdentityCompare` allows you to correctly compare proxies for identity:

Java

```
Ice.ObjectPrx p1 = ...;           // Get a proxy...
Ice.ObjectPrx p2 = ...;           // Get another proxy...

if (Ice.Util.proxyIdentityCompare(p1, p2) != 0) {
    // p1 and p2 denote different objects           // Correct
} else {
    // p1 and p2 denote the same object           // Correct
}
```

The function returns 0 if the identities are equal, -1 if `p1` is less than `p2`, and 1 if `p1` is greater than `p2`. (The comparison uses `name` as the major and `category` as the minor sort key.)

The `proxyIdentityAndFacetCompare` function behaves similarly, but compares both the identity and the [facet name](#).

In addition, the Java mapping provides two wrapper classes that allow you to wrap a proxy for use as the key of a hashed collection:

Java

```

package Ice;

public class ProxyIdentityKey {
    public ProxyIdentityKey(Ice.ObjectPrx proxy);
    public int hashCode();
    public boolean equals(java.lang.Object obj);
    public Ice.ObjectPrx getProxy();
}

public class ProxyIdentityFacetKey {
    public ProxyIdentityFacetKey(Ice.ObjectPrx proxy);
    public int hashCode();
    public boolean equals(java.lang.Object obj);
    public Ice.ObjectPrx getProxy();
}

```

The constructor caches the identity and the hash code of the passed proxy, so calls to `hashCode` and `equals` can be evaluated efficiently. The `getProxy` method returns the proxy that was passed to the constructor.

As for the comparison functions, `ProxyIdentityKey` only uses the proxy's identity, whereas `ProxyIdentityFacetKey` also includes the facet name.

Deserializing Proxies in Java

Proxy objects implement the `java.io.Serializable` interface that enables serialization of proxies to and from a byte stream. You can use the standard class `java.io.ObjectInputStream` to deserialize all `Slice` types *except* proxies; proxies are a special case because they must be created by a communicator.

To supply a communicator for use in deserializing proxies, an application must use the class `Ice.ObjectInputStream`:

Java

```

package Ice;

public class ObjectInputStream extends java.io.ObjectInputStream
{
    public ObjectInputStream(Communicator communicator,
        java.io.InputStream stream)
        throws java.io.IOException;

    public Communicator getCommunicator();
}

```

The code shown below demonstrates how to use this class:

Java

```
Ice.Communicator communicator = ...
byte[] bytes = ... // data to be deserialized
java.io.ByteArrayInputStream byteStream =
new java.io.ByteArrayInputStream(bytes);
Ice.ObjectInputStream in =
new Ice.ObjectInputStream(communicator, byteStream);
Ice.ObjectPrx proxy = (Ice.ObjectPrx)in.readObject();
```

Ice raises `java.io.IOException` if an application attempts to deserialize a proxy without supplying a communicator.

See Also

- [Interfaces, Operations, and Exceptions](#)
- [Proxies](#)
- [Type IDs](#)
- [Java Mapping for Operations](#)
- [Request Contexts](#)
- [Operations on Object](#)
- [Proxy Methods](#)
- [Facets and Versioning](#)
- [IceStorm](#)

Java Mapping for Operations

On this page:

- [Basic Java Mapping for Operations](#)
- [Normal and `idempotent` Operations in Java](#)
- [Passing Parameters in Java](#)
 - [In-Parameters in Java](#)
 - [Out-Parameters in Java](#)
 - [Null Parameters in Java](#)
 - [Optional Parameters in Java](#)
- [Exception Handling in Java](#)
 - [Exceptions and Out-Parameters](#)

Basic Java Mapping for Operations

As we saw in the [mapping for interfaces](#), for each [operation](#) on an interface, the proxy class contains a corresponding member function with the same name. To invoke an operation, you call it via the proxy. For example, here is part of the definitions for our [file system](#):

```

Slice

module Filesystem {
    interface Node {
        idempotent string name();
    };
    // ...
};
```

The `name` operation returns a value of type `string`. Given a proxy to an object of type `Node`, the client can invoke the operation as follows:

```

Java

NodePrx node = ...;           // Initialize proxy
String name = node.name();    // Get name via RPC
```

This illustrates the typical pattern for receiving return values: return values are returned by reference for complex types, and by value for simple types (such as `int` or `double`).

Normal and `idempotent` Operations in Java

You can add an `idempotent` qualifier to a Slice operation. As far as the signature for the corresponding proxy method is concerned, `idempotent` has no effect. For example, consider the following interface:

```

Slice

interface Example {
    string op1();
    idempotent string op2();
};
```

The proxy interface for this is:

Java

```
public interface ExamplePrx extends Ice.ObjectPrx {
    public String op1();
    public String op2();
}
```

Because `idempotent` affects an aspect of call dispatch, not interface, it makes sense for the two methods to be mapped the same.

Passing Parameters in Java

In-Parameters in Java

The parameter passing rules for the Java mapping are very simple: parameters are passed either by value (for simple types) or by reference (for complex types and type `string`). Semantically, the two ways of passing parameters are identical: it is guaranteed that the value of a parameter will not be changed by the invocation (with some caveats — see [Location Transparency](#)).

Here is an interface with operations that pass parameters of various types from client to server:

Slice

```
struct NumberAndString {
    int x;
    string str;
};

sequence<string> StringSeq;

dictionary<long, StringSeq> StringTable;

interface ClientToServer {
    void op1(int i, float f, bool b, string s);
    void op2(NumberAndString ns, StringSeq ss, StringTable st);
    void op3(ClientToServer* proxy);
};
```

The Slice compiler generates the following proxy for these definitions:

Java

```
public interface ClientToServerPrx extends Ice.ObjectPrx {
    public void op1(int i, float f, boolean b, String s);
    public void op2(NumberAndString ns, String[] ss, java.util.Map st);
    public void op3(ClientToServerPrx proxy);
}
```

Given a proxy to a `ClientToServer` interface, the client code can pass parameters as in the following example:

Java

```

ClientToServerPrx p = ...;           // Get proxy...

p.op1(42, 3.14f, true, "Hello world!"); // Pass simple literals

int i = 42;
float f = 3.14f;
boolean b = true;
String s = "Hello world!";
p.op1(i, f, b, s);                   // Pass simple variables

NumberAndString ns = new NumberAndString();
ns.x = 42;
ns.str = "The Answer";
String[] ss = { "Hello world!" };
java.util.HashMap st = new java.util.HashMap();
st.put(new Long(0), ns);
p.op2(ns, ss, st);                   // Pass complex variables

p.op3(p);                             // Pass proxy

```

Out-Parameters in Java

Java does not have pass-by-reference: parameters are always passed by value. For a function to modify one of its arguments, we must pass a reference (by value) to an object; the called function can then modify the object's contents via the passed reference.

To permit the called function to modify a parameter, the Java mapping uses *holder* classes. For example, for each of the built-in Slice types, such as `int` and `string`, the `Ice` package contains a corresponding holder class. Here are the definitions for the holder classes `Ice.IntHolder` and `Ice.StringHolder`:

Java

```

package Ice;

public final class IntHolder {
    public IntHolder() {}
    public IntHolder(int value) {
        this.value = value;
    }
    public int value;
}

public final class StringHolder {
    public StringHolder() {}
    public StringHolder(String value) {
        this.value = value;
    }
    public String value;
}

```

A holder class has a public `value` member that stores the value of the parameter; the called function can modify the value by assigning to that member. The class also has a default constructor and a constructor that accepts an initial value.

For user-defined types, such as structures, the Slice-to-Java compiler generates a corresponding holder type. For example, here is the generated holder type for the `NumberAndString` structure we defined earlier:

Java

```

public final class NumberAndStringHolder {
    public NumberAndStringHolder() {}

    public NumberAndStringHolder(NumberAndString value) {
        this.value = value;
    }

    public NumberAndString value;
}

```

This looks exactly like the holder classes for the built-in types: we get a default constructor, a constructor that accepts an initial value, and the public `value` member.

Note that holder classes are generated for *every* Slice type you define. For example, for sequences, such as the `FruitPlatter` sequence, the compiler does not generate a special Java `FruitPlatter` type because sequences map to Java arrays. However, the compiler does generate a `FruitPlatterHolder` class, so we can pass a `FruitPlatter` array as an out-parameter.

To pass an out-parameter to an operation, we simply pass an instance of a holder class and examine the `value` member of each out-parameter when the call completes. Here are the same Slice definitions we saw earlier, but this time with all parameters being passed in the `out` direction:

Slice

```

struct NumberAndString {
    int x;
    string str;
};

sequence<string> StringSeq;

dictionary<long, StringSeq> StringTable;

interface ServerToClient {
    void op1(out int i, out float f, out bool b, out string s);
    void op2(out NumberAndString ns,
             out StringSeq ss,
             out StringTable st);
    void op3(out ServerToClient* proxy);
};

```

The Slice compiler generates the following code for these definitions:

Java

```

public interface ClientToServerPrx extends Ice.ObjectPrx {
    public void op1(Ice.IntHolder i, Ice.FloatHolder f,
                   Ice.BooleanHolder b, Ice.StringHolder s);
    public void op2(NumberAndStringHolder ns,
                   StringSeqHolder ss, StringTableHolder st);
    public void op3(ClientToServerPrxHolder proxy);
}

```

Given a proxy to a `ServerToClient` interface, the client code can pass parameters as in the following example:

Java

```

ClientToServerPrx p = ...;           // Get proxy...

Ice.IntHolder ih = new Ice.IntHolder();
Ice.FloatHolder fh = new Ice.FloatHolder();
Ice.BooleanHolder bh = new Ice.BooleanHolder();
Ice.StringHolder sh = new Ice.StringHolder();
p.op1(ih, fh, bh, sh);

NumberAndStringHolder nsh = new NumberAndString();
StringSeqHolder ssh = new StringSeqHolder();
StringTableHolder sth = new StringTableHolder();
p.op2(nsh, ssh, sth);

ServerToClientPrxHolder stcph = new ServerToClientPrxHolder();
p.op3(stcph);

System.out.println(ih.value); // Show one of the values

```

Again, there are no surprises in this code: the various holder instances contain values once the operation invocation completes and the `value` member of each instance provides access to those values.

Null Parameters in Java

Some Slice types naturally have "empty" or "not there" semantics. Specifically, sequences, dictionaries, and strings all can be `null`, but the corresponding Slice types do not have the concept of a null value. To make life with these types easier, whenever you pass `null` as a parameter or return value of type sequence, dictionary, or string, the Ice run time automatically sends an empty sequence, dictionary, or string to the receiver.

This behavior is useful as a convenience feature: especially for deeply-nested data types, members that are sequences, dictionaries, or strings automatically arrive as an empty value at the receiving end. This saves you having to explicitly initialize, for example, every string element in a large sequence before sending the sequence in order to avoid `NullPointerException`. Note that using null parameters in this way does *not* create null semantics for Slice sequences, dictionaries, or strings. As far as the object model is concerned, these do not exist (only *empty* sequences, dictionaries, and strings do). For example, whether you send a string as `null` or as an empty string makes no difference to the receiver: either way, the receiver sees an empty string.

Optional Parameters in Java

The Java mapping uses the generic class `Ice.Optional` to encapsulate **optional parameters**. All Slice types (including `string`) that map to Java reference types use the `Ice.Optional` generic class. To minimize garbage, the mapping also defines several non-generic classes to hold the unboxed primitive types `boolean`, `byte`, `short`, `int`, `long`, `float`, and `double`. For example, an optional `boolean` parameter maps to the `Ice.BooleanOptional` class.

Optional return values and output parameters are mapped to instances of `Ice.Optional` or one of the primitive wrapper classes, depending on their types. For operations with optional *input* parameters, the proxy provides a set of overloaded methods that accept them as optional values, and another set of methods that accept them as required values. Consider the following operation:

Slice

```
optional(1) int execute(optional(2) string params, out optional(3) float
value);
```

The default Java mapping for this operation is shown below:

Java

```
Ice.IntOptional execute(String params, Ice.FloatOptional value, ...);
Ice.IntOptional execute(Ice.Optional<String> params, Ice.FloatOptional
value, ...);
```

For cases where you are passing values for all optional input parameters, it is more efficient to use the required mapping and avoid creating temporary optional values.

A client can invoke `execute` as shown below:

Java

```
Ice.IntOptional i;
Ice.FloatOptional v = new Ice.FloatOptional();

i = proxy.execute("--file log.txt", v); //
required mapping
i = proxy.execute(new Ice.Optional<String>("--file log.txt"), v); //
optional mapping
i = proxy.execute((Ice.Optional<String>)null, v); //
params is unset

if(v.isSet())
    System.out.println("value = " + v.get());
```

Passing `null` where an `Ice.Optional` value is expected is equivalent to passing an `Ice.Optional` instance whose value is unset. For optional parameters of reference types, passing an explicit `null` requires a cast as shown in the last call to `execute` above.

Whereas the mapping for required output parameters uses `Holder` classes to transfer their values from the Ice run time to the caller, the optional mapping uses `Optional` values. When invoking a proxy operation, the client must pass an instance of the appropriate `Optional` type for each output parameter. The Ice run time invokes `clear` on the client's `Optional` value if the server does not supply a value for an output parameter, therefore it is safe to pass an `Optional` instance that already has a value.

A well-behaved program must not assume that an optional parameter always has a value. Calling `get` on an `Optional` instance for which no value is set raises `java.lang.IllegalStateException`.

Exception Handling in Java

Any operation invocation may throw a [run-time exception](#) and, if the operation has an exception specification, may also throw [user exceptions](#). Suppose we have the following simple interface:

Slice

```

exception Tantrum {
    string reason;
};

interface Child {
    void askToCleanUp() throws Tantrum;
};

```

Slice exceptions are thrown as Java exceptions, so you can simply enclose one or more operation invocations in a `try-catch` block:

Java

```

ChildPrx child = ...; // Get child proxy...

try {
    child.askToCleanUp();
} catch (Tantrum t) {
    System.out.write("The child says: ");
    System.out.println(t.reason);
}

```

Typically, you will catch only a few exceptions of specific interest around an operation invocation; other exceptions, such as unexpected run-time errors, will typically be handled by exception handlers higher in the hierarchy. For example:

Java

```

public class Client {
    static void run() {
        ChildPrx child = ...;    // Get child proxy...
        try {
            child.askToCleanUp();
        } catch (Tantrum t) {
            System.out.print("The child says: ");
            System.out.println(t.reason);
            child.scold();        // Recover from error...
        }
        child.praise();          // Give positive feedback...
    }

    public static void
    main(String[] args)
    {
        try {
            // ...
            run();
            // ...
        } catch (Ice.LocalException e) {
            e.printStackTrace();
        } catch (Ice.UserException e) {
            System.err.println(e.getMessage());
        }
    }
}

```

This code handles a specific exception of local interest at the point of call and deals with other exceptions generically. (This is also the strategy we used for our [first simple application](#).)

Exceptions and Out-Parameters

The Ice run time makes no guarantees about the state of out-parameters when an operation throws an exception: the parameter may still have its original value or may have been changed by the operation's implementation in the target object. In other words, for out-parameters, Ice provides the weak exception guarantee [1] but does not provide the strong exception guarantee.



This is done for reasons of efficiency: providing the strong exception guarantee would require more overhead than can be justified.

See Also

- [Operations](#)
- [Java Mapping for Exceptions](#)
- [Java Mapping for Sequences](#)
- [Java Mapping for Interfaces](#)
- [Java Mapping for Optional Data Members](#)
- [Location Transparency](#)

References

1. Sutter, H. 1999. [Exceptional C++: 47 Engineering Puzzles, Programming Problems, and Solutions](#). Reading, MA: Addison-Wesley.

Java Mapping for Classes

On this page:

- [Basic Java Mapping for Classes](#)
- [Operations Interfaces in Java](#)
- [Inheritance from `Ice.Object` in Java](#)
- [Class Data Members in Java](#)
- [Class Operations in Java](#)
- [Class Factories in Java](#)
- [Class Constructors in Java](#)

Basic Java Mapping for Classes

A Slice `class` is mapped to a Java class with the same name. The generated class contains a public data member for each Slice data member (just as for structures and exceptions), and a member function for each operation. Consider the following class definition:

Slice
<pre>class TimeOfDay { short hour; // 0 - 23 short minute; // 0 - 59 short second; // 0 - 59 string format(); // Return time as hh:mm:ss };</pre>

The Slice compiler generates the following code for this definition:

Java
<pre>public interface _TimeOfDayOperations { String format(Ice.Current current); } public interface _TimeOfDayOperationsNC { String format(); } public abstract class TimeOfDay extends Ice.ObjectImpl implements _TimeOfDayOperations, _TimeOfDayOperationsNC { public short hour; public short minute; public short second; public TimeOfDay(); public TimeOfDay(short hour, short minute, short second); // ... }</pre>

There are a number of things to note about the generated code:

1. The compiler generates "operations interfaces" called `_TimeOfDayOperations` and `_TimeOfDayOperationsNC`. These interfaces contain a method for each Slice operation of the class.
2. The generated class `TimeOfDay` inherits (indirectly) from `Ice.Object`. This means that all classes implicitly inherit from `Ice.Object`, which is the ultimate ancestor of all classes. Note that `Ice.Object` is *not* the same as `Ice.ObjectPrx`. In other words, you *cannot* pass a class where a proxy is expected and vice versa. If a class has only data members, but no operations, the compiler generates a non-abstract class.
3. The generated class contains a public member for each Slice data member.
4. The generated class inherits member functions for each Slice operation from the operations interfaces.
5. The generated class contains two constructors.

There is quite a bit to discuss here, so we will look at each item in turn.

Operations Interfaces in Java

The methods in the `<interface-name>Operations` interface have an additional trailing parameter of type `Ice.Current`, whereas the methods in the `<interface-name>OperationsNC` interface lack this additional trailing parameter. The methods without the `Current` parameter simply forward to the methods with a `Current` parameter, supplying a default `Current`. For now, you can ignore this parameter and pretend it does not exist.

If a class has only data members, but no operations, the compiler omits generating the `<interface-name>Operations` and `<interface-name>OperationsNC` interfaces.

Inheritance from `Ice.Object` in Java

Like interfaces, classes implicitly inherit from a common base class, `Ice.Object`. However, as shown in the illustration below, classes inherit from `Ice.Object` instead of `Ice.ObjectPrx` (which is at the base of the inheritance hierarchy for proxies). As a result, you cannot pass a class where a proxy is expected (and vice versa) because the base types for classes and proxies are not compatible.

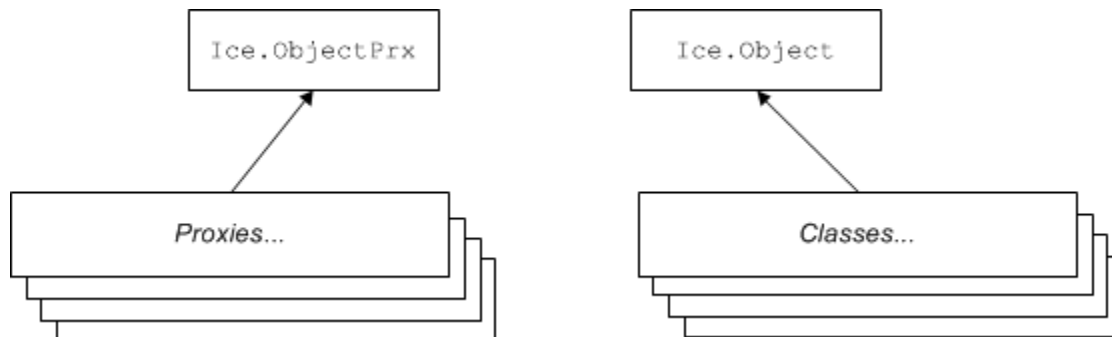

Inheritance from `Ice.ObjectPrx` and `Ice.Object`.

`Ice.Object` contains a number of member functions:

Java

```

package Ice;

public interface Object
{
    boolean ice_isA(String s);
    boolean ice_isA(String s, Current current);

    void ice_ping();
    void ice_ping(Current current);

    String[] ice_ids();
    String[] ice_ids(Current current);

    String ice_id();
    String ice_id(Current current);

    void ice_preMarshal();
    void ice_postUnmarshal();

    DispatchStatus ice_dispatch(Request request,
    DispatchInterceptorAsyncCallback cb);
}

```

The member functions of `Ice.Object` behave as follows:

- `ice_isA`
This function returns `true` if the object supports the given [type ID](#), and `false` otherwise.
- `ice_ping`
As for interfaces, `ice_ping` provides a basic reachability test for the class.
- `ice_ids`
This function returns a string sequence representing all of the [type IDs](#) supported by this object, including `::Ice::Object`.
- `ice_id`
This function returns the actual run-time [type ID](#) for a class. If you call `ice_id` through a reference to a base instance, the returned type id is the actual (possibly more derived) type ID of the instance.
- `ice_preMarshal`
The Ice run time invokes this function prior to marshaling the object's state, providing the opportunity for a subclass to validate its declared data members.
- `ice_postUnmarshal`
The Ice run time invokes this function after unmarshaling an object's state. A subclass typically overrides this function when it needs to perform additional initialization using the values of its declared data members.
- `ice_dispatch`
This function dispatches an incoming request to a servant. It is used in the implementation of [dispatch interceptors](#).

Note that the generated class does not override `hashCode` and `equals`. This means that classes are compared using shallow reference equality, not value equality (as is used for structures).

All Slice classes derive from `Ice.Object` via the `Ice.ObjectImpl` abstract base class. `ObjectImpl` implements the `java.io.Serializable` interface to support Java's [serialization](#) facility. `ObjectImpl` also supplies an implementation of `clone` that returns a shallow memberwise copy.

Class Data Members in Java

By default, data members of classes are mapped exactly as for structures and exceptions: for each data member in the Slice definition, the generated class contains a corresponding public data member. A [JavaBean-style API](#) is used for optional data members, and you can [customize the mapping](#) to force required members to use this same API.

If you wish to restrict access to a data member, you can modify its visibility using the `protected` metadata directive. The presence of this directive causes the Slice compiler to generate the data member with protected visibility. As a result, the member can be accessed only by the class itself or by one of its subclasses. For example, the `TimeOfDay` class shown below has the `protected` metadata directive applied to each of its data members:

Slice
<pre>class TimeOfDay { ["protected"] short hour; // 0 - 23 ["protected"] short minute; // 0 - 59 ["protected"] short second; // 0 - 59 string format(); // Return time as hh:mm:ss };</pre>

The Slice compiler produces the following generated code for this definition:

Java
<pre>public abstract class TimeOfDay extends Ice.ObjectImpl implements _TimeOfDayOperations, _TimeOfDayOperationsNC { protected short hour; protected short minute; protected short second; public TimeOfDay(); public TimeOfDay(short hour, short minute, short second); // ... }</pre>

For a class in which all of the data members are protected, the metadata directive can be applied to the class itself rather than to each member individually. For example, we can rewrite the `TimeOfDay` class as follows:

Slice

```
[ "protected" ] class TimeOfDay {
    short hour;           // 0 - 23
    short minute;        // 0 - 59
    short second;        // 0 - 59
    string format();     // Return time as hh:mm:ss
};
```

Note that you can optionally [customize the mapping](#) for data members to use getters and setters instead.

Class Operations in Java

Operations of classes are mapped to abstract member functions in the generated class. This means that, if a class contains operations (such as the `format` operation of our `TimeOfDay` class), you must provide an implementation of the operation in a class that is derived from the generated class. For example:

Java

```
public class TimeOfDayI extends TimeOfDay {
    public String format(Ice.Current current) {
        DecimalFormat df = (DecimalFormat)DecimalFormat.getInstance();
        df.setMinimumIntegerDigits(2);
        return new String(df.format(hour) + ":" +
            df.format(minute) + ":" +
                df.format(second));
    }
}
```

Class Factories in Java

Having created a class such as `TimeOfDayI`, we have an implementation and we can instantiate the `TimeOfDayI` class, but we cannot receive it as the return value or as an out-parameter from an operation invocation. To see why, consider the following simple interface:

Slice

```
interface Time {
    TimeOfDay get();
};
```

When a client invokes the `get` operation, the Ice run time must instantiate and return an instance of the `TimeOfDay` class. However, `TimeOfDay` is an abstract class that cannot be instantiated. Unless we tell it, the Ice run time cannot magically know that we have created a `TimeOfDayI` class that implements the abstract `format` operation of the `TimeOfDay` abstract class. In other words, we must provide the Ice run time with a factory that knows that the `TimeOfDay` abstract class has a `TimeOfDayI` concrete implementation. The `Ice::CommunicatorI` interface provides us with the necessary operations:

Slice

```

module Ice {
    local interface ObjectFactory {
        Object create(string type);
        void destroy();
    };

    local interface Communicator {
        void addObjectFactory(ObjectFactory factory, string id);
        ObjectFactory findObjectFactory(string id);
        // ...
    };
};

```

To supply the Ice run time with a factory for our `TimeOfDayI` class, we must implement the `ObjectFactory` interface:

Java

```

class ObjectFactory implements Ice.ObjectFactory {
    public Ice.Object create(String type) {
        if (type.equals(M.TimeOfDay.ice_staticId())) {
            return new TimeOfDayI();
        }
        assert(false);
        return null;
    }

    public void destroy() {
        // Nothing to do
    }
}

```

The object factory's `create` method is called by the Ice run time when it needs to instantiate a `TimeOfDay` class. The factory's `destroy` method is called by the Ice run time when its communicator is destroyed.

The `create` method is passed the [type ID](#) of the class to instantiate. For our `TimeOfDay` class, the type ID is `"::M::TimeOfDay"`. Our implementation of `create` checks the type ID: if it matches, the method instantiates and returns a `TimeOfDayI` object. For other type IDs, the method asserts because it does not know how to instantiate other types of objects.

Note that we used the `ice_staticId` method to obtain the type ID rather than embedding a literal string. Using a literal type ID string in your code is discouraged because it can lead to errors that are only detected at run time. For example, if a Slice class or one of its enclosing modules is renamed and the literal string is not changed accordingly, a receiver will fail to unmarshal the object and the Ice run time will raise `NoObjectFactoryException`. By using `ice_staticId` instead, we avoid any risk of a misspelled or obsolete type ID, and we can discover at compile time if a Slice class or module has been renamed.

Given a factory implementation, such as our `ObjectFactory`, we must inform the Ice run time of the existence of the factory:

Java

```
Ice.Communicator ic = ...;
ic.addObjectFactory(new ObjectFactory(), M.TimeOfDay.ice_staticId());
```

Now, whenever the Ice run time needs to instantiate a class with the type ID `"::M::TimeOfDay"`, it calls the `create` method of the registered `ObjectFactory` instance.

The `destroy` operation of the object factory is invoked by the Ice run time when the communicator is destroyed. This gives you a chance to clean up any resources that may be used by your factory. Do not call `destroy` on the factory while it is registered with the communicator — if you do, the Ice run time has no idea that this has happened and, depending on what your `destroy` implementation is doing, may cause undefined behavior when the Ice run time tries to next use the factory.

The run time guarantees that `destroy` will be the last call made on the factory, that is, `create` will not be called concurrently with `destroy`, and `create` will not be called once `destroy` has been called. However, calls to `create` can be made concurrently.

Note that you cannot register a factory for the same type ID twice: if you call `addObjectFactory` with a type ID for which a factory is registered, the Ice run time throws an `AlreadyRegisteredException`.

Finally, keep in mind that if a class has only data members, but no operations, you need not create and register an object factory to transmit instances of such a class. Only if a class has operations do you have to define and register an object factory.

Class Constructors in Java

Classes have a default constructor that default-constructs each data member. This means members of primitive type are initialized to the equivalent of zero, and members of reference type are initialized to null. Note that applications must always explicitly initialize members of structure and enumerated types because the Ice run time does not accept null as a legal value for these types.

If you wish to ensure that data members of primitive and enumerated types are initialized to specific values, you can declare default values in your [Slice definition](#). The default constructor initializes each of these data members to its declared value.

The generated class also contains a second constructor that accepts one argument for each member of the class. This allows you to create and initialize a class in a single statement, for example:

Java

```
TimeOfDayI tod = new TimeOfDayI(14, 45, 00); // 14:45pm
```

For derived classes, the constructor requires an argument for every member of the class, including inherited members. For example, consider the the definition from [Class Inheritance](#) once more:

Slice

```
class TimeOfDay {
    short hour;          // 0 - 23
    short minute;       // 0 - 59
    short second;       // 0 - 59
};

class DateTime extends TimeOfDay {
    short day;          // 1 - 31
    short month;        // 1 - 12
    short year;         // 1753 onwards
};
```

The constructors for the generated classes are as follows:

Java

```

public class TimeOfDay extends Ice.ObjectImpl {
    public TimeOfDay() {}

    public TimeOfDay(short hour, short minute, short second)
    {
        this.hour = hour;
        this.minute = minute;
        this.second = second;
    }

    // ...
}

public class DateTime extends TimeOfDay
{
    public DateTime()
    {
        super();
    }

    public DateTime(short hour, short minute, short second,
                    short day, short month, short year)
    {
        super(hour, minute, second);
        this.day = day;
        this.month = month;
        this.year = year;
    }

    // ...
}

```

If you want to instantiate and initialize a `DateTime` instance, you must either use the default constructor or provide values for all of the data members of the instance, including data members of any base classes.

See Also

- [Classes](#)
- [Class Inheritance](#)
- [Java Mapping for Optional Data Members](#)
- [Type IDs](#)
- [Serializable Objects in Java](#)
- [JavaBean Mapping](#)
- [The Current Object](#)
- [Dispatch Interceptors](#)

Java Mapping for Optional Data Members

On this page:

- [Overview of Java Mapping for Optional Data Members](#)
- [Java Helper Classes for Optional Values](#)

Overview of Java Mapping for Optional Data Members

The Java mapping for [optional data members](#) in Slice classes and [exceptions](#) uses a JavaBean-style API that provides methods to get, set, and clear a member's value, and test whether a value is set. Consider the following Slice definition:

Slice
<pre>class C { string name; optional(2) string alternateName; optional(5) bool active; };</pre>

The generated Java code provides the following API:

Java
<pre>public class C ... { public C(); public C(String name); public C(String name, String alternateName, boolean active); public String name; public String getAlternateName(); public void setAlternateName(String v); public boolean hasAlternateName(); public void clearAlternateName(); public void optionalAlternateName(Ice.Optional<String> v); public Ice.Optional<String> optionalAlternateName(); public boolean getActive(); public void setActive(boolean v); public boolean isActive(); public boolean hasActive(); public void clearActive(); public void optionalActive(Ice.BooleanOptional v); public Ice.BooleanOptional optionalActive(); ... }</pre>

If a class or exception declares any required data members, the generated class includes an overloaded constructor that accepts values for just the required members; optional members remain unset unless their Slice definitions specify a default value. Another overloaded constructor accepts values for all data members.

The `has` method allows you to test whether a member's value has been set, and the `clear` method removes any existing value for a member.



Calling a `get` method when the member's value has not been set raises `java.lang.IllegalStateException`.

The `optional` methods provide an alternate API that uses an `Optional` object to encapsulate the value, as discussed below.

Java Helper Classes for Optional Values

Ice defines the following classes to encapsulate optional values of primitive types:

- `Ice.BooleanOptional`
- `Ice.ByteOptional`
- `Ice.DoubleOptional`
- `Ice.FloatOptional`
- `Ice.IntOptional`
- `Ice.LongOptional`
- `Ice.ShortOptional`

These classes all share the same API for getting, setting, and testing an optional value. We'll use the `IntOptional` class as an example:

```

Java

public class IntOptional
{
    public IntOptional();           // Value is unset
    public IntOptional(int v);     // Value is set
    public IntOptional(IntOptional opt); // Copies the state of the
argument
    public int get();              // Raises IllegalStateException
if unset
    public void set(int v);        // Value is set
    public void set(IntOptional opt); // Copies the state of the
argument
    public boolean isSet();
    public void clear();

    ...
}

```

The `Ice.Optional` generic class encapsulates values of reference types and offers an identical API:

Java

```

public class Optional<T>
{
    public Optional();           // Value is unset
    public Optional(T v);       // Value is set
    public Optional(Optional<T> opt); // Copies the state of the
argument
    public T get();             // Raises IllegalStateException if
unset
    public void set(T v);       // Value is set
    public void set(Optional<T> opt); // Copies the state of the
argument
    public boolean isSet();
    public void clear();

    public static <T> Optional<T> O(T v);
    public static BooleanOptional O(boolean v);
    public static ByteOptional O(byte v);
    public static ShortOptional O(short v);
    public static IntOptional O(int v);
    public static LongOptional O(long v);
    public static FloatOptional O(float v);
    public static DoubleOptional O(double v);

    ...
}

```

To improve the readability of code that creates optional values, the `Optional` class defines overloaded `O` methods that simplify the creation of these objects:

Java

```

import static Ice.Optional.O;

C obj = ...;
Ice.Optional<C> opt = O(obj);

Ice.IntOptional i = O(5);

```

See Also

- [Optional Data Members](#)

Serializable Objects in Java

In Java terminology, a *serializable object* typically refers to an object that implements the `java.io.Serializable` interface and therefore supports serialization to and from a byte stream. All Java classes generated from Slice definitions implement the `java.io.Serializable` interface.

In addition to serializing Slice types, applications may also need to incorporate foreign types into their Slice definitions. Ice allows you to pass Java *serializable objects* directly as operation parameters or as fields of another data type. For example:

```

Slice

["java:serializable:SomePackage.JavaClass"]
sequence<byte> JavaObj;
struct MyStruct {
    int i;
    JavaObj o;
};

interface Example {
    void op(JavaObj inObj, MyStruct s, out JavaObj outObj);
};

```

The generated code for `MyStruct` contains a member `i` of type `int` and a member `o` of type `SomePackage.JavaClass`:

```

Java

public final class MyStruct implements java.lang.Cloneable {
    public int i;
    public SomePackage.JavaClass o;

    // ...
}

```

Similarly, the signature for `op` has parameters of type `JavaClass` and `MyStruct` for the in-parameters, and `Ice.Holder<SomePackage.JavaClass>` for the out-parameter. (Out-parameters are always passed as `Ice.Holder<Class>`.)

```

Java

void op(SomePackage.JavaClass inObj,
        MyStruct s,
        Ice.Holder<SomePackage.JavaClass> outObj);

```

Of course, your client and server code must have an implementation of `JavaClass` that derives from `java.io.Serializable`:

Java

```
package SomePackage;  
  
public class JavaClass implements java.io.Serializable {  
    // ...  
}
```

You can implement this class in any way you see fit — the Ice run time does not place any other requirements on the implementation.

See Also

- [Serializable Objects](#)

Customizing the Java Mapping

You can customize the code that the Slice-to-Java compiler produces by annotating your Slice definitions with [metadata](#). This section describes how metadata influences several aspects of the generated Java code.

On this page:

- [Java Packages](#)
 - [Java Package Configuration Properties](#)
- [Custom Types in Java](#)
 - [Metadata in Java](#)
 - [Defining a Custom Sequence Type in Java](#)
 - [Defining a Custom Dictionary Type in Java](#)
 - [Using Custom Type Metadata in Java](#)
 - [Mapping for Modified Out Parameters in Java](#)
- [JavaBean Mapping](#)
 - [JavaBean Generated Methods](#)
 - [JavaBean Metadata](#)
- [Overriding `serialVersionUID`](#)

Java Packages

By default, the scope of a Slice definition determines the package of its mapped Java construct. A Slice type defined in a module hierarchy is [mapped](#) to a type residing in the equivalent Java package.

There are times when applications require greater control over the packaging of generated Java classes. For instance, a company may have software development guidelines that require all Java classes to reside in a designated package. One way to satisfy this requirement is to modify the Slice module hierarchy so that the generated code uses the required package by default. In the example below, we have enclosed the original definition of `Workflow::Document` in the modules `com::acme` so that the compiler will create the class in the `com.acme` package:

Slice
<pre> module com { module acme { module Workflow { class Document { // ... }; }; }; }; </pre>

There are two problems with this workaround:

1. It incorporates the requirements of an implementation language into the application's interface specification.
2. Developers using other languages, such as C++, are also affected.

The Slice-to-Java compiler provides a better way to control the packages of generated code through the use of [global metadata](#). The example above can be converted as follows:

Slice

```
[[ "java:package:com.acme" ]]
module Workflow {
  class Document {
    // ...
  };
};
```

The global metadata directive `java:package:com.acme` instructs the compiler to generate all of the classes resulting from definitions in this Slice file into the Java package `com.acme`. The net effect is the same: the class for `Document` is generated in the package `com.acme.Workflow`. However, we have addressed the two shortcomings of the first solution by reducing our impact on the interface specification: the Slice-to-Java compiler recognizes the package metadata directive and modifies its actions accordingly, whereas the compilers for other language mappings simply ignore it.

Java Package Configuration Properties

Using global metadata to alter the default package of generated classes has ramifications for the Ice run time when unmarshaling [exceptions](#) and [concrete class types](#). The Ice run time dynamically loads generated classes by translating their Slice type ids into Java class names. For example, the Ice run time translates the Slice type id `::Workflow::Document` into the class name `Workflow.Document`.

However, when the generated classes are placed in a user-specified package, the Ice run time can no longer rely on the direct translation of a Slice type id into a Java class name, and therefore requires additional configuration so that it can successfully locate the generated classes. Two configuration properties are supported:

- `Ice.Package.Module=package`
Associates a top-level Slice module with the package in which it was generated.

 Only top-level module names are allowed; the semantics of global metadata prevent a nested module from being generated into a different package than its enclosing module.

- `Ice.Default.Package=package`
Specifies a default package to use if other attempts to load a class have failed.

The behavior of the Ice run time when unmarshaling an exception or concrete class is described below:

1. Translate the Slice type id into a Java class name and attempt to load the class.
2. If that fails, extract the top-level module from the type id and check for an `Ice.Package` property with a matching module name. If found, prepend the specified package to the class name and try to load the class again.
3. If that fails, check for the presence of `Ice.Default.Package`. If found, prepend the specified package to the class name and try to load the class again.
4. If the class still cannot be loaded, the instance may be [sliced](#).

Continuing our example from the previous section, we can define the following property:

```
Ice.Package.Workflow=com.acme
```

Alternatively, we could achieve the same result with this property:

```
Ice.Default.Package=com.acme
```

Custom Types in Java

One of the more powerful applications of metadata is the ability to tailor the Java mapping for sequence and dictionary types to match the needs of your application.

Metadata in Java

The metadata for specifying a custom type has the following format:

```
java:type:instance-type[:formal-type]
```

The formal type is optional; the compiler uses a default value if one is not defined. The instance type must satisfy an is-A relationship with the formal type: either the same class is specified for both types, or the instance type must be derived from the formal type.

The Slice-to-Java compiler generates code that uses the formal type for all occurrences of the modified Slice definition except when the generated code must instantiate the type, in which case the compiler uses the instance type instead.

The compiler performs no validation on your custom types. Misspellings and other errors will not be apparent until you compile the generated code.

Defining a Custom Sequence Type in Java

Although the default mapping of a sequence type to a native Java array is efficient and typesafe, it is not always the most convenient representation of your data. To use a different representation, specify the type information in a metadata directive, as shown in the following example:

```

Slice
["java:type:java.util.LinkedList<String>"]
sequence<string> StringList;

```

It is your responsibility to use a type parameter for the Java class (`String` in the example above) that is the correct mapping for the sequence's element type.

The compiler requires the formal type to implement `java.util.List<E>`, where `E` is the Java mapping of the element type. If you do not specify a formal type, the compiler uses `java.util.List<E>` by default.

Note that extra care must be taken when defining custom types that contain nested generic types, such as a custom sequence whose element type is also a custom sequence. The Java compiler strictly enforces type safety, therefore any compatibility issues in the custom type metadata will be apparent when the generated code is compiled.

Defining a Custom Dictionary Type in Java

The default instance type for a dictionary is `java.util.HashMap<K, V>`, where `K` is the Java mapping of the key type and `V` is the Java mapping of the value type. If the semantics of a `HashMap` are not suitable for your application, you can specify an alternate type using metadata as shown in the example below:

```

Slice
["java:type:java.util.TreeMap<String, String>"]
dictionary<string, string> StringMap;

```

It is your responsibility to use type parameters for the Java class (`String` in the example above) that are the correct mappings for the dictionary's key and value types.

The compiler requires the formal type to implement `java.util.Map<K, V>`. If you do not specify a formal type, the compiler uses this type by default.

Note that extra care must be taken when defining dictionary types that contain nested generic types, such as a dictionary whose element type is a custom sequence. The Java compiler strictly enforces type safety, therefore any compatibility issues in the custom type metadata will be apparent when the generated code is compiled.

Using Custom Type Metadata in Java

You can define custom type metadata in a variety of situations. The simplest scenario is specifying the metadata at the point of definition:

Slice
<pre>["java:type:java.util.LinkedList<String>"] sequence<string> StringList;</pre>

Defined in this manner, the Slice-to-Java compiler uses `java.util.List<String>` (the default formal type) for all occurrences of `StringList`, and `java.util.LinkedList<String>` when it needs to instantiate `StringList`.

You may also specify a custom type more selectively by defining metadata for a data member, parameter or return value. For instance, the mapping for the original Slice definition might be sufficient in most situations, but a different mapping is more convenient in particular cases. The example below demonstrates how to override the sequence mapping for the data member of a structure as well as for several operations:

Slice
<pre>sequence<string> StringSeq; struct S { ["java:type:java.util.LinkedList<String>"] StringSeq seq; }; interface I { ["java:type:java.util.ArrayList<String>"] StringSeq modifiedReturnValue(); void modifiedInParam(["java:type:java.util.ArrayList<String>"] Stri ngSeq seq); void modifiedOutParam(out ["java:type:java.util.ArrayList<String>"] StringSeq seq); };</pre>

As you might expect, modifying the mapping for an operation's parameters or return value may require the application to manually convert values from the original mapping to the modified mapping. For example, suppose we want to invoke the `modifiedInParam` operation. The signature of its proxy operation is shown below:

Java

```
void modifiedInParam(java.util.List<String> seq, Ice.Current curr)
```

The metadata changes the mapping of the `seq` parameter to `java.util.List`, which is the default formal type. If a caller has a `StringSeq` value in the original mapping, it must convert the array as shown in the following example:

Java

```
String[] seq = new String[2];
seq[0] = "hi";
seq[1] = "there";
IPrx proxy = ...;
proxy.modifiedInParam(java.util.Arrays.asList(seq));
```

Although we specified the instance type `java.util.ArrayList<String>` for the parameter, we are still able to pass the result of `asList` because its return type (`java.util.List<String>`) is compatible with the parameter's formal type declared by the proxy method. In the case of an operation parameter, the instance type is only relevant to a servant implementation, which may need to make assumptions about the actual type of the parameter.

Mapping for Modified Out Parameters in Java

The mapping for an `out` parameter uses a generated "holder" class to convey the [parameter value](#). If you modify the mapping of an `out` parameter, as discussed in the previous section, it is possible that the holder class for the parameter's unmodified type is no longer compatible with the custom type you have specified. The holder class generated for `StringSeq` is shown below:

Java

```
public final class StringSeqHolder
{
    public
    StringSeqHolder()
    {
    }

    public
    StringSeqHolder(String[] value)
    {
        this.value = value;
    }

    public String[] value;
}
```

An `out` parameter of type `StringSeq` would normally map to a proxy method that used `StringSeqHolder` to hold the parameter value. When the parameter is modified, as is the case with the `modifiedOutParam` operation, the Slice-to-Java compiler cannot use `StringSeqHolder` to hold an instance of `java.util.List<String>`, because `StringSeqHolder` is only appropriate for the default mapping to a native array.

As a result, the compiler handles these situations using instances of the generic class `Ice.Holder<T>`, where T is the parameter's formal type. Consider the following example:

```

Slice
sequence<string> StringSeq;

interface I {
    void modifiedOutParam(out ["java:type:java.util.ArrayList<String>"]
StringSeq seq);
};

```

The compiler generates the following mapping for the `modifiedOutParam` proxy method:

```

Java
void modifiedOutParam(Ice.Holder<java.util.List<java.lang.String> > seq,
Ice.Current curr)

```

The formal type of the parameter is `java.util.List<String>`, therefore the holder class becomes `Ice.Holder<java.util.List<String>>`.

JavaBean Mapping

The Java mapping optionally generates JavaBean-style methods for the data members of class, structure, and exception types.

JavaBean Generated Methods

For each data member `val` of type T , the mapping generates the following methods:

```

Java
public T getVal();
public void setVal(T v);

```

The mapping generates an additional method if T is the `bool` type:

```

Java
public boolean isVal();

```

Finally, if T is a sequence type with an element type E , two methods are generated to provide direct access to elements:

```

Java
public E getVal(int index);
public void setVal(int index, E v);

```

Note that these element methods are only generated for sequence types that use the default mapping.

The Slice-to-Java compiler considers it a fatal error for a JavaBean method of a class data member to conflict with a declared operation of the class. In this situation, you must rename the operation or the data member, or disable the generation of JavaBean methods for the data member in question.

JavaBean Metadata

The JavaBean methods are generated for a data member when the member or its enclosing type is annotated with the `java:getset` meta data. The following example demonstrates both styles of usage:

Slice
<pre>sequence<int> IntSeq; class C { ["java:getset"] int i; double d; }; ["java:getset"] struct S { bool b; string str; }; ["java:getset"] exception E { IntSeq seq; };</pre>

JavaBean methods are generated for all members of struct `S` and exception `E`, but for only one member of class `C`. Relevant portions of the generated code are shown below:

Java
<pre>public class C extends Ice.ObjectImpl { ... public int i; public int getI() { return i; } public void setI(int _i) {</pre>

```
        i = _i;
    }

    public double d;
}

public final class S implements java.lang.Cloneable
{
    public boolean b;

    public boolean
    getB()
    {
        return b;
    }

    public void
    setB(boolean _b)
    {
        b = _b;
    }

    public boolean
    isB()
    {
        return b;
    }

    public String str;

    public String
    getStr()
    {
        return str;
    }

    public void
    setStr(String _str)
    {
        str = _str;
    }

    ...
}

public class E extends Ice.UserException
{
    ...

    public int[] seq;
```



```
public int[]
getSeq()
{
    return seq;
}

public void
setSeq(int[] _seq)
{
    seq = _seq;
}

public int
getSeq(int _index)
{
    return seq[_index];
}

public void
setSeq(int _index, int _val)
{
    seq[_index] = _val;
}
```

```

    ...
}

```

Overriding `serialVersionUID`

The Slice-to-Java compiler computes a default value for the `serialVersionUID` member of Slice classes, exceptions and structures. If you prefer, you can override this value using the `java:serialVersionUID` metadata, as shown below:

```

Slice
["java:serialVersionUID:571254925"]
struct Identity
{
    ...
};

```

The specified value will be used in place of the default value in the generated code:

```

Java
public class Identity
{
    ...

    public static final long serialVersionUID = 571254925L;
}

```

By using this metadata, the application assumes responsibility for updating the UID whenever changes to the Slice definition affect the serializable state of the type.

See Also

- [Metadata](#)
- [Java Mapping for Modules](#)
- [Java Mapping for Operations](#)
- [Class Inheritance Semantics](#)

Asynchronous Method Invocation (AMI) in Java

Asynchronous Method Invocation (AMI) is the term used to describe the client-side support for the asynchronous programming model. AMI supports both oneway and twoway requests, but unlike their synchronous counterparts, AMI requests never block the calling thread. When a client issues an AMI request, the Ice run time hands the message off to the local transport buffer or, if the buffer is currently full, queues the request for later delivery. The application can then continue its activities and poll or wait for completion of the invocation, or receive a callback when the invocation completes.

AMI is transparent to the server: there is no way for the server to tell whether a client sent a request synchronously or asynchronously.

 As of version 3.4, Ice provides a new API for asynchronous method invocation. This page describes the new API. Note that the old API is deprecated and will be removed in a future release.

On this page:

- [Basic Asynchronous API in Java](#)
 - [Asynchronous Proxy Methods in Java](#)
 - [Asynchronous Exception Semantics in Java](#)
- [AsyncResult Class in Java](#)
- [Polling for Completion in Java](#)
- [Generic Completion Callbacks in Java](#)
- [Sharing State Between begin_ and end_ Methods in Java](#)
- [Type-Safe Completion Callbacks in Java](#)
- [Asynchronous Oneway Invocations in Java](#)
- [Flow Control in Java](#)
- [Asynchronous Batch Requests in Java](#)
- [Concurrency Semantics for AMI in Java](#)
- [AMI Limitations in Java](#)

Basic Asynchronous API in Java

Consider the following simple Slice definition:

Slice

```

module Demo {
    interface Employees {
        string getName(int number);
    };
};

```

Asynchronous Proxy Methods in Java

Besides the synchronous proxy methods, `slice2java` generates the following asynchronous proxy methods:

Java

```
public interface EmployeesPrx extends Ice.ObjectPrx
{
    // ...

    public Ice.AsyncResult begin_getName(int number);
    public Ice.AsyncResult begin_getName(int number,
    java.util.Map<String, String> __ctx);

    public String end_getName(Ice.AsyncResult __result);
}
```

i Four additional overloads of `begin_getName` are generated for use with [generic completion callbacks](#) and [type-safe completion callbacks](#).

As you can see, the single `getName` operation results in `begin_getName` and `end_getName` methods. (The `begin_` method is overloaded so you can pass a [per-invocation context](#).)

- The `begin_getName` method sends (or queues) an invocation of `getName`. This method does not block the calling thread.
- The `end_getName` method collects the result of the asynchronous invocation. If, at the time the calling thread calls `end_getName`, the result is not yet available, the calling thread blocks until the invocation completes. Otherwise, if the invocation completed some time before the call to `end_getName`, the method returns immediately with the result.

A client could call these methods as follows:

Java

```
EmployeesPrx e = ...;
Ice.AsyncResult r = e.begin_getName(99);

// Continue to do other things here...

String name = e.end_getName(r);
```

Because `begin_getName` does not block, the calling thread can do other things while the operation is in progress.

Note that `begin_getName` returns a value of type `AsyncResult`. This value contains the state that the Ice run time requires to keep track of the asynchronous invocation. You must pass the `AsyncResult` that is returned by the `begin_` method to the corresponding `end_` method.

The `begin_` method has one parameter for each in-parameter of the corresponding Slice operation. Similarly, the `end_` method has one out-parameter for each out-parameter of the corresponding Slice operation (plus the `AsyncResult` parameter). For example, consider the following operation:

Slice

```
double op(int inp1, string inp2, out bool outp1, out long outp2);
```

The `begin_op` and `end_op` methods have the following signature:

Java

```
Ice.AsyncResult begin_op(int inp1, String inp2);
Ice.AsyncResult begin_op(int inp1, String inp2,
    java.util.Map<String, String> __ctx);
double end_op(Ice.BooleanHolder outp1, Ice.LongHolder outp2,
    Ice.AsyncResult r);
```

Asynchronous Exception Semantics in Java

If an invocation raises an exception, the exception is thrown by the `end_` method, even if the actual error condition for the exception was encountered during the `begin_` method ("on the way out"). The advantage of this behavior is that all exception handling is located with the code that calls the `end_` method (instead of being present twice, once where the `begin_` method is called, and again where the `end_` method is called).

There is one exception to the above rule: if you destroy the communicator and then make an asynchronous invocation, the `begin_` method throws `CommunicatorDestroyedException`. This is necessary because, once the run time is finalized, it can no longer throw an exception from the `end_` method.

The only other exception that is thrown by the `begin_` and `end_` methods is `java.lang.IllegalArgumentException`. This exception indicates that you have used the API incorrectly. For example, the `begin_` method throws this exception if you call an operation that has a return value or out-parameters on a oneway proxy. Similarly, the `end_` method throws this exception if you use a different proxy to call the `end_` method than the proxy you used to call the `begin_` method, or if the `AsyncResult` you pass to the `end_` method was obtained by calling the `begin_` method for a different operation.

AsyncResult Class in Java

The `AsyncResult` that is returned by the `begin_` method encapsulates the state of the asynchronous invocation:

Java

```
public class AsyncResult {
    public Communicator getCommunicator();
    public Connection getConnection();
    public ObjectPrx getProxy();
    public String getOperation();

    public boolean isCompleted();
    public void waitForCompleted();

    public boolean isSent();
    public void waitForSent();

    public void throwLocalException();

    public boolean sentSynchronously();
}
```

The methods have the following semantics:

- `Communicator getCommunicator()`
This method returns the communicator that sent the invocation.
- `Connection getConnection()`
This method returns the connection that was used for the invocation. Note that, for typical asynchronous proxy invocations, this method returns a nil value because the possibility of automatic retries means the connection that is currently in use could change unexpectedly. The `getConnection` method only returns a non-nil value when the `AsyncResult` object is obtained by calling `begin_flushBatchRequests` on a `Connection` object.
- `ObjectPrx getProxy()`
This method returns the proxy that was used to call the `begin_` method, or nil if the `AsyncResult` object was not obtained via an asynchronous proxy invocation.
- `String getOperation()`
This method returns the name of the operation.
- `boolean isCompleted()`
This method returns true if, at the time it is called, the result of an invocation is available, indicating that a call to the `end_` method will not block the caller. Otherwise, if the result is not yet available, the method returns false.
- `void waitForCompleted()`
This method blocks the caller until the result of an invocation becomes available.
- `boolean isSent()`
When you call the `begin_` method, the Ice run time attempts to write the corresponding request to the client-side transport. If the transport cannot accept the request, the Ice run time queues the request for later transmission. `isSent` returns true if, at the time it is called, the request has been written to the local transport (whether it was initially queued or not). Otherwise, if the request is still queued or an exception occurred before the request could be sent, `isSent` returns false.
- `void waitForSent()`
This method blocks the calling thread until a request has been written to the client-side transport, or an exception occurs. After `waitForSent` returns, `isSent` returns true if the request was successfully written to the client-side transport, or false if an exception occurred. In the case of a failure, you can call the corresponding `end_` method or `throwLocalException` to obtain the exception.
- `void throwLocalException()`
This method throws the local exception that caused the invocation to fail. If no exception has occurred yet, `throwLocalException` does nothing.
- `boolean sentSynchronously()`
This method returns true if a request was written to the client-side transport without first being queued. If the request was initially queued, `sentSynchronously` returns false (independent of whether the request is still in the queue or has since been written to the client-side transport).

Polling for Completion in Java

The `AsyncResult` methods allow you to poll for call completion. Polling is useful in a variety of cases. As an example, consider the following simple interface to transfer files from client to server:

Slice
<pre>interface FileTransfer { void send(int offset, ByteSeq bytes); };</pre>

The client repeatedly calls `send` to send a chunk of the file, indicating at which offset in the file the chunk belongs. A naïve way to transmit a

file would be along the following lines:

Java

```
FileHandle file = open(...);
FileTransferPrx ft = ...;
int chunkSize = ...;
int offset = 0;
while (!file.eof()) {
    byte[] bs;
    bs = file.read(chunkSize); // Read a chunk
    ft.send(offset, bs);      // Send the chunk
    offset += bs.length;
}
```

This works, but not very well: because the client makes synchronous calls, it writes each chunk on the wire and then waits for the server to receive the data, process it, and return a reply before writing the next chunk. This means that both client and server spend much of their time doing nothing — the client does nothing while the server processes the data, and the server does nothing while it waits for the client to send the next chunk.

Using asynchronous calls, we can improve on this considerably:

Java

```

FileHandle file = open(...);
FileTransferPrx ft = ...;
int chunkSize = ...;
int offset = 0;

LinkedList<Ice.AsyncResult> results = new LinkedList<Ice.AsyncResult>();
int numRequests = 5;

while (!file.eof()) {
    byte[] bs;
    bs = file.read(chunkSize);

    // Send up to numRequests + 1 chunks asynchronously.
    Ice.AsyncResult r = ft.begin_send(offset, bs);
    offset += bs.length;

    // Wait until this request has been passed to the transport.
    r.waitForSent();
    results.add(r);

    // Once there are more than numRequests, wait for the least
    // recent one to complete.
    while (results.size() > numRequests) {
        Ice.AsyncResult r = results.getFirst();
        results.removeFirst();
        r.waitForCompleted();
    }
}

// Wait for any remaining requests to complete.
while (results.size() > 0) {
    Ice.AsyncResult r = results.getFirst();
    results.removeFirst();
    r.waitForCompleted();
}

```

With this code, the client sends up to `numRequests + 1` chunks before it waits for the least recent one of these requests to complete. In other words, the client sends the next request without waiting for the preceding request to complete, up to the limit set by `numRequests`. In effect, this allows the client to "keep the pipe to the server full of data": the client keeps sending data, so both client and server continuously do work.

Obviously, the correct chunk size and value of `numRequests` depend on the bandwidth of the network as well as the amount of time taken by the server to process each request. However, with a little testing, you can quickly zoom in on the point where making the requests larger or queuing more requests no longer improves performance. With this technique, you can realize the full bandwidth of the link to within a percent or two of the theoretical bandwidth limit of a native socket connection.

Generic Completion Callbacks in Java

The `begin_` method is overloaded to allow you to provide completion callbacks. Here are the corresponding methods for the `getName` operation:

Java

```
Ice.AsyncResult begin_getName(int number, Ice.Callback __cb);

Ice.AsyncResult begin_getName(int number,
                               java.util.Map<String, String> __ctx,
                               Ice.Callback __cb);
```

The second version of `begin_getName` lets you override the default context. Following the in-parameters, the `begin_` method accepts a parameter of type `Ice.Callback`, which is a callback class with a `completed` method that you must provide. The Ice run time invokes the `completed` method when an asynchronous operation completes. For example:

Java

```
public class MyCallback extends Ice.Callback
{
    public void completed(Ice.AsyncResult r)
    {
        EmployeesPrx e = (EmployeesPrx)r.getProxy();
        try {
            String name = e.end_getName(r);
            System.out.println("Name is: " + name);
        } catch (Ice.LocalException ex) {
            System.err.println("Exception is: " + ex);
        }
    }
}
```

Note that your callback class must derive from `Ice.Callback`. The implementation of your callback method must call the `end_` method. The proxy for the call is available via the `getProxy` method on the `AsyncResult` that is passed by the Ice run time. The return type of `getProxy` is `Ice.ObjectPrx`, so you must down-cast the proxy to its correct type.

Your callback method should catch and handle any exceptions that may be thrown by the `end_` method. If an operation can throw user exceptions, this means that you need an additional catch handler for `Ice.UserException` (or catch all possible user exceptions explicitly). If you allow an exception to escape from the callback method, the Ice run time produces a log entry by default and ignores the exception. (You can disable the log message by setting the property `Ice.Warn.AMICallback` to zero.)

To inform the Ice run time that you want to receive a callback for the completion of the asynchronous call, you pass the callback instance to the `begin_` method:

Java

```
EmployeesPrx e = ...;

MyCallback cb = new MyCallback();
e.begin_getName(99, cb);
```

This is often written using an anonymous class instead:

```

Java

EmployeesPrx e = ...;

e.begin_getName(
    99,
    new Ice.AsyncCallback()
    {
        public void completed(Ice.AsyncResult r)
        {
            EmployeesPrx p = (EmployeesPrx)r.getProxy();
            try {
                String name = p.end_getName(r);
                System.out.println("Name is: " + name);
            } catch (Ice.LocalException ex) {
                System.err.println("Exception: " + ex);
            }
        }
    });

```

An anonymous class is useful particularly for callbacks that do only a small amount of work because the code that starts the call and the code that processes the results are physically close together.

Sharing State Between `begin_` and `end_` Methods in Java

It is common for the `end_` method to require access to some state that is established by the code that calls the `begin_` method. As an example, consider an application that asynchronously starts a number of operations and, as each operation completes, needs to update different user interface elements with the results. In this case, the `begin_` method knows which user interface element should receive the update, and the `end_` method needs access to that element.

Assuming that we have a `Widget` class that designates a particular user interface element, you could pass different widgets by storing the widget to be used as a member of your callback class:

Java

```
public class MyCallback extends Ice.AsyncCallback
{
    public MyCallback(Widget w)
    {
        _w = w;
    }

    private Widget _w;

    public void completed(Ice.AsyncResult r)
    {
        EmployeesPrx e = (EmployeesPrx)r.getProxy();
        try {
            String name = e.end_getName(r);
            _w.writeString(name);
        } catch (Ice.LocalException ex) {
            System.err.println("Exception is: " + ex);
        }
    }
}
```

For this example, we assume that widgets have a `writeString` method that updates the relevant UI element.

When you call the `begin_` method, you pass the appropriate callback instance to inform the `end_` method how to update the display:

Java

```
EmployeesPrx e = ...;
Widget widget1 = ...;
Widget widget2 = ...;

// Invoke the getName operation with different widget callbacks.
e.begin_getName(99, new MyCallback(widget1));
e.begin_getName(24, new MyCallback(widget2));
```

The callback class provides a simple and effective way for you to pass state between the point where an operation is invoked and the point where its results are processed. Moreover, if you have a number of operations that share common state, you can pass the same callback instance to multiple invocations. (If you do this, your callback methods may need to use synchronization.)

Type-Safe Completion Callbacks in Java

The generic callback API is not entirely type-safe:

- You must down-cast the return value of `getProxy` to the correct proxy type before you can call the `end_` method.
- You must call the correct `end_` method to match the operation called by the `begin_` method.
- You must remember to catch exceptions when you call the `end_` method; if you forget to do this, you will not know that the operation failed.

`slice2java` generates an additional type-safe API that takes care of these chores for you. To use type-safe callbacks, you must implement a callback class that provides two callback methods:

- a `response` method that is called if the operation succeeds
- an `exception` method that is called if the operation raises an exception

Your callback class must derive from the base class that is generated by `slice2java`. The name of this base class is `<module>.Callback_<interface>_<operation>`. Here is a callback class for an invocation of the `getName` operation:

```

Java
public class MyCallback extends Demo.Callback_Employees_getName
{
    public void response(String name)
    {
        System.out.println("Name is: " + name);
    }

    public void exception(Ice.LocalException ex)
    {
        System.err.println("Exception is: " + ex);
    }
}

```

The `response` callback parameters depend on the operation signature. If the operation has non-void return type, the first parameter of the `response` callback is the return value. The return value (if any) is followed by a parameter for each out-parameter of the corresponding Slice operation, in the order of declaration.

The `exception` callback is invoked if the invocation fails because of an Ice run time exception. If the Slice operation can also raise user exceptions, your callback class must supply an additional overloading of `exception` that accepts an argument of type `Ice.UserException`.

The proxy methods are overloaded to accept this callback instance:

```

Java
Ice.AsyncResult begin_getName(int number,
                             Callback_Employees_getName __cb);

Ice.AsyncResult begin_getName(int number,
                             java.util.Map<String, String> __ctx,
                             Callback_Employees_getName __cb);

```

You pass the callback to an invocation as you would with the generic API:

Java

```

EmployeesPrx e = ...;

MyCallback cb = new MyCallback();
e.begin_getName(99, cb);

```

Asynchronous Oneway Invocations in Java

You can invoke operations via oneway proxies asynchronously, provided the operation has `void` return type, does not have any out-parameters, and does not raise user exceptions. If you call the `begin_` method on a oneway proxy for an operation that returns values or raises a user exception, the `begin_` method throws an `IllegalArgumentException`.

The callback methods looks exactly as for a twoway invocation. For the generic API, the Ice run time does not call the `completed` callback method unless the invocation raised an exception during the `begin_` method ("on the way out"). For the type-safe API, the `response` method is never called.

Flow Control in Java

Asynchronous method invocations never block the thread that calls the `begin_` method: the Ice run time checks to see whether it can write the request to the local transport. If it can, it does so immediately in the caller's thread. (In that case, `AsyncResult.sentSynchronously` returns true.) Alternatively, if the local transport does not have sufficient buffer space to accept the request, the Ice run time queues the request internally for later transmission in the background. (In that case, `AsyncResult.sentSynchronously` returns false.)

This creates a potential problem: if a client sends many asynchronous requests at the time the server is too busy to keep up with them, the requests pile up in the client-side run time until, eventually, the client runs out of memory.

The API provides a way for you to implement flow control by counting the number of requests that are queued so, if that number exceeds some threshold, the client stops invoking more operations until some of the queued operations have drained out of the local transport.

For the [generic API](#), you can override the `sent` method:

Java

```

public class MyCallback extends Ice.AsyncCallback
{
    public void completed(Ice.AsyncResult r)
    {
        // ...
    }

    public void sent(Ice.AsyncResult r)
    {
        // ...
    }
}

```

You inform the Ice run time that you want to be informed when a call has been passed to the local transport as usual:

Java

```
e.begin_getName(99, new MyCallback());
```

If the Ice run time can immediately pass the request to the local transport, it does so and invokes the `sent` method from the thread that calls the `begin_` method. On the other hand, if the run time has to queue the request, it calls the `sent` method from a different thread once it has written the request to the local transport. In addition, you can find out from the `AsyncResult` that is returned by the `begin_` method whether the request was sent synchronously or was queued, by calling `sentSynchronously`.

For the **generic API**, the `sent` method has the following signature:

Java

```
void sent(Ice.AsyncResult r);
```

For the **type-safe API**, the signature is:

Java

```
void sent(boolean sentSynchronously);
```

For the generic API, you can find out whether the request was sent synchronously by calling `sentSynchronously` on the `AsyncResult`. For the type-safe API, the boolean `sentSynchronously` parameter provides the same information.

The `sent` methods allow you to limit the number of queued requests by counting the number of requests that are queued and decrementing the count when the Ice run time passes a request to the local transport.

Asynchronous Batch Requests in Java

Applications that send **batched requests** can either flush a batch explicitly or allow the Ice run time to flush automatically. The proxy method `ice_flushBatchRequests` performs an immediate flush using the synchronous invocation model and may block the calling thread until the entire message can be sent. Ice also provides asynchronous versions of this method so you can flush batch requests asynchronously.

`begin_ice_flushBatchRequests` and `end_ice_flushBatchRequests` are proxy methods that flush any batch requests queued by that proxy.

In addition, similar methods are available on the communicator and the `Connection` object that is returned by `AsyncResult.getConnection`. These methods flush batch requests sent via the same communicator and via the same connection, respectively.

Concurrency Semantics for AMI in Java

The Ice run time always invokes your callback methods from a separate thread, with one exception: it calls the `sent` callback from the thread calling the `begin_` method if the request could be sent synchronously. In the `sent` callback, you know which thread is calling the callback by looking at the `sentSynchronously` member or parameter.

AMI Limitations in Java

AMI invocations cannot be sent using collocated optimization. If you attempt to invoke an AMI operation using a proxy that is configured to use **collocation optimization**, the Ice run time raises `CollocationOptimizationException` if the servant happens to be collocated; the request is sent normally if the servant is not collocated. You can disable this optimization if necessary.

See Also

- [Request Contexts](#)
- [Batched Invocations](#)
- [Location Transparency](#)

Using the Slice Compiler for Java

On this page:

- [slice2java Command-Line Options](#)
- [Slice2Java Ant Task](#)
 - [Execution Environment](#)
 - [Dependencies](#)
 - [Parameters](#)
 - [Nested Elements](#)
 - [Using the Task](#)

slice2java Command-Line Options

The Slice-to-Java compiler, `slice2java`, offers the following command-line options in addition to the standard options:

- `--tie`
Generate [tie classes](#).
- `--impl`
Generate sample implementation files. This option will not overwrite an existing file.
- `--impl-tie`
Generate sample implementation files using [tie classes](#). This option will not overwrite an existing file.
- `--checksum CLASS`
Generate [checksums](#) for Slice definitions into the class `CLASS`. The given class name may optionally contain a package specifier. The generated class contains checksums for all of the Slice files being translated by this invocation of the compiler. For example, the command below causes `slice2java` to generate the file `Checksums.java` containing the checksums for the Slice definitions in `File1.ice` and `File2.ice`:

```
slice2java --checksum Checksums File1.ice File2.ice
```

- `--stream`
Generate [streaming helper functions](#) for Slice types.
- `--meta META`
Define the global metadata directive `META`. Using this option is equivalent to defining the global metadata `META` in each named Slice file, as well as in any file included by a named Slice file. Global metadata specified with `--meta` overrides any corresponding global metadata directive in the files being compiled.

Slice2Java Ant Task

The Ice for Java build system makes extensive use of an ant task named `Slice2JavaTask` to automate the execution of the Slice-to-Java compiler. This task may also be useful for Ice developers. The task and its supporting classes reside in the JAR file named `ant-ice.jar`, which normally can be found in the `lib` subdirectory of your Ice installation.

Execution Environment

The `Slice2JavaTask` must be able to locate and spawn the `slice2java` executable. You can specify the directory of your Ice installation by defining the `ice.home` ant property or the `ICE_HOME` environment variable, in which case the task assumes that the Slice compiler's executable is located in the `bin` subdirectory of the specified installation directory. For example, if `ICE_HOME` is set to `/opt/Ice` on Linux, the task assumes that the executable path name is `/opt/Ice/bin/slice2java`. Furthermore, the task also configures its shared library search path (if necessary for your platform) to ensure the executable can resolve its library dependencies.

If both `ice.home` and `ICE_HOME` are defined, `ice.home` takes precedence. If neither are defined, the task assumes that the executable

can already be found in your `PATH` and that your shared library search path is configured correctly.

Finally, you can use a task parameter to specify the full path name of the Slice compiler. Again, the task assumes that your shared library search path is configured correctly.

Dependencies

The task minimizes recompilation by maintaining dependencies between Slice files. The task stores this information in a file named `.depend` in the output directory and updates these dependencies after each invocation. (You can specify a different name for this file using a task parameter.)

Note that the task does not maintain dependencies between a Slice file and its generated Java source files. Consequently, removing the generated Java source files does not cause the task to recompile a Slice file. In fact, the task only compiles a Slice file when any of the following conditions are true:

- no dependency file exists
- no dependency information is found for the Slice file
- the modification time of the Slice file is later than the modification time of the dependency file
- the Slice file includes another Slice file that is eligible for compilation

The simplest way to force the task to recompile all of your Slice files is to remove the dependency file.

Parameters

The task supports the parameters listed in the following table:

Attribute	Description	Required
<code>checksum</code>	Specifies the name of a class to contain the Slice checksums.	No
<code>dependencyfile</code>	Specifies an alternate name for the dependency file. If you specify a relative filename, it is relative to ant's current working directory. If not specified, the task uses the name <code>.depend</code> by default. If you do not define this attribute and <code>outputdir</code> is defined, the task creates the <code>.depend</code> file in the designated output directory (see <code>outputdir</code>).	No
<code>ice</code>	Instructs the Slice compiler to permit symbols that have the reserved prefix <code>Ice</code> . This parameter is used in the Ice build system and is not normally required by applications.	No
<code>outputdir</code>	Specifies the directory in which the Slice compiler generates Java source files. If not specified, the task uses ant's current working directory.	No
<code>stream</code>	Indicates whether to generate streaming support . If not specified, streaming support is not generated.	No
<code>tie</code>	Indicates whether to generate tie classes . If not specified, tie classes are not generated.	No

translator	Specifies the path name of the Slice compiler. If not specified, the task locates the Slice compiler in its execution environment .	No
------------	---	----

For the flag parameters (`ice`, `stream`, and `tie`), legal positive values are `on`, `true`, or `yes`; negative values are `off`, `false`, or `no`.

Nested Elements

Several Slice compiler options must be defined as nested elements of the task:

- define**
 Defines a preprocessor macro. The element supports the attributes `name` and (optionally) `value`, as shown below:

```
<define name="FOO">
<define name="BAR" value="5">
```

 These definitions are equivalent to the command-line options `-DFOO` and `-DBAR=5`, respectively.
- fileset**
 Specifies the set of Slice files to be compiled. Refer to the ant documentation of its `FileSet` type for more information.
- includepath**
 Specifies the include file search path for Slice files. In ant terminology, `includepath` is a *path-like structure*. Refer to the ant documentation of its `Path` type for more information.
- meta**
 Defines a global metadata directive in each Slice file as well as in each included Slice file. The element supports `name` and `value` attributes.

Using the Task

Define the following `taskdef` element in your project's build file to enable the task:

```
Ant
```

```
<taskdef name="slice2java" classname="Slice2JavaTask"/>
```

This configuration assumes that `ant-ice.jar` is already present in ant's class path. Alternatively, you can specify the JAR explicitly as follows:

```
Ant
```

```
<taskdef name="slice2java" classpath="/opt/Ice/lib/ant-ice.jar"
  classname="Slice2JavaTask"/>
```

Once activated, you can invoke the task to translate your Slice files. The example shown below is a simplified version of the ant project for the `hello` demo:

Ant

```

<target name="generate" depends="init">
  <mkdir dir="generated"/>
  <slice2java outputdir="generated">
    <fileset dir="." includes="Hello.ice"/>
  </slice2java>
</target>

<target name="compile" depends="generate">
  <mkdir dir="classes"/>
  <javac srcdir=".:generated" destdir="classes">
    <exclude name="generated/**"/>
    ...
  </javac>
</target>

<target name="all" depends="compile"/>

<target name="clean">
  <delete dir="generated"/>
  <delete dir="classes"/>
</target>

```

This project demonstrates some practices that we encourage you to adopt in your own projects. First, it is helpful to keep the source files generated by the Slice compiler separate from your application's source files by dedicating an output directory for the exclusive use of the Slice compiler. Doing so helps to minimize confusion and makes it easier to configure a source-code management system to ignore generated files.

Next, we also recommend that you include a `clean` target in your ant project that removes this output directory. Assuming that the dependency file (`.depend`) is also stored in this directory, removing the output directory is an efficient way to clean up your project's source tree and guarantees that all of your Slice files are recompiled in the next build.

Finally, after seeing the `exclude` element in the invocation of `javac` you might infer that the generated code was not being compiled, but the presence of the output directory in the `srcdir` attribute ensures that the generated code is included in the build. The purpose of the `exclude` element is to prevent ant from including the generated files twice in its target list.

See Also

- [Using the Slice Compilers](#)
- [Using Slice Checksums in Java](#)
- [Tie Classes in Java](#)
- [Streaming Interfaces](#)

Using Slice Checksums in Java

The Slice compilers can optionally generate [checksums](#) of Slice definitions. For `slice2java`, the `--checksum` option causes the compiler to generate a new Java class that adds checksums to a static map member. Assuming we supplied the option `--checksum Checksums` to `slice2java`, the generated class `Checksums.java` looks like this:

```

Java
public class Checksums {
    public static java.util.Map<String, String> checksums;
}

```

The read-only map `checksums` is initialized automatically prior to first use; no action is required by the application.

In order to verify a server's checksums, a client could simply compare the dictionaries using the `equals` method. However, this is not feasible if it is possible that the server might return a superset of the client's checksums. A more general solution is to iterate over the local checksums as demonstrated below:

```

Java
java.util.Map<String, String> serverChecksums = ...
java.util.Iterator<java.util.Map.Entry<String, String>> i =
    Checksums.checksums.entrySet().iterator();
while(i.hasNext()) {
    java.util.Map.Entry<String, String> e = i.next();
    String id = e.getKey();
    String checksum = e.getValue();
    String serverChecksum = serverChecksums.get(id);
    if (serverChecksum == null) {
        // No match found for type id!
    } else if (!checksum.equals(serverChecksum)) {
        // Checksum mismatch!
    }
}
}

```

In this example, the client first verifies that the server's dictionary contains an entry for each Slice type ID, and then it proceeds to compare the checksums.

See Also

- [Slice Checksums](#)

Example of a File System Client in Java

This page presents the source code for a very simple client to access a server that implements the file system we developed in [Slice for a Simple File System](#). The Java code hardly differs from the code you would write for an ordinary Java program. This is one of the biggest advantages of using Ice: accessing a remote object is as easy as accessing an ordinary, local Java object. This allows you to put your effort where you should, namely, into developing your application logic instead of having to struggle with arcane networking APIs. This is true for the [server side](#) as well, meaning that you can develop distributed applications easily and efficiently.

We now have seen enough of the client-side Java mapping to develop a complete client to access our remote file system. For reference, here is the Slice definition once more:

```

Slice

module Filesystem {
    interface Node {
        idempotent string name();
    };

    exception GenericError {
        string reason;
    };

    sequence<string> Lines;

    interface File extends Node {
        idempotent Lines read();
        idempotent void write(Lines text) throws GenericError;
    };

    sequence<Node*> NodeSeq;

    interface Directory extends Node {
        idempotent NodeSeq list();
    };
};
```

To exercise the file system, the client does a recursive listing of the file system, starting at the root directory. For each node in the file system, the client shows the name of the node and whether that node is a file or directory. If the node is a file, the client retrieves the contents of the file and prints them.

The body of the client code looks as follows:

```

Java

import Filesystem.*;

public class Client {

    // Recursively print the contents of directory "dir" in
    // tree fashion. For files, show the contents of each file.
    // The "depth" parameter is the current nesting level
    // (for indentation).
```

```

static void
listRecursive(DirectoryPrx dir, int depth)
{
    char[] indentCh = new char[++depth];
    java.util.Arrays.fill(indentCh, '\t');
    String indent = new String(indentCh);

    NodePrx[] contents = dir.list();

    for (int i = 0; i < contents.length; ++i) {
        DirectoryPrx subdir
= DirectoryPrxHelper.checkedCast(contents[i]);
        FilePrx file = FilePrxHelper.uncheckedCast(contents[i]);
        System.out.println(indent + contents[i].name() +
            (subdir != null ? " (directory):" : " (file):"));
        if (subdir != null) {
            listRecursive(subdir, depth);
        } else {
            String[] text = file.read();
            for (int j = 0; j < text.length; ++j)
                System.out.println(indent + "\t" + text[j]);
        }
    }
}

public static void
main(String[] args)
{
    int status = 0;
    Ice.Communicator ic = null;
    try {
        // Create a communicator
        //
        ic = Ice.Util.initialize(args);

        // Create a proxy for the root directory
        //
        Ice.ObjectPrx base
= ic.stringToProxy("RootDir:default -p 10000");
        if (base == null)
            throw new RuntimeException("Cannot create proxy");

        // Down-cast the proxy to a Directory proxy
        //
        DirectoryPrx rootDir = DirectoryPrxHelper.checkedCast(base);
        if (rootDir == null)
            throw new RuntimeException("Invalid proxy");

        // Recursively list the contents of the root directory

```

```
        //
        System.out.println("Contents of root directory:");
        listRecursive(rootDir, 0);
    } catch (Ice.LocalException e) {
        e.printStackTrace();
        status = 1;
    } catch (Exception e) {
        System.err.println(e.getMessage());
        status = 1;
    }
    if (ic != null) {
        // Clean up
        //
        try {
            ic.destroy();
        } catch (Exception e) {
            System.err.println(e.getMessage());
            status = 1;
        }
    }
    System.exit(status);
```

```

    }
}

```

After importing the `Filesystem` package, the `Client` class defines two methods: `listRecursive`, which is a helper function to print the contents of the file system, and `main`, which is the main program. Let us look at `main` first:

1. The structure of the code in `main` follows what we saw in [Hello World Application](#). After initializing the run time, the client creates a proxy to the root directory of the file system. For this example, we assume that the server runs on the local host and listens using the default protocol (TCP/IP) at port 10000. The object identity of the root directory is known to be `RootDir`.
2. The client down-casts the proxy to `DirectoryPrx` and passes that proxy to `listRecursive`, which prints the contents of the file system.

Most of the work happens in `listRecursive`. The function is passed a proxy to a directory to list, and an indent level. (The indent level increments with each recursive call and allows the code to print the name of each node at an indent level that corresponds to the depth of the tree at that node.) `listRecursive` calls the `list` operation on the directory and iterates over the returned sequence of nodes:

1. The code does a `checkedCast` to narrow the `Node` proxy to a `Directory` proxy, as well as an `uncheckedCast` to narrow the `Node` proxy to a `File` proxy. Exactly one of those casts will succeed, so there is no need to call `checkedCast` twice: if the `Node` is a `Directory`, the code uses the `DirectoryPrx` returned by the `checkedCast`; if the `checkedCast` fails, we know that the `Node` is a `File` and, therefore, an `uncheckedCast` is sufficient to get a `FilePrx`.
In general, if you know that a down-cast to a specific type will succeed, it is preferable to use an `uncheckedCast` instead of a `checkedCast` because an `uncheckedCast` does not incur any network traffic.
2. The code prints the name of the file or directory and then, depending on which cast succeeded, prints "(directory)" or "(file)" following the name.
3. The code checks the type of the node:
 - If it is a directory, the code recurses, incrementing the indent level.
 - If it is a file, the code calls the `read` operation on the file to retrieve the file contents and then iterates over the returned sequence of lines, printing each line.

Assume that we have a small file system consisting of two files and a directory as follows:

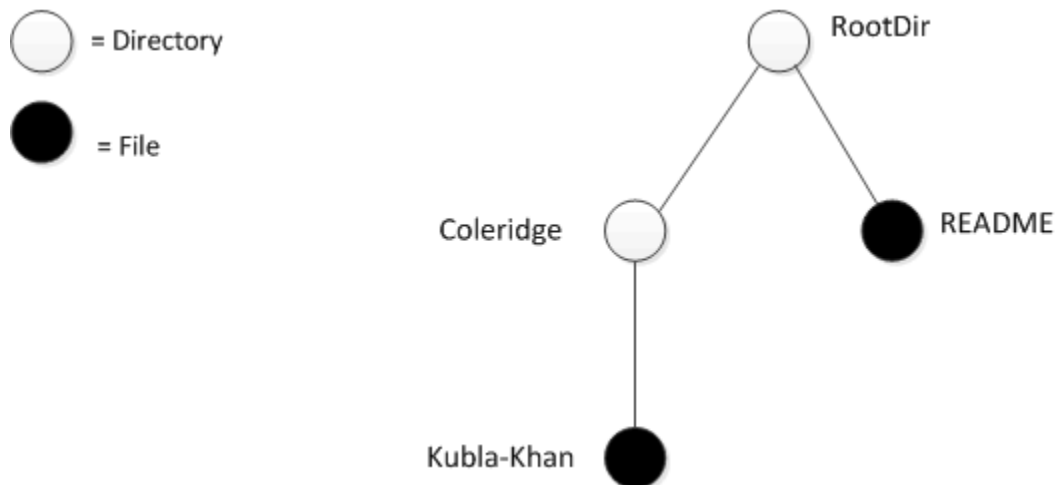

A small file system.

The output produced by the client for this file system is:

```
Contents of root directory:
```

```
  README (file):
```

```
    This file system contains a collection of poetry.
```

```
  Coleridge (directory):
```

```
    Kubla_Khan (file):
```

```
      In Xanadu did Kubla Khan
```

```
      A stately pleasure-dome decree:
```

```
      Where Alph, the sacred river, ran
```

```
      Through caverns measureless to man
```

```
      Down to a sunless sea.
```

Note that, so far, our client (and server) are not very sophisticated:

- The protocol and address information are hard-wired into the code.
- The client makes more remote procedure calls than strictly necessary; with minor redesign of the Slice definitions, many of these calls can be avoided.

We will see how to address these shortcomings in our discussions of [IceGrid](#) and [object life cycle](#).

See Also

- [Hello World Application](#)
- [Slice for a Simple File System](#)
- [Example of a File System Server in Java](#)
- [Object Life Cycle](#)
- [IceGrid](#)

Server-Side Slice-to-Java Mapping

The mapping for Slice data types to Java is identical on the client side and server side. This means that everything in [Client-Side Slice-to-Java Mapping](#) also applies to the server side. However, for the server side, there are a few additional things you need to know — specifically how to:

- Initialize and finalize the server-side run time
- Implement servants
- Pass parameters and throw exceptions
- Create servants and register them with the Ice run time

Because the mapping for Slice data types is identical for clients and servers, the server-side mapping only adds a few additional mechanisms to the client side: a small API to initialize and finalize the run time, plus a few rules for how to derive servant classes from skeletons and how to register servants with the server-side run time.

Although the examples we present are very simple, they accurately reflect the basics of writing an Ice server. Of course, for more sophisticated servers, you will be using [additional APIs](#), for example, to improve performance or scalability. However, these APIs are all described in Slice, so, to use these APIs, you need not learn any Java mapping rules beyond those we described here.

Topics

- [The Server-Side main Method in Java](#)
- [Server-Side Java Mapping for Interfaces](#)
- [Parameter Passing in Java](#)
- [Raising Exceptions in Java](#)
- [Tie Classes in Java](#)
- [Object Incarnation in Java](#)
- [Asynchronous Method Dispatch \(AMD\) in Java](#)
- [Example of a File System Server in Java](#)

The Server-Side main Method in Java

On this page:

- [A Basic main Method in Java](#)
- [The `Ice.Application` Class in Java](#)
 - [Using `Ice.Application` on the Client Side in Java](#)
 - [Catching Signals in Java](#)
 - [Ice.Application and Properties in Java](#)
 - [Limitations of `Ice.Application` in Java](#)

A Basic main Method in Java

The main entry point to the Ice run time is represented by the local Slice interface `Ice::Communicator`. As for the client side, you must initialize the Ice run time by calling `Ice.Util.initialize` before you can do anything else in your server. `Ice.Util.initialize` returns a reference to an instance of an `Ice.Communicator`:

Java

```

public class Server {
    public static void
    main(String[] args)
    {
        int status = 0;
        Ice.Communicator ic = null;
        try {
            ic = Ice.Util.initialize(args);
            // ...
        } catch (Exception e) {
            e.printStackTrace();
            status = 1;
        }
        // ...
    }
}

```

`Ice.Util.initialize` accepts the argument vector that is passed to `main` by the operating system. The function scans the argument vector for any [command-line options](#) that are relevant to the Ice run time, but does not remove those options. If anything goes wrong during initialization, `initialize` throws an exception.

 The semantics of Java arrays prevents `Ice.Util.initialize` from modifying the size of the argument vector. However, [another overloading](#) of `Ice.Util.initialize` is provided that allows the application to obtain a new argument vector with the Ice options removed.

Before leaving your `main` function, you *must* call `Communicator.destroy`. The `destroy` operation is responsible for finalizing the Ice run time. In particular, `destroy` waits for any operation implementations that are still executing in the server to complete. In addition, `destroy` ensures that any outstanding threads are joined with and reclaims a number of operating system resources, such as file descriptors and memory. Never allow your `main` function to terminate without calling `destroy` first; doing so has undefined behavior.

The general shape of our server-side `main` function is therefore as follows:

Java

```

public class Server {
    public static void
    main(String[] args)
    {
        int status = 0;
        Ice.Communicator ic = null;
        try {
            ic = Ice.Util.initialize(args);
            // ...
        } catch (Exception e) {
            e.printStackTrace();
            status = 1;
        }
        if (ic != null) {
            try {
                ic.destroy();
            } catch (Exception e) {
                e.printStackTrace();
                status = 1;
            }
        }
        System.exit(status);
    }
}

```

Note that the code places the call to `Ice.Util.initialize` into a `try` block and takes care to return the correct exit status to the operating system. Also note that an attempt to destroy the communicator is made only if the initialization succeeded.

The `Ice.Application` Class in Java

The preceding structure for the `main` function is so common that Ice offers a class, `Ice.Application`, that encapsulates all the correct initialization and finalization activities. The synopsis of the class is as follows (with some detail omitted for now):

Java

```

package Ice;

public enum SignalPolicy { HandleSignals, NoSignalHandling }

public abstract class Application {
    public Application()

        public Application(SignalPolicy signalPolicy)

        public final int main(String appName, String[] args)

        public final int main(String appName, String[] args,
String configFile)

        public final int main(String appName, String[] args,
InitializationData initData)

        public abstract int run(String[] args)

        public static String appName()

        public static Communicator communicator()

        // ...
}

```

The intent of this class is that you specialize `Ice.Application` and implement the abstract `run` method in your derived class. Whatever code you would normally place in `main` goes into the `run` method instead. Using `Ice.Application`, our program looks as follows:

Java

```
public class Server extends Ice.Application {
    public int
    run(String[] args)
    {
        // Server code here...

        return 0;
    }

    public static void
    main(String[] args)
    {
        Server app = new Server();
        int status = app.main("Server", args);
        System.exit(status);
    }
}
```

Note that `Application.main` is overloaded: you can pass an optional file name or an `InitializationData` structure.

If you pass a [configuration file name](#) to `main`, the property settings in this file are overridden by settings in a file identified by the `ICE_CONFIG` environment variable (if defined). Property settings supplied on the [command line](#) take precedence over all other settings.

The `Application.main` function does the following:

1. It installs an exception handler for `java.lang.Exception`. If your code fails to handle an exception, `Application.main` prints the name of an exception and a stack trace on `System.err` before returning with a non-zero return value.
2. It initializes (by calling `Ice.Util.initialize`) and finalizes (by calling `Communicator.destroy`) a communicator. You can get access to the communicator for your server by calling the static `communicator` accessor.
3. It scans the argument vector for options that are relevant to the Ice run time and removes any such options. The argument vector that is passed to your `run` method therefore is free of Ice-related options and only contains options and arguments that are specific to your application.
4. It provides the name of your application via the static `appName` member function. The return value from this call is the first argument in the call to `Application.main`, so you can get at this name from anywhere in your code by calling `Ice.Application.appName` (which is usually required for error messages). In the example above, the return value from `appName` would be `Server`.
5. It installs a shutdown hook that properly shuts down the communicator.
6. It installs a [per-process logger](#) if the application has not already configured one. The per-process logger uses the value of the `Ice.ProgramName` property as a prefix for its messages and sends its output to the standard error channel. An application can also specify an [alternate logger](#).

Using `Ice.Application` ensures that your program properly finalizes the Ice run time, whether your server terminates normally or in response to an exception. We recommend that all your programs use this class; doing so makes your life easier. In addition, `Ice.Application` also provides features for signal handling and configuration that you do not have to implement yourself when you use this class.

Using `Ice.Application` on the Client Side in Java

You can use `Ice.Application` for your clients as well: simply implement a class that derives from `Ice.Application` and place the client code into its `run` method. The advantage of this approach is the same as for the server side: `Ice.Application` ensures that the communicator is destroyed correctly even in the presence of exceptions.

Catching Signals in Java

The simple server we developed in [Hello World Application](#) had no way to shut down cleanly: we simply interrupted the server from the command line to force it to exit. Terminating a server in this fashion is unacceptable for many real-life server applications: typically, the server has to perform some cleanup work before terminating, such as flushing database buffers or closing network connections. This is particularly important on receipt of a signal or keyboard interrupt to prevent possible corruption of database files or other persistent data.

Java does not provide direct support for signals, but it does allow an application to register a *shutdown hook* that is invoked when the JVM is shutting down. There are several events that trigger JVM shutdown, such as a call to `System.exit` or an interrupt signal from the operating system, but the shutdown hook is not provided with the reason for the shut down.

`Ice.Application` registers a shutdown hook by default, allowing you to cleanly terminate your application prior to JVM shutdown.

```

Java

package Ice;

public abstract class Application {
    // ...

    synchronized public static void destroyOnInterrupt()
    synchronized public static void shutdownOnInterrupt()
    synchronized public static void setInterruptHook(Thread t)
    synchronized public static void defaultInterrupt()
    synchronized public static boolean interrupted()
}

```

The functions behave as follows:

- `destroyOnInterrupt`
This function installs a shutdown hook that calls `destroy` on the communicator. This is the default behavior.
- `shutdownOnInterrupt`
This function installs a shutdown hook that calls `shutdown` on the communicator.
- `setInterruptHook`
This function installs a custom shutdown hook that takes responsibility for performing whatever action is necessary to terminate the application. Refer to the Java documentation for `Runtime.addShutdownHook` for more information on the semantics of shutdown hooks.
- `defaultInterrupt`
This function removes the shutdown hook.
- `interrupted`
This function returns true if the shutdown hook caused the communicator to shut down, false otherwise. This allows us to distinguish intentional shutdown from a forced shutdown that was caused by the JVM. This is useful, for example, for logging purposes.

By default, `Ice.Application` behaves as if `destroyOnInterrupt` was invoked, therefore our server `main` function requires no change to ensure that the program terminates cleanly on JVM shutdown. (You can disable this default shutdown hook by passing the enumerator `NoSignalHandling` to the constructor. In that case, shutdown is not intercepted and terminates the VM.) However, we add a diagnostic to report the occurrence, so our `main` function now looks like:

Java

```
public class Server extends Ice.Application {
    public int
    run(String[] args)
    {
        // Server code here...

        if (interrupted())
            System.err.println(appName() + ": terminating");

        return 0;
    }

    public static void
    main(String[] args)
    {
        Server app = new Server();
        int status = app.main("Server", args);
        System.exit(status);
    }
}
```

During the course of normal execution, the JVM does not terminate until all non-daemon threads have completed. If an interrupt occurs, the JVM ignores the status of active threads and terminates as soon as it has finished invoking all of the installed shutdown hooks.

In a subclass of `Ice.Application`, the default shutdown hook (as installed by `destroyOnInterrupt`) blocks until the application's main thread completes. As a result, an interrupted application may not terminate successfully if the main thread is blocked. For example, this can occur in an interactive application when the main thread is waiting for console input. To remedy this situation, the application can install an alternate shutdown hook that does not wait for the main thread to finish:

Java

```

public class Server extends Ice.Application {
    class ShutdownHook extends Thread {
        public void
        run()
        {
            try
            {
                communicator().destroy();
            }
            catch(Ice.LocalException ex)
            {
                ex.printStackTrace();
            }
        }
    }

    public int
    run(String[] args)
    {
        setInterruptHook(new ShutdownHook());

        // ...
    }
}

```

After replacing the default shutdown hook using `setInterruptHook`, the JVM will terminate as soon as the communicator is destroyed.

Ice.Application and Properties in Java

Apart from the functionality shown in this section, `Ice.Application` also takes care of initializing the Ice run time with property values. [Properties](#) allow you to configure the run time in various ways. For example, you can use properties to control things such as the thread pool size or port number for a server. The `main` function of `Ice.Application` is overloaded; the second version allows you to specify the name of a configuration file that will be processed during initialization.

Limitations of Ice.Application in Java

`Ice.Application` is a singleton class that creates a single communicator. If you are using multiple communicators, you cannot use `Ice.Application`. Instead, you must structure your code as we saw in [Hello World Application](#) (taking care to always destroy the communicator).

See Also

- [Hello World Application](#)
- [Properties and Configuration](#)
- [Communicator Initialization](#)
- [Logger Facility](#)

Server-Side Java Mapping for Interfaces

The server-side mapping for interfaces provides an up-call API for the Ice run time: by implementing member functions in a servant class, you provide the hook that gets the thread of control from the Ice server-side run time into your application code.

On this page:

- [Skeleton Classes in Java](#)
- [Servant Classes in Java](#)
 - [Normal and `idempotent` Operations in Java](#)

Skeleton Classes in Java

On the client side, interfaces map to [proxy classes](#). On the server side, interfaces map to *skeleton* classes. A skeleton is a class that has a pure virtual member function for each operation on the corresponding interface. For example, consider our [Slice definition](#) for the `Node` interface:

Slice
<pre> module Filesystem { interface Node { idempotent string name(); }; // ... }; </pre>

The Slice compiler generates the following definition for this interface:

Java
<pre> package Filesystem; public interface _NodeOperations { String name(Ice.Current current); } public interface _NodeOperationsNC { String name(); } public interface Node extends Ice.Object, _NodeOperations, _NodeOperationsNC {} public abstract class _NodeDisp extends Ice.ObjectImpl implements Node { // Mapping-internal code here... } </pre>

The important points to note here are:

- As for the client side, Slice modules are mapped to Java packages with the same name, so the skeleton class definitions are part of the `Filesystem` package.
- For each Slice interface `<interface-name>`, the compiler generates Java interfaces `_<interface-name>Operations` and `_<interface-name>OperationsNC` (`_NodeOperations` and `_NodeOperationsNC` in this example). These interfaces contain a method for each operation in the Slice interface. (You can ignore the `Ice.Current` parameter for now.)
- For each Slice interface `<interface-name>`, the compiler generates a Java interface `<interface-name>` (`Node` in this example). That interface extends `Ice.Object` and the two operations interfaces.
- For each Slice interface `<interface-name>`, the compiler generates an abstract class `_<interface-name>Disp` (`_NodeDisp` in this example). This abstract class is the actual skeleton class; it is the base class from which you derive your servant class.

Servant Classes in Java

In order to provide an implementation for an Ice object, you must create a servant class that inherits from the corresponding skeleton class. For example, to create a servant for the `Node` interface, you could write:

```

Java

package Filesystem;

public final class NodeI extends _NodeDisp {

    public NodeI(String name)
    {
        _name = name;
    }

    public String name(Ice.Current current)
    {
        return _name;
    }

    private String _name;
}

```

By convention, servant classes have the name of their interface with an `I`-suffix, so the servant class for the `Node` interface is called `NodeI`. (This is a convention only: as far as the Ice run time is concerned, you can choose any name you prefer for your servant classes.) Note that `NodeI` extends `_NodeDisp`, that is, it derives from its skeleton class.

As far as Ice is concerned, the `NodeI` class must implement only a single method: the `name` method that it inherits from its skeleton. This makes the servant class a concrete class that can be instantiated. You can add other member functions and data members as you see fit to support your implementation. For example, in the preceding definition, we added a `_name` member and a constructor. (Obviously, the constructor initializes the `_name` member and the `name` function returns its value.)

Normal and idempotent Operations in Java

Whether an operation is an ordinary operation or an `idempotent` operation has no influence on the way the operation is mapped. To illustrate this, consider the following interface:

Slice

```
interface Example {
    void normalOp();
    idempotent void idempotentOp();
    idempotent string readonlyOp();
};
```

The operations class for this interface looks like this:

Java

```
public interface _ExampleOperations
{
    void normalOp(Ice.Current current);
    void idempotentOp(Ice.Current current);
    String readonlyOp(Ice.Current current);
}
```

Note that the signatures of the member functions are unaffected by the `idempotent` qualifier.

See Also

- [Slice for a Simple File System](#)
- [Java Mapping for Interfaces](#)
- [Parameter Passing in Java](#)
- [Raising Exceptions in Java](#)
- [Tie Classes in Java](#)
- [The Current Object](#)

Parameter Passing in Java

For each parameter of a Slice operation, the Java mapping generates a corresponding parameter for the method in the `_interface-nameOperations` interface. In addition, every operation has a trailing parameter of type `Ice.Current`. For example, the `name` operation of the `Node` interface has no parameters, but the `name` method of the `_NodeOperations` interface has a single parameter of type `Ice.Current`. We will ignore this parameter for now.

Passing Required Parameters in Java

Parameter passing on the server side follows the rules for the *client side*. To illustrate the rules, consider the following interface that passes string parameters in all possible directions:

```

Slice



```

module M {
 interface Example {
 string op(string sin, out string sout);
 };
};

```

```

The generated skeleton class for this interface looks as follows:

```

Java



```

public interface _ExampleOperations
{
 String op(String sin, Ice.StringHolder sout, Ice.Current current);
}

```

```

As you can see, there are no surprises here. For example, we could implement `op` as follows:

```

Java



```

public final class ExampleI extends M._ExampleDisp {

 public String op(String sin, Ice.StringHolder sout,
Ice.Current current)
 {
 System.out.println(sin); // In params are initialized
 sout.value = "Hello World!"; // Assign out param
 return "Done";
 }
}

```

```

This code is in no way different from what you would normally write if you were to pass strings to and from a function; the fact that remote procedure calls are involved does not impact on your code in any way. The same is true for parameters of other types, such as proxies, classes, or dictionaries: the parameter passing conventions follow normal Java rules and do not require special-purpose API calls.

Passing Optional Parameters in Java

Suppose we modify the example above to use optional parameters:

```

Slice
module M {
    interface Example {
        optional(1) string op(optional(2) string sin, out optional(3)
string sout);
    };
};

```

The generated skeleton now looks like this:

```

Java
public interface _ExampleOperations
{
    String op(Ice.Optional<String> sin, Ice.StringHolder sout,
Ice.Current current);
}

```

For the sake of performance, the default mapping treats optional out parameters and return values as if they are required. If your servant needs the ability to return an optional value, you must add the `java:optional` metadata tag:

```

Slice
module M {
    interface Example {
        ["java:optional"]
        optional(1) string op(optional(2) string sin, out optional(3)
string sout);
    };
};

```

This tag can be applied to an interface if you want to use the optional mapping for all of the operations in that interface, or to individual operations as shown here. With this change, the mapping now returns optional values:

```

Java
public interface _ExampleOperations
{
    Ice.Optional<String> op(Ice.Optional<String> sin,
Ice.Optional<String> sout, Ice.Current current);
}

```

The `java:optional` tag affects the return value and all out parameters; it is not possible to modify the mapping only for certain parameters.

See Also

- [Server-Side Java Mapping for Interfaces](#)
- [Java Mapping for Operations](#)
- [Raising Exceptions in Java](#)
- [Tie Classes in Java](#)
- [The Current Object](#)

Raising Exceptions in Java

To throw an exception from an operation implementation, you simply instantiate the exception, initialize it, and throw it. For example:

```

Java



```

// ...

public void
write(String[] text, Ice.Current current)
 throws GenericError
{
 try
 {
 // Try to write file contents here...
 }
 catch(Exception ex)
 {
 throw new GenericError("Exception during write operation", ex);
 }
}

```

```

Note that, for this example, we have supplied the [optional second parameter](#) to the `GenericError` constructor. This parameter sets the inner exception and preserves the original cause of the error for later diagnosis.

If you throw an arbitrary Java run-time exception (such as a `ClassCastException`), the Ice run time catches the exception and then returns an `UnknownException` to the client. Similarly, if you throw an "impossible" user exception (a user exception that is not listed in the exception specification of the operation), the client receives an `UnknownUserException`.

If you throw an Ice run-time exception, such as `MemoryLimitException`, the client receives an `UnknownLocalException`. For that reason, you should never throw system exceptions from operation implementations. If you do, all the client will see is an `UnknownLocalException`, which does not tell the client anything useful.



Three run-time exceptions are [treated specially](#) and not changed to `UnknownLocalException` when returned to the client: `ObjectNotExistException`, `OperationNotExistException`, and `FacetNotExistException`.

See Also

- [Run-Time Exceptions](#)
- [Java Mapping for Exceptions](#)
- [Server-Side Java Mapping for Interfaces](#)
- [Parameter Passing in Java](#)
- [Tie Classes in Java](#)

Tie Classes in Java

The mapping to [skeleton classes](#) requires the servant class to inherit from its skeleton class. Occasionally, this creates a problem: some class libraries require you to inherit from a base class in order to access functionality provided by the library; because Java does not support multiple implementation inheritance, this means that you cannot use such a class library to implement your servants because your servants cannot inherit from both the library class and the skeleton class simultaneously.

To allow you to still use such class libraries, Ice provides a way to write servants that replaces inheritance with delegation. This approach is supported by *tie classes*. The idea is that, instead of inheriting from the skeleton class, you simply create a class (known as an *implementation class* or *delegate class*) that contains methods corresponding to the operations of an interface. You use the `--tie` option with the `slice2java` compiler to create a tie class. For example, the `--tie` option causes the compiler to create exactly the same code for the [Node interface](#) as we saw previously, but to also emit an additional tie class. For an interface `<interface-name>`, the generated tie class has the name `_interface-name>Tie`:

Java

```
package Filesystem;

public class _NodeTie extends _NodeDisp implements Ice.TieBase {

    public _NodeTie() {}

    public
    _NodeTie(_NodeOperations delegate)
    {
        _ice_delegate = delegate;
    }

    public java.lang.Object
    ice_delegate()
    {
        return _ice_delegate;
    }

    public void
    ice_delegate(java.lang.Object delegate)
    {
        _ice_delegate = (_NodeOperations)delegate;
    }

    public boolean
    equals(java.lang.Object rhs)
    {
        if (this == rhs)
        {
            return true;
        }
        if (!(rhs instanceof _NodeTie))
        {
            return false;
        }
    }
}
```

```
        return _ice_delegate.equals(((NodeTie)rhs)._ice_delegate);
    }

    public int
    hashCode()
    {
        return _ice_delegate.hashCode();
    }

    public String
    name(Ice.Current current)
    {
        return _ice_delegate.name(current);
    }
}
```

```

private _NodeOperations _ice_delegate;
}

```

This looks a lot worse than it is: in essence, the generated tie class is simply a servant class (it extends `_NodeDisp`) that delegates to your implementation class each invocation of a method corresponding to a Slice operation:

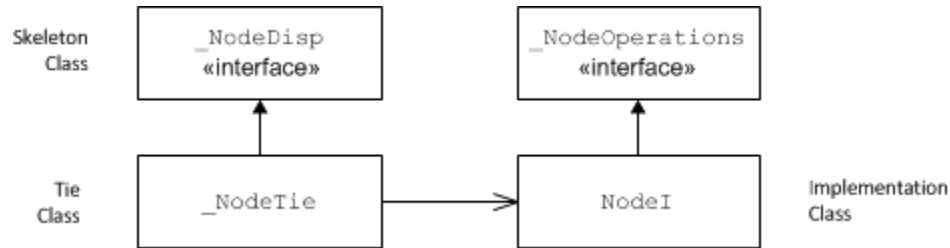

A skeleton class, tie class, and implementation class.

The generated tie class also implements the `Ice.TieBase` interface, which defines methods for obtaining and changing the delegate object:

```

Java
package Ice;

public interface TieBase {
    java.lang.Object ice_delegate();
    void ice_delegate(java.lang.Object delegate);
}

```

The delegate has type `java.lang.Object` in these methods in order to allow a tie object's delegate to be manipulated without knowing its actual type. However, the `ice_delegate` modifier raises `ClassCastException` if the given delegate object is not of the correct type.

Given this machinery, we can create an implementation class for our `Node` interface as follows:

Java

```
package Filesystem;

public final class NodeI implements _NodeOperations {

    public NodeI(String name)
    {
        _name = name;
    }

    public String name(Ice.Current current)
    {
        return _name;
    }

    private String _name;
}

```

Note that this class is identical to our previous implementation, except that it implements the `_NodeOperations` interface and does not extend `_NodeDisp` (which means that you are now free to extend any other class to support your implementation).

To create a servant, you instantiate your implementation class and the tie class, passing a reference to the implementation instance to the tie constructor:

Java

```
NodeI fred = new NodeI("Fred");           // Create implementation
_NodeTie servant = new _NodeTie(fred);     // Create tie

```

Alternatively, you can also default-construct the tie class and later set its delegate instance by calling `ice_delegate`:

Java

```
_NodeTie servant = new _NodeTie();        // Create tie
// ...
NodeI fred = new NodeI("Fred");          // Create implementation
// ...
servant.ice_delegate(fred);               // Set delegate

```

When using tie classes, it is important to remember that the tie instance is the servant, not your delegate. Furthermore, you must not use a tie instance to [incarnate](#) an Ice object until the tie has a delegate. Once you have set the delegate, you must not change it for the lifetime of the tie; otherwise, undefined behavior results.

You should use the tie approach only when necessary, that is, if you need to extend some base class in order to implement your servants: using the tie approach is more costly in terms of memory because each Ice object is incarnated by two Java objects (the tie and the delegate) instead of just one. In addition, call dispatch for ties is marginally slower than for ordinary servants because the tie forwards each operation to the delegate, that is, each operation invocation requires two function calls instead of one.

Also note that, unless you arrange for it, there is no way to get from the delegate back to the tie. If you need to navigate back to the tie from the delegate, you can store a reference to the tie in a member of the delegate. (The reference can, for example, be initialized by the constructor of the delegate.)

See Also

- [Server-Side Java Mapping for Interfaces](#)
- [Parameter Passing in Java](#)
- [Raising Exceptions in Java](#)
- [Object Incarnation in Java](#)

Object Incarnation in Java

Having created a servant class such as the rudimentary `NodeI` class, you can instantiate the class to create a concrete servant that can receive invocations from a client. However, merely instantiating a servant class is insufficient to incarnate an object. Specifically, to provide an implementation of an Ice object, you must take the following steps:

1. [Instantiate a servant class.](#)
2. [Create an identity](#) for the Ice object incarnated by the servant.
3. Inform the Ice run time of the existence of the servant.
4. [Pass a proxy for the object](#) to a client so the client can reach it.

On this page:

- [Instantiating a Java Servant](#)
- [Creating an Identity in Java](#)
- [Activating a Java Servant](#)
- [UUIDs as Identities in Java](#)
- [Creating Proxies in Java](#)
 - [Proxies and Servant Activation in Java](#)
 - [Direct Proxy Creation in Java](#)

Instantiating a Java Servant

Instantiating a servant means to allocate an instance:

```

Java
Node servant = new NodeI("Fred");
```

This code creates a new `NodeI` instance and assigns its address to a reference of type `Node`. This works because `NodeI` is derived from `Node`, so a `Node` reference can refer to an instance of type `NodeI`. However, if we want to invoke a member function of the `NodeI` class at this point, we must use a `NodeI` reference:

```

Java
NodeI servant = new NodeI("Fred");
```

Whether you use a `Node` or a `NodeI` reference depends purely on whether you want to invoke a member function of the `NodeI` class: if not, a `Node` reference works just as well as a `NodeI` reference.

Creating an Identity in Java

Each Ice object requires an identity. That identity must be unique for all servants using the same object adapter.

 The Ice object model assumes that all objects (regardless of their adapter) have a [globally unique identity](#).

An Ice object identity is a structure with the following Slice definition:

Slice

```
module Ice {
    struct Identity {
        string name;
        string category;
    };
    // ...
};
```

The full identity of an object is the combination of both the `name` and `category` fields of the `Identity` structure. For now, we will leave the `category` field as the empty string and simply use the `name` field. (The `category` field is most often used in conjunction with [servant locators](#).)

To create an identity, we simply assign a key that identifies the servant to the `name` field of the `Identity` structure:

Java

```
Ice.Identity id = new Ice.Identity();
id.name = "Fred"; // Not unique, but good enough for now
```

Activating a Java Servant

Merely creating a servant instance does nothing: the Ice run time becomes aware of the existence of a servant only once you explicitly tell the object adapter about the servant. To activate a servant, you invoke the `add` operation on the object adapter. Assuming that we have access to the object adapter in the `_adapter` variable, we can write:

Java

```
_adapter.add(servant, id);
```

Note the two arguments to `add`: the servant and the object identity. Calling `add` on the object adapter adds the servant and the servant's identity to the adapter's servant map and links the proxy for an Ice object to the correct servant instance in the server's memory as follows:

1. The proxy for an Ice object, apart from addressing information, contains the identity of the Ice object. When a client invokes an operation, the object identity is sent with the request to the server.
2. The object adapter receives the request, retrieves the identity, and uses the identity as an index into the servant map.
3. If a servant with that identity is active, the object adapter retrieves the servant from the servant map and dispatches the incoming request into the correct member function on the servant.

Assuming that the object adapter is in the [active state](#), client requests are dispatched to the servant as soon as you call `add`.

UUIDs as Identities in Java

The Ice object model assumes that object identities are globally unique. One way of ensuring that uniqueness is to use UUIDs (Universally Unique Identifiers) as identities. Java provides a helper function that we can use to create such identities:

Java

```
public class Example {
    public static void
    main(String[] args)
    {
        System.out.println(java.util.UUID.randomUUID().toString());
    }
}
```

When executed, this program prints a unique string such as 5029a22c-e333-4f87-86b1-cd5e0fccc509. Each call to `randomUUID` creates a string that differs from all previous ones.

You can use a UUID such as this to create object identities. For convenience, the object adapter has an operation `addWithUUID` that generates a UUID and adds a servant to the servant map in a single step. Using this operation, we can create an identity and register a servant with that identity in a single step as follows:

Java

```
_adapter.addWithUUID(new NodeI("Fred"));
```

Creating Proxies in Java

Once we have activated a servant for an Ice object, the server can process incoming client requests for that object. However, clients can only access the object once they hold a proxy for the object. If a client knows the server's address details and the object identity, it can create a proxy from a string, as we saw in our first example in [Hello World Application](#). However, creation of proxies by the client in this manner is usually only done to allow the client access to initial objects for bootstrapping. Once the client has an initial proxy, it typically obtains further proxies by invoking operations.

The object adapter contains all the details that make up the information in a proxy: the addressing and protocol information, and the object identity. The Ice run time offers a number of ways to create proxies. Once created, you can pass a proxy to the client as the return value or as an out-parameter of an operation invocation.

Proxies and Servant Activation in Java

The `add` and `addWithUUID` servant activation operations on the object adapter return a proxy for the corresponding Ice object. This means we can write:

Java

```
NodePrx proxy = NodePrxHelper.uncheckedCast(_adapter.addWithUUID(new No
deI("Fred")));
```

Here, `addWithUUID` both activates the servant and returns a proxy for the Ice object incarnated by that servant in a single step.

Note that we need to use an `uncheckedCast` here because `addWithUUID` returns a proxy of type `Ice.ObjectPrx`.

Direct Proxy Creation in Java

The object adapter offers an operation to create a proxy for a given identity:

Slice

```

module Ice {
    local interface ObjectAdapter {
        Object* createProxy(Identity id);
        // ...
    };
};

```

Note that `createProxy` creates a proxy for a given identity whether a servant is activated with that identity or not. In other words, proxies have a life cycle that is quite independent from the life cycle of servants:

Java

```

Ice.Identity id = new Ice.Identity();
id.name = java.util.UUID.randomUUID().toString();
Ice.ObjectPrx o = _adapter.createProxy(id);

```

This creates a proxy for an Ice object with the identity returned by `randomUUID`. Obviously, no servant yet exists for that object so, if we return the proxy to a client and the client invokes an operation on the proxy, the client will receive an `ObjectNotExistException`. (We examine these life cycle issues in more detail in [Object Life Cycle](#).)

See Also

- [Hello World Application](#)
- [Server-Side Java Mapping for Interfaces](#)
- [Object Adapter States](#)
- [Servant Locators](#)
- [Object Life Cycle](#)

Asynchronous Method Dispatch (AMD) in Java

The number of simultaneous synchronous requests a server is capable of supporting is determined by the number of threads in the server's [thread pool](#). If all of the threads are busy dispatching long-running operations, then no threads are available to process new requests and therefore clients may experience an unacceptable lack of responsiveness.

Asynchronous Method Dispatch (AMD), the server-side equivalent of [AMI](#), addresses this scalability issue. Using AMD, a server can receive a request but then suspend its processing in order to release the dispatch thread as soon as possible. When processing resumes and the results are available, the server sends a response explicitly using a callback object provided by the Ice run time.

AMD is transparent to the client, that is, there is no way for a client to distinguish a request that, in the server, is processed synchronously from a request that is processed asynchronously.

In practical terms, an AMD operation typically queues the request data (i.e., the callback object and operation arguments) for later processing by an application thread (or thread pool). In this way, the server minimizes the use of dispatch threads and becomes capable of efficiently supporting thousands of simultaneous clients.

An alternate use case for AMD is an operation that requires further processing after completing the client's request. In order to minimize the client's delay, the operation returns the results while still in the dispatch thread, and then continues using the dispatch thread for additional work.

On this page:

- [Enabling AMD with Metadata in Java](#)
- [AMD Mapping in Java](#)
 - [Callback interface for AMD](#)
 - [Dispatch method for AMD](#)
- [AMD Exceptions in Java](#)
- [AMD Example in Java](#)

Enabling AMD with Metadata in Java

To enable asynchronous dispatch, you must add an ["amd"] metadata directive to your Slice definitions. The directive applies at the interface and the operation level. If you specify ["amd"] at the interface level, all operations in that interface use asynchronous dispatch; if you specify ["amd"] for an individual operation, only that operation uses asynchronous dispatch. In either case, the metadata directive *replaces* synchronous dispatch, that is, a particular operation implementation must use synchronous or asynchronous dispatch and cannot use both.

Consider the following Slice definitions:

Slice
<pre>["amd"] interface I { bool isValid(); float computeRate(); }; interface J { ["amd"] void startProcess(); int endProcess(); };</pre>

In this example, both operations of interface `I` use asynchronous dispatch, whereas, for interface `J`, `startProcess` uses asynchronous dispatch and `endProcess` uses synchronous dispatch.

Specifying metadata at the operation level (rather than at the interface or class level) minimizes the amount of generated code and, more importantly, minimizes complexity: although the asynchronous model is more flexible, it is also more complicated to use. It is therefore in your best interest to limit the use of the asynchronous model to those operations that need it, while using the simpler synchronous model for

the rest.

AMD Mapping in Java

The Java mapping emits the following code for each AMD operation:

1. [Callback interface](#)
2. [Dispatch method](#)

Callback interface for AMD

A callback interface is used by the implementation to notify the Ice run time about the completion of an operation. The name of this interface is formed using the pattern `AMD_class_op`. For example, an operation named `foo` defined in interface `I` results in an interface named `AMD_I_foo`. The interface is generated in the same scope as the interface or class containing the operation. Two methods are provided:

```

Java
public void ice_response(<params>);
```

The `ice_response` method allows the server to report the successful completion of the operation. If the operation has a non-`void` return type, the first parameter to `ice_response` is the return value. Parameters corresponding to the operation's out parameters follow the return value, in the order of declaration.

```

Java
public void ice_exception(java.lang.Exception ex);
```

The `ice_exception` method allows the server to raise an exception. With respect to exceptions, there is less compile-time type safety in an AMD implementation because there is no `throws` clause on the dispatch method and any exception type could conceivably be passed to `ice_exception`. However, the Ice run time [validates](#) the exception value using the same semantics as for synchronous dispatch.

Neither `ice_response` nor `ice_exception` throw any exceptions to the caller.

Dispatch method for AMD

The dispatch method, whose name has the suffix `_async`, has a `void` return type. The first parameter is a reference to an instance of the callback interface described above. The remaining parameters comprise the `in` parameters of the operation, in the order of declaration.

For example, suppose we have defined the following operation:

```

Slice
interface I {
  ["amd"] int foo(short s, out long l);
};
```

The callback interface generated for operation `foo` is shown below:

Java

```
public interface AMD_I_foo {
    void ice_response(int __ret, long l);
    void ice_exception(java.lang.Exception ex);
}
```

The dispatch method for asynchronous invocation of operation `foo` is generated as follows:

Java

```
void foo_async(AMD_I_foo __cb, short s);
```

AMD Exceptions in Java

There are two processing contexts in which the logical implementation of an AMD operation may need to report an exception: the dispatch thread (the thread that receives the invocation), and the response thread (the thread that sends the response).



These are not necessarily two different threads: it is legal to send the response from the dispatch thread.

Although we recommend that the callback object be used to report all exceptions to the client, it is legal for the implementation to raise an exception instead, but only from the dispatch thread.

As you would expect, an exception raised from a response thread cannot be caught by the Ice run time; the application's run time environment determines how such an exception is handled. Therefore, a response thread must ensure that it traps all exceptions and sends the appropriate response using the callback object. Otherwise, if a response thread is terminated by an uncaught exception, the request may never be completed and the client might wait indefinitely for a response.

Whether raised in a dispatch thread or reported via the callback object, user exceptions are [validated](#) and local exceptions may undergo [translation](#).

AMD Example in Java

To demonstrate the use of AMD in Ice, let us define the Slice interface for a simple computational engine:

Slice

```
module Demo {
    sequence<float> Row;
    sequence<Row> Grid;

    exception RangeError {};

    interface Model {
        ["amd"] Grid interpolate(Grid data, float factor)
            throws RangeError;
    };
};
```

Given a two-dimensional grid of floating point values and a factor, the `interpolate` operation returns a new grid of the same size with the values interpolated in some interesting (but unspecified) way.

Our servant class derives from `Demo._ModelDisp` and supplies a definition for the `interpolate_async` method that creates a `Job` to hold the callback object and arguments, and adds the `Job` to a queue. The method is synchronized to guard access to the queue:

Java

```
public final class ModelI extends Demo._ModelDisp {
    synchronized public void interpolate_async(
        Demo.AMD_Model_interpolate cb,
        float[][] data,
        float factor,
        Ice.Current current)
        throws RangeError
    {
        _jobs.add(new Job(cb, data, factor));
    }

    java.util.LinkedList<Job> _jobs = new java.util.LinkedList<Job>();
}
```

After queuing the information, the operation returns control to the Ice run time, making the dispatch thread available to process another request. An application thread removes the next `Job` from the queue and invokes `execute`, which uses `interpolateGrid` (not shown) to perform the computational work:

Java

```

class Job {
    Job(Demo.AMD_Model_interpolate cb,
        float[][] grid,
        float factor)
    {
        _cb = cb;
        _grid = grid;
        _factor = factor;
    }

    void execute()
    {
        if (!interpolateGrid()) {
            _cb.ice_exception(new Demo.RangeError());
            return;
        }
        _cb.ice_response(_grid);
    }

    private boolean interpolateGrid() {
        // ...
    }

    private Demo.AMD_Model_interpolate _cb;
    private float[][] _grid;
    private float _factor;
}

```

If `interpolateGrid` returns false, then `ice_exception` is invoked to indicate that a range error has occurred. The `return` statement following the call to `ice_exception` is necessary because `ice_exception` does not throw an exception; it only marshals the exception argument and sends it to the client.

If interpolation was successful, `ice_response` is called to send the modified grid back to the client.

See Also

- [User Exceptions](#)
- [Run-Time Exceptions](#)
- [Asynchronous Method Invocation \(AMI\) in Java](#)
- [The Ice Threading Model](#)

Example of a File System Server in Java

This page presents the source code for a Java server that implements our [file system](#) and communicates with the [client](#) we wrote earlier. The code is fully functional, apart from the required interlocking for threads.

Note that the server is remarkably free of code that relates to distribution: most of the server code is simply application logic that would be present just the same for a non-distributed version. Again, this is one of the major advantages of Ice: distribution concerns are kept away from application code so that you can concentrate on developing application logic instead of networking infrastructure.

i The server code shown here is not quite correct as it stands: if two clients access the same file in parallel, each via a different thread, one thread may read the `_lines` data member while another thread updates it. Obviously, if that happens, we may write or return garbage or, worse, crash the server. However, it is trivial to make the `read` and `write` operations thread-safe. We discuss thread safety in [The Ice Threading Model](#).

On this page:

- [Implementing a File System Server in Java](#)
- [Server Main Program in Java](#)
- [FileI Servant Class in Java](#)
- [DirectoryI Servant Class in Java](#)
 - [DirectoryI Data Members](#)
 - [DirectoryI Constructor](#)
 - [DirectoryI Methods](#)

Implementing a File System Server in Java

We have now seen enough of the server-side Java mapping to implement a server for our [file system](#). (You may find it useful to review these [Slice definitions](#) before studying the source code.)

Our server is composed of three source files:

- `Server.java`
This file contains the server main program.
- `Filesystem/DirectoryI.java`
This file contains the implementation for the `Directory` servants.
- `Filesystem/FileI.java`
This file contains the implementation for the `File` servants.

Server Main Program in Java

Our server main program, in the file `Server.java`, uses the `Ice.Application` class. The `run` method installs a shutdown hook, creates an object adapter, instantiates a few servants for the directories and files in the file system, and then activates the adapter. This leads to a main program as follows:

Java

```
import Filesystem.*;

public class Server extends Ice.Application {
    public int
    run(String[] args)
    {
        //
        // Terminate cleanly on receipt of a signal
        //
    }
}
```

```

shutdownOnInterrupt();

// Create an object adapter (stored in the _adapter
// static members)
//
Ice.ObjectAdapter adapter
= communicator().createObjectAdapterWithEndpoints(
    "SimpleFilesystem", "default -p 10000");
DirectoryI._adapter = adapter;
FileI._adapter = adapter;

// Create the root directory (with name "/" and no parent)
//
DirectoryI root = new DirectoryI("/", null);

// Create a file "README" in the root directory
//
File file = new FileI("README", root);
String[] text;
text = new String[] {
    "This file system contains a collection of poetry."
};
try {
    file.write(text, null);
} catch (GenericError e) {
    System.err.println(e.reason);
}

// Create a directory "Coleridge" in the root directory
//
DirectoryI coleridge = new DirectoryI("Coleridge", root);

// Create a file "Kubla_Khan" in the Coleridge directory
//
file = new FileI("Kubla_Khan", coleridge);
text = new String[] { "In Xanadu did Kubla Khan",
    "A stately pleasure-dome decree:",
    "Where Alph, the sacred river, ran",
    "Through caverns measureless to man",
    "Down to a sunless sea." };
try {
    file.write(text, null);
} catch (GenericError e) {
    System.err.println(e.reason);
}

// All objects are created, allow client requests now
//
adapter.activate();

```



```
        // Wait until we are done
        //
        communicator().waitForShutdown();

        return 0;
    }

    public static void
    main(String[] args)
    {
        Server app = new Server();
        System.exit(app.main("Server", args));
    }
}
```

```

    }
}

```

The code imports the contents of the `Filesystem` package. This avoids having to continuously use fully-qualified identifiers with a `Filesystem.` prefix.

The next part of the source code is the definition of the `Server` class, which derives from `Ice.Application` and contains the main application logic in its `run` method. Much of this code is boiler plate that we saw previously: we create an object adapter, and, towards the end, activate the object adapter and call `waitForShutdown`.

The interesting part of the code follows the adapter creation: here, the server instantiates a few nodes for our file system to create the structure shown below:

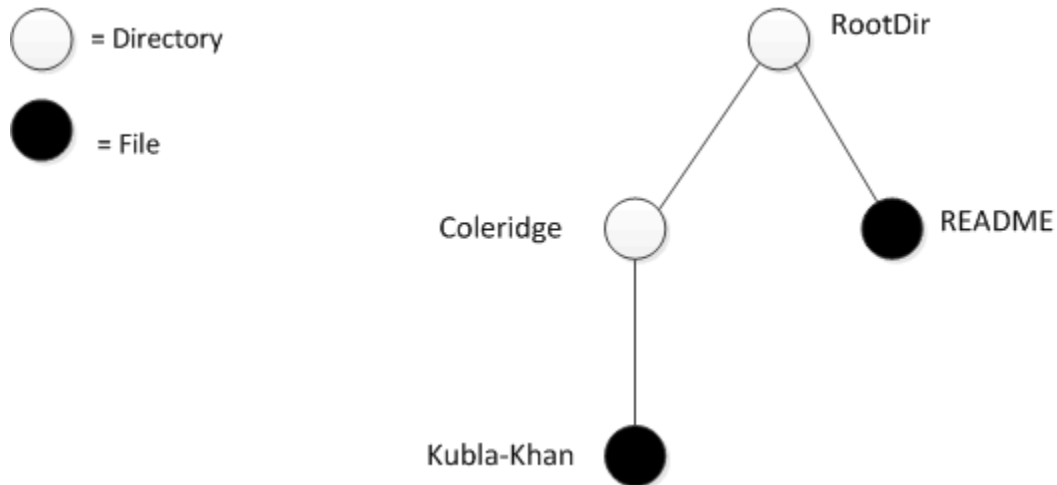

A small file system.

As we will see shortly, the servants for our directories and files are of type `DirectoryI` and `FileI`, respectively. The constructor for either type of servant accepts two parameters, the name of the directory or file to be created and a reference to the servant for the parent directory. (For the root directory, which has no parent, we pass a null parent.) Thus, the statement

```

Java
DirectoryI root = new DirectoryI("/", null);

```

creates the root directory, with the name `" / "` and no parent directory.

Here is the code that establishes the structure in the above illustration:

Java

```

// Create the root directory (with name "/" and no parent)
//
DirectoryI root = new DirectoryI("/", null);

// Create a file "README" in the root directory
//
File file = new FileI("README", root);
String[] text;
text = new String[] {
    "This file system contains a collection of poetry."
};
try {
    file.write(text, null);
} catch (GenericError e) {
    System.err.println(e.reason);
}

// Create a directory "Coleridge" in the root directory
//
DirectoryI coleridge = new DirectoryI("Coleridge", root);

// Create a file "Kubla_Khan" in the Coleridge directory
//
file = new FileI("Kubla_Khan", coleridge);
text = new String[] { "In Xanadu did Kubla Khan",
    "A stately pleasure-dome decree:",
    "Where Alph, the sacred river, ran",
    "Through caverns measureless to man",
    "Down to a sunless sea." };
try {
    file.write(text, null);
} catch (GenericError e) {
    System.err.println(e.reason);
}

```

We first create the root directory and a file `README` within the root directory. (Note that we pass a reference to the root directory as the parent when we create the new node of type `FileI`.)

The next step is to fill the file with text:

Java

```
String[] text;
text = new String[] {
    "This file system contains a collection of poetry."
};
try {
    file.write(text, null);
} catch (GenericError e) {
    System.err.println(e.reason);
}
```

Recall that [Slice sequences](#) by default map to Java arrays. The Slice type `Lines` is simply an array of strings; we add a line of text to our `README` file by initializing the `text` array to contain one element.

Finally, we call the Slice `write` operation on our `FileI` servant by writing:

Java

```
file.write(text, null);
```

This statement is interesting: the server code invokes an operation on one of its own servants. Because the call happens via a reference to the servant (of type `FileI`) and *not* via a proxy (of type `FilePrx`), the Ice run time does not know that this call is even taking place — such a direct call into a servant is not mediated by the Ice run time in any way and is dispatched as an ordinary Java function call.

In similar fashion, the remainder of the code creates a subdirectory called `Coleridge` and, within that directory, a file called `Kubla_Khan` to complete the structure in the illustration listed above.

FileI Servant Class in Java

Our `FileI` servant class has the following basic structure:

Java

```
public class FileI extends _FileDisp
{
    // Constructor and operations here...

    public static Ice.ObjectAdapter _adapter;
    private String _name;
    private DirectoryI _parent;
    private String[] _lines;
}
```

The class has a number of data members:

- `_adapter`
This static member stores a reference to the single object adapter we use in our server.
- `_name`

This member stores the name of the file incarnated by the servant.

- `_parent`
This member stores the reference to the servant for the file's parent directory.
- `_lines`
This member holds the contents of the file.

The `_name` and `_parent` data members are initialized by the constructor:

```

Java

public
FileI(String name, DirectoryI parent)
{
    _name = name;
    _parent = parent;

    assert(_parent != null);

    // Create an identity
    //
    Ice.Identity myID = new Ice.Identity();
    myID.name = java.util.UUID.randomUUID().toString();

    // Add the identity to the object adapter
    //
    _adapter.add(this, myID);

    // Create a proxy for the new node and
    // add it as a child to the parent
    //
    NodePrx thisNode
= NodePrxHelper.uncheckedCast(_adapter.createProxy(myID));
    _parent.addChild(thisNode);
}

```

After initializing the `_name` and `_parent` members, the code verifies that the reference to the parent is not null because every file must have a parent directory. The constructor then generates an identity for the file by calling `java.util.UUID.randomUUID` and adds itself to the servant map by calling `ObjectAdapter.add`. Finally, the constructor creates a proxy for this file and calls the `addChild` method on its parent directory. `addChild` is a helper function that a child directory or file calls to add itself to the list of descendant nodes of its parent directory. We will see the implementation of this function in [DirectoryI Methods](#).

The remaining methods of the `FileI` class implement the Slice operations we defined in the `Node` and `File` Slice interfaces:

Java

```

// Slice Node::name() operation

public String
name(Ice.Current current)
{
    return _name;
}

// Slice File::read() operation

public String[]
read(Ice.Current current)
{
    return _lines;
}

// Slice File::write() operation

public void
write(String[] text, Ice.Current current)
    throws GenericError
{
    _lines = text;
}

```

The `name` method is inherited from the generated `Node` interface (which is a base interface of the `_FileDisp` class from which `FileI` is derived). It returns the value of the `_name` member.

The `read` and `write` methods are inherited from the generated `File` interface (which is a base interface of the `_FileDisp` class from which `FileI` is derived) and return and set the `_lines` member.

DirectoryI Servant Class in Java

The `DirectoryI` class has the following basic structure:

Java

```
package Filesystem;

public final class DirectoryI extends _DirectoryDisp
{
    // Constructor and operations here...

    public static Ice.ObjectAdapter _adapter;
    private String _name;
    private DirectoryI _parent;
    private java.util.ArrayList<NodePrx> _contents
= new java.util.ArrayList<NodePrx>();
}
```

DirectoryI Data Members

As for the `FileI` class, we have data members to store the object adapter, the name, and the parent directory. (For the root directory, the `_parent` member holds a null reference.) In addition, we have a `_contents` data member that stores the list of child directories. These data members are initialized by the constructor:

Java

```
public
DirectoryI(String name, DirectoryI parent)
{
    _name = name;
    _parent = parent;

    // Create an identity. The parent has the
    // fixed identity "RootDir"
    //
    Ice.Identity myID = new Ice.Identity();
    myID.name = _parent != null ? java.util.UUID.randomUUID().toString(
) : "RootDir";

    // Add the identity to the object adapter
    //
    _adapter.add(this, myID);

    // Create a proxy for the new node and add it as a
    // child to the parent
    //
    NodePrx thisNode
= NodePrxHelper.uncheckedCast(_adapter.createProxy(myID));
    if (_parent != null)
        _parent.addChild(thisNode);
}
```

DirectoryI Constructor

The constructor creates an identity for the new directory by calling `java.util.UUID.randomUUID()`. (For the root directory, we use the fixed identity "RootDir".) The servant adds itself to the servant map by calling `ObjectAdapter.add` and then creates a reference to itself and passes it to the `addChild` helper function.

DirectoryI Methods

`addChild` adds the passed reference to the `_contents` list:

```

Java

void
addChild(NodePrx child)
{
    _contents.add(child);
}

```

The remainder of the operations, `name` and `list`, are equally trivial:

```

Java

public String
name(Ice.Current current)
{
    return _name;
}

// Slice Directory::list() operation

public NodePrx[]
list(Ice.Current current)
{
    NodePrx[] result = new NodePrx[_contents.size()];
    _contents.toArray(result);
    return result;
}

```

Note that the `_contents` member is of type `java.util.ArrayList<NodePrx>`, which is convenient for the implementation of the `addChild` method. However, this requires us to convert the list into a Java array in order to return it from the `list` operation.

See Also

- [Slice for a Simple File System](#)
- [Example of a File System Client in Java](#)
- [The Server-Side main Method in Java](#)
- [Java Mapping for Sequences](#)
- [The Ice Threading Model](#)

The Java Utility Library

Ice for Java includes a number of utility APIs in the `IceUtil` package and the `Ice.Util` class. This section summarizes the contents of these APIs for your reference.

On this page:

- [The `IceUtil` Package in Java](#)
 - [Cache and Store Classes](#)
- [The `Ice.Util` Class in Java](#)
 - [Communicator Initialization Methods](#)
 - [Identity Conversion](#)
 - [Per-Process Logger Methods](#)
 - [Property Creation Methods](#)
 - [Proxy Comparison Methods](#)
 - [Stream Creation](#)
 - [Version Information](#)

The `IceUtil` Package in Java

Cache and Store Classes

The `Cache` class allows you to efficiently maintain a cache that is backed by secondary storage, such as a Berkeley DB database, without holding a lock on the entire cache while values are being loaded from the database. If you want to create [evictors for servants](#) that store their state in a database, the `Cache` class can simplify your evictor implementation considerably.



You may also want to examine the implementation of the Freeze background save evictor in the source distribution; it uses `IceUtil.Cache` for its implementation.

The `Cache` class has the following interface:

```

Java

package IceUtil;

public class Cache {
    public Cache(Store store);

    public Object pin(Object key);
    public Object pin(Object key, Object o);
    public Object unpin(Object key);

    public Object putIfAbsent(Object key, Object newObj);
    public Object getIfPinned(Object key);

    public void clear();
    public int size();
}

```

Internally, a `Cache` maintains a map of name-value pairs. The implementation of `Cache` takes care of maintaining the map; in particular, it ensures that concurrent lookups by callers are possible without blocking even if some of the callers are currently loading values from the backing store. In turn, this is useful for evictor implementations, such as the Freeze [background save evictor](#). The `Cache` class does not limit

the number of entries in the cache — it is the job of the evictor implementation to limit the map size by calling `unpin` on elements of the map that it wants to evict.

The `Cache` class works in conjunction with a `Store` interface for which you must provide an implementation. The `Store` interface is trivial:

```

Java

package IceUtil;

public interface Store {
    Object load(Object key);
}

```

You must implement the `load` method in a class that you derive from `Store`. The `Cache` implementation calls `load` when it needs to retrieve the value for the passed key from the backing store. If `load` cannot locate a record for the given key because no such record exists, it must return `null`. If `load` fails for some other reason, it can throw an exception derived from `java.lang.RuntimeException`, which is propagated back to the application code.

The public member functions of `Cache` behave as follows:

Cache(Store s)

The constructor initializes the cache with your implementation of the `Store` interface.

Object pin(Object key, Object val)

To add a key-value pair to the cache, your evictor can call `pin`. The return value is `null` if the key and value were added; otherwise, if the map already contains an entry with the given key, the entry is unchanged and `pin` returns the original value for that key.

This version of `pin` does *not* call `load` to retrieve the entry from backing store if it is not yet in the cache. This is useful when you add a newly-created object to the cache.

Object pin(Object key)

This version of `pin` returns the value stored in the cache for the given key if the cache already contains an entry for that key. If no entry with the given key is in the cache, `pin` calls `load` to retrieve the corresponding value (if any) from the backing store. `pin` returns the value returned by `load`, that is, the value if `load` could retrieve it, `null` if `load` could not retrieve it, or any exception thrown by `load`.

Object unpin(Object key)

`unpin` removes the entry for the given key from the cache. If the cache contained an entry for the key, the return value is the value for that key; otherwise, the return value is `null`.

Object putIfAbsent(Object key, Object val)

This function adds a key-value pair to the cache. If the cache already contains an entry for the given key, `putIfAbsent` returns the original value for that key. If no entry with the given key is in the cache, `putIfAbsent` calls `load` to retrieve the corresponding entry (if any) from the backing store and returns the value returned by `load`.

If the cache does not contain an entry for the given key and `load` does not retrieve a value for the key, the method adds the new entry and returns `null`.

Object getIfPinned(Object key)

This function returns the value stored for the given key. If an entry for the given key is in the map, the function returns the corresponding value; otherwise, the function returns `null`. `getIfPinned` does not call `load`.

void clear()

This function removes all entries in the map.

```
int size()
```

This function returns the number of entries in the map.

The `Ice.Util` Class in Java

Communicator Initialization Methods

`Ice.Util` provides a number of overloaded `initialize` methods that [create a communicator](#).

Identity Conversion

`Ice.Util` contains two methods for [converting object identities](#) of type `Ice.Identity` to and from strings.

Per-Process Logger Methods

`Ice.Util` provides methods for [getting and setting the per-process logger](#).

Property Creation Methods

`Ice.Util` provides a number of overloaded `createProperties` methods that [create property sets](#).

Proxy Comparison Methods

Two methods, `proxyIdentityCompare` and `proxyIdentityAndFacetCompare`, allow you to [compare object identities](#) that are stored in proxies (either ignoring the facet or taking the facet into account).

Stream Creation

The methods `createInputStream`, `wrapInputStream` and `createOutputStream` create [streams](#) for use with dynamic invocation.

Version Information

The `stringVersion` and `intVersion` methods return the version of the Ice run time:

Java
<pre><code>public static String stringVersion(); public static int intVersion();</code></pre>

The `stringVersion` method returns the Ice version in the form `<major>.<minor>.<patch>`, for example, `3.4.2`. For beta releases, the version is `<major>.<minor>b`, for example, `3.4b`.

The `intVersion` method returns the Ice version in the form `AABBCC`, where `AA` is the major version number, `BB` is the minor version number, and `CC` is patch level, for example, `30402` for version `3.4.2`. For beta releases, the patch level is set to 51 so, for example, for version `3.4b`, the value is `30451`.

See Also

- [Background Save Evictor](#)
- [Java Mapping for Interfaces](#)
- [Command-Line Parsing and Initialization](#)
- [Setting Properties](#)

- [Object Identity](#)
- [Java Streaming Interfaces](#)

C-Sharp Mapping

Topics

- [Client-Side Slice-to-C-Sharp Mapping](#)
- [Server-Side Slice-to-C-Sharp Mapping](#)
- [Silverlight and .NET Compact Framework Support](#)
- [The .NET Utility Library](#)
- [Silverlight Security Policies](#)

Client-Side Slice-to-C-Sharp Mapping

The client-side Slice-to-C# mapping defines how Slice data types are translated to C# types, and how clients invoke operations, pass parameters, and handle errors. Much of the C# mapping is intuitive. For example, by default, Slice sequences map to C# arrays, so there is little you have learn in order to use Slice sequences in C#.

The C# API to the Ice run time is fully thread-safe. Obviously, you must still synchronize access to data from different threads. For example, if you have two threads sharing a sequence, you cannot safely have one thread insert into the sequence while another thread is iterating over the sequence. However, you only need to concern yourself with concurrent access to your own data — the Ice run time itself is fully thread safe, and none of the Ice API calls require you to acquire or release a lock before you safely can make the call.

Much of what appears in this chapter is reference material. We suggest that you skim the material on the initial reading and refer back to specific sections as needed. However, we recommend that you read at least the mappings for [exceptions](#), [interfaces](#), and [operations](#) in detail because these sections cover how to call operations from a client, pass parameters, and handle exceptions.



In order to use the C# mapping, you should need no more than the Slice definition of your application and knowledge of the C# mapping rules. In particular, looking through the generated code in order to discern how to use the C# mapping is likely to be inefficient, due to the amount of detail. Of course, occasionally, you may want to refer to the generated code to confirm a detail of the mapping, but we recommend that you otherwise use the material presented here to see how to write your client-side code.



The Ice Namespace

All of the APIs for the Ice run time are nested in the `Ice` namespace, to avoid clashes with definitions for other libraries or applications. Some of the contents of the `Ice` namespace are generated from Slice definitions; other parts of the `Ice` namespace provide special-purpose definitions that do not have a corresponding Slice definition. We will incrementally cover the contents of the `Ice` namespace throughout the remainder of the manual.

Topics

- [C-Sharp Mapping for Identifiers](#)
- [C-Sharp Mapping for Modules](#)
- [C-Sharp Mapping for Built-In Types](#)
- [C-Sharp Mapping for Enumerations](#)
- [C-Sharp Mapping for Structures](#)
- [C-Sharp Mapping for Sequences](#)
- [C-Sharp Mapping for Dictionaries](#)
- [C-Sharp Collection Comparison](#)
- [C-Sharp Mapping for Constants](#)
- [C-Sharp Mapping for Exceptions](#)
- [C-Sharp Mapping for Interfaces](#)
- [C-Sharp Mapping for Operations](#)
- [C-Sharp Mapping for Classes](#)
- [C-Sharp Mapping for Optional Values](#)
- [Serializable Objects in C-Sharp](#)
- [C-Sharp Specific Metadata Directives](#)
- [Asynchronous Method Invocation \(AMI\) in C-Sharp](#)
- [slice2cs Command-Line Options](#)
- [Using Slice Checksums in C-Sharp](#)
- [Example of a File System Client in C-Sharp](#)

C-Sharp Mapping for Identifiers

Slice identifiers map to an identical C# identifier. For example, the Slice identifier `clock` becomes the C# identifier `clock`. If a Slice identifier is the same as a C# keyword, the corresponding C# identifier is a *verbatim identifier* (an identifier prefixed with `@`). For example, the Slice identifier `while` is mapped as `@while`.

 You should try to avoid such identifiers as much as possible.

The Slice-to-C# compiler generates classes that inherit from interfaces or base classes in the .NET framework. These interfaces and classes introduce a number of methods into derived classes. To avoid name clashes between Slice identifiers that happen to be the same as an inherited method, such identifiers are prefixed with `ice_` and suffixed with `_` in the generated code. For example, the Slice identifier `Clone` maps to the C# identifier `ice_Clone_` if it would clash with an inherited `Clone`. The complete list of identifiers that are so changed is:

<code>Clone</code>	<code>Equals</code>	<code>Finalize</code>
<code>GetBaseException</code>	<code>GetHashCode</code>	<code>GetObjectData</code>
<code>GetType</code>	<code>MemberwiseClone</code>	<code>ReferenceEquals</code>
<code>ToString</code>	<code>checkedCast</code>	<code>uncheckedCast</code>

Note that Slice identifiers in this list are translated to the corresponding C# identifier only where necessary. For example, structures do not derive from `ICloneable`, so if a Slice structure contains a member named `Clone`, the corresponding C# structure's member is named `Clone` as well. On the other hand, classes do derive from `ICloneable`, so, if a Slice class contains a member named `Clone`, the corresponding C# class's member is named `ice_Clone_`.

Also note that, for the purpose of prefixing, Slice identifiers are case-insensitive, that is, both `Clone` and `clone` are escaped and map to `ice_Clone_` and `ice_clone_`, respectively.

See Also

- [Identifiers That Are Keywords](#)
- [C-Sharp Mapping for Modules](#)
- [C-Sharp Mapping for Built-In Types](#)
- [C-Sharp Mapping for Enumerations](#)
- [C-Sharp Mapping for Structures](#)
- [C-Sharp Mapping for Sequences](#)
- [C-Sharp Mapping for Dictionaries](#)
- [C-Sharp Collection Comparison](#)
- [C-Sharp Mapping for Constants](#)
- [C-Sharp Mapping for Exceptions](#)

C-Sharp Mapping for Modules

Slice modules map to C# namespaces with the same name as the Slice module. The mapping preserves the nesting of the Slice definitions. For example:

Slice
<pre> module M1 { // Definitions for M1 here... module M2 { // Definitions for M2 here... }; }; // ... module M1 { // Reopen M1 // More definitions for M1 here... }; </pre>

This definition maps to the corresponding C# definitions:

C#
<pre> namespace M1 { namespace M2 { // ... } // ... } // ... namespace M1 // Reopen M1 { // ... } </pre>

If a Slice module is reopened, the corresponding C# namespace is reopened as well.

See Also

- [C-Sharp Mapping for Identifiers](#)
- [C-Sharp Mapping for Built-In Types](#)
- [C-Sharp Mapping for Enumerations](#)
- [C-Sharp Mapping for Structures](#)
- [C-Sharp Mapping for Sequences](#)
- [C-Sharp Mapping for Dictionaries](#)
- [C-Sharp Collection Comparison](#)

- [C-Sharp Mapping for Constants](#)
- [C-Sharp Mapping for Exceptions](#)

C-Sharp Mapping for Built-In Types

The Slice built-in types are mapped to C# types as shown below:

Slice	C#
bool	bool
byte	byte
short	short
int	int
long	long
float	float
double	double
string	string

Mapping of Slice built-in types to C#.

See Also

- [C-Sharp Mapping for Identifiers](#)
- [C-Sharp Mapping for Modules](#)
- [C-Sharp Mapping for Enumerations](#)
- [C-Sharp Mapping for Structures](#)
- [C-Sharp Mapping for Sequences](#)
- [C-Sharp Mapping for Dictionaries](#)
- [C-Sharp Collection Comparison](#)
- [C-Sharp Mapping for Constants](#)
- [C-Sharp Mapping for Exceptions](#)

C-Sharp Mapping for Enumerations

A Slice `enumeration` maps to the corresponding enumeration in C#. For example:

```

Slice
enum Fruit { Apple, Pear, Orange };

```

Not surprisingly, the generated C# definition is very similar:

```

C#
public enum Fruit { Apple, Pear, Orange }

```

Suppose we modify the Slice definition to include a custom enumerator value:

```

Slice
enum Fruit { Apple, Pear = 3, Orange };

```

The generated C# definition now includes an explicit initializer for every enumerator:

```

C#
public enum Fruit { Apple = 0, Pear = 3, Orange = 4 }

```

See Also

- [C-Sharp Mapping for Identifiers](#)
- [C-Sharp Mapping for Modules](#)
- [C-Sharp Mapping for Built-In Types](#)
- [C-Sharp Mapping for Structures](#)
- [C-Sharp Mapping for Sequences](#)
- [C-Sharp Mapping for Dictionaries](#)
- [C-Sharp Collection Comparison](#)
- [C-Sharp Mapping for Constants](#)
- [C-Sharp Mapping for Exceptions](#)

C-Sharp Mapping for Structures

Ice for .NET supports two different mappings for Slice [structures](#). By default, Slice structures map to C# structures if they (recursively) contain only value types. If a Slice structure (recursively) contains a string, proxy, class, sequence, or dictionary member, it maps to a C# class. A [metadata directive](#) allows you to force the mapping to a C# class for Slice structures that contain only value types.

In addition, for either mapping, you can control whether Slice data members are mapped to fields or to [properties](#).

On this page:

- [Structure Mapping for Structures in C#](#)
- [Class Mapping for Structures in C#](#)
- [Property Mapping for Structures in C#](#)

Structure Mapping for Structures in C#

Consider the following structure:

Slice
<pre>struct Point { double x; double y; };</pre>

This structure consists of only value types and so, by default, maps to a C# partial structure:

C#
<pre>public partial struct Point { public double x; public double y; public Point(double x, double y); public override int GetHashCode(); public override bool Equals(object other); public static bool operator==(Point lhs, Point rhs); public static bool operator!=(Point lhs, Point rhs); }</pre>

For each data member in the Slice definition, the C# structure contains a corresponding public data member of the same name.

The generated constructor accepts one argument for each structure member, in the order in which they are defined in the Slice definition. This allows you to construct and initialize a structure in a single statement:

C#
<pre>Point p = new Point(5.1, 7.8);</pre>

Note that C# does not allow a value type to declare a default constructor or to assign default values to data members.

The structure overrides the `GetHashCode` and `Equals` methods to allow you to use it as the key type of a dictionary. (Note that the static two-argument version of `Equals` is inherited from `System.Object`.) Two structures are equal if (recursively) all their data members are equal. Otherwise, they are not equal. For structures that contain reference types, `Equals` performs a deep comparison; that is, reference types are compared for value equality, not reference equality.

Class Mapping for Structures in C#

The mapping for Slice structures to C# structures provides value semantics. Usually, this is appropriate, but there are situations where you may want to change this:

- If you use structures as members of a collection, each access to an element of the collection incurs the cost of boxing or unboxing. Depending on your situation, the performance penalty may be noticeable.
- On occasion, it is useful to be able to assign null to a structure, for example, to support "not there" semantics (such as when implementing parameters that are conceptually optional).

To allow you to choose the correct performance and functionality trade-off, the Slice-to-C# compiler provides an alternative mapping of structures to classes, for example:

Slice
<pre>["clr:class"] struct Point { double x; double y; };</pre>

The `"clr:class"` metadata directive instructs the Slice-to-C# compiler to generate a mapping to a C# partial class for this structure. The generated code is almost identical, except that the keyword `struct` is replaced by the keyword `class` and that the class has a default constructor and inherits from `ICloneable`:

C#
<pre>public partial class Point : _System.ICloneable { public double x; public double y; public Point(); public Point(double x, double y); public object Clone(); public override int GetHashCode(); public override bool Equals(object other); public static bool operator==(Point lhs, Point rhs); public static bool operator!=(Point lhs, Point rhs); }</pre>



Some of the generated marshaling code differs for the class mapping of structures, but this is irrelevant to application code.

The class has a default constructor that default-constructs each data member. This means members of primitive type are initialized to the equivalent of zero, and members of reference type are initialized to null. Note that applications must always explicitly initialize a member whose type is a class-mapped structure because the Ice run time does not accept null as a legal value for these types.

If you wish to ensure that data members of primitive and enumerated types are initialized to specific values, you can declare default values in your [Slice definition](#). The default constructor initializes each of these data members to its declared value.

The class also provides a second constructor that has one parameter for each data member. This allows you to construct and initialize a class instance in a single statement:

```
C#  
Point p = new Point(5.1, 7.8);
```

The `Clone` method performs a shallow memberwise copy, and the comparison methods have the usual semantics (they perform value comparison).

Note that you can influence the mapping for structures only at the point of definition of a structure, that is, for a particular structure type, you must decide whether you want to use the structure or the class mapping. (You cannot override the structure mapping elsewhere, for example, for individual structure members or operation parameters.)

As we mentioned previously, if a Slice structure (recursively) contains a member of reference type, it is automatically mapped to a C# class. (The compiler behaves as if you had explicitly specified the `"clr:class"` metadata directive for the structure.)

Here is our [Employee](#) structure once more:

```
Slice  
struct Employee {  
    long number;  
    string firstName;  
    string lastName;  
};
```

The structure contains two strings, which are reference types, so the Slice-to-C# compiler generates a C# class for this structure:

C#

```

public partial class Employee : _System.ICloneable
{
    public long number;
    public string firstName;
    public string lastName;

    public Employee();
    public Employee(long number, string firstName, string lastName);

    public object Clone();

    public override int GetHashCode();
    public override bool Equals(object other);

    public static bool operator==(Employee lhs, Employee rhs);
    public static bool operator!=(Employee lhs, Employee rhs);
}

```

Property Mapping for Structures in C#

You can instruct the compiler to emit property definitions instead of public data members. For example:

Slice

```

["clr:property"] struct Point {
    double x;
    double y;
};

```

The "clr:property" metadata directive causes the compiler to generate a property for each Slice data member:

C#

```

public partial struct Point
{
    private double x_prop;
    public double x {
        get {
            return x_prop;
        }
        set {
            x_prop = value;
        }
    }

    private double y_prop;
    public double y {
        get {
            return y_prop;
        }
        set {
            y_prop = value;
        }
    }

    // Other methods here...
}

```

Note that the properties are non-virtual because C# structures cannot have virtual properties. However, if you apply the "clr:property" directive to a structure that contains a member of reference type, or if you combine the "clr:property" and "clr:class" directives, the generated properties are virtual. For example:

Slice

```

["clr:property", "clr:class"]
struct Point {
    double x;
    double y;
};

```

This generates the following code:

C#

```
public partial class Point : System.ICloneable
{
    private double x_prop;
    public virtual double x {
        get {
            return x_prop;
        }
        set {
            x_prop = value;
        }
    }

    private double y_prop;
    public virtual double y {
        get {
            return y_prop;
        }
        set {
            y_prop = value;
        }
    }

    // Other methods here...
}
```

See Also

- [Metadata](#)
- [C-Sharp Mapping for Identifiers](#)
- [C-Sharp Mapping for Modules](#)
- [C-Sharp Mapping for Built-In Types](#)
- [C-Sharp Mapping for Enumerations](#)
- [C-Sharp Mapping for Sequences](#)
- [C-Sharp Mapping for Dictionaries](#)
- [C-Sharp Collection Comparison](#)
- [C-Sharp Mapping for Constants](#)
- [C-Sharp Mapping for Exceptions](#)

C-Sharp Mapping for Sequences

Ice for .NET supports several different mappings for [sequences](#). By default, sequences are mapped to arrays. You can use [metadata directives](#) to map sequences to a number of alternative types:

- `System.Collections.Generic.List`
- `System.Collections.Generic.LinkedList`
- `System.Collections.Generic.Queue`
- `System.Collections.Generic.Stack`
- Types derived from `Ice.CollectionBase`, which is a drop-in replacement for `System.Collections.CollectionBase` (this mapping is provided mainly for compatibility with Ice versions prior to 3.3)
- User-defined custom types that derive from `System.Collections.Generic.IEnumerable<T>`.

The different mappings allow you to map sequences to a container type that provides the correct performance trade-off for your application.

On this page:

- [Array Mapping for Sequences in C#](#)
- [Mapping to Predefined Generic Containers for Sequences in C#](#)
- [Mapping to Custom Types for Sequences in C#](#)
- [CollectionBase Mapping for Sequences in C#](#)
- [Multi-Dimensional Sequences in C#](#)

Array Mapping for Sequences in C#

By default, the Slice-to-C# compiler maps sequences to arrays. Interestingly, no code is generated in this case; you simply define an array of elements to model the Slice sequence. For example:

```

Slice

sequence<Fruit> FruitPlatter;
```

Given this definition, to create a sequence containing an apple and an orange, you could write:

```

C#

Fruit[] fp = { Fruit.Apple, Fruit.Orange };
```

Or, alternatively:

```

C#

Fruit fp[] = new Fruit[2];
fp[0] = Fruit.Apple;
fp[1] = Fruit.Orange;
```

The array mapping for sequences is both simple and efficient, especially for sequences that do not need to provide insertion or deletion other than at the end of the sequence.

Mapping to Predefined Generic Containers for Sequences in C#

With metadata directives, you can change the default mapping for sequences to use generic containers provided by .NET. For example:

Slice

```
["clr:generic:List"] sequence<string> StringSeq;
["clr:generic:LinkedList"] sequence<Fruit> FruitSeq;
["clr:generic:Queue"] sequence<int> IntQueue;
["clr:generic:Stack"] sequence<double> DoubleStack;
```

The `"clr:generic:<type>"` metadata directive causes the `slice2cs` compiler to map the corresponding sequence to one of the containers in the `System.Collections.Generic` namespace. For example, the `Queue` sequence maps to `System.Collections.Generic.Queue<int>` due to its metadata directive.

The predefined containers allow you to select an appropriate space-performance trade-off, depending on how your application uses a sequence. In addition, if a sequence contains value types, such as `int`, the generic containers do not incur the cost of boxing and unboxing and so are quite efficient. (For example, `System.Collections.Generic.List<int>` performs within a few percentage points of an integer array for insertion and deletion at the end of the sequence, but has the advantage of providing a richer set of operations.)

Generic containers can be used for sequences of any element type except objects. For sequences of objects, only `List` is supported because it provides the functionality required for efficient unmarshaling. Metadata that specifies any other generic type is ignored with a warning:

Slice

```
class MyClass {
    // ...
};

["clr:generic:List"]
sequence<MyClass> MyClassList; // OK

["clr:generic:LinkedList"]
sequence<MyClass> MyClassLinkedList; // Ignored
```

In this example, sequence type `MyClassList` maps to the generic container `System.Collections.Generic.List<MyClass>`, but sequence type `MyClassLinkedList` uses the default array mapping.

Mapping to Custom Types for Sequences in C#

If the array mapping and the predefined containers are unsuitable for your application (for example, because you may need a priority queue, which does not come with .NET), you can implement your own custom containers and direct `slice2cs` to map sequences to these custom containers. For example:

Slice

```
["clr:generic:MyTypes.PriorityQueue"] sequence<int> Queue;
```

This metadata directive causes the `Slice Queue` sequence to be mapped to the type `MyTypes.PriorityQueue`. You must specify the fully-qualified name of your custom type following the `clr:generic:` prefix. This is because the generated code prepends a `global::` qualifier to the type name you provide; for the preceding example, the generated code refers to your custom type as `global::MyTypes.PriorityQueue<int>`.

Your custom type can have whatever interface you deem appropriate, but it must meet the following requirements:

- The custom type must derive from `System.Collections.Generic.IEnumerable<T>`.
- The custom type must provide a readable `Count` property that returns the number of elements in the collection.
- The custom type must provide an `Add` method that appends an element to the end of the collection.
- If (and only if) the Slice sequence contains elements that are Slice classes, the custom type must provide an indexer that sets the value of an element at a specific index. (Indexes, as usual, start at zero.)

As an example, here is a minimal class (omitting implementation) that meets these criteria:

```

C#

public class PriorityQueue<T> : IEnumerable<T>
{
    public IEnumerator<T> GetEnumerator();

    public int Count
        get;

    public void Add(T elmt);

    public T this[int index] // Needed for class elements only.
        set;

    // Other methods and data members here...
}

```

CollectionBase Mapping for Sequences in C#

The `CollectionBase` mapping is provided mainly for compatibility with Ice versions prior to 3.3. Internally, `CollectionBase` is implemented using `System.Collections.Generic.List<T>`, so it offers the same performance trade-offs as `List<T>`. (For value types, `Ice.CollectionBase` is considerably faster than `System.Collections.CollectionBase`, however.)

`Ice.CollectionBase` is not as type-safe as `List<T>` because, in order to remain source-code compatible with `System.Collections.CollectionBase`, it provides methods that accept elements of type `object`. This means that, if you pass an element of the wrong type, the problem will be diagnosed only at run time, instead of at compile time. For this reason, we suggest that you do not use the `CollectionBase` mapping for new code.

To enable the `CollectionBase` mapping, you must use the `"clr:collection"` metadata directive:

```

Slice

["clr:collection"] sequence<Fruit> FruitPlatter;

```

With this directive, `slice2cs` generates a type that derives from `Ice.CollectionBase`:

C#

```

public class FruitPlatter : Ice.CollectionBase<M.Fruit>,
System.ICloneable
{
    public FruitPlatter();
    public FruitPlatter(int capacity);
    public FruitPlatter(Fruit[] a);
    public FruitPlatter(System.Collections.Generic.IEnumerable<Fruit> l
);

    public static implicit operator
_System.Collections.Generic.List<Fruit>(FruitPlatter s);

    public virtual FruitPlatter GetRange(int index, int count);

    public static FruitPlatter Repeat(Fruit value, int count);

    public object Clone();
}

```

The generated `FruitPlatter` class provides the following methods:

- `FruitPlatter();`
`FruitPlatter(int capacity);`
`FruitPlatter(Fruit[] a);`
`FruitPlatter(IEnumerable<Fruit> l);`
 Apart from calling the default constructor, you can also specify an initial capacity for the sequence or, using the array constructor, initialize a sequence from an array. In addition, you can initialize the class to contain the same elements as any enumerable collection with the same element type.
- `FruitPlatter GetRange(int index, int count);`
 This method returns a new sequence with `count` elements that are copied from the source sequence beginning at `index`.
- `FruitPlatter Repeat(Fruit value, int count);`
 This method returns a sequence with `count` elements that are initialized to `value`.
- `object Clone();`
 The `Clone` method returns a shallow copy of the source sequence.
- `static implicit operator List<Fruit> (FruitPlatter s);`
 This operator performs an implicit conversion of a `FruitPlatter` instance to a `List<Fruit>`, so you can pass a `FruitPlatter` sequence where a `List<Fruit>`, `IEnumerable<Fruit>`, or `System.Collections.IEnumerable` is expected.

The remaining methods are provided by the generic `Ice.CollectionBase` base class. This class provides the following methods:

- `CollectionBase();`
`CollectionBase(int capacity);`
`CollectionBase(T[] a);`
`CollectionBase(IEnumerable<T> l);`
 The constructors initialize the sequence as for the concrete derived class.
- `int Count { get; }`
 This property returns the number of elements of the sequence.

- `int Capacity { get; set; }`
This property controls the capacity of the sequence. Its semantics are as for the corresponding property of `List<T>`.
- `virtual void TrimToSize();`
This method sets the capacity of the sequence to the actual number of elements.
- `int Add(object o);`
`int Add(T value);`
These methods append `value` at the end of the sequence. They return the index at which the element is inserted (which always is the value of `Count` prior the call to `Add`.)
- `void Insert(int index, object o);`
`void Insert(int index, T value);`
These methods insert an element at the specified index.
- `virtual void InsertRange(int index, CollectionBase<T> c);`
`virtual void InsertRange(int index, T[] c);`
These methods insert a range of values into the sequence starting at the given index.
- `virtual void SetRange(int index, CollectionBase<T> c);`
`virtual void SetRange(int index, T[] c);`
These methods copy the provided sequence over a range of elements in the target sequence, starting at the provided index, with semantics as for `System.Collections.ArrayList`.
- `void RemoveAt(int index);`
This method deletes the element at the specified index.
- `void Remove(object o);`
`void Remove(T value);`
These methods search for the specified element and, if present, delete that element. If the element is not in the sequence, the methods do nothing.
- `virtual void RemoveRange(int index, int count);`
This method removes `count` elements, starting at the given index.
- `void Clear();`
This method deletes all elements of the sequence.
- `bool Contains(object o);`
`bool Contains(T value);`
These methods return `true` if the sequence contains `value`; otherwise, they return `false`.
- `int IndexOf(object o);`
`int IndexOf(T value);`
These methods return the index of the specified element. If the element is not in the sequence, the return value is `-1`.
- `virtual int LastIndexOf(T value);`
`virtual int LastIndexOf(T value, int startIndex);`
`virtual int LastIndexOf(T value, int startIndex, int count);`
These methods search for the provided element and return its last occurrence in the sequence, as for `System.Collections.ArrayList.LastIndexOf`.
- `object this[int index] { get; set; }`
`T this[int index] { get; set; }`
The indexers allow you to read and write elements using array subscript notation.
- `IEnumerator<T> GetEnumerator();`
This method returns an enumerator that you can use to iterate over the collection.
- `static implicit operator List<T> (CollectionBase<T> s);`

As for the derived class, this operator permits implicit conversion to a `List<T>`.

- `void CopyTo(T[] a);`
`void CopyTo(T[] a, int i);`
`void CopyTo(int i, T[] a, int ai, int c);`
`void CopyTo(System.Array a, int i);`
 These methods copy the contents of a sequence into an array. The semantics are the same as for the corresponding methods of `List<T>`.
- `T[] ToArray();`
 The `ToArray` method returns the contents of the sequence as an array.
- `void AddRange(CollectionBase<T> s);`
`void AddRange(T[] a);`
 The `AddRange` methods append the contents of a sequence or an array to the current sequence, respectively.
- `virtual void Sort();`
`virtual void Sort(System.Collections.IComparer comparer);`
`virtual void Sort(int index, int count, System.Collections.IComparer comparer);`
 These methods sort the sequence.
- `virtual void Reverse();`
`virtual void Reverse(int index, int count);`
 These methods reverse the order of elements of the sequence.
- `virtual int BinarySearch(T value);`
`virtual int BinarySearch(T value, System.Collections.IComparer comparer);`
`virtual int BinarySearch(int index, int count, T value, System.Collections.IComparer comparer);`
 The methods perform a binary search on the sequence, with semantics as for `System.Collections.ArrayList`.
- `static FruitPlatter Repeat(Fruit value, int count);`
 This method returns a sequence with `count` elements that are initialized to `value`.

Note that for all methods that return sequences, these methods perform a shallow copy, that is, if you have a sequence whose elements have reference type, what is copied are the references, not the objects denoted by those references.

`Ice.CollectionBase` also provides the usual `GetHashCode` and `Equals` methods, as well as the comparison operators for equality and inequality. (Two sequences are equal if they have the same number of elements and all elements in corresponding positions are equal, as determined by the `Equals` method of the elements.)

`Ice.CollectionBase` also implements the inherited `IsFixedSize`, `IsReadOnly`, and `IsSynchronized` properties (which return `false`), and the inherited `SyncRoot` property (which returns `this`).

Creating a sequence containing an apple and an orange is simply a matter of writing:

```

C#

FruitPlatter fp = new FruitPlatter();
fp.Add(Fruit.Apple);
fp.Add(Fruit.Orange);
```

Multi-Dimensional Sequences in C#

`Slice` permits you to define sequences of sequences, for example:

Slice

```
enum Fruit { Apple, Orange, Pear };
["clr:generic:List"] sequence<Fruit> FruitPlatter;
["clr:generic:LinkedList"] sequence<FruitPlatter> Cornucopia;
```

If we use these definitions as shown, the type of `FruitPlatter` in the generated code is:

C#

```
System.Collections.Generic.LinkedList<System.Collections.Generic.List<Fruit>>
```

Here the outer sequence contains elements of type `List<Fruit>`, as you would expect.

Now let us modify the definition to change the mapping of `FruitPlatter` to an array:

Slice

```
enum Fruit { Apple, Orange, Pear };
sequence<Fruit> FruitPlatter;
["clr:LinkedList"] sequence<FruitPlatter> Cornucopia;
```

With this definition, the type of `Cornucopia` becomes:

C#

```
System.Collections.Generic.LinkedList<Fruit[]>
```

The generated code now no longer mentions the type `FruitPlatter` anywhere and deals with the outer sequence elements as an array of `Fruit` instead.

See Also

- [Metadata](#)
- [C-Sharp Mapping for Identifiers](#)
- [C-Sharp Mapping for Modules](#)
- [C-Sharp Mapping for Built-In Types](#)
- [C-Sharp Mapping for Enumerations](#)
- [C-Sharp Mapping for Structures](#)
- [C-Sharp Mapping for Dictionaries](#)
- [C-Sharp Collection Comparison](#)
- [C-Sharp Mapping for Constants](#)
- [C-Sharp Mapping for Exceptions](#)

C-Sharp Mapping for Dictionaries

Ice for .NET supports three different mappings for dictionaries. By default, dictionaries are mapped to `System.Collections.Generic.Dictionary<T>`. You can use [metadata directives](#) to map dictionaries to two other types:

- `System.Collections.Generic.SortedDictionary`
- Types derived from `Ice.DictionaryBase`, which is a drop-in replacement for `System.Collections.DictionaryBase` (this mapping is provided mainly for compatibility with Ice versions prior to 3.3)

On this page:

- [Mapping to Predefined Containers for Dictionaries in C#](#)
- [DictionaryBase mapping for Dictionaries in C#](#)

Mapping to Predefined Containers for Dictionaries in C#

Here is the definition of our `EmployeeMap` once more:

Slice
<code>dictionary<long, Employee> EmployeeMap;</code>

By default, the Slice-to-C# compiler maps the dictionary to the following type:

C#
<code>System.Collections.Generic.Dictionary<long, Employee></code>

You can use the `"clr:generic:SortedDictionary"` metadata directive to change the mapping to a sorted dictionary:

Slice
<code>["clr:generic:SortedDictionary"] dictionary<long, Employee> EmployeeMap;</code>

With this definition, the type of the dictionary becomes:

C#
<code>System.Collections.Generic.SortedDictionary<long, Employee></code>

DictionaryBase mapping for Dictionaries in C#

The `DictionaryBase` mapping is provided mainly for compatibility with Ice versions prior to 3.3. Internally, `DictionaryBase` is implemented using `System.Collections.Generic.Dictionary<T>`, so it offers the same performance trade-offs as `Dictionary<T>`. (For value types, `Ice.DictionaryBase` is considerably faster than `System.Collections.DictionaryBase`, however.)

`Ice.DictionaryBase` is not as type-safe as `Dictionary<T>` because, in order to remain source code compatible with `System.Collections.DictionaryBase`, it provides methods that accept elements of type `object`. This means that, if you pass an element of the wrong type, the problem will be diagnosed only at run time, instead of at compile time. For this reason, we suggest that you do not use the `Dictio`

naryBase mapping for new code.

To enable the DictionaryBase mapping, you must use the "clr:collection" metadata directive:

Slice
<pre>["clr:collection"] dictionary<long, Employee> EmployeeMap;</pre>

With this directive, slice2cs generates a type that derives from Ice.CollectionBase:

C#
<pre>public class EmployeeMap : Ice.DictionaryBase<long, Employee>, System.ICloneable { public void AddRange(EmployeeMap m); public object Clone(); }</pre>

Note that the generated EmployeeMap class derives from Ice.DictionaryBase, which provides a super-set of the interface of the .NET System.Collections.DictionaryBase class. Apart from methods inherited from DictionaryBase, the class provides a Clone method and an AddRange method that allows you to append the contents of one dictionary to another. If the target dictionary contains a key that is also in the source dictionary, the target dictionary's value is preserved. For example:

C#

```
Employee e1 = new Employee();
e1.number = 42;
e1.firstName = "Herb";
e1.lastName = "Sutter";

EmployeeMap em1 = new EmployeeMap();
em[42] = e;

Employee e2 = new Employee();
e2.number = 42;
e2.firstName = "Stan";
e2.lastName = "Lipmann";

EmployeeMap em2 = new EmployeeMap();
em[42] = e2;

// Add contents of em2 to em1
//
em1.AddRange(em2);

// Equal keys preserve the original value
//
Debug.Assert(em1[42].firstName.Equals("Herb"));
```

The DictionaryBase class provides the following methods:

C#

```

public abstract class DictionaryBase<KT, VT>
    : System.Collections.IDictionary
{
    public DictionaryBase();

    public int Count { get; }

    public void Add(KT key, VT value);
    public void Add(object key, object value);

    public void CopyTo(System.Array a, int index);

    public void Remove(KT key);
    public void Remove(object key);

    public void Clear();

    public System.Collections.ICollection Keys { get; }
    public System.Collections.ICollection Values { get; }

    public VT this[KT key] { get; set; }
    public object this[object key] { get; set; }

    public bool Contains(KT key);
    public bool Contains(object key);

    public override int GetHashCode();
    public override bool Equals(object other);
    public static bool operator==(DictionaryBase<KT, VT> lhs,
DictionaryBase<KT, VT> rhs);
    public static bool operator!=(DictionaryBase<KT, VT> lhs, Dictionar
yBase<KT, VT> rhs);

    public System.Collections.IEnumerator GetEnumerator();

    public bool IsFixedSize { get; }
    public bool IsReadOnly { get; }
    public bool IsSynchronized { get; }
    public object SyncRoot { get; }
}

```

The methods have the same semantics as the corresponding methods in the .NET Framework. The `Equals` method returns true if two dictionaries contain the same number of entries and, for each entry, the key and value are the same (as determined by their `Equals` methods).

The `Clone` method performs a shallow copy.

The class also implements the inherited `IsFixedSize`, `IsReadOnly`, and `IsSynchronized` properties (which return false), and the `Sync`

Root property (which returns `this`).

See Also

- [Metadata](#)
- [C-Sharp Mapping for Identifiers](#)
- [C-Sharp Mapping for Modules](#)
- [C-Sharp Mapping for Built-In Types](#)
- [C-Sharp Mapping for Enumerations](#)
- [C-Sharp Mapping for Structures](#)
- [C-Sharp Mapping for Sequences](#)
- [C-Sharp Collection Comparison](#)
- [C-Sharp Mapping for Constants](#)
- [C-Sharp Mapping for Exceptions](#)

C-Sharp Collection Comparison

The utility class `Ice.CollectionComparer` allows you to compare collections for equality:

```

C#



```
public class CollectionComparer {
 public static bool
 Equals(System.Collections.IDictionary d1,
 System.Collections.IDictionary d2);

 public static bool
 Equals(System.Collections.ICollection c1,
 System.Collections.ICollection c2);

 public static bool
 Equals(System.Collections.IEnumerable c1,
 System.Collections.IEnumerable c2);
}
```

```

Equality of the elements in a collection is determined by calling the elements' `Equals` method.

Two dictionaries are equal if they contain the same number of entries with identical keys and values.

Two collections that derive from `ICollection` or `IEnumerable` are equal if they contain the same number of entries and entries compare equal. Note that order is significant, so corresponding entries must not only be equal but must also appear in the same position.

See Also

- [C-Sharp Mapping for Identifiers](#)
- [C-Sharp Mapping for Modules](#)
- [C-Sharp Mapping for Built-In Types](#)
- [C-Sharp Mapping for Enumerations](#)
- [C-Sharp Mapping for Structures](#)
- [C-Sharp Mapping for Sequences](#)
- [C-Sharp Mapping for Dictionaries](#)
- [C-Sharp Mapping for Constants](#)
- [C-Sharp Mapping for Exceptions](#)

C-Sharp Mapping for Constants

Here are the sample `constant definitions` once more:

```

Slice

const bool      AppendByDefault = true;  
const byte     LowerNibble = 0x0f;  
const string   Advice = "Don't Panic!";  
const short    TheAnswer = 42;  
const double   PI = 3.1416;  
  
enum Fruit { Apple, Pear, Orange };  
const Fruit    FavoriteFruit = Pear;
```

Here are the generated definitions for these constants:

C#

```

public abstract class AppendByDefault
{
    public const bool value = true;
}

public abstract class LowerNibble
{
    public const byte value = 15;
}

public abstract class Advice
{
    public const string value = "Don't Panic!";
}

public abstract class TheAnswer
{
    public const short value = 42;
}

public abstract class PI
{
    public const double value = 3.1416;
}

public enum Fruit { Apple, Pear, Orange }

public abstract class FavoriteFruit
{
    public const Fruit value = Fruit.Pear;
}

```

As you can see, each Slice constant is mapped to a class with the same name as the constant. The class contains a member named `value` that holds the value of the constant.



The mapping to classes instead of to plain constants is necessary because C# does not permit constant definitions at namespace scope.

See Also

- [Constants and Literals](#)
- [C-Sharp Mapping for Identifiers](#)
- [C-Sharp Mapping for Modules](#)
- [C-Sharp Mapping for Built-In Types](#)
- [C-Sharp Mapping for Enumerations](#)
- [C-Sharp Mapping for Structures](#)
- [C-Sharp Mapping for Sequences](#)
- [C-Sharp Mapping for Dictionaries](#)

- [C-Sharp Collection Comparison](#)
- [C-Sharp Mapping for Exceptions](#)

C-Sharp Mapping for Exceptions

On this page:

- [Inheritance Hierarchy for Exceptions in C#](#)
- [C# Mapping for User Exceptions](#)
- [C# Default Constructors for User Exceptions](#)
- [C# Mapping for Run-Time Exceptions](#)

Inheritance Hierarchy for Exceptions in C#

The mapping for exceptions is based on the inheritance hierarchy shown below:

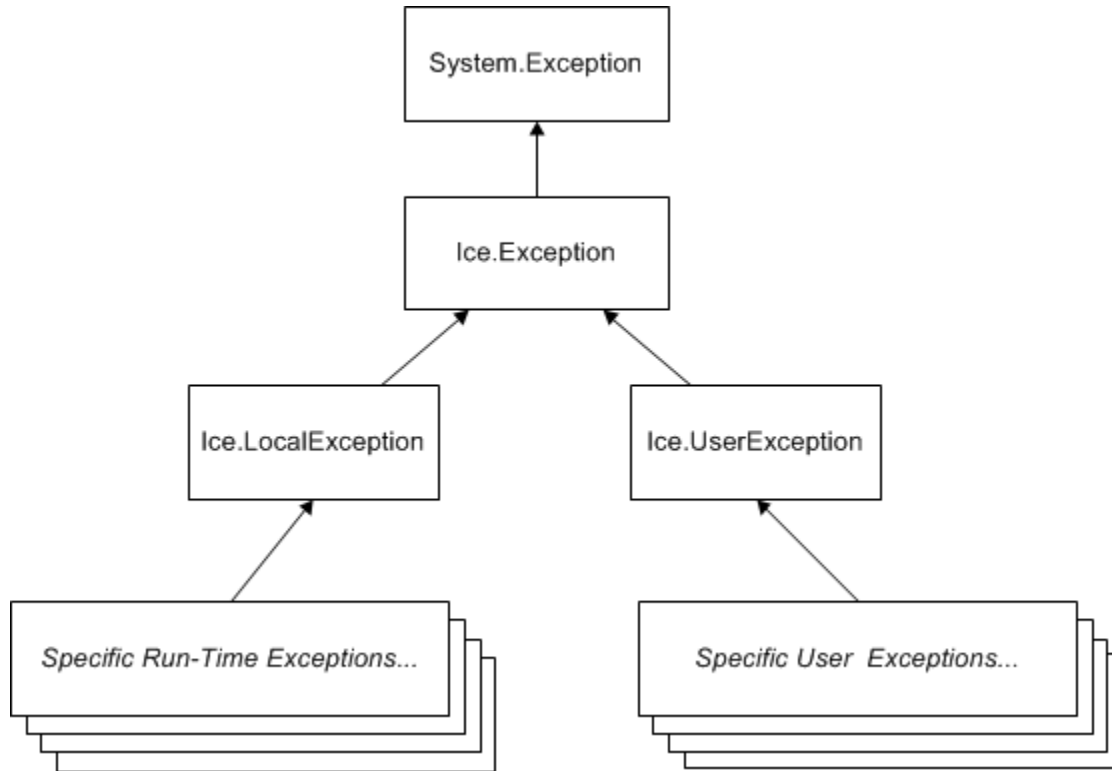

Inheritance structure for exceptions.

The ancestor of all exceptions is `System.Exception`. Derived from that is `Ice.Exception`, which provides the definitions of a number of constructors. `Ice.LocalException` and `Ice.UserException` are derived from `Ice.Exception` and form the base of all run-time and user exceptions, respectively.

The constructors defined in `Ice.Exception` have the following signatures:

C#
<pre> public abstract class Exception : System.Exception { public Exception(); public Exception(System.Exception ex); } </pre>

Each concrete derived exception class implements these constructors. The second constructor initializes the `InnerException` property of `System.Exception`. (Both constructors set the `Message` property to the empty string.)

C# Mapping for User Exceptions

Here is a fragment of the Slice definition for our world time server once more:

```

Slice



```
exception GenericError {
 string reason;
};

exception BadTimeVal extends GenericError {};

exception BadZoneName extends GenericError {};
```

```

These exception definitions map as follows:

C#

```

public partial class GenericError : Ice.UserException
{
    public string reason;

    public GenericError();
    public GenericError(System.Exception ex__);
    public GenericError(string reason);
    public GenericError(string reason, System.Exception ex__);

    // GetHashCode and comparison methods defined here,
    // as well as mapping-internal methods.
}

public partial class BadTimeVal : M.GenericError
{
    public BadTimeVal();
    public BadTimeVal(System.Exception ex__);
    public BadTimeVal(string reason);
    public BadTimeVal(string reason, System.Exception ex__);

    // GetHashCode and comparison methods defined here,
    // as well as mapping-internal methods.
}

public partial class BadZoneName : M.GenericError
{
    public BadZoneName();
    public BadZoneName(System.Exception ex__);
    public BadZoneName(string reason);
    public BadZoneName(string reason, System.Exception ex__);

    // GetHashCode and comparison methods defined here,
    // as well as mapping-internal methods.
}

```

Each Slice exception is mapped to a C# partial class with the same name. For each exception member, the corresponding class contains a public data member. (Obviously, because `BadTimeVal` and `BadZoneName` do not have members, the generated classes for these exceptions also do not have members.) [Optional data members](#) are mapped to instances of the `Ice.Optional` type.

The inheritance structure of the Slice exceptions is preserved for the generated classes, so `BadTimeVal` and `BadZoneName` inherit from `GenericError`.

All user exceptions are derived from the base class `Ice.UserException`. This allows you to catch all user exceptions generically by installing a handler for `Ice.UserException`. Similarly, you can catch all Ice run-time exceptions with a handler for `Ice.LocalException`, and you can catch all Ice exceptions with a handler for `Ice.Exception`.

All exceptions provide the usual `GetHashCode` and `Equals` methods, as well as the `==` and `!=` comparison operators.

The generated exception classes also contain other member functions that are not shown here; these member functions are internal to the

C# mapping and are not meant to be called by application code.

C# Default Constructors for User Exceptions

Exceptions have a default constructor that default-constructs each data member. This means members of primitive type are initialized to the equivalent of zero, and members of reference type are initialized to null. Note that applications must always explicitly initialize a member whose type is a [class-mapped structure](#) because the Ice run time does not accept null as a legal value for these types.

If you wish to ensure that data members of primitive and enumerated types are initialized to specific values, you can declare default values in your [Slice definition](#). The default constructor initializes each of these data members to its declared value.

An exception also provides a constructor that accepts one parameter for each data member so that you can construct and initialize a class instance in a single statement (instead of first having to construct the instance and then assign to its members). For a derived exception, this constructor accepts one argument for each base exception member, plus one argument for each derived exception member, in base-to-derived order. For each optional data member, the constructor accepts an `Ice.Optional` parameter of the appropriate type.

C# Mapping for Run-Time Exceptions

The Ice run time throws run-time exceptions for a number of pre-defined error conditions. All run-time exceptions directly or indirectly derive from `Ice.LocalException` (which, in turn, derives from `Ice.Exception`).

`Ice.LocalException` implements a `Clone` method that is inherited by its derived exceptions, so you can make memberwise shallow copies of exceptions.

By catching exceptions at the appropriate point in the inheritance hierarchy, you can handle exceptions according to the category of error they indicate:

- `Ice.Exception`
This is the root of the inheritance tree for both run-time and user exceptions.
- `Ice.LocalException`
This is the root of the inheritance tree for run-time exceptions.
- `Ice.UserException`
This is the root of the inheritance tree for user exceptions.
- `Ice.TimeoutException`
This is the base exception for both operation-invocation and connection-establishment timeouts.
- `Ice.ConnectTimeoutException`
This exception is raised when the initial attempt to establish a connection to a server times out.

For example, a `ConnectTimeoutException` can be handled as `ConnectTimeoutException`, `TimeoutException`, `LocalException`, or `Exception`.

You will probably have little need to catch run-time exceptions as their most-derived type and instead catch them as `LocalException`; the fine-grained error handling offered by the remainder of the hierarchy is of interest mainly in the implementation of the Ice run time. Exceptions to this rule are the exceptions related to [facet](#) and [object](#) life cycles, which you may want to catch explicitly. These exceptions are `FacetNotExistException` and `ObjectNotExistException`, respectively.

See Also

- [User Exceptions](#)
- [Run-Time Exceptions](#)
- [C-Sharp Mapping for Identifiers](#)
- [C-Sharp Mapping for Modules](#)
- [C-Sharp Mapping for Built-In Types](#)
- [C-Sharp Mapping for Enumerations](#)
- [C-Sharp Mapping for Structures](#)
- [C-Sharp Mapping for Sequences](#)

- [C-Sharp Mapping for Dictionaries](#)
- [C-Sharp Collection Comparison](#)
- [C-Sharp Mapping for Constants](#)
- [C-Sharp Mapping for Optional Values](#)
- [Facets and Versioning](#)
- [Object Life Cycle](#)

C-Sharp Mapping for Interfaces

The mapping of Slice [interfaces](#) revolves around the idea that, to invoke a remote operation, you call a member function on a local class instance that is a [proxy](#) for the remote object. This makes the mapping easy and intuitive to use because making a remote procedure call is no different from making a local procedure call (apart from error semantics).

On this page:

- [Proxy Interfaces in C#](#)
- [The `Ice.ObjectPrx` Interface in C#](#)
- [Proxy Helpers in C#](#)
- [Using Proxy Methods in C#](#)
- [Object Identity and Proxy Comparison in C#](#)

Proxy Interfaces in C#

On the client side, a Slice interface maps to a C# interface with member functions that correspond to the operations on that interface. Consider the following simple interface:

Slice
<pre>interface Simple { void op(); };</pre>

The Slice compiler generates the following definition for use by the client:

C#
<pre>public interface SimplePrx : Ice.ObjectPrx { void op(); void op(System.Collections.Generic.Dictionary<string, string> __context); }</pre>

As you can see, the compiler generates a *proxy interface* `SimplePrx`. In general, the generated name is `<interface-name>Prx`. If an interface is nested in a module `M`, the generated interface is part of namespace `M`, so the fully-qualified name is `M.<interface-name>Prx`.

In the client's address space, an instance of `SimplePrx` is the local ambassador for a remote instance of the `Simple` interface in a server and is known as a *proxy instance*. All the details about the server-side object, such as its address, what protocol to use, and its object identity are encapsulated in that instance.

Note that `SimplePrx` inherits from `Ice.ObjectPrx`. This reflects the fact that all Ice interfaces implicitly inherit from `Ice::Object`.

For each operation in the interface, the proxy class has a member function of the same name. For the preceding example, we find that the operation `op` has been mapped to the method `op`. Also note that `op` is overloaded: the second version of `op` has a parameter `__context`, which is a dictionary of string pairs. This parameter is for use by the Ice run time to store information about how to deliver a request. You normally do not need to use it. (We examine the `__context` parameter in detail in [Request Contexts](#). The parameter is also used by `IceStor` m.)

Because all the `<interface-name>Prx` types are interfaces, you cannot instantiate an object of such a type. Instead, proxy instances are always instantiated on behalf of the client by the Ice run time, so client code never has any need to instantiate a proxy directly. The proxy references handed out by the Ice run time are always of type `<interface-name>Prx`; the concrete implementation of the interface is part of the Ice run time and does not concern application code.

A value of `null` denotes the null proxy. The null proxy is a dedicated value that indicates that a proxy points "nowhere" (denotes no object).

The `Ice.ObjectPrx` Interface in C#

All Ice objects have `Object` as the ultimate ancestor type, so all proxies inherit from `Ice.ObjectPrx`. `ObjectPrx` provides a number of methods:

```

C#
namespace Ice
{
    public interface ObjectPrx
    {
        Identity ice_getIdentity();
        bool ice_isA(string id);
        string ice_id();
        void ice_ping();

        int GetHashCode();
        bool Equals(object r);

        // Defined in a helper class:
        //
        public static bool Equals(Ice.ObjectPrx lhs, ObjectPrx rhs);
        public static bool operator==(ObjectPrx lhs, ObjectPrx rhs);
        public static bool operator!=(ObjectPrx lhs, ObjectPrx rhs);

        // ...
    }
}

```

Note that the static methods are not actually defined in `Ice.ObjectPrx`, but in a helper class that becomes a base class of an instantiated proxy. However, this is simply an internal detail of the C# mapping — conceptually, these methods belong with `Ice.ObjectPrx`, so we discuss them here.

The methods behave as follows:

- **`ice_getIdentity`**

This method returns the identity of the object denoted by the proxy. The identity of an Ice object has the following `Slice` type:

```

Slice
module Ice {
    struct Identity {
        string name;
        string category;
    };
};

```

To see whether two proxies denote the same object, first obtain the identity for each object and then compare the identities:

C#

```
Ice.ObjectPrx o1 = ...;
Ice.ObjectPrx o2 = ...;
Ice.Identity i1 = o1.ice_getIdentity();
Ice.Identity i2 = o2.ice_getIdentity();

if (i1.Equals(i2))
    // o1 and o2 denote the same object
else
    // o1 and o2 denote different objects
```

- **ice_isA**

The `ice_isA` method determines whether the object denoted by the proxy supports a specific interface. The argument to `ice_isA` is a [type ID](#). For example, to see whether a proxy of type `ObjectPrx` denotes a `Printer` object, we can write:

C#

```
Ice.ObjectPrx o = ...;
if (o != null && o.ice_isA("::Printer"))
    // o denotes a Printer object
else
    // o denotes some other type of object
```

Note that we are testing whether the proxy is null before attempting to invoke the `ice_isA` method. This avoids getting a `NullReferenceException` if the proxy is null.

- **ice_ids**

The `ice_ids` method returns an array of strings representing all of the [type IDs](#) that the object denoted by the proxy supports.

- **ice_id**

The `ice_id` method returns the [type ID](#) of the object denoted by the proxy. Note that the type returned is the type of the actual object, which may be more derived than the static type of the proxy. For example, if we have a proxy of type `BasePrx`, with a static type ID of `::Base`, the return value of `ice_id` might be `::Base`, or it might something more derived, such as `::Derived`.

- **ice_ping**

The `ice_ping` method provides a basic reachability test for the object. If the object can physically be contacted (that is, the object exists and its server is running and reachable), the call completes normally; otherwise, it throws an exception that indicates why the object could not be reached, such as `ObjectNotExistException` or `ConnectTimeoutException`.

- **Equals**

This method compares two proxies for equality. Note that all aspects of proxies are compared by this operation, such as the communication endpoints for the proxy. This means that, in general, if two proxies compare unequal, that does *not* imply that they denote different objects. For example, if two proxies denote the same Ice object via different transport endpoints, `equals` returns `false` even though the proxies denote the same object.

The `ice_isA`, `ice_ids`, `ice_id`, and `ice_ping` methods are remote operations and therefore support an additional overloading that accepts a [request context](#). Also note that there are [other methods](#) in `ObjectPrx`, not shown here. These methods provide different ways to dispatch a call and also provide access to an object's [facets](#).

Proxy Helpers in C#

For each Slice interface, apart from the proxy interface, the Slice-to-C# compiler creates a helper class: for an interface `Simple`, the name of the generated helper class is `SimplePrxHelper`.

 You can ignore the `ObjectPrxHelperBase` base class — it exists for mapping-internal purposes.

The helper class contains two methods of interest:

```

C#
public class SimplePrxHelper : Ice.ObjectPrxHelperBase, SimplePrx
{
    public static SimplePrx checkedCast(Ice.ObjectPrx b);
    public static SimplePrx checkedCast(
        Ice.ObjectPrx b,
        System.Collections.Generic.Dictionary<string, string> ctx);
    public static SimplePrx uncheckedCast(Ice.ObjectPrx b)

    // ...
}

```

For `checkedCast`, if the passed proxy is for an object of type `Simple`, or a proxy for an object with a type derived from `Simple`, the cast returns a non-null reference to a proxy of type `SimplePrx`; otherwise, if the passed proxy denotes an object of a different type (or if the passed proxy is null), the cast returns a null reference.

Given a proxy of any type, you can use a `checkedCast` to determine whether the corresponding object supports a given type, for example:

```

C#
Ice.ObjectPrx obj = ...;           // Get a proxy from somewhere...

SimplePrx simple = SimplePrxHelper.checkedCast(obj);
if (simple != null)
    // Object supports the Simple interface...
else
    // Object is not of type Simple...

```

Note that a `checkedCast` contacts the server. This is necessary because only the implementation of an object in the server has definite knowledge of the type of an object. As a result, a `checkedCast` may throw a `ConnectTimeoutException` or an `ObjectNotExistException`. (This also explains the need for the helper class: the Ice run time must contact the server, so we cannot use a C# down-cast.)

In contrast, an `uncheckedCast` does not contact the server and unconditionally returns a proxy of the requested type. However, if you do use an `uncheckedCast`, you must be certain that the proxy really does support the type you are casting to; otherwise, if you get it wrong, you will most likely get a run-time exception when you invoke an operation on the proxy. The most likely error for such a type mismatch is `OperationNotExistException`. However, other exceptions, such as a marshaling exception are possible as well. And, if the object happens to have an operation with the correct name, but different parameter types, no exception may be reported at all and you simply end up sending the invocation to an object of the wrong type; that object may do rather nonsensical things. To illustrate this, consider the following two interfaces:

Slice

```
interface Process {
    void launch(int stackSize, int dataSize);
};

// ...

interface Rocket {
    void launch(float xCoord, float yCoord);
};
```

Suppose you expect to receive a proxy for a `Process` object and use an `uncheckedCast` to down-cast the proxy:

C#

```
Ice.ObjectPrx obj = ...; // Get proxy...
ProcessPrx process
= ProcessPrxHelper.uncheckedCast(obj); // No worries...
process.launch(40, 60); // Oops...
```

If the proxy you received actually denotes a `Rocket` object, the error will go undetected by the Ice run time: because `int` and `float` have the same size and because the Ice protocol does not tag data with its type on the wire, the implementation of `Rocket::launch` will simply misinterpret the passed integers as floating-point numbers.

In fairness, this example is somewhat contrived. For such a mistake to go unnoticed at run time, both objects must have an operation with the same name and, in addition, the run-time arguments passed to the operation must have a total marshaled size that matches the number of bytes that are expected by the unmarshaling code on the server side. In practice, this is extremely rare and an incorrect `uncheckedCast` typically results in a run-time exception.

A final warning about down-casts: you must use either a `checkedCast` or an `uncheckedCast` to down-cast a proxy. If you use a C# cast, the behavior is undefined.

Using Proxy Methods in C#

The base proxy class `ObjectPrx` supports a variety of methods for [customizing a proxy](#). Since proxies are immutable, each of these "factory methods" returns a copy of the original proxy that contains the desired modification. For example, you can obtain a proxy configured with a ten second timeout as shown below:

C#

```
Ice.ObjectPrx proxy = communicator.stringToProxy(...);
proxy = proxy.ice_timeout(10000);
```

A factory method returns a new proxy object if the requested modification differs from the current proxy, otherwise it returns the current proxy. With few exceptions, factory methods return a proxy of the same type as the current proxy, therefore it is generally not necessary to repeat a `checkedCast` or `uncheckedCast` after using a factory method. However, a regular cast is still required, as shown in the example below:

C#

```
Ice.ObjectPrx base = communicator.stringToProxy(...);
HelloPrx hello = HelloPrxHelper.checkedCast(base);
hello = (HelloPrx)hello.ice_timeout(10000); # Type is preserved
hello.sayHello();
```

The only exceptions are the factory methods `ice_facet` and `ice_identity`. Calls to either of these methods may produce a proxy for an object of an unrelated type, therefore they return a base proxy that you must subsequently down-cast to an appropriate type.

Object Identity and Proxy Comparison in C#

Proxies provide an `Equals` method that compares proxies:

C#

```
public interface ObjectPrx {
    bool Equals(object r);
}
```

Note that proxy comparison with `Equals` uses *all* of the information in a proxy for the comparison. This means that not only the object identity must match for a comparison to succeed, but other details inside the proxy, such as the protocol and endpoint information, must be the same. In other words, comparison with `Equals` (or `==` and `!=`) tests for *proxy* identity, *not* object identity. A common mistake is to write code along the following lines:

C#

```
Ice.ObjectPrx p1 = ...;           // Get a proxy...
Ice.ObjectPrx p2 = ...;           // Get another proxy...

if (p1.Equals(p2)) {
    // p1 and p2 denote different objects           // WRONG!
} else {
    // p1 and p2 denote the same object           // Correct
}
```

Even though `p1` and `p2` differ, they may denote the same Ice object. This can happen because, for example, both `p1` and `p2` embed the same object identity, but each use a different protocol to contact the target object. Similarly, the protocols may be the same, but denote different endpoints (because a single Ice object can be contacted via several different transport endpoints). In other words, if two proxies compare equal with `Equals`, we know that the two proxies denote the same object (because they are identical in all respects); however, if two proxies compare unequal with `Equals`, we know absolutely nothing: the proxies may or may not denote the same object.

To compare the object identities of two proxies, you can use a helper function in the `Ice.Util` class:

C#

```
public sealed class Util {
    public static int proxyIdentityCompare(ObjectPrx lhs,
ObjectPrx rhs);
    public static int proxyIdentityAndFacetCompare(ObjectPrx lhs,
ObjectPrx rhs);
    // ...
}
```

`proxyIdentityCompare` allows you to correctly compare proxies for identity:

C#

```
Ice.ObjectPrx p1 = ...;           // Get a proxy...
Ice.ObjectPrx p2 = ...;           // Get another proxy...

if (Ice.Util.proxyIdentityCompare(p1, p2) != 0) {
    // p1 and p2 denote different objects      // Correct
} else {
    // p1 and p2 denote the same object        // Correct
}
```

The function returns 0 if the identities are equal, -1 if `p1` is less than `p2`, and 1 if `p1` is greater than `p2`. (The comparison uses `name` as the major and `category` as the minor sort key.)

The `proxyIdentityAndFacetCompare` function behaves similarly, but compares both the identity and the **facet name**.

The C# mapping also provides two helper classes in the `Ice` namespace that allow you to insert proxies into hashtables or ordered collections, based on the identity, or the identity plus the facet name:

C#

```
public class ProxyIdentityKey
    : System.Collections.IHashCodeProvider,
    System.Collections.IComparer {

    public int GetHashCode(object obj);
    public int Compare(object obj1, object obj2);
}

public class ProxyIdentityFacetKey
    : System.Collections.IHashCodeProvider,
    System.Collections.IComparer {

    public int GetHashCode(object obj);
    public int Compare(object obj1, object obj2);
}
```

Note these classes derive from `IHashCodeProvider` and `IComparer`, so they can be used for both hash tables and ordered collections.

See Also

- [Interfaces, Operations, and Exceptions](#)
- [Proxies](#)
- [C-Sharp Mapping for Operations](#)
- [Operations on Object](#)
- [Proxy Methods](#)
- [Facets and Versioning](#)
- [IceStorm](#)

C-Sharp Mapping for Operations

On this page:

- [Basic C# Mapping for Operations](#)
- [Normal and `idempotent` Operations in C#](#)
- [Passing Parameters in C#](#)
 - [In-Parameters in C#](#)
 - [Out-Parameters in C#](#)
 - [Null Parameters in C#](#)
 - [Optional Parameters in C#](#)
- [Exception Handling in C#](#)
 - [Exceptions and Out-Parameters in C#](#)

Basic C# Mapping for Operations

As we saw in the [C# mapping for interfaces](#), for each [operation](#) on an interface, the proxy class contains a corresponding member function with the same name. To invoke an operation, you call it via the proxy. For example, here is part of the definitions for our [file system](#):

```

Slice

module Filesystem {
    interface Node {
        idempotent string name();
    };
    // ...
};
```

The `name` operation returns a value of type `string`. Given a proxy to an object of type `Node`, the client can invoke the operation as follows:

```

C#

NodePrx node = ...;           // Initialize proxy
string name = node.name();    // Get name via RPC
```

This illustrates the typical pattern for receiving return values: return values are returned by reference for complex types, and by value for simple types (such as `int` or `double`).

Normal and `idempotent` Operations in C#

You can add an `idempotent` qualifier to a Slice operation. As far as the signature for the corresponding proxy method is concerned, `idempotent` has no effect. For example, consider the following interface:

```

Slice

interface Example {
    string op1();
    idempotent string op2();
};
```

The proxy interface for this is:

C#

```
public interface ExamplePrx : Ice.ObjectPrx
{
    string op1();
    string op2();
}
```

Because `idempotent` affects an aspect of call dispatch, not interface, it makes sense for the two methods to be mapped the same.

Passing Parameters in C#**In-Parameters in C#**

The parameter passing rules for the C# mapping are very simple: parameters are passed either by value (for value types) or by reference (for reference types). Semantically, the two ways of passing parameters are identical: it is guaranteed that the value of a parameter will not be changed by the invocation (with some caveats — see [Location Transparency](#)).

Here is an interface with operations that pass parameters of various types from client to server:

Slice

```
struct NumberAndString {
    int x;
    string str;
};

sequence<string> StringSeq;

dictionary<long, StringSeq> StringTable;

interface ClientToServer {
    void op1(int i, float f, bool b, string s);
    void op2(NumberAndString ns, StringSeq ss, StringTable st);
    void op3(ClientToServer* proxy);
};
```

The Slice compiler generates the following proxy for these definitions:

C#

```
public interface ClientToServerPrx : Ice.ObjectPrx
{
    void op1(int i, float f, bool b, string s);
    void op2(NumberAndString ns, string[] ss, Dictionary<long, string[]
> st);
    void op3(ClientToServerPrx proxy);
}
```

Given a proxy to a `ClientToServer` interface, the client code can pass parameters as in the following example:

C#

```
ClientToServerPrx p = ...; // Get proxy...

p.op1(42, 3.14f, true, "Hello world!"); // Pass simple literals

int i = 42;
float f = 3.14f;
bool b = true;
string s = "Hello world!";
p.op1(i, f, b, s); // Pass simple variables

NumberAndString ns = new NumberAndString();
ns.x = 42;
ns.str = "The Answer";
string[] ss = new string[1];
ss[0] = "Hello world!";
Dictionary<long, string[]> st = new Dictionary<long, string[]>();
st[0] = ss;
p.op2(ns, ss, st); // Pass complex variables

p.op3(p); // Pass proxy
```

Out-Parameters in C#

Slice out parameters simply map to C# out parameters.

Here again are the same Slice definitions we saw earlier, but this time with all parameters being passed in the `out` direction:

Slice

```

struct NumberAndString {
    int x;
    string str;
};

sequence<string> StringSeq;

dictionary<long, StringSeq> StringTable;

interface ServerToClient {
    void op1(out int i, out float f, out bool b, out string s);
    void op2(out NumberAndString ns, out StringSeq ss,
out StringTable st);
    void op3(out ServerToClient* proxy);
};

```

The Slice compiler generates the following code for these definitions:

C#

```

public interface ServerToClientPrx : Ice.ObjectPrx
{
    void op1(out int i, out float f, out bool b, out string s);
    void op2(out NumberAndString ns,
        out string[] ss,
        out Dictionary<long, string[]> st);
    void op3(out ServerToClientPrx proxy);
}

```

Given a proxy to a `ServerToClient` interface, the client code can pass parameters as in the following example:

```

C#
ClientToServerPrx p = ...;           // Get proxy...

int i;
float f;
bool b;
string s;
p.op1(out i, out f, out b, out s);

NumberAndString ns;
string[] ss;
Dictionary<long, string[]> st;
p.op2(out ns, out ss, out st);

ServerToClientPrx stc;
p.op3(out stc);

System.Console.WriteLine(i); // Show one of the values

```

Null Parameters in C#

Some Slice types naturally have "empty" or "not there" semantics. Specifically, C# sequences (if mapped to [CollectionBase](#)), dictionaries, strings, and structures (if mapped to [classes](#)) all can be `null`, but the corresponding Slice types do not have the concept of a null value.

- Slice sequences, dictionaries, and strings cannot be null, but can be empty. To make life with these types easier, whenever you pass a C# `null` reference as a parameter or return value of type sequence, dictionary, or string, the Ice run time automatically sends an empty sequence, dictionary, or string to the receiver.
- If you pass a C# `null` reference to a Slice structure that is mapped to a C# [class](#) as a parameter or return value, the Ice run time automatically sends a structure whose elements are default-initialized. This means that all proxy members are initialized to `null`, sequence and dictionary members are initialized to empty collections, strings are initialized to the empty string, and members that have a value type are initialized to their default values.

This behavior is useful as a convenience feature: especially for deeply-nested data types, members that are structures, sequences, dictionaries, or strings automatically arrive as an empty value at the receiving end. This saves you having to explicitly initialize, for example, every string element in a large sequence before sending the sequence in order to avoid `NullReferenceException`. Note that using null parameters in this way does *not* create null semantics for Slice sequences, dictionaries, or strings. As far as the object model is concerned, these do not exist (only *empty* sequences, dictionaries, and strings do). For example, whether you send a string as `null` or as an empty string makes no difference to the receiver: either way, the receiver sees an empty string.

Optional Parameters in C#

The mapping for [optional parameters](#) is the same as for required parameters, except each optional parameter is encapsulated in an `Ice.Optional` value. Consider the following operation:

Slice

```
optional(1) int execute(optional(2) string params, out optional(3) float
value);
```

The C# mapping for this operation is shown below:

C#

```
Ice.Optional<int> execute(Ice.Optional<string> params, out
Ice.Optional<float> value, ...);
```

The constructors and conversion operators provided by the `Ice.Optional` type simplify the use of optional parameters:

C#

```
Ice.Optional<int> i;
Ice.Optional<float> v;

i = proxy.execute("--file log.txt", out v); // string converted to
Optional<string>
i = proxy.execute(Ice.Util.None, out v);    // params is unset

if(v.HasValue)
    Console.WriteLine("value = " + v.Value);
```

A well-behaved program must not assume that an optional parameter always has a value.

Exception Handling in C#

Any operation invocation may throw a [run-time exception](#) and, if the operation has an exception specification, may also throw [user exceptions](#). Suppose we have the following simple interface:

Slice

```
exception Tantrum {
    string reason;
};

interface Child {
    void askToCleanUp() throws Tantrum;
};
```

Slice exceptions are thrown as C# exceptions, so you can simply enclose one or more operation invocations in a `try-catch` block:

C#

```
ChildPrx child = ...; // Get child proxy...

try
{
    child.askToCleanUp();
}
catch (Tantrum t)
{
    System.Console.Write("The child says: ");
    System.Console.WriteLine(t.reason);
}
```

Typically, you will catch only a few exceptions of specific interest around an operation invocation; other exceptions, such as unexpected run-time errors, will typically be handled by exception handlers higher in the hierarchy. For example:

C#

```

public class Client
{
    private static void run() {
        ChildPrx child = ...;           // Get child proxy...
        try
        {
            child.askToCleanUp();
        }
        catch (Tantrum t)
        {
            System.Console.WriteLine("The child says: ");
            System.Console.WriteLine(t.reason);
            child.scold();               // Recover from error...
        }
        child.praise();                 // Give positive feedback...
    }

    static void Main(string[] args)
    {
        try
        {
            // ...
            run();
            // ...
        }
        catch (Ice.Exception e)
        {
            System.Console.WriteLine(e);
        }
    }
}

```

This code handles a specific exception of local interest at the point of call and deals with other exceptions generically. (This is also the strategy we used for our [first simple application](#).)

Note that the `ToString` method of exceptions prints the name of the exception, any inner exceptions, and the stack trace. Of course, you can be more selective in the way exceptions are displayed. For example, `e.GetType().Name` returns the (unscoped) name of an exception.

Exceptions and Out-Parameters in C#

The Ice run time makes no guarantees about the state of out-parameters when an operation throws an exception: the parameter may still have its original value or may have been changed by the operation's implementation in the target object. In other words, for out-parameters, Ice provides the weak exception guarantee [1] but does not provide the strong exception guarantee.



This is done for reasons of efficiency: providing the strong exception guarantee would require more overhead than can be justified.

See Also

- [Operations](#)
- [C-Sharp Mapping for Exceptions](#)
- [C-Sharp Mapping for Interfaces](#)
- [Location Transparency](#)

References

1. Sutter, H. 1999. [Exceptional C++: 47 Engineering Puzzles, Programming Problems, and Solutions](#). Reading, MA: Addison-Wesley.

C-Sharp Mapping for Classes

On this page:

- [Basic C# Mapping for Classes](#)
- [Operations Interfaces in C#](#)
- [Inheritance from `Ice.Object` in C#](#)
- [Class Data Members in C#](#)
- [Class Operations in C#](#)
- [Class Factories in C#](#)
- [Class Constructors in C#](#)

Basic C# Mapping for Classes

A Slice `class` is mapped to a C# class with the same name. By default, the generated class contains a public data member for each Slice data member (just as for structures and exceptions), and a member function for each operation. Alternatively, you can use the [property mapping](#) by specifying the "`clr:property`" metadata directive, which generates classes with virtual properties instead of data members.

Consider the following class definition:

Slice
<pre>class TimeOfDay { short hour; // 0 - 23 short minute; // 0 - 59 short second; // 0 - 59 string format(); // Return time as hh:mm:ss };</pre>

The Slice compiler generates the following code for this definition:

C#

```

public interface TimeOfDayOperations_
{
    string format(Ice.Current __current);
}

public interface TimeOfDayOperationsNC_
{
    string format();
}

public abstract partial class TimeOfDay
    : Ice.ObjectImpl,
      TimeOfDayOperations_,
      TimeOfDayOperationsNC_
{
    public short hour;
    public short minute;
    public short second;

    public TimeOfDay()
    {
    }

    public TimeOfDay(short hour, short minute, short second)
    {
        this.hour = hour;
        this.minute = minute;
        this.second = second;
    }

    public string format()
    {
        return format(new Ice.Current());
    }

    public abstract string format(Ice.Current __current);
}

```

There are a number of things to note about the generated code:

1. The compiler generates "operations interfaces" called `TimeOfDayOperations_` and `TimeOfDayOperationsNC_`. These interfaces contain a method for each Slice operation of the class.
2. The generated class `TimeOfDay` inherits (indirectly) from `Ice.Object`. This means that all classes implicitly inherit from `Ice.Object`, which is the ultimate ancestor of all classes. Note that `Ice.Object` is *not* the same as `Ice.ObjectPrx`. In other words, you *cannot* pass a class where a proxy is expected and vice versa.
If a class has only data members, but no operations, the compiler generates a non-abstract class.
3. The generated class contains a public member for each Slice member.
4. The generated class inherits member functions for each Slice operation from the operations interfaces.

5. The generated class contains two constructors.

There is quite a bit to discuss here, so we will look at each item in turn.

Operations Interfaces in C#

The methods in the `<interface-name>Operations_` interface have an additional trailing parameter of type `Ice.Current`, whereas the methods in the `<interface-name>OperationsNC_` interface lack this additional trailing parameter. The methods without the `Current` parameter simply forward to the methods with a `Current` parameter, supplying a default `Current`. For now, you can ignore this parameter and pretend it does not exist.

If a class has only data members, but no operations, the compiler omits generating the `<interface-name>Operations_` and `<interface-name>OperationsNC_` interfaces.

Inheritance from `Ice.Object` in C#

Like interfaces, classes implicitly inherit from a common base class, `Ice.Object`. However, as shown in the illustration below, classes inherit from `Ice.Object` instead of `Ice.ObjectPrx` (which is at the base of the inheritance hierarchy for proxies). As a result, you cannot pass a class where a proxy is expected (and vice versa) because the base types for classes and proxies are not compatible.

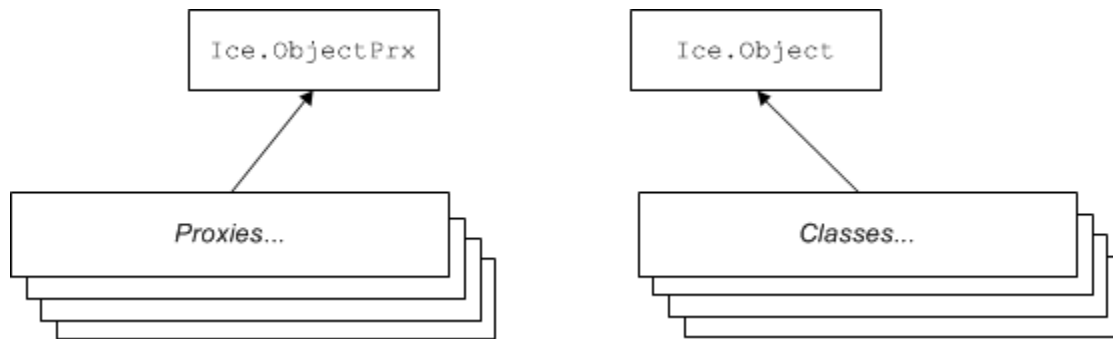

Inheritance from `Ice.ObjectPrx` and `Ice.Object`.

`Ice.Object` contains a number of member functions:

C#

```

namespace Ice
{
    public interface Object : System.ICloneable
    {
        bool ice_isA(string s);
        bool ice_isA(string s, Current current);

        void ice_ping();
        void ice_ping(Current current);

        string[] ice_ids();
        string[] ice_ids(Current current);

        string ice_id();
        string ice_id(Current current);

        void ice_preMarshal();
        void ice_postUnmarshal();

        DispatchStatus ice_dispatch(Request request,
        DispatchInterceptorAsyncCallback cb);
    }
}

```

The member functions of `Ice.Object` behave as follows:

- `ice_isA`
This function returns `true` if the object supports the given `type ID`, and `false` otherwise.
- `ice_ping`
As for interfaces, `ice_ping` provides a basic reachability test for the class.
- `ice_ids`
This function returns a string sequence representing all of the `type IDs` supported by this object, including `::Ice::Object`.
- `ice_id`
This function returns the actual run-time `type ID` for a class. If you call `ice_id` through a reference to a base instance, the returned type id is the actual (possibly more derived) type ID of the instance.
- `ice_preMarshal`
The Ice run time invokes this function prior to marshaling the object's state, providing the opportunity for a subclass to validate its declared data members.
- `ice_postUnmarshal`
The Ice run time invokes this function after unmarshaling an object's state. A subclass typically overrides this function when it needs to perform additional initialization using the values of its declared data members.
- `ice_dispatch`
This function dispatches an incoming request to a servant. It is used in the implementation of `dispatch interceptors`.

Note that the generated class does *not* override `GetHashCode` and `Equals`. This means that classes are compared using shallow reference equality, not value equality (as is used for structures).

The class also provides a `Clone` method (whose implementation is inherited from `Ice.ObjectImpl`); the `Clone` method returns a shallow memberwise copy.

Class Data Members in C#

By default, data members of classes are mapped exactly as for structures and exceptions: for each data member in the Slice definition, the generated class contains a corresponding public data member. [Optional data members](#) are mapped to instances of the `Ice.Optional` type

If you wish to restrict access to a data member, you can modify its visibility using the `protected` metadata directive. The presence of this directive causes the Slice compiler to generate the data member with protected visibility. As a result, the member can be accessed only by the class itself or by one of its subclasses. For example, the `TimeOfDay` class shown below has the `protected` metadata directive applied to each of its data members:

Slice
<pre>class TimeOfDay { ["protected"] short hour; // 0 - 23 ["protected"] short minute; // 0 - 59 ["protected"] short second; // 0 - 59 string format(); // Return time as hh:mm:ss };</pre>

The Slice compiler produces the following generated code for this definition:

C#
<pre>public abstract partial class TimeOfDay : Ice.ObjectImpl, TimeOfDayOperations_, TimeOfDayOperationsNC_ { protected short hour; protected short minute; protected short second; public TimeOfDay() { } public TimeOfDay(short hour, short minute, short second) { this.hour = hour; this.minute = minute; this.second = second; } // ... }</pre>

For a class in which all of the data members are protected, the metadata directive can be applied to the class itself rather than to each member individually. For example, we can rewrite the `TimeOfDay` class as follows:

Slice
<pre>["protected"] class TimeOfDay { short hour; // 0 - 23 short minute; // 0 - 59 short second; // 0 - 59 string format(); // Return time as hh:mm:ss };</pre>

If a protected data member also has the `clr:property` directive, the generated property has protected visibility. Consider the `TimeOfDay` class once again:

Slice
<pre>["protected", "clr:property"] class TimeOfDay { short hour; // 0 - 23 short minute; // 0 - 59 short second; // 0 - 59 string format(); // Return time as hh:mm:ss };</pre>

The effects of combining these two metadata directives are shown in the generated code below:

C#
<pre>public abstract partial class TimeOfDay : Ice.ObjectImpl, TimeOfDayOperations_, TimeOfDayOperationsNC_ { private short hour_prop; protected short hour { get { return hour_prop; } set { hour_prop = value; } } // ... }</pre>

Refer to the [structure mapping](#) for more information on the property mapping for data members.

Class Operations in C#

Operations of classes are mapped to abstract member functions in the generated class. This means that, if a class contains operations (such as the `format` operation of our `TimeOfDay` class), you must provide an implementation of the operation in a class that is derived from the generated class. For example:

```
C#
```

```
public class TimeOfDayI : TimeOfDay
{
    public string format(Ice.Current current)
    {
        return    hour.ToString("D2") + ":"
                + minute.ToString("D2") + ":"
                + second.ToString("D2");
    }
}
```

Class Factories in C#

Having created a class such as `TimeOfDayI`, we have an implementation and we can instantiate the `TimeOfDayI` class, but we cannot receive it as the return value or as an out-parameter from an operation invocation. To see why, consider the following simple interface:

```
Slice
```

```
interface Time {
    TimeOfDay get();
};
```

When a client invokes the `get` operation, the Ice run time must instantiate and return an instance of the `TimeOfDay` class. However, `TimeOfDay` is an abstract class that cannot be instantiated. Unless we tell it, the Ice run time cannot magically know that we have created a `TimeOfDayI` class that implements the abstract `format` operation of the `TimeOfDay` abstract class. In other words, we must provide the Ice run time with a factory that knows that the `TimeOfDay` abstract class has a `TimeOfDayI` concrete implementation. The `Ice::Communicator` interface provides us with the necessary operations:

```
Slice
```

```
module Ice {
    local interface ObjectFactory {
        Object create(string type);
        void destroy();
    };

    local interface Communicator {
        void addObjectFactory(ObjectFactory factory, string id);
        ObjectFactory findObjectFactory(string id);
        // ...
    };
};
```

To supply the Ice run time with a factory for our `TimeOfDayI` class, we must implement the `ObjectFactory` interface:

```

C#
class ObjectFactory : Ice.ObjectFactory
{
    public Ice.Object create(string type)
    {
        if (type.Equals(M.TimeOfDay.ice_staticId()))
            return new TimeOfDayI();
        System.Diagnostics.Debug.Assert(false);
        return null;
    }

    public void destroy()
    {
        // Nothing to do
    }
}

```

The object factory's `create` method is called by the Ice run time when it needs to instantiate a `TimeOfDay` class. The factory's `destroy` method is called by the Ice run time when its communicator is destroyed.

The `create` method is passed the [type ID](#) of the class to instantiate. For our `TimeOfDay` class, the type ID is `"::M::TimeOfDay"`. Our implementation of `create` checks the type ID: if it matches, the method instantiates and returns a `TimeOfDayI` object. For other type IDs, the method asserts because it does not know how to instantiate other types of objects.

Note that we used the `ice_staticId` method to obtain the type ID rather than embedding a literal string. Using a literal type ID string in your code is discouraged because it can lead to errors that are only detected at run time. For example, if a `Slice` class or one of its enclosing modules is renamed and the literal string is not changed accordingly, a receiver will fail to unmarshal the object and the Ice run time will raise `NoObjectFactoryException`. By using `ice_staticId` instead, we avoid any risk of a misspelled or obsolete type ID, and we can discover at compile time if a `Slice` class or module has been renamed.

Given a factory implementation, such as our `ObjectFactory`, we must inform the Ice run time of the existence of the factory:

```

C#
Ice.Communicator ic = ...;
ic.addObjectFactory(new ObjectFactory(), M.TimeOfDay.ice_staticId());

```

Now, whenever the Ice run time needs to instantiate a class with the type ID `"::M::TimeOfDay"`, it calls the `create` method of the registered `ObjectFactory` instance, which returns a `TimeOfDayI` instance to the Ice run time.

The `destroy` operation of the object factory is invoked by the Ice run time when the communicator is destroyed. This gives you a chance to clean up any resources that may be used by your factory. Do not call `destroy` on the factory while it is registered with the communicator — if you do, the Ice run time has no idea that this has happened and, depending on what your `destroy` implementation is doing, may cause undefined behavior when the Ice run time tries to next use the factory.

The run time guarantees that `destroy` will be the last call made on the factory, that is, `create` will not be called concurrently with `destroy`, and `create` will not be called once `destroy` has been called. However, calls to `create` can be made concurrently.

Note that you cannot register a factory for the same type ID twice: if you call `addObjectFactory` with a type ID for which a factory is registered, the Ice run time throws an `AlreadyRegisteredException`.

Finally, keep in mind that if a class has only data members, but no operations, you need not create and register an object factory to transmit instances of such a class. Only if a class has operations do you have to define and register an object factory.

Class Constructors in C#

Classes have a default constructor that default-constructs each data member. This means members of primitive type are initialized to the equivalent of zero, and members of reference type are initialized to null. Note that applications must always explicitly initialize a member whose type is a [class-mapped structure](#) because the Ice run time does not accept null as a legal value for these types.

If you wish to ensure that data members of primitive and enumerated types are initialized to specific values, you can declare default values in your [Slice definition](#). The default constructor initializes each of these data members to its declared value.

A class also provides a constructor that accepts one argument for each member of the class. This allows you to create and initialize a class in a single statement, for example:

C#
<pre>TimeOfDayI tod = new TimeOfDayI(14, 45, 00); // 2:45pm</pre>

For a derived class, the constructor requires one argument for every member of the class, including inherited members. For example, consider the the definition from [Class Inheritance](#) once more:

Slice
<pre>class TimeOfDay { short hour; // 0 - 23 short minute; // 0 - 59 short second; // 0 - 59 }; class DateTime extends TimeOfDay { short day; // 1 - 31 short month; // 1 - 12 short year; // 1753 onwards };</pre>

The Slice compiler generates the following constructors for these types:

C#

```

public partial class TimeOfDay : Ice.ObjectImpl
{
    public TimeOfDay() {}

    public TimeOfDay(short hour, short minute, short second)
    {
        this.hour = hour;
        this.minute = minute;
        this.second = second;
    }

    // ...
}

public partial class DateTime : TimeOfDay
{
    public DateTime() : base() {}

    public DateTime(short hour,
                    short minute,
                    short second,
                    short day,
                    short month,
                    short year) : base(hour, minute, second)
    {
        this.day = day;
        this.month = month;
        this.year = year;
    }

    // ...
}

```

If you want to instantiate and initialize a `DateTime` instance, you must either use the default constructor or provide values for all of the data members of the instance, including data members of its base class.

For each optional data member of a class, the constructor accepts an `Ice.Optional` parameter of the appropriate type. You can pass the value `Ice.Util.None` as the value of any optional data member to initialize it to an unset condition.

See Also

- [Classes](#)
- [Class Inheritance](#)
- [Type IDs](#)
- [C-Sharp Mapping for Structures](#)
- [C-Sharp Mapping for Optional Values](#)
- [The Current Object](#)
- [Dispatch Interceptors](#)

C-Sharp Mapping for Optional Values

On this page:

- [The Ice.Optional Type](#)
- [The Ice.Util.None Value](#)

The Ice.Optional Type

The C# mapping uses a generic structure to hold the values of optional [data members](#) and [parameters](#):

```

C#
namespace Ice
{
    public struct NoneType {}

    public struct Optional<T> {
        public Optional(NoneType none);
        public Optional(T v);
        public Optional(Optional<T> v);

        public static explicit operator T(Optional<T> v);
        public static implicit operator Optional<T>(T v);
        public static implicit operator Optional<T>(NoneType v);

        public T Value { get; }
        public bool HasValue { get; }

        public override bool Equals(object other);
        public override int GetHashCode();

        ...
    }
}

```

The `Ice.Optional` type provides constructors and conversion operators that allow you to initialize an instance using the element type or an existing optional value. The default constructor initializes an instance to an unset condition. The `Value` property and conversion operator retrieve the current value held by the instance, or throw `System.InvalidOperationException` if no value is currently set. Use the `HasValue` property to test whether the instance has a value prior to accessing it.

The implicit conversion operators allow you to initialize an `Optional` instance without a cast. However, the conversion operator that extracts the current value is declared as `explicit` and therefore requires a cast:

```

C#
Ice.Optional<int> i = 5; // No cast necessary
int j = i;             // Error!
int k = (int)i;       // OK

```

This operator raises an exception if no value is set, so the proper way to write this is shown below:

```
C#
```

```
Ice.Optional<int> i = 5;
int j;
if(i.HasValue)
    j = (int)i;
else
    ...
```

The `Ice.Util.None` Value

The `Ice.Optional` type provides a constructor and conversion operator that accept `NoneType`. Ice defines an instance of this type, `Ice.Util.None`, that you can use to initialize (or reset) an `Optional` instance to an unset condition:

```
C#
```

```
Ice.Optional<int> i = 5;
i = Ice.Util.None;
Debug.Assert(!i.HasValue); // true
```



You can pass `Ice.Util.None` anywhere an `Ice.Optional` value is expected.

See Also

- [Optional Data Members](#)

Serializable Objects in C-Sharp

In addition to serializing Slice types, applications may also need to incorporate foreign types into their Slice definitions. Ice allows you to pass CLR [serializable objects](#) directly as operation parameters or as fields of another data type. For example:

```

Slice
["clr:serializable:SomeNamespace.CLRClass"]
sequence<byte> CLRObj;
struct MyStruct {
    int i;
    CLRObj o;
};

interface Example {
    void op(CLRObj o, MyStruct s);
};

```

The generated code for `MyStruct` contains member `i` of type `int` and a member `o` of type `SomeNamespace.CLRClass`:

```

C#
public partial class MyStruct : _System.ICloneable {
    public int i;
    SomeNamespace.CLRClass o;

    // ...
}

```

Similarly, the signature for `op` has parameters of type `CLRClass` and `MyStruct`:

```

C#
void op(SomeNamespace.CLRClass o, MyStruct s);

```

Of course, your client and server code must have an implementation of `CLRClass` that sets the `Serializable` attribute:

```

C#
namespace SomeNamespace {
    [Serializable]
    public class CLRClass {
        // ...
    }
}

```

You can implement this class in any way you see fit — the Ice run time does not place any other requirements on the implementation. However, note that the CLR requires the class to reside in the same assembly for client and server.

See Also

- [Serializable Objects](#)

C-Sharp Specific Metadata Directives

The `slice2cs` compiler supports [metadata](#) directives that allow you to inject C# attribute specifications into the generated code. The metadata directive is `cs:attribute:.` For example:

Slice
<pre>["cs:attribute:System.Serializable"] struct Point { double x; double y; };</pre>

This results in the following code being generated for S:

C#
<pre>[System.Serializable] public partial struct Point { public double x; public double y; // ... }</pre>

You can apply this metadata directive to any Slice construct, such as structure, operation, or parameter definitions.

You can use this directive also at global level. For example:

Slice
<pre>[["cs:attribute:assembly: AssemblyDescription(\"My assembly\")"]]</pre>

This results in the following code being inserted after any `using` directives and before any definitions:

C#
<pre>[assembly: AssemblyDescription("My assembly")]</pre>

See Also

- [Metadata](#)
- [Slice Metadata Directives](#)

Asynchronous Method Invocation (AMI) in C-Sharp

Asynchronous Method Invocation (AMI) is the term used to describe the client-side support for the asynchronous programming model. AMI supports both oneway and twoway requests, but unlike their synchronous counterparts, AMI requests never block the calling thread. When a client issues an AMI request, the Ice run time hands the message off to the local transport buffer or, if the buffer is currently full, queues the request for later delivery. The application can then continue its activities and poll or wait for completion of the invocation, or receive a callback when the invocation completes.

AMI is transparent to the server: there is no way for the server to tell whether a client sent a request synchronously or asynchronously.

 As of version 3.4, Ice provides a new API for asynchronous method invocation. This page describes the new API. Note that the old API is deprecated and will be removed in a future release.

On this page:

- [Basic Asynchronous API in C#](#)
 - [Asynchronous Proxy Methods in C#](#)
 - [Asynchronous Exception Semantics in C#](#)
- [AsyncResult Class in C#](#)
- [Polling for Completion in C#](#)
- [Generic Completion Callbacks in C#](#)
 - [Using Cookies for Generic Completion Callbacks in C#](#)
- [Type-Safe Completion Callbacks in C#](#)
 - [Using Cookies for Type-Safe Completion Callbacks in C#](#)
- [Asynchronous Oneway Invocations in C#](#)
- [Flow Control in C#](#)
- [Asynchronous Batch Requests in C#](#)
- [Concurrency Semantics for AMI in C#](#)
- [AMI Limitations in C#](#)

Basic Asynchronous API in C#

Consider the following simple Slice definition:

Slice

```

module Demo {
    interface Employees {
        string getName(int number);
    };
};

```

Asynchronous Proxy Methods in C#

Besides the synchronous proxy methods, `slice2cs` generates the following asynchronous proxy methods:

C#

```
public interface EmployeesPrx : Ice.ObjectPrx {
    Ice.AsyncResult<Demo.Callback_Employees_getName>
    begin_getName(int number);

    Ice.AsyncResult<Demo.Callback_Employees_getName>
    begin_getName(int number,
        _System.Collections.Generic.Dictionary<string, string> ctx__);

    string end_getName(Ice.AsyncResult r__);
}
```



Two additional overloads of `begin_getName` are generated for use with [generic completion callbacks](#).

As you can see, the single `getName` operation results in `begin_getName` and `end_getName` methods. (The `begin_` method is overloaded so you can pass a [per-invocation context](#).)

- The `begin_getName` method sends (or queues) an invocation of `getName`. This method does not block the calling thread.
- The `end_getName` method collects the result of the asynchronous invocation. If, at the time the calling thread calls `end_getName`, the result is not yet available, the calling thread blocks until the invocation completes. Otherwise, if the invocation completed some time before the call to `end_getName`, the method returns immediately with the result.

A client could call these methods as follows:

C#

```
EmployeesPrx e = ...;
Ice.AsyncResult r = e.begin_getName(99);

// Continue to do other things here...

string name = e.end_getName(r);
```

Because `begin_getName` does not block, the calling thread can do other things while the operation is in progress.

Note that `begin_getName` returns a value of type `Ice.AsyncResult`. (The class derives from `System.IAsyncResult`.) This value contains the state that the Ice run time requires to keep track of the asynchronous invocation. You must pass the `AsyncResult` that is returned by the `begin_` method to the corresponding `end_` method.

The `begin_` method has one parameter for each in-parameter of the corresponding Slice operation. Similarly, the `end_` method has one out-parameter for each out-parameter of the corresponding Slice operation (plus the `AsyncResult` parameter). For example, consider the following operation:

Slice

```
double op(int inp1, string inp2, out bool outp1, out long outp2);
```

The `begin_op` and `end_op` methods have the following signature:

```

C#

Ice.AsyncResult<Demo.Callback_Employees_op>
begin_op(int inp1, string inp2);

double end_op(out bool outp1, out long outp2, Ice.AsyncResult r__);
```

Asynchronous Exception Semantics in C#

If an invocation raises an exception, the exception is thrown by the `end_` method, even if the actual error condition for the exception was encountered during the `begin_` method ("on the way out"). The advantage of this behavior is that all exception handling is located with the code that calls the `end_` method (instead of being present twice, once where the `begin_` method is called, and again where the `end_` method is called).

There is one exception to the above rule: if you destroy the communicator and then make an asynchronous invocation, the `begin_` method throws `CommunicatorDestroyedException`. This is necessary because, once the run time is finalized, it can no longer throw an exception from the `end_` method.

The only other exception that is thrown by the `begin_` and `end_` methods is `System.ArgumentException`. This exception indicates that you have used the API incorrectly. For example, the `begin_` method throws this exception if you call an operation that has a return value or out-parameters on a oneway proxy. Similarly, the `end_` method throws this exception if you use a different proxy to call the `end_` method than the proxy you used to call the `begin_` method, or if the `AsyncResult` you pass to the `end_` method was obtained by calling the `begin_` method for a different operation.

AsyncResult Class in C#

The `AsyncResult` that is returned by the `begin_` method encapsulates the state of the asynchronous invocation:

C#

```

public interface AsyncResult : System.IAsyncResult
{
    Ice.Communicator getCommunicator();
    Ice.Connection getConnection();
    ObjectPrx getProxy();
    string getOperation();
    object AsyncState { get; }

    bool IsCompleted { get; }
    void waitForCompleted();

    bool isSent();
    void waitForSent();

    void throwLocalException();

    bool sentSynchronously();

    AsyncResult whenSent(Ice.AsyncCallback cb);
    AsyncResult whenSent(Ice.SentCallback cb);
    AsyncResult whenCompleted(Ice.ExceptionCallback ex);
}

public interface AsyncResult<T> : AsyncResult
{
    AsyncResult<T> whenCompleted(T cb, Ice.ExceptionCallback excb);

    new AsyncResult<T> whenCompleted(Ice.ExceptionCallback excb);
    new AsyncResult<T> whenSent(Ice.SentCallback cb);
}

```

The methods and properties have the following semantics:

- `Communicator getCommunicator()`
This method returns the communicator that sent the invocation.
- `Connection getConnection()`
This method returns the connection that was used for the invocation. Note that, for typical asynchronous proxy invocations, this method returns a nil value because the possibility of automatic retries means the connection that is currently in use could change unexpectedly. The `getConnection` method only returns a non-nil value when the `AsyncResult` object is obtained by calling `begin_flushBatchRequests` on a `Connection` object.
- `ObjectPrx getProxy()`
This method returns the proxy that was used to call the `begin_` method, or nil if the `AsyncResult` object was not obtained via an asynchronous proxy invocation.
- `string getOperation()`
This method returns the name of the operation.
- `object AsyncState { get; }`

This property stores an object that you can use to pass shared state from the `begin_` to the `end_` method.

- `bool IsCompleted { get; }`
This property is true if, at the time it is called, the result of an invocation is available, indicating that a call to the `end_` method will not block the caller. Otherwise, if the result is not yet available, the method returns false.
- `void waitForCompleted()`
This method blocks the caller until the result of an invocation becomes available.
- `bool isSent()`
When you call the `begin_` method, the Ice run time attempts to write the corresponding request to the client-side transport. If the transport cannot accept the request, the Ice run time queues the request for later transmission. `isSent` returns true if, at the time it is called, the request has been written to the local transport (whether it was initially queued or not). Otherwise, if the request is still queued or an exception occurred before the request could be sent, `isSent` returns false.
- `void waitForSent()`
This method blocks the calling thread until a request has been written to the client-side transport, or an exception occurs. After `waitForSent` returns, `isSent` returns true if the request was successfully written to the client-side transport, or false if an exception occurred. In the case of a failure, you can call the corresponding `end_` method or `throwLocalException` to obtain the exception.
- `void throwLocalException()`
This method throws the local exception that caused the invocation to fail. If no exception has occurred yet, `throwLocalException` does nothing.
- `bool sentSynchronously()`
This method returns true if a request was written to the client-side transport without first being queued. If the request was initially queued, `sentSynchronously` returns false (independent of whether the request is still in the queue or has since been written to the client-side transport).
- `AsyncResult whenSent(Ice.SentCallback cb)`
`AsyncResult<T> whenSent(Ice.SentCallback cb)`
`AsyncResult whenCompleted(Ice.ExceptionCallback ex)`
`AsyncResult<T> whenCompleted(T cb, Ice.ExceptionCallback excb)`
`AsyncResult<T> whenCompleted(Ice.ExceptionCallback excb)`
These methods allow you to specify callback methods that are called by the Ice run time. The `whenSent` methods set a callback that triggers when an asynchronous invocation is written to the client-side transport. The `whenCompleted` methods set a callback that triggers when an asynchronous invocation completes (also see [Generic Completion Callbacks in C#](#)).

Polling for Completion in C#

The `AsyncResult` methods allow you to poll for call completion. Polling is useful in a variety of cases. As an example, consider the following simple interface to transfer files from client to server:

Slice

```
interface FileTransfer
{
    void send(int offset, ByteSeq bytes);
};
```

The client repeatedly calls `send` to send a chunk of the file, indicating at which offset in the file the chunk belongs. A naïve way to transmit a file would be along the following lines:

C#

```
FileHandle file = open(...);
FileTransferPrx ft = ...;
const int chunkSize = ...;
int offset = 0;
while (!file.eof()) {
    byte[] bs;
    bs = file.read(chunkSize); // Read a chunk
    ft.send(offset, bs);      // Send the chunk
    offset += bs.Length;
}
```

This works, but not very well: because the client makes synchronous calls, it writes each chunk on the wire and then waits for the server to receive the data, process it, and return a reply before writing the next chunk. This means that both client and server spend much of their time doing nothing — the client does nothing while the server processes the data, and the server does nothing while it waits for the client to send the next chunk.

Using asynchronous calls, we can improve on this considerably:

C#

```

FileHandle file = open(...);
FileTransferPrx ft = ...;
const int chunkSize = ...;
int offset = 0;

LinkedList<Ice.AsyncResult> results = new LinkedList<Ice.AsyncResult>();
const int numRequests = 5;

while (!file.eof()) {
    byte[] bs;
    bs = file.read(chunkSize);

    // Send up to numRequests + 1 chunks asynchronously.
    Ice.AsyncResult r = ft.begin_send(offset, bs);
    offset += bs.Length;

    // Wait until this request has been passed to the transport.
    r.waitForSent();
    results.AddLast(r);

    // Once there are more than numRequests, wait for the least
    // recent one to complete.
    while (results.Count > numRequests) {
        Ice.AsyncResult r = results.First();
        results.RemoveFirst();
        r.waitForCompleted();
    }
}

// Wait for any remaining requests to complete.
while (results.Count > 0) {
    Ice.AsyncResult r = results.First();
    results.RemoveFirst();
    r.waitForCompleted();
}

```

With this code, the client sends up to `numRequests + 1` chunks before it waits for the least recent one of these requests to complete. In other words, the client sends the next request without waiting for the preceding request to complete, up to the limit set by `numRequests`. In effect, this allows the client to "keep the pipe to the server full of data": the client keeps sending data, so both client and server continuously do work.

Obviously, the correct chunk size and value of `numRequests` depend on the bandwidth of the network as well as the amount of time taken by the server to process each request. However, with a little testing, you can quickly zoom in on the point where making the requests larger or queuing more requests no longer improves performance. With this technique, you can realize the full bandwidth of the link to within a percent or two of the theoretical bandwidth limit of a native socket connection.

Generic Completion Callbacks in C#

The `begin_` method is overloaded to allow you to provide completion callbacks. Here are the corresponding methods for the `getName` operation:

```

C#

Ice.AsyncResult begin_getName(
    int number,
    Ice.AsyncCallback cb__,
    object cookie__);

Ice.AsyncResult begin_getName(
    int number,
    _System.Collections.Generic.Dictionary<string, string> ctx__,
    Ice.AsyncCallback cb__,
    object cookie__);

```

The second version of `begin_getName` lets you override the default context. (We discuss the purpose of the `cookie` parameter in the next section.) Following the in-parameters, the `begin_` method accepts a parameter of type `Ice.AsyncCallback`, which is a delegate for a callback method. The Ice run time invokes the callback method when an asynchronous operation completes. Your callback method must have `void` return type and accept a single parameter of type `AsyncResult`, for example:

```

C#

private class MyCallback
{
    public void finished(Ice.AsyncResult r)
    {
        EmployeesPrx e = (EmployeesPrx)r.getProxy();
        try {
            string name = e.end_getName(r);
            System.Console.WriteLine("Name is: " + name);
        } catch (Ice.Exception ex) {
            System.Console.Err.WriteLine("Exception is: " + ex);
        }
    }
}

```

The implementation of your callback method must call the `end_` method. The proxy for the call is available via the `getProxy` method on the `AsyncResult` that is passed by the Ice run time. The return type of `getProxy` is `Ice.ObjectPrx`, so you must down-cast the proxy to its correct type.

Your callback method should catch and handle any exceptions that may be thrown by the `end_` method. If you allow an exception to escape from the callback method, the Ice run time produces a log entry by default and ignores the exception. (You can disable the log message by setting the property `Ice.Warn.AMICallback` to zero.)

To inform the Ice run time that you want to receive a callback for the completion of the asynchronous call, you pass a delegate for your callback method to the `begin_` method:

C#

```

EmployeesPrx e = ...;

MyCallback cb = new MyCallback();
Ice.AsyncCallback del = new Ice.AsyncCallback(cb.finished);

e.begin_getName(99, del, null);

```

The trailing `null` argument specifies a cookie, which we will discuss shortly.

You can avoid explicit instantiation of the delegate and, more tersely, write:

C#

```

EmployeesPrx e = ...;

MyCallback cb = new MyCallback();
e.begin_getName(99, cb.finished, null);

```

Using Cookies for Generic Completion Callbacks in C#

It is common for the `end_` method to require access to some state that is established by the code that calls the `begin_` method. As an example, consider an application that asynchronously starts a number of operations and, as each operation completes, needs to update different user interface elements with the results. In this case, the `begin_` method knows which user interface element should receive the update, and the `end_` method needs access to that element.

The API allows you to pass such state by providing a cookie. A cookie is any class instance; the class can contain whatever data you want to pass, as well as any methods you may want to add to manipulate that data.

Here is an example implementation that stores a `Widget`. (We assume that this class provides whatever methods are needed by the `end_` method to update the display.) When you call the `begin_` method, you pass the appropriate cookie instance to inform the `end_` method how to update the display:

C#

```

// Invoke the getName operation with different widget cookies.
MyCallback cb = ...;
e.begin_getName(99, cb.finished, widget1);
e.begin_getName(24, cb.finished, widget2);

```

The `end_` method can retrieve the cookie from the `AsyncResult` by reading the `AsyncState` property. For this example, we assume that widgets have a `writeString` method that updates the relevant UI element:

C#

```

public void finished(Ice.AsyncResult r)
{
    EmployeesPrx e = (EmployeesPrx)r.getProxy();
    Widget widget = (Widget)r.AsyncState;
    try {
        string name = e.end_getName(r);
        widget.writeString(name);
    } catch (Ice.Exception ex) {
        handleException(ex);
    }
}

```

The cookie provides a simple and effective way for you to pass state between the point where an operation is invoked and the point where its results are processed. Moreover, if you have a number of operations that share common state, you can pass the same cookie instance to multiple invocations.

Type-Safe Completion Callbacks in C#

The [generic callback API](#) is not entirely type-safe:

- You must down-cast the return value of `getProxy` to the correct proxy type before you can call the `end_` method.
- You must call the correct `end_` method to match the operation called by the `begin_` method.
- You must remember to catch exceptions when you call the `end_` method; if you forget to do this, you will not know that the operation failed.

`slice2cs` generates an additional type-safe API that takes care of these chores for you. To use type-safe callbacks, you supply delegates for two callback methods:

- a success callback that is called if the operation succeeds
- a failure callback that is called if the operation raises an exception

Here is a callback class for an invocation of the `getName` operation:

C#

```

public class MyCallback
{
    public void getNameCB(string name)
    {
        System.Console.WriteLine("Name is: " + name);
    }

    public void failureCB(Ice.Exception ex)
    {
        System.Console.Err.WriteLine("Exception is: " + ex);
    }
}

```

The callback methods can have any name you prefer and must have `void` return type. The failure callback always has a single parameter of

type `Ice.Exception`. The success callback parameters depend on the operation signature. If the operation has non-`void` return type, the first parameter of the success callback is the return value. The return value (if any) is followed by a parameter for each out-parameter of the corresponding Slice operation, in the order of declaration.

At the calling end, you call the `begin_` method as follows:

```
C#
```

```
MyCallback cb = new MyCallback();

e.begin_getName(99).whenCompleted(cb.getNameCB, cb.failureCB);
```

Note the `whenCompleted` method on the `AsyncResult` that is returned by the `begin_` method. This method establishes the link between the `begin_` method and the callbacks that are called by the Ice run time by setting the delegates for the success and failure methods.

It is legal to pass a null delegate for the success or failure methods. For the success callback, this is legal only for operations that have `void` return type and no out-parameters. This is useful if you do not care when the operation completes but want to know if the call failed. If you pass a null exception delegate, the Ice run time will ignore any exception that is raised by the invocation.

Using Cookies for Type-Safe Completion Callbacks in C#

The type-safe API does not support cookies. If you want to pass state from the `begin_` method to the `end_` method, you must use the `generic API` or, alternatively, place the state into the callback class containing the callback methods. Here is a simple implementation of a callback class that stores a widget that can be retrieved by the `end_` method:

```
C#
```

```
public class MyCallback
{
    public MyCallback(Widget w)
    {
        _w = w;
    }

    private Widget _w;

    public void getNameCB(string name)
    {
        _w.writeString(name);
    }

    public void failureCB(Ice.Exception ex)
    {
        _w.writeError(ex);
    }
}
```

When you call the `begin_` method, you pass the appropriate callback instance to inform the `end_` method how to update the display:

C#

```

EmployeesPrx e = ...;
Widget widget1 = ...;
Widget widget2 = ...;

MyCallback cb1 = new MyCallback(widget1);
MyCallback cb2 = new MyCallback(widget2);

// Invoke the getName operation with different widget callbacks.

e.begin_getName(99).whenCompleted(cb1.getNameCB, cb1.failureCB);
e.begin_getName(24).whenCompleted(cb2.getNameCB, cb2.failureCB);

```

Asynchronous Oneway Invocations in C#

You can invoke operations via oneway proxies asynchronously, provided the operation has `void` return type, does not have any out-parameters, and does not raise user exceptions. If you call the `begin_` method on a oneway proxy for an operation that returns values or raises a user exception, the `begin_` method throws a `System.ArgumentException`.

For the generic API, the callback method looks exactly as for a twoway invocation. However, for oneway invocations, the Ice run time does not call the callback method unless the invocation raised an exception during the `begin_` method ("on the way out").

For the type-safe API, you only specify a delegate for the failure method. For example, here is how you could call `ice_ping` asynchronously :

C#

```

ObjectPrx p = ...;
MyCallback cb = new MyCallback();
p.begin_ice_ping().whenCompleted(cb.failureCB);

```

Flow Control in C#

Asynchronous method invocations never block the thread that calls the `begin_` method: the Ice run time checks to see whether it can write the request to the local transport. If it can, it does so immediately in the caller's thread. (In that case, `AsyncResult.sentSynchronously` returns true.) Alternatively, if the local transport does not have sufficient buffer space to accept the request, the Ice run time queues the request internally for later transmission in the background. (In that case, `AsyncResult.sentSynchronously` returns false.)

This creates a potential problem: if a client sends many asynchronous requests at the time the server is too busy to keep up with them, the requests pile up in the client-side run time until, eventually, the client runs out of memory.

The API provides a way for you to implement flow control by counting the number of requests that are queued so, if that number exceeds some threshold, the client stops invoking more operations until some of the queued operations have drained out of the local transport.

For the [generic API](#), you can create an additional callback method:

C#

```
public class MyCallback
{
    public void finished(Ice.AsyncResult r)
    {
        // ...
    }

    public void sent(Ice.AsyncResult r)
    {
        // ...
    }
}
```

As with any other callback method, you are free to choose any name you like. For this example, the name of the callback method is `sent`. You inform the Ice run time that you want to be informed when a call has been passed to the local transport by calling `whenSent`:

C#

```
MyCallback cb = new MyCallback();

e.begin_getName(99).whenCompleted(cb.getNameCB,
cb.failureCB).whenSent(cb.sent);
```

If the Ice run time can immediately pass the request to the local transport, it does so and invokes the `sent` method from the thread that calls the `begin_` method. On the other hand, if the run time has to queue the request, it calls the `sent` method from a different thread once it has written the request to the local transport. In addition, you can find out from the `AsyncResult` that is returned by the `begin_` method whether the request was sent synchronously or was queued, by calling `sentSynchronously`.

For the [generic API](#), the `sent` method has the following signature:

C#

```
void sent(Ice.AsyncResult r);
```

For the [type-safe API](#), the signature is:

C#

```
void sent(bool sentSynchronously);
```

For the [generic API](#), you can find out whether the request was sent synchronously by calling `sentSynchronously` on the `AsyncResult`. For the [type-safe API](#), the boolean `sentSynchronously` parameter provides the same information.

The `sent` methods allow you to limit the number of queued requests by counting the number of requests that are queued and decrementing the count when the Ice run time passes a request to the local transport.

Asynchronous Batch Requests in C#

Applications that send [batched requests](#) can either flush a batch explicitly or allow the Ice run time to flush automatically. The proxy method `ice_flushBatchRequests` performs an immediate flush using the synchronous invocation model and may block the calling thread until the entire message can be sent. Ice also provides asynchronous versions of this method so you can flush batch requests asynchronously.

`begin_ice_flushBatchRequests` and `end_ice_flushBatchRequests` are proxy methods that flush any batch requests queued by that proxy.

In addition, similar methods are available on the communicator and the `Connection` object that is returned by `AsyncResult.getConnection`. These methods flush batch requests sent via the same communicator and via the same connection, respectively.

Concurrency Semantics for AMI in C#

The Ice run time always invokes your callback methods from a separate thread, with one exception: it calls the `sent` callback from the thread calling the `begin_` method if the request could be sent synchronously. In the `sent` callback, you know which thread is calling the callback by looking at the `sentSynchronously` member or parameter.

AMI Limitations in C#

AMI invocations cannot be sent using collocated optimization. If you attempt to invoke an AMI operation using a proxy that is configured to use [collocation optimization](#), the Ice run time raises `CollocationOptimizationException` if the servant happens to be collocated; the request is sent normally if the servant is not collocated. You can disable this optimization if necessary.

See Also

- [Request Contexts](#)
- [Batched Invocations](#)
- [Location Transparency](#)

slice2cs Command-Line Options

The Slice-to-C# compiler, `slice2cs`, offers the following command-line options in addition to the standard options described in [Using the Slice Compilers](#):

- `--tie`
Generate [tie classes](#).
- `--impl`
Generate sample implementation files. This option will not overwrite an existing file.
- `--impl-tie`
Generate sample implementation files using [tie classes](#). This option will not overwrite an existing file.
- `--checksum`
Generate [checksums](#) for Slice definitions.
- `--stream`
Generate [streaming helper functions](#) for Slice types.

See Also

- [Using the Slice Compilers](#)
- [Tie Classes in C-Sharp](#)
- [Streaming Interfaces](#)

Using Slice Checksums in C-Sharp

The Slice compilers can optionally generate [checksums](#) of Slice definitions. For `slice2cs`, the `--checksum` option causes the compiler to generate checksums in each C# source file that are added to a member of the `Ice.SliceChecksums` class:

```

C#

namespace Ice {
    public sealed class SliceChecksums {
        public readonly static
        System.Collections.Generic.Dictionary<string, string> checksums;
    }
}
```

The `checksums` map is initialized automatically prior to first use; no action is required by the application.

In order to verify a server's checksums, a client could simply compare the dictionaries using the `Equals` function. However, this is not feasible if it is possible that the server might be linked with more Slice definitions than the client. A more general solution is to iterate over the local checksums as demonstrated below:

```

C#

System.Collections.Generic.Dictionary<string,string> serverChecksums =
...
foreach(System.Collections.Generic.KeyValuePair<string, string> e
in Ice.SliceChecksums.checksums) {
    string checksum;
    if (!serverChecksums.TryGetValue(e.Key, out checksum)) {
        // No match found for type id!
    } else if (!checksum.Equals(e.Value)) {
        // Checksum mismatch!
    }
}
```

In this example, the client first verifies that the server's dictionary contains an entry for each Slice type ID, and then it proceeds to compare the checksums.

See Also

- [Slice Checksums](#)

Example of a File System Client in C-Sharp

This page presents a very simple client to access a server that implements the file system we developed in [Slice for a Simple File System](#). The C# code hardly differs from the code you would write for an ordinary C# program. This is one of the biggest advantages of using Ice: accessing a remote object is as easy as accessing an ordinary, local C# object. This allows you to put your effort where you should, namely, into developing your application logic instead of having to struggle with arcane networking APIs. This is true for the [server side](#) as well, meaning that you can develop distributed applications easily and efficiently.

We now have seen enough of the client-side C# mapping to develop a complete client to access our remote file system. For reference, here is the Slice definition once more:

```

Slice
module Filesystem {
    interface Node {
        idempotent string name();
    };

    exception GenericError {
        string reason;
    };

    sequence<string> Lines;

    interface File extends Node {
        idempotent Lines read();
        idempotent void write(Lines text) throws GenericError;
    };

    sequence<Node*> NodeSeq;

    interface Directory extends Node {
        idempotent NodeSeq list();
    };
};

```

To exercise the file system, the client does a recursive listing of the file system, starting at the root directory. For each node in the file system, the client shows the name of the node and whether that node is a file or directory. If the node is a file, the client retrieves the contents of the file and prints them.

The body of the client code looks as follows:

```

C#
using System;
using Filesystem;

public class Client
{
    // Recursively print the contents of directory "dir"
    // in tree fashion. For files, show the contents of
    // each file. The "depth" parameter is the current

```



```

// nesting level (for indentation).

static void listRecursive(DirectoryPrx dir, int depth)
{
    string indent = new string('\t', ++depth);

    NodePrx[] contents = dir.list();

    foreach (NodePrx node in contents)
        DirectoryPrx subdir = DirectoryPrxHelper.checkedCast(node);
        FilePrx file = FilePrxHelper.uncheckedCast(node);
        Console.WriteLine(
            indent + node.name() +
(subdir != null ? " (directory):" : " (file):"));
        if (subdir != null) {
            listRecursive(subdir, depth);
        } else {
            string[] text = file.read();
            for (int j = 0; j < text.Length; ++j)
                Console.WriteLine(indent + "\t" + text[j]);
        }
    }
}

public static void Main(string[] args)
{
    int status = 0;
    Ice.Communicator ic = null;
    try {
        // Create a communicator
        //
        ic = Ice.Util.initialize(ref args);

        // Create a proxy for the root directory
        //
        Ice.ObjectPrx obj
= ic.stringToProxy("RootDir:default -p 10000");

        // Down-cast the proxy to a Directory proxy
        //
        DirectoryPrx rootDir = DirectoryPrxHelper.checkedCast(obj);

        // Recursively list the contents of the root directory
        //
        Console.WriteLine("Contents of root directory:");
        listRecursive(rootDir, 0);
    } catch (Exception e) {
        Console.Error.WriteLine(e);
        status = 1;
    }
}

```

```
if (ic != null) {
    // Clean up
    //
    try {
        ic.destroy();
    } catch (Exception e) {
        Console.Error.WriteLine(e);
        status = 1;
    }
}
Environment.Exit(status);
```

```

    }
}

```

The `Client` class defines two methods: `listRecursive`, which is a helper function to print the contents of the file system, and `Main`, which is the main program. Let us look at `Main` first:

1. The structure of the code in `Main` follows what we saw in [Hello World Application](#). After initializing the run time, the client creates a proxy to the root directory of the file system. For this example, we assume that the server runs on the local host and listens using the default protocol (TCP/IP) at port 10000. The object identity of the root directory is known to be `RootDir`.
2. The client down-casts the proxy to `DirectoryPrx` and passes that proxy to `listRecursive`, which prints the contents of the file system.

Most of the work happens in `listRecursive`. The function is passed a proxy to a directory to list, and an indent level. (The indent level increments with each recursive call and allows the code to print the name of each node at an indent level that corresponds to the depth of the tree at that node.) `listRecursive` calls the `list` operation on the directory and iterates over the returned sequence of nodes:

1. The code does a `checkedCast` to narrow the `Node` proxy to a `Directory` proxy, as well as an `uncheckedCast` to narrow the `Node` proxy to a `File` proxy. Exactly one of those casts will succeed, so there is no need to call `checkedCast` twice: if the `Node` is a `Directory`, the code uses the `DirectoryPrx` returned by the `checkedCast`; if the `checkedCast` fails, we know that the `Node` is a `File` and, therefore, an `uncheckedCast` is sufficient to get a `FilePrx`.
In general, if you know that a down-cast to a specific type will succeed, it is preferable to use an `uncheckedCast` instead of a `checkedCast` because an `uncheckedCast` does not incur any network traffic.
2. The code prints the name of the file or directory and then, depending on which cast succeeded, prints "(directory)" or "(file)" following the name.
3. The code checks the type of the node:
 - If it is a directory, the code recurses, incrementing the indent level.
 - If it is a file, the code calls the `read` operation on the file to retrieve the file contents and then iterates over the returned sequence of lines, printing each line.

Assume that we have a small file system consisting of two files and a directory as follows:

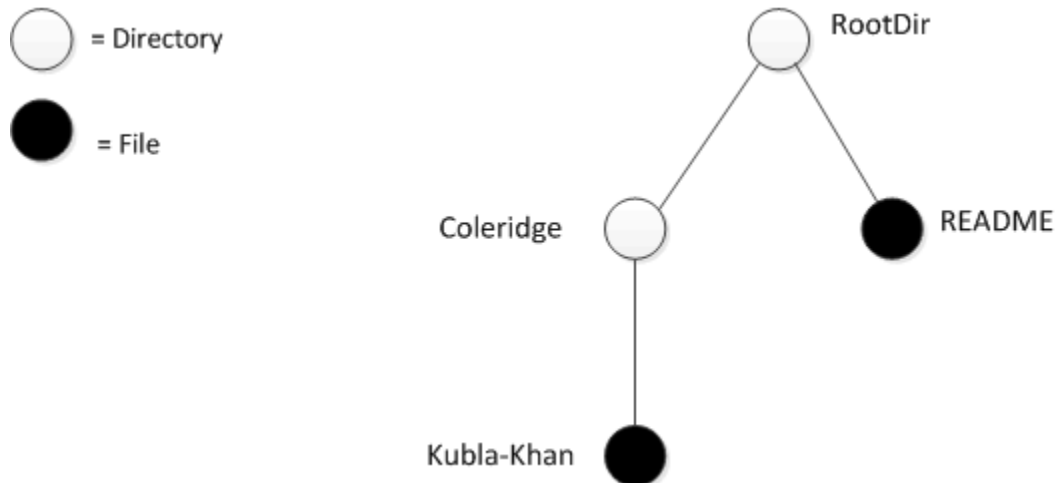

A small file system.

The output produced by the client for this file system is:

```
Contents of root directory:
```

```
  README (file):
```

```
    This file system contains a collection of poetry.
```

```
  Coleridge (directory):
```

```
    Kubla_Khan (file):
```

```
      In Xanadu did Kubla Khan
```

```
      A stately pleasure-dome decree:
```

```
      Where Alph, the sacred river, ran
```

```
      Through caverns measureless to man
```

```
      Down to a sunless sea.
```

Note that, so far, our client (and server) are not very sophisticated:

- The protocol and address information are hard-wired into the code.
- The client makes more remote procedure calls than strictly necessary; with minor redesign of the Slice definitions, many of these calls can be avoided.

We will see how to address these shortcomings in our discussions of [IceGrid](#) and [object life cycle](#).

See Also

- [Hello World Application](#)
- [Slice for a Simple File System](#)
- [Example of a File System Server in C-Sharp](#)
- [Object Life Cycle](#)
- [IceGrid](#)

Server-Side Slice-to-C-Sharp Mapping

The mapping for Slice data types to C# is identical on the client side and server side. This means that everything in the [Client-Side Slice-to-C-Sharp Mapping](#) also applies to the server side. However, for the server side, there are a few additional things you need to know — specifically, how to:

- Initialize and finalize the server-side run time
- Implement servants
- Pass parameters and throw exceptions
- Create servants and register them with the Ice run time.

Because the mapping for Slice data types is identical for clients and servers, the server-side mapping only adds a few additional mechanisms to the client side: a small API to initialize and finalize the run time, plus a few rules for how to derive servant classes from skeletons and how to register servants with the server-side run time.

Although the examples we present in this chapter are very simple, they accurately reflect the basics of writing an Ice server. Of course, for more sophisticated servers, you will be using [additional APIs](#), for example, to improve performance or scalability. However, these APIs are all described in Slice, so, to use these APIs, you need not learn any C# mapping rules beyond those described here.

Topics

- [The Server-Side main Method in C-Sharp](#)
- [Server-Side C-Sharp Mapping for Interfaces](#)
- [Parameter Passing in C-Sharp](#)
- [Raising Exceptions in C-Sharp](#)
- [Tie Classes in C-Sharp](#)
- [Object Incarnation in C-Sharp](#)
- [Asynchronous Method Dispatch \(AMD\) in C-Sharp](#)
- [Example of a File System Server in C-Sharp](#)

The Server-Side main Method in C-Sharp

On this page:

- [A Basic Main Method in C#](#)
- [The `Ice.Application` Class in C#](#)
 - [Using `Ice.Application` on the Client Side in C#](#)
 - [Catching Signals in C#](#)
 - [Ice.Application and Properties in C#](#)
 - [Limitations of `Ice.Application` in C#](#)

A Basic main Method in C#

The main entry point to the Ice run time is represented by the local interface `Ice::Communicator`. As for the client side, you must initialize the Ice run time by calling `Ice.Util.initialize` before you can do anything else in your server. `Ice.Util.initialize` returns a reference to an instance of an `Ice.Communicator`:

C#

```

using System;

public class Server
{
    public static void Main(string[] args)
    {
        int status = 0;
        Ice.Communicator communicator = null;

        try {
            communicator = Ice.Util.initialize(ref args);
            // ...
        } catch (Exception ex) {
            Console.Error.WriteLine(ex);
            status = 1;
        }
        // ...
    }
}

```

`Ice.Util.initialize` accepts the argument vector that is passed to `Main` by the operating system. The method scans the argument vector for any [command-line options](#) that are relevant to the Ice run time; any such options are removed from the argument vector so, when `Ice.Util.initialize` returns, the only options and arguments remaining are those that concern your application. If anything goes wrong during initialization, `initialize` throws an exception.

Before leaving your `Main` method, you *must* call `Communicator.destroy`. The `destroy` operation is responsible for finalizing the Ice run time. In particular, `destroy` waits for any operation implementations that are still executing in the server to complete. In addition, `destroy` ensures that any outstanding threads are joined with and reclaims a number of operating system resources, such as file descriptors and memory. Never allow your `Main` method to terminate without calling `destroy` first; doing so has undefined behavior.

The general shape of our server-side `Main` method is therefore as follows:

C#

```

using System;

public class Server
{
    public static void Main(string[] args)
    {
        int status = 0;
        Ice.Communicator communicator = null;

        try {
            communicator = Ice.Util.initialize(ref args);
            // ...
        } catch (Exception ex) {
            Console.Error.WriteLine(ex);
            status = 1;
        }
        if (communicator != null) {
            try {
                communicator.destroy();
            } catch (Exception ex) {
                Console.Error.WriteLine(ex);
                status = 1;
            }
        }
        Environment.Exit(status);
    }
}

```

Note that the code places the call to `Ice.Util.initialize` into a `try` block and takes care to return the correct exit status to the operating system. Also note that an attempt to destroy the communicator is made only if the initialization succeeded.

The `Ice.Application` Class in C#

The preceding structure for the `Main` method is so common that Ice offers a class, `Ice.Application`, that encapsulates all the correct initialization and finalization activities. The synopsis of the class is as follows (with some detail omitted for now):

C#

```

namespace Ice
{
    public abstract class Application
    {
        public abstract int run(string[] args);

        public Application();

        public Application(SignalPolicy signalPolicy);

        public int main(string[] args);
        public int main(string[] args, string configFile);
        public int main(string[] args, InitializationData init);

        public static string appName();

        public static Communicator communicator();
    }
}

```

The intent of this class is that you specialize `Ice.Application` and implement the abstract `run` method in your derived class. Whatever code you would normally place in `Main` goes into the `run` method instead. Using `Ice.Application`, our program looks as follows:

C#

```

using System;

public class Server
{
    class App : Ice.Application
    {
        public override int run(string[] args)
        {
            // Server code here...

            return 0;
        }
    }

    public static void Main(string[] args)
    {
        App app = new App();
        Environment.Exit(app.main(args));
    }
}

```

Note that `Application.main` is overloaded: you can pass an optional file name or an `InitializationData` structure.

If you pass a `configuration file name` to `main`, the property settings in this file are overridden by settings in a file identified by the `ICE_CONFIG` environment variable (if defined). Property settings supplied on the `command line` take precedence over all other settings.

The `Application.main` method does the following:

1. It installs an exception handler for `System.Exception`. If your code fails to handle an exception, `Application.main` prints the name of the exception and a stack trace on `Console.Error` before returning with a non-zero return value.
2. It initializes (by calling `Ice.Util.initialize`) and finalizes (by calling `Communicator.destroy`) a communicator. You can get access to the communicator for your server by calling the static `communicator` accessor.
3. It scans the argument vector for options that are relevant to the Ice run time and removes any such options. The argument vector that is passed to your `run` method therefore is free of Ice-related options and only contains options and arguments that are specific to your application.
4. It provides the name of your application via the static `appName` method. You can get at the application name from anywhere in your code by calling `Ice.Application.appName` (which is usually required for error messages).
5. It installs a signal handler that properly destroys the communicator.
6. It installs a `per-process logger` if the application has not already configured one. The per-process logger uses the value of the `Ice.ProgramName` property as a prefix for its messages and sends its output to the standard error channel. An application can also specify an `alternate logger`.

Using `Ice.Application` ensures that your program properly finalizes the Ice run time, whether your server terminates normally or in response to an exception. We recommend that all your programs use this class; doing so makes your life easier. In addition, `Ice.Application` also provides features for signal handling and configuration that you do not have to implement yourself when you use this class.

Using `Ice.Application` on the Client Side in C#

You can use `Ice.Application` for your clients as well: simply implement a class that derives from `Ice.Application` and place the client code into its `run` method. The advantage of this approach is the same as for the server side: `Ice.Application` ensures that the communicator is destroyed correctly even in the presence of exceptions.

Catching Signals in C#

The simple server we developed in [Hello World Application](#) had no way to shut down cleanly: we simply interrupted the server from the command line to force it to exit. Terminating a server in this fashion is unacceptable for many real-life server applications: typically, the server has to perform some cleanup work before terminating, such as flushing database buffers or closing network connections. This is particularly important on receipt of a signal or keyboard interrupt to prevent possible corruption of database files or other persistent data.

To make it easier to deal with signals, `Ice.Application` encapsulates the low-level signal handling tasks, allowing you to cleanly shut down on receipt of a signal.

C#

```

namespace Ice
{
    public abstract class Application
    {
        // ...

        public static void destroyOnInterrupt();
        public static void shutdownOnInterrupt();
        public static void ignoreInterrupt();
        public static void callbackOnInterrupt();
        public static void holdInterrupt();
        public static void releaseInterrupt();

        public static bool interrupted();

        public virtual void interruptCallback(int sig);
    }
}

```

The methods behave as follows:

- `destroyOnInterrupt`
This method installs a handler that destroys the communicator if it is interrupted. This is the default behavior.
- `shutdownOnInterrupt`
This method installs a handler that shuts down the communicator if it is interrupted.
- `ignoreInterrupt`
This method causes signals to be ignored.
- `callbackOnInterrupt`
This method configures `Ice.Application` to invoke `interruptCallback` when a signal occurs, thereby giving the subclass responsibility for handling the signal.
- `holdInterrupt`
This method temporarily blocks signal delivery.
- `releaseInterrupt`
This method restores signal delivery to the previous disposition. Any signal that arrives after `holdInterrupt` was called is delivered when you call `releaseInterrupt`.
- `interrupted`
This method returns `true` if a signal caused the communicator to shut down, `false` otherwise. This allows us to distinguish intentional shutdown from a forced shutdown that was caused by a signal. This is useful, for example, for logging purposes.
- `interruptCallback`
A subclass overrides this method to respond to signals. The method may be called concurrently with any other thread and must not raise exceptions.

By default, `Ice.Application` behaves as if `destroyOnInterrupt` was invoked, therefore our server `Main` method requires no change to ensure that the program terminates cleanly on receipt of a signal. (You can disable the signal-handling functionality of `Ice.Application` by passing the enumerator `NoSignalHandling` to the constructor. In that case, signals retain their default behavior, that is, terminate the process.) However, we add a diagnostic to report the occurrence, so our `run` method now looks like:

C#

```

using System;

public class Server
{
    class App : Ice.Application
    {
        public override int run(string[] args)
        {
            // Server code here...

            if (interrupted())
                Console.Error.WriteLine(appName() + ": terminating");

            return 0;
        }
    }

    public static void Main(string[] args)
    {
        App app = new App();
        Environment.Exit(app.main(args));
    }
}

```

Ice.Application and Properties in C#

Apart from the functionality shown in this section, `Ice.Application` also takes care of initializing the Ice run time with property values. [Properties](#) allow you to configure the run time in various ways. For example, you can use properties to control things such as the thread pool size or port number for a server. The `main` method of `Ice.Application` is overloaded; the second version allows you to specify the name of a configuration file that will be processed during initialization.

Limitations of Ice.Application in C#

`Ice.Application` is a singleton class that creates a single communicator. If you are using multiple communicators, you cannot use `Ice.Application`. Instead, you must structure your code as we saw in [Hello World Application](#) (taking care to always destroy the communicator).

See Also

- [Hello World Application](#)
- [Properties and Configuration](#)
- [Communicator Initialization](#)
- [Logger Facility](#)

Server-Side C-Sharp Mapping for Interfaces

The server-side mapping for interfaces provides an up-call API for the Ice run time: by implementing methods in a servant class, you provide the hook that gets the thread of control from the Ice server-side run time into your application code.

On this page:

- [Skeleton Classes in C#](#)
- [Servant Classes in C#](#)
 - [Server-Side Normal and `idempotent` Operations in C#](#)

Skeleton Classes in C#

On the client side, interfaces map to [proxy classes](#). On the server side, interfaces map to *skeleton* classes. A skeleton is a class that has an abstract method for each operation on the corresponding interface. For example, consider our [Slice definition](#) for the `Node` interface:

```

Slice



```
module Filesystem {
 interface Node {
 idempotent string name();
 };
 // ...
};
```

```

The Slice compiler generates the following definition for this interface:

```

C#
namespace Filesystem
{
    public interface NodeOperations_
    {
        string name(Ice.Current __current);
    }

    public interface NodeOperationsNC_
    {
        string name();
    }

    public interface Node : Ice.Object,
NodeOperations_, NodeOperationsNC_
    {
    }

    public abstract class NodeDisp_ : Ice.ObjectImpl, Node
    {
        public string name()
        {
            return name(new Ice.Current());
        }

        public abstract string name(Ice.Current __current);

        // Mapping-internal code here...
    }
}

```

The important points to note here are:

- As for the client side, Slice modules are mapped to C# namespaces with the same name, so the skeleton class definitions are part of the `Filesystem` namespace.
- For each Slice interface `<interface-name>`, the compiler generates C# interfaces `<interface-name>Operations_` and `<interface-name>OperationsNC_` (`NodeOperations_` and `NodeOperationsNC_` in this example). These interfaces contain a method for each operation in the Slice interface. (You can ignore the `Ice.Current` parameter for the now.)
- For each Slice interface `<interface-name>`, the compiler generates a C# interface `<interface-name>` (`Node` in this example). That interface extends `Ice.Object` and the two operations interfaces.
- For each Slice interface `<interface-name>`, the compiler generates an abstract class `<interface-name>Disp_` (`NodeDisp_` in this example). This abstract class is the actual skeleton class; it is the base class from which you derive your servant class.

Servant Classes in C#

In order to provide an implementation for an Ice object, you must create a servant class that inherits from the corresponding skeleton class. For example, to create a servant for the `Node` interface, you could write:

```
C#
```

```

public class NodeI : NodeDisp_
{
    public NodeI(string name)
    {
        _name = name;
    }

    public override string name(Ice.Current current)
    {
        return _name;
    }

    private string _name;
}

```

By convention, servant classes have the name of their interface with an `I`-suffix, so the servant class for the `Node` interface is called `NodeI`. (This is a convention only: as far as the Ice run time is concerned, you can choose any name you prefer for your servant classes.) Note that `NodeI` extends `NodeDisp_`, that is, it derives from its skeleton class.

As far as Ice is concerned, the `NodeI` class must implement only a single method: the abstract `name` method that it inherits from its skeleton. This makes the servant class a concrete class that can be instantiated. You can add other methods and data members as you see fit to support your implementation. For example, in the preceding definition, we added a `_name` member and a constructor. (Obviously, the constructor initializes the `_name` member and the `name` method returns its value.)

Server-Side Normal and `idempotent` Operations in C#

Whether an operation is an ordinary operation or an `idempotent` operation has no influence on the way the operation is mapped. To illustrate this, consider the following interface:

```
Slice
```

```

interface Example {
    void          normalOp();
    idempotent void idempotentOp();
};

```

The operations class for this interface looks like this:

```
C#
```

```

public interface ExampleOperations_
{
    void normalOp(Ice.Current __current);
    void idempotentOp(Ice.Current __current);
}

```

Note that the signatures of the methods are unaffected by the `idempotent` qualifier.

See Also

- [Slice for a Simple File System](#)
- [Parameter Passing in C-Sharp](#)
- [Raising Exceptions in C-Sharp](#)
- [Tie Classes in C-Sharp](#)
- [The Current Object](#)

Parameter Passing in C-Sharp

Parameter Passing in C#

For each parameter of a Slice operation, the C# mapping generates a corresponding parameter for the corresponding method in the *<interface-name>Operations_* interface. In addition, every operation has an additional, trailing parameter of type `Ice.Current`. For example, the `name` operation of the `Node` interface has no parameters, but the `name` method of the `NodeOperations_` interface has a single parameter of type `Ice.Current`. We will ignore this parameter for now.

Parameter passing on the server side follows the rules for the [client side](#). To illustrate the rules, consider the following interface that passes string parameters in all possible directions:

```

Slice
module M {
  interface Example {
    string op(string sin, out string sout);
  };
};

```

The generated method for `op` looks as follows:

```

C#
public interface ExampleOperations_
{
  string op(string sin, out string sout, Ice.Current __current);
}

```

As you can see, there are no surprises here. For example, we could implement `op` as follows:

```

C#
using System;

public class ExampleI : ExampleDisp_
{
  public override string op(string sin, out string sout,
Ice.Current current)
  {
    Console.WriteLine(sin);           // In params are initialized
    sout = "Hello World!";           // Assign out param
    return "Done";
  }
}

```

This code is in no way different from what you would normally write if you were to pass strings to and from a method; the fact that remote procedure calls are involved does not affect your code in any way. The same is true for parameters of other types, such as proxies, classes, or dictionaries: the parameter passing conventions follow normal C# rules and do not require special-purpose API calls.

See Also

- [Server-Side C-Sharp Mapping for Interfaces](#)
- [Raising Exceptions in C-Sharp](#)
- [Tie Classes in C-Sharp](#)
- [The Current Object](#)

Raising Exceptions in C-Sharp

To throw an exception from an operation implementation, you simply instantiate the exception, initialize it, and throw it. For example:

```

C#



```

// ...
public override void write(string[] text, Ice.Current current)
{
 try
 {
 // Try to write file contents here...
 }
 catch(System.Exception ex)
 {
 GenericError e = new GenericError("cannot write file", ex);
 e.reason = "Exception during write operation";
 throw e;
 }
}

```

```

Note that, for this example, we have supplied the [optional second parameter](#) to the `GenericError` constructor. This parameter sets the `InnerException` member of `System.Exception` and preserves the original cause of the error for later diagnosis.

If you throw an arbitrary C# run-time exception (such as an `InvalidCastException`), the Ice run time catches the exception and then returns an `UnknownException` to the client. Similarly, if you throw an "impossible" user exception (a user exception that is not listed in the exception specification of the operation), the client receives an `UnknownUserException`.

If you throw an Ice run-time exception, such `MemoryLimitException`, the client receives an `UnknownLocalException`. For that reason, you should never throw system exceptions from operation implementations. If you do, all the client will see is an `UnknownLocalException`, which does not tell the client anything useful.



Three run-time exceptions are [treated specially](#) and not changed to `UnknownLocalException` when returned to the client: `ObjectNotExistException`, `OperationNotExistException`, and `FacetNotExistException`.

See Also

- [Run-Time Exceptions](#)
- [C-Sharp Mapping for Exceptions](#)
- [Server-Side C-Sharp Mapping for Interfaces](#)
- [Parameter Passing in C-Sharp](#)
- [Tie Classes in C-Sharp](#)

Tie Classes in C-Sharp

The mapping to [skeleton classes](#) requires the servant class to inherit from its skeleton class. Occasionally, this creates a problem: some class libraries require you to inherit from a base class in order to access functionality provided by the library; because C# does not support multiple implementation inheritance, this means that you cannot use such a class library to implement your servants because your servants cannot inherit from both the library class and the skeleton class simultaneously.

To allow you to still use such class libraries, Ice provides a way to write servants that replaces inheritance with delegation. This approach is supported by *tie classes*. The idea is that, instead of inheriting from the skeleton class, you simply create a class (known as an *implementation class* or *delegate class*) that contains methods corresponding to the operations of an interface. You use the `--tie` option with the `slice2cs` compiler to create a tie class. For example, the `--tie` option causes the compiler to create exactly the same code for the [Node interface](#) as we saw previously, but to also emit an additional tie class. For an interface `<interface-name>`, the generated tie class has the name `<interface-name>Tie_:`

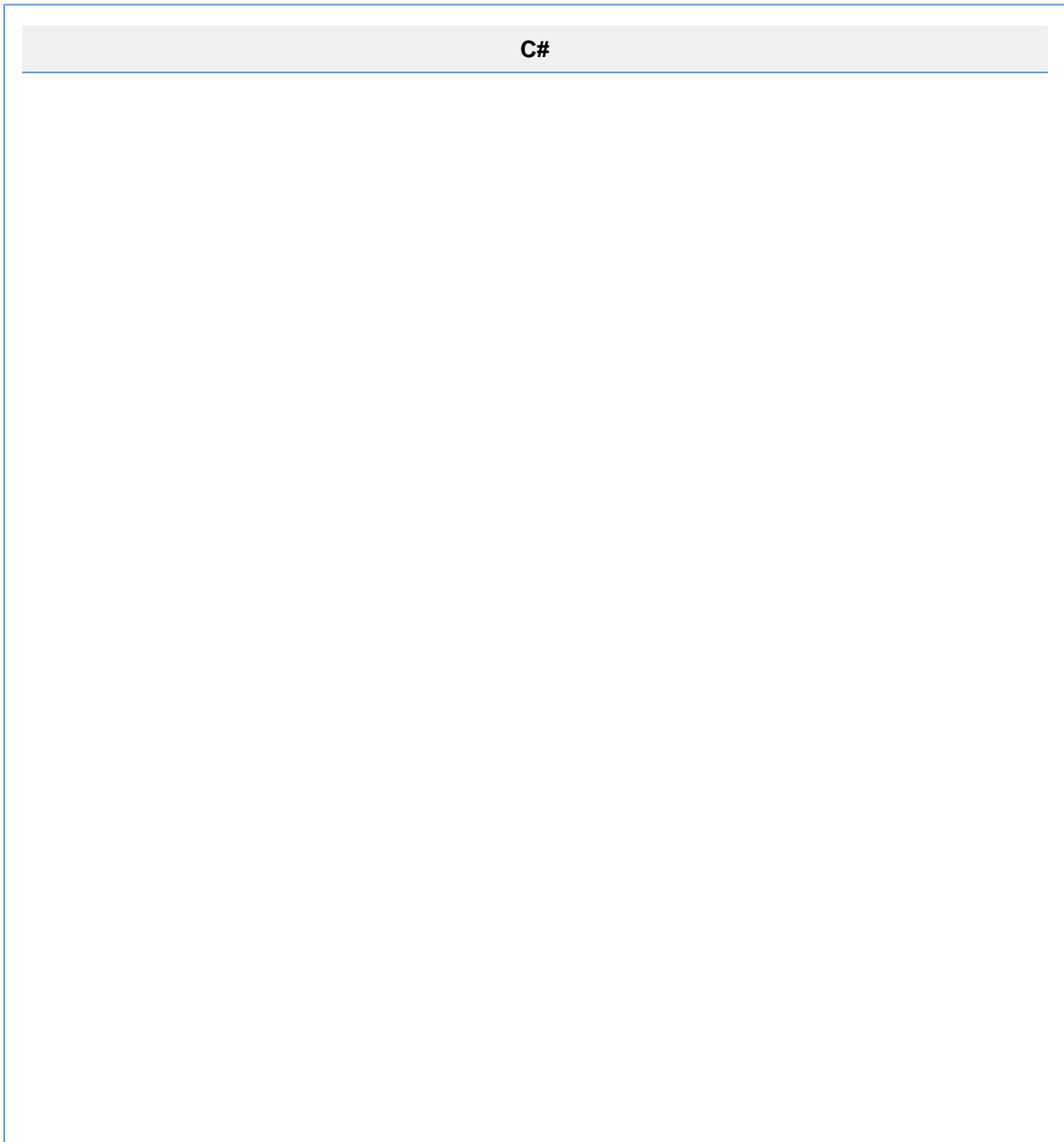

```

public class NodeTie_ : NodeDisp_, Ice.TieBase
{
    public NodeTie_()
    {
    }

    public NodeTie_(NodeOperations_ del)
    {
        _ice_delegate = del;
    }

    public object ice_delegate()
    {
        return _ice_delegate;
    }

    public void ice_delegate(object del)
    {
        _ice_delegate = (NodeOperations_)del;
    }

    public override int GetHashCode()
    {
        return _ice_delegate == null ? 0 : _ice_delegate.GetHashCode();
    }

    public override bool Equals(object rhs)
    {
        if (object.ReferenceEquals(this, rhs))
        {
            return true;
        }
        if (!(rhs is NodeTie_))
        {
            return false;
        }
        if (_ice_delegate == null)
        {
            return ((NodeTie_)rhs)._ice_delegate == null;
        }
        return _ice_delegate.Equals(((NodeTie_)rhs)._ice_delegate);
    }

    public override string name(Ice.Current __current)
    {
        return _ice_delegate.name(__current);
    }

    private NodeOperations_ _ice_delegate;
}

```

This looks a lot worse than it is: in essence, the generated tie class is simply a servant class (it extends `NodeDisp_`) that delegates each invocation of a method that corresponds to a Slice operation to your implementation class:

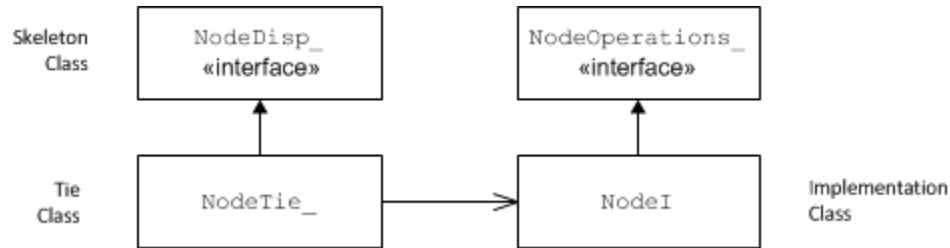

A skeleton class, tie class, and implementation class.

The `Ice.TieBase` interface defines the `ice_delegate` methods that allow you to get and set the delegate.

Given this machinery, we can create an implementation class for our `Node` interface as follows:

```

C#
public class NodeI : NodeOperations_
{
    public NodeI(string name)
    {
        _name = name;
    }

    public override string name(Ice.Current current)
    {
        return _name;
    }

    private string _name;
}
  
```

Note that this class is identical to our previous implementation, except that it implements the `NodeOperations_` interface and does not extend `NodeDisp_` (which means that you are now free to extend any other class to support your implementation).

To create a servant, you instantiate your implementation class and the tie class, passing a reference to the implementation instance to the tie constructor:

```

C#
NodeI fred = new NodeI("Fred"); // Create implementation
NodeTie_ servant = new NodeTie_(fred); // Create tie
  
```

Alternatively, you can also default-construct the tie class and later set its delegate instance by calling `ice_delegate`:

```
C#
```

```
NodeTie_ servant = new NodeTie_();      // Create tie
// ...
NodeI fred = new NodeI("Fred");       // Create implementation
// ...
servant.ice_delegate(fred);           // Set delegate
```

When using tie classes, it is important to remember that the tie instance is the servant, not your delegate. Furthermore, you must not use a tie instance to *incarnate* an Ice object until the tie has a delegate. Once you have set the delegate, you must not change it for the lifetime of the tie; otherwise, undefined behavior results.

You should use the tie approach only if you need to, that is, if you need to extend some base class in order to implement your servants: using the tie approach is more costly in terms of memory because each Ice object is incarnated by two C# objects (the tie and the delegate) instead of just one. In addition, call dispatch for ties is marginally slower than for ordinary servants because the tie forwards each operation to the delegate, that is, each operation invocation requires two function calls instead of one.

Also note that, unless you arrange for it, there is no way to get from the delegate back to the tie. If you need to navigate back to the tie from the delegate, you can store a reference to the tie in a member of the delegate. (The reference can, for example, be initialized by the constructor of the delegate.)

See Also

- [Server-Side C-Sharp Mapping for Interfaces](#)
- [Parameter Passing in C-Sharp](#)
- [Raising Exceptions in C-Sharp](#)
- [Object Incarnation in C-Sharp](#)

Object Incarnation in C-Sharp

Having created a servant class such as the rudimentary `NodeI` class, you can instantiate the class to create a concrete servant that can receive invocations from a client. However, merely instantiating a servant class is insufficient to incarnate an object. Specifically, to provide an implementation of an Ice object, you must take the following steps:

1. [Instantiate a servant class.](#)
2. [Create an identity](#) for the Ice object incarnated by the servant.
3. Inform the Ice run time of the existence of the servant.
4. [Pass a proxy](#) for the object to a client so the client can reach it.

On this page:

- [Instantiating a C# Servant](#)
- [Creating an Identity in C#](#)
- [Activating a C# Servant](#)
- [UUIDs as Identities in C#](#)
- [Creating Proxies in C#](#)
 - [Proxies and Servant Activation in C#](#)
 - [Direct Proxy Creation in C#](#)

Instantiating a C# Servant

Instantiating a servant means to allocate an instance:

```
C#
```

```
Node servant = new NodeI("Fred");
```

This code creates a new `NodeI` instance and assigns its address to a reference of type `Node`. This works because `NodeI` is derived from `Node`, so a `Node` reference can refer to an instance of type `NodeI`. However, if we want to invoke a method of the `NodeI` class at this point, we must use a `NodeI` reference:

```
C#
```

```
NodeI servant = new NodeI("Fred");
```

Whether you use a `Node` or a `NodeI` reference depends purely on whether you want to invoke a method of the `NodeI` class: if not, a `Node` reference works just as well as a `NodeI` reference.

Creating an Identity in C#

Each Ice object requires an identity. That identity must be unique for all servants using the same object adapter.

 The Ice object model assumes that all objects (regardless of their adapter) have a [globally unique identity](#).

An Ice object identity is a structure with the following Slice definition:

Slice

```

module Ice {
    struct Identity {
        string name;
        string category;
    };
    // ...
};

```

The full identity of an object is the combination of both the `name` and `category` fields of the `Identity` structure. For now, we will leave the `category` field as the empty string and simply use the `name` field. (The `category` field is most often used in conjunction with [servant locators](#).)

To create an identity, we simply assign a key that identifies the servant to the `name` field of the `Identity` structure:

C#

```

Ice.Identity id = new Ice.Identity();
id.name = "Fred"; // Not unique, but good enough for now

```

Activating a C# Servant

Merely creating a servant instance does nothing: the Ice run time becomes aware of the existence of a servant only once you explicitly tell the object adapter about the servant. To activate a servant, you invoke the `add` operation on the object adapter. Assuming that we have access to the object adapter in the `_adapter` variable, we can write:

C#

```

_adapter.add(servant, id);

```

Note the two arguments to `add`: the servant and the object identity. Calling `add` on the object adapter adds the servant and the servant's identity to the adapter's servant map and links the proxy for an Ice object to the correct servant instance in the server's memory as follows:

1. The proxy for an Ice object, apart from addressing information, contains the identity of the Ice object. When a client invokes an operation, the object identity is sent with the request to the server.
2. The object adapter receives the request, retrieves the identity, and uses the identity as an index into the servant map.
3. If a servant with that identity is active, the object adapter retrieves the servant from the servant map and dispatches the incoming request into the correct method on the servant.

Assuming that the object adapter is in the [active state](#), client requests are dispatched to the servant as soon as you call `add`.

UUIDs as Identities in C#

The Ice object model assumes that object identities are globally unique. One way of ensuring that uniqueness is to use UUIDs (Universally Unique Identifiers) as identities. .NET provides a helper function that we can use to create such identities:

C#

```
public class Example
{
    public static void Main(string[] args)
    {
        System.Console.WriteLine(System.Guid.NewGuid().ToString());
    }
}
```

When executed, this program prints a unique string such as 5029a22c-e333-4f87-86b1-cd5e0fccc509. Each call to `NewGuid` creates a string that differs from all previous ones.

You can use a UUID such as this to create object identities. For convenience, the object adapter has an operation `addWithUUID` that generates a UUID and adds a servant to the servant map in a single step. Using this operation, we can create an identity and register a servant with that identity in a single step as follows:

C#

```
_adapter.addWithUUID(new NodeI("Fred"));
```

Creating Proxies in C#

Once we have activated a servant for an Ice object, the server can process incoming client requests for that object. However, clients can only access the object once they hold a proxy for the object. If a client knows the server's address details and the object identity, it can create a proxy from a string, as we saw in our first example in [Hello World Application](#). However, creation of proxies by the client in this manner is usually only done to allow the client access to initial objects for bootstrapping. Once the client has an initial proxy, it typically obtains further proxies by invoking operations.

The object adapter contains all the details that make up the information in a proxy: the addressing and protocol information, and the object identity. The Ice run time offers a number of ways to create proxies. Once created, you can pass a proxy to the client as the return value or as an out-parameter of an operation invocation.

Proxies and Servant Activation in C#

The `add` and `addWithUUID` servant activation operations on the object adapter return a proxy for the corresponding Ice object. This means we can write:

C#

```
NodePrx proxy = NodePrxHelper.uncheckedCast(_adapter.addWithUUID(new NodeI("Fred")));
```

Here, `addWithUUID` both activates the servant and returns a proxy for the Ice object incarnated by that servant in a single step.

Note that we need to use an `uncheckedCast` here because `addWithUUID` returns a proxy of type `Ice.ObjectPrx`.

Direct Proxy Creation in C#

The object adapter offers an operation to create a proxy for a given identity:

Slice

```

module Ice {
  local interface ObjectAdapter {
    Object* createProxy(Identity id);
    // ...
  };
};

```

Note that `createProxy` creates a proxy for a given identity whether a servant is activated with that identity or not. In other words, proxies have a life cycle that is quite independent from the life cycle of servants:

C#

```

Ice.Identity id = new Ice.Identity();
id.name = System.Guid.NewGuid().ToString();
Ice.ObjectPrx o = _adapter.createProxy(id);

```

This creates a proxy for an Ice object with the identity returned by `NewGuid`. Obviously, no servant yet exists for that object so, if we return the proxy to a client and the client invokes an operation on the proxy, the client will receive an `ObjectNotExistException`. (We examine these life cycle issues in more detail in [Object Life Cycle](#).)

See Also

- [Hello World Application](#)
- [Server-Side C-Sharp Mapping for Interfaces](#)
- [Object Adapter States](#)
- [Servant Locators](#)
- [Object Life Cycle](#)

Asynchronous Method Dispatch (AMD) in C-Sharp

The number of simultaneous synchronous requests a server is capable of supporting is determined by the number of threads in the server's [thread pool](#). If all of the threads are busy dispatching long-running operations, then no threads are available to process new requests and therefore clients may experience an unacceptable lack of responsiveness.

Asynchronous Method Dispatch (AMD), the server-side equivalent of [AMI](#), addresses this scalability issue. Using AMD, a server can receive a request but then suspend its processing in order to release the dispatch thread as soon as possible. When processing resumes and the results are available, the server sends a response explicitly using a callback object provided by the Ice run time.

AMD is transparent to the client, that is, there is no way for a client to distinguish a request that, in the server, is processed synchronously from a request that is processed asynchronously.

In practical terms, an AMD operation typically queues the request data (i.e., the callback object and operation arguments) for later processing by an application thread (or thread pool). In this way, the server minimizes the use of dispatch threads and becomes capable of efficiently supporting thousands of simultaneous clients.

An alternate use case for AMD is an operation that requires further processing after completing the client's request. In order to minimize the client's delay, the operation returns the results while still in the dispatch thread, and then continues using the dispatch thread for additional work.

On this page:

- [Enabling AMD with Metadata in C#](#)
- [AMD Mapping in C#](#)
 - [Callback Interface for AMD](#)
 - [Dispatch Method for AMD](#)
- [AMD Exceptions in C#](#)
- [AMD Example in C#](#)

Enabling AMD with Metadata in C#

To enable asynchronous dispatch, you must add an ["amd"] metadata directive to your Slice definitions. The directive applies at the interface and the operation level. If you specify ["amd"] at the interface level, all operations in that interface use asynchronous dispatch; if you specify ["amd"] for an individual operation, only that operation uses asynchronous dispatch. In either case, the metadata directive replaces synchronous dispatch, that is, a particular operation implementation must use synchronous or asynchronous dispatch and cannot use both.

Consider the following Slice definitions:

Slice
<pre>["amd"] interface I { bool isValid(); float computeRate(); }; interface J { ["amd"] void startProcess(); int endProcess(); };</pre>

In this example, both operations of interface `I` use asynchronous dispatch, whereas, for interface `J`, `startProcess` uses asynchronous dispatch and `endProcess` uses synchronous dispatch.

Specifying metadata at the operation level (rather than at the interface or class level) minimizes the amount of generated code and, more importantly, minimizes complexity: although the asynchronous model is more flexible, it is also more complicated to use. It is therefore in your best interest to limit the use of the asynchronous model to those operations that need it, while using the simpler synchronous model for

the rest.

AMD Mapping in C#

The C# mapping emits the following code for each AMD operation:

1. Callback interface
2. Dispatch method

Callback Interface for AMD

A callback interface is used by the implementation to notify the Ice run time about the completion of an operation. The name of this interface is formed using the pattern `AMD_class_op`. For example, an operation named `foo` defined in interface `I` results in an interface named `AMD_I_foo`. The interface is generated in the same scope as the interface or class containing the operation. Two methods are provided:

```
C#  
public void ice_response(<params>);
```

The `ice_response` method allows the server to report the successful completion of the operation. If the operation has a non-void return type, the first parameter to `ice_response` is the return value. Parameters corresponding to the operation's `out` parameters follow the return value, in the order of declaration.

```
C#  
public void ice_exception(System.Exception ex);
```

The `ice_exception` method allows the server to raise an exception. Although any exception type could conceivably be passed to `ice_exception`, the Ice run time [validates](#) the exception value using the same semantics as for synchronous dispatch.

Neither `ice_response` nor `ice_exception` throw any exceptions to the caller.

Dispatch Method for AMD

The dispatch method, whose name has the suffix `_async`, has a `void` return type. The first parameter is a reference to an instance of the callback interface described above. The remaining parameters comprise the `in` parameters of the operation, in the order of declaration.

For example, suppose we have defined the following operation:

```
Slice  
interface I {  
    ["amd"] int foo(short s, out long l);  
};
```

The callback interface generated for operation `foo` is shown below:

C#

```
public interface AMD_I_foo
{
    void ice_response(int __ret, long l);
    void ice_exception(System.Exception ex);
}
```

The dispatch method for asynchronous invocation of operation `foo` is generated as follows:

C#

```
public abstract void foo_async(AMD_I_foo __cb, short s,
    Ice.Current __current);
```

AMD Exceptions in C#

There are two processing contexts in which the logical implementation of an AMD operation may need to report an exception: the dispatch thread (the thread that receives the invocation), and the response thread (the thread that sends the response).



These are not necessarily two different threads: it is legal to send the response from the dispatch thread.

Although we recommend that the callback object be used to report all exceptions to the client, it is legal for the implementation to raise an exception instead, but only from the dispatch thread.

As you would expect, an exception raised from a response thread cannot be caught by the Ice run time; the application's run time environment determines how such an exception is handled. Therefore, a response thread must ensure that it traps all exceptions and sends the appropriate response using the callback object. Otherwise, if a response thread is terminated by an uncaught exception, the request may never be completed and the client might wait indefinitely for a response.

Whether raised in a dispatch thread or reported via the callback object, user exceptions are validated as described in [User Exceptions](#), and local exceptions may undergo the translation described in [Run-Time Exceptions](#).

AMD Example in C#

To demonstrate the use of AMD in Ice, let us define the Slice interface for a simple computational engine:

Slice

```

module Demo {
    sequence<float> Row;
    sequence<Row> Grid;

    exception RangeError {};

    interface Model {
        ["amd"] Grid interpolate(Grid data, float factor)
            throws RangeError;
    };
};

```

Given a two-dimensional grid of floating point values and a factor, the `interpolate` operation returns a new grid of the same size with the values interpolated in some interesting (but unspecified) way.

Our servant class derives from `Demo.ModelDisp` and supplies a definition for the `interpolate_async` method that creates a `Job` to hold the callback object and arguments, and adds the `Job` to a queue. The method uses a `lock` statement to guard access to the queue:

C#

```

public class ModelI : Demo.ModelDisp_
{
    public override void interpolate_async(
        Demo.AMD_Model_interpolate cb,
        float[][] data,
        float factor,
        Ice.Current current)
    {
        lock(this)
        {
            _jobs.Add(new Job(cb, data, factor));
        }
    }

    private System.Collections.ArrayList _jobs
    = new System.Collections.ArrayList();
}

```

After queuing the information, the operation returns control to the Ice run time, making the dispatch thread available to process another request. An application thread removes the next `Job` from the queue and invokes `execute`, which uses `interpolateGrid` (not shown) to perform the computational work:

C#

```

public class Job {
    public Job(Demo.AMD_Model_interpolate cb,
float[][] grid, float factor)
    {
        _cb = cb;
        _grid = grid;
        _factor = factor;
    }

    public void execute()
    {
        if (!interpolateGrid()) {
            _cb.ice_exception(new Demo.RangeError());
            return;
        }
        _cb.ice_response(_grid);
    }

    private boolean interpolateGrid()
    {
        // ...
    }

    private Demo.AMD_Model_interpolate _cb;
    private float[][] _grid;
    private float _factor;
}

```

If `interpolateGrid` returns false, then `ice_exception` is invoked to indicate that a range error has occurred. The `return` statement following the call to `ice_exception` is necessary because `ice_exception` does not throw an exception; it only marshals the exception argument and sends it to the client.

If interpolation was successful, `ice_response` is called to send the modified grid back to the client.

See Also

- [User Exceptions](#)
- [Run-Time Exceptions](#)
- [Asynchronous Method Invocation \(AMI\) in C-Sharp](#)
- [The Ice Threading Model](#)

Example of a File System Server in C-Sharp

This page presents the source code for a C# server that implements our [file system](#) and communicates with the [client](#) we wrote earlier. The code is fully functional, apart from the required interlocking for threads.

The server is free of code that relates to distribution: most of the server code is simply application logic that would be present just the same for a non-distributed version. Again, this is one of the major advantages of Ice: distribution concerns are kept away from application code so that you can concentrate on developing application logic instead of networking infrastructure.

i The server code shown here is not quite correct as it stands: if two clients access the same file in parallel, each via a different thread, one thread may read the `_lines` data member while another thread updates it. Obviously, if that happens, we may write or return garbage or, worse, crash the server. However, it is trivial to make the `read` and `write` operations thread-safe. We discuss thread safety in [The Ice Threading Model](#).

On this page:

- [Implementing a File System Server in C#](#)
- [Server Main Program in C#](#)
- [FileI Servant Class in C#](#)
- [DirectoryI Servant Class in C#](#)
 - [DirectoryI Data Members](#)
 - [DirectoryI Constructor](#)
 - [DirectoryI Methods](#)

Implementing a File System Server in C#

We have now seen enough of the server-side C# mapping to implement a server for our [file system](#). (You may find it useful to review these [Slice definitions](#) before studying the source code.)

Our server is composed of three source files:

- `Server.cs`
This file contains the server main program.
- `DirectoryI.cs`
This file contains the implementation for the `Directory` servants.
- `FileI.cs`
This file contains the implementation for the `File` servants.

Server Main Program in C#

Our server main program, in the file `Server.cs`, uses the `Ice.Application` class. The `run` method installs a signal handler, creates an object adapter, instantiates a few servants for the directories and files in the file system, and then activates the adapter. This leads to a main program as follows:

C#

```
using Filesystem;
using System;

public class Server
{
    class App : Ice.Application
    {
        public override int run(string[] args)
```



```

{
    // Terminate cleanly on receipt of a signal
    //
    shutdownOnInterrupt();

    // Create an object adapter (stored in the _adapter
    // static members)
    //
    Ice.ObjectAdapter adapter
= communicator().createObjectAdapterWithEndpoints(
        "SimpleFilesystem", "default -p 10000");
    DirectoryI._adapter = adapter;
    FileI._adapter = adapter;

    // Create the root directory (with name "/" and no
    // parent)
    //
    DirectoryI root = new DirectoryI("/", null);

    // Create a file called "README" in the root directory
    //
    File file = new FileI("README", root);
    string[] text;
    text = new string[] {
        "This file system contains a collection of poetry."
    };
    try {
        file.write(text);
    } catch (GenericError e) {
        Console.Error.WriteLine(e.reason);
    }

    // Create a directory called "Coleridge"
    // in the root directory
    //
    DirectoryI coleridge = new DirectoryI("Coleridge", root);

    // Create a file called "Kubla_Khan"
    // in the Coleridge directory
    //
    file = new FileI("Kubla_Khan", coleridge);
    text = new string[] { "In Xanadu did Kubla Khan",
        "A stately pleasure-dome decree:",
        "Where Alph, the sacred river, ran",
        "Through caverns measureless to man",
        "Down to a sunless sea." };
    try {
        file.write(text);
    } catch (GenericError e) {
        Console.Error.WriteLine(e.reason);
    }
}

```

```
    }

    // All objects are created, allow client requests now
    //
    adapter.activate();

    // Wait until we are done
    //
    communicator().waitForShutdown();

    if (interrupted())
        Console.Error.WriteLine(appName() + ": terminating");

    return 0;
}

public static void Main(string[] args)
{
    App app = new App();
    Environment.Exit(app.main(args));
}
```

```

    }
}

```

The code uses a `using` directive for the `Filesystem` namespace. This avoids having to continuously use fully-qualified identifiers with a `Filesystem.` prefix.

The next part of the source code is the definition of the `Server` class, which includes a nested class that derives from `Ice.Application` and contains the main application logic in its `run` method. Much of this code is boiler plate that we saw previously: we create an object adapter, and, towards the end, activate the object adapter and call `waitForShutdown`.

The interesting part of the code follows the adapter creation: here, the server instantiates a few nodes for our file system to create the structure shown below:

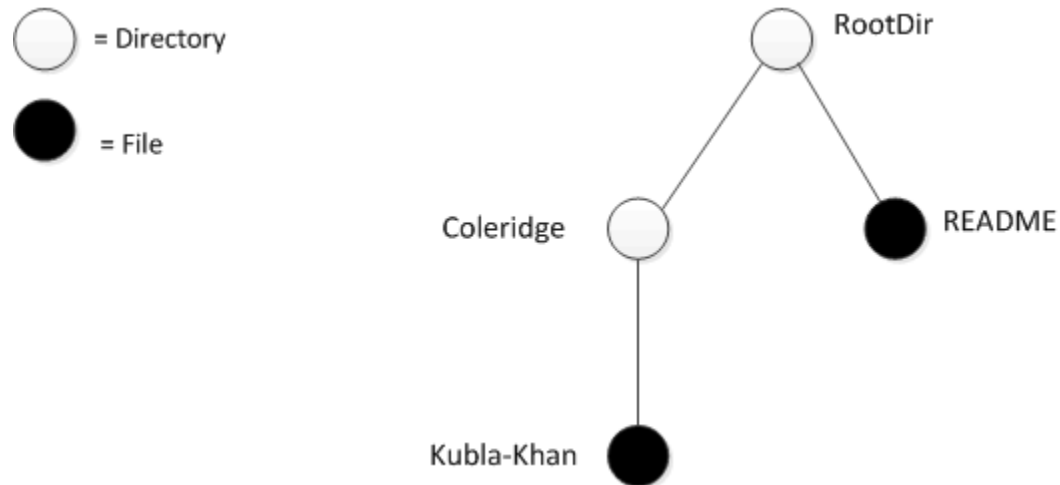

A small file system.

As we will see shortly, the servants for our directories and files are of type `DirectoryI` and `FileI`, respectively. The constructor for either type of servant accepts two parameters, the name of the directory or file to be created and a reference to the servant for the parent directory. (For the root directory, which has no parent, we pass a null parent.) Thus, the statement

```

C#
DirectoryI root = new DirectoryI("/", null);

```

creates the root directory, with the name `" / "` and no parent directory.

Here is the code that establishes the structure in the above illustration:

C#

```

// Create the root directory (with name "/" and no parent)
//
DirectoryI root = new DirectoryI("/", null);

// Create a file called "README" in the root directory
//
File file = new FileI("README", root);
string[] text;
text = new string[] {
    "This file system contains a collection of poetry."
};
try {
    file.write(text);
} catch (GenericError e) {
    Console.Error.WriteLine(e.reason);
}

// Create a directory called "Coleridge"
// in the root directory
//
DirectoryI coleridge = new DirectoryI("Coleridge", root);

// Create a file called "Kubla_Khan"
// in the Coleridge directory
//
file = new FileI("Kubla_Khan", coleridge);
text = new string[] { "In Xanadu did Kubla Khan",
    "A stately pleasure-dome decree:",
    "Where Alph, the sacred river, ran",
    "Through caverns measureless to man",
    "Down to a sunless sea." };
try {
    file.write(text);
} catch (GenericError e) {
    Console.Error.WriteLine(e.reason);
}

```

We first create the root directory and a file `README` within the root directory. (Note that we pass a reference to the root directory as the parent when we create the new node of type `FileI`.)

The next step is to fill the file with text:

C#

```

string[] text;
text = new string[] {
    "This file system contains a collection of poetry."
};
try {
    file.write(text);
} catch (GenericError e) {
    Console.Error.WriteLine(e.reason);
}

```

Recall that [Slice sequences](#) by default map to C# arrays. The Slice type `Lines` is simply an array of strings; we add a line of text to our REA DME file by initializing the `text` array to contain one element.

Finally, we call the Slice `write` operation on our `FileI` servant by writing:

C#

```
file.write(text);
```

This statement is interesting: the server code invokes an operation on one of its own servants. Because the call happens via a reference to the servant (of type `FileI`) and not via a proxy (of type `FilePrx`), the Ice run time does not know that this call is even taking place — such a direct call into a servant is not mediated by the Ice run time in any way and is dispatched as an ordinary C# method call.

In similar fashion, the remainder of the code creates a subdirectory called `Coleridge` and, within that directory, a file called `Kubla_Khan` to complete the structure in the above illustration.

FileI Servant Class in C#

Our `FileI` servant class has the following basic structure:

C#

```

using Filesystem;
using System;

public class FileI : FileDisp_
{
    // Constructor and operations here...

    public static Ice.ObjectAdapter _adapter;
    private string _name;
    private DirectoryI _parent;
    private string[] _lines;
}

```

The class has a number of data members:

- `_adapter`
This static member stores a reference to the single object adapter we use in our server.
- `_name`
This member stores the name of the file incarnated by the servant.
- `_parent`
This member stores the reference to the servant for the file's parent directory.
- `_lines`
This member holds the contents of the file.

The `_name` and `_parent` data members are initialized by the constructor:

```

C#

public FileI(string name, DirectoryI parent)
{
    _name = name;
    _parent = parent;

    Debug.Assert(_parent != null);

    // Create an identity
    //
    Ice.Identity myID = new Ice.Identity();
    myID.name = System.Guid.NewGuid().ToString();

    // Add the identity to the object adapter
    //
    _adapter.add(this, myID);

    // Create a proxy for the new node and
    // add it as a child to the parent
    //
    NodePrx thisNode = NodePrxHelper.uncheckedCast(_adapter.createP
roxy(myID));
    _parent.addChild(thisNode);
}

```

After initializing the `_name` and `_parent` members, the code verifies that the reference to the parent is not null because every file must have a parent directory. The constructor then generates an identity for the file by calling `NewGuid` and adds itself to the servant map by calling `ObjectAdapter.add`. Finally, the constructor creates a proxy for this file and calls the `addChild` method on its parent directory. `addChild` is a helper function that a child directory or file calls to add itself to the list of descendant nodes of its parent directory. We will see the implementation of this function in [DirectoryI Methods](#).

The remaining methods of the `FileI` class implement the Slice operations we defined in the `Node` and `File` Slice interfaces:

C#

```

// Slice Node::name() operation

public override string name(Ice.Current current)
{
    return _name;
}

// Slice File::read() operation

public override string[] read(Ice.Current current)
{
    return _lines;
}

// Slice File::write() operation

public override void write(string[] text, Ice.Current current)
{
    _lines = text;
}

```

The `name` method is inherited from the generated `Node` interface (which is a base interface of the `_FileDisp` class from which `FileI` is derived). It simply returns the value of the `_name` member.

The `read` and `write` methods are inherited from the generated `File` interface (which is a base interface of the `_FileDisp` class from which `FileI` is derived) and simply return and set the `_lines` member.

DirectoryI Servant Class in C#

The `DirectoryI` class has the following basic structure:

C#

```

using Filesystem;
using System;
using System.Collections;

public class DirectoryI : DirectoryDisp_
{
    // Constructor and operations here...

    public static Ice.ObjectAdapter _adapter;
    private string _name;
    private DirectoryI _parent;
    private ArrayList _contents = new ArrayList();
}

```

DirectoryI Data Members

As for the `FileI` class, we have data members to store the object adapter, the name, and the parent directory. (For the root directory, the `_parent` member holds a null reference.) In addition, we have a `_contents` data member that stores the list of child directories. These data members are initialized by the constructor:

```

C#

public DirectoryI(string name, DirectoryI parent)
{
    _name = name;
    _parent = parent;

    // Create an identity. The
    // parent has the fixed identity "RootDir"
    //
    Ice.Identity myID = new Ice.Identity();
    myID.name = _parent != null ? System.Guid.NewGuid().ToString()
: "RootDir";

    // Add the identity to the object adapter
    //
    _adapter.add(this, myID);

    // Create a proxy for the new node and
    // add it as a child to the parent
    //
    NodePrx thisNode = NodePrxHelper.uncheckedCast(_adapter.createP
roxy(myID));
    if (_parent != null)
        _parent.addChild(thisNode);
}

```

DirectoryI Constructor

The constructor creates an identity for the new directory by calling `NewGuid`. (For the root directory, we use the fixed identity "RootDir".) The servant adds itself to the servant map by calling `ObjectAdapter.add` and then creates a proxy to itself and passes it to the `addChild` helper function.

DirectoryI Methods

`addChild` simply adds the passed reference to the `_contents` list:

```

C#

public void addChild(NodePrx child)
{
    _contents.Add(child);
}

```

The remainder of the operations, `name` and `list`, are trivial:

```

C#



```
public override string name(Ice.Current current)
{
 return _name;
}

public override NodePrx[] list(Ice.Current current)
{
 return (NodePrx[])_contents.ToArray(typeof(NodePrx));
}
```

```

Note that the `_contents` member is of type `System.Collections.ArrayList`, which is convenient for the implementation of the `addChild` method. However, this requires us to convert the list into a C# array in order to return it from the `list` operation.

See Also

- [Slice for a Simple File System](#)
- [Example of a File System Client in C-Sharp](#)
- [The Server-Side main Method in C-Sharp](#)
- [C-Sharp Mapping for Sequences](#)
- [The Ice Threading Model](#)

Silverlight and .NET Compact Framework Support

Ice for .NET includes support for Silverlight and the .NET Compact Framework (.NET CF).

On this page:

- [Using Ice for Silverlight and .NET CF](#)
- [Limitations of Ice for Silverlight and .NET CF](#)
- [Managing Factory Assemblies](#)

Using Ice for Silverlight and .NET CF

These versions of Ice differ from Ice for .NET in several ways, therefore you must re-compile Ice to target Silverlight or .NET CF. The [Ice installer for Windows](#) includes the Silverlight and .NET CF versions of the Ice run time in `install-dir\bin\sl\Ice.dll` and `install-dir\bin\cf\Ice.dll`, respectively. The [Ice Visual Studio Add-in](#) automatically selects the appropriate DLL for your project. To build Ice for .NET CF in a source distribution, enable `COMPACT` in `cs\config\Make.rules.mak.cs`; to build Ice for Silverlight, enable `SILVERLIGHT` in the same file.

Limitations of Ice for Silverlight and .NET CF

This table lists the Ice for .NET features that may not be available when using Silverlight or .NET CF:

Feature	Silverlight	.NET CF
Protocol compression	No	No
Serializable objects	No	No
IceSSL transport plug-in	No	No
ICE_CONFIG environment variable	No	No
Ice.Application class	No	Yes (without signal support)
Glacier2.Application class	No	Yes
Thread priorities	No	Yes
Server-side support	No	Yes
Bi-directional callbacks	Yes	Yes
Loading properties from Windows registry	No	Yes
Ice.StdOut and Ice.StdErr properties	No	Yes
Ice.PrintProcessId property	No	Yes
Ice.LogFile property	No	Yes
Ice.TCP.SndSize and Ice.TCP.RcvSize properties	Yes	No
Multi-homed DNS addresses	No	Yes
Dynamic loading of class and exception factories	No	No

With respect to multi-homed DNS addresses, the Silverlight API never returns more than one IP address when performing a DNS lookup, even for a multi-homed host name that is associated with multiple IP addresses. As a result, the Ice for Silverlight run time cannot attempt to transparently establish a connection to all of the IP addresses associated with a multi-homed host name.

Managing Factory Assemblies

When receiving a Slice user exception or a concrete Slice object-by-value, the Ice run time must be able to dynamically translate the encoded Slice type ID (such as `::MyModule::MyType`) into a .NET class name (such as `MyModule.MyType`), dynamically locate that class, and instantiate it. This is convenient for .NET applications because it requires no additional user configuration; at startup, the Ice for .NET run time recursively loads all dependent assemblies used by the program to ensure that any generated classes are available if necessary.

Neither Silverlight nor the Compact Framework allow a program to discover its dependent assemblies, so this strategy cannot work. Consequently, Ice adds the new configuration property `Ice.FactoryAssemblies` so that you can explicitly list any assemblies that contain the generated code for user exceptions or concrete classes. When searching for a class, Ice first checks in the assemblies specified by this property. If the type is not found, Ice automatically looks in the standard Ice assemblies (`Ice`, `Glacier2`, `IceBox`, `IceGrid`, `IcePatch2`, and `IceStorm`).

Note that the program itself is also considered an assembly. If you compiled the main program directly with Slice-generated code, your `Ice.FactoryAssemblies` property must include the program itself if the generated code includes user exceptions or concrete classes. For simple build scenarios in which all generated code is compiled directly into the executable, the following configuration setting is sufficient:

```
Ice.FactoryAssemblies=client
```

This example assumes the executable is named `client.exe`. On the other hand, if Slice-generated code is also compiled into a dependent assembly, your configuration might look like this instead:

```
Ice.FactoryAssemblies=client MyOtherAssembly
```

Failing to define `Ice.FactoryAssemblies` can cause the Ice run time in the receiver to raise `NoObjectFactoryException`, `UnmarshalingOutOfBoundsException` or `UnknownUserException`. If you are experiencing any of these exceptions, verify that your assemblies are configured correctly.

See Also

- [Visual Studio Add-in](#)
- [Ice.FactoryAssemblies](#)

The .NET Utility Library

Ice for .Net includes a number of utility APIs in the `Ice.Util` class. This appendix summarizes the contents of these APIs for your reference.

On this page:

- [Communicator Initialization Methods](#)
- [Identity Conversion](#)
- [Per-Process Logger Methods](#)
- [Property Creation Methods](#)
- [Proxy Comparison Methods](#)
- [Stream Creation](#)
- [Version Information](#)

Communicator Initialization Methods

`Ice.Util` provides a number of overloaded `initialize` methods that create a communicator.

Identity Conversion

`Ice.Util` contains two methods to convert object identities of type `Ice.Identity` to and from strings.

Per-Process Logger Methods

`Ice.Util` provides methods for getting and setting the per-process logger.

Property Creation Methods

`Ice.Util` provides a number of overloaded `createProperties` methods that create property sets.

Proxy Comparison Methods

Two methods, `proxyIdentityCompare` and `proxyIdentityAndFacetCompare`, allow you to compare object identities that are stored in proxies (either ignoring the facet or taking the facet into account).

Stream Creation

The methods `createInputStream`, `wrapInputStream` and `createOutputStream` create streams for use with dynamic invocation.

Version Information

The `stringVersion` and `intVersion` methods return the version of the Ice run time:

```

C#
public static string stringVersion();
public static int intVersion();

```

The `stringVersion` method returns the Ice version in the form `<major>.<minor>.<patch>`, for example, `3.4.2`. For beta releases, the version is `<major>.<minor>b`, for example, `3.4b`.

The `intVersion` method returns the Ice version in the form `AABBC`, where `AA` is the major version number, `BB` is the minor version

number, and *CC* is patch level, for example, 30402 for version 3.4.2. For beta releases, the patch level is set to 51 so, for example, for version 3.4b, the value is 30451.

See Also

- [Command-Line Parsing and Initialization](#)
- [Setting Properties](#)
- [C-Sharp Streaming Interfaces](#)
- [Object Identity](#)

Silverlight Security Policies

Overview of Silverlight Security Policies

As a security measure, the Silverlight run time [validates all outgoing socket connections](#) against an XML policy file supplied by the host from which the Silverlight client is downloaded. The download host must either run a standalone policy server or use a web server as a policy server. Ice for Silverlight includes a basic implementation of a [policy server](#) that you can use to deploy with your own applications.

If you do not want to use a standalone policy server, you can also use the web server on the download host as a policy server by adding a `clientaccesspolicy.xml` file at the document root directory. You must also set `Ice.ClientAccessPolicyProtocol` to `Http` for this deployment to work correctly.

Silverlight limits the range of ports to which a client can connect. As a result, you must configure your Ice server to listen on a TCP port within the range 4502 to 4534. The policy file can limit this range to an even smaller number of ports if necessary, and provides additional flexibility in controlling the client's access to server-side resources. For example, the following configuration grants the client access to ports in the range 4502 to 4506:

```
<?xml version="1.0" encoding="utf-8"?>
<access-policy>
  <cross-domain-access>
    <policy>
      <allow-from>
        <domain uri="*" />
      </allow-from>
      <grant-to>
        <socket-resource port="4502-4506" protocol="tcp" />
      </grant-to>
    </policy>
  </cross-domain-access>
</access-policy>
```

[Out of browser](#) applications (OOB) are not subject to these limitations: you do not need to use a policy server for OOB applications and you can use ports outside the 4502-4534 port range.

Silverlight Policy Server

For your convenience, the [Ice installer for Windows](#) includes two versions of a Silverlight policy server: one for .NET in the `bin` subdirectory, and another for .NET Compact Framework in the `bin\cf` subdirectory. A copy of the policy file shown earlier is provided in `config\PolicyResponse.xml`. In a source distribution, you can find the code for the policy server in `cs\src\PolicyServer`.

The policy server accepts two command-line arguments:

```
polycyserver <ip-address> <policy-file>
```

The `ip-address` argument selects the interface on which to listen, and `policy-file` indicates the Silverlight policy file to be returned for every request. The server always listens on port 943, which is the standard port used by the Silverlight run time.

See Also

- [Network Security Access Restrictions in Silverlight](#)

- [Out of Browser Applications](#)

Objective-C Mapping

Topics

- [Client-Side Slice-to-Objective-C Mapping](#)
- [Server-Side Slice-to-Objective-C Mapping](#)

Client-Side Slice-to-Objective-C Mapping

The client-side Slice-to-Objective-C mapping defines how Slice data types are translated to Objective-C types, and how clients invoke operations, pass parameters, and handle errors. Much of the Objective-C mapping is intuitive. For example, Slice dictionaries map to Cocoa framework dictionaries, so there is little new you have to learn in order to use Slice dictionaries in Objective-C.

The Objective-C mapping is thread-safe. For example, you can concurrently invoke operations on an object from different threads without the risk of race conditions or corrupting data structures in the Ice run time, but you must still synchronize access to application data from different threads. For example, if you have two threads sharing a sequence, you cannot safely have one thread insert into the sequence while another thread is iterating over the sequence. However, you only need to concern yourself with concurrent access to your own data — the Ice run time itself is fully thread safe, and none of the Ice API calls require you to acquire or release a lock before you safely can make the call.

Much of what appears in this chapter is reference material. We suggest that you skim the material on the initial reading and refer back to specific sections as needed. However, we recommend that you read at least the mappings for [exceptions](#), [interfaces](#), and [operations](#) in detail because these sections cover how to call operations from a client, pass parameters, and handle exceptions.



In order to use the Objective-C mapping, you should need no more than the Slice definition of your application and knowledge of the Objective-C mapping rules. In particular, looking through the generated code in order to discern how to use the Objective-C mapping is likely to be confusing because the generated code is not necessarily meant for human consumption and, occasionally, contains various cryptic constructs to deal with mapping internals. Of course, occasionally, you may want to refer to the generated code to confirm a detail of the mapping, but we recommend that you otherwise use the material presented here to see how to write your client-side code.



ICE, ICEMX, GLACIER2, ICESTORM, ICEGRID Prefixes

All of the APIs for the Ice run time are prefixed by `ICE`, to avoid clashes with definitions for other libraries or applications. Parts of the Ice API are generated from Slice definitions; other parts provide special-purpose definitions that do not have a corresponding Slice definition. Regardless of the way they are defined, the `ICE` prefix universally applies to all entry points in the Ice run time. We will incrementally cover the contents of the Ice API throughout the remainder of the manual.

The APIs for IceMX, Glacier2, IceStorm and IceGrid are also prefixed with respectively ICEMX, GLACIER2, ICESTORM and ICEGRID.

Topics

- [Objective-C Mapping for Modules](#)
- [Objective-C Mapping for Identifiers](#)
- [Objective-C Mapping for Built-In Types](#)
- [Objective-C Mapping for Enumerations](#)
- [Objective-C Mapping for Structures](#)
- [Objective-C Mapping for Sequences](#)
- [Objective-C Mapping for Dictionaries](#)
- [Objective-C Mapping for Constants](#)
- [Objective-C Mapping for Exceptions](#)
- [Objective-C Mapping for Interfaces](#)
- [Objective-C Mapping for Operations](#)
- [Objective-C Mapping for Local Interfaces](#)
- [Objective-C Mapping for Classes](#)
- [Objective-C Mapping for Interfaces by Value](#)
- [Objective-C Mapping for Optional Data Members](#)
- [Asynchronous Method Invocation \(AMI\) in Objective-C](#)
- [slice2objc Command-Line Options](#)
- [Example of a File System Client in Objective-C](#)

Objective-C Mapping for Modules

Because Objective-C does not support namespaces, a Slice module maps to a prefix for the identifiers defined inside the modules. By default, the prefix is the same as the name of the module:

Slice
<pre>module example { enum Color { Red, Green, Blue }; };</pre>

With this definition, the Slice identifier `Color` maps to the Objective-C identifier `exampleColor`.

For nested modules, by default, the module identifiers are concatenated. For example, consider the following Slice definition:

Slice
<pre>module outer { module inner { enum Color { Red, Green, Blue }; }; };</pre>

With this definition, the Slice identifier `Color` becomes `outerinnerColor` in Objective-C.

You can use a metadata directive to change the default mapping to a different prefix. For example:

Slice
<pre>["objc:prefix:OUT"] module outer { enum Vehicle { Car, Truck, Bicycle }; module inner { enum Color { Red, Green, Blue }; }; };</pre>

With this definition, `Vehicle` maps to `OUTVehicle`. However, `Color` still maps to `outerinnerColor`, that is, the metadata directive applies only to types defined in the `outer` module, but not to types that are defined in nested modules. If you want to assign a prefix for types in the nested module, you must use a separate metadata directive, for example:

Slice

```
["objc:prefix:OUT"]
module outer {
    enum Vehicle { Car, Truck, Bicycle };

    ["objc:prefix:IN"]
    module inner {
        enum Color { Red, Green, Blue };
    };
};
```

With this definition, `Vehicle` maps to `OUTVehicle`, and `Color` maps to `INColor`.

For the remainder of the examples in this chapter, we assume that Slice definitions are enclosed by a module `Example` that is annotated with the metadata directive `["objc:prefix:EX"]`.

See Also

- [Objective-C Mapping for Identifiers](#)
- [Objective-C Mapping for Built-In Types](#)
- [Objective-C Mapping for Enumerations](#)
- [Objective-C Mapping for Structures](#)
- [Objective-C Mapping for Sequences](#)
- [Objective-C Mapping for Dictionaries](#)
- [Objective-C Mapping for Constants](#)
- [Objective-C Mapping for Exceptions](#)
- [Objective-C Mapping for Interfaces](#)

Objective-C Mapping for Identifiers

Objective-C identifiers are derived from Slice identifiers. The exact Objective-C identifier that is generated depends on the context. For types that are nested in modules (and hence have global visibility in Objective-C), the generated Objective-C identifiers are prefixed with their `module prefix`. Slice identifiers that do not have global visibility (such as operation names and structure members) do not use the module prefix and are preserved without change. For example, consider the following Slice definition:

```

Slice
["objc:prefix:EX"]
module Example {
    struct Point {
        double x;
        double y;
    };
};

```

This maps to the following Objective-C definition:

```

Objective-C
@interface EXPoint : NSObject <NSCopying>
{
    @private
        ICEDouble x;
        ICEDouble y;
}

@property(nonatomic, assign) ICEDouble x;
@property(nonatomic, assign) ICEDouble y;

// More definitions here...
@end

```

If a Slice identifier is the same as an Objective-C keyword, the corresponding Objective-C identifier has an underscore suffix. For example, Slice `while` maps to Objective-C `while_`.

In some cases, the Objective-C mapping generates more than one identifier for a given Slice construct. For example, an interface `Intf` generates the identifiers `EXIntf` and `EXIntfPrx`. If a Slice identifier happens to be an Objective-C keyword, the underscore suffix applies only where necessary, so an interface `while` generates `EXWhile` and `EXWhilePrx`.

Note that Slice operation and member names can clash with the name of an inherited method, property, or instance variable. For example:

```

Slice
exception Failed {
    string reason; // Clashes with NSException
};

```

This is a legal Slice definition. However, the generated exception class derives from `NSException`, which defines a `reason` method. To

avoid hiding the method in the base class, the generated exception class maps the Slice `reason` member to the Objective-C property `reason_`, just as it would for a keyword.

This escape mechanism applies to all generated classes that directly or indirectly derive from `NSObject` or `NSException`.

Internal Identifiers in Objective-C

Any methods that contain two or more adjacent underscores (such as `read__` and `op_____`) are internal to the Objective-C mapping implementation and are not for use by application code.

See Also

- [Objective-C Mapping for Modules](#)
- [Objective-C Mapping for Built-In Types](#)
- [Objective-C Mapping for Enumerations](#)
- [Objective-C Mapping for Structures](#)
- [Objective-C Mapping for Sequences](#)
- [Objective-C Mapping for Dictionaries](#)
- [Objective-C Mapping for Constants](#)
- [Objective-C Mapping for Exceptions](#)
- [Objective-C Mapping for Interfaces](#)

Objective-C Mapping for Built-In Types

The Slice built-in types are mapped to Objective-C types as shown below.

Slice	Objective-C
<code>bool</code>	<code>BOOL</code>
<code>byte</code>	<code>ICEByte</code>
<code>short</code>	<code>ICEShort</code>
<code>int</code>	<code>ICEInt</code>
<code>long</code>	<code>ICELong</code>
<code>float</code>	<code>ICEFloat</code>
<code>double</code>	<code>ICEDouble</code>
<code>string</code>	<code>NSString</code> or <code>NSMutableString</code>

Slice `bool` maps to Objective-C `BOOL`. The remaining integral and floating-point types map to Objective-C type definitions instead of native types. This allows the Ice run time to provide a definition as appropriate for each target architecture. (For example, `ICELong` might be defined as `long` on one architecture and as `long long` on another.)

Note that `ICEByte` is a typedef for `unsigned char`. This guarantees that byte values are always in the range 0..255, and it ensures that right-shifting an `ICEByte` does not cause sign-extension.

Whether a Slice string maps to `NSString` or `NSMutableString` depends on the context. `NSMutableString` is used in some cases for operation parameters; otherwise, if a string is a data member of a Slice structure, class, or exception, it maps to `NSString`. (We will discuss these differences in more detail as we cover the mapping of the relevant Slice language features.)

See Also

- [Objective-C Mapping for Modules](#)
- [Objective-C Mapping for Identifiers](#)
- [Objective-C Mapping for Enumerations](#)
- [Objective-C Mapping for Structures](#)
- [Objective-C Mapping for Sequences](#)
- [Objective-C Mapping for Dictionaries](#)
- [Objective-C Mapping for Constants](#)
- [Objective-C Mapping for Exceptions](#)
- [Objective-C Mapping for Interfaces](#)

Objective-C Mapping for Enumerations

A Slice [enumeration](#) maps to the corresponding enumeration in Objective-C. For example:

```

Slice



```
["objc:prefix:EX"]
module Example {
 enum Fruit { Apple, Pear, Orange };
};
```

```

The generated Objective-C definition is:

```

Objective-C



```
typedef enum {
 EXApple, EXPear, EXOrange
} EXFruit;
```

```

See Also

- [Objective-C Mapping for Modules](#)
- [Objective-C Mapping for Identifiers](#)
- [Objective-C Mapping for Built-In Types](#)
- [Objective-C Mapping for Structures](#)
- [Objective-C Mapping for Sequences](#)
- [Objective-C Mapping for Dictionaries](#)
- [Objective-C Mapping for Constants](#)
- [Objective-C Mapping for Exceptions](#)
- [Objective-C Mapping for Interfaces](#)

Objective-C Mapping for Structures

On this page:

- [Basic Objective-C Mapping for Structures](#)
- [Mapping for Data Members in Objective-C](#)
- [Creating and Initializing Structures in Objective-C](#)
- [Copying Structures in Objective-C](#)
- [Deallocating Structures in Objective-C](#)
- [Structure Comparison and Hashing in Objective-C](#)

Basic Objective-C Mapping for Structures

A Slice `structure` maps to an Objective-C class.

For each Slice data member, the generated Objective-C class has a corresponding property. For example, here is our `Employee` structure once more:

Slice
<pre>struct Employee { long number; string firstName; string lastName; };</pre>

The Slice-to-Objective-C compiler generates the following definition for this structure:

Objective-C
<pre>@interface EXEmployee : NSObject <NSCopying> { @private ICELong number; NSString *firstName; NSString *lastName; } @property(nonatomic, assign) ICELong number; @property(nonatomic, retain) NSString *firstName; @property(nonatomic, retain) NSString *lastName; -(id) init:(ICELong)number firstName:(NSString *)firstName lastName:(NSString *)lastName; +(id) employee:(ICELong)number firstName:(NSString *)firstName lastName:(NSString *)lastName; +(id) employee; // This class also overrides copyWithZone, // hash, isEqual, and dealloc. @end</pre>

Mapping for Data Members in Objective-C

For each data member in the Slice definition, the Objective-C class contains a corresponding private instance variable of the same name, as well as a property definition that allows you to set and get the value of the corresponding instance variable. For example, given an instance of `EXEmployee`, you can write the following:

```

Objective-C

ICELong number;
EXEmployee *e = ...;
[e setNumber:99];
number = [e number];

// Or, more concisely with dot notation:

e.number = 99;
number = e.number;
```

Properties that represent data members always use the `nonatomic` property attribute. This avoids the overhead of locking each data member during access. The second property attribute is `assign` for integral and floating-point types and `retain` for all other types (such as strings, structures, and so on.)

Note that, for types that have immutable and mutable variants (strings, sequences, and dictionaries), the corresponding data member uses the immutable variant. This allows the application to assign an immutable object to the data member. You can safely cast the data member to the mutable variant if the structure was created by the Ice run time: the unmarshaling code always creates and assigns the mutable version to the data member.

Creating and Initializing Structures in Objective-C

Structures provide the typical (inherited) `init` method:

```

Objective-C

EXEmployee *e = [[EXEmployee alloc] init];
// ...
[e release];
```

As usual, `init` initializes the instance variables of the structure with zero-filled memory. You can also declare default values in your `Slice definition`, in which case this `init` method initializes each data member with its declared value.

In addition, a structure provides a second `init` method that accepts one parameter for each data member of the structure:

```

Objective-C

-(id) init:(ICELong)number firstName:(NSString *)firstName
        lastName:(NSString *)lastName;
```

Note that the first parameter is always unlabeled; the second and subsequent parameters have a label that is the same as the name of the corresponding Slice data member. The additional `init` method allows you to instantiate a structure and initialize its data members in a single statement:

Objective-C

```
EXEmployee *e = [[EXEmployee alloc] init:99 firstName:@"Brad"
lastName:@"Cox"];
// ...
[e release];
```

`init` applies the memory management policy of the corresponding properties, that is, it calls `retain` on the `firstName` and `lastName` arguments.

Each structure also provides two convenience constructors that mirror the `init` methods: a parameter-less convenience constructor and one that has a parameter for each Slice data member:

Objective-C

```
+(id) employee;
+(id) employee:(ICELong)number firstName:(NSString *)firstName
lastName:(NSString *)lastName;
```

The convenience constructors have the same name as the mapped Slice structure (without the module prefix). As usual, they allocate an instance, perform the same initialization actions as the corresponding `init` methods, and call `autorelease` on the return value:

Objective-C

```
EXEmployee *e = [EXEmployee employee:99 firstName:@"Brad"
lastName:@"Cox"];

// No need to call [e release] here.
```

Copying Structures in Objective-C

Structures implement the `NSCopying` protocol. Structures are copied by assigning instance variables of value type and calling `retain` on each instance variable of non-value type. In other words, the copy is shallow:

Objective-C

```
EXEmployee *e = [EXEmployee employee:99 firstName:@"Brad"
lastName:@"Cox"];
EXEmployee *e2 = [e copy];
NSAssert(e.number == e2.number);
NSAssert([e.firstName == e2.firstName]); // Same instance
// ...
[e2 release];
```

Note that, if you assign an `NSMutableString` to a structure member and use the structure as a dictionary key, you must not modify the string inside the structure without copying it because doing so will corrupt the dictionary.

Deallocating Structures in Objective-C

Each structure implements a `dealloc` method that calls `release` on each instance variable with a `retain` property attribute. This means that structures take care of the memory management of their contents: releasing a structure automatically releases all its instance variables.

Structure Comparison and Hashing in Objective-C

Structures implement `isEqual`, so you can compare them for equality. Two structures are equal if all their instance variables are equal. For value types, equality is determined by the `==` operator; for non-value types other than classes, equality is determined by the corresponding instance variable's `isEqual` method. [Classes](#) are compared by comparing their identity: two class members are equal if they both point at the same instance.

The `hash` method returns a hash value is that is computed from the hash value of all of the structure's instance variables.

See Also

- [Structures](#)
- [Dictionaries](#)
- [Objective-C Mapping for Modules](#)
- [Objective-C Mapping for Identifiers](#)
- [Objective-C Mapping for Built-In Types](#)
- [Objective-C Mapping for Enumerations](#)
- [Objective-C Mapping for Sequences](#)
- [Objective-C Mapping for Dictionaries](#)
- [Objective-C Mapping for Constants](#)
- [Objective-C Mapping for Exceptions](#)
- [Objective-C Mapping for Interfaces](#)
- [Objective-C Mapping for Classes](#)

Objective-C Mapping for Sequences

The Objective-C mapping uses different mappings for [sequences](#) of value types (such as `sequence<byte>`) and non-value types (such as `sequence<string>`).

On this page:

- [Mapping for Sequences of Value Types in Objective-C](#)
- [Mapping of Sequences of Non-Value Types in Objective-C](#)

Mapping for Sequences of Value Types in Objective-C

The following Slice types are value types:

- Integral types (`bool`, `byte`, `short`, `int`, `long`)
- Floating point types (`float`, `double`)
- Enumerated types

Sequences of these types map to a type definition. For example:

Slice
<pre>enum Fruit { Apple, Pear, Orange }; sequence<byte> ByteSeq; sequence<int> IntSeq; sequence<Fruit> FruitSeq;</pre>

The three Slice sequences produce the following Objective-C definitions:

Objective-C
<pre>typedef enum { EXApple, EXPear, EXOrange } EXFruit; typedef NSData EXByteSeq; typedef NSMutableData EXMutableByteSeq; typedef NSData EXIntSeq; typedef NSMutableData EXMutableIntSeq; typedef NSData EXFruitSeq; typedef NSMutableData EXMutableFruitSeq;</pre>

As you can see, each sequence definition creates a pair of type definitions, an immutable version named `<module-prefix><Slice-name>`, and a mutable version named `<module-prefix>Mutable<Slice-name>`. This constitutes the entire public API for sequences of value types, that is, sequences of value types simply map to `NSData` or `NSMutableData`. The `NS(Mutable)Data` sequences contain an array of the corresponding element type in their internal byte array.



We chose to map sequences of value types to `NSData` instead of `NSArray` because of the large overhead of placing each sequence element into an `NSNumber` container instance.

For example, here is how you could initialize a byte sequence of 1024 elements with values that are the modulo 128 of the element index in reverse order:

Objective-C

```
int limit = 1024;
NSMutableByteSeq *bs = [NSMutableData dataWithLength:limit];
ICEByte *p = (ICEByte *)[bs bytes];
while (--limit > 0) {
    *p++ = limit % 0x80;
}
```

Naturally, you do not need to initialize the sequence using a loop. For example, if the data is available in a buffer, you could use the `dataWithBytes:length` or `dataWithBytesNoCopy:length` methods of `NSData` instead.

Here is one way to retrieve the bytes of the sequence:

Objective-C

```
const ICEByte* p = (const ICEByte *)[bs bytes];
const ICEByte* limitp = p + [bs length];
while (p < limitp) {
    printf("%d\n", *p++);
}
```

For sequences of types other than `byte` or `bool`, you must keep in mind that the length of the `NSData` array is not the same as the number of elements. The following example initializes an integer sequence with the first few primes and prints out the contents of the sequence:

Objective-C

```
const int primes[] = { 1, 2, 3, 5, 7, 11, 13, 17, 19, 23 };
NSMutableIntSeq *is = [NSMutableData dataWithBytes:primes
length:sizeof(primes)];

const ICEInt *p = (const ICEInt *)[is bytes];
int limit = [is length] / sizeof(*p);
int i;
for(i = 0; i < limit; ++i) {
    printf("%d\n", p[i]);
}
```

The code to manipulate a sequence of enumerators is very similar. For portability, you should not assume a particular size for enumerators. That is, instead of relying on all enumerators having the size of, for example, an `int`, it is better to use `sizeof(EXFruit)` to ensure that you are not overstepping the bounds of the sequence.

Mapping of Sequences of Non-Value Types in Objective-C

Sequences of non-value types, such as sequences of `string`, structures, classes, and so on, map to mutable and immutable type definitions of `NSArray`. For example:

Slice

```
sequence<string> Page;
sequence<Page> Book;
```

This maps to:

Objective-C

```
typedef NSArray EXPage;
typedef NSMutableArray EXMutablePage;

typedef NSArray EXBook;
typedef NSMutableArray EXMutableBook;
```

You use such sequences as you would use any other `NSArray` in your code. For example:

Objective-C

```
EXMutablePage *page1 = [NSArray arrayWithObjects:
    @"First line of page one",
    @"Second line of page one",
    nil];

EXMutablePage *page2 = [NSArray arrayWithObjects:
    @"First line of page two",
    @"Second line of page two",
    nil];

EXMutableBook *book = [NSMutableArray array];
[book addObject:page1];
[book addObject:page2];
[book addObject:[NSArray array]]; // Empty page
```

This creates a book with three pages; the first two pages contain two lines each, and the third page is empty. You can print the contents of the book as follows:

Objective-C

```

int pageNum = 0;
for (EXPage *page in book) {
    ++pageNum;
    int lineNumber = 0;
    if ([page count] == 0) {
        printf("page %d: <empty>\n", pageNum);
    } else {
        for (NSString *line in page) {
            ++lineNum;
            printf("page %d, line %d: %s\n",
                pageNum, lineNumber, [line UTF8String]);
        }
    }
}

```

This prints:

```

page 1, line 1: First line of page one
page 1, line 2: Second line of page one
page 2, line 1: First line of page two
page 2, line 2: Second line of page two
page 3: <empty>

```

If you have a sequence of proxies or a sequence of classes, to transmit a null proxy or class inside a sequence, you must insert an `NSNull` value into the `NSArray`. In addition, the mapping also allows you to use `NSNull` as the element value of an `NSArray` for elements of type string, structure, sequence, or dictionary. For example, instead of inserting an empty `NSArray` into the book sequence in the preceding example, we could also have inserted `NSNull`:

Objective-C

```

EXMutableBook *book = [NSMutableArray array];
[book addObject:page1];
[book addObject:page2];
[book addObject:[NSNull null]]; // Empty page

```

See Also

- [Objective-C Mapping for Modules](#)
- [Objective-C Mapping for Identifiers](#)
- [Objective-C Mapping for Built-In Types](#)
- [Objective-C Mapping for Enumerations](#)
- [Objective-C Mapping for Structures](#)
- [Objective-C Mapping for Dictionaries](#)
- [Objective-C Mapping for Constants](#)
- [Objective-C Mapping for Exceptions](#)
- [Objective-C Mapping for Interfaces](#)

Objective-C Mapping for Dictionaries

Here is the definition of our `EmployeeMap` once more:

Slice
<code>dictionary<long, Employee> EmployeeMap;</code>

The following code is generated for this definition:

Objective-C
<code>typedef NSDictionary EXEmployeeMap; typedef NSMutableDictionary EXMutableEmployeeMap;</code>

Similar to [sequences](#), Slice dictionaries map to type definitions for `NSDictionary` and `NSMutableDictionary`, with the names `<module-prefix><Slice-name>` and `<module-prefix>Mutable<Slice-name>`.

As a result, you can use the dictionary like any other `NSDictionary`, for example:

Objective-C
<code>EXMutableEmployeeMap *em = [EXMutableEmployeeMap dictionary]; EXEmployee *e = [EXEmployee employee]; e.number = 42; e.firstName = @"Stan"; e.lastName = @"Lippman"; [em setObject:e forKey:[NSNumber numberWithInt:e.number]];</code>
<code>e = [EXEmployee employee]; e.number = 77; e.firstName = @"Herb"; e.lastName = @"Sutter"; [em setObject:e forKey:[NSNumber numberWithInt:e.number]];</code>

To put a value type into a dictionary (either as the key or the value), you must use `NSNumber` as the object to hold the value. If you have a dictionary that uses a Slice enumeration as the key or the value, you must insert the enumerator as an `NSNumber` that holds an `int`.

To insert a null proxy or null class instance into a dictionary as a value, you must insert `NSNull`.

As a convenience feature, the Objective-C mapping also allows you to insert `NSNull` as the value of a dictionary if the value type of the dictionary is a string, structure, sequence, or dictionary. If you send such a dictionary to a receiver, the Ice run time marshals an empty string, default-initialized structure, empty sequence, or empty dictionary as the corresponding value to the receiver, respectively.

See Also

- [Dictionaries](#)
- [Objective-C Mapping for Modules](#)
- [Objective-C Mapping for Identifiers](#)
- [Objective-C Mapping for Built-In Types](#)
- [Objective-C Mapping for Enumerations](#)
- [Objective-C Mapping for Structures](#)

- [Objective-C Mapping for Sequences](#)
- [Objective-C Mapping for Constants](#)
- [Objective-C Mapping for Exceptions](#)
- [Objective-C Mapping for Interfaces](#)

Objective-C Mapping for Constants

Slice `constant` definitions map to corresponding Objective-C constant definitions. For example:

Slice	
<code>const bool</code>	<code>AppendByDefault = true;</code>
<code>const byte</code>	<code>LowerNibble = 0x0f;</code>
<code>const string</code>	<code>Advice = "Don't Panic!";</code>
<code>const short</code>	<code>TheAnswer = 42;</code>
<code>const double</code>	<code>PI = 3.1416;</code>
<code>enum Fruit { Apple, Pear, Orange };</code>	
<code>const Fruit</code>	<code>FavoriteFruit = Pear;</code>

Here are the generated definitions for these constants:

Objective-C	
<code>static const BOOL</code>	<code>EXAppendByDefault = YES;</code>
<code>static const ICEByte</code>	<code>EXLowerNibble = 15;</code>
<code>static NSString * const</code>	<code>EXAdvice = @"Don't Panic!";</code>
<code>static const ICEShort</code>	<code>EXTheAnswer = 42;</code>
<code>static const ICEDouble</code>	<code>EXPI = 3.1416;</code>
<code>typedef enum {</code>	<code>EXApple, EXPear, EXOrange</code>
<code>} EXFruit;</code>	
<code>static const EXFruit</code>	<code>EXFavoriteFruit = EXPear;</code>

All constants are initialized directly in the generated header file, so they are compile-time constants and can be used in contexts where a compile-time constant expression is required, such as to dimension an array or as the `case` label of a `switch` statement.

See Also

- [Constants and Literals](#)
- [Objective-C Mapping for Modules](#)
- [Objective-C Mapping for Identifiers](#)
- [Objective-C Mapping for Built-In Types](#)
- [Objective-C Mapping for Enumerations](#)
- [Objective-C Mapping for Structures](#)
- [Objective-C Mapping for Sequences](#)
- [Objective-C Mapping for Dictionaries](#)
- [Objective-C Mapping for Exceptions](#)
- [Objective-C Mapping for Interfaces](#)

Objective-C Mapping for Exceptions

This page describes the Objective-C mapping for exceptions.

On this page:

- [Exception Inheritance Hierarchy in Objective-C](#)
- [Mapping for Exception Data Members in Objective-C](#)
- [Objective-C Mapping for User Exceptions](#)
- [Objective-C Mapping for Run-Time Exceptions](#)
 - [Creating and Initializing Run-Time Exceptions in Objective-C](#)
- [Copying and Deallocating Exceptions in Objective-C](#)
- [Exception Comparison and Hashing in Objective-C](#)

Exception Inheritance Hierarchy in Objective-C

Here again is a fragment of the Slice definition for our `world time` server:

Slice
<pre>exception GenericError { string reason; }; exception BadTimeVal extends GenericError {}; exception BadZoneName extends GenericError {};</pre>

These exception definitions map as follows:

Objective-C
<pre>@interface EXGenericError : ICEUserException { @private NSString *reason_; } @property(n nonatomic, retain) NSString *reason_; // ... @end @interface EXBadTimeVal : EXGenericError // ... @end @interface EXBadZoneName : EXGenericError // ... @end</pre>

Each Slice exception is mapped to an Objective-C class. For each exception member, the corresponding class contains a private instance variable and a property. (Obviously, because `BadTimeVal` and `BadZoneName` do not have members, the generated classes for these exceptions also do not have members.)

The inheritance structure of the Slice exceptions is preserved for the generated classes, so `EXBadTimeVal` and `EXBadZoneName` inherit from `EXGenericError`.

In turn, `EXGenericError` derives from `ICEUserException`:

```

Objective-C

@interface ICEException : NSException
-(NSString* *)ice_name;
@end

@interface ICEUserException : ICEException
// ...
@end

@interface ICELocalException : ICEException
// ...
@end

```

Note that `ICEUserException` itself derives from `ICEException`, which derives from `NSException`. Similarly, run-time exceptions derive from a common base class `ICELocalException` that derives from `ICEException`, so we have the inheritance structure shown below:

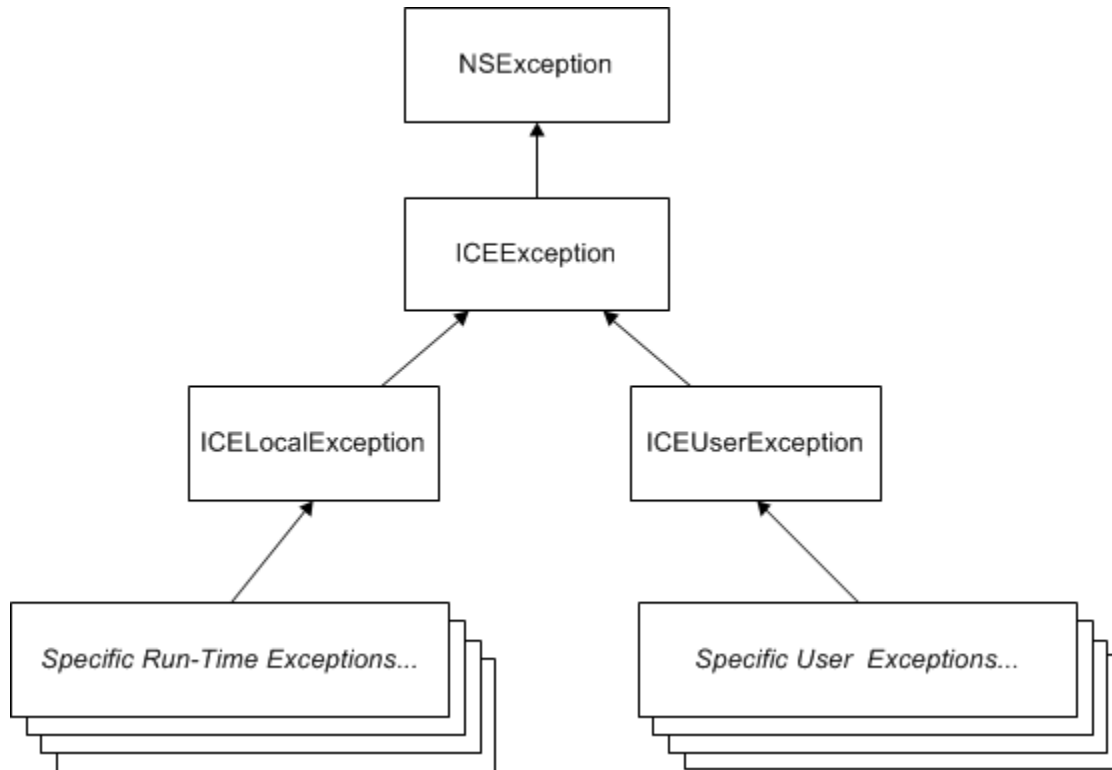

Inheritance structure for exceptions.

`ICEException` provides a single method, `ice_name`, that returns the Slice type ID of the exception with the leading `::` omitted. For example, the return value of `ice_name` for our Slice `GenericError` is `Example::GenericError`.

Mapping for Exception Data Members in Objective-C

As we mentioned [earlier](#), each data member of a Slice exception generates a corresponding Objective-C property. Here is an example that extends our `GenericError` with yet another exception:

Slice
<pre>exception GenericError { string reason; }; exception FileError extends GenericError { string name; int errorCode; };</pre>

The generated properties for these exceptions are as follows:

Objective-C
<pre>@interface EXGenericError : ICEUserException { @private NSString *reason_; } @property(nonatomic, retain) NSString *reason_; // ... @end @interface EXFileError : EXGenericError { @private NSString *name_; ICEInt errorCode; } @property(nonatomic, retain) NSString *name_; @property(nonatomic, assign) ICEInt errorCode; // ... @end</pre>

This is exactly the same mapping as for [structure members](#), with one difference: the `name` and `reason` members map to `name_` and `reason_` properties, whereas — as for structures — `errorCode` maps to `errorCode`. The trailing underscore for `reason_` and `name_` prevents a name collision with the `name` and `reason` methods that are defined by `NSEException`: if you call the `name` method, you receive the name that is stored by `NSEException`; if you call the `name_` method, you receive the value of the `name_` instance variable of `EXFileError`:

Objective-C

```

@try {
    // Do something that can throw ExFileError...
}
@catch(EXFileError *ex)
{
    // Print the value of the Slice reason, name,
    // and errorCode members.
    printf("reason: %s, name: %s, errorCode: %d\n",
           [ex.reason_ UTF8String],
           [ex.name_ UTF8String],
           ex.errorCode);

    // Print the NSExcption name.
    printf("NSExcption name: %s\n", [[ex name] UTF8String]);
}

```

The same escape mechanism applies if you define exception data members named `callStackReturnAddresses`, `raise`, or `userInfo`.

Objective-C Mapping for User Exceptions

Initialization of exceptions follows the same pattern as for [structures](#): each exception (apart from the inherited no-argument `init` method) provides an `init` method that accepts one argument for each data member of the exception, and two convenience constructors. For example, the generated methods for our `EXGenericError` exception look as follows:

Objective-C

```

@interface EXGenericError : ICEUserException
// ...

-(id) init:(NSString *)reason;
+(id) genericError;
+(id) genericError:(NSString *)reason;
@endif

```

If a user exception has no data members (and its base exceptions do not have data members either), only the inherited `init` method and the no-argument convenience constructor are generated.

If you declare default values in your [Slice definition](#), the inherited `init` method and the no-argument convenience constructor initialize each data member with its declared value.

If an exception has a base exception with data members, its `init` method and convenience constructor accept one argument for each `Slice` data member, in base-to-derived order. For example, here are the methods for the `FileError` exception we defined [above](#):

Objective-C

```
@interface EXFileError : EXGenericError
// ...

-(id) init:(NSString *)reason name:(NSString *)name
        errorCode:(ICEInt)errorCode;

+(id) fileError;

+(id) fileError:(NSString *)reason name:(NSString *)name
        errorCode:(ICEInt)errorCode;

@end
```

Note that `init` and the second convenience constructor accept three arguments; the first initializes the `EXGenericError` base, and the remaining two initialize the instance variables of `EXFileError`.

Objective-C Mapping for Run-Time Exceptions

The Ice run time throws [run-time exceptions](#) for a number of pre-defined error conditions. All run-time exceptions directly or indirectly derive from `ICELocalException` which, in turn, derives from `ICEException`. (See the above illustration for an example of an inheritance diagram.)

By catching exceptions at the appropriate point in the hierarchy, you can handle exceptions according to the category of error they indicate:

- `NSException`
This is the root of the complete inheritance tree. Catching `NSException` catches all exceptions, whether they relate to Ice or the Cocoa framework.
- `ICEException`
Catching `ICEException` catches both user and run-time exceptions.
- `ICEUserException`
This is the root exception for all user exceptions. Catching `ICEUserException` catches all user exceptions (but not run-time exceptions).
- `ICELocalException`
This is the root exception for all run-time exceptions. Catching `ICELocalException` catches all run-time exceptions (but not user exceptions).
- `ICETimeoutException`
This is the base exception for both operation-invocation and connection-establishment timeouts.
- `ICEConnectTimeoutException`
This exception is raised when the initial attempt to establish a connection to a server times out.

For example, an `ICEConnectTimeoutException` can be handled as `ICEConnectTimeoutException`, `ICETimeoutException`, `ICELocalException`, `ICEException`, or `NSException`.

You will probably have little need to catch run-time exceptions as their most-derived type and instead catch them as `ICELocalException`; the fine-grained error handling offered by the remainder of the hierarchy is of interest mainly in the implementation of the Ice run time. Exceptions to this rule are the exceptions related to [facet](#) and [object](#) life cycles, which you may want to catch explicitly. These exceptions are `ICEFacetNotExistException` and `ICEObjectNotExistException`, respectively.

Creating and Initializing Run-Time Exceptions in Objective-C

`ICELocalException` provides two properties that return the file name and line number at which an exception was raised:

Objective-C

```

@interface ICELocalException : ICEException
{
// ...

@property(nonatomic, readonly) NSString* file;
@property(nonatomic, readonly) int line;

-(id)init:(const char*)file line:(int)line;
+(id)localException:(const char*)file line:(int)line;
@end

```

The `init` method and the convenience constructor accept the file name and line number as arguments.

Concrete run-time exceptions that derived from `ICEException` provide a corresponding `init` method and convenience constructor. For example, here is the Slice definition of `ObjectNotExistException`:

Slice

```

local exception RequestFailedException {
    Identity id;
    string facet;
    string operation;
};

local exception ObjectNotExistException
extends RequestFailedException {};

```

The Objective-C mapping for `ObjectNotExistException` is:

Objective-C

```

@interface ICEObjectNotExistException : ICERequestFailedException
// ...
-(id) init:(const char*)file__p line:(int)line__p;
-(id) init:(const char*)file__p
        line:(int)line__p
        id_(ICEIdentity *)id_
        facet:(NSString *)facet
        operation:(NSString *)operation;
+(id) objectNotExistException:(const char*)file__p
        line:(int)line__p;
+(id) objectNotExistException:(const char*)file__p
        line:(int)line__p
        id_(ICEIdentity *)id_
        facet:(NSString *)facet
        operation:(NSString *)operation;

@end

```

In other words, as for user exceptions, run-time exceptions provide `init` methods and convenience constructors that accept arguments in base-to-derived order. This means that all run-time exceptions require a file name and line number when they are instantiated. For example, you can throw an `ICEObjectNotExistException` as follows:

Objective-C

```

@throw [ICEObjectNotExistException
objectNotExistException:__FILE__ line:__LINE__];

```

If you throw this exception in the context of an executing operation on the server side, the `id_`, `facet`, and `operation` instance variables are automatically initialized by the Ice run time.

When you instantiate a run-time exception, the base `NSEException` is initialized such that its `name` method returns the same string as `ice_name`; the `reason` and `userInfo` methods return `nil`.

Copying and Deallocating Exceptions in Objective-C

User exceptions and run-time exceptions implement the `NSCopying` protocol, so you can copy them. The semantics are the same as for structures.

Similarly, like structures, exceptions implement a `dealloc` method that takes care of deallocating the instance variables when an exception is released.

Exception Comparison and Hashing in Objective-C

Exceptions do not override `isEqual` or `hash`, so these methods have the behavior inherited from `NSObject`.

See Also

- [User Exceptions](#)
- [Run-Time Exceptions](#)
- [Objective-C Mapping for Modules](#)
- [Objective-C Mapping for Identifiers](#)

- [Objective-C Mapping for Built-In Types](#)
- [Objective-C Mapping for Enumerations](#)
- [Objective-C Mapping for Structures](#)
- [Objective-C Mapping for Sequences](#)
- [Objective-C Mapping for Dictionaries](#)
- [Objective-C Mapping for Constants](#)
- [Objective-C Mapping for Interfaces](#)
- [Facets and Versioning](#)
- [Object Life Cycle](#)

Objective-C Mapping for Interfaces

The mapping of Slice [interfaces](#) revolves around the idea that, to invoke a remote operation, you call a member function on a local class instance that represents the remote object. This makes the mapping easy and intuitive to use because, for all intents and purposes (apart from error semantics), making a remote procedure call is no different from making a local procedure call.

On this page:

- [Proxy Classes and Proxy Protocols in Objective-C](#)
- [Proxy Instantiation and Casting in Objective-C](#)
 - [Using a Checked Cast in Objective-C](#)
 - [Using an Unchecked Cast in Objective-C](#)
- [Using Proxy Methods in Objective-C](#)
- [Object Identity and Proxy Comparison in Objective-C](#)

Proxy Classes and Proxy Protocols in Objective-C

On the client side, interfaces map to a protocol with member functions that correspond to the operations on those interfaces. Consider the following simple interface:

```

Slice

["objc:prefix:EX"]
module Example {
    interface Simple {
        void op();
    }
};
```

The Slice compiler generates the following definitions for use by the client:

```

Objective-C

@interface EXSimplePrx : ICEObjectPrx
// Mapping-internal methods here...
@end

@protocol EXSimplePrx <ICEObjectPrx>
-(void) op;
-(void) op:(ICEContext *)context;
@end;
```

As you can see, the compiler generates a proxy protocol `EXSimplePrx` and a proxy class `EXSimplePrx`. In general, the generated name for both protocol and class is `<module-prefix><interface-name>Prx`.

In the client's address space, an instance of `EXSimplePrx` is the local ambassador for a remote instance of the `Simple` interface in a server and is known as a *proxy class instance*. All the details about the server-side object, such as its address, what protocol to use, and its object identity are encapsulated in that instance.

Note that `EXSimplePrx` derives from `ICEObjectPrx`, and that `EXSimplePrx` adopts the `ICEObjectPrx` protocol. This reflects the fact that all Slice interfaces implicitly derive from `Ice::Object`. For each operation in the interface, the proxy protocol has two methods whose name is derived from the operation. For the preceding example, we find that the operation `op` is mapped to two methods, `op` and `op:`.

The second method has a trailing parameter of type `ICEContext`. This parameter is for use by the Ice run time to store information about

how to deliver a request; normally, you do not need to supply a value here and can pretend that the trailing parameter does not exist. (We examine the `ICEContext` parameter in detail in [Request Contexts](#). The parameter is also used by `IceStorm`.)

Proxy Instantiation and Casting in Objective-C

Client-side application code never manipulates proxy class instances directly. In fact, you are not allowed to instantiate a proxy class directly. Instead, proxy instances are always instantiated on behalf of the client by the Ice run time, so client code never has any need to instantiate a proxy directly.

Proxies are immutable: once the run time has instantiated a proxy, that proxy continues to denote the same remote object and cannot be changed. This means that, if you want to keep a copy of a proxy, it is sufficient to call `retain` on the proxy. (You can also call `copy` on a proxy because `ICEObjectPrx` implements `NSCopying`. However, calling `copy` has the same effect as calling `retain`.)

Proxies are always passed and returned as type `id<module-prefix><interface-name>Prx>`. For example, for the preceding `Simple` interface, the proxy type is `id<EXSimplePrx>`.

The `ICEObjectPrx` base class provides class methods that allow you to cast a proxy from one type to another, as described below.

Using a Checked Cast in Objective-C

A `checkedCast` tests whether the object denoted by a proxy implements the specified interface:

```
Objective-C
+(id) checkedCast:(id<ICEObjectPrx>)proxy;
```

If so, the cast returns a proxy to the specified interface; otherwise, if the object denoted by the proxy does not implement the specified interface, the cast returns `nil`. Checked casts are typically used to safely down-cast a proxy to a more derived interface. For example, assuming we have Slice interfaces `Base` and `Derived`, you can write the following:

```
Objective-C
id<EXBasePrx> base = ...; // Initialize base proxy
id<EXDerivedPrx> derived = [EXDerivedPrx checkedCast:base];
if(derived != nil)
{
    // base implements run-time type Derived
    // use derived...
} else {
    // Base has some other, unrelated type
}
```

The expression `[EXDerivedPrx checkedCast:base]` tests whether `base` points at an object of type `Derived` (or an object with a type that is derived from `Derived`). If so, the cast succeeds and `derived` is set to point at the same object as `base`. Otherwise, the cast fails and `derived` is set to `nil`. (Proxies that "point nowhere" are represented by `nil`.)

A `checkedCast` typically results in a remote message to the server.



In some cases, the Ice run time can optimize the cast and avoid sending a message. However, the optimization applies only in narrowly-defined circumstances, so you cannot rely on a `checkedCast` not sending a message.

The message effectively asks the server "is the object denoted by this proxy of type `Derived`?" The reply from the server is communicated to the application code in form of a successful (non-`nil`) or unsuccessful (`nil`) result. Sending a remote message is necessary because, as

a rule, there is no way for the client to find out what the actual run-time type of a proxy is without confirmation from the server. (For example, the server may replace the implementation of the object for an existing proxy with a more derived one.) This means that you have to be prepared for a `checkedCast` to fail. For example, if the server is not running, you will receive an `ICEConnectionRefusedException`; if the server is running, but the object denoted by the proxy no longer exists, you will receive an `ICEObjectNotExistException`.

Using an Unchecked Cast in Objective-C

In some cases, it is known that an object supports a more derived interface than the static type of its proxy. For such cases, you can use an unchecked down-cast:

```
Objective-C
```

```
+(id) uncheckedCast:(id<ICEObjectPrx>)proxy;
```

Here is an example:

```
Objective-C
```

```
id<EXBasePrx> base;
base = ...; // Initialize base to point at a Derived
id<EXDerivedPrx> derived = [EXDerivedPrx uncheckedCast:base];
// Use derived...
```

An `uncheckedCast` provides a down-cast *without* consulting the server as to the actual run-time type of the object. You should use an `uncheckedCast` only if you are certain that the proxy indeed supports the more derived type: an `uncheckedCast`, as the name implies, is not checked in any way; it does not contact the object in the server and, if the proxy does not support the specified interface, the cast does not return null. If you use the proxy resulting from an incorrect `uncheckedCast` to invoke an operation, the behavior is undefined. Most likely, you will receive an `ICEOperationNotExistException`, but, depending on the circumstances, the Ice run time may also report an exception indicating that unmarshaling has failed, or even silently return garbage results.

Despite its dangers, `uncheckedCast` is still useful because it avoids the cost of sending a message to the server. And, particularly during initialization, it is common to receive a proxy of type `id<ICEObjectPrx>`, but with a known run-time type. In such cases, an `uncheckedCast` saves the overhead of sending a remote message.

Note that an `uncheckedCast` is *not* the same as an ordinary cast. The following is incorrect and has undefined behavior:

```
Objective-C
```

```
id<EXDerivedPrx> derived = (id<EXDerivedPrx>)base; // Wrong!
```

Both `checkedCast` and `uncheckedCast` call `autorelease` on the proxy they return so, if you want to prevent the proxy from being deallocated once the enclosing `autorelease` pool is drained, you must call `retain` on the returned proxy.

Using Proxy Methods in Objective-C

The `ICEObjectPrx` provides a variety of [methods for customizing a proxy](#). Since proxies are immutable, each of these "factory methods" returns a copy of the original proxy that contains the desired modification. For example, you can obtain a proxy configured with a ten-second timeout as shown below:

Objective-C

```
id<ICEObjectPrx> proxy = [communicator stringToProxy:...];
proxy = [proxy ice_timeout:10000];
```

A factory method returns a new (autoreleased) proxy object if the requested modification differs from the current proxy, otherwise it returns the original proxy. The returned proxy is always of the same type as the source proxy, except for the factory methods `ice_facet` and `ice_identity`. Calls to either of these methods may produce a proxy for an object of an unrelated type, therefore they return a base proxy that you must subsequently down-cast to an appropriate type.

Object Identity and Proxy Comparison in Objective-C

Proxy objects support comparison with `isEqual`. Note that `isEqual` uses *all* of the information in a proxy for the comparison. This means that not only the object identity must match for a comparison to succeed, but other details inside the proxy, such as the protocol and endpoint information, must be the same as well. In other words, comparison with `isEqual` tests for proxy identity, not object identity. A common mistake is to write code along the following lines:

Objective-C

```
id<ICEObjectPrx> p1 = ...; // Get a proxy...
id<ICEObjectPrx> p2 = ...; // Get another proxy...

if (![p1 isEqual:p2]) {
    // p1 and p2 denote different objects // WRONG!
} else {
    // p1 and p2 denote the same object // Correct
}
```

Even though `p1` and `p2` differ, they may denote the same Ice object. This can happen if, for example, `p1` and `p2` embed the same object identity, but use a different protocol to contact the target object. Similarly, the protocols might be the same, but could denote different endpoints (because a single Ice object can be contacted via several different transport endpoints). In other words, if two proxies compare equal with `isEqual`, we know that the two proxies denote the same object (because they are identical in all respects); however, if two proxies compare unequal with `isEqual`, we know absolutely nothing: the proxies may or may not denote the same object.

To compare the object identities of two proxies, you can use additional methods provided by proxies:

Objective-C

```
@protocol ICEObjectPrx <NSObject, NSCopying>
// ...
-(NSComparisonResult) compareIdentity:(id<ICEObjectPrx>)p;
-(NSComparisonResult) compareIdentityAndFacet:(id<ICEObjectPrx>)p;
@end
```

The `compareIdentity` method compares the object identities embedded in two proxies while ignoring other information, such as facet and transport information. To include the **facet name** in the comparison, use `compareIdentityAndFacet` instead.

`compareIdentity` and `compareIdentityAndFacet` allow you to correctly compare proxies for object identity. The example below demonstrates how to use `compareIdentity`:

Objective-C

```
id<ICEObjectPrx> p1 = ...;    // Get a proxy...
id<ICEObjectPrx> p2 = ...;    // Get another proxy...

if ([p1 compareIdentity:p2] != NSOrderedSame) {
    // p1 and p2 denote different objects    // Correct
} else {
    // p1 and p2 denote the same object    // Correct
}
```

See Also

- [Interfaces, Operations, and Exceptions](#)
- [Proxies](#)
- [Objective-C Mapping for Operations](#)
- [Operations on Object](#)
- [Proxy Methods](#)
- [Facets and Versioning](#)
- [IceStorm](#)

Objective-C Mapping for Operations

On this page:

- [Basic Objective-C Mapping for Operations](#)
- [Normal and `idempotent` Operations in Objective-C](#)
- [Passing Parameters in Objective-C](#)
 - [In-Parameters in Objective-C](#)
 - [Passing `nil` and `NSNull` in Objective-C](#)
 - [Out-Parameters in Objective-C](#)
 - [Memory Management for Out-Parameters in Objective-C](#)
 - [Receiving Return Values in Objective-C](#)
 - [Chained Invocations in Objective-C](#)
 - [`nil` Out-Parameters and Return Values in Objective-C](#)
 - [Optional Parameters in Objective-C](#)
- [Exception Handling in Objective-C](#)
 - [Exceptions and Out-Parameters in Objective-C](#)
 - [Exceptions and Return Values in Objective-C](#)

Basic Objective-C Mapping for Operations

As we saw in the [mapping for interfaces](#), for each [operation](#) on an interface, the proxy protocol contains two corresponding methods with the same name as the operation.

To invoke an operation, you call it via the proxy object. For example, here is part of the definitions for our [file system](#):

Slice
<pre>["objc:prefix:FS" module Filesystem { interface Node { idempotent string name(); }; // ... };</pre>

The proxy protocol for the `Node` interface looks as follows:

Objective-C
<pre>@protocol FSNodePrx <ICEObjectPrx> -(NSMutableString *) name; -(NSMutableString *) name:(ICEContext *)context; @end;</pre>

The `name` method returns a value of type `NSMutableString`. Given a proxy to an object of type `Node`, the client can invoke the operation as follows:

Objective-C

```
id<EXNodePrx> node = ...; // Initialize proxy
NSString *name = [node name]; // Get name via RPC
```

The `name` method sends the operation invocation to the server, waits until the operation is complete, and then unmarshals the return value and returns it to the caller.

Because the `name` method autoreleases the return value, it is safe to ignore the return value. For example, the following code contains no memory leak:

Objective-C

```
id<EXNodePrx> node = ...; // Initialize proxy
[node name]; // Useless, but no leak
```

If you ignore the return value, no memory leak occurs because the next time the enclosing autorelease pool is drained, the memory will be reclaimed.

Normal and idempotent Operations in Objective-C

You can add an `idempotent` qualifier to a Slice operation. As far as the corresponding proxy protocol methods are concerned, `idempotent` has no effect. For example, consider the following interface:

Slice

```
interface Ops {
    string op1();
    idempotent string op2();
    idempotent void op3(string s);
};
```

The proxy protocol for this interface looks like this:

Objective-C

```
@protocol EXOpsPrx <ICEObjectPrx>
-(NSMutableString *) op1;
-(NSMutableString *) op1:(ICEContext *)context;
-(NSMutableString *) op2;
-(NSMutableString *) op2:(ICEContext *)context;
-(void) op3:(NSString *)s;
-(void) op3:(NSString *)s context:(ICEContext *)context;
@end;
```



For brevity, we will not show the methods with the additional trailing `context` parameter for the remainder of this discussion. Of course, the compiler generates the additional methods regardless.

Because `idempotent` affects an aspect of call dispatch, not interface, it makes sense for the mapping to be unaffected by the `idempotent` keyword.

Passing Parameters in Objective-C

In-Parameters in Objective-C

The parameter passing rules for the Objective-C mapping are very simple: value type parameters are passed by value and non-value type parameters are passed by pointer. Semantically, the two ways of passing parameters are identical: the Ice run time guarantees not to change the value of an in-parameter.

Here is an interface with operations that pass parameters of various types from client to server:

Slice
<pre> struct NumberAndString { int x; string str; }; sequence<string> StringSeq; dictionary<long, StringSeq> StringTable; interface ClientToServer { void op1(int i, float f, bool b, string s); void op2(NumberAndString ns, StringSeq ss, StringTable st); void op3(ClientToServer* proxy); }; </pre>

The Slice compiler generates the following code for this definition:

Objective-C

```

@interface EXNumberAndString : NSObject <NSCopying>
// ...
@property(nonatomic, assign) ICEInt x;
@property(nonatomic, retain) NSString *str;
// ...
@end

typedef NSArray EXStringSeq;
typedef NSMutableArray EXMutableStringSeq;

typedef NSDictionary EXStringTable;
typedef NSMutableDictionary EXMutableStringTable;

@protocol EXClientToServerPrx <ICEObjectPrx>
-(void) op1:(ICEInt)i f:(ICEFloat)f b:(BOOL)b s:(NSString *)s;
-(void) op2:(EXNumberAndString *)ns ss:(EXStringSeq *)ss
st:(NSDictionary *)st;
-(void) op3:(id<EXClientToServerPrx>)proxy;
@end;

```

Given a proxy to a `ClientToServer` interface, the client code can pass parameters as in the following example:

Objective-C

```

id<EXClientToServerPrx> p = ...; // Get proxy...

[p op1:42 f:3.14 b:YES s:@"Hello world!"]; // Pass literals

ICEInt i = 42;
ICEFloat f = 3.14;
BOOL b = YES;
NSString *s = @"Hello world!";

[p op1:i f:f b:b s:s]; // Pass simple vars

EXNumberAndString *ns = [EXNumberAndString numberAndString:42
str:@"The Answer"];
EXMutableStringSeq *ss = [EXMutableStringSeq array];
[ss addObject:@"Hello world!"];
EXStringTable *st = [EXMutableStringTable dictionary];
[ss setObject:ss forKey:[NSNumber numberWithInt:0]];

[p op2:ns ss:ss st:st]; // Pass complex vars

[p op3:p]; // Pass proxy

```

You can pass either literals or variables to the various operations. The Ice run time simply marshals the value of the parameters to the server and leaves parameters otherwise untouched, so there are no memory-management issues to consider.

Note that the invocation of `op3` is somewhat unusual: the caller passes the proxy it uses to invoke the operation to the operation as a parameter. While unusual, this is legal (and no memory management issues arise from doing this.)

Passing `nil` and `NSNull` in Objective-C

The Slice language supports the concept of null ("points nowhere") for only two of its types: proxies and classes. For either type, `nil` represents a null proxy or class. For other Slice types, such as strings, the concept of a null string simply does not apply. (There is no such thing as a null string, only the empty string.) However, strings, structures, sequences, and dictionaries are all passed by pointer, which raises the question of how the Objective-C mapping deals with `nil` values.

As a convenience feature, the Objective-C mapping permits passing of `nil` as a parameter for the following types:

- Proxies (`nil` sends a null proxy.)
- Classes (`nil` sends a null class instance.)
- Strings (`nil` sends an empty string.)
- Structures (`nil` sends a default-initialized structure.)
- Sequences (`nil` sends an empty sequence.)
- Dictionaries (`nil` sends an empty dictionary.)

It is impossible to add `nil` to an `NSArray` or `NSDictionary`, so the mapping follows the usual convention that an `NSArray` element or `NSDictionary` value that is conceptually `nil` is represented by `NSNull`. For example, to send a sequence of proxies, some of which are null proxies, you must insert `NSNull` values into the sequence.

As a convenience feature, if you have a sequence with elements of type string, structure, sequence, or dictionary, you can use `NSNull` as the element value. For elements that are `NSNull`, the Ice run time marshals an empty string, default-initialized structure, empty sequence, or empty dictionary to the receiver.

Similarly, for dictionaries with value type string, structure, sequence, or dictionary, you can use `NSNull` as the value to send the corresponding empty value (or default-initialized value, in the case of structures).

Out-Parameters in Objective-C

The Objective-C mapping passes out-parameters by pointer (for value types) and by pointer-to-pointer (for non-value types). Here is the [Slice definition](#) once more, modified to pass all parameters in the `out` direction:

Slice

```

struct NumberAndString {
    int x;
    string str;
};

sequence<string> StringSeq;

dictionary<long, StringSeq> StringTable;

interface ServerToClient {
    void op1(out int i, out float f, out bool b, out string s);
    void op2(out NumberAndString ns,
             out StringSeq ss,
             out StringTable st);
    void op3(out ClientToServer* proxy);
};

```

The Slice compiler generates the following code for this definition:

Objective-C

```

@protocol EXServerToClientPrx <ICEObjectPrx>
-(void) op1:(ICEInt *)i f:(ICEFloat *)f b:(BOOL *)b
s:(NSMutableString **)s;
-(void) op2:(EXNumberAndString **)ns ss:(EXMutableStringSeq **)ss
           st:(EXMutableStringTable **)st;
-(void) op3:(id<EXClientToServerPrx> *)proxy;
@end

```

Note that, for types that come in immutable and mutable variants (strings, sequences, and dictionaries), the corresponding out-parameter uses the mutable variant.

Given a proxy to a `ServerToClient` interface, the client code can pass parameters as in the following example:

Objective-C

```

id<EXServerToClientPrx> p = ...; // Get proxy...

ICEInt i;
ICEFloat f;
BOOL b;
NSMutableString *s;

[p op1:&i f:&f b:&b s:&s];
// i, f, b, and s contain updated values now

EXNumberAndString *ns;
EXStringSeq *ss;
EXStringTable *st;

[p op2:&ns ss:&ss st:&st];
// ns, ss, and st contain updated values now

[p op3:&p];
// p has changed now!

```

Again, there are no surprises in this code: the caller simply passes pointers to pointer variables to a method; once the operation completes, the values of those variables will have been set by the server.

Memory Management for Out-Parameters in Objective-C

When the Ice run time returns an out-parameter to the caller, it does not make any assumptions about the previous value of that parameter (if any). In other words, if you pass an initialized string as an out-parameter, the value you pass is simply discarded and the corresponding variable is assigned a new instance. As an example, consider the following operation:

Slice

```
void getString(out string s);
```

You could call this as follows:

Objective-C

```

NSMutableString *s = @"Hello";
[p getString:&s];
// s now points at the returned string.

```

All out-parameters are autoreleased by the Ice run time before they are returned. This is convenient because it does just the right thing with respect to memory management. For example, the following code does not leak memory:

Objective-C

```
NSMutableString *s = @"Hello";
[p getString:&s];
[p getString:&s]; // No leak here.
```

However, because the pointer value of out-parameters is simply assigned by the proxy method, you must be careful not to pass a variable as an out-parameter if that variable was not released or autoreleased:

Objective-C

```
NSMutableString *s = [[NSMutableString alloc] initWithString:@"Hello"];
[p getString:&s]; // Bad news!
```

This code leaks the initial string because the proxy method assigns the passed pointer without calling `release` on it first. (In practice, this is rarely a problem because there is no need to initialize out-parameters and, if an out-parameter was initialized by being passed as an out-parameter to an operation earlier, its value will have been autoreleased by the proxy method already.)

It is worth having another look at the final call of the [code example](#) we saw earlier:

Objective-C

```
[p op3:&p];
```

Here, `p` is the proxy that is used to dispatch the call. That same variable `p` is also passed as an out-parameter to the call, meaning that the server will set its value. In general, passing the same parameter as both an input and output parameter is safe (with the caveat we just discussed).

Receiving Return Values in Objective-C

The Objective-C mapping returns return values in much the same way as out-parameters: value types are returned by value, and non-value types are returned by pointer. As an example, consider the following operations:

Slice

```
struct NumberAndString {
    int x;
    string str;
};

interface Ops {
    int getInt();
    string getString();
    NumberAndString getNumberAndString();
};
```

The proxy protocol looks as follows:

Objective-C

```
@protocol EXOpsPrx <ICEObjectPrx>
-(ICEInt) getInt;
-(NSString *) getString;
-(EXNumberAndString *) getNumberAndString;
@end
```

Note that, for types with mutable and immutable variants (strings, sequences, and dictionaries), the formal return type is the mutable variant. As for out-parameters, anything returned by pointer is autoreleased by the Ice run time. This means that the following code works fine and does not contain memory management errors:

Objective-C

```
EXNumberAndString *ns = [NSNumberAndString numberAndString];
ns.x = [p getInt];
ns.str = [p getString]; // Autoreleased by getString,
                        // retained by ns.str.

[p getNumberAndString]; // No leak here.
```

The return value of `getString` is autoreleased by the proxy method but, during the assignment to the property `str`, the generated code calls `retain`, so the structure keeps the returned string alive in memory, as it should. Similarly, ignoring the return value from an invocation is safe because the returned value is autoreleased and will be reclaimed when the enclosing autorelease pool is drained.

Chained Invocations in Objective-C

Consider the following simple interface containing two operations, one to set a value and one to get it:

Slice

```
interface Name {
    string getName();
    void setName(string name);
};
```

Suppose we have two proxies to interfaces of type `Name`, `p1` and `p2`, and chain invocations as follows:

Objective-C

```
[p2 setName:[p1 getName]]; // No leak here.
```

This works exactly as intended: the value returned by `p1` is transferred to `p2`. There are no memory-management or exception safety issues with this code.

nil Out-Parameters and Return Values in Objective-C

If an out-parameter or return value is a proxy or class, and the operation returns a null proxy or class, the proxy method returns `nil`. If a

proxy or class is returned as part of a sequence or dictionary, the corresponding entry is `NSNull`.

For strings, structures, sequences, and dictionaries, the Ice run time *never* returns `nil` or `NSNull` (even if the server passed `nil` or `NSNull` as the value). Instead, the unmarshaling code always instantiates an empty string, empty sequence, or empty dictionary, and it always initializes structure members during unmarshaling, so structures that are returned from an operation invocation never contain a `nil` instance variable (except for proxy and class instance variables).

Optional Parameters in Objective-C

The Objective-C mapping uses the `id` type for [optional parameters](#). As a result, there's no compile time check for optional parameters. Instead, Ice performs a run-time type check and if the optional parameter does not match the expected type an `NSException` with the `NSInvalidArgumentException` name is raised. Slice types that map to an Objective-C class use the same mapping as required parameters. Slice built-in basic types (except string) are boxed into an `NSNumber` value. The `ICENone` singleton value can also be passed as the value of an optional parameter or return value.

Consider the following operation:

Slice
<pre>optional(1) int execute(optional(2) string aString, optional(3) int anInt, out optional(4) float outFloat);</pre>

A client can invoke this operation as shown below:

Objective-C
<pre>id f; id i; i = [proxy execute:@"--file log.txt" anInt:@14 outFloat:&f] i = [proxy execute:ICENone anInt:@14 outFloat:&f] // aString is unset if(i == ICENone) { NSLog(@"return value is not set"); } else { int v = [i intValue]; NSLog(@"return value is set to %d", v); }</pre>

Passing `nil` for an optional parameter is the same as passing `nil` for a required parameter, the optional parameter is considered to be set to `nil`. For Slice built-in basic types (except string), the optional parameter is considered to be set to `0` or `NO` for booleans.

A well-behaved program must not assume that an optional parameter always has a value. It should compare the value to `ICENone` to determine whether the optional parameter is set.

Exception Handling in Objective-C

Any operation invocation may throw a [run-time exception](#) and, if the operation has an exception specification, may also throw [user exceptions](#). Suppose we have the following simple interface:

Slice

```

exception Tantrum {
    string reason;
};

interface Child {
    void askToCleanUp() throws Tantrum;
};

```

Slice exceptions are thrown as Objective-C exceptions, so you can simply enclose one or more operation invocations in a try-catch block:

Objective-C

```

id<EXChildPrx> child = ...;    // Get proxy...
@try {
    [child askToCleanUp];    // Give it a try...
} @catch (EXTantrum *t) {
    printf("The child says: %s\n", t.reason_);
}

```

Typically, you will catch only a few exceptions of specific interest around an operation invocation; other exceptions, such as unexpected run-time errors, will typically be dealt with by exception handlers higher in the hierarchy. For example:

Objective-C

```

void run()
{
    id<EXChildPrx> child = ...;           // Get proxy...
    @try {
        [child askToCleanUp];           // Give it a try...
    } @catch (EXTantrum *t) {
        printf("The child says: %s\n", t.reason);
        [child scold];                  // Recover from error...
    }
    [child praise];                      // Give positive feedback...
}

int
main(int argc, char* argv[])
{
    int status = 1;
    @try {
        // ...
        run();
        // ...
        status = 0;
    } @catch (ICEException *e) {
        printf("Unexpected run-time error: %s\n", [e ice_name]);
    }
    // ...
    return status;
}

```

This code handles a specific exception of local interest at the point of call and deals with other exceptions generically. (This is also the strategy we used for our [first simple application](#).)

Exceptions and Out-Parameters in Objective-C

If an operation throws an exception, the Ice run time makes no guarantee for the value of out-parameters. Individual out-parameters may have the old value, the new value, or a value that is indeterminate, such that parts of the out-parameter have been assigned and others have not. However, no matter what their state, the values will be "safe" for memory-management purposes, that is, any out-parameters that were successfully unmarshaled are autoreleased.

Exceptions and Return Values in Objective-C

For return values, the Objective-C mapping provides the guarantee that a variable receiving the return value of an operation will not be overwritten if an exception is thrown.

See Also

- [Operations](#)
- [Hello World Application](#)
- [Objective-C Mapping for Interfaces](#)
- [Objective-C Mapping for Exceptions](#)
- [Objective-C Mapping for Local Interfaces](#)

- [Request Contexts](#)

Objective-C Mapping for Local Interfaces

The Ice run time defines APIs using [Slice](#). These APIs are provided as part of the Ice run time library and cannot be invoked remotely. (Doing so would not make any sense.) Therefore, the Slice interfaces for the Ice run time are defined as [local interfaces](#). The Objective-C mapping for local interfaces differs from the default mapping in two ways:

- Local interfaces do not adopt an `<interface-name>Prx` protocol. (Doing so would be misleading because proxies imply that the target object can be remote.) Instead, the protocol for local interfaces has the same name as the interface. For example, the `Ice::Communicator` interfaces is defined as:

```

Slice
["objc:prefix:ICE"]
module Ice {
    local interface Communicator {
        // ...
    }
};

```

Because `Communicator` is a local interface, objects of type `ICECommunicator` are passed as `id<ICECommunicator>` (*not* `ICECommunicator*` Or `id<ICECommunicatorPrx>`).

- Types that come in mutable and immutable variants (strings, sequences, and dictionaries) are always passed as the immutable variant. For example, the `getName` operation on the `ObjectAdapter` interface is defined as:

```

Slice
["objc:prefix:ICE"]
module Ice {
    local interface ObjectAdapter {
        string getName();
    };
};

```

Because `ObjectAdapter` is a local interface, the `getName` operation maps to:

```

Objective-C
-(NSString *) getName;

```

Note that the returned string is of type `NSString` instead of `NSMutableString` (as would be the case for an operation on a non-local interface).

For local interfaces, parameters are passed as the immutable version because their values are not meant to be modified by application code. In addition, passing the immutable version avoids an unnecessary data copy.

See Also

- [Modules](#)
- [Local Types](#)
- [Objective-C Mapping for Operations](#)

Objective-C Mapping for Classes

On this page:

- [Basic Objective-C Mapping for Classes](#)
- [Derivation from ICEObject in Objective-C](#)
- [Class Data Members in Objective-C](#)
- [Class Constructors in Objective-C](#)
- [Derived Classes in Objective-C](#)
- [Passing Classes as Parameters in Objective-C](#)
- [Operations of Classes in Objective-C](#)
- [Class Factories in Objective-C](#)
 - [Using a Category to Implement Operations in Objective-C](#)
- [Copying of Classes in Objective-C](#)
 - [Cyclic References in Objective-C](#)

Basic Objective-C Mapping for Classes

A Slice class is mapped similar to a structure and exception.

The generated class contains an instance variable and a property for each Slice data member. Consider the following class definition:

Slice
<pre>class TimeOfDay { short hour; // 0 - 23 short minute; // 0 - 59 short second; // 0 - 59 string format(); // Return time as hh:mm:ss };</pre>

The Slice compiler generates the following code for this definition:

Objective-C
<pre>@interface EXTimeOfDay : ICEObject { ICEShort hour; ICEShort minute; ICEShort second; } @property(nonatomic, assign) ICEShort hour; @property(nonatomic, assign) ICEShort minute; @property(nonatomic, assign) ICEShort second; -(id) initWith:(ICEShort)hour minute:(ICEShort)minute second:(ICEShort)second; +(id) timeOfDay; +(id) timeOfDay:(ICEShort)hour minute:(ICEShort)minute second:(ICEShort)second; @end</pre>

There are a number of things to note about the generated code:

1. The generated class `EXTimeOfDay` derives from `ICEObject`, which is the parent of all classes. Note that `ICEObject` is *not* the same as `ICEObjectPrx`. In other words, you *cannot* pass a class where a proxy is expected and vice versa.
2. The generated class contains a property for each Slice data member.
3. The generated class provides an `init` method that accepts one argument for each data member, and it provides the same two convenience constructors as structures and exceptions.

Derivation from `ICEObject` in Objective-C

All classes ultimately derive from a common base class, `ICEObject`. Note that this is not the same as implementing the `ICEObjectPrx` protocol (which is implemented by proxies). As a result, you cannot pass a class where a proxy is expected (and vice versa) because the base types for classes and proxies are not compatible.

`ICEObject` defines a number of methods:

```

Objective-C

@protocol ICEObject <NSObject>
-(BOOL) ice_isA:(NSString*)typeId current:(ICECurrent*)current;
-(void) ice_ping:(ICECurrent*)current;
-(NSString*) ice_id:(ICECurrent*)current;
-(NSArray*) ice_ids:(ICECurrent*)current;
@end

@interface ICEObject NSObject <ICEObject, NSCopying>
-(BOOL) ice_isA:(NSString*)typeId;
-(void) ice_ping;
-(NSString*) ice_id;
-(NSArray*) ice_ids;
+(NSString*) ice_staticId;
-(void) ice_preMarshal;
-(void) ice_postUnmarshal;
-(BOOL) ice_dispatch:(id<ICERequest>)request;
-(id) initWithDelegate:(id)delegate;
+(id) objectWithDelegate:(id)delegate;
@end

```



The methods are split between the `ICEObject` protocol and class because classes can be servants.

The methods of `ICEObject` behave as follows:

- `ice_isA`
This function returns YES if the object supports the given `type ID`, and NO otherwise.
- `ice_ping`
`ice_ping` provides a basic reachability test for the class. If it completes without raising an exception, the class exists and is reachable. Note that `ice_ping` is normally only invoked on the proxy for a class that might be remote because a class instance that is local (in the caller's address space) can always be reached.
- `ice_ids`
This function returns a string sequence representing all of the `type IDs` supported by this object, including `::Ice::Object`.

- `ice_id`
This function returns the actual run-time [type ID](#) for a class. If you call `ice_id` via a pointer to a base instance, the returned type ID is the actual (possibly more derived) type ID of the instance.
- `ice_staticId`
This function returns the static [type ID](#) of a class.
- `ice_preMarshal`
The Ice run time invokes this function prior to marshaling the object's state, providing the opportunity for a subclass to validate its declared data members.
- `ice_postUnmarshal`
The Ice run time invokes this function after unmarshaling an object's state. A subclass typically overrides this function when it needs to perform additional initialization using the values of its declared data members.
- `ice_dispatch`
This function dispatches an incoming request to a servant. It is used in the implementation of [dispatch interceptors](#).
- `initWithDelegate`
These constructors enable the implementation of servants with a [delegate](#).

Class Data Members in Objective-C

By default, data members of classes are mapped exactly as for structures and exceptions: for each data member in the Slice definition, the generated class contains a corresponding property.

Class Constructors in Objective-C

Classes provide the usual `init` method and a parameter-less convenience constructor that perform default initialization of the class's instance variables. If you declare default values in your [Slice definition](#), the `init` method and convenience constructor initialize each data member with its declared value.

In addition, if a class has data members, it provides an `init` method and a convenience constructor that accept one argument for each data member. This allows you to allocate and initialize a class instance in a single statement (instead of first having to allocate and default-initialize the instance and then assign to its properties).

For derived classes, the `init` method and the convenience constructor have one parameter for each of the base class's data members, plus one parameter for each of the derived class's data members, in base-to-derived order. For example:

Slice
<pre>class Base { int i; }; class Derived extends Base { string s; };</pre>

This generates:

Objective-C

```

@interface EXBase : ICEObject
// ...

@property(nonatomic, assign) ICEInt i;

-(id) init:(ICEInt)i;
+(id) base;
+(id) base:(ICEInt)i;
@end

@interface EXDerived : EXBase
// ...

@property(nonatomic, retain) NSString *s;

-(id) init:(ICEInt)i s:(NSString *)s;
+(id) derived;
+(id) derived:(ICEInt)i s:(NSString *)s;
@end

```

Derived Classes in Objective-C

Note that, in the preceding example, the derivation of the Slice definitions is preserved for the generated classes: `EXBase` derives from `ICEObject`, and `EXDerived` derives from `EXBase`. This allows you to treat and pass classes polymorphically: you can always pass an `EXDerived` instance where an `EXBase` instance is expected.

Passing Classes as Parameters in Objective-C

Classes are passed by pointer, like any other Objective-C object. For example, here is an operation that accepts a `Base` as an in-parameter and returns a `Derived`:

Slice

```
Derived getDerived(Base d);
```

The corresponding proxy method looks as follows:

Objective-C

```
-(EXDerived *) getDerived:(EXBase *)d;
```

To pass a null instance, you simply pass `nil`.

Operations of Classes in Objective-C

If you look back at the code that is generated for the `EXTimeOfDay` class, you will notice that there is no indication at all that the class has a

`format` operation. As opposed to proxies, classes do not implement any protocol that would define which operations are available. This means that you can partially implement the operations of a class. For example, you might have a `Slice` class with five operations that is returned from a server to a client. If the client uses only one of the five operations, the client-side code needs to implement only that one operation and can leave the remaining four operations without implementation. (If the class were to implement a mandatory protocol, the client-side code would have to implement all operations in order to avoid a compiler warning.)

Of course, you must implement those operations that you actually intend to call. The mapping of operations for classes follows the *server-side* mapping for operations on interfaces: parameter types and labels are exactly the same. (See [Parameter Passing in Objective-C](#) for details.) In a nutshell, the server-side mapping is the same as the client-side mapping except that, for types that have mutable and immutable variants, they map to the immutable variant where the client-side mapping uses the mutable variant, and vice versa.

For example, here is how we could implement the `format` operation of our `TimeOfDay` class:

```

Objective-C



```

@interface TimeOfDayI : EXTimeOfDay
@end

@implementation TimeOfDayI
-(NSString *) format
{
 return [NSString stringWithFormat:@"%0.2d:%0.2d:%0.2d",
self.hour, self.minute, self.second];
}
@end

```

```

By convention, the implementation of classes with operations has the same name as the `Slice` class with an `I`-suffix. Doing this is not mandatory — you can call your implementation class anything you like. However, if you do not want to use the `I`-suffix naming, we recommend that you adopt another naming convention and follow it consistently.

Note that `TimeOfDayI` derives from `EXTimeOfDay`. This is because, as we will see in a moment, the Ice run time will instantiate a `TimeOfDayI` instance whenever it receives a `TimeOfDay` instance over the wire and expects that instance to provide the properties of `EXTimeOfDay`.

Class Factories in Objective-C

Having created a class such as `TimeOfDayI`, we have an implementation and we can instantiate the `TimeOfDayI` class, but we cannot receive it as the return value or as an out-parameter from an operation invocation. To see why, consider the following simple interface:

```

Slice



```

interface Time {
 TimeOfDay get();
};

```

```

When a client invokes the `get` operation, the Ice run time must instantiate and return an instance of the `TimeOfDayI` class. However, unless we tell it, the Ice run time cannot magically know that we have created a `TimeOfDayI` class that implements a `format` method. To allow the Ice run time to instantiate the correct object, we must provide a factory that knows that the `Slice` `TimeOfDay` class is implemented by our `TimeOfDayI` class. The `Ice::Communicator` interface provides us with the necessary operations:

Slice

```
[ "objc:prefix:ICE" ]
module Ice {
    local interface ObjectFactory {
        Object create(string type);
        void destroy();
    };

    local interface Communicator {
        void addObjectFactory(ObjectFactory factory, string id);
        ObjectFactory findObjectFactory(string id);
        // ...
    };
};
```

To supply the Ice run time with a factory for our `TimeOfDayI` class, we must implement the `ObjectFactory` interface:

Slice

```
module Ice {
    local interface ObjectFactory {
        Object create(string type);
        void destroy();
    };
};
```

The object factory's `create` operation is called by the Ice run time when it needs to instantiate a `TimeOfDay` class. The factory's `destroy` operation is called by the Ice run time when its communicator is destroyed. A possible implementation of our object factory is:

Objective-C

```
@interface ObjectFactory<ICEObjectFactory>
@end

@implementation ObjectFactory
-(ICEObject*) create:(NSString *)type
{
    NSAssert([type isEqualToString:@"::Example::TimeOfDay"]);
    return [[TimeOfDayI alloc] init];
}
@end
```

The `create` method is passed the [type ID](#) of the class to instantiate. For our `TimeOfDay` class, the type ID is `"::Example::TimeOfDay"`. Our implementation of `create` checks the type ID: if it is `"::Example::TimeOfDay"`, it instantiates and returns a `TimeOfDayI` object. For other type IDs, it asserts because it does not know how to instantiate other types of objects.

Note that your factory *must not* autorelease the returned instance. The Ice run time takes care of the necessary memory management

activities on your behalf.

Given a factory implementation, such as our `ObjectFactory`, we must inform the Ice run time of the existence of the factory:

Objective-C

```
id<ICECommunicator> ice = ...;
ObjectFactory *factory = [[[ObjectFactory alloc] init] autorelease];
[ic addObjectFactory:factory sliceId:@"::Example::TimeOfDay"];
```

Now, whenever the Ice run time needs to instantiate a class with the type ID `"::Example::TimeOfDay"`, it calls the `create` method of the registered `ObjectFactory` instance.

The `destroy` operation of the object factory is invoked by the Ice run time when the communicator is destroyed. This gives you a chance to clean up any resources that may be used by your factory. Do not call `destroy` on the factory while it is registered with the communicator — if you do, the Ice run time has no idea that this has happened and, depending on what your `destroy` implementation is doing, may cause undefined behavior when the Ice run time tries to next use the factory.

The run time guarantees that `destroy` will be the last call made on the factory, that is, `create` will not be called concurrently with `destroy`, and `create` will not be called once `destroy` has been called. However, the Ice run time may make concurrent calls to `create`.

Note that you cannot register a factory for the same type ID twice: if you call `addObjectFactory` with a type ID for which a factory is registered, the Ice run time throws an `AlreadyRegisteredException`.

Finally, keep in mind that if a class has only data members, but no operations, you need not (but can) create and register an object factory to transmit instances of such a class. Only if a class has operations do you have to define and register an object factory.

Using a Category to Implement Operations in Objective-C

An alternative to registering a class factory is to use an Objective-C category to implement operations. For example, we could have implemented our `format` method using a category instead:

Objective-C

```
@interface EXTimeOfDay (TimeOfDayI)
@end

@implementation EXTimeOfDay (TimeOfDayI)
-(NSString *) format
{
    return [NSString stringWithFormat:@"%%.2d:%.2d:%.2d",
self.hour, self.minute, self.second];
}
@end
```

In this case, there is no need to derive from the generated `EXTimeOfDay` class because we provide the `format` implementation as a category. There is also no need to register a class factory: the Ice run time instantiates an `EXTimeOfDay` instance when a `TimeOfDay` instance arrives over the wire, and the `format` method is found at run time when it is actually called.

This is a viable alternative approach to implement class operations. However, keep in mind that, if the operation implementation requires use of instance variables that are not defined as part of the Slice definitions of a class, you cannot use this approach because Objective-C categories do not permit you to add instance variables to a class.

Copying of Classes in Objective-C

Classes implement `NSCopying`. The behavior is the same as for structures: instance variables of value type are copied by assignment, instance variables of pointer type are copied by calling `retain`, that is, the copy is shallow. To illustrate this, consider the following class definition:

```
Slice
```

```
class Node {
    int i;
    string s;
    Node next;
};
```

We can initialize two instances of type `EXNode` as follows:

```
Objective-C
```

```
NSString lastString = [NSString stringWithString:@"last"];
EXNode *last = [EXNode node:99 s:lastString next:nil];

NSString firstString = [NSString stringWithString:@"first"];
EXNode *first = [EXNode node:1 s:firstString next:last];
```

This creates the situation shown below:

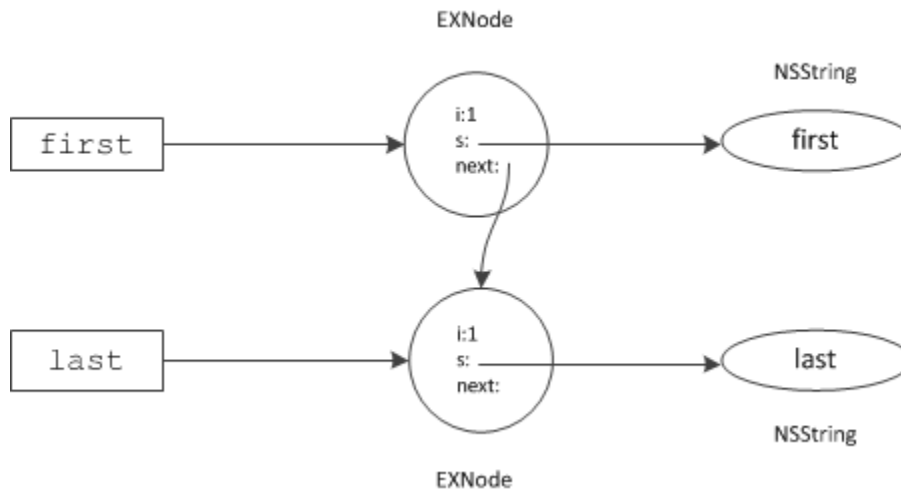

Two instances of type `EXNode`.

Now we create a copy of the first node by calling `copy`:

```
Objective-C
```

```
EXNode *copy = [[first copy] autorelease];
```

This creates the situation shown here:

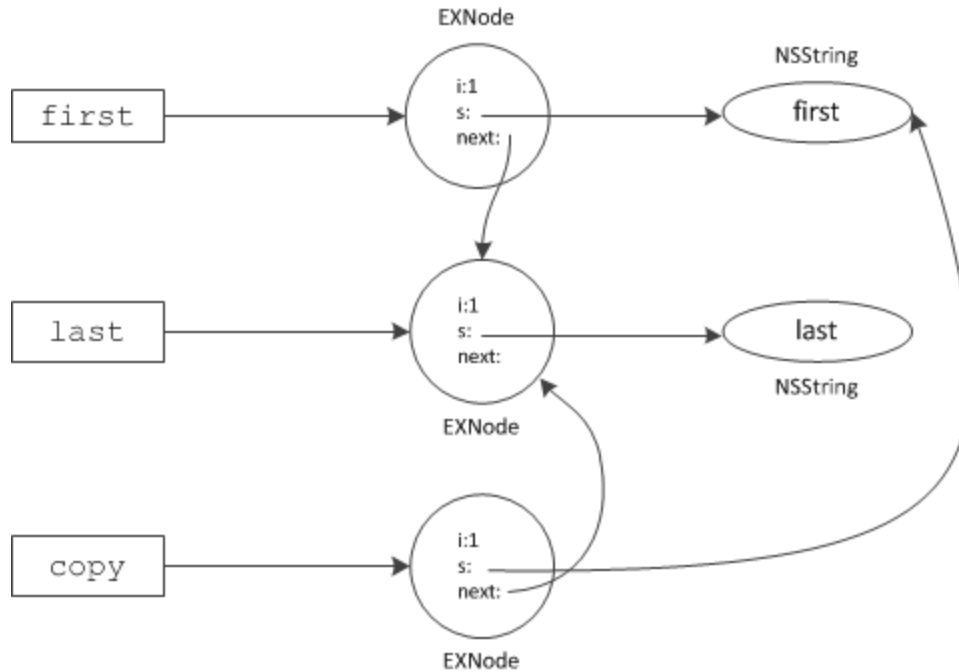

EXNode instances after calling copy on first.

As you can see, the first node is copied, but the last node (pointed at by the `next` instance variable of the first node) is not copied; instead, `first` and `copy` now both have their `next` instance variable point at the same last node, and both point at the same string.

Cyclic References in Objective-C

One thing to be aware of are cyclic references among classes. As an example, we can easily create a cycle by executing the following statements:

```
Objective-C
EXNode *first = [EXNode node];
EXNode *last = [EXNode node];
first.next = last;
last.next = first;
```

This makes the `next` instance variable of the two classes point at each other, creating the cycle shown below:

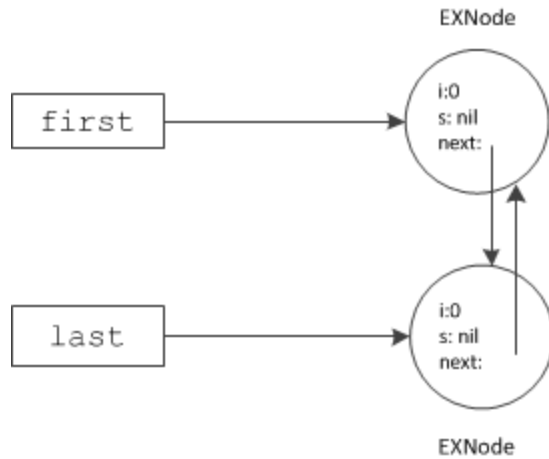

Two nodes with cyclic references.

There is no problem with sending this class graph as a parameter. For example, you could pass either `first` or `last` as a parameter to an operation and, in the server, the Ice run time will faithfully rebuild the corresponding graph, preserving the cycle. However, if a server returns such a graph from an operation invocation as the return value or as an out-parameter, all class instances that are part of a cycle are leaked. The same is true on the client side: if you receive such a graph from an operation invocation and do not explicitly break the cycle, you will leak all instances that form part of the cycle.

Because it is difficult to break cycles manually (and, on the server side, for return values and out-parameters, it is impossible to break them), we recommend that you avoid cyclic references among classes.

 A future version of the Objective-C run time may provide a garbage collector similar to the one used by Ice for C++.

See Also

- [Simple Classes](#)
- [Objective-C Mapping for Classes\]](#)
- [Server-Side Objective-C Mapping for Interfaces](#)
- [Parameter Passing in Objective-C](#)
- [Dispatch Interceptors](#)

Objective-C Mapping for Interfaces by Value

Slice permits you to pass an [interface by value](#):

Slice
<pre>interface ClassBase { void someOp(); // ... }; interface Processor { ClassBase process(ClassBase b); }; class SomeClass implements ClassBase { // ... };</pre>

Note that `process` accepts and returns a value of type `ClassBase`. This is *not* the same as passing `id<ClassBasePrx>`, which is a *proxy* to an object of type `ClassBase` that is possibly remote. Instead, what is passed here is an *interface*, and the interface is passed by *value*.

The immediate question is "what does this mean?" After all, interfaces are abstract and, therefore, it is impossible to pass an interface by value. The answer is that, while an interface cannot be passed, what *can* be passed is a class that implements the interface. That class is type-compatible with the formal parameter type and, therefore, can be passed by value. In the preceding example, `SomeClass` implements `ClassBase` and, hence, can be passed to and returned from the `process` operation.

The Objective-C mapping maps interface-by-value parameters to `ICEObject*`, regardless of the type of the interface. For example, the proxy protocol for the `process` operation is:

Objective-C
<pre>-(ICEObject *) process:(ICEObject *)b;</pre>

This means that you can pass a class of any type to the operation, even if it is not type-compatible with the formal parameter type, because all classes derive from `ICEObject`. However, an invocation of `process` is still type-safe at run time: the Ice run time verifies that the class instance that is passed implements the specified interface; if not, the invocation throws an `ICEMarshalException`.

Passing interfaces by value as `ICEObject*` is a consequence of the decision to not generate a formal protocol for classes. (If such a protocol would exist, the formal parameter type could be `id<ProtocolName>`. However, as we described for the [class mapping](#), a protocol would require the implementation of a class to implement all of its operations, which can be inconvenient. Because it is rare to pass interfaces by value (more often, the formal parameter type will be a base *class* instead of a base *interface*), the minor loss of static type safety is an acceptable trade-off.

See Also

- [Passing Interfaces by Value](#)
- [Objective-C Mapping for Classes](#)

Objective-C Mapping for Optional Data Members

The Objective-C mapping for [optional data members](#) in Slice classes and [exceptions](#) adds an extra boolean instance variable as well as two selectors for testing if the optional is set and clearing its value. The argument for the optional data member in the convenience constructor is mapped according to the [optional parameter mapping](#) for Slice operations. Consider the following Slice definition:

Slice
<pre>class C { string name; optional(2) string alternateName; optional(5) bool active; };</pre>

The generated Objective-C code provides the following API:

Objective-C
<pre>@interface testC : ICEObject { NSString *name; NSString *alternateName; BOOL has_alternateName__; BOOL active; BOOL has_active__; } @property(nonatomic, ICE_STRONG_ATTR) NSString *name; @property(nonatomic, ICE_STRONG_ATTR) NSString *alternateName; @property(nonatomic, assign) BOOL active; -(id) init:(NSString*)name alternateName:(id)alternateName active:(id)active; +(id) c:(NSString*)name alternateName:(id)alternateName active:(id)active; +(id) c; -(void)setAlternateName:(NSString*)alternateName_p; -(BOOL)hasAlternateName; -(void)clearAlternateName; -(void)setActive:(BOOL)active_p; -(BOOL)hasActive; -(void)clearActive; @end</pre>

Note that calling a `get` method or accessing the property when the value is not currently set returns an undefined value.

See Also

- [Optional Data Members](#)

Asynchronous Method Invocation (AMI) in Objective-C

Asynchronous Method Invocation (AMI) is the term used to describe the client-side support for the asynchronous programming model. AMI supports both oneway and twoway requests, but unlike their synchronous counterparts, AMI requests never block the calling thread. When a client issues an AMI request, the Ice run time hands the message off to the local transport buffer or, if the buffer is currently full, queues the request for later delivery. The application can then continue its activities and poll or wait for completion of the invocation, or receive a callback when the invocation completes.

AMI is transparent to the server: there is no way for the server to tell whether a client sent a request synchronously or asynchronously.

On this page:

- [Basic Asynchronous API in Objective-C](#)
 - [Proxy Methods for AMI in Objective-C](#)
 - [Exception Handling for AMI in Objective-C](#)
- [The ICEAsyncResult Protocol in Objective-C](#)
- [Polling for Completion in Objective-C](#)
- [Completion Callbacks in Objective-C](#)
- [Oneway Invocations in Objective-C](#)
- [Flow Control in Objective-C](#)
- [Batch Requests in Objective-C](#)
- [Concurrency in Objective-C](#)

Basic Asynchronous API in Objective-C

Consider the following simple Slice definition:

Slice
<pre> module Demo { interface Employees { string getName(int number); }; }; </pre>

Proxy Methods for AMI in Objective-C

Besides the synchronous proxy methods, the Objective-C mapping generates the following asynchronous proxy methods:

Objective-C

```

-(id<ICEAsyncResult>) begin_getName:(ICEInt)number;

-(id<ICEAsyncResult>) begin_getName:(ICEInt)number
context:(ICEContext *)context;

-(id<ICEAsyncResult>) begin_getName:(ICEInt)number
response:(void(^)(NSMutableString*))response_
exception:(void(^)(ICEException*))exception_;

-(id<ICEAsyncResult>) begin_getName:(ICEInt)number
context:(ICEContext *)context
response:(void(^)(NSMutableString*))response_
exception:(void(^)(ICEException*))exception_;

-(id<ICEAsyncResult>) begin_getName:(ICEInt)number
response:(void(^)(NSMutableString*))response_
exception:(void(^)(ICEException*))exception_
sent:(void(^)(BOOL))sent_;

-(id<ICEAsyncResult>) begin_getName:(ICEInt)number
context:(ICEContext *)context
response:(void(^)(NSMutableString*))response_
exception:(void(^)(ICEException*))exception_
sent:(void(^)(BOOL))sent_;

-(NSMutableString *) end_getName:(id<ICEAsyncResult>)result;

```

As you can see, the single `getName` operation results in several `begin_getName` methods as well as an `end_getName` method. The `begin_` methods optionally accept a [per-invocation context](#) and [callbacks](#).

- The `begin_getName` methods send (or queue) an invocation of `getName`. These methods do not block the calling thread.
- The `end_getName` method collects the result of the asynchronous invocation. If, at the time the calling thread calls `end_getName`, the result is not yet available, the calling thread blocks until the invocation completes. Otherwise, if the invocation completed some time before the call to `end_getName`, the method returns immediately with the result.

A client could call these methods as follows:

Objective-C

```

id<EXEmployeesPrx> e = [EXEmployeesPrx checkedCast:...];
id<ICEAsyncResult> r = [e begin_getName:99]

// Continue to do other things here...

NSString* name = [e end_getName:r];

```

Because `begin_getName` does not block, the calling thread can do other things while the operation is in progress.

Note that `begin_getName` returns a value of type `id<ICEAsyncResult>`. This value contains the state that the Ice run time requires to keep track of the asynchronous invocation. You must pass the `id<ICEAsyncResult>` that is returned by the `begin_` method to the corresponding `end_` method.

The `begin_` method has one parameter for each in-parameter of the corresponding Slice operation. The `end_` method accepts the `id<ICEAsyncResult>` object as its only argument and returns the out-parameters using the *same semantics* as for regular synchronous invocations. For example, consider the following operation:

```
Slice  
double op(int inp1, string inp2, out bool outp1, out long outp2);
```

The `begin_op` and `end_op` methods have the following signature:

```
Objective-C  
-(id<ICEAsyncResult>) begin_op:(ICEInt)inp1 inp2:(NSString *)inp2;  
-(ICEDouble) end_op:(BOOL*)outp1 outp2:(ICELong*)outp2  
result:(id<ICEAsyncResult>)result;
```

The call to `end_op` returns the out-parameters as follows:

```
Objective-C  
BOOL outp1;  
ICELong outp2;  
ICEDouble doubleValue = [p end_op:&outp1 outp2:&outp2 result:result];
```

Exception Handling for AMI in Objective-C

If an invocation raises an exception, the exception is thrown by the `end_` method, even if the actual error condition for the exception was encountered during the `begin_` method ("on the way out"). The advantage of this behavior is that all exception handling is located with the code that calls the `end_` method (instead of being present twice, once where the `begin_` method is called, and again where the `end_` method is called).

There is one exception to the above rule: if you destroy the communicator and then make an asynchronous invocation, the `begin_` method throws `ICECommunicatorDestroyedException`. This is necessary because, once the run time is finalized, it can no longer throw an exception from the `end_` method.

The only other exception that is thrown by the `begin_` and `end_` methods is `NSException` with the `NSInvalidArgumentException` name. This exception indicates that you have used the API incorrectly. For example, the `begin_` method throws this exception if you call an operation that has a return value or out-parameters on a oneway proxy. Similarly, the `end_` method throws this exception if you use a different proxy to call the `end_` method than the proxy you used to call the `begin_` method, or if the `id<ICEAsyncResult>` you pass to the `end_` method was obtained by calling the `begin_` method for a different operation.

The `ICEAsyncResult` Protocol in Objective-C

The `id<ICEAsyncResult>` that is returned by the `begin_` method encapsulates the state of the asynchronous invocation:

Objective-C

```

@protocol ICEAsyncResult <NSObject>
-(id<ICECommunicator>) getCommunicator;
-(id<ICEConnection>) getConnection;
-(id<ICEObjectPrx>) getProxy;

-(BOOL) isCompleted;
-(void) waitForCompleted;

-(BOOL) isSent;
-(void) waitForSent;

-(BOOL) sentSynchronously;
-(NSString*) getOperation;
@end

```

The methods have the following semantics:

- `getCommunicator`
This method returns the communicator that sent the invocation.
- `getConnection`
This method returns the connection that was used for the invocation. Note that, for typical asynchronous proxy invocations, this method returns a nil value because the possibility of automatic retries means the connection that is currently in use could change unexpectedly. The `getConnection` method only returns a non-nil value when the `ICEAsyncResult` is obtained by calling `begin_flushBatchRequests` on a `Connection` object.
- `getProxy`
This method returns the proxy that was used to call the `begin_` method, or nil if the `ICEAsyncResult` was not obtained via an asynchronous proxy invocation.
- `getOperation`
This method returns the name of the operation.
- `isCompleted`
This method returns true if, at the time it is called, the result of an invocation is available, indicating that a call to the `end_` method will not block the caller. Otherwise, if the result is not yet available, the method returns false.
- `waitForCompleted`
This method blocks the caller until the result of an invocation becomes available.
- `isSent`
When you call the `begin_` method, the Ice run time attempts to write the corresponding request to the client-side transport. If the transport cannot accept the request, the Ice run time queues the request for later transmission. `isSent` returns true if, at the time it is called, the request has been written to the local transport (whether it was initially queued or not). Otherwise, if the request is still queued, `isSent` returns false.
- `waitForSent`
This method blocks the calling thread until a request has been written to the client-side transport.
- `sentSynchronously`
This method returns true if a request was written to the client-side transport without first being queued. If the request was initially queued, `sentSynchronously` returns false (independent of whether the request is still in the queue or has since been written to the client-side transport).

Polling for Completion in Objective-C

The `ICEAsyncResult` methods allow you to poll for call completion. Polling is useful in a variety of cases. As an example, consider the following simple interface to transfer files from client to server:

Slice
<pre>interface FileTransfer { void send(int offset, ByteSeq bytes); };</pre>

The client repeatedly calls `send` to send a chunk of the file, indicating at which `offset` in the file the chunk belongs. A naïve way to transmit a file would be along the following lines:

Objective-C
<pre>NSInputStream* stream = ... id<EXFileTransferPrx> ft = [EXFileTransferPrx checkedCast:...]; int chunkSize = ...; int offset = 0; while([stream hasBytesAvailable]) { char bytes[chunkSize]; int l = [stream read:bytes maxLength:sizeof(bytes)]; if(l > 0) { [ft send:offset bytes:[ByteSeq dataWithBytes:bytes length:l]]; offset += l; } }</pre>

This works, but not very well: because the client makes synchronous calls, it writes each chunk on the wire and then waits for the server to receive the data, process it, and return a reply before writing the next chunk. This means that both client and server spend much of their time doing nothing — the client does nothing while the server processes the data, and the server does nothing while it waits for the client to send the next chunk.

Using asynchronous calls, we can improve on this considerably:

Objective-C

```

NSInputStream* stream = ...
id<EXFileTransferPrx> ft = [EXFileTransferPrx checkedCast:...];
int chunkSize = ...;
int offset = 0;
NSMutableArray* results = [NSMutableArray arrayWithCapacity:5];
int numRequests = 5;
while([stream hasBytesAvailable])
{
    char bytes[chunkSize];
    int l = [stream read:bytes maxLength:sizeof(bytes)];
    if(l > 0)
    {
        // Send up to numRequests + 1 chunks asynchronously.
        id<ICEAsyncResult> r =
            [ft begin_send:offset bytes:[ByteSeq dataWithBytes:bytes
length:l]];
        offset += l;

        // Wait until this request has been passed to the
        // transport.
        [r waitForSent];
        [results addObject:r];

        // Once there are more than numRequests, wait for the
        // least recent one to complete.
        while([results count] > numRequests)
        {
            r = [results objectAtIndex:0];
            [results removeObjectAtIndex:0];
            [r waitForCompleted];
        }
    }
}

// Wait for any remaining requests to complete.
for(id<ICEAsyncResult> r in results)
{
    [r waitForCompleted];
}

```

With this code, the client sends up to `numRequests + 1` chunks before it waits for the least recent one of these requests to complete. In other words, the client sends the next request without waiting for the preceding request to complete, up to the limit set by `numRequests`. In effect, this allows the client to "keep the pipe to the server full of data": the client keeps sending data, so both client and server continuously do work.

Obviously, the correct chunk size and value of `numRequests` depend on the bandwidth of the network as well as the amount of time taken by the server to process each request. However, with a little testing, you can quickly zoom in on the point where making the requests larger or queuing more requests no longer improves performance. With this technique, you can realize the full bandwidth of the link to within a

percent or two of the theoretical bandwidth limit of a native socket connection.

Completion Callbacks in Objective-C

The `begin_` method accepts three optional callback arguments that allow you to be notified asynchronously when a request completes. Here is the signature of the `begin_getName` method that we saw earlier:

```

Objective-C

-(id<ICEAsyncResult>) begin_getName:(ICEInt)number
    response:(void(^)(NSMutableString*))response_
    exception:(void(^)(ICEException*))exception_;

-(id<ICEAsyncResult>) begin_getName:(ICEInt)number
    context:(ICEContext *)context
    response:(void(^)(NSMutableString*))response_
    exception:(void(^)(ICEException*))exception_;

-(id<ICEAsyncResult>) begin_getName:(ICEInt)number
    response:(void(^)(NSMutableString*))response_
    exception:(void(^)(ICEException*))exception_
    sent:(void(^)(BOOL))sent_;

-(id<ICEAsyncResult>) begin_getName:(ICEInt)number
    context:(ICEContext *)context
    response:(void(^)(NSMutableString*))response_
    exception:(void(^)(ICEException*))exception_
    sent:(void(^)(BOOL))sent_;
```

The value you pass for the response callback (`response`), the exception callback (`exception`), or the sent callback (`sent`) argument must be an Objective-C block. The response callback is invoked when the request completes successfully, and the exception callback is invoked when the operation raises an exception. (The sent callback is primarily used for [flow control](#).)

For example, consider the following callbacks for an invocation of the `getName` operation:

```

Objective-C

void(^getNameCB)(NSMutableString*) = ^(NSMutableString* name)
{
    NSLog(@"Name is: %@", name);
};

void(^failureCB)(ICEException*) = ^(ICEException* ex)
{
    NSLog(@"Exception is: %@", [ex description]);
};
```

The response callback parameters depend on the operation signature. If the operation has a non-void return type, the first parameter of the response callback is the return value. The return value (if any) is followed by a parameter for each out-parameter of the corresponding Slice operation, in the order of declaration.

The exception callback is called if the invocation fails because of an Ice run time exception, or if the operation raises a user exception.

To inform the Ice run time that you want to receive callbacks for the completion of the asynchronous call, you pass the callbacks to the `begin_` method:

```

Objective-C

e = [EmployeesPrx checkedCast:...]

[e begin_getName:99 response:getNameCB exception:failureCB];
```

You can also pass the Objective-C blocks directly to the call:

```

Objective-C

[e begin_getName:99
 response: ^(NSMutableString* name)
 {
     NSLog(@"Name is: %@", name);
 }
 exception: ^(ICEException* ex)
 {
     NSLog(@"Exception is: %@", [ex description]);
 }];
```

Ice enforces the following semantics at run time regarding which callbacks can be optionally specified with a `nil` value:

- You must supply an exception callback.
- You may omit the response callback for an operation that returns no data (that is, an operation with a void return type and no out-parameters).

Oneway Invocations in Objective-C

You can invoke operations via oneway proxies asynchronously, provided the operation has `void` return type, does not have any out-parameters, and does not raise user exceptions. If you call the `begin_` method on a oneway proxy for an operation that returns values or raises a user exception, the `begin_` method throws `NSException` with the `NSInvalidArgumentException` name.

The callback signatures look exactly as for a twoway invocation, but the response block is never called and may be `nil`.

Flow Control in Objective-C

Asynchronous method invocations never block the thread that calls the `begin_` method: the Ice run time checks to see whether it can write the request to the local transport. If it can, it does so immediately in the caller's thread. (In that case, `[ICEAsyncResult sentSynchronously]` returns `true`.) Alternatively, if the local transport does not have sufficient buffer space to accept the request, the Ice run time queues the request internally for later transmission in the background. (In that case, `[ICEAsyncResult sentSynchronously]` returns `false`.)

This creates a potential problem: if a client sends many asynchronous requests at the time the server is too busy to keep up with them, the requests pile up in the client-side run time until, eventually, the client runs out of memory.

The API provides a way for you to implement flow control by counting the number of requests that are queued so, if that number exceeds some threshold, the client stops invoking more operations until some of the queued operations have drained out of the local transport.

You can supply a sent callback to be notified when the request was successfully sent:

```

Objective-C

void(^sentCB)(BOOL) = ^(BOOL sentSynchronously)
{
    ...
}

```

You inform the Ice run time that you want to be notified when a request has been passed to the local transport as usual:

```

Objective-C

[e begin_getName:99 response:getNameCB exception:failureCB sent:sentCB];

```

If the Ice run time can immediately pass the request to the local transport, it does so and invokes the sent callback from the thread that calls the `begin_` method. On the other hand, if the run time has to queue the request, it calls the sent callback from a different thread once it has written the request to the local transport. The boolean `sentSynchronously` parameter indicates whether the request was sent synchronously or was queued.

The sent callback allows you to limit the number of queued requests by counting the number of requests that are queued and decrementing the count when the Ice run time passes a request to the local transport.

Batch Requests in Objective-C

Applications that send [batched requests](#) can either flush a batch explicitly or allow the Ice run time to flush automatically. The proxy method `ice_flushBatchRequests` performs an immediate flush using the synchronous invocation model and may block the calling thread until the entire message can be sent. Ice also provides asynchronous versions of this method so you can flush batch requests asynchronously.

`begin_ice_flushBatchRequests` and `end_ice_flushBatchRequests` are proxy methods that flush any batch requests queued by that proxy.

In addition, similar methods are available on the communicator and the `Connection` object that is returned by `[ICEAsyncResult getConnection]`. These methods flush batch requests sent via the same communicator and via the same connection, respectively.

Concurrency in Objective-C

The Ice run time always invokes your callback methods from a separate thread, with one exception: it calls the sent callback from the thread calling the `begin_` method if the request could be sent synchronously. In the sent callback, you know which thread is calling the callback by looking at the `sentSynchronously` parameter.

See Also

- [Request Contexts](#)
- [Batched Invocations](#)

slice2objc Command-Line Options

The Slice-to-Objective-C compiler, `slice2objc`, offers the following command-line options in addition to the [standard options](#):

- `--include-dir DIR`
Modifies `#import` directives in source files to prepend the path name of each header file with the directory `DIR`.
- `--output-dir DIR`
Places the generated source files into the specified output directory `DIR`.
- `--depend`
Prints makefile dependency information to standard output. No code is generated when this option is specified. The output generally needs to be filtered before it can be included in a makefile; the Ice build system uses the script `config/makedepend.py` for this purpose.
- `--depend-xml`
Prints dependency information to standard output in XML format. No code is generated when this option is specified. This option is intended for use with Apple's Xcode development environment.

See Also

- [Using the Slice Compilers](#)

Example of a File System Client in Objective-C

This page presents a very simple client to access a server that implements the file system we developed in [Slice for a Simple File System](#). The Objective-C code shown here hardly differs from the code you would write for an ordinary Objective-C program. This is one of the biggest advantages of using Ice: accessing a remote object is as easy as accessing an ordinary, local Objective-C object. This allows you to put your effort where you should, namely, into developing your application logic instead of having to struggle with arcane networking APIs. This is true for the [server side](#) as well, meaning that you can develop distributed applications easily and efficiently.

We now have seen enough of the client-side Objective-C mapping to develop a complete client to access our remote file system. For reference, here is the Slice definition once more:

Slice
<pre>["objc:prefix:FS"] module Filesystem { exception GenericError { string reason; }; interface Node { idempotent string name(); }; sequence<string> Lines; interface File extends Node { idempotent Lines read(); idempotent void write(Lines text) throws GenericError; }; sequence<Node*> NodeSeq; interface Directory extends Node { idempotent NodeSeq list(); }; };</pre>

To exercise the file system, the client does a recursive listing of the file system, starting at the root directory. For each node in the file system, the client shows the name of the node and whether that node is a file or directory. If the node is a file, the client retrieves the contents of the file and prints them.

The body of the client code looks as follows:

Objective-C
Objective-C code content would go here

```

#import <Ice/Ice.h>
#import <Filesystem.h>

#import <Foundation/NSAutoreleasePool.h>
#import <stdio.h>

static void
listRecursive(id<FSDirectoryPrx> dir, int depth)
{
    // ...
}

int
main(int argc, char* argv[])
{
    NSAutoreleasePool * pool = [[NSAutoreleasePool alloc] init];
    int status = 1;
    id<ICECommunicator> communicator;
    @try
    {
        communicator = [ICEUtil createCommunicator:&argc argv:argv];

        // Create a proxy for the root directory
        //
        id<FSDirectoryPrx> rootDir = [FSDirectoryPrx checkedCast:
            [communicator stringToProxy:
@"RootDir:default -p 10000"]];
        if (!rootDir)
            [NSException raise:@"invalid proxy" format:@"nil"];

        // Recursively list the contents of the root directory
        //
        printf("Contents of root directory:\n");
        listRecursive(rootDir, 0);

        status = 0;
    } @catch (NSException *ex) {
        NSLog(@"%@ \n", [ex name]);
    }

    @try {
        [communicator destroy];
    } @catch (NSException* ex) {
        NSLog(@"%@ \n", [ex name]);
    }

    [pool release];
    return status;
}

```

1. The code imports a few header files:
 - `Ice/Ice.h`: Always included in both client and server source files, provides definitions that are necessary for accessing the Ice run time.
 - `Filesystem.h`: The header that is generated by the Slice compiler from the Slice definitions in `Filesystem.ice`.
 - `NSAutoreleasePool.h`: The client uses an autorelease pool to reclaim memory before it exits.
 - `stdio.h`: The implementation of `listRecursive` prints to `stdout`.
2. The structure of the code in `main` follows what we saw in [Hello World Application](#). After initializing the run time, the client creates a proxy to the root directory of the file system. For this example, we assume that the server runs on the local host and listens using the default protocol (TCP/IP) at port 10000. The object identity of the root directory is known to be `RootDir`.
3. The client down-casts the proxy to `DirectoryPrx` and passes that proxy to `listRecursive`, which prints the contents of the file system.

Most of the work happens in `listRecursive`:

Objective-C

```

// Print the specified number of tabs.

static void
printIndent(int depth)
{
    while (depth-- > 0)
        putchar('\t');
}

// Recursively print the contents of directory "dir" in tree
// fashion.  For files, show the contents of each file.
// The "depth" parameter is the current nesting level
// (for indentation).

static void
listRecursive(id<FSDirectoryPrx> dir, int depth)
{
    ++depth;
    FSNodeSeq *contents = [dir list];

    for (id<FSNodePrx> node in contents) {
        id<FSDirectoryPrx> dir = [FSDirectoryPrx checkedCast:node];
        id<FSFilePrx> file = [FSFilePrx uncheckedCast:node];
        printIndent(depth);
        printf("%s%s\n", [[node name] UTF8String],
            (dir ? " (directory):" : " (file):"));
        if (dir) {
            listRecursive(dir, depth);
        } else {
            FSLines *text = [file read];
            for (NSString *line in text) {
                printIndent(depth);
                printf("\t%s\n", [line UTF8String]);
            }
        }
    }
}

```

The function is passed a proxy to a directory to list, and an indent level. (The indent level increments with each recursive call and allows the code to print the name of each node at an indent level that corresponds to the depth of the tree at that node.) `listRecursive` calls the `list` operation on the directory and iterates over the returned sequence of nodes:

1. The code does a `checkedCast` to narrow the `Node` proxy to a `Directory` proxy, as well as an `uncheckedCast` to narrow the `Node` proxy to a `File` proxy. Exactly one of those casts will succeed, so there is no need to call `checkedCast` twice: if the `Node` *is-a* `Directory`, the code uses the `id<FSDirectoryPrx>` returned by the `checkedCast`; if the `checkedCast` fails, we *know* that the `Node` *is-a* `File` and, therefore, an `uncheckedCast` is sufficient to get an `id<FSFilePrx>`.

In general, if you know that a down-cast to a specific type will succeed, it is preferable to use an `uncheckedCast` instead of a `checkedCast` because an `uncheckedCast` does not incur any network traffic.

2. The code prints the name of the file or directory and then, depending on which cast succeeded, prints "(directory)" or "(file)" following the name.
3. The code checks the type of the node:
 - If it is a directory, the code recurses, incrementing the indent level.
 - If it is a file, the code calls the `read` operation on the file to retrieve the file contents and then iterates over the returned sequence of lines, printing each line.

Assume that we have a small file system consisting of two files and a directory as follows:

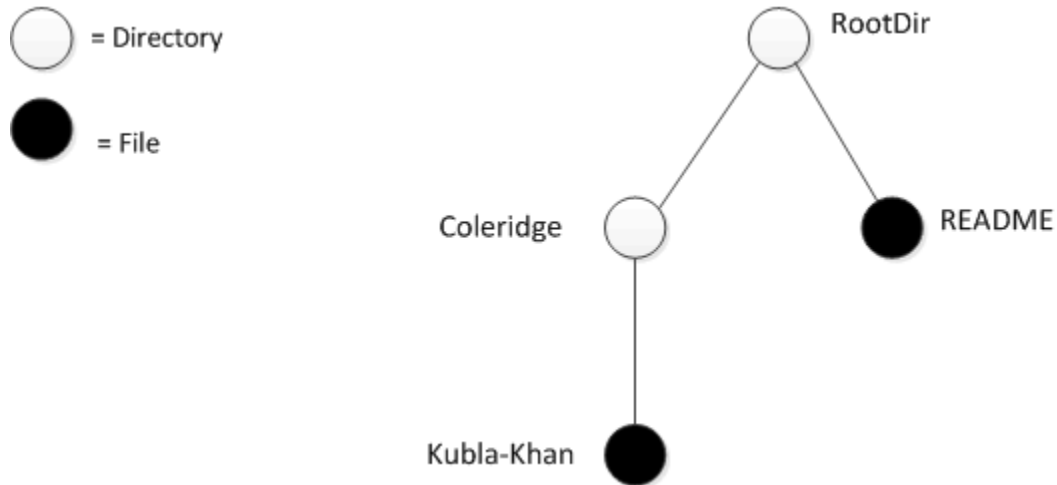

A small file system.

The output produced by the client for this file system is:

```

Contents of root directory:
  README (file):
    This file system contains a collection of poetry.
  Coleridge (directory):
    Kubla_Khan (file):
      In Xanadu did Kubla Khan
      A stately pleasure-dome decree:
      Where Alph, the sacred river, ran
      Through caverns measureless to man
      Down to a sunless sea.
  
```

Note that, so far, our client (and server) are not very sophisticated:

- The protocol and address information are hard-wired into the code.
- The client makes more remote procedure calls than strictly necessary; with minor redesign of the Slice definitions, many of these calls can be avoided.

We will see how to address these shortcomings in our discussions of [IceGrid](#) and [object life cycle](#).

See Also

- [Hello World Application](#)
- [Slice for a Simple File System](#)
- [Example of a File System Server in Objective-C](#)
- [Object Life Cycle](#)
- [IceGrid](#)

Server-Side Slice-to-Objective-C Mapping

The mapping for Slice data types to Objective-C is identical on the client side and server side, except for operation parameters, which map slightly differently for types that have mutable and immutable variants (strings, sequence, and dictionaries). This means that the mappings in the [Client-Side Slice-to-Objective-C Mapping](#) also apply to the server side. However, for the server side, there are a few additional things you need to know — specifically, how to:

- Initialize and finalize the server-side run time
- Implement servants
- Pass parameters and throw exceptions
- Create servants and register them with the Ice run time.

Although the examples we present are very simple, they accurately reflect the basics of writing an Ice server. Of course, for more sophisticated servers, you will be using [additional APIs](#), for example, to improve performance or scalability. However, these APIs are all described in Slice, so, to use these APIs, you need not learn any Objective-C mapping rules beyond those described here.

Topics

- [The Server-Side main Function in Objective-C](#)
- [Server-Side Objective-C Mapping for Interfaces](#)
- [Parameter Passing in Objective-C](#)
- [Raising Exceptions in Objective-C](#)
- [Object Incarnation in Objective-C](#)
- [Example of a File System Server in Objective-C](#)

The Server-Side main Function in Objective-C

This page discusses how to initialize and finalize the server-side run time.

On this page:

- [Initializing and Finalizing the Server-Side Run Time](#)
- [Alternative Ways to Create a Communicator in Objective-C](#)

Initializing and Finalizing the Server-Side Run Time

The main entry point to the Ice run time is represented by the local interface `ICECommunicator`. As for the client side, you must initialize the Ice run time by calling `createCommunicator` (a class method of the `ICEUtil` class) before you can do anything else in your server. `createCommunicator` returns an instance of type `id<ICECommunicator>`:

Objective-C

```

int
main(int argc, char* argv[])
{
    // ...
    id<ICECommunicator> communicator =
    [ICEUtil createCommunicator:&argc argv:argv];
    // ...
}

```

`createCommunicator` accepts a *pointer* to `argc` as well as `argv`. The class method scans the argument vector for any **command-line options** that are relevant to the Ice run time; any such options are removed from the argument vector so, when `createCommunicator` returns, the only options and arguments remaining are those that concern your application. If anything goes wrong during initialization, `createCommunicator` throws an exception.

Before leaving your `main` function, you *must* call `Communicator::destroy`. The `destroy` operation is responsible for finalizing the Ice run time. In particular, `destroy` waits for any operation implementations that are still executing in the server to complete. In addition, `destroy` ensures that any outstanding threads are joined with and reclaims a number of operating system resources, such as file descriptors and memory. Never allow your `main` function to terminate without calling `destroy` first; doing so has undefined behavior.

The general shape of our server-side `main` function is therefore as follows:

Objective-C

```

#import <Ice/Ice.h>

int
main(int argc, char* argv[])
{
    NSAutoreleasePool * pool = [[NSAutoreleasePool alloc] init];

    int status = 1;
    id<ICECommunicator> communicator = nil;
    @try {
        communicator = [ICEUtil createCommunicator:&argc argv:argv];

        // Server code here...

        status = 0;
    } @catch (NSEException* ex) {
        NSLog(@"%@", ex);
    }

    @try {
        [communicator destroy];
    } @catch (NSEException* ex) {
        NSLog(@"%@", ex);
    }

    [pool release];
    return status;
}

```

Note that the code places the call to `createCommunicator` into a `try` block and takes care to return the correct exit status to the operating system. Also note that the code creates and releases an autorelease pool. This ensures that memory will be released before the program terminates.

The `catch` handler for `NSEException` ensures that the communicator is destroyed regardless of whether the program terminates normally or due to an exception.

You must *not* release the communicator that is returned by `createCommunicator`. As for any operation that returns a pointer, the Ice run time calls `autorelease` on the returned instance, so you do not have to release it yourself.



This is also the reason why `createCommunicator` is not called `initialize` (as it is for other language mappings) — `initialize` would suggest that the return value must be released because the method name begins with `init`.

Alternative Ways to Create a Communicator in Objective-C

`createCommunicator` is provided in several versions that accept different arguments. Here is the complete list:

- `(id<ICECommunicator>) createCommunicator: (int*)argc argv:(char*[])argv initData:(ICEInitializationData*)initData;`

This is the designated initializer — the remaining versions of `createCommunicator` are implemented in terms of this initializer. As for the version we saw in the preceding section, this version accepts a pointer to `argc` as well as `argv` and removes Ice-related [command-line options](#) from the argument vector. The `initData` argument allows you to pass additional initialization information to the Ice run time (see below).

- `+(id<ICECommunicator>) createCommunicator;`
This is equivalent to calling:
`[ICEUtil createCommunicator:nil argv:nil initData:nil];`
- `+(id<ICECommunicator>) createCommunicator: (int*)argc argv:(char*[])argv;`
This is equivalent to calling
`[ICEUtil createCommunicator:&argc argv:argv initData:nil];`
- `+(id<ICECommunicator>) createCommunicator: (ICEInitializationData*)initData`
This is equivalent to calling
`[ICEUtil createCommunicator:nil argv:nil initData:initData];`

The `initData` argument is of type `ICEInitializationData`. Even though it has no Slice definition, this class behaves as if it were a Slice structure with the following definition:

Slice

```
#include <Properties.ice>
#include <Logger.ice>

["objc:prefix:ICE"]
module Ice {
    dictionary<string, string> PrefixDict;

    local struct InitializationData {
        Ice::Properties properties;
        Ice::Logger logger;
    };
};
```

The `properties` member allows you to explicitly set [property values](#) for the communicator to be created. This is useful, for example, if you want to ensure that a particular property setting is always used by the communicator.

The `logger` member sets the [logger](#) that the Ice run time uses to log messages. If you do not set a logger (leaving the `logger` member as `nil`), the run time installs a default logger that calls `NSLog` to log messages.

See Also

- [Communicator Initialization](#)
- [Properties and Configuration](#)
- [Logger Facility](#)

Server-Side Objective-C Mapping for Interfaces

The server-side mapping for interfaces provides an up-call API for the Ice run time: by implementing methods in a servant class, you provide the hook that gets the thread of control from the Ice server-side run time into your application code.

On this page:

- [Skeleton Classes in Objective-C](#)
- [Servant Classes in Objective-C](#)
 - [Derived Servants in Objective-C](#)
 - [Delegate Servants in Objective-C](#)

Skeleton Classes in Objective-C

On the client side, interfaces map to [proxy protocols and classes](#). On the server side, interfaces map to *skeleton* protocols and classes. A skeleton is a class that has a method for each operation on the corresponding interface. For example, consider our [Slice definition](#) for the `Node` interface:

Slice
<pre>["objc:prefix:FS"] module Filesystem { interface Node { idempotent string name(); }; // ... };</pre>

The Slice compiler generates the following definition for this interface:

Objective-C
<pre>@protocol FSNode <ICEObject> -(NSString *) name:(ICECurrent *)current; @end @interface FSNode : ICEObject // ... @end</pre>

As you can see, the server-side API consists of a protocol and a class, known as the *skeleton protocol* and *skeleton class*. The methods of the skeleton class are internal to the mapping, so they do not concern us here. The skeleton protocol defines one method for each Slice operation. As for the client-side mapping, the method name is the same as the name of the corresponding Slice operation. If the Slice operation has parameters or a return value, these are reflected in the generated method, just as they are for the client-side mapping. In addition, each method has an additional trailing parameter of type `ICECurrent`. This parameter provides additional information about an invocation to your server-side code.

As for the client-side mapping, the generated code reflects the fact that all Slice interfaces and classes ultimately derive from `Ice::Object`. As you can see, the generated protocol incorporates the `ICEObject` protocol, and the generated class derives from the `ICEObject` class.

Servant Classes in Objective-C

The Objective-C mapping supports two different ways to implement servants. You can implement a servant by deriving from the skeleton class and implementing the methods for the Slice operations in your derived class. Alternatively, you can use a delegate servant, which need not derive from the skeleton class.

Derived Servants in Objective-C

To provide an implementation for an Ice object, you can create a servant class that derives from the corresponding skeleton class. For example, to create a servant for the `Node` interface, you could write:

```

Objective-C

@interface NodeI : FSNode <FSNode>
{
    @private
    NSString *myName;
}

+(id) nodei:(NSString *)name;
@end
```

By convention, servant classes have the name of their interface with an `I`-suffix, so the servant class for the `Node` interface is called `NodeI`. (This is a convention only: as far as the Ice run time is concerned, you can choose any name you prefer for your servant classes.)

Note that `NodeI` derives from `FSNode`, that is, it derives from its skeleton class. In addition, it adopts the `FSNode` protocol. Adopting the protocol is not strictly necessary; however, if you do write your servants this way, the compiler emits a warning if you forget to implement one or more Slice operations for the corresponding interface, so we suggest that you make it a habit to always have your servant class adopt its skeleton protocol.

As far as Ice is concerned, the `NodeI` class must implement the single `name` method that is defined by its skeleton protocol. That way, the Ice run time gets a servant that can respond to the operation that is defined by its Slice interface. You can add other methods and instance variables as you see fit to support your implementation. For example, in the preceding definition, we added a `myName` instance variable and property, a convenience constructor, and `dealloc`. Not surprisingly, the convenience constructor initializes the `myName` instance variable, the `name` method returns the value of that variable, and `dealloc` releases it.

Objective-C

```

@implementation NodeI

+(id) nodei:(NSString *)name
{
    NodeI *instance = [[[NodeI alloc] init] autorelease];
    instance.myName = [[name copy] retain];
    return instance;
}

-(NSString *) name:(ICECurrent *)current
{
    return myName;
}

-(void) dealloc
{
    [myName release];
    [super dealloc];
}
@end

```

Delegate Servants in Objective-C

An alternate way to implement a servant is to use a delegate. `ICEObject` provides two constructors to do this:

Objective-C

```

@interface ICEObject NSObject <ICEObject, NSCopying>
// ...
-(id) initWithDelegate:(id)delegate;
+(id) objectWithDelegate:(id)delegate;
@end

```

The `delegate` parameter specifies an object to which the servant will delegate operation invocations. That object need not derive from the skeleton class; the only requirement on the delegate is that it must have an implementation of the methods corresponding to the Slice operations that are called by clients. As for derived servants, we suggest that the delegate adopt the skeleton protocol, so the compiler will emit a warning if you forget to implement one or more Slice operations in the delegate.

The implementation of the Slice operations in a delegate servant is exactly the same as for a derived servant.

Delegate servants are useful if you need to derive your servant implementation from a base class in order to access some functionality. In that case, you cannot also derive the servant from the generated skeleton class. A delegate servant gets around Objective-C's single inheritance limitation and saves you having to write a servant class that forwards each operation invocation to the delegate.

Another use case are different interfaces that share their implementation. As an example, consider the following Slice definitions:

Slice

```
interface Intf1 {
    void op1();
};

interface Intf2 {
    void op2();
};
```

If `op1` and `op2` are substantially similar in their implementation and share common state, it can be convenient to implement the servants for `Intf1` and `Intf2` using a common delegate class:

Objective-C

```
@interface Intf1AndIntf2 : NSObject<EXIntf1, EXIntf2>
    +(id) intf1AndIntf2;
@end

@implementation Intf1AndIntf2
    +(id) intf1AndIntf2 { /*...*/ }
    -(void) op1:(ICECurrent*)current { /*...*/ }
    -(void) op2:(ICECurrent*)current { /*...*/ }
@end
```

See [Instantiating an Objective-C Servant](#) for an example of how to instantiate delegate servants.

Delegate servants do not permit you to override operations that are inherited from `ICEObject` (such as `ice_ping`). Therefore, if you want to override `ice_ping`, for example, to implement a [default servant](#), you must use a derived servant.

See Also

- [Slice for a Simple File System](#)
- [Objective-C Mapping for Interfaces](#)
- [Parameter Passing in Objective-C](#)
- [Object Incarnation in Objective-C](#)
- [The Current Object](#)
- [Default Servants](#)

Parameter Passing in Objective-C

This page shows how to implement parameters for Slice operations in Objective-C.

On this page:

- [Implementing Parameters for Slice Operations in Objective-C](#)
- [Memory Management for Operations in Objective-C](#)

Implementing Parameters for Slice Operations in Objective-C

For each parameter of a Slice operation, the Objective-C mapping generates a corresponding parameter for the method in the skeleton. In addition, every method has an additional, trailing parameter of type `ICECurrent`. For example, the `name` operation of the `Node` interface has no parameters, but the `name` method of the `Node` skeleton protocol has a single parameter of type `ICECurrent`. We will ignore this parameter for now.

Parameter passing on the server side follows the rules for the client side (with one exception):

- In-parameters and the return value are passed by value or by pointer, depending on the parameter type.
- Out-parameters are passed by pointer-to-pointer.

The exception to the client-side rules concerns types that come in mutable and immutable variants (strings, sequences, and dictionaries). For these, the server-side mapping passes the mutable variant where the client-side passes the immutable variant, and vice versa.

To illustrate the rules, consider the following interface that passes string parameters in all possible directions:

```

Slice

interface Intf {
    string op(string sin, out string sout);
};

```

The generated skeleton protocol for this interface looks as follows:

```

Objective-C

@protocol EXIntf <ICEObject>
- (NSString *) op:(NSMutableString *)sin
                sout:(NSString **)sout
                current:(ICECurrent *)current;
@end

```

As you can see, the in-parameter `sin` is of type `NSMutableString`, and the out parameter and return value are passed as `NSString` (the opposite of the client-side mapping). This means that in-parameters are passed to the servant as their mutable variant, and it is safe for you to modify such in-parameters. This is useful, for example, if a client passes a sequence to the operation, and the operation returns the sequence with a few minor changes. In that case, there is no need for the operation implementation to copy the sequence. Instead, you can simply modify the passed sequence as necessary and return the modified sequence to the client.

Here is an example implementation of the operation:

Objective-C

```

-(NSString *) op:(NSMutableString *)sin
              sout:(NSString **)sout
              current:(ICECurrent *)current
{
    printf("%s\n", [sin UTF8String]); // In-params are initialized
    *sout = [sin appendString:@"appended"]; // Assign out-param
    return @"Done"; // Return a string
}

```

Memory Management for Operations in Objective-C

To avoid leaking memory, you must be aware of how the Ice run time manages memory for operation implementations:

- In-parameters are passed to the servant already autoreleased.
- Out-parameters and return values must be returned by the servant as autoreleased values.

This follows the usual Objective-C convention: the allocator of a value is responsible for releasing it. This is what the Ice run time does for in-parameters, and what you are expected to do for out-parameters and return values. These rules also mean that it is safe to return an in-parameter as an out-parameter or return value. For example:

Objective-C

```

-(NSString *) op:(NSMutableString *)sin
              sout:(NSString **)sout
              current:(ICECurrent *)current
{
    *sout = sin; // Works fine.
    return sin; // Works fine.
}

```

The Ice run time creates and releases a separate autorelease pool for each invocation. This means that the memory for parameters is reclaimed as soon as the run time has marshaled the operation results back to the client.

See Also

- [Server-Side Objective-C Mapping for Interfaces](#)
- [Raising Exceptions in Objective-C](#)
- [The Current Object](#)

Raising Exceptions in Objective-C

To throw an exception from an operation implementation, you simply allocate the exception, initialize it, and throw it. For example:

```

Objective-C

-(void) write:(NSMutableArray *)text current:(ICECurrent *)current
{
    // Try to write the file contents here...
    // Assume we are out of space...
    if (error)
        @throw [FSGenericError genericError:@"file too large"];
}

```

As for out-parameters and return values, you must take care to throw an autoreleased exception.

If you throw an arbitrary Objective-C exception that does not derive from `ICEException`, the client receives an `UnknownException`. Similarly, if you throw an "impossible" user exception (a user exception that is not listed in the exception specification of the operation), the client receives an `UnknownUserException`.

If you throw a run-time exception, such as `MemoryLimitException`, the client receives an `UnknownLocalException`. For that reason, you should never throw system exceptions from operation implementations. If you do, all the client will see is an `UnknownLocalException`, which does not tell the client anything useful.



Three run-time exceptions are **treated specially** and not changed to `UnknownLocalException` when returned to the client: `ObjectNotExistException`, `OperationNotExistException`, and `FacetNotExistException`.

See Also

- [Run-Time Exceptions](#)
- [Objective-C Mapping for Exceptions](#)
- [Server-Side Objective-C Mapping for Interfaces](#)
- [Parameter Passing in Objective-C](#)

Object Incarnation in Objective-C

Having created a servant class such as the rudimentary `NodeI` class, you can instantiate the class to create a concrete servant that can receive invocations from a client. However, merely instantiating a servant class is insufficient to incarnate an object. Specifically, to provide an implementation of an Ice object, you must follow these steps:

1. [Instantiate a servant class.](#)
2. [Create an identity](#) for the Ice object incarnated by the servant.
3. Inform the Ice run time of the existence of the servant.
4. [Pass a proxy for the object](#) to a client so the client can reach it.

On this page:

- [Instantiating an Objective-C Servant](#)
- [Creating an Identity in Objective-C](#)
- [Activating an Objective-C Servant](#)
- [UUIDs as Identities in Objective-C](#)
- [Creating Proxies in Objective-C](#)
 - [Proxies and Servant Activation in Objective-C](#)
 - [Direct Proxy Creation in Objective-C](#)

Instantiating an Objective-C Servant

Instantiating a servant means to allocate an instance on the heap:

```

Objective-C

NodeI *servant = [NodeI nodei:@"Fred"];

```

This code creates a new `NodeI` instance. For this example, we used the convenience constructor we saw [earlier](#). Of course, you are not obliged to define such a constructor but, if you do not, you must explicitly call `release` or `autorelease` on the servant.

For a [delegate servant](#), instantiation would look as follows:

```



Objective-C

Intf1AndIntf2 *delegate = [Intf1AndIntf2 intf1AndIntf2];
ICEObject *servant = [ICEObject objectWithDelegate:delegate];

```

Creating an Identity in Objective-C

Each Ice object requires an identity. That identity must be unique for all servants using the same object adapter.

 The Ice object model assumes that all objects (regardless of their adapter) have a [globally unique identity](#).

An Ice object identity is a structure with the following Slice definition:

Slice

```
[ "objc:prefix:ICE" ]
module Ice {
    struct Identity {
        string name;
        string category;
    };
    // ...
};
```

The full identity of an object is the combination of both the `name` and `category` fields of the `Identity` structure. For now, we will leave the `category` field as the empty string and simply use the `name` field. (The `category` field is most often used in conjunction with [servant locators](#).)

To create an identity, we simply assign a key that identifies the servant to the `name` field of the `Identity` structure:

Objective-C

```
ICEIdentity ident = [ICEIdentity identity:"Fred" category:nil];
```

Activating an Objective-C Servant

Merely creating a servant instance does nothing: the Ice run time becomes aware of the existence of a servant only once you explicitly tell the object adapter about the servant. To activate a servant, you invoke the `add` operation on the object adapter. Assuming that we have access to the object adapter in the `adapter` variable, we can write:

Objective-C

```
[adapter add:servant identity:ident];
```

Note the two arguments to `add`: the servant and the object identity. Calling `add` on the object adapter adds the servant and the servant's identity to the adapter's servant map and links the proxy for an Ice object to the correct servant instance in the server's memory as follows:

1. The proxy for an Ice object, apart from addressing information, contains the identity of the Ice object. When a client invokes an operation, the object identity is sent with the request to the server.
2. The object adapter receives the request, retrieves the identity, and uses the identity as an index into the servant map.
3. If a servant with that identity is active, the object adapter retrieves the servant pointer from the servant map and dispatches the incoming request into the correct method on the servant.

Assuming that the object adapter is in the `active` state, client requests are dispatched to the servant as soon as you call `add`.

Putting the preceding points together, we can write a simple method that instantiates and activates one of our `NodeI` servants. For this example, we use a simple method on our servant called `activate` that activates a servant in an object adapter with the passed identity:

Objective-C

```

-(void) activate:(id<ICEObjectAdapter>)a
           name:(NSString *)name
{
    ICEIdentity ident = [ICEIdentity identity:name category:nil];
    [a add:self identity:ident];
}

```

UUIDs as Identities in Objective-C

The Ice object model assumes that object identities are globally unique. One way of ensuring that uniqueness is to use UUIDs (Universally Unique Identifiers) as identities. The `ICEUtil` class contains a helper function to create such identities:

Objective-C

```

@interface ICEUtil : NSObject
+(id) generateUUID;
// ...
@end

```

When executed, this method returns a unique string such as `5029a22c-e333-4f87-86b1-cd5e0fcce509`. Each call to `generateUUID` creates a string that differs from all previous ones. You can use a UUID such as this to create object identities. For convenience, the object adapter has an operation `addWithUUID` that generates a UUID and adds a servant to the servant map in a single step:

Objective-C

```

-(id<ICEObjectPrx>) addWithUUID:(ICEObject*)servant

```

Note that the operation returns the proxy for the servant just activated.

Creating Proxies in Objective-C

Once we have activated a servant for an Ice object, the server can process incoming client requests for that object. However, clients can only access the object once they hold a proxy for the object. If a client knows the server's address details and the object identity, it can create a proxy from a string, as we saw in our [first example](#). However, creation of proxies by the client in this manner is usually only done to allow the client access to initial objects for bootstrapping. Once the client has an initial proxy, it typically obtains further proxies by invoking operations.

The object adapter contains all the details that make up the information in a proxy: the addressing and protocol information, and the object identity. The Ice run time offers a number of ways to create proxies. Once created, you can pass a proxy to the client as the return value or as an out-parameter of an operation invocation.

Proxies and Servant Activation in Objective-C

The `add` and `addWithUUID` servant activation operations on the object adapter return a proxy for the corresponding Ice object, as we saw earlier. This means we can write:

Objective-C

```
NodeI *servant = [NodeI nodei:name];
id<FSNodePrx> proxy = [FSNodePrx uncheckedCast:
[adapter addWithUUID:servant]];

// Pass proxy to client...
```

Here, `addWithUUID` both activates the servant and returns a proxy for the Ice object incarnated by that servant in a single step.

Note that we need to use an `uncheckedCast` here because `addWithUUID` returns a proxy of type `id<ICEObjectPrx>`.

Direct Proxy Creation in Objective-C

The object adapter offers an operation to create a proxy for a given identity:

Slice

```
["objc:prefix:ICE"]
module Ice {
    local interface ObjectAdapter {
        Object* createProxy(Identity id);
        // ...
    };
};
```

Note that `createProxy` creates a proxy for a given identity whether a servant is activated with that identity or not. In other words, proxies have a life cycle that is quite independent from the life cycle of servants:

Objective-C

```
ICEIdentity *ident = [ICEIdentity identity];
ident.name = [ICEUtil generateUUID];
id<ICEObjectPrx> o = [adapter createProxy:ident];
```

This creates a proxy for an Ice object with the identity returned by `generateUUID`. Obviously, no servant yet exists for that object so, if we return the proxy to a client and the client invokes an operation on the proxy, the client will receive an `ObjectNotExistException`. (We examine these life cycle issues in more detail in [Object Life Cycle](#).)

See Also

- [Writing an Ice Application with Objective-C](#)
- [Server-Side Objective-C Mapping for Interfaces](#)
- [Object Adapter States](#)
- [Servant Locators](#)
- [Object Life Cycle](#)

Example of a File System Server in Objective-C

This page presents the source code for a C++ server that implements our [file system](#) and communicates with the [client](#) we wrote earlier. The code here is fully functional, apart from the required interlocking for threads.

The server is remarkably free of code that relates to distribution: most of the server code is simply application logic that would be present just the same for a non-distributed version. Again, this is one of the major advantages of Ice: distribution concerns are kept away from application code so that you can concentrate on developing application logic instead of networking infrastructure.

i The server code presented here is not quite correct as it stands: if two clients access the same file in parallel, each via a different thread, one thread may read the lines instance variable while another thread updates it. Obviously, if that happens, we may write or return garbage or, worse, crash the server. However, it is trivial to make the read and write operations thread-safe with a few lines of code. We discuss how to write thread-safe servant implementations in [The Ice Threading Model](#).

On this page:

- [Implementing a File System Server in Objective-C](#)
- [Server main Program in Objective-C](#)
- [Servant Class Definitions in Objective-C](#)
- [Servant Implementation in Objective-C](#)
 - [Implementing FileI in Objective-C](#)
 - [Implementing DirectoryI in Objective-C](#)

Implementing a File System Server in Objective-C

We have now seen enough of the server-side Objective-C mapping to implement a server for our [file system](#). (You may find it useful to review these Slice definitions before studying the source code.)

Our server is composed of three source files:

- `Server.m`
This file contains the server main program.
- `FileI.m`
This file contains the implementation for the `File` servants.
- `DirectoryI.m`
This file contains the implementation for the `Directory` servants.

Server main Program in Objective-C

Our server main program, in the file `Server.m`, uses the structure we saw in an [earlier example](#):

```

Objective-C

#import <Ice/Ice.h>
#import <FileI.h>
#import <DirectoryI.h>

#import <Foundation/NSAutoreleasePool.h>

int
main(int argc, char* argv[])
{
    NSAutoreleasePool * pool = [[NSAutoreleasePool alloc] init];

    int status = 1;
```



```

id<ICECommunicator> communicator = nil;
@try {
    communicator = [ICEUtil createCommunicator:&argc argv:argv];

    id<ICEObjectAdapter> adapter =
[communicator createObjectAdapterWithEndpoints:
                    @"SimpleFilesystem"
                    endpoints:@"default -p 10000"];

    // Create the root directory (with name "/" and no parent)
    //
    DirectoryI *root = [DirectoryI directoryi:@"/" parent:nil];
    [root activate:adapter];

    // Create a file called "README" in the root directory
    //
    FileI *file = [FileI filei:@"README" parent:root];
    NSMutableArray *text = [NSMutableArray arrayWithObject:
        @"This file system contains a collection of poetry."];
    [file write:text current:nil];
    [file activate:adapter];

    // Create a directory called "Coleridge" in the root dir
    //
    DirectoryI *coleridge =
[DirectoryI directoryi:@"Coleridge" parent:root];
    [coleridge activate:adapter];

    // Create a file called "Kubla_Khan"
    // in the Coleridge directory
    //
    file = [FileI filei:@"Kubla_Khan" parent:coleridge];
    text = [NSMutableArray arrayWithObjects:
        @"In Xanadu did Kubla Khan",
        @"A stately pleasure-dome decree:",
        @"Where Alph, the sacred river, ran",
        @"Through caverns measureless to man",
        @"Down to a sunless sea.",
        nil];
    [file write:text current:nil];
    [file activate:adapter];

    // All objects are created, allow client requests now
    //
    [adapter activate];

    // Wait until we are done
    //
    [communicator waitForShutdown];

```

```
        status = 0;
    } @catch (NSEException* ex) {
        NSLog(@"%@", ex);
    }

    @try {
        [communicator destroy];
    } @catch (NSEException* ex) {
        NSLog(@"%@", ex);
    }

    [pool release];
```

```

    return status;
}

```

There is quite a bit of code here, so let us examine each section in detail:

Objective-C

```

#import <Ice/Ice.h>
#import <FileI.h>
#import <DirectoryI.h>

#import <Foundation/NSAutoreleasePool.h>

```

The code includes the header `Ice/Ice.h`, which contains the definitions for the Ice run time, and the files `FileI.h` and `DirectoryI.h`, which contain the definitions of our servant implementations. Because we use an autorelease pool, we need to include `Foundation/NSAutoreleasePool.h` as well.

The next part of the source code is mostly boiler plate that we saw previously: we create an object adapter, and, towards the end, activate the object adapter and call `waitForShutdown`, which blocks the calling thread until you call `shutdown` or `destroy` on the communicator. (Ice does not make any demands on the main thread, so `waitForShutdown` simply blocks the calling thread; if you want to use the main thread for other purposes, you are free to do so.)

Objective-C

```

int
main(int argc, char* argv[])
{
    NSAutoreleasePool * pool = [[NSAutoreleasePool alloc] init];

    int status = 1;
    id<ICECommunicator> communicator = nil;
    @try {
        communicator = [ICEUtil createCommunicator:&argc argv:argv];

        id<ICEObjectAdapter> adapter =
[communicator createObjectAdapterWithEndpoints:
                                @"SimpleFilesystem"
                                endpoints:@"default -p 10000"];

        // ...

        // All objects are created, allow client requests now
        //
        [adapter activate];

        // Wait until we are done
        //
        [communicator waitForShutdown];

        status = 0;
    } @catch (NSException* ex) {
        NSLog(@"%@", ex);
    }

    @try {
        [communicator destroy];
    } @catch (NSException* ex) {
        NSLog(@"%@", ex);
    }

    [pool release];
    return status;
}

```

The interesting part of the code follows the adapter creation: here, the server instantiates a few nodes for our file system to create the structure shown below:

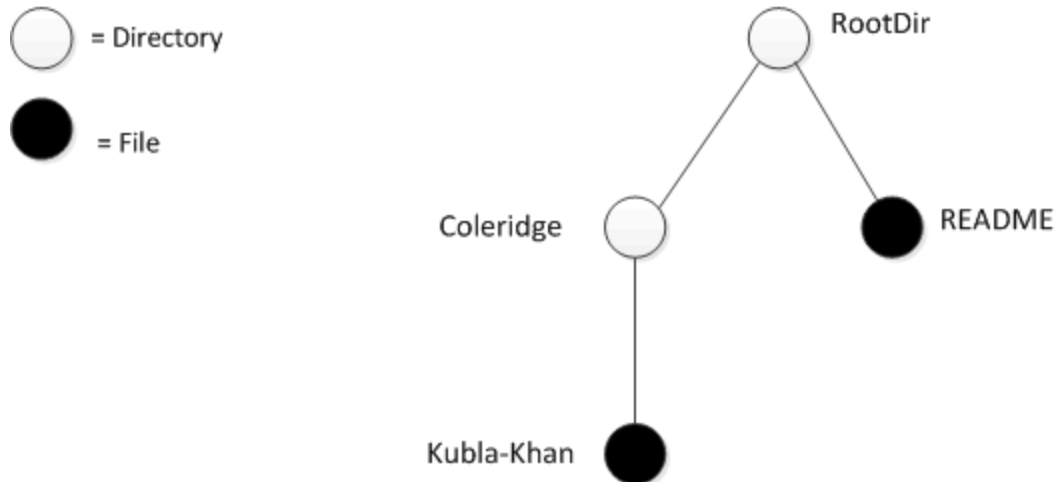

A small file system.

As we will see shortly, the servants for our directories and files are of type `DirectoryI` and `FileI`, respectively. The constructor for either type of servant accepts two parameters: the name of the directory or file to be created and the servant for the parent directory. (For the root directory, which has no parent, we pass a `nil` parent.) Thus, the statement

Objective-C

```
DirectoryI *root = [DirectoryI directoryi:@"/" parent:nil];
```

creates the root directory, with the name `"/"` and no parent directory.

Here is the code that establishes the structure in the above illustration shown:

Objective-C

```

// Create the root directory (with name "/" and no parent)
//
DirectoryI *root = [DirectoryI directoryi:@"/" parent:nil];
[root activate:adapter];

// Create a file called "README" in the root directory
//
FileI *file = [FileI filei:@"README" parent:root];
NSMutableArray *text = [NSMutableArray arrayWithObject:
    @"This file system contains a collection of poetry."];
[file write:text current:nil];
[file activate:adapter];

// Create a directory called "Coleridge" in the root dir
//
DirectoryI *coleridge =
[DirectoryI directoryi:@"Coleridge" parent:root];
[coleridge activate:adapter];

// Create a file called "Kubla_Khan"
// in the Coleridge directory
//
file = [FileI filei:@"Kubla_Khan" parent:coleridge];
text = [NSMutableArray arrayWithObjects:
    @"In Xanadu did Kubla Khan",
    @"A stately pleasure-dome decree:",
    @"Where Alph, the sacred river, ran",
    @"Through caverns measureless to man",
    @"Down to a sunless sea.",
    nil];
[file write:text current:nil];
[file activate:adapter];

```

We first create the root directory and a file `README` within the root directory. (Note that we pass the servant for the root directory as the parent pointer when we create the new node of type `FileI`.)

After creating each servant, the code calls `activate` on the servant. (We will see the definition of this member function shortly.) The `activate` member function adds the servant to the ASM.

The next step is to fill the file with text:

Objective-C

```

// Create the root directory (with name "/" and no parent)
//
DirectoryI *root = [DirectoryI directoryi:@"/" parent:nil];
[root activate:adapter];

// Create a file called "README" in the root directory
//
FileI *file = [FileI filei:@"README" parent:root];
NSMutableArray *text = [NSMutableArray arrayWithObject:
    @"This file system contains a collection of poetry."];
[file write:text current:nil];
[file activate:adapter];

// Create a directory called "Coleridge" in the root dir
//
DirectoryI *coleridge =
[DirectoryI directoryi:@"Coleridge" parent:root];
[coleridge activate:adapter];

// Create a file called "Kubla_Khan"
// in the Coleridge directory
//
file = [FileI filei:@"Kubla_Khan" parent:coleridge];
text = [NSMutableArray arrayWithObjects:
    @"In Xanadu did Kubla Khan",
    @"A stately pleasure-dome decree:",
    @"Where Alph, the sacred river, ran",
    @"Through caverns measureless to man",
    @"Down to a sunless sea.",
    nil];
[file write:text current:nil];
[file activate:adapter];

```

Recall that [Slice sequences](#) map to `NSArray` or `NSMutableArray`, depending on the parameter direction. Here, we instantiate that array and add a line of text to it.

Finally, we call the Slice `write` operation on our `FileI` servant by simply writing:

Objective-C

```
[file write:text current:nil];
```

This statement is interesting: the server code invokes an operation on one of its own servants. Because the call happens via the pointer to the servant (of type `FileI`) and *not* via a proxy (of type `id<FilePrx>`), the Ice run time does not know that this call is even taking place — such a direct call into a servant is not mediated by the Ice run time in any way and is dispatched as an ordinary Objective-C function call. The operation implementation in the servant expects a `current` object. In this case, we pass `nil` (which is fine because the operation implementation does not use it anyway).

In similar fashion, the remainder of the code creates a subdirectory called `Coleridge` and, within that directory, a file called `Kubla_Khan` to complete the structure in the above illustration.

Servant Class Definitions in Objective-C

We must provide servants for the concrete interfaces in our Slice specification, that is, we must provide servants for the `File` and `Directory` interfaces in the Objective-C classes `FileI` and `DirectoryI`. This means that our servant classes look as follows:

```

Objective-C

#import <Filesystem.h>

@interface FileI : FSFile <FSFile>
// ...
@end

@interface DirectoryI : FSDirectory <FSDirectory>
// ...
@end
```

Each servant class derives from its skeleton class and adopts its skeleton protocol.

We now can think about how to implement our servants. One thing that is common to all nodes is that they have a name and a parent directory. As we saw earlier, we pass these details to a convenience constructor, which also takes care of calling `autorelease` on the new servant.

In addition, we will use UUIDs as the object identities for files and directories. This relieves us of the need to otherwise come up with a unique identity for each servant (such as path names, which would only complicate our implementation). Because the `list` operation returns proxies to nodes, and because each proxy carries the identity of the servant it denotes, this means that our servants must store their own identity, so we can create proxies to them when clients ask for them.

For `File` servants, we also need to store the contents of the file, leading to the following definition for the `FileI` class:

Objective-C

```

#import <Filesystem.h>

@class DirectoryI;

@interface FileI : FSFile <FSFile>
{
    @private
    NSString *myName;
    DirectoryI *parent;
    ICEIdentity *ident;
    NSArray *lines;
}

@property(nonatomic, retain) NSString *myName;
@property(nonatomic, retain) DirectoryI *parent;
@property(nonatomic, retain) ICEIdentity *ident;
@property(nonatomic, retain) NSArray *lines;

+(id) filei:(NSString *)name parent:(DirectoryI *)parent;
-(void) write:(NSMutableArray *)text current:(ICECurrent *)current;
-(void) activate:(id<ICEObjectAdapter>)a;
@end

```

The instance variables store the name, parent node, identity, and the contents of the file. The `filei` convenience constructor instantiates the servant, remembers the name and parent directory, assigns a new identity, and calls `autorelease`.

Note that the only Slice operation we have defined here is the `write` method. This is necessary because, as we saw previously, the code in `Server.m` calls this method to initialize the files it creates.

For directories, the requirements are similar. They also need to store a name, parent directory, and object identity. Directories are also responsible for keeping track of the child nodes. We can store these nodes in an array of proxies. This leads to the following definition:

Objective-C

```

#import <Filesystem.h>

@interface DirectoryI : FSDirectory <FSDirectory>
{
    @private
    NSString *myName;
    DirectoryI *parent;
    ICEIdentity *ident;
    NSMutableArray *contents;
}
@property(nonatomic, retain) NSString *myName;
@property(nonatomic, retain) DirectoryI *parent;
@property(nonatomic, retain) ICEIdentity *ident;
@property(nonatomic, retain) NSMutableArray *contents;

+(id) directoryi:(NSString *)name parent:(DirectoryI *)parent;
-(void) addChild:(id<FSNodePrx>)child;
-(void) activate:(id<ICEObjectAdapter>)a;
@end

```

Because the code in `Server.m` does not call any Slice operations on directory servants, we have not declared any of the corresponding methods. (We will see the purpose of the `addChild` method shortly.) As for files, the convenience constructor creates the servant, remembers the name and parent, and assigns an object identity, as well as calling `autorelease`.

Servant Implementation in Objective-C

Let us now turn to how to implement each of the methods for our servants.

Implementing `FileI` in Objective-C

The implementation of the `name`, `read`, and `write` operations for files is trivial, returning or updating the corresponding instance variable:

Objective-C

```

-(NSString *) name:(ICECurrent *)current
{
    return myName;
}

-(NSArray *) read:(ICECurrent *)current
{
    return lines;
}

-(void) write:(NSMutableArray *)text current:(ICECurrent *)current
{
    self.lines = text;
}

```

Note that this constitutes the complete implementation of the Slice operations for files.

Here is the convenience constructor:

Objective-C

```

+(id) filei:(NSString *)name parent:(DirectoryI *)parent
{
    FileI *instance = [[[FileI alloc] init] autorelease];
    if(instance == nil)
    {
        return nil;
    }
    instance.myName = name;
    instance.parent = parent;
    instance.ident = [ICEIdentity
identity:[ICEUtil generateUUID] category:nil];
    return instance;
}

```

After allocating and autoreleasing the instance, the constructor initializes the instance variables. The only interesting part of this code is how we create the identity for the servant. `generateUUID` is a class method of the `ICEUtil` class that returns a UUID. We assign this UUID to the `name` member of the identity.

We saw earlier that the server calls `activate` after it creates each servant. Here is the implementation of this method:

Objective-C

```

-(void) activate:(id<ICEObjectAdapter>)a
{
    id<FSNodePrx> thisNode =
    [FSNodePrx uncheckedCast:[a add:self identity:ident]];
    [parent addChild:thisNode];
}

```

This is how our code informs the Ice run time of the existence of a new servant. The call to `add` on the object adapter adds the servant and object identity to the adapter's servant map. In other words, this step creates the link between the object identity (which is embedded in proxies), and the actual Objective-C class instance that provides the behavior for the Slice operations.

`add` returns a proxy to the servant, of type `id<ICEObjectPrx>`. Because the `contents` instance variable of directory servants stores proxies of type `id<FSNodePrx>` (and `addChild` expects a proxy of that type), we down-cast the returned proxy to `id<FSNodePrx>`. In this case, because we know that the servant we just added to the adapter is indeed a servant that implements the operations on the Slice `Node` interface, we can use an `uncheckedCast`.

The call to `addChild` connects the new file to its parent directory.

Finally, we need a `dealloc` function so we do not leak the memory for the servant's instance variables:

Objective-C

```

-(void) dealloc
{
    [myName release];
    [parent release];
    [ident release];
    [lines release];
    [super dealloc];
}

```

Implementing DirectoryI in Objective-C

The implementation of the Slice operations for directories is just as simple as for files:

Objective-C

```

-(NSString *) name:(ICECurrent *)current
{
    return myName;
}

-(NSArray *) list:(ICECurrent *)current
{
    return contents;
}

```

Because the `contents` instance variable stores the proxies for child nodes of the directory, the `list` operation simply returns that variable.

The convenience constructor looks much like the one for file servants:

```

Objective-C

+(id) directory:(NSString *)name parent:(DirectoryI *)parent
{
    DirectoryI *instance = [[[DirectoryI alloc] init] autorelease];
    if(instance == nil)
    {
        return nil;
    }
    instance.myName = name;
    instance.parent = parent;
    instance.ident = [ICEIdentity
        identity:(parent ? [ICEUtil generateUUID] : @"RootDir")
        category:nil];
    instance.contents = [[NSMutableArray alloc] init];
    return instance;
}

```

The only noteworthy differences are that, for the root directory (which has no parent), the code uses "RootDir" as the identity. (As we saw earlier, the client knows that this is the identity of the root directory and uses it to create its proxy.)

The `addChild` method connects our nodes into a hierarchy by updating the `contents` instance variable. That way, each directory knows which nodes are contained in it:

```

Objective-C

-(void) addChild:(id<FSNodePrx>)child
{
    [contents addObject:child];
}

```

Finally, the `activate` and `dealloc` methods are very much like the corresponding methods for files:

Objective-C

```
-(void) activate:(id<ICEObjectAdapter>)a
{
    id<FSNodePrx> thisNode = [FSNodePrx uncheckedCast:[a add:self
identity:ident]];
    [parent addChild:thisNode];
}

-(void) dealloc
{
    [myName release];
    [parent release];
    [ident release];
    [contents release];
    [super dealloc];
}
```

See Also

- [Slice for a Simple File System](#)
- [Objective-C Mapping for Sequences](#)
- [Example of a File System Client in Objective-C](#)
- [The Server-Side main Function in Objective-C](#)
- [The Ice Threading Model](#)

Python Mapping

Topics

- [Client-Side Slice-to-Python Mapping](#)
- [Server-Side Slice-to-Python Mapping](#)

Client-Side Slice-to-Python Mapping

The client-side Slice-to-Python mapping defines how Slice data types are translated to Python types, and how clients invoke operations, pass parameters, and handle errors. Much of the Python mapping is intuitive. For example, Slice sequences map to Python lists, so there is essentially nothing new you have to learn in order to use Slice sequences in Python.

The Python API to the Ice run time is fully thread-safe. Obviously, you must still synchronize access to data from different threads. For example, if you have two threads sharing a sequence, you cannot safely have one thread insert into the sequence while another thread is iterating over the sequence. However, you only need to concern yourself with concurrent access to your own data — the Ice run time itself is fully thread safe, and none of the Ice API calls require you to acquire or release a lock before you safely can make the call.

Much of what appears in this chapter is reference material. We suggest that you skim the material on the initial reading and refer back to specific sections as needed. However, we recommend that you read at least the mappings for [exceptions](#), [interfaces](#), and [operations](#) in detail because these sections cover how to call operations from a client, pass parameters, and handle exceptions.



In order to use the Python mapping, you should need no more than the Slice definition of your application and knowledge of the Python mapping rules. In particular, looking through the generated code in order to discern how to use the Python mapping is likely to be inefficient, due to the amount of detail. Of course, occasionally, you may want to refer to the generated code to confirm a detail of the mapping, but we recommend that you otherwise use the material presented here to see how to write your client-side code.



The Ice Module

All of the APIs for the Ice run time are nested in the `Ice` module, to avoid clashes with definitions for other libraries or applications. Some of the contents of the `Ice` module are generated from Slice definitions; other parts of the `Ice` module provide special-purpose definitions that do not have a corresponding Slice definition. We will incrementally cover the contents of the `Ice` module throughout the remainder of the manual.

A Python application can load the Ice run time using the `import` statement:

```
import Ice
```

If the statement executes without error, the Ice run time is loaded and available for use. You can determine the version of the Ice run time you have just loaded by calling the `stringVersion` function:

```
icever = Ice.stringVersion()
```

Topics

- [Python Mapping for Identifiers](#)
- [Python Mapping for Modules](#)
- [Python Mapping for Built-In Types](#)
- [Python Mapping for Enumerations](#)
- [Python Mapping for Structures](#)
- [Python Mapping for Sequences](#)
- [Python Mapping for Dictionaries](#)
- [Python Mapping for Constants](#)
- [Python Mapping for Exceptions](#)
- [Python Mapping for Interfaces](#)
- [Python Mapping for Operations](#)
- [Python Mapping for Classes](#)
- [Asynchronous Method Invocation \(AMI\) in Python](#)
- [Code Generation in Python](#)
- [Using Slice Checksums in Python](#)
- [Example of a File System Client in Python](#)

Python Mapping for Identifiers

A Slice [identifier](#) maps to an identical Python identifier. For example, the Slice identifier `clock` becomes the Python identifier `clock`. There is one exception to this rule: if a Slice identifier is the same as a Python keyword or is an identifier reserved by the Ice run time (such as `checkedCast`), the corresponding Python identifier is prefixed with an underscore. For example, the Slice identifier `while` is mapped as `_while`.



You should try to [avoid such identifiers](#) as much as possible.

The mapping does not modify a Slice identifier that matches the name of a Python built-in function because it can always be accessed by its fully-qualified name. For example, the built-in function `hash` can also be accessed as `__builtin__.hash`.

See Also

- [Lexical Rules](#)
- [Python Mapping for Modules](#)
- [Python Mapping for Built-In Types](#)
- [Python Mapping for Enumerations](#)
- [Python Mapping for Structures](#)
- [Python Mapping for Sequences](#)
- [Python Mapping for Dictionaries](#)
- [Python Mapping for Constants](#)
- [Python Mapping for Exceptions](#)

Python Mapping for Modules

A Slice [module](#) maps to a Python module with the same name. The mapping preserves the nesting of the Slice definitions. Note that you can optionally use [packages](#) to gain further control over the generated code.

See Also

- [Modules](#)
- [Python Mapping for Identifiers](#)
- [Python Mapping for Built-In Types](#)
- [Python Mapping for Enumerations](#)
- [Python Mapping for Structures](#)
- [Python Mapping for Sequences](#)
- [Python Mapping for Dictionaries](#)
- [Python Mapping for Constants](#)
- [Python Mapping for Exceptions](#)
- [Code Generation in Python](#)

Python Mapping for Built-In Types

On this page:

- [Mapping of Slice Built-In Types to Python Types](#)
- [String Mapping in Python](#)

Mapping of Slice Built-In Types to Python Types

The Slice built-in types are mapped to Python types as shown in this table:

Slice	Python
<code>bool</code>	<code>bool</code>
<code>short</code>	<code>int</code>
<code>int</code>	<code>int</code>
<code>long</code>	<code>long</code>
<code>float</code>	<code>double</code>
<code>double</code>	<code>double</code>
<code>string</code>	<code>string</code>

Although Python supports arbitrary precision in its integer types, the Ice run time validates integer values to ensure they have valid ranges for their declared Slice types.

String Mapping in Python

String values returned as the result of a Slice operation (including return values, out parameters, and data members) are always represented as instances of Python's 8-bit `string` type. These string values contain UTF-8 encoded strings unless the program has installed a [string converter](#), in which case string values use the converter's native encoding instead.

Legal string input values for a remote Slice operation are shown below:

- `None`
Ice marshals an empty string whenever `None` is encountered.
- 8-bit string objects
Ice assumes that all 8-bit string objects contain valid UTF-8 encoded strings unless the program has installed a string converter, in which case Ice assumes that 8-bit string objects use the native encoding expected by the converter.
- Unicode objects
Ice converts a Unicode object into UTF-8 and marshals it directly. If a string converter is installed, it is not invoked for Unicode objects.

See Also

- [Basic Types](#)
- [Python Mapping for Identifiers](#)
- [Python Mapping for Modules](#)
- [Python Mapping for Enumerations](#)
- [Python Mapping for Structures](#)
- [Python Mapping for Sequences](#)
- [Python Mapping for Dictionaries](#)
- [Python Mapping for Constants](#)
- [Python Mapping for Exceptions](#)
- [C++ Strings and Character Encoding](#)

Python Mapping for Enumerations

Python does not have an enumerated type, so a Slice [enumeration](#) is emulated using a Python class: the name of the Slice enumeration becomes the name of the Python class; for each enumerator, the class contains an attribute with the same name as the enumerator. For example:

Slice
<pre>enum Fruit { Apple, Pear, Orange };</pre>

The generated Python class looks as follows:

Python
<pre>class Fruit(Ice.EnumBase): def valueOf(self, n): # ... valueOf = classmethod(valueOf) # ... Fruit.Apple = ... Fruit.Pear = ... Fruit.Orange = ...</pre>

Each instance of the class has a `value` attribute providing the Slice value of the enumerator, and a `name` attribute that returns its name. The `valueOf` class method translates a Slice value into its corresponding enumerator, or returns `None` if no match is found.

Given the above definitions, we can use enumerated values as follows:

Python
<pre>f1 = Fruit.Apple f2 = Fruit.Orange if f1 == Fruit.Apple: # Compare with constant # ... if f1 == f2: # Compare two enums # ... if f2.value == Fruit.Apple.value: # Use Slice values # ... elif f2.value == Fruit.Pear.value: # ... elif f2.value == Fruit.Orange.value: # ... Fruit.valueOf(1) # Pear</pre>

As you can see, the generated class enables natural use of enumerated values. The `Fruit` class attributes are preinitialized enumerators that you can use for initialization and comparison.

Note that the generated class also defines a number of Python special methods, such as `__str__` and rich comparison operators, which we have not shown. The rich comparison operators compare the Slice value of the enumerator, which is not necessarily the same as its ordinal value.

Suppose we modify the Slice definition to include a [custom enumerator value](#):

```
Slice  
enum Fruit { Apple, Pear = 3, Orange };
```

We can use `valueOf` to examine the Slice values of the enumerators:

```
Python  
Fruit.valueOf(0) # Apple  
Fruit.valueOf(1) # None  
Fruit.valueOf(3) # Pear  
Fruit.valueOf(4) # Orange
```

See Also

- [Enumerations](#)
- [Python Mapping for Identifiers](#)
- [Python Mapping for Modules](#)
- [Python Mapping for Built-In Types](#)
- [Python Mapping for Structures](#)
- [Python Mapping for Sequences](#)
- [Python Mapping for Dictionaries](#)
- [Python Mapping for Constants](#)
- [Python Mapping for Exceptions](#)

Python Mapping for Structures

A Slice [structure](#) maps to a Python class with the same name. For each Slice data member, the Python class contains a corresponding attribute. For example, here is our [Employee](#) structure once more:

Slice
<pre>struct Employee { long number; string firstName; string lastName; };</pre>

The Python mapping generates the following definition for this structure:

Python
<pre>class Employee(object): def __init__(self, number=0, firstName='', lastName=''): self.number = number self.firstName = firstName self.lastName = lastName def __eq__(self, other): # ... def __ne__(self, other): # ... def __str__(self): # ... def __hash__(self): # ... # ...</pre>

The constructor initializes each of the attributes to a default value appropriate for its type. You can also declare different [default values](#) for members of primitive and enumerated types.

The `__eq__` method returns true if all members of two structures are (recursively) equal, and `__ne__` returns true if any member differs.

The `__str__` method returns a string representation of the structure.

For structures that are also [legal dictionary key types](#), the mapping also generates relational operators (`__lt__`, `__le__`, `__gt__`, `__ge__`) and a `__hash__` method. The `__hash__` method returns a hash value for the structure based on the value of all its data members.

See Also

- [Structures](#)
- [Dictionaries](#)
- [Python Mapping for Identifiers](#)

- [Python Mapping for Modules](#)
- [Python Mapping for Built-In Types](#)
- [Python Mapping for Enumerations](#)
- [Python Mapping for Sequences](#)
- [Python Mapping for Dictionaries](#)
- [Python Mapping for Constants](#)
- [Python Mapping for Exceptions](#)

Python Mapping for Sequences

On this page:

- [Default Sequence Mapping in Python](#)
- [Allowable Sequence Values in Python](#)
- [Customizing the Sequence Mapping in Python](#)

Default Sequence Mapping in Python

A Slice sequence maps by default to a Python list; the only exception is a sequence of bytes, which maps by default to a string in order to lower memory utilization and improve throughput. This use of native types means that the Python mapping does not generate a separate named type for a Slice sequence. It also means that you can take advantage of all the inherent functionality offered by Python's native types. For example, here is the definition of our `FruitPlatter` sequence once more:

```

Python
sequence<Fruit> FruitPlatter;

```

We can use the `FruitPlatter` sequence as shown below:

```

Python
platter = [ Fruit.Apple, Fruit.Pear ]
assert(len(platter) == 2)
platter.append(Fruit.Orange)

```

The Ice run time validates the elements of a tuple or list to ensure that they are compatible with the declared type; a `ValueError` exception is raised if an incompatible type is encountered.

Allowable Sequence Values in Python

Although each sequence type has a default mapping, the Ice run time allows a sender to use other types as well. Specifically, a tuple is also accepted for a sequence type that maps to a list, and in the case of a byte sequence, the sender is allowed to supply a tuple or list of integers as an alternative to a string.

i Using a string for a byte sequence bypasses the validation step and avoids an extra copy, resulting in much greater throughput than a tuple or list. For larger byte sequences, the use of a string is strongly recommended.

Furthermore, the Ice run time accepts objects that implement Python's buffer protocol as legal values for sequences of all primitive types except strings. For example, you can use the `array` module to create a buffer that is transferred much more efficiently than a tuple or list. Consider the two sequence values in the sample code below:

```

Python
import array
...
seq1 = array.array("i", [1, 2, 3, 4, 5])
seq2 = [1, 2, 3, 4, 5]

```

The values have the same on-the-wire representation, but they differ greatly in marshaling overhead because the buffer can be traversed more quickly and requires no validation.

Note that the Ice run time has no way of knowing what type of elements a buffer contains, therefore it is the application's responsibility to ensure that a buffer is compatible with the declared sequence type.

Customizing the Sequence Mapping in Python

The previous section described the allowable types that an application may use when sending a sequence. That kind of flexibility is not possible when receiving a sequence, because in this case it is the Ice run time's responsibility to create the container that holds the sequence.

As stated earlier, the default mapping for most sequence types is a list, and for byte sequences the default mapping is a string. Unless otherwise indicated, an application always receives sequences as the container type specified by the default mapping. If it would be more convenient to receive a sequence as a different type, you can customize the mapping by annotating your Slice definitions with metadata. The following table describes the metadata directives supported by the Python mapping:

Directive	Description
<code>python:seq:default</code>	Use the default mapping.
<code>python:seq:list</code>	Map to a Python list.
<code>python:seq:tuple</code>	Map to a Python tuple.

A metadata directive may be specified when defining a sequence, or when a sequence is used as a parameter, return value or data member. If specified at the point of definition, the directive affects all occurrences of that sequence type unless overridden by another directive at a point of use. The following Slice definitions illustrate these points:

Slice

```

sequence<int> IntList; // Uses list by default
["python:seq:tuple"] sequence<int> IntTuple; // Defaults to tuple

sequence<byte> ByteString; // Uses string by default
["python:seq:list"] sequence<byte> ByteList; // Defaults to list

struct S {
    IntList i1; // list
    IntTuple i2; // tuple
    ["python:seq:tuple"] IntList i3; // tuple
    ["python:seq:list"] IntTuple i4; // list
    ["python:seq:default"] IntTuple i5; // list

    ByteString b1; // string
    ByteList b2; // list
    ["python:seq:list"] ByteString b3; // list
    ["python:seq:tuple"] ByteString b4; // tuple
    ["python:seq:default"] ByteList b5; // string
};

interface I {
    IntList op1(ByteString s1, out ByteList s2);

    ["python:seq:tuple"]
    IntList op2(["python:seq:list"] ByteString s1,
               ["python:seq:tuple"] out ByteList s2);
};

```

The operation `op2` and the data members of structure `S` demonstrate how to override the mapping for a sequence at the point of use.

It is important to remember that these metadata directives only affect the receiver of the sequence. For example, the data members of structure `S` are populated with the specified sequence types only when the Ice run time unmarshals an instance of `S`. In the case of an operation, custom metadata affects the client when specified for the operation's return type and output parameters, whereas metadata affects the server for input parameters.

See Also

- [Sequences](#)
- [Python Mapping for Identifiers](#)
- [Python Mapping for Modules](#)
- [Python Mapping for Built-In Types](#)
- [Python Mapping for Enumerations](#)
- [Python Mapping for Structures](#)
- [Python Mapping for Dictionaries](#)
- [Python Mapping for Constants](#)
- [Python Mapping for Exceptions](#)

Python Mapping for Dictionaries

Here is the definition of our `EmployeeMap` once more:

Slice
<pre>dictionary<long, Employee> EmployeeMap;</pre>

As for [sequences](#), the Python mapping does not create a separate named type for this definition. Instead, *all* dictionaries are simply instances of Python's dictionary type. For example:

Python
<pre>em = {} e = Employee() e.number = 31 e.firstName = "James" e.lastName = "Gosling" em[e.number] = e</pre>

The Ice run time validates the elements of a dictionary to ensure that they are compatible with the declared type; a `ValueError` exception is raised if an incompatible type is encountered.

See Also

- [Dictionaries](#)
- [Python Mapping for Identifiers](#)
- [Python Mapping for Modules](#)
- [Python Mapping for Built-In Types](#)
- [Python Mapping for Enumerations](#)
- [Python Mapping for Structures](#)
- [Python Mapping for Sequences](#)
- [Python Mapping for Constants](#)
- [Python Mapping for Exceptions](#)

Python Mapping for Constants

Here are the [constant definitions](#) once more:

Slice	
<code>const bool</code>	<code>AppendByDefault = true;</code>
<code>const byte</code>	<code>LowerNibble = 0x0f;</code>
<code>const string</code>	<code>Advice = "Don't Panic!";</code>
<code>const short</code>	<code>TheAnswer = 42;</code>
<code>const double</code>	<code>PI = 3.1416;</code>
<code>enum Fruit { Apple, Pear, Orange };</code>	
<code>const Fruit</code>	<code>FavoriteFruit = Pear;</code>

The generated definitions for these constants are shown below:

Python	
<code>AppendByDefault = True</code>	
<code>LowerNibble = 15</code>	
<code>Advice = "Don't Panic!"</code>	
<code>TheAnswer = 42</code>	
<code>PI = 3.1416</code>	
<code>FavoriteFruit = Fruit.Pear</code>	

As you can see, each Slice constant is mapped to a Python attribute with the same name as the constant.

See Also

- [Constants and Literals](#)
- [Python Mapping for Identifiers](#)
- [Python Mapping for Modules](#)
- [Python Mapping for Built-In Types](#)
- [Python Mapping for Enumerations](#)
- [Python Mapping for Structures](#)
- [Python Mapping for Sequences](#)
- [Python Mapping for Dictionaries](#)
- [Python Mapping for Exceptions](#)

Python Mapping for Exceptions

On this page:

- [Inheritance Hierarchy for Exceptions in Python](#)
- [Python Mapping for User Exceptions](#)
- [Python Mapping for Run-Time Exceptions](#)

Inheritance Hierarchy for Exceptions in Python

The mapping for exceptions is based on the inheritance hierarchy shown below:

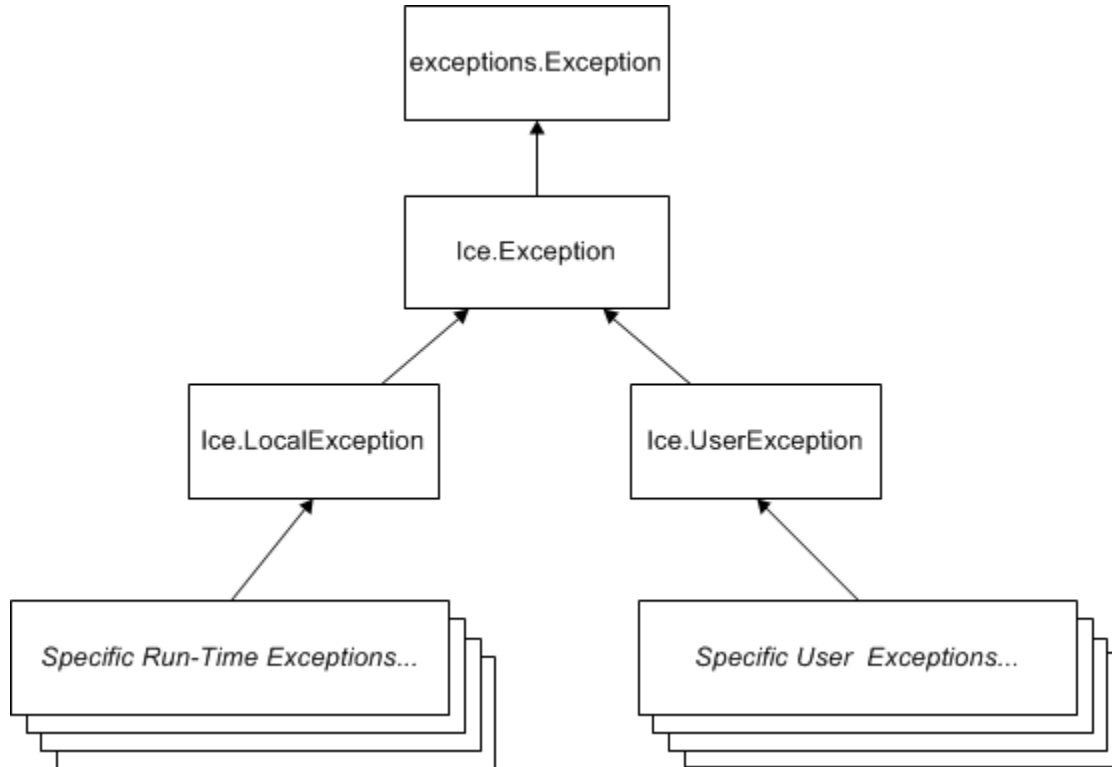

Inheritance structure for Ice exceptions.

The ancestor of all exceptions is `exceptions.Exception`, from which `Ice.Exception` is derived. `Ice.LocalException` and `Ice.UserException` are derived from `Ice.Exception` and form the base for all run-time and user exceptions.

Python Mapping for User Exceptions

Here is a fragment of the Slice definition for our world time server once more:

```

Slice
exception GenericError {
    string reason;
};
exception BadTimeVal extends GenericError {};
exception BadZoneName extends GenericError {};
  
```

These exception definitions map as follows:

Python
<pre> class GenericError(Ice.UserException): def __init__(self, reason=''): self.reason = reason def ice_name(self): # ... def __str__(self): # ... class BadTimeVal(GenericError): def __init__(self, reason=''): GenericError.__init__(self, reason) def ice_name(self): # ... def __str__(self): # ... class BadZoneName(GenericError): def __init__(self, reason=''): GenericError.__init__(self, reason) def ice_name(self): # ... def __str__(self): # ... </pre>

Each Slice exception is mapped to a Python class with the same name. The inheritance structure of the Slice exceptions is preserved for the generated classes, so `BadTimeVal` and `BadZoneName` inherit from `GenericError`.

Each exception member corresponds to an attribute of the instance, which the constructor initializes to a default value appropriate for its type. You can also declare different [default values](#) for members of primitive and enumerated types. For derived exceptions, the constructor has one parameter for each of the base exception's data members, plus one parameter for each of the derived exception's data members, in base-to-derived order. As an example, although `BadTimeVal` and `BadZoneName` do not declare data members, their constructors still accept a value for the inherited data member `reason` in order to pass it to the constructor of the base exception `GenericError`.

[Optional data members](#) use the same mapping as required data members, but an optional data member can also be set to the marker value `Ice.Unset` to indicate that the member is unset. A well-behaved program must compare an optional data member to `Ice.Unset` before using the member's value:

Python

```
try:
    ...
except ex:
    if ex.optionalMember is Ice.Unset:
        print("optionalMember is unset")
    else:
        print("optionalMember = " + str(ex.optionalMember))
```

Each exception also defines the `ice_name` method to return the name of the exception, and the special method `__str__` to return a stringified representation of the exception and its members.

All user exceptions are derived from the base class `Ice.UserException`. This allows you to catch all user exceptions generically by installing a handler for `Ice.UserException`. Similarly, you can catch all Ice run-time exceptions with a handler for `Ice.LocalException`, and you can catch all Ice exceptions with a handler for `Ice.Exception`.

Python Mapping for Run-Time Exceptions

The Ice run time throws [run-time exceptions](#) for a number of pre-defined error conditions. All run-time exceptions directly or indirectly derive from `Ice.LocalException` (which, in turn, derives from `Ice.Exception`).

By catching exceptions at the appropriate point in the inheritance hierarchy, you can handle exceptions according to the category of error they indicate:

- `Ice.LocalException`
This is the root of the inheritance tree for run-time exceptions.
- `Ice.UserException`
This is the root of the inheritance tree for user exceptions.
- `Ice.TimeoutException`
This is the base exception for both operation-invocation and connection-establishment timeouts.
- `Ice.ConnectTimeoutException`
This exception is raised when the initial attempt to establish a connection to a server times out.

For example, a `ConnectTimeoutException` can be handled as `ConnectTimeoutException`, `TimeoutException`, `LocalException`, or `Exception`.

You will probably have little need to catch run-time exceptions as their most-derived type and instead catch them as `LocalException`; the fine-grained error handling offered by the remainder of the hierarchy is of interest mainly in the implementation of the Ice run time. Exceptions to this rule are the exceptions related to [facet](#) and [object](#) life cycles, which you may want to catch explicitly. These exceptions are `FacetNotExistException` and `ObjectNotExistException`, respectively.

See Also

- [User Exceptions](#)
- [Run-Time Exceptions](#)
- [Python Mapping for Identifiers](#)
- [Python Mapping for Modules](#)
- [Python Mapping for Built-In Types](#)
- [Python Mapping for Enumerations](#)
- [Python Mapping for Structures](#)
- [Python Mapping for Sequences](#)
- [Python Mapping for Dictionaries](#)

- [Python Mapping for Constants](#)
- [Optional Data Members](#)
- [Facets and Versioning](#)
- [Object Life Cycle](#)

Python Mapping for Interfaces

The mapping of Slice [interfaces](#) revolves around the idea that, to invoke a remote operation, you call a member function on a local class instance that is a [proxy](#) for the remote object. This makes the mapping easy and intuitive to use because making a remote procedure call is no different from making a local procedure call (apart from error semantics).

On this page:

- [Proxy Classes in Python](#)
- [Ice.ObjectPrx Class in Python](#)
- [Casting Proxies in Python](#)
- [Using Proxy Methods in Python](#)
- [Object Identity and Proxy Comparison in Python](#)

Proxy Classes in Python

On the client side, a Slice interface maps to a Python class with methods that correspond to the operations on that interface. Consider the following simple interface:

Slice
<pre>interface Simple { void op(); };</pre>

The Python mapping generates the following definition for use by the client:

Python
<pre>class SimplePrx(Ice.ObjectPrx): def op(self, _ctx=None): # ... # ...</pre>

In the client's address space, an instance of `SimplePrx` is the local ambassador for a remote instance of the `Simple` interface in a server and is known as a *proxy instance*. All the details about the server-side object, such as its address, what protocol to use, and its object identity are encapsulated in that instance.

Note that `SimplePrx` inherits from `Ice.ObjectPrx`. This reflects the fact that all Ice interfaces implicitly inherit from `Ice::Object`.

For each operation in the interface, the proxy class has a method of the same name. In the preceding example, we find that the operation `op` has been mapped to the method `op`. Note that `op` accepts an optional trailing parameter `_ctx` representing the operation context. This parameter is a Python dictionary for use by the Ice run time to store information about how to deliver a request. You normally do not need to use it. (We examine the context parameter in detail in [Request Contexts](#). The parameter is also used by `IceStorm`.)

Proxy instances are always created on behalf of the client by the Ice run time, so client code never has any need to instantiate a proxy directly.

A value of `None` denotes the null proxy. The null proxy is a dedicated value that indicates that a proxy points "nowhere" (denotes no object).

Ice.ObjectPrx Class in Python

All Ice objects have `Object` as the ultimate ancestor type, so all proxies inherit from `Ice.ObjectPrx`. `ObjectPrx` provides a number of

methods:

```
Python
```

```
class ObjectPrx(object):
    def equals(self, other):
    def ice_getIdentity(self):
    def ice_isA(self, id):
    def ice_ids(self):
    def ice_id(self):
    def ice_ping(self):
    # ...
```

The methods behave as follows:

- **equals**

This method compares two proxies for equality. Note that all aspects of proxies are compared by this method, such as the communication endpoints for the proxy. This means that, in general, if two proxies compare unequal, that does *not* imply that they denote different objects. For example, if two proxies denote the same Ice object via different transport endpoints, `equals` returns `false` even though the proxies denote the same object.

- **ice_getIdentity**

This method returns the identity of the object denoted by the proxy. The identity of an Ice object has the following Slice type:

```
Slice
```

```
module Ice {
    struct Identity {
        string name;
        string category;
    };
};
```

To see whether two proxies denote the same object, first obtain the identity for each object and then compare the identities:

```
Python
```

```
proxy1 = ...
proxy2 = ...
id1 = proxy1.ice_getIdentity()
id2 = proxy2.ice_getIdentity()

if id1 == id2:
    # proxy1 and proxy2 denote the same object
else:
    # proxy1 and proxy2 denote different objects
```

- **ice_isA**

The `ice_isA` method determines whether the object denoted by the proxy supports a specific interface. The argument to `ice_isA` is a [type ID](#). For example, to see whether a proxy of type `ObjectPrx` denotes a `Printer` object, we can write:

Python

```

proxy = ...
if proxy != None and proxy.ice_isA("::Printer"):
    # proxy denotes a Printer object
else:
    # proxy denotes some other type of object

```

Note that we are testing whether the proxy is `None` before attempting to invoke the `ice_isA` method. This avoids getting a run-time error if the proxy is `None`.

- **ice_ids**
The `ice_ids` method returns an array of strings representing all of the [type IDs](#) that the object denoted by the proxy supports.
- **ice_id**
The `ice_id` method returns the [type ID](#) of the object denoted by the proxy. Note that the type returned is the type of the actual object, which may be more derived than the static type of the proxy. For example, if we have a proxy of type `BasePrx`, with a static type ID of `::Base`, the return value of `ice_id` might be `::Base`, or it might something more derived, such as `::Derived`.
- **ice_ping**
The `ice_ping` method provides a basic reachability test for the object. If the object can physically be contacted (that is, the object exists and its server is running and reachable), the call completes normally; otherwise, it throws an exception that indicates why the object could not be reached, such as `ObjectNotExistException` or `ConnectTimeoutException`.

The `ice_isA`, `ice_ids`, `ice_id`, and `ice_ping` methods are remote operations and therefore support an optional trailing parameter representing a [request context](#). Also note that there are [other methods](#) in `ObjectPrx`, not shown here. These methods provide different ways to dispatch a call and also provide access to an object's [facets](#).

Casting Proxies in Python

The Python mapping for a proxy also generates two static methods:

Python

```

class SimplePrx(Ice.ObjectPrx):
    # ...

    def checkedCast(proxy, facet=''):
        # ...
    checkedCast = staticmethod(checkedCast)

    def uncheckedCast(proxy, facet=''):
        # ...
    uncheckedCast = staticmethod(uncheckedCast)

```

The method names `checkedCast` and `uncheckedCast` are reserved for use in proxies. If a Slice interface defines an operation with either of those names, the mapping escapes the name in the generated proxy by prepending an underscore. For example, an interface that defines an operation named `checkedCast` is mapped to a proxy with a method named `_checkedCast`.

For `checkedCast`, if the passed proxy is for an object of type `Simple`, or a proxy for an object with a type derived from `Simple`, the cast returns a reference to a proxy of type `SimplePrx`; otherwise, if the passed proxy denotes an object of a different type (or if the passed proxy

is `None`), the cast returns `None`.

Given a proxy of any type, you can use a `checkedCast` to determine whether the corresponding object supports a given type, for example:

```

Python

obj = ...           # Get a proxy from somewhere...

simple = SimplePrx.checkedCast(obj)
if simple != None:
    # Object supports the Simple interface...
else:
    # Object is not of type Simple...
```

Note that a `checkedCast` contacts the server. This is necessary because only the implementation of an object in the server has definite knowledge of the type of an object. As a result, a `checkedCast` may throw a `ConnectTimeoutException` or an `ObjectNotExistException`.

In contrast, an `uncheckedCast` does not contact the server and unconditionally returns a proxy of the requested type. However, if you do use an `uncheckedCast`, you must be certain that the proxy really does support the type you are casting to; otherwise, if you get it wrong, you will most likely get a run-time exception when you invoke an operation on the proxy. The most likely error for such a type mismatch is `OperationNotExistException`. However, other exceptions, such as a marshaling exception are possible as well. And, if the object happens to have an operation with the correct name, but different parameter types, no exception may be reported at all and you simply end up sending the invocation to an object of the wrong type; that object may do rather nonsensical things. To illustrate this, consider the following two interfaces:

```

Slice

interface Process {
    void launch(int stackSize, int dataSize);
};

// ...

interface Rocket {
    void launch(float xCoord, float yCoord);
};
```

Suppose you expect to receive a proxy for a `Process` object and use an `uncheckedCast` to down-cast the proxy:

```

Python

obj = ...           # Get proxy...
process = ProcessPrx.uncheckedCast(obj) # No worries...
process.launch(40, 60)           # Oops...
```

If the proxy you received actually denotes a `Rocket` object, the error will go undetected by the Ice run time: because `int` and `float` have the same size and because the Ice protocol does not tag data with its type on the wire, the implementation of `Rocket::launch` will simply misinterpret the passed integers as floating-point numbers.

In fairness, this example is somewhat contrived. For such a mistake to go unnoticed at run time, both objects must have an operation with

the same name and, in addition, the run-time arguments passed to the operation must have a total marshaled size that matches the number of bytes that are expected by the unmarshaling code on the server side. In practice, this is extremely rare and an incorrect `uncheckedCast` typically results in a run-time exception.

Using Proxy Methods in Python

The base proxy class `ObjectPrx` supports a variety of [methods for customizing a proxy](#). Since proxies are immutable, each of these "factory methods" returns a copy of the original proxy that contains the desired modification. For example, you can obtain a proxy configured with a ten second timeout as shown below:

```

Python
proxy = communicator.stringToProxy(...)
proxy = proxy.ice_timeout(10000)

```

A factory method returns a new proxy object if the requested modification differs from the current proxy, otherwise it returns the current proxy. With few exceptions, factory methods return a proxy of the same type as the current proxy, therefore it is generally not necessary to repeat a down-cast after using a factory method. The example below demonstrates these semantics:

```

Python
base = communicator.stringToProxy(...)
hello = Demo.HelloPrx.checkedCast(base)
hello = hello.ice_timeout(10000) # Type is preserved
hello.sayHello()

```

The only exceptions are the factory methods `ice_facet` and `ice_identity`. Calls to either of these methods may produce a proxy for an object of an unrelated type, therefore they return a base proxy that you must subsequently down-cast to an appropriate type.

Object Identity and Proxy Comparison in Python

Proxy objects support comparison using the built-in relational operators as well as the `cmp` function. Note that proxy comparison uses *all* of the information in a proxy for the comparison. This means that not only the object identity must match for a comparison to succeed, but other details inside the proxy, such as the protocol and endpoint information, must be the same. In other words, comparison tests for *proxy* identity, *not* object identity. A common mistake is to write code along the following lines:

```

Python
p1 = ...          # Get a proxy...
p2 = ...          # Get another proxy...

if p1 != p2:
    # p1 and p2 denote different objects      # WRONG!
else:
    # p1 and p2 denote the same object        # Correct

```

Even though `p1` and `p2` differ, they may denote the same Ice object. This can happen because, for example, both `p1` and `p2` embed the same object identity, but each uses a different protocol to contact the target object. Similarly, the protocols may be the same, but denote

different endpoints (because a single Ice object can be contacted via several different transport endpoints). In other words, if two proxies compare equal, we know that the two proxies denote the same object (because they are identical in all respects); however, if two proxies compare unequal, we know absolutely nothing: the proxies may or may not denote the same object.

To compare the object identities of two proxies, you can use helper functions in the `Ice` module:

```
Python
```

```
def proxyIdentityCompare(lhs, rhs)
def proxyIdentityAndFacetCompare(lhs, rhs)
```

`proxyIdentityCompare` allows you to correctly compare proxies for identity:

```
Python
```

```
p1 = ...          # Get a proxy...
p2 = ...          # Get another proxy...

if Ice.proxyIdentityCompare(p1, p2) != 0:
    # p1 and p2 denote different objects      # Correct
else:
    # p1 and p2 denote the same object        # Correct
```

The function returns 0 if the identities are equal, 1 if `p1` is less than `p2`, and -1 if `p1` is greater than `p2`. (The comparison uses `name` as the major sort key and `category` as the minor sort key.)

The `proxyIdentityAndFacetCompare` function behaves similarly, but compares both the identity and the `facet name`.

See Also

- [Interfaces, Operations, and Exceptions](#)
- [Proxies](#)
- [Python Mapping for Operations](#)
- [Operations on Object](#)
- [Proxy Methods](#)
- [Facets and Versioning](#)
- [IceStorm](#)

Python Mapping for Operations

On this page:

- [Basic Python Mapping for Operations](#)
- [Normal and `idempotent` Operations in Python](#)
- [Passing Parameters in Python](#)
 - [In-Parameters in Python](#)
 - [Out-Parameters in Python](#)
 - [Parameter Type Mismatches in Python](#)
 - [Null Parameters in Python](#)
 - [Optional Parameters in Python](#)
- [Exception Handling in Python](#)

Basic Python Mapping for Operations

As we saw in the [Python mapping for interfaces](#), for each `operation` on an interface, the proxy class contains a corresponding method with the same name. To invoke an operation, you call it via the proxy. For example, here is part of the definitions for our `file system`:

```

Slice

module Filesystem {
    interface Node {
        idempotent string name();
    };
    // ...
};
```

The `name` operation returns a value of type `string`. Given a proxy to an object of type `Node`, the client can invoke the operation as follows:

```

Python

node = ...           # Initialize proxy
name = node.name()  # Get name via RPC
```

Normal and `idempotent` Operations in Python

You can add an `idempotent` qualifier to a `Slice` operation. As far as the signature for the corresponding proxy method is concerned, `idempotent` has no effect. For example, consider the following interface:

```

Slice

interface Example {
    string op1();
    idempotent string op2();
};
```

The proxy class for this is:

Python

```
class ExamplePrx(Ice.ObjectPrx):
    def op1(self, _ctx=None):
        # ...

    def op2(self, _ctx=None):
        # ...
```

Because `idempotent` affects an aspect of call dispatch, not interface, it makes sense for the two methods to look the same.

Passing Parameters in Python**In-Parameters in Python**

All parameters are passed by reference in the Python mapping; it is guaranteed that the value of a parameter will not be changed by the invocation.

Here is an interface with operations that pass parameters of various types from client to server:

Slice

```
struct NumberAndString {
    int x;
    string str;
};

sequence<string> StringSeq;

dictionary<long, StringSeq> StringTable;

interface ClientToServer {
    void op1(int i, float f, bool b, string s);
    void op2(NumberAndString ns, StringSeq ss, StringTable st);
    void op3(ClientToServer* proxy);
};
```

The Slice compiler generates the following proxy for this definition:

Python

```
class ClientToServerPrx(Ice.ObjectPrx):
    def op1(self, i, f, b, s, _ctx=None):
        # ...

    def op2(self, ns, ss, st, _ctx=None):
        # ...

    def op3(self, proxy, _ctx=None):
        # ...
```

Given a proxy to a `ClientToServer` interface, the client code can pass parameters as in the following example:

Python

```
p = ... # Get proxy...

p.op1(42, 3.14f, True, "Hello world!") # Pass simple literals

i = 42
f = 3.14f
b = True
s = "Hello world!"
p.op1(i, f, b, s) # Pass simple variables

ns = NumberAndString()
ns.x = 42
ns.str = "The Answer"
ss = [ "Hello world!" ]
st = {}
st[0] = ns
p.op2(ns, ss, st) # Pass complex variables

p.op3(p) # Pass proxy
```

Out-Parameters in Python

As in Java, Python functions do not support reference arguments. That is, it is not possible to pass an uninitialized variable to a Python function in order to have its value initialized by the function. The [Java mapping](#) overcomes this limitation with the use of *holder classes* that represent each `out` parameter. The Python mapping takes a different approach, one that is more natural for Python users.

The semantics of `out` parameters in the Python mapping depend on whether the operation returns one value or multiple values. An operation returns multiple values when it has declared multiple `out` parameters, or when it has declared a non-void return type and at least one `out` parameter.

If an operation returns multiple values, the client receives them in the form of a *result tuple*. A non-void return value, if any, is always the first element in the result tuple, followed by the `out` parameters in the order of declaration.

If an operation returns only one value, the client receives the value itself.

Here again are the same Slice definitions we saw earlier, but this time with all parameters being passed in the `out` direction:

```

Slice

struct NumberAndString {
    int x;
    string str;
};

sequence<string> StringSeq;

dictionary<long, StringSeq> StringTable;

interface ServerToClient {
    int op1(out float f, out bool b, out string s);
    void op2(out NumberAndString ns,
             out StringSeq ss,
             out StringTable st);
    void op3(out ServerToClient* proxy);
};

```

The Python mapping generates the following code for this definition:

```

Python

class ServerToClientPrx(Ice.ObjectPrx):
    def op1(self, _ctx=None):
        # ...

    def op2(self, _ctx=None):
        # ...

    def op3(self, _ctx=None):
        # ...

```

Given a proxy to a `ServerToClient` interface, the client code can receive the results as in the following example:

```

Python

p = ... # Get proxy...
i, f, b, s = p.op1()
ns, ss, st = p.op2()
stcp = p.op3()

```

The operations have no `in` parameters, therefore no arguments are passed to the proxy methods. Since `op1` and `op2` return multiple values, their result tuples are unpacked into separate values, whereas the return value of `op3` requires no unpacking.

Parameter Type Mismatches in Python

Although the Python compiler cannot check the types of arguments passed to a function, the Ice run time does perform validation on the arguments to a proxy invocation and reports any type mismatches as a `ValueError` exception.

Null Parameters in Python

Some Slice types naturally have "empty" or "not there" semantics. Specifically, sequences, dictionaries, and strings all can be `None`, but the corresponding Slice types do not have the concept of a null value. To make life with these types easier, whenever you pass `None` as a parameter or return value of type sequence, dictionary, or string, the Ice run time automatically sends an empty sequence, dictionary, or string to the receiver.

This behavior is useful as a convenience feature: especially for deeply-nested data types, members that are sequences, dictionaries, or strings automatically arrive as an empty value at the receiving end. This saves you having to explicitly initialize, for example, every string element in a large sequence before sending the sequence in order to avoid a run-time error. Note that using null parameters in this way does *not* create null semantics for Slice sequences, dictionaries, or strings. As far as the object model is concerned, these do not exist (only *empty* sequences, dictionaries, and strings do). For example, it makes no difference to the receiver whether you send a string as `None` or as an empty string: either way, the receiver sees an empty string.

Optional Parameters in Python

Optional parameters use the same mapping as required parameters. The only difference is that `Ice.Unset` can be passed as the value of an optional parameter or return value. Consider the following operation:

Slice
<pre>optional(1) int execute(optional(2) string params, out optional(3) float value);</pre>

A client can invoke this operation as shown below:

Python
<pre>i, v = proxy.execute("--file log.txt") i, v = proxy.execute(Ice.Unset) if v is not Ice.Unset: print("value = " + str(v))</pre>

A well-behaved program must always compare an optional parameter to `Ice.Unset` prior to using its value.

Exception Handling in Python

Any operation invocation may throw a [run-time exception](#) and, if the operation has an exception specification, may also throw [user exceptions](#). Suppose we have the following simple interface:

Slice

```
exception Tantrum {
    string reason;
};

interface Child {
    void askToCleanUp() throws Tantrum;
};
```

Slice exceptions are thrown as Python exceptions, so you can simply enclose one or more operation invocations in a `try-except` block:

Python

```
child = ...      # Get child proxy...

try:
    child.askToCleanUp()
except Tantrum, t:
    print "The child says:", t.reason
```

Typically, you will catch only a few exceptions of specific interest around an operation invocation; other exceptions, such as unexpected run-time errors, will usually be handled by exception handlers higher in the hierarchy. For example:

Python

```
import traceback, Ice

def run():
    child = ...      # Get child proxy...
    try:
        child.askToCleanUp()
    except Tantrum, t:
        print "The child says:", t.reason
        child.scold() # Recover from error...
        child.praise() # Give positive feedback...

try:
    # ...
    run()
    # ...
except Ice.Exception:
    traceback.print_exc()
```

This code handles a specific exception of local interest at the point of call and deals with other exceptions generically. (This is also the strategy we used for our first simple application in [Hello World Application](#).)

See Also

- [Operations](#)
- [Hello World Application](#)
- [Slice for a Simple File System](#)
- [Python Mapping for Operations](#)
- [Python Mapping for Interfaces](#)
- [Python Mapping for Exceptions](#)

Python Mapping for Classes

On this page:

- [Basic Python Mapping for Classes](#)
- [Inheritance from `Ice.Object` in Python](#)
- [Class Data Members in Python](#)
- [Class Constructors in Python](#)
- [Class Operations in Python](#)
- [Class Factories in Python](#)

Basic Python Mapping for Classes

A Slice `class` maps to a Python class with the same name. The generated class contains an attribute for each Slice data member (just as for structures and exceptions). Consider the following class definition:

```

Slice
class TimeOfDay {
    short hour;          // 0 - 23
    short minute;       // 0 - 59
    short second;       // 0 - 59
    string format();    // Return time as hh:mm:ss
};

```

The Python mapping generates the following code for this definition:

```

Python
class TimeOfDay(Ice.Object):
    def __init__(self, hour=0, minute=0, second=0):
        # ...
        self.hour = hour
        self.minute = minute
        self.second = second

    def ice_staticId():
        return '::M::TimeOfDay'
    ice_staticId = staticmethod(ice_staticId)

    # ...

    #
    # Operation signatures.
    #
    # def format(self, current=None):

```

There are a number of things to note about the generated code:

1. The generated class `TimeOfDay` inherits from `Ice.Object`. This means that all classes implicitly inherit from `Ice.Object`, which is the ultimate ancestor of all classes. Note that `Ice.Object` is *not* the same as `Ice.ObjectPrx`. In other words, you *cannot* pass a class where a proxy is expected and vice versa.

2. The constructor defines an attribute for each Slice data member.
3. The class defines the static method `ice_staticId`.
4. A comment summarizes the method signatures for each Slice operation.

There is quite a bit to discuss here, so we will look at each item in turn.

Inheritance from `Ice.Object` in Python

Like interfaces, classes implicitly inherit from a common base class, `Ice.Object`. However, as shown in the illustration below, classes inherit from `Ice.Object` instead of `Ice.ObjectPrx` (which is at the base of the inheritance hierarchy for proxies). As a result, you cannot pass a class where a proxy is expected (and vice versa) because the base types for classes and proxies are not compatible.

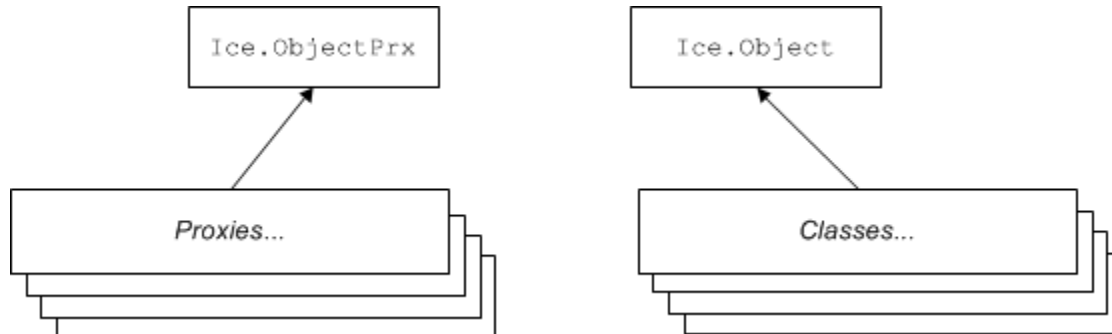

Inheritance from `Ice.ObjectPrx` and `Ice.Object`.

`Ice.Object` contains a number of methods:

```

Python
class Object(object):
    def ice_isA(self, id, current=None):
        # ...

    def ice_ping(self, current=None):
        # ...

    def ice_ids(self, current=None):
        # ...

    def ice_id(self, current=None):
        # ...

    def ice_staticId():
        # ...
    ice_staticId = staticmethod(ice_staticId)

    def ice_preMarshal(self):
        # ...

    def ice_postUnmarshal(self):
        # ...
  
```

The member functions of `Ice.Object` behave as follows:

- `ice_isA`
This method returns `true` if the object supports the given `type ID`, and `false` otherwise.
- `ice_ping`
As for interfaces, `ice_ping` provides a basic reachability test for the object.
- `ice_ids`
This method returns a string sequence representing all of the `type IDs` supported by this object, including `::Ice::Object`.
- `ice_id`
This method returns the actual run-time `type ID` of the object. If you call `ice_id` through a reference to a base instance, the returned `type ID` is the actual (possibly more derived) `type ID` of the instance.
- `ice_staticId`
This method is generated in each class and returns the static `type ID` of the class.
- `ice_preMarshal`
The Ice run time invokes this method prior to marshaling the object's state, providing the opportunity for a subclass to validate its declared data members.
- `ice_postUnmarshal`
The Ice run time invokes this method after unmarshaling an object's state. A subclass typically overrides this function when it needs to perform additional initialization using the values of its declared data members.

Note that neither `Ice.Object` nor the generated class override `__hash__` and `__eq__`, so the default implementations apply.

Class Data Members in Python

By default, data members of classes are mapped exactly as for structures and exceptions: for each data member in the Slice definition, the generated class contains a corresponding attribute.

Optional data members use the same mapping as required data members, but an optional data member can also be set to the marker value `Ice.Unset` to indicate that the member is unset. A well-behaved program must compare an optional data member to `Ice.Unset` before using the member's value:

Python
<pre>v = ... if v.optionalMember is Ice.Unset: print("optionalMember is unset") else: print("optionalMember = " + str(v.optionalMember))</pre>

Although Python provides no standard mechanism for restricting access to an object's attributes, by convention an attribute whose name begins with an underscore signals the author's intent that the attribute should only be accessed by the class itself or by one of its subclasses. You can employ this convention in your Slice classes using the `protected` metadata directive. The presence of this directive causes the Slice compiler to prepend an underscore to the mapped name of the data member. For example, the `TimeOfDay` class shown below has the `protected` metadata directive applied to each of its data members:

Slice

```
class TimeOfDay {
  ["protected"] short hour;    // 0 - 23
  ["protected"] short minute; // 0 - 59
  ["protected"] short second; // 0 - 59
  string format();           // Return time as hh:mm:ss
};
```

The Slice compiler produces the following generated code for this definition:

Python

```
class TimeOfDay(Ice.Object):
    def __init__(self, hour=0, minute=0, second=0):
        # ...
        self._hour = hour
        self._minute = minute
        self._second = second

    # ...

    #
    # Operation signatures.
    #
    # def format(self, current=None):
```

For a class in which all of the data members are protected, the metadata directive can be applied to the class itself rather than to each member individually. For example, we can rewrite the `TimeOfDay` class as follows:

Slice

```
["protected"] class TimeOfDay {
  short hour;           // 0 - 23
  short minute;        // 0 - 59
  short second;        // 0 - 59
  string format();     // Return time as hh:mm:ss
};
```

Class Constructors in Python

Classes have a constructor that assigns to each data member a default value appropriate for its type. You can also declare different default values for data members of primitive and enumerated types.

For derived classes, the constructor has one parameter for each of the base class's data members, plus one parameter for each of the derived class's data members, in base-to-derived order.

You can invoke this constructor in one of two ways:

- Provide values for all members, including [optional members](#), in the order of declaration:

Python

```
t = TimeOfDay(12, 33, 45)
t2 = TimeOfDay(14, 7) # second defaults to 0
```

Pass `Ice.Unset` as the value of any optional member you want to be unset.

- Used named arguments to specify values for certain members and in any order:

Python

```
t = TimeOfDay(minute=33, hour=12)
```

Class Operations in Python

Operations of classes are mapped to methods in the generated class. This means that, if a class contains operations (such as the `format` operation of our `TimeOfDay` class), you must provide an implementation of the operation in a class that is derived from the generated class. For example:

Python

```
class TimeOfDayI(TimeOfDay):
    def __init__(self, hour=0, minute=0, second=0):
        TimeOfDay.__init__(self, hour, minute, second)

    def format(self, current=None):
        return "%02d:%02d:%02d" % (self.hour, self.minute, self.second)
```

A Slice class such as `TimeOfDay` that declares or inherits an operation is inherently abstract. Python does not support the notion of abstract classes or abstract methods, therefore the mapping merely summarizes the required method signatures in a comment for your convenience. Furthermore, the mapping generates code in the constructor of an abstract class to prevent it from being instantiated directly; any attempt to do so raises a `RuntimeError` exception.

You may notice that the mapping for an operation adds an optional trailing parameter named `current`. For now, you can ignore this parameter and pretend it does not exist.

Class Factories in Python

Having created a class such as `TimeOfDayI`, we have an implementation and we can instantiate the `TimeOfDayI` class, but we cannot receive it as the return value or as an out-parameter from an operation invocation. To see why, consider the following simple interface:

Slice

```
interface Time {
    TimeOfDay get();
};
```

When a client invokes the `get` operation, the Ice run time must instantiate and return an instance of the `TimeOfDay` class. However, `TimeO`

`TimeOfDay` is an abstract class that cannot be instantiated. Unless we tell it, the Ice run time cannot magically know that we have created a `TimeOfDayI` class that implements the abstract `format` operation of the `TimeOfDay` abstract class. In other words, we must provide the Ice run time with a factory that knows that the `TimeOfDay` abstract class has a `TimeOfDayI` concrete implementation. The `Ice::Communicator` interface provides us with the necessary operations:

Slice
<pre> module Ice { local interface ObjectFactory { Object create(string type); void destroy(); }; local interface Communicator { void addObjectFactory(ObjectFactory factory, string id); ObjectFactory findObjectFactory(string id); // ... }; }; </pre>

To supply the Ice run time with a factory for our `TimeOfDayI` class, we must implement the `ObjectFactory` interface:

Python
<pre> class ObjectFactory(Ice.ObjectFactory): def create(self, type): if type == M.TimeOfDay.ice_staticId(): return TimeOfDayI() assert(False) return None def destroy(self): # Nothing to do pass </pre>

The object factory's `create` method is called by the Ice run time when it needs to instantiate a `TimeOfDay` class. The factory's `destroy` method is called by the Ice run time when its communicator is destroyed.

The `create` method is passed the `type ID` of the class to instantiate. For our `TimeOfDay` class, the type ID is `"::M::TimeOfDay"`. Our implementation of `create` checks the type ID: if it matches, the method instantiates and returns a `TimeOfDayI` object. For other type IDs, the method asserts because it does not know how to instantiate other types of objects.

Note that we used the `ice_staticId` method to obtain the type ID rather than embedding a literal string. Using a literal type ID string in your code is discouraged because it can lead to errors that are only detected at run time. For example, if a Slice class or one of its enclosing modules is renamed and the literal string is not changed accordingly, a receiver will fail to unmarshal the object and the Ice run time will raise `NoObjectFactoryException`. By using `ice_staticId` instead, we avoid any risk of a misspelled or obsolete type ID, and we can discover earlier whether a Slice class or module has been renamed.

Given a factory implementation, such as our `ObjectFactory`, we must inform the Ice run time of the existence of the factory:

Python

```
ic = ... # Get Communicator...
ic.addObjectFactory(ObjectFactory(), M.TimeOfDay.ice_staticId())
```

Now, whenever the Ice run time needs to instantiate a class with the type ID `"::M::TimeOfDay"`, it calls the `create` method of the registered `ObjectFactory` instance.

The `destroy` operation of the object factory is invoked by the Ice run time when the communicator is destroyed. This gives you a chance to clean up any resources that may be used by your factory. Do not call `destroy` on the factory while it is registered with the communicator — if you do, the Ice run time has no idea that this has happened and, depending on what your `destroy` implementation is doing, may cause undefined behavior when the Ice run time tries to next use the factory.

The run time guarantees that `destroy` will be the last call made on the factory, that is, `create` will not be called concurrently with `destroy`, and `create` will not be called once `destroy` has been called. However, calls to `create` can be made concurrently.

Note that you cannot register a factory for the same type ID twice: if you call `addObjectFactory` with a type ID for which a factory is registered, the Ice run time throws an `AlreadyRegisteredException`.

Finally, keep in mind that if a class has only data members, but no operations, you need not create and register an object factory to transmit instances of such a class. Only if a class has operations do you have to define and register an object factory.

See Also

- [Classes](#)
- [Type IDs](#)
- [Optional Data Members](#)
- [Python Mapping for Operations](#)
- [The Current Object](#)

Asynchronous Method Invocation (AMI) in Python

Asynchronous Method Invocation (AMI) is the term used to describe the client-side support for the asynchronous programming model. AMI supports both oneway and twoway requests, but unlike their synchronous counterparts, AMI requests never block the calling thread. When a client issues an AMI request, the Ice run time hands the message off to the local transport buffer or, if the buffer is currently full, queues the request for later delivery. The application can then continue its activities and poll or wait for completion of the invocation, or receive a callback when the invocation completes.

AMI is transparent to the server: there is no way for the server to tell whether a client sent a request synchronously or asynchronously.

i As of version 3.4, Ice provides a new API for asynchronous method invocation. This page describes the new API. Note that the old API is deprecated and will be removed in a future release.

On this page:

- [Basic Asynchronous API in Python](#)
 - [Asynchronous Proxy Methods in Python](#)
 - [Asynchronous Exception Semantics in Python](#)
- [AsyncResult Class in Python](#)
- [Polling for Completion in Python](#)
- [Completion Callbacks in Python](#)
- [Sharing State Between begin_ and end_ Methods in Python](#)
- [Asynchronous Oneway Invocations in Python](#)
- [Flow Control in Python](#)
- [Asynchronous Batch Requests in Python](#)
- [Concurrency Semantics for AMI in Python](#)

Basic Asynchronous API in Python

Consider the following simple Slice definition:

Slice

```
module Demo {
    interface Employees {
        string getName(int number);
    };
};
```

Asynchronous Proxy Methods in Python

Besides the synchronous proxy methods, the Python mapping generates the following asynchronous proxy methods:

Python

```
def begin_getName(self, number, _response=None, _ex=None,
                 _sent=None, _ctx=None)
def end_getName(self, result)
```

As you can see, the single `getName` operation results in `begin_getName` and `end_getName` methods. The `begin_` method optionally accepts a [per-invocation context](#) and [callbacks](#).

- The `begin_getName` method sends (or queues) an invocation of `getName`. This method does not block the calling thread.
- The `end_getName` method collects the result of the asynchronous invocation. If, at the time the calling thread calls `end_getName`, the result is not yet available, the calling thread blocks until the invocation completes. Otherwise, if the invocation completed some time before the call to `end_getName`, the method returns immediately with the result.

A client could call these methods as follows:

```

Python

e = EmployeePrx.checkedCast(...)
r = e.begin_getName(99)

# Continue to do other things here...

name = e.end_getName(r)
```

Because `begin_getName` does not block, the calling thread can do other things while the operation is in progress.

Note that `begin_getName` returns a value of type `AsyncResult`. This value contains the state that the Ice run time requires to keep track of the asynchronous invocation. You must pass the `AsyncResult` that is returned by the `begin_` method to the corresponding `end_` method.

The `begin_` method has one parameter for each in-parameter of the corresponding Slice operation. The `end_` method accepts the `AsyncResult` object as its only argument and returns the out-parameters using the [same semantics](#) as for regular synchronous invocations. For example, consider the following operation:

```

Slice

double op(int inp1, string inp2, out bool outp1, out long outp2);
```

The `begin_op` and `end_op` methods have the following signature:

```

Python

def begin_op(self, inp1, inp2, ...)
def end_op(self, result)
```

The call to `end_op` returns the following tuple:

```

Python

doubleValue, outp1, outp2 = p.end_op(result)
```

Asynchronous Exception Semantics in Python

If an invocation raises an exception, the exception is thrown by the `end_` method, even if the actual error condition for the exception was encountered during the `begin_` method ("on the way out"). The advantage of this behavior is that all exception handling is located with the code that calls the `end_` method (instead of being present twice, once where the `begin_` method is called, and again where the `end_` method is called).

There is one exception to the above rule: if you destroy the communicator and then make an asynchronous invocation, the `begin_` method throws `CommunicatorDestroyedException`. This is necessary because, once the run time is finalized, it can no longer throw an exception from the `end_` method.

The only other exception that is thrown by the `begin_` and `end_` methods is `RuntimeError`. This exception indicates that you have used the API incorrectly. For example, the `begin_` method throws this exception if you call an operation that has a return value or out-parameters on a oneway proxy. Similarly, the `end_` method throws this exception if you use a different proxy to call the `end_` method than the proxy you used to call the `begin_` method, or if the `AsyncResult` you pass to the `end_` method was obtained by calling the `begin_` method for a different operation.

AsyncResult Class in Python

The `AsyncResult` that is returned by the `begin_` method encapsulates the state of the asynchronous invocation:

Python
<pre>class AsyncResult: def getCommunicator() def getConnection() def getProxy() def getOperation() def isCompleted() def waitForCompleted() def isSent() def waitForSent() def throwLocalException() def sentSynchronously()</pre>

The methods have the following semantics:

- `getCommunicator()`
This method returns the communicator that sent the invocation.
- `getConnection()`
This method returns the connection that was used for the invocation. Note that, for typical asynchronous proxy invocations, this method returns a nil value because the possibility of automatic retries means the connection that is currently in use could change unexpectedly. The `getConnection` method only returns a non-nil value when the `AsyncResult` object is obtained by calling `begin_flushBatchRequests` on a `Connection` object.
- `getProxy()`
This method returns the proxy that was used to call the `begin_` method, or nil if the `AsyncResult` object was not obtained via an asynchronous proxy invocation.
- `getOperation()`
This method returns the name of the operation.
- `isCompleted()`
This method returns true if, at the time it is called, the result of an invocation is available, indicating that a call to the `end_` method will not block the caller. Otherwise, if the result is not yet available, the method returns false.
- `waitForCompleted()`

This method blocks the caller until the result of an invocation becomes available.

- `isSent()`
When you call the `begin_` method, the Ice run time attempts to write the corresponding request to the client-side transport. If the transport cannot accept the request, the Ice run time queues the request for later transmission. `isSent` returns true if, at the time it is called, the request has been written to the local transport (whether it was initially queued or not). Otherwise, if the request is still queued or an exception occurred before the request could be sent, `isSent` returns false.
- `waitForSent()`
This method blocks the calling thread until a request has been written to the client-side transport, or an exception occurs. After `waitForSent` returns, `isSent` returns true if the request was successfully written to the client-side transport, or false if an exception occurred. In the case of a failure, you can call the corresponding `end_` method or `throwLocalException` to obtain the exception.
- `throwLocalException()`
This method throws the local exception that caused the invocation to fail. If no exception has occurred yet, `throwLocalException` does nothing.
- `sentSynchronously()`
This method returns true if a request was written to the client-side transport without first being queued. If the request was initially queued, `sentSynchronously` returns false (independent of whether the request is still in the queue or has since been written to the client-side transport).

Polling for Completion in Python

The `AsyncResult` methods allow you to poll for call completion. Polling is useful in a variety of cases. As an example, consider the following simple interface to transfer files from client to server:

Slice
<pre>interface FileTransfer { void send(int offset, ByteSeq bytes); };</pre>

The client repeatedly calls `send` to send a chunk of the file, indicating at which offset in the file the chunk belongs. A naïve way to transmit a file would be along the following lines:

Python
<pre>file = open(...) ft = FileTransferPrx.checkedCast(...) chunkSize = ... offset = 0 while not file.eof(): bytes = file.read(chunkSize) # Read a chunk ft.send(offset, bytes) # Send the chunk offset += len(bytes.length)</pre>

This works, but not very well: because the client makes synchronous calls, it writes each chunk on the wire and then waits for the server to receive the data, process it, and return a reply before writing the next chunk. This means that both client and server spend much of their time doing nothing — the client does nothing while the server processes the data, and the server does nothing while it waits for the client to send the next chunk.

Using asynchronous calls, we can improve on this considerably:

Python

```

file = open(...)
ft = FileTransferPrx.checkedCast(...)
chunkSize = ...
offset = 0

results = []
numRequests = 5

while not file.eof():
    bytes = file.read(chunkSize) # Read a chunk

    # Send up to numRequests + 1 chunks asynchronously.
    r = ft.begin_send(offset, bytes)
    offset += len(bytes)

    # Wait until this request has been passed to the transport.
    r.waitForSent()
    results.append(r)

    # Once there are more than numRequests, wait for the least
    # recent one to complete.
    while len(results) > numRequests:
        r = results[0]
        del results[0]
        r.waitForCompleted()

    # Wait for any remaining requests to complete.
    while len(results) > 0:
        r = results[0]
        del results[0]
        r.waitForCompleted()

```

With this code, the client sends up to `numRequests + 1` chunks before it waits for the least recent one of these requests to complete. In other words, the client sends the next request without waiting for the preceding request to complete, up to the limit set by `numRequests`. In effect, this allows the client to "keep the pipe to the server full of data": the client keeps sending data, so both client and server continuously do work.

Obviously, the correct chunk size and value of `numRequests` depend on the bandwidth of the network as well as the amount of time taken by the server to process each request. However, with a little testing, you can quickly zoom in on the point where making the requests larger or queuing more requests no longer improves performance. With this technique, you can realize the full bandwidth of the link to within a percent or two of the theoretical bandwidth limit of a native socket connection.

Completion Callbacks in Python

The `begin_` method accepts three optional callback arguments that allow you to be notified asynchronously when a request completes. Here are the corresponding methods for the `getName` operation:

Python

```
def begin_getName(self, number, _response=None, _ex=None,
                 _sent=None, _ctx=None)
```

The value you pass for the response callback (`_response`), the exception callback (`_ex`), or the sent callback (`_sent`) argument must be a *callable object* such as a function or method. The response callback is invoked when the request completes successfully, and the exception callback is invoked when the operation raises an exception. (The sent callback is primarily used for [flow control](#).)

For example, consider the following callbacks for an invocation of the `getName` operation:

Python

```
def getNameCB(name):
    print "Name is: " + name

def failureCB(ex):
    print "Exception is: " + str(ex)
```

The response callback parameters depend on the operation signature. If the operation has a non-`void` return type, the first parameter of the response callback is the return value. The return value (if any) is followed by a parameter for each out-parameter of the corresponding Slice operation, in the order of declaration.

The exception callback is invoked if the invocation fails because of an Ice run time exception, or if the operation raises a user exception.

To inform the Ice run time that you want to receive callbacks for the completion of the asynchronous call, you pass the callbacks to the `begin_` method:

Python

```
e = EmployeesPrx.checkedCast(...)

e.begin_getName(99, getNameCB, failureCB)
```

Although the signature of an asynchronous proxy method implies that all of the callbacks are optional and therefore can be supplied in any combination, Ice enforces the following semantics at run time:

- If you omit all callbacks, you must call the `end_` method explicitly as described [earlier](#).
- If you supply either a response callback or a sent callback (or both), you must also supply an exception callback.
- You may omit the response callback for an operation that returns no data (that is, an operation with a `void` return type and no out-parameters).

Sharing State Between `begin_` and `end_` Methods in Python

It is common for the `end_` method to require access to some state that is established by the code that calls the `begin_` method. As an example, consider an application that asynchronously starts a number of operations and, as each operation completes, needs to update different user interface elements with the results. In this case, the `begin_` method knows which user interface element should receive the update, and the `end_` method needs access to that element.

Assuming that we have a `Widget` class that designates a particular user interface element, you could pass different widgets by storing the widget to be used as a member of a callback class:

Python

```
class MyCallback(object):
    def __init__(self, w):
        self._w = w

    def getNameCB(self, name):
        self._w.writeString(name)

    def failureCB(self, ex):
        print "Exception is: " + str(ex)
```

For this example, we assume that widgets have a `writeString` method that updates the relevant UI element.

When you call the `begin_` method, you pass the appropriate callback instance to inform the `end_` method how to update the display:

Python

```
e = EmployeesPrx.checkedCast(...)
widget1 = ...
widget2 = ...

# Invoke the getName operation with different widget callbacks.
cb1 = MyCallback(widget1)
e.begin_getName(99, cb1.getNameCB, cb1.failureCB)
cb2 = MyCallback(widget2)
e.begin_getName(24, cb2.getNameCB, cb2.failureCB)
```

The callback class provides a simple and effective way for you to pass state between the point where an operation is invoked and the point where its results are processed. Moreover, if you have a number of operations that share common state, you can pass the same callback instance to multiple invocations. (If you do this, your callback methods may need to use synchronization.)

For those situations in which a stateless callback is preferred, you can use a lambda function to pass state to a callback. Consider the following example:

Python

```
def getNameCB(name, w):
    w.writeString(name)

def failureCB(ex):
    print "Exception is: " + str(ex)

e = EmployeesPrx.checkedCast(...)
widget1 = ...
widget2 = ...

# Use lambda functions to pass state.
e.begin_getName(99, lambda name: getNameCB(name, widget1), failureCB)
e.begin_getName(24, lambda name: getNameCB(name, widget2), failureCB)
```

This strategy eliminates the need to encapsulate shared state in a callback class. Since lambda functions can refer to variables in the enclosing scope, they provide a convenient way to pass state directly to your callback.

Asynchronous Oneway Invocations in Python

You can invoke operations via oneway proxies asynchronously, provided the operation has `void` return type, does not have any out-parameters, and does not raise user exceptions. If you call the `begin_` method on a oneway proxy for an operation that returns values or raises a user exception, the `begin_` method throws a `RuntimeError`.

The callback signatures look exactly as for a twoway invocation, but the response method is never called and may be omitted.

Flow Control in Python

Asynchronous method invocations never block the thread that calls the `begin_` method: the Ice run time checks to see whether it can write the request to the local transport. If it can, it does so immediately in the caller's thread. (In that case, `AsyncResult.sentSynchronously` returns true.) Alternatively, if the local transport does not have sufficient buffer space to accept the request, the Ice run time queues the request internally for later transmission in the background. (In that case, `AsyncResult.sentSynchronously` returns false.)

This creates a potential problem: if a client sends many asynchronous requests at the time the server is too busy to keep up with them, the requests pile up in the client-side run time until, eventually, the client runs out of memory.

The API provides a way for you to implement flow control by counting the number of requests that are queued so, if that number exceeds some threshold, the client stops invoking more operations until some of the queued operations have drained out of the local transport.

You can supply a sent callback to be notified when the request was successfully sent:

Python

```
def response(name):
    # ...

def exception(ex):
    # ...

def sent(sentSynchronously):
    # ...
```

You inform the Ice run time that you want to be informed when a call has been passed to the local transport as usual:

Python

```
e.begin_getName(99, response, exception, sent)
```

If the Ice run time can immediately pass the request to the local transport, it does so and invokes the `sent` callback from the thread that calls the `begin_` method. On the other hand, if the run time has to queue the request, it calls the `sent` callback from a different thread once it has written the request to the local transport. The boolean `sentSynchronously` parameter indicates whether the request was sent synchronously or was queued.

The `sent` callback allows you to limit the number of queued requests by counting the number of requests that are queued and decrementing the count when the Ice run time passes a request to the local transport.

Asynchronous Batch Requests in Python

Applications that send [batched requests](#) can either flush a batch explicitly or allow the Ice run time to flush automatically. The proxy method `ice_flushBatchRequests` performs an immediate flush using the synchronous invocation model and may block the calling thread until the entire message can be sent. Ice also provides asynchronous versions of this method so you can flush batch requests asynchronously.

`begin_ice_flushBatchRequests` and `end_ice_flushBatchRequests` are proxy methods that flush any batch requests queued by that proxy.

In addition, similar methods are available on the communicator and the `Connection` object that is returned by `AsyncResult.getConnection`. These methods flush batch requests sent via the same communicator and via the same connection, respectively.

Concurrency Semantics for AMI in Python

The Ice run time always invokes your callback methods from a separate thread, with one exception: it calls the `sent` callback from the thread calling the `begin_` method if the request could be sent synchronously. In the `sent` callback, you know which thread is calling the callback by looking at the `sentSynchronously` parameter.

See Also

- [Python Mapping for Operations](#)
- [Request Contexts](#)
- [Batched Invocations](#)

Code Generation in Python

The Python mapping supports two forms of code generation: dynamic and static.

On this page:

- [Dynamic Code Generation in Python](#)
 - [Ice.loadSlice Options in Python](#)
 - [Locating Slice Files in Python](#)
 - [Loading Multiple Slice Files in Python](#)
- [Static Code Generation in Python](#)
 - [Compiler Output in Python](#)
 - [Include Files in Python](#)
- [Static Versus Dynamic Code Generation in Python](#)
 - [Application Considerations for Code Generation in Python](#)
 - [Mixing Static and Dynamic Code Generation in Python](#)
- [slice2py Command-Line Options](#)
- [Generating Packages in Python](#)

Dynamic Code Generation in Python

Using dynamic code generation, Slice files are "loaded" at run time and dynamically translated into Python code, which is immediately compiled and available for use by the application. This is accomplished using the `Ice.loadSlice` function, as shown in the following example:

Python
<pre>Ice.loadSlice("Color.ice") import M print "My favorite color is", M.Color.blue</pre>

For this example, we assume that `Color.ice` contains the following definitions:

Slice
<pre>module M { enum Color { red, green, blue }; };</pre>

The code imports module `M` after the Slice file is loaded because module `M` is not defined until the Slice definitions have been translated into Python.

Ice.loadSlice Options in Python

The `Ice.loadSlice` function behaves like a Slice compiler in that it accepts command-line arguments for specifying preprocessor options and controlling code generation. The arguments must include at least one Slice file.

The function has the following Python definition:

Python
<pre>def Ice.loadSlice(cmd, args=[])</pre>

The command-line arguments can be specified entirely in the first argument, `cmd`, which must be a string. The optional second argument can be used to pass additional command-line arguments as a list; this is useful when the caller already has the arguments in list form. The function always returns `None`.

For example, the following calls to `Ice.loadSlice` are functionally equivalent:

```

Python
Ice.loadSlice("-I/opt/IcePy/slice Color.ice")
Ice.loadSlice("-I/opt/IcePy/slice", ["Color.ice"])
Ice.loadSlice("", ["-I/opt/IcePy/slice", "Color.ice"])
```

In addition to the [standard compiler options](#), `Ice.loadSlice` also supports the following command-line options:

- `--all`
Generate code for all Slice definitions, including those from included files.
- `--checksum`
Generate [checksums](#) for Slice definitions.

Locating Slice Files in Python

If your Slice files depend on Ice types, you can avoid hard-coding the path name of your Ice installation directory by calling the `Ice.getSliceDir` function:

```

Python
Ice.loadSlice("-I" + Ice.getSliceDir() + " Color.ice")
```

This function attempts to locate the `slice` subdirectory of your Ice installation using an algorithm that succeeds for the following scenarios:

- Installation of a binary Ice archive
- Installation of an Ice source distribution using `make install`
- Installation via a Windows installer
- RPM installation on Linux
- Execution inside a compiled Ice source distribution

If the `slice` subdirectory can be found, `getSliceDir` returns its absolute path name, otherwise the function returns `None`.

Loading Multiple Slice Files in Python

You can specify as many Slice files as necessary in a single invocation of `Ice.loadSlice`, as shown below:

```

Python
Ice.loadSlice("Syscall.ice Process.ice")
```

Alternatively, you can call `Ice.loadSlice` several times:

Python

```
Ice.loadSlice("Syscall.ice")
Ice.loadSlice("Process.ice")
```

If a Slice file includes another file, the default behavior of `Ice.loadSlice` generates Python code only for the named file. For example, suppose `Syscall.ice` includes `Process.ice` as follows:

Slice

```
// Syscall.ice
#include <Process.ice>
...
```

If you call `Ice.loadSlice("-I. Syscall.ice")`, Python code is not generated for the Slice definitions in `Process.ice` or for any definitions that may be included by `Process.ice`. If you also need code to be generated for included files, one solution is to load them individually in subsequent calls to `Ice.loadSlice`. However, it is much simpler, not to mention more efficient, to use the `--all` option instead:

Python

```
Ice.loadSlice("--all -I. Syscall.ice")
```

When you specify `--all`, `Ice.loadSlice` generates Python code for all Slice definitions included directly or indirectly from the named Slice files.

There is no harm in loading a Slice file multiple times, aside from the additional overhead associated with code generation. For example, this situation could arise when you need to load multiple top-level Slice files that happen to include a common subset of nested files. Suppose that we need to load both `Syscall.ice` and `Kernel.ice`, both of which include `Process.ice`. The simplest way to load both files is with a single call to `Ice.loadSlice`:

Python

```
Ice.loadSlice("--all -I. Syscall.ice Kernel.ice")
```

Although this invocation causes the Ice extension to generate code twice for `Process.ice`, the generated code is structured so that the interpreter ignores duplicate definitions. We could have avoided generating unnecessary code with the following sequence of steps:

Python

```
Ice.loadSlice("--all -I. Syscall.ice")
Ice.loadSlice("-I. Kernel.ice")
```

In more complex cases, however, it can be difficult or impossible to completely avoid this situation, and the overhead of code generation is usually not significant enough to justify such an effort.

Static Code Generation in Python

You should be familiar with static code generation if you have used other Slice language mappings, such as C++ or Java. Using static code generation, the Slice compiler `slice2py` generates Python code from your Slice definitions.

Compiler Output in Python

For each Slice file `x.ice`, `slice2py` generates Python code into a file named `x_ice.py` in the output directory.

 Using the file name `x.py` would create problems if `x.ice` defined a module named `x`, therefore the suffix `_ice` is appended to the name of the generated file.

The default output directory is the current working directory, but a different directory can be specified using the `--output-dir` option.

In addition to the generated file, `slice2py` creates a Python package for each Slice module it encounters. A Python package is nothing more than a subdirectory that contains a file with a special name (`__init__.py`). This file is executed automatically by Python when a program first imports the package. It is created by `slice2py` and must not be edited manually. Inside the file is Python code to import the generated files that contain definitions in the Slice module of interest.

For example, the Slice files `Process.ice` and `Syscall.ice` both define types in the Slice module `OS`. First we present `Process.ice`:

```

Slice
module OS {
    interface Process {
        void kill();
    };
};

```

And here is `Syscall.ice`:

```

Slice
#include <Process.ice>
module OS {
    interface Syscall {
        Process getProcess(int pid);
    };
};

```

Next, we translate these files using the Slice compiler:

```
> slice2py -I. Process.ice Syscall.ice
```

If we list the contents of the output directory, we see the following entries:

Python

```
OS/
Process_ice.py
Syscall_ice.py
```

The subdirectory `OS` is the Python package that `slice2py` created for the Slice module `OS`. Inside this directory is the special file `__init__.py` that contains the following statements:

Python

```
import Process_ice
import Syscall_ice
```

Now when a Python program executes `import OS`, the two files `Process_ice.py` and `Syscall_ice.py` are implicitly imported.

Subsequent invocations of `slice2py` for Slice files that also contain definitions in the `OS` module result in additional `import` statements being added to `OS/__init__.py`. Be aware, however, that `import` statements may persist in `__init__.py` files after a Slice file is renamed or becomes obsolete. This situation may manifest itself as a run-time error if the interpreter can no longer locate the generated file while attempting to import the package. It may also cause more subtle problems, if an obsolete generated file is still present and being loaded unintentionally. In general, it is advisable to remove the package directory and regenerate it whenever the set of Slice files changes.

A Python program may also import a generated file explicitly, using a statement such as `import Process_ice`. Typically, however, it is more convenient to import the Python module once, rather than importing potentially several individual files that comprise the module, especially when you consider that the program must still import the module explicitly in order to make its definitions available. For example, it is much simpler to state

Python

```
import OS
```

rather than the following alternative:

Python

```
import Process_ice
import Syscall_ice
import OS
```

Include Files in Python

It is important to understand how `slice2py` handles include files. In the absence of the `--all` option, the compiler does not generate Python code for Slice definitions in included files. Rather, the compiler translates Slice `#include` statements into Python `import` statements in the following manner:

1. Determine the full pathname of the include file.
2. Create the shortest possible relative pathname for the include file by iterating over each of the include directories (specified using the `-I` option) and removing the leading directory from the include file if possible.

For example, if the full pathname of an include file is `/opt/App/slice/OS/Process.ice`, and we specified the options `-I/opt/`

App and `-I/opt/App/slice`, then the shortest relative pathname is `OS/Process.ice` after removing `/opt/App/slice`.

3. Replace any slashes with underscores, remove the `.ice` extension, and append `_ice`. Continuing our example from the previous step, the translated import statement becomes

```
import OS_Process_ice
```

There is a potential problem here that must be addressed. The generated `import` statement shown above expects to find the file `OS_Process_ice.py` somewhere in Python's search path. However, `slice2py` uses a different default name, `Process_ice.py`, when it compiles `Process.ice`. To resolve this issue, we must use the `--prefix` option when compiling `Process.ice`:

```
> slice2py --prefix OS_ Process.ice
```

The `--prefix` option causes the compiler to prepend the specified prefix to the name of each generated file. When executed, the above command creates the desired file name: `OS_Process_ice.py`.

It should be apparent by now that generating Python code for a complex Ice application requires a bit of planning. In particular, it is imperative that you be consistent in your use of `#include` statements, include directories, and `--prefix` options to ensure that the correct file names are used at all times.

Of course, these precautionary steps are only necessary when you are compiling Slice files individually. An alternative is to use the `--all` option and generate Python code for all of your Slice definitions into one Python source file. If you do not have a suitable Slice file that includes all necessary Slice definitions, you could write a "master" Slice file specifically for this purpose.

Static Versus Dynamic Code Generation in Python

There are several issues to consider when evaluating your requirements for code generation.

Application Considerations for Code Generation in Python

The requirements of your application generally dictate whether you should use dynamic or static code generation. Dynamic code generation is convenient for a number of reasons:

- it avoids the intermediate compilation step required by static code generation
- it makes the application more compact because the application requires only the Slice files, not the assortment of files and directories produced by static code generation
- it reduces complexity, which is especially helpful during testing, or when writing short or transient programs.

Static code generation, on the other hand, is appropriate in many situations:

- when an application uses a large number of Slice definitions and the startup delay must be minimized
- when it is not feasible to deploy Slice files with the application
- when a number of applications share the same Slice files
- when Python code is required in order to utilize third-party Python tools.

Mixing Static and Dynamic Code Generation in Python

Using a combination of static and dynamic translation in an application can produce unexpected results. For example, consider a situation where a dynamically-translated Slice file includes another Slice file that was statically translated:

Slice

```
// Slice
#include <Glacier2/Session.ice>

module App {
    interface SessionFactory {
        Glacier2::Session* createSession();
    };
};
```

The Slice file `Session.ice` is statically translated, as are all of the Slice files included with the Ice run time.

Assuming the above definitions are saved in `App.ice`, let's execute a simple Python script:

Python

```
# Python
import Ice
Ice.loadSlice("-I/opt/Ice/slice App.ice")

import Glacier2
class MyVerifier(Glacier2.PermissionsVerifier): # Error
    def checkPermissions(self, userId, password):
        return (True, "")
```

The code looks reasonable, but running it produces the following error:

```
'module' object has no attribute 'PermissionsVerifier'
```

Normally, importing the Glacier2 module as we have done here would load all of the Python code generated for the Glacier2 Slice files. However, since `App.ice` has already included a subset of the Glacier2 definitions, the Python interpreter ignores any subsequent requests to import the entire module, and therefore the `PermissionsVerifier` type is not present.

One way to address this problem is to import the statically-translated modules first, prior to loading Slice files dynamically:

Python

```
# Python
import Ice, Glacier2 # Import Glacier2 before App.ice is loaded
Ice.loadSlice("-I/opt/Ice/slice App.ice")

class MyVerifier(Glacier2.PermissionsVerifier): # OK
    def checkPermissions(self, userId, password):
        return (True, "")
```

The disadvantage of this approach in a non-trivial application is that it breaks encapsulation, forcing one Python module to know what other

modules are doing. For example, suppose we place our `PermissionsVerifier` implementation in a module named `verifier.py`:

```

Python
# Python
import Glacier2
class MyVerifier(Glacier2.PermissionsVerifier):
    def checkPermissions(self, userId, password):
        return (True, "")

```

Now that the use of `Glacier2` definitions is encapsulated in `verifier.py`, we would like to remove references to `Glacier2` from the main script:

```

Python
# Python
import Ice
Ice.loadSlice("-I/opt/Ice/slice App.ice")
...
import verifier # Error
v = verifier.MyVerifier()

```

Unfortunately, executing this script produces the same error as before. To fix it, we have to break the `verifier` module's encapsulation and import the `Glacier2` module in the main script because we know that the `verifier` module requires it:

```

Python
# Python
import Ice, Glacier2
Ice.loadSlice("-I/opt/Ice/slice App.ice")
...
import verifier # OK
v = verifier.MyVerifier()

```

Although breaking encapsulation in this way might offend our sense of good design, it is a relatively minor issue.

Another solution is to import the necessary submodules explicitly. We can safely remove the `Glacier2` reference from our main script after rewriting `verifier.py` as shown below:

```

Python
# Python
import Glacier2_PermissionsVerifier_ice
import Glacier2
class MyVerifier(Glacier2.PermissionsVerifier):
    def checkPermissions(self, userId, password):
        return (True, "")

```

Using the rules defined for [static code generation](#), we can derive the name of the module containing the code generated for `PermissionsVerifier.ice` and import it directly. We need a second `import` statement to make the `Glacier2` definitions accessible in this module.

slice2py Command-Line Options

The Slice-to-Python compiler, `slice2py`, offers the following command-line options in addition to the [standard options](#):

- `--all`
Generate code for all Slice definitions, including those from included files.
- `--checksum`
Generate [checksums](#) for Slice definitions.
- `--prefix PREFIX`
Use `PREFIX` as the prefix for [generated](#) file names.

Generating Packages in Python

By default, the scope of a Slice definition determines the [module](#) of its mapped Python construct. There are times, however, when applications require greater control over the packaging of generated Python code. For example, consider the following Slice definitions:

Slice
<pre> module sys { interface Process { // ... }; }; </pre>

Other language mappings can use these Slice definitions as shown, but they present a problem for the Python mapping: the top-level Slice module `sys` conflicts with Python's predefined module `sys`. A Python application executing the statement `import sys` would import whichever module the interpreter happens to locate first in its search path.

A workaround for this problem is to modify the Slice definitions so that the top-level module no longer conflicts with a predefined Python module, but that may not be feasible in certain situations. For example, the application may already be deployed using other language mappings, in which case the impact of modifying the Slice definitions could represent an unacceptable expense.

The Python mapping could have addressed this issue by considering the names of predefined modules to be reserved, in which case the Slice module `sys` would be mapped to the Python module `_sys`. However, the likelihood of a name conflict is relatively low to justify such a solution, therefore the mapping supports a different approach: global [metadata](#) can be used to enclose generated code in a Python package. Our modified Slice definitions demonstrate this feature:

Slice
<pre> [["python:package:zeroc"]] module sys { interface Process { // ... }; }; </pre>

The global metadata directive `python:package:zeroc` causes the mapping to generate all of the code resulting from definitions in this Slice file into the Python package `zeroc`. The net effect is the same as if we had enclosed our Slice definitions in the module `zeroc`: the

Slice module `sys` is mapped to the Python module `zeroc.sys`. However, by using metadata we have not affected the semantics of the Slice definitions, nor have we affected other language mappings.

See Also

- [Using the Slice Compilers](#)
- [Python Mapping for Modules](#)
- [Using Slice Checksums in Python](#)
- [Metadata](#)

Using Slice Checksums in Python

The Slice compilers can optionally generate [checksums](#) of Slice definitions. For `slice2py`, the `--checksum` option causes the compiler to generate code that adds checksums to the dictionary `Ice.sliceChecksums`. The checksums are installed automatically when the Python code is first imported; no action is required by the application.

In order to verify a server's checksums, a client could simply compare the dictionaries using the comparison operator. However, this is not feasible if it is possible that the server might return a superset of the client's checksums. A more general solution is to iterate over the local checksums as demonstrated below:

```

Python



```
serverChecksums = ...
for i in Ice.sliceChecksums:
 if not serverChecksums.has_key(i):
 # No match found for type id!
 elif Ice.sliceChecksums[i] != serverChecksums[i]:
 # Checksum mismatch!
```

```

In this example, the client first verifies that the server's dictionary contains an entry for each Slice type ID, and then it proceeds to compare the checksums.

See Also

- [Slice Checksums](#)

Example of a File System Client in Python

This page presents a very simple client to access a server that implements the file system we developed in [Slice for a Simple File System](#). The Python code shown here hardly differs from the code you would write for an ordinary Python program. This is one of the biggest advantages of using Ice: accessing a remote object is as easy as accessing an ordinary, local Python object. This allows you to put your effort where you should, namely, into developing your application logic instead of having to struggle with arcane networking APIs. This is true for the [server side](#) as well, meaning that you can develop distributed applications easily and efficiently.

We now have seen enough of the client-side Python mapping to develop a complete client to access our remote file system. For reference, here is the Slice definition once more:

```

Slice

module Filesystem {
    interface Node {
        idempotent string name();
    };

    exception GenericError {
        string reason;
    };

    sequence<string> Lines;

    interface File extends Node {
        idempotent Lines read();
        idempotent void write(Lines text) throws GenericError;
    };

    sequence<Node*> NodeSeq;

    interface Directory extends Node {
        idempotent NodeSeq list();
    };
};
```

To exercise the file system, the client does a recursive listing of the file system, starting at the root directory. For each node in the file system, the client shows the name of the node and whether that node is a file or directory. If the node is a file, the client retrieves the contents of the file and prints them.

The body of the client code looks as follows:

```

Python

import sys, traceback, Ice, Filesystem

# Recursively print the contents of directory "dir"
# in tree fashion. For files, show the contents of
# each file. The "depth" parameter is the current
# nesting level (for indentation).

def listRecursive(dir, depth):
```

```

indent = ''
depth = depth + 1
for i in range(depth):
    indent = indent + '\t'

contents = dir.list()

for node in contents:
    subdir = Filesystem.DirectoryPrx.checkedCast(node)
    file = Filesystem.FilePrx.uncheckedCast(node)
    print indent + node.name(),
    if subdir:
        print "(directory):"
        listRecursive(subdir, depth)
    else:
        print "(file):"
        text = file.read()
        for line in text:
            print indent + "\t" + line

status = 0
ic = None
try:
    # Create a communicator
    #
    ic = Ice.initialize(sys.argv)

    # Create a proxy for the root directory
    #
    obj = ic.stringToProxy("RootDir:default -p 10000")

    # Down-cast the proxy to a Directory proxy
    #
    rootDir = Filesystem.DirectoryPrx.checkedCast(obj)

    # Recursively list the contents of the root directory
    #
    print "Contents of root directory:"
    listRecursive(rootDir, 0)
except:
    traceback.print_exc()
    status = 1

if ic:
    # Clean up
    #
    try:
        ic.destroy()
    except:
        traceback.print_exc()

```

```
status = 1
```

```
sys.exit(status)
```

The program first defines the `listRecursive` function, which is a helper function to print the contents of the file system, and the main program follows. Let us look at the main program first:

1. The structure of the code follows what we saw in [Hello World Application](#). After initializing the run time, the client creates a proxy to the root directory of the file system. For this example, we assume that the server runs on the local host and listens using the default protocol (TCP/IP) at port 10000. The object identity of the root directory is known to be `RootDir`.
2. The client down-casts the proxy to `DirectoryPrx` and passes that proxy to `listRecursive`, which prints the contents of the file system.

Most of the work happens in `listRecursive`. The function is passed a proxy to a directory to list, and an indent level. (The indent level increments with each recursive call and allows the code to print the name of each node at an indent level that corresponds to the depth of the tree at that node.) `listRecursive` calls the `list` operation on the directory and iterates over the returned sequence of nodes:

1. The code does a `checkedCast` to narrow the `Node` proxy to a `Directory` proxy, as well as an `uncheckedCast` to narrow the `Node` proxy to a `File` proxy. Exactly one of those casts will succeed, so there is no need to call `checkedCast` twice: if the `Node` is-a `Directory`, the code uses the `DirectoryPrx` returned by the `checkedCast`; if the `checkedCast` fails, we know that the `Node` is-a `File` and, therefore, an `uncheckedCast` is sufficient to get a `FilePrx`.
In general, if you know that a down-cast to a specific type will succeed, it is preferable to use an `uncheckedCast` instead of a `checkedCast` because an `uncheckedCast` does not incur any network traffic.
2. The code prints the name of the file or directory and then, depending on which cast succeeded, prints "(directory)" or "(file)" following the name.
3. The code checks the type of the node:
 - If it is a directory, the code recurses, incrementing the indent level.
 - If it is a file, the code calls the `read` operation on the file to retrieve the file contents and then iterates over the returned sequence of lines, printing each line.

Assume that we have a small file system consisting of a two files and a directory as follows:

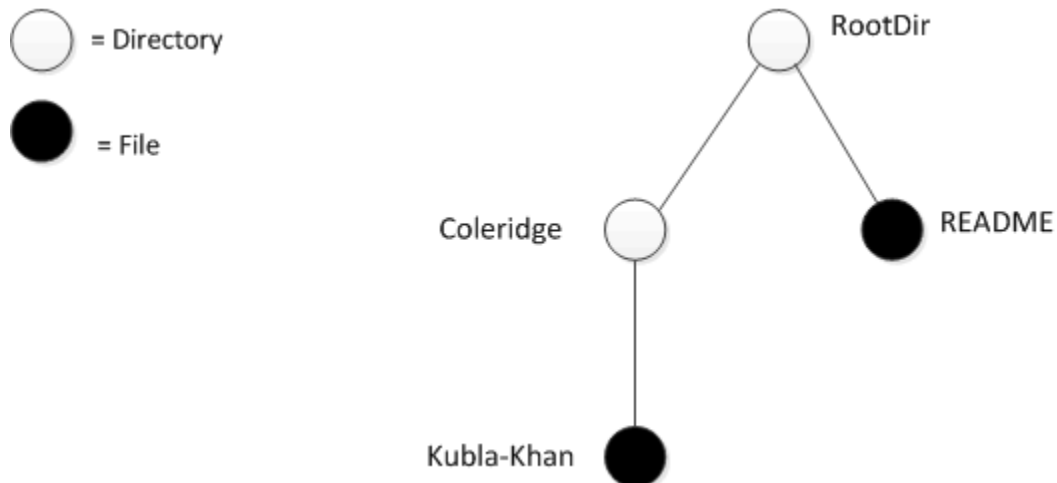

A small file system.

The output produced by the client for this file system is:

```
Contents of root directory:
```

```
  README (file):
```

```
    This file system contains a collection of poetry.
```

```
  Coleridge (directory):
```

```
    Kubla_Khan (file):
```

```
      In Xanadu did Kubla Khan
```

```
      A stately pleasure-dome decree:
```

```
      Where Alph, the sacred river, ran
```

```
      Through caverns measureless to man
```

```
      Down to a sunless sea.
```

Note that, so far, our client (and server) are not very sophisticated:

- The protocol and address information are hard-wired into the code.
- The client makes more remote procedure calls than strictly necessary; with minor redesign of the Slice definitions, many of these calls can be avoided.

We will see how to address these shortcomings in our discussions of [IceGrid](#) and [object life cycle](#).

See Also

- [Hello World Application](#)
- [Slice for a Simple File System](#)
- [Example of a File System Server in Python](#)
- [Object Life Cycle](#)
- [IceGrid](#)

Server-Side Slice-to-Python Mapping

The mapping for Slice data types to Python is identical on the client side and server side. This means that everything in the [Client-Side Slice-to-Python Mapping](#) section also applies to the server side. However, for the server side, there are a few additional things you need to know — specifically, how to:

- Initialize and finalize the server-side run time
- Implement servants
- Pass parameters and throw exceptions
- Create servants and register them with the Ice run time.

Although the examples in this chapter are simple, they accurately reflect the basics of writing an Ice server. Of course, for more sophisticated servers, you will be using [additional APIs](#), for example, to improve performance or scalability. However, these APIs are all described in [Slice](#), so, to use these APIs, you need not learn any Python mapping rules beyond those described here.

Topics

- [The Server-Side main Program in Python](#)
- [Server-Side Python Mapping for Interfaces](#)
- [Parameter Passing in Python](#)
- [Raising Exceptions in Python](#)
- [Object Incarnation in Python](#)
- [Asynchronous Method Dispatch \(AMD\) in Python](#)
- [Example of a File System Server in Python](#)

The Server-Side main Program in Python

This section discussed how to initialize and finalize the server-side run time.

On this page:

- [Initializing and Finalizing the Server-Side Run Time in Python](#)
- [The `Ice.Application` Class in Python](#)
 - [Using `Ice.Application` on the Client Side in Python](#)
 - [Catching Signals in Python](#)
 - [Ice.Application and Properties in Python](#)
 - [Limitations of `Ice.Application` in Python](#)

Initializing and Finalizing the Server-Side Run Time in Python

The main entry point to the Ice run time is represented by the local interface `Ice::Communicator`. As for the client side, you must initialize the Ice run time by calling `Ice.initialize` before you can do anything else in your server. `Ice.initialize` returns a reference to an instance of `Ice.Communicator`:

```

Python

import sys, traceback, Ice

status = 0
ic = None
try:
    ic = Ice.initialize(sys.argv)
    # ...
except:
    traceback.print_exc()
    status = 1

# ...
```

`Ice.initialize` accepts the argument list that is passed to the program by the operating system. The function scans the argument list for any command-line options that are relevant to the Ice run time; any such options are removed from the argument list so, when `Ice.initialize` returns, the only options and arguments remaining are those that concern your application. If anything goes wrong during initialization, `initialize` throws an exception.

You can pass a second argument of type `InitializationData` to `Ice.initialize`. `InitializationData` is defined as follows:

```

Python

class InitializationData(object):
    def __init__(self):
        self.properties = None
        self.logger = None
        self.threadHook = None
```

You can pass in an instance of this class to set `properties` for the communicator, establish a `logger`, and to establish a `thread notification hook`.

Before leaving your program, you *must* call `Communicator.destroy`. The `destroy` operation is responsible for finalizing the Ice run time.

In particular, `destroy` waits for any operation implementations that are still executing in the server to complete. In addition, `destroy` ensures that any outstanding threads are joined with and reclaims a number of operating system resources, such as file descriptors and memory. Never allow your program to terminate without calling `destroy` first; doing so has undefined behavior.

The general shape of our server-side program is therefore as follows:

```

Python

import sys, traceback, Ice

status = 0
ic = None
try:
    ic = Ice.initialize(sys.argv)
    # ...
except:
    traceback.print_exc()
    status = 1

if ic:
    try:
        ic.destroy()
    except:
        traceback.print_exc()
        status = 1

sys.exit(status)
```

Note that the code places the call to `Ice.initialize` into a `try` block and takes care to return the correct exit status to the operating system. Also note that an attempt to destroy the communicator is made only if the initialization succeeded.

The `Ice.Application` Class in Python

The preceding program structure is so common that `Ice` offers a class, `Ice.Application`, that encapsulates all the correct initialization and finalization activities. The synopsis of the class is as follows (with some detail omitted for now):

Python

```
class Application(object):

    def __init__(self, signalPolicy=0):

    def main(self, args, configFile=None, initData=None):

    def run(self, args):

    def appName():
        # ...
    appName = staticmethod(appName)

    def communicator():
        # ...
    communicator = staticmethod(communicator)
```

The intent of this class is that you specialize `Ice.Application` and implement the abstract `run` method in your derived class. Whatever code you would normally place in your main program goes into `run` instead. Using `Ice.Application`, our program looks as follows:

Python

```
import sys, Ice

class Server(Ice.Application):
    def run(self, args):
        # Server code here...
        return 0

app = Server()
status = app.main(sys.argv)
sys.exit(status)
```

You also can call `main` with an optional file name or an `InitializationData` structure. If you pass a [configuration file name](#) to `main`, the property settings in this file are overridden by settings in a file identified by the `ICE_CONFIG` environment variable (if defined). Property settings supplied on the [command line](#) take precedence over all other settings.

The `Application.main` function does the following:

1. It installs an exception handler. If your code fails to handle an exception, `Application.main` prints the exception information before returning with a non-zero return value.
2. It initializes (by calling `Ice.initialize`) and finalizes (by calling `Communicator.destroy`) a communicator. You can get access to the communicator for your server by calling the static `communicator` accessor.
3. It scans the argument list for options that are relevant to the Ice run time and removes any such options. The argument list that is passed to your `run` method therefore is free of Ice-related options and only contains options and arguments that are specific to your application.
4. It provides the name of your application via the static `appName` member function. The return value from this call is the first element of the argument vector passed to `Application.main`, so you can get at this name from anywhere in your code by calling `Ice.Application.appName` (which is often necessary for error messages).

5. It installs a signal handler that properly shuts down the communicator.
6. It installs a [per-process logger](#) if the application has not already configured one. The per-process logger uses the value of the `Ice.ProgramName` property as a prefix for its messages and sends its output to the standard error channel. An application can also specify an [alternate logger](#).

Using `Ice.Application` ensures that your program properly finalizes the Ice run time, whether your server terminates normally or in response to an exception or signal. We recommend that all your programs use this class; doing so makes your life easier. In addition, `Ice.Application` also provides features for signal handling and configuration that you do not have to implement yourself when you use this class.

Using `Ice.Application` on the Client Side in Python

You can use `Ice.Application` for your clients as well: simply implement a class that derives from `Ice.Application` and place the client code into its `run` method. The advantage of this approach is the same as for the server side: `Ice.Application` ensures that the communicator is destroyed correctly even in the presence of exceptions or signals.

Catching Signals in Python

The simple server we developed in [Hello World Application](#) had no way to shut down cleanly: we simply interrupted the server from the command line to force it to exit. Terminating a server in this fashion is unacceptable for many real-life server applications: typically, the server has to perform some cleanup work before terminating, such as flushing database buffers or closing network connections. This is particularly important on receipt of a signal or keyboard interrupt to prevent possible corruption of database files or other persistent data.

To make it easier to deal with signals, `Ice.Application` encapsulates Python's signal handling capabilities, allowing you to cleanly shut down on receipt of a signal:

Python

```

class Application(object):
    # ...
    def destroyOnInterrupt():
        # ...
    destroyOnInterrupt = classmethod(destroyOnInterrupt)

    def shutdownOnInterrupt():
        # ...
    shutdownOnInterrupt = classmethod(shutdownOnInterrupt)

    def ignoreInterrupt():
        # ...
    ignoreInterrupt = classmethod(ignoreInterrupt)

    def callbackOnInterrupt():
        # ...
    callbackOnInterrupt = classmethod(callbackOnInterrupt)

    def holdInterrupt():
        # ...
    holdInterrupt = classmethod(holdInterrupt)

    def releaseInterrupt():
        # ...
    releaseInterrupt = classmethod(releaseInterrupt)

    def interrupted():
        # ...
    interrupted = classmethod(interrupted)

    def interruptCallback(self, sig):
        # Default implementation does nothing.
        pass

```

The methods behave as follows:

- `destroyOnInterrupt`
This method installs a signal handler that destroys the communicator if it is interrupted. This is the default behavior.
- `shutdownOnInterrupt`
This method installs a signal handler that shuts down the communicator if it is interrupted.
- `ignoreInterrupt`
This method causes signals to be ignored.
- `callbackOnInterrupt`
This method configures `Ice.Application` to invoke `interruptCallback` when a signal occurs, thereby giving the subclass responsibility for handling the signal.
- `holdInterrupt`

This method temporarily blocks signal delivery.

- `releaseInterrupt`
This method restores signal delivery to the previous disposition. Any signal that arrives after `holdInterrupt` was called is delivered when you call `releaseInterrupt`.
- `interrupted`
This method returns `True` if a signal caused the communicator to shut down, `False` otherwise. This allows us to distinguish intentional shutdown from a forced shutdown that was caused by a signal. This is useful, for example, for logging purposes.
- `interruptCallback`
A subclass overrides this method to respond to signals. The function may be called concurrently with any other thread and must not raise exceptions.

By default, `Ice.Application` behaves as if `destroyOnInterrupt` was invoked, therefore our server program requires no change to ensure that the program terminates cleanly on receipt of a signal. (You can disable the signal-handling functionality of `Ice.Application` by passing `1` to the constructor. In that case, signals retain their default behavior, that is, terminate the process.) However, we add a diagnostic to report the occurrence of a signal, so our program now looks like:

Python

```

import sys, Ice

class MyApplication(Ice.Application):
    def run(self, args):

        # Server code here...

        if self.interrupted():
            print self.appName() + ": terminating"

        return 0

app = MyApplication()
status = app.main(sys.argv)
sys.exit(status)

```

Note that, if your server is interrupted by a signal, the Ice run time waits for all currently executing operations to finish. This means that an operation that updates persistent state cannot be interrupted in the middle of what it was doing and cause partial update problems.

Ice.Application and Properties in Python

Apart from the functionality shown in this section, `Ice.Application` also takes care of initializing the Ice run time with property values. [Properties](#) allow you to configure the run time in various ways. For example, you can use properties to control things such as the thread pool size or port number for a server. The `main` method of `Ice.Application` accepts an optional second parameter allowing you to specify the name of a [configuration file](#) that will be processed during initialization.

Limitations of Ice.Application in Python

`Ice.Application` is a singleton class that creates a single communicator. If you are using multiple communicators, you cannot use `Ice.Application`. Instead, you must structure your code as we saw in [Hello World Application](#) (taking care to always destroy the communicator).

See Also

- [Hello World Application](#)

- Properties and Configuration
- Communicator Initialization
- Logger Facility
- Thread Safety

Server-Side Python Mapping for Interfaces

The server-side mapping for interfaces provides an up-call API for the Ice run time: by implementing methods in a servant class, you provide the hook that gets the thread of control from the Ice server-side run time into your application code.

On this page:

- [Skeleton Classes in Python](#)
- [Servant Classes in Python](#)
 - [Server-Side Normal and idempotent Operations in Python](#)

Skeleton Classes in Python

On the client side, interfaces map to proxy classes. On the server side, interfaces map to *skeleton classes*. A skeleton is an abstract base class from which you derive your servant class and define a method for each operation on the corresponding interface. For example, consider our `Slice` definition for the `Node` interface:

```

Slice

module Filesystem {
    interface Node {
        idempotent string name();
    };
    // ...
};

```

The Python mapping generates the following definition for this interface:

```

Python

class Node(Ice.Object):
    def __init__(self):
        # ...

    #
    # Operation signatures.
    #
    # def name(self, current=None):

```

The important points to note here are:

- As for the client side, Slice modules are mapped to Python modules with the same name, so the skeleton class definitions are part of the `Filesystem` module.
- The name of the skeleton class is the same as the name of the Slice interface (`Node`).
- The skeleton class contains a comment summarizing the method signature of each operation in the Slice interface.
- The skeleton class is an abstract base class because its constructor prevents direct instantiation of the class.
- The skeleton class inherits from `Ice.Object` (which forms the root of the Ice object hierarchy).

Servant Classes in Python

In order to provide an implementation for an Ice object, you must create a servant class that inherits from the corresponding skeleton class. For example, to create a servant for the `Node` interface, you could write:

Python

```
import Filesystem

class NodeI(Filesystem.Node):
    def __init__(self, name):
        self._name = name

    def name(self, current=None):
        return self._name
```

By convention, servant classes have the name of their interface with an `I`-suffix, so the servant class for the `Node` interface is called `NodeI`. (This is a convention only: as far as the Ice run time is concerned, you can choose any name you prefer for your servant classes.) Note that `NodeI` extends `Filesystem.Node`, that is, it derives from its skeleton class.

As far as Ice is concerned, the `NodeI` class must implement only a single method: the `name` method that is defined in the `Node` interface. This makes the servant class a concrete class that can be instantiated. You can add other member functions and data members as you see fit to support your implementation. For example, in the preceding definition, we added a `_name` member and a constructor. (Obviously, the constructor initializes the `_name` member and the `name` function returns its value.)

Server-Side Normal and `idempotent` Operations in Python

Whether an operation is an ordinary operation or an `idempotent` operation has no influence on the way the operation is mapped. To illustrate this, consider the following interface:

Slice

```
interface Example {
    void normalOp();
    idempotent void idempotentOp();
};
```

The mapping for this interface is shown below:

Python

```
class Example(Ice.Object):
    # ...

    #
    # Operation signatures.
    #
    # def normalOp(self, current=None):
    # def idempotentOp(self, current=None):
```

Note that the signatures of the methods are unaffected by the `idempotent` qualifier.

See Also

- [Slice for a Simple File System](#)

- [Python Mapping for Interfaces](#)
- [Parameter Passing in Python](#)
- [Raising Exceptions in Python](#)

Parameter Passing in Python

For each `in` parameter of a Slice operation, the Python mapping generates a corresponding parameter for the method in the skeleton. In addition, every operation has a trailing parameter of type `Ice.Current`. For example, the `name` operation of the `Node` interface has no parameters, but the `name` method in a Python servant has a `current` parameter. We will ignore this parameter for now.

Parameter passing on the server side follows the rules for the `client side`. An operation returning multiple values returns them in a tuple consisting of a non-`void` return value, if any, followed by the `out` parameters in the order of declaration. An operation returning only one value simply returns the value itself.

i An operation returns multiple values when it declares multiple `out` parameters, or when it declares a non-`void` return type and at least one `out` parameter.

To illustrate these rules, consider the following interface that passes string parameters in all possible directions:

```

Slice

interface Example {
    string op1(string sin);
    void op2(string sin, out string sout);
    string op3(string sin, out string sout);
};

```

The generated skeleton class for this interface looks as follows:

```

Python

class Example(Ice.Object):
    def __init__(self):
        # ...

    #
    # Operation signatures.
    #
    # def op1(self, sin, current=None):
    # def op2(self, sin, current=None):
    # def op3(self, sin, current=None):

```

The signatures of the Python methods are identical because they all accept a single `in` parameter, but their implementations differ in the way they return values. For example, we could implement the operations as follows:

Python

```
class ExampleI(Example):
    def op1(self, sin, current=None):
        print sin          # In params are initialized
        return "Done"     # Return value

    def op2(self, sin, current=None):
        print sin          # In params are initialized
        return "Hello World!" # Out parameter

    def op3(self, sin, current=None):
        print sin          # In params are initialized
        return ("Done", "Hello World!")
```

Notice that `op1` and `op2` return their string values directly, whereas `op3` returns a tuple consisting of the return value followed by the out parameter.

This code is in no way different from what you would normally write if you were to pass strings to and from a function; the fact that remote procedure calls are involved does not impact your code in any way. The same is true for parameters of other types, such as proxies, classes, or dictionaries: the parameter passing conventions follow normal Python rules and do not require special-purpose API calls.

See Also

- [Server-Side Python Mapping for Interfaces](#)
- [Python Mapping for Operations](#)
- [Raising Exceptions in Python](#)
- [The Current Object](#)

Raising Exceptions in Python

To throw an exception from an operation implementation, you simply instantiate the exception, initialize it, and throw it. For example:

```

Python
class FileI(Filesystem.File):
    # ...

    def write(self, text, current=None):
        # Try to write the file contents here...
        # Assume we are out of space...
        if error:
            e = Filesystem.GenericError()
            e.reason = "file too large"
            raise e

```

The [mapping for exceptions](#) generates a constructor that accepts values for data members, so we can simplify this example by changing our `raise` statement to the following:

```

Python
class FileI(Filesystem.File):
    # ...

    def write(self, text, current=None):
        # Try to write the file contents here...
        # Assume we are out of space...
        if error:
            raise Filesystem.GenericError("file too large")

```

If you throw an arbitrary Python run-time exception, the Ice run time catches the exception and then returns an `UnknownException` to the client. Similarly, if you throw an "impossible" user exception (a user exception that is not listed in the exception specification of the operation), the client receives an `UnknownUserException`.

If you throw a run-time exception, such as `MemoryLimitException`, the client receives an `UnknownLocalException`. For that reason, you should never throw system exceptions from operation implementations. If you do, all the client will see is an `UnknownLocalException`, which does not tell the client anything useful.



Three run-time exceptions are [treated specially](#) and not changed to `UnknownLocalException` when returned to the client: `ObjectNotExistException`, `OperationNotExistException`, and `FacetNotExistException`.

See Also

- [Run-Time Exceptions](#)
- [Server-Side Python Mapping for Interfaces](#)
- [Python Mapping for Exceptions](#)
- [Facets and Versioning](#)

Object Incarnation in Python

Having created a servant class such as the rudimentary `NodeI` class, you can instantiate the class to create a concrete servant that can receive invocations from a client. However, merely instantiating a servant class is insufficient to incarnate an object. Specifically, to provide an implementation of an Ice object, you must take the following steps:

1. [Instantiate a servant class.](#)
2. [Create an identity](#) for the Ice object incarnated by the servant.
3. Inform the Ice run time of the existence of the servant.
4. [Pass a proxy](#) for the object to a client so the client can reach it.

On this page:

- [Instantiating a Python Servant](#)
- [Creating an Identity in Python](#)
- [Activating a Python Servant](#)
- [UUIDs as Identities in Python](#)
- [Creating Proxies in Python](#)
 - [Proxies and Servant Activation in Python](#)
 - [Direct Proxy Creation in Python](#)

Instantiating a Python Servant

Instantiating a servant means to allocate an instance:

Python
<pre>servant = NodeI("Fred")</pre>

This statement creates a new `NodeI` instance and assigns its reference to the variable `servant`.

Creating an Identity in Python

Each Ice object requires an identity. That identity must be unique for all servants using the same object adapter.



The Ice object model assumes that all objects (regardless of their adapter) have a [globally unique identity](#).

An Ice object identity is a structure with the following Slice definition:

Slice
<pre>module Ice { struct Identity { string name; string category; }; // ... };</pre>

The full identity of an object is the combination of both the `name` and `category` fields of the `Identity` structure. For now, we will leave the `category` field as the empty string and simply use the `name` field. (The `category` field is most often used in conjunction with [servant locators](#).)

To create an identity, we simply assign a key that identifies the servant to the `name` field of the `Identity` structure:

```

Python
id = Ice.Identity()
id.name = "Fred" # Not unique, but good enough for now

```

Note that the [mapping for structures](#) allows us to write the following equivalent code:

```

Python
id = Ice.Identity("Fred") # Not unique, but good enough for now

```

Activating a Python Servant

Merely creating a servant instance does nothing: the Ice run time becomes aware of the existence of a servant only once you explicitly tell the object adapter about the servant. To activate a servant, you invoke the `add` operation on the object adapter. Assuming that we have access to the object adapter in the `adapter` variable, we can write:

```

Python
adapter.add(servant, id)

```

Note the two arguments to `add`: the servant and the object identity. Calling `add` on the object adapter adds the servant and the servant's identity to the adapter's servant map and links the proxy for an Ice object to the correct servant instance in the server's memory as follows:

1. The proxy for an Ice object, apart from addressing information, contains the identity of the Ice object. When a client invokes an operation, the object identity is sent with the request to the server.
2. The object adapter receives the request, retrieves the identity, and uses the identity as an index into the servant map.
3. If a servant with that identity is active, the object adapter retrieves the servant from the servant map and dispatches the incoming request into the correct member function on the servant.

Assuming that the object adapter is in the `active` state, client requests are dispatched to the servant as soon as you call `add`.

UUIDs as Identities in Python

The Ice object model assumes that object identities are globally unique. One way of ensuring that uniqueness is to use UUIDs (Universally Unique Identifiers) as identities. The `Ice.generateUUID` function creates such identities:

```

Python
import Ice
print Ice.generateUUID()

```

When executed, this program prints a unique string such as `5029a22c-e333-4f87-86b1-cd5e0fcce509`. Each call to `generateUUID` creates a string that differs from all previous ones.

You can use a UUID such as this to create object identities. For convenience, the object adapter has an operation `addWithUUID` that generates a UUID and adds a servant to the servant map in a single step. Using this operation, we can create an identity and register a servant with that identity in a single step as follows:

Python

```
adapter.addWithUUID(NodeI("Fred"))
```

Creating Proxies in Python

Once we have activated a servant for an Ice object, the server can process incoming client requests for that object. However, clients can only access the object once they hold a proxy for the object. If a client knows the server's address details and the object identity, it can create a proxy from a string, as we saw in our first example in [Hello World Application](#). However, creation of proxies by the client in this manner is usually only done to allow the client access to initial objects for bootstrapping. Once the client has an initial proxy, it typically obtains further proxies by invoking operations.

The object adapter contains all the details that make up the information in a proxy: the addressing and protocol information, and the object identity. The Ice run time offers a number of ways to create proxies. Once created, you can pass a proxy to the client as the return value or as an out-parameter of an operation invocation.

Proxies and Servant Activation in Python

The `add` and `addWithUUID` servant activation operations on the object adapter return a proxy for the corresponding Ice object. This means we can write:

Python

```
proxy = adapter.addWithUUID(NodeI("Fred"))
nodeProxy = Filesystem.NodePrx.uncheckedCast(proxy)

# Pass nodeProxy to client...
```

Here, `addWithUUID` both activates the servant and returns a proxy for the Ice object incarnated by that servant in a single step.

Note that we need to use an `uncheckedCast` here because `addWithUUID` returns a proxy of type `Ice.ObjectPrx`.

Direct Proxy Creation in Python

The object adapter offers an operation to create a proxy for a given identity:

Slice

```
module Ice {
    local interface ObjectAdapter {
        Object* createProxy(Identity id);
        // ...
    };
};
```

Note that `createProxy` creates a proxy for a given identity whether a servant is activated with that identity or not. In other words, proxies have a life cycle that is quite independent from the life cycle of servants:

Python

```
id = Ice.Identity()  
id.name = Ice.generateUUID()  
proxy = adapter.createProxy(id)
```

This creates a proxy for an Ice object with the identity returned by `generateUUID`. Obviously, no servant yet exists for that object so, if we return the proxy to a client and the client invokes an operation on the proxy, the client will receive an `ObjectNotExistException`. (We examine these life cycle issues in more detail in [Object Life Cycle](#).)

See Also

- [Hello World Application](#)
- [Python Mapping for Structures](#)
- [Server-Side Python Mapping for Interfaces](#)
- [Object Adapter States](#)
- [Servant Locators](#)
- [Object Life Cycle](#)

Asynchronous Method Dispatch (AMD) in Python

The number of simultaneous synchronous requests a server is capable of supporting is determined by the number of threads in the server's [thread pool](#). If all of the threads are busy dispatching long-running operations, then no threads are available to process new requests and therefore clients may experience an unacceptable lack of responsiveness.

Asynchronous Method Dispatch (AMD), the server-side equivalent of [AMI](#), addresses this scalability issue. Using AMD, a server can receive a request but then suspend its processing in order to release the dispatch thread as soon as possible. When processing resumes and the results are available, the server sends a response explicitly using a callback object provided by the Ice run time.

AMD is transparent to the client, that is, there is no way for a client to distinguish a request that, in the server, is processed synchronously from a request that is processed asynchronously.

In practical terms, an AMD operation typically queues the request data (i.e., the callback object and operation arguments) for later processing by an application thread (or thread pool). In this way, the server minimizes the use of dispatch threads and becomes capable of efficiently supporting thousands of simultaneous clients.

An alternate use case for AMD is an operation that requires further processing after completing the client's request. In order to minimize the client's delay, the operation returns the results while still in the dispatch thread, and then continues using the dispatch thread for additional work.

On this page:

- [Enabling AMD with Metadata in Python](#)
- [AMD Mapping in Python](#)
- [AMD Exceptions in Python](#)
- [AMD Example in Python](#)

Enabling AMD with Metadata in Python

To enable asynchronous dispatch, you must add an ["amd"] metadata directive to your Slice definitions. The directive applies at the interface and the operation level. If you specify ["amd"] at the interface level, all operations in that interface use asynchronous dispatch; if you specify ["amd"] for an individual operation, only that operation uses asynchronous dispatch. In either case, the metadata directive *replaces* synchronous dispatch, that is, a particular operation implementation must use synchronous or asynchronous dispatch and cannot use both.

Consider the following Slice definitions:

Slice
<pre>["amd"] interface I { bool isValid(); float computeRate(); }; interface J { ["amd"] void startProcess(); int endProcess(); };</pre>

In this example, both operations of interface `I` use asynchronous dispatch, whereas, for interface `J`, `startProcess` uses asynchronous dispatch and `endProcess` uses synchronous dispatch.

Specifying metadata at the operation level (rather than at the interface or class level) minimizes the amount of generated code and, more importantly, minimizes complexity: although the asynchronous model is more flexible, it is also more complicated to use. It is therefore in your best interest to limit the use of the asynchronous model to those operations that need it, while using the simpler synchronous model for the rest.

AMD Mapping in Python

For each AMD operation, the Python mapping emits a dispatch method with the same name as the operation and the suffix `_async`. This method returns `None`. The first parameter is a reference to a callback object, as described below. The remaining parameters comprise the `in` parameters of the operation, in the order of declaration.

The callback object defines two methods:

- `def ice_response(self, <params>)`
The `ice_response` method allows the server to report the successful completion of the operation. If the operation has a non-void return type, the first parameter to `ice_response` is the return value. Parameters corresponding to the operation's `out` parameters follow the return value, in the order of declaration.
- `def ice_exception(self, ex)`
The `ice_exception` method allows the server to report an exception.

Neither `ice_response` nor `ice_exception` throw any exceptions to the caller.

Suppose we have defined the following operation:

```

Slice
interface I {
    ["amd"] int foo(short s, out long l);
};

```

The callback interface generated for operation `foo` is shown below:

```

Python
class ...
    #
    # Operation signatures.
    #
    # def ice_response(self, _result, l)
    # def ice_exception(self, ex)

```

The dispatch method for asynchronous invocation of operation `foo` is generated as follows:

```

Python
def foo_async(self, __cb, s)

```

AMD Exceptions in Python

There are two processing contexts in which the logical implementation of an AMD operation may need to report an exception: the dispatch thread (the thread that receives the invocation), and the response thread (the thread that sends the response).

 These are not necessarily two different threads: it is legal to send the response from the dispatch thread.

Although we recommend that the callback object be used to report all exceptions to the client, it is legal for the implementation to raise an exception instead, but only from the dispatch thread.

As you would expect, an exception raised from a response thread cannot be caught by the Ice run time; the application's run time environment determines how such an exception is handled. Therefore, a response thread must ensure that it traps all exceptions and sends the appropriate response using the callback object. Otherwise, if a response thread is terminated by an uncaught exception, the request may never be completed and the client might wait indefinitely for a response.

Whether raised in a dispatch thread or reported via the callback object, user exceptions are [validated](#) and local exceptions may undergo [translation](#).

AMD Example in Python

To demonstrate the use of AMD in Ice, let us define the Slice interface for a simple computational engine:

Slice
<pre> module Demo { sequence<float> Row; sequence<Row> Grid; exception RangeError {}; interface Model { ["amd"] Grid interpolate(Grid data, float factor) throws RangeError; }; }; </pre>

Given a two-dimensional grid of floating point values and a factor, the `interpolate` operation returns a new grid of the same size with the values interpolated in some interesting (but unspecified) way.

Our servant class derives from `Demo.Model` and supplies a definition for the `interpolate_async` method that creates a `Job` to hold the callback object and arguments, and adds the `Job` to a queue. The method uses a lock to guard access to the queue:

Python
<pre> class ModelI(Demo.Model): def __init__(self): self._mutex = threading.Lock() self._jobs = [] def interpolate_async(self, cb, data, factor, current=None): self._mutex.acquire() try: self._jobs.append(Job(cb, data, factor)) finally: self._mutex.release() </pre>

After queuing the information, the operation returns control to the Ice run time, making the dispatch thread available to process another request. An application thread removes the next `Job` from the queue and invokes `execute`, which uses `interpolateGrid` (not shown) to perform the computational work:

Python

```

class Job(object):
    def __init__(self, cb, grid, factor):
        self._cb = cb
        self._grid = grid
        self._factor = factor

    def execute(self):
        if not self.interpolateGrid():
            self._cb.ice_exception(Demo.RangeError())
            return
        self._cb.ice_response(self._grid)

    def interpolateGrid(self):
        # ...

```

If `interpolateGrid` returns `False`, then `ice_exception` is invoked to indicate that a range error has occurred. The `return` statement following the call to `ice_exception` is necessary because `ice_exception` does not throw an exception; it only marshals the exception argument and sends it to the client.

If interpolation was successful, `ice_response` is called to send the modified grid back to the client.

See Also

- [User Exceptions](#)
- [Run-Time Exceptions](#)
- [Asynchronous Method Invocation \(AMI\) in Python](#)
- [The Ice Threading Model](#)

Example of a File System Server in Python

This page presents the source code for a Python server that implements our [file system](#) and communicates with the [client](#) we wrote earlier.

The server is remarkably free of code that relates to distribution: most of the server code is simply application logic that would be present just the same as a non-distributed version. Again, this is one of the major advantages of Ice: distribution concerns are kept away from application code so that you can concentrate on developing application logic instead of networking infrastructure.

On this page:

- [Implementing a File System Server in Python](#)
- [Server Main Program in Python](#)
 - [FileI Servant Class in Python](#)
 - [DirectoryI Servant Class in Python](#)
 - [DirectoryI Data Members in Python](#)
 - [DirectoryI Constructor in Python](#)
 - [DirectoryI Methods in Python](#)
- [Thread Safety in Python](#)

Implementing a File System Server in Python

We have now seen enough of the server-side Python mapping to implement a server for our [file system](#). (You may find it useful to review these Slice definitions before studying the source code.)

Our server is implemented in a single source file, `Server.py`, containing our server's main program as well as the definitions of our `Directory` and `File` servant subclasses.

Server Main Program in Python

Our server main program uses the `Ice.Application` class. The `run` method installs a signal handler, creates an object adapter, instantiates a few servants for the directories and files in the file system, and then activates the adapter. This leads to a main program as follows:

```

Python

import sys, threading, Ice, Filesystem

# DirectoryI servant class ...
# FileI servant class ...

class Server(Ice.Application):
    def run(self, args):
        # Terminate cleanly on receipt of a signal
        #
        self.shutdownOnInterrupt()

        # Create an object adapter (stored in the _adapter
        # static members)
        #
        adapter = self.communicator().createObjectAdapterWithEndpoints(
            "SimpleFilesystem", "default -p 10000")
        DirectoryI._adapter = adapter
        FileI._adapter = adapter

        # Create the root directory (with name "/" and no parent)
        #
```

```
root = DirectoryI("/", None)

# Create a file called "README" in the root directory
#
file = FileI("README", root)
text = [ "This file system contains a collection of poetry." ]
try:
    file.write(text)
except Filesystem.GenericError, e:
    print e.reason

# Create a directory called "Coleridge"
# in the root directory
#
coleridge = DirectoryI("Coleridge", root)

# Create a file called "Kubla_Khan"
# in the Coleridge directory
#
file = FileI("Kubla_Khan", coleridge)
text = [ "In Xanadu did Kubla Khan",
        "A stately pleasure-dome decree:",
        "Where Alph, the sacred river, ran",
        "Through caverns measureless to man",
        "Down to a sunless sea." ]
try:
    file.write(text)
except Filesystem.GenericError, e:
    print e.reason

# All objects are created, allow client requests now
#
adapter.activate()

# Wait until we are done
#
self.communicator().waitForShutdown()

if self.interrupted():
    print self.appName() + ": terminating"

return 0
```

```
app = Server()
sys.exit(app.main(sys.argv))
```

The code defines the `Server` class, which derives from `Ice.Application` and contains the main application logic in its `run` method. Much of this code is boiler plate that we saw previously: we create an object adapter, and, towards the end, activate the object adapter and call `waitForShutdown`.

The interesting part of the code follows the adapter creation: here, the server instantiates a few nodes for our file system to create the structure shown below:

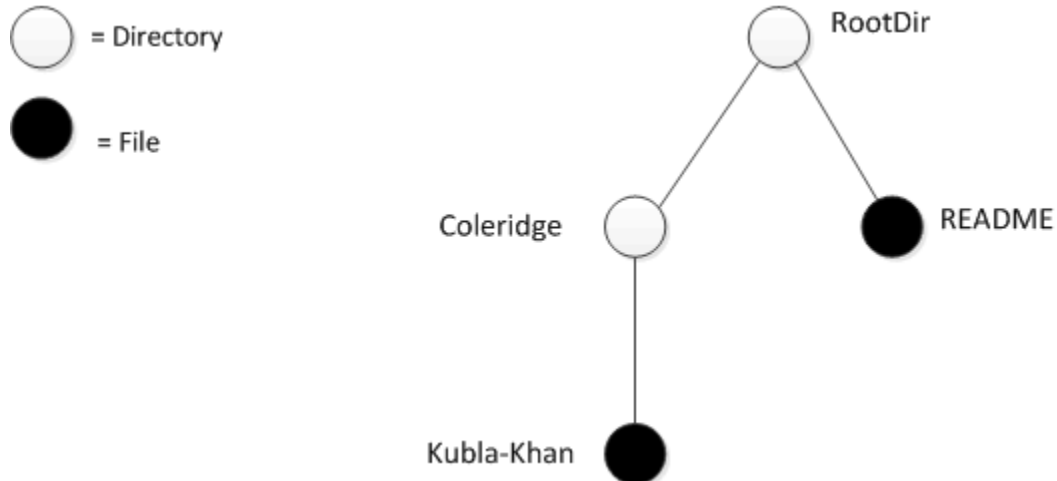

A small file system.

As we will see shortly, the servants for our directories and files are of type `DirectoryI` and `FileI`, respectively. The constructor for either type of servant accepts two parameters, the name of the directory or file to be created and a reference to the servant for the parent directory. (For the root directory, which has no parent, we pass `None`.) Thus, the statement

```
Python  
root = DirectoryI("/", None)
```

creates the root directory, with the name `" / "` and no parent directory.

Here is the code that establishes the structure in the above illustration:

Python

```

# Create the root directory (with name "/" and no parent)
#
root = DirectoryI("/", None)

# Create a file called "README" in the root directory
#
file = FileI("README", root)
text = [ "This file system contains a collection of poetry." ]
try:
    file.write(text)
except Filesystem.GenericError, e:
    print e.reason

# Create a directory called "Coleridge"
# in the root directory
#
coleridge = DirectoryI("Coleridge", root)

# Create a file called "Kubla_Khan"
# in the Coleridge directory
#
file = FileI("Kubla_Khan", coleridge)
text = [ "In Xanadu did Kubla Khan",
        "A stately pleasure-dome decree:",
        "Where Alph, the sacred river, ran",
        "Through caverns measureless to man",
        "Down to a sunless sea." ]
try:
    file.write(text)
except Filesystem.GenericError, e:
    print e.reason

```

We first create the root directory and a file `README` within the root directory. (Note that we pass a reference to the root directory as the parent when we create the new node of type `FileI`.)

The next step is to fill the file with text:

Python

```

text = [ "This file system contains a collection of poetry." ]
try:
    file.write(text)
except Filesystem.GenericError, e:
    print e.reason

```

Recall that [Slice sequences](#) map to Python lists. The Slice type `Lines` is simply a list of strings; we add a line of text to our `README` file by

initializing the `text` list to contain one element.

Finally, we call the Slice `write` operation on our `FileI` servant by simply writing:

```

Python

file.write(text)
```

This statement is interesting: the server code invokes an operation on one of its own servants. Because the call happens via a reference to the servant (of type `FileI`) and not via a proxy (of type `FilePrx`), the Ice run time does not know that this call is even taking place — such a direct call into a servant is not mediated by the Ice run time in any way and is dispatched as an ordinary Python method call.

In similar fashion, the remainder of the code creates a subdirectory called `Coleridge` and, within that directory, a file called `Kubla_Khan` to complete the structure in the above illustration.

FileI Servant Class in Python

Our `FileI` servant class has the following basic structure:

```

Python

class FileI(Filesystem.File):
    # Constructor and operations here...

    _adapter = None
```

The class has a number of data members:

- `_adapter`
This class member stores a reference to the single object adapter we use in our server.
- `_name`
This instance member stores the name of the file incarnated by the servant.
- `_parent`
This instance member stores the reference to the servant for the file's parent directory.
- `_lines`
This instance member holds the contents of the file.

The `_name`, `_parent`, and `_lines` data members are initialized by the constructor:

Python

```

def __init__(self, name, parent):
    self._name = name
    self._parent = parent
    self._lines = []

    assert(self._parent != None)

    # Create an identity
    #
    myID = Ice.Identity()
    myID.name = Ice.generateUUID()

    # Add ourself to the object adapter
    #
    self._adapter.add(self, myID)

    # Create a proxy for the new node and
    # add it as a child to the parent
    #
    thisNode = Filesystem.NodePrx.uncheckedCast(self._adapter.createProxy(myID))
    self._parent.addChild(thisNode)

```

After initializing the instance members, the code verifies that the reference to the parent is not `None` because every file must have a parent directory. The constructor then generates an identity for the file by calling `Ice.generateUUID` and adds itself to the servant map by calling `ObjectAdapter.add`. Finally, the constructor creates a proxy for this file and calls the `addChild` method on its parent directory. `addChild` is a helper function that a child directory or file calls to add itself to the list of descendant nodes of its parent directory. We will see the implementation of this function in [DirectoryI Methods](#).

The remaining methods of the `FileI` class implement the Slice operations we defined in the `Node` and `File Slice` interfaces:

Python

```

# Slice Node::name() operation

def name(self, current=None):
    return self._name

# Slice File::read() operation

def read(self, current=None):
    return self._lines

# Slice File::write() operation

def write(self, text, current=None):
    self._lines = text

```

The `name` method is inherited from the generated `Node` class. It simply returns the value of the `_name` instance member.

The `read` and `write` methods are inherited from the generated `File` class and simply return and set the `_lines` instance member.

DirectoryI Servant Class in Python

The `DirectoryI` class has the following basic structure:

Python

```

class DirectoryI(Filesystem.Directory):
    # Constructor and operations here...

    _adapter = None

```

DirectoryI Data Members in Python

As for the `FileI` class, we have data members to store the object adapter, the name, and the parent directory. (For the root directory, the `_parent` member holds `None`.) In addition, we have a `_contents` data member that stores the list of child directories. These data members are initialized by the constructor:

Python

```

def __init__(self, name, parent):
    self._name = name
    self._parent = parent
    self._contents = []

    # Create an identity. The
    # parent has the fixed identity "RootDir"
    #
    myID = Ice.Identity()
    if(self._parent):
        myID.name = Ice.generateUUID()
    else:
        myID.name = "RootDir"

    # Add ourself to the object adapter
    #
    self._adapter.add(self, myID)

    # Create a proxy for the new node and
    # add it as a child to the parent
    #
    thisNode = Filesystem.NodePrx.uncheckedCast(self._adapter.createProxy(myID))
    if self._parent:
        self._parent.addChild(thisNode)

```

DirectoryI Constructor in Python

The constructor creates an identity for the new directory by calling `Ice.generateUUID`. (For the root directory, we use the fixed identity "RootDir".) The servant adds itself to the servant map by calling `ObjectAdapter.add` and then creates a proxy to itself and passes it to the `addChild` helper function.

DirectoryI Methods in Python

`addChild` simply adds the passed reference to the `_contents` list:

Python

```

def addChild(self, child):
    self._contents.append(child)

```

The remainder of the operations, `name` and `list`, are trivial:

Python

```
def name(self, current=None):
    return self._name

def list(self, current=None):
    return self._contents
```

Thread Safety in Python

The server code we have written so far is not quite correct as it stands: if two clients access the same file in parallel, each via a different thread, one thread may read the `_lines` data member while another thread updates it. Obviously, if that happens, we may write or return garbage or, worse, crash the server. However, we can make the `read` and `write` operations thread-safe with a few trivial changes to the `FileI` class:

Python

```
def __init__(self, name, parent):
    self._name = name
    self._parent = parent
    self._lines = []
    self._mutex = threading.Lock()

    # ...

def name(self, current=None):
    return self._name

def read(self, current=None):
    self._mutex.acquire()
    lines = self._lines[:] # Copy the list
    self._mutex.release()
    return lines

def write(self, text, current=None):
    self._mutex.acquire()
    self._lines = text
    self._mutex.release()
```

We modified the constructor to add the instance member `_mutex`, and then enclosed our `read` and `write` implementations in a critical section. (The `name` method does not require a critical section because the file's name is immutable.)

No changes for thread safety are necessary in the `DirectoryI` class because the `Directory` interface, in its current form, defines no operations that modify the object.

See Also

- [Slice for a Simple File System](#)
- [Python Mapping for Sequences](#)
- [Example of a File System Client in Python](#)

- [The Server-Side main Program in Python](#)

Ruby Mapping

Ice currently provides a client-side mapping for Ruby, but not a server-side mapping.

Topics

- [Client-Side Slice-to-Ruby Mapping](#)

Client-Side Slice-to-Ruby Mapping

The client-side Slice-to-Ruby mapping defines how Slice data types are translated to Ruby types, and how clients invoke operations, pass parameters, and handle errors. Much of the Ruby mapping is intuitive. For example, Slice sequences map to Ruby arrays, so there is essentially nothing new you have to learn in order to use Slice sequences in Ruby.

The Ruby API to the Ice run time is fully thread-safe. Obviously, you must still synchronize access to data from different threads. For example, if you have two threads sharing a sequence, you cannot safely have one thread insert into the sequence while another thread is iterating over the sequence. However, you only need to concern yourself with concurrent access to your own data — the Ice run time itself is fully thread safe, and none of the Ice API calls require you to acquire or release a lock before you safely can make the call.

Much of what appears in this chapter is reference material. We suggest that you skim the material on the initial reading and refer back to specific sections as needed. However, we recommend that you read at least the mappings for [exceptions](#), [interfaces](#), and [operations](#) in detail because these sections cover how to call operations from a client, pass parameters, and handle exceptions.



In order to use the Ruby mapping, you should need no more than the Slice definition of your application and knowledge of the Ruby mapping rules. In particular, looking through the generated code in order to discern how to use the Ruby mapping is likely to be inefficient, due to the amount of detail. Of course, occasionally, you may want to refer to the generated code to confirm a detail of the mapping, but we recommend that you otherwise use the material presented here to see how to write your client-side code.



The Ice Module

All of the APIs for the Ice run time are nested in the `Ice` module, to avoid clashes with definitions for other libraries or applications. Some of the contents of the `Ice` module are generated from Slice definitions; other parts of the `Ice` module provide special-purpose definitions that do not have a corresponding Slice definition. We will incrementally cover the contents of the `Ice` module throughout the remainder of the manual.

A Ruby application can load the Ice run time using the `require` statement:

```
require 'Ice'
```

If the statement executes without error, the Ice run time is loaded and available for use. You can determine the version of the Ice run time you have just loaded by calling the `stringVersion` function:

```
icever = Ice::stringVersion()
```

Topics

- [Ruby Mapping for Identifiers](#)
- [Ruby Mapping for Modules](#)
- [Ruby Mapping for Built-In Types](#)
- [Ruby Mapping for Enumerations](#)
- [Ruby Mapping for Structures](#)
- [Ruby Mapping for Sequences](#)
- [Ruby Mapping for Dictionaries](#)
- [Ruby Mapping for Constants](#)
- [Ruby Mapping for Exceptions](#)
- [Ruby Mapping for Interfaces](#)
- [Ruby Mapping for Operations](#)
- [Ruby Mapping for Classes](#)
- [Code Generation in Ruby](#)
- [The main Program in Ruby](#)
- [Using Slice Checksums in Ruby](#)
- [Example of a File System Client in Ruby](#)

Ruby Mapping for Identifiers

A Slice [identifier](#) maps to an identical Ruby identifier. For example, the Slice identifier `clock` becomes the Ruby identifier `clock`. There are two exceptions to this rule:

1. Ruby requires the names of classes, modules, and constants to begin with an upper case letter. If a Slice identifier maps to the name of a Ruby class, module, or constant, and the Slice identifier does not begin with an upper case letter, the mapping replaces the leading character with its upper case equivalent. For example, the Slice identifier `bankAccount` is mapped as `BankAccount`.
2. If a Slice identifier is the same as a Ruby keyword, the corresponding Ruby identifier is prefixed with an underscore. For example, the Slice identifier `while` is mapped as `_while`.



You should try to avoid such identifiers as much as possible.

See Also

- [Lexical Rules](#)
- [Ruby Mapping for Modules](#)
- [Ruby Mapping for Built-In Types](#)
- [Ruby Mapping for Enumerations](#)
- [Ruby Mapping for Structures](#)
- [Ruby Mapping for Sequences](#)
- [Ruby Mapping for Dictionaries](#)
- [Ruby Mapping for Constants](#)
- [Ruby Mapping for Exceptions](#)
- [Ruby Mapping for Interfaces](#)
- [Ruby Mapping for Operations](#)

Ruby Mapping for Modules

A Slice [module](#) maps to a Ruby module with the [same name](#). The mapping preserves the nesting of the Slice definitions.

See Also

- [Modules](#)
- [Ruby Mapping for Identifiers](#)
- [Ruby Mapping for Built-In Types](#)
- [Ruby Mapping for Enumerations](#)
- [Ruby Mapping for Structures](#)
- [Ruby Mapping for Sequences](#)
- [Ruby Mapping for Dictionaries](#)
- [Ruby Mapping for Constants](#)
- [Ruby Mapping for Exceptions](#)
- [Ruby Mapping for Interfaces](#)
- [Ruby Mapping for Operations](#)

Ruby Mapping for Built-In Types

On this page:

- [Mapping of Slice Built-In Types to Ruby Types](#)
- [String Mapping in Ruby](#)

Mapping of Slice Built-In Types to Ruby Types

The Slice built-in types are mapped to Ruby types as shown in this table:

Slice	Ruby
bool	true or false
byte	Fixnum
short	Fixnum
int	Fixnum or Bignum
long	Fixnum or Bignum
float	Float
double	Float
string	String

Although Ruby supports arbitrary precision in its integer types, the Ice run time validates integer values to ensure they have valid ranges for their declared Slice types.

String Mapping in Ruby

String values returned as the result of a Slice operation (including return values, out parameters, and data members) contain UTF-8 encoded strings unless the program has installed a [string converter](#), in which case string values use the converter's native encoding instead.

As string input values for a remote Slice operation, Ice accepts `nil` in addition to `String` objects; each occurrence of `nil` is marshaled as an empty string. Ice assumes that all `String` objects contain valid UTF-8 encoded strings unless the program has installed a string converter, in which case Ice assumes that `String` objects use the native encoding expected by the converter.

See Also

- [Basic Types](#)
- [Ruby Mapping for Identifiers](#)
- [Ruby Mapping for Modules](#)
- [Ruby Mapping for Enumerations](#)
- [Ruby Mapping for Structures](#)
- [Ruby Mapping for Sequences](#)
- [Ruby Mapping for Dictionaries](#)
- [Ruby Mapping for Constants](#)
- [Ruby Mapping for Exceptions](#)
- [Ruby Mapping for Interfaces](#)
- [Ruby Mapping for Operations](#)
- [C++ Strings and Character Encoding](#)

Ruby Mapping for Enumerations

Ruby does not have an enumerated type, so a Slice [enumeration](#) is emulated using a Ruby class: the name of the Slice enumeration becomes the name of the Ruby class; for each enumerator, the class contains a constant with the [same name](#) as the enumerator. For example:

Slice
<pre>enum Fruit { Apple, Pear, Orange };</pre>

The generated Ruby class looks as follows:

Ruby
<pre>class Fruit include Comparable Apple = # ... Pear = # ... Orange = # ... def Fruit.from_int(val) def to_i def to_s def <=>(other) def hash # ... end</pre>

The compiler generates a class constant for each enumerator that holds a corresponding instance of `Fruit`. The `from_int` class method returns an instance given its Slice value, while `to_i` returns the Slice value of an enumerator and `to_s` returns its Slice identifier.

Given the above definitions, we can use enumerated values as follows:

Ruby

```
f1 = Fruit::Apple
f2 = Fruit::Orange

if f1 == Fruit::Apple    # Compare for equality
  # ...

if f1 < f2                # Compare two enums
  # ...

case f2
when Fruit::Orange
  puts "found Orange"
else
  puts "found #{f2.to_s}"
end
```

Comparison operators are available as a result of including `Comparable`, which means a program can compare enumerators according to their `Slice` values. Note that, when using [custom enumerator values](#), the order of enumerators by their `Slice` values may not match their order of declaration.

Suppose we modify the `Slice` definition to include a custom enumerator value:

Slice

```
enum Fruit { Apple, Pear = 3, Orange };
```

We can use `from_int` to examine the `Slice` values of the enumerators:

Ruby

```
Fruit::from_int(0) # Apple
Fruit::from_int(1) # nil
Fruit::from_int(3) # Pear
Fruit::from_int(4) # Orange
```

See Also

- [Enumerations](#)
- [Ruby Mapping for Identifiers](#)
- [Ruby Mapping for Modules](#)
- [Ruby Mapping for Built-In Types](#)
- [Ruby Mapping for Structures](#)
- [Ruby Mapping for Sequences](#)
- [Ruby Mapping for Dictionaries](#)
- [Ruby Mapping for Constants](#)
- [Ruby Mapping for Exceptions](#)
- [Ruby Mapping for Interfaces](#)

- [Ruby Mapping for Operations](#)

Ruby Mapping for Structures

A Slice [structure](#) maps to a Ruby class with the [same name](#). For each Slice data member, the Ruby class contains a corresponding instance variable as well as accessors to read and write its value. For example, here is our [Employee](#) structure once more:

Slice
<pre>struct Employee { long number; string firstName; string lastName; };</pre>

The Ruby mapping generates the following definition for this structure:

Ruby
<pre>class Employee def initialize(number=0, firstName='', lastName='') @number = number @firstName = firstName @lastName = lastName end def hash # ... end def == # ... end def inspect # ... end attr_accessor :number, :firstName, :lastName end</pre>

The constructor initializes each of the instance variables to a default value appropriate for its type. You can also declare different [default values](#) for members of primitive and enumerated types.

The compiler generates a definition for the `hash` method, which allows instances to be used as keys in a hash collection. The `hash` method returns a hash value for the structure based on the value of its data members.

The `==` method returns true if all members of two structures are (recursively) equal.

The `inspect` method returns a string representation of the structure.

See Also

- [Structures](#)

- [Ruby Mapping for Identifiers](#)
- [Ruby Mapping for Modules](#)
- [Ruby Mapping for Built-In Types](#)
- [Ruby Mapping for Enumerations](#)
- [Ruby Mapping for Sequences](#)
- [Ruby Mapping for Dictionaries](#)
- [Ruby Mapping for Constants](#)
- [Ruby Mapping for Exceptions](#)
- [Ruby Mapping for Interfaces](#)
- [Ruby Mapping for Operations](#)

Ruby Mapping for Sequences

On this page:

- [Mapping Slice Sequences to Ruby Arrays](#)
- [Mapping for Byte Sequences in Ruby](#)

Mapping Slice Sequences to Ruby Arrays

A Slice [sequence](#) maps to a Ruby array; the only exception is a sequence of bytes, which [maps to a string](#). The use of a Ruby array means that the mapping does not generate a separate named type for a Slice sequence. It also means that you can take advantage of all the array functionality provided by Ruby. For example:

Slice
<pre>sequence<Fruit> FruitPlatter;</pre>

We can use the `FruitPlatter` sequence as shown below:

Ruby
<pre>platter = [Fruit::Apple, Fruit::Pear] platter.push(Fruit::Orange)</pre>

The Ice run time validates the elements of a sequence to ensure that they are compatible with the declared type; a `TypeError` exception is raised if an incompatible type is encountered.

Mapping for Byte Sequences in Ruby

A Ruby string can contain arbitrary 8-bit binary data, therefore it is a more efficient representation of a byte sequence than a Ruby array in both memory utilization and throughput performance.

When receiving a byte sequence (as the result of an operation, as an out parameter, or as a member of a data structure), the value is always represented as a string. When sending a byte sequence as an operation parameter or data member, the Ice run time accepts both a string and an array of integers as legal values. For example, consider the following Slice definitions:

Slice
<pre>// Slice sequence<byte> Data; interface I { void sendData(Data d); Data getData(); };</pre>

The interpreter session below uses these Slice definitions to demonstrate the mapping for a sequence of bytes:

Ruby

```
> proxy = ...
> proxy.sendData("\0\1\2\3") # Send as a string
> proxy.sendData([0, 1, 2, 3]) # Send as an array
> d = proxy.getData()
> d.class
=> String
> d
=> "\000\001\002\003"
```

The two invocations of `sendData` are equivalent; however, the second invocation incurs additional overhead as the Ice run time must validate the type and range of each array element.

See Also

- [Sequences](#)
- [Ruby Mapping for Identifiers](#)
- [Ruby Mapping for Modules](#)
- [Ruby Mapping for Built-In Types](#)
- [Ruby Mapping for Enumerations](#)
- [Ruby Mapping for Structures](#)
- [Ruby Mapping for Dictionaries](#)
- [Ruby Mapping for Constants](#)
- [Ruby Mapping for Exceptions](#)
- [Ruby Mapping for Interfaces](#)
- [Ruby Mapping for Operations](#)

Ruby Mapping for Dictionaries

Here is the definition of our `EmployeeMap` once more:

Slice
<code>dictionary<long, Employee> EmployeeMap;</code>

As for [sequences](#), the Ruby mapping does not create a separate named type for this definition. Instead, *all* dictionaries are simply instances of Ruby's hash collection type. For example:

Ruby
<pre>em = {} e = Employee.new e.number = 31 e.firstName = "James" e.lastName = "Gosling" em[e.number] = e</pre>

The Ice run time validates the elements of a dictionary to ensure that they are compatible with the declared type; a `TypeError` exception is raised if an incompatible type is encountered.

See Also

- [Dictionaries](#)
- [Ruby Mapping for Identifiers](#)
- [Ruby Mapping for Modules](#)
- [Ruby Mapping for Built-In Types](#)
- [Ruby Mapping for Enumerations](#)
- [Ruby Mapping for Structures](#)
- [Ruby Mapping for Sequences](#)
- [Ruby Mapping for Constants](#)
- [Ruby Mapping for Exceptions](#)
- [Ruby Mapping for Interfaces](#)
- [Ruby Mapping for Operations](#)

Ruby Mapping for Constants

Here are the [constant definitions](#) once more:

Slice	
<code>const bool</code>	<code>AppendByDefault = true;</code>
<code>const byte</code>	<code>LowerNibble = 0x0f;</code>
<code>const string</code>	<code>Advice = "Don't Panic!";</code>
<code>const short</code>	<code>TheAnswer = 42;</code>
<code>const double</code>	<code>PI = 3.1416;</code>
<code>enum Fruit { Apple, Pear, Orange };</code>	
<code>const Fruit</code>	<code>FavoriteFruit = Pear;</code>

The generated definitions for these constants are shown below:

Ruby	
<code>AppendByDefault = true</code>	
<code>LowerNibble = 15</code>	
<code>Advice = "Don't Panic!"</code>	
<code>TheAnswer = 42</code>	
<code>PI = 3.1416</code>	
<code>FavoriteFruit = Fruit::Pear</code>	

As you can see, each Slice constant is mapped to a Ruby constant with the same name.

See Also

- [Constants and Literals](#)
- [Ruby Mapping for Identifiers](#)
- [Ruby Mapping for Modules](#)
- [Ruby Mapping for Built-In Types](#)
- [Ruby Mapping for Enumerations](#)
- [Ruby Mapping for Structures](#)
- [Ruby Mapping for Sequences](#)
- [Ruby Mapping for Dictionaries](#)
- [Ruby Mapping for Exceptions](#)
- [Ruby Mapping for Interfaces](#)
- [Ruby Mapping for Operations](#)

Ruby Mapping for Exceptions

On this page:

- [Inheritance Hierarchy for Exceptions in Ruby](#)
- [Ruby Mapping for User Exceptions](#)
- [Ruby Mapping for Run-Time Exceptions](#)

Inheritance Hierarchy for Exceptions in Ruby

The mapping for exceptions is based on the inheritance hierarchy shown below:

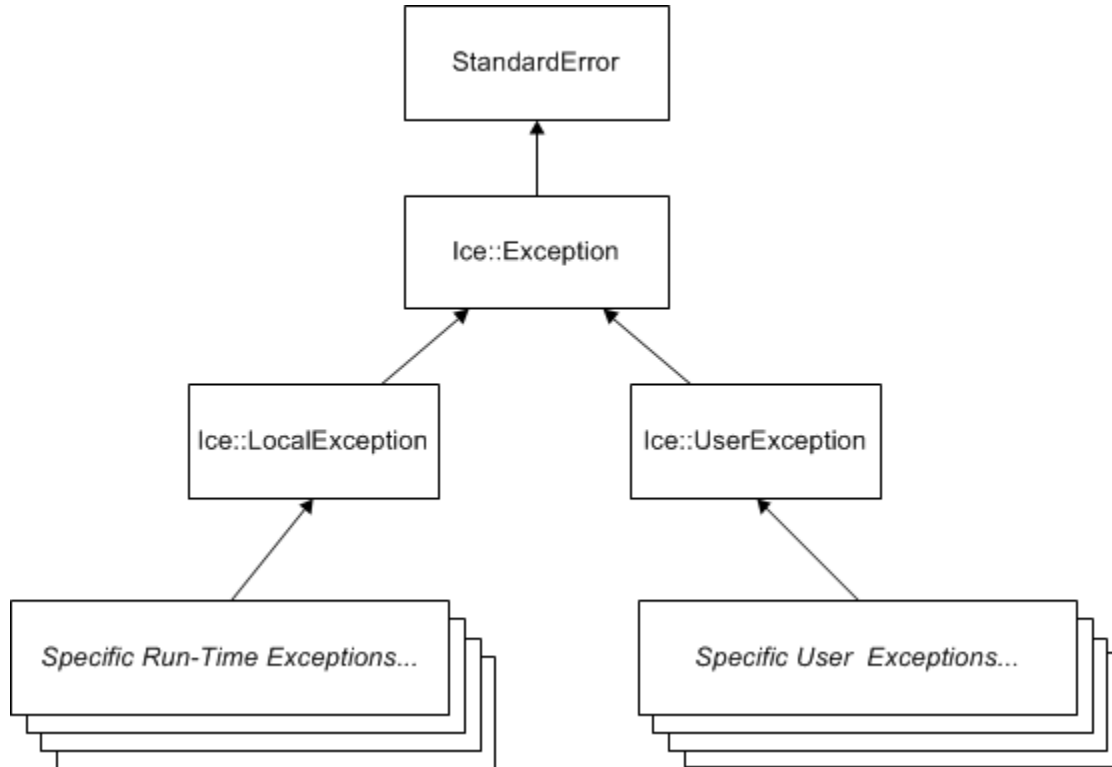

Inheritance structure for Ice exceptions.

The ancestor of all exceptions is `StandardError`, from which `Ice::Exception` is derived. `Ice::LocalException` and `Ice::UserException` are derived from `Ice::Exception` and form the base for all run-time and user exceptions.

Ruby Mapping for User Exceptions

Here is a fragment of the `Slice` definition for our world time server once more:

```

Slice
exception GenericError {
  string reason;
};
exception BadTimeVal extends GenericError {};
exception BadZoneName extends GenericError {};
  
```

These exception definitions map to the abbreviated Ruby class definitions shown below:

Ruby
<pre> class GenericError < Ice::UserException def initialize(reason='') def to_s def inspect attr_accessor :reason end class BadTimeVal < GenericError def initialize(reason='') def to_s def inspect end class BadZoneName < GenericError def initialize(reason='') def to_s def inspect end </pre>

Each Slice exception is mapped to a Ruby class with the same name. The inheritance structure of the Slice exceptions is preserved for the generated classes, so `BadTimeVal` and `BadZoneName` inherit from `GenericError`.

Each exception member corresponds to an instance variable of the instance, which the constructor initializes to a default value appropriate for its type. You can also declare different **default values** for members of primitive and enumerated types. For derived exceptions, the constructor has one parameter for each of the base exception's data members, plus one parameter for each of the derived exception's data members, in base-to-derived order. As an example, although `BadTimeVal` and `BadZoneName` do not declare data members, their constructors still accept a value for the inherited data member `reason` in order to pass it to the constructor of the base exception `GenericError`. The generated class defines an accessor for each data member to read and write its value.

Optional data members use the same mapping as required data members, but an optional data member can also be set to the marker value `Ice::Unset` to indicate that the member is unset. A well-behaved program must compare an optional data member to `Ice::Unset` before using the member's value:

Ruby

```
begin
  ...
rescue => ex
  if ex.optionalMember == Ice::Unset
    puts "optionalMember is unset"
  else
    puts "optionalMember = " + ex.optionalMember
  end
end
end
```

Each exception also defines the standard methods `to_s` and `inspect` to return the name of the exception and a stringified representation of the exception and its members, respectively.

All user exceptions are derived from the base class `Ice::UserException`. This allows you to catch all user exceptions generically by installing a handler for `Ice::UserException`. Similarly, you can catch all Ice run-time exceptions with a handler for `Ice::LocalException`, and you can catch all Ice exceptions with a handler for `Ice::Exception`.

Ruby Mapping for Run-Time Exceptions

The Ice run time throws [run-time exceptions](#) for a number of pre-defined error conditions. All run-time exceptions directly or indirectly derive from `Ice::LocalException` (which, in turn, derives from `Ice::Exception`).

By catching exceptions at the appropriate point in the inheritance hierarchy, you can handle exceptions according to the category of error they indicate:

- `Ice::LocalException`
This is the root of the inheritance tree for run-time exceptions.
- `Ice::UserException`
This is the root of the inheritance tree for user exceptions.
- `Ice::TimeoutException`
This is the base exception for both operation-invocation and connection-establishment timeouts.
- `Ice::ConnectTimeoutException`
This exception is raised when the initial attempt to establish a connection to a server times out.

For example, a `ConnectTimeoutException` can be handled as `ConnectTimeoutException`, `TimeoutException`, `LocalException`, or `Exception`.

You will probably have little need to catch run-time exceptions as their most-derived type and instead catch them as `LocalException`; the fine-grained error handling offered by the remainder of the hierarchy is of interest mainly in the implementation of the Ice run time. Exceptions to this rule are the exceptions related to [facet](#) and [object](#) life cycles, which you may want to catch explicitly. These exceptions are `FacetNotExistException` and `ObjectNotExistException`, respectively.

See Also

- [User Exceptions](#)
- [Run-Time Exceptions](#)
- [Ruby Mapping for Identifiers](#)
- [Ruby Mapping for Modules](#)
- [Ruby Mapping for Built-In Types](#)
- [Ruby Mapping for Enumerations](#)

- [Ruby Mapping for Structures](#)
- [Ruby Mapping for Sequences](#)
- [Ruby Mapping for Dictionaries](#)
- [Ruby Mapping for Constants](#)
- [Optional Data Members](#)
- [Facets and Versioning](#)
- [Object Life Cycle](#)

Ruby Mapping for Interfaces

The mapping of Slice [interfaces](#) revolves around the idea that, to invoke a remote operation, you call a member function on a local class instance that is a [proxy](#) for the remote object. This makes the mapping easy and intuitive to use because making a remote procedure call is no different from making a local procedure call (apart from error semantics).

On this page:

- [Proxy Classes in Ruby](#)
- [Ice::ObjectPrx Class in Ruby](#)
- [Casting Proxies in Ruby](#)
- [Using Proxy Methods in Ruby](#)
- [Object Identity and Proxy Comparison in Ruby](#)

Proxy Classes in Ruby

On the client side, a Slice interface maps to a Ruby class with methods that correspond to the operations on those interfaces. Consider the following simple interface:

Slice
<pre>interface Simple { void op(); };</pre>

The Ruby mapping generates the following definition for use by the client:

Ruby
<pre>class SimplePrx < Ice::ObjectPrx def op(_ctx=nil) # ... # ... end end</pre>

In the client's address space, an instance of `SimplePrx` is the local ambassador for a remote instance of the `Simple` interface in a server and is known as a *proxy instance*. All the details about the server-side object, such as its address, what protocol to use, and its object identity are encapsulated in that instance.

Note that `SimplePrx` inherits from `Ice::ObjectPrx`. This reflects the fact that all Ice interfaces implicitly inherit from `Ice::Object`.

For each operation in the interface, the proxy class has a method of the same name. In the preceding example, we find that the operation `op` has been mapped to the method `op`. Note that `op` accepts an optional trailing parameter `_ctx` representing the operation context. This parameter is a Ruby hash value for use by the Ice run time to store information about how to deliver a request. You normally do not need to use it. (We examine the context parameter in detail in [Request Contexts](#). The parameter is also used by [IceStorm](#).)

Proxy instances are always created on behalf of the client by the Ice run time, so client code never has any need to instantiate a proxy directly.

A value of `nil` denotes the null proxy. The null proxy is a dedicated value that indicates that a proxy points "nowhere" (denotes no object).

Ice::ObjectPrx Class in Ruby

All Ice objects have `Object` as the ultimate ancestor type, so all proxies inherit from `Ice::ObjectPrx`. `ObjectPrx` provides a number of methods:

```

Ruby

class ObjectPrx
  def eql?(proxy)
  def ice_getIdentity
  def ice_isA(id)
  def ice_ids
  def ice_id
  def ice_ping
  # ...
end

```

The methods behave as follows:

- **eql?**
The implementation of this standard Ruby method compares two proxies for equality. Note that all aspects of proxies are compared by this operation, such as the communication endpoints for the proxy. This means that, in general, if two proxies compare unequal, that does *not* imply that they denote different objects. For example, if two proxies denote the same Ice object via different transport endpoints, `eql?` returns `false` even though the proxies denote the same object.
- **ice_getIdentity**
This method returns the identity of the object denoted by the proxy. The identity of an Ice object has the following Slice type:

```

Slice

module Ice {
  struct Identity {
    string name;
    string category;
  };
};

```

To see whether two proxies denote the same object, first obtain the identity for each object and then compare the identities:

```

Ruby

proxy1 = ...
proxy2 = ...
id1 = proxy1.ice_getIdentity
id2 = proxy2.ice_getIdentity

if id1 == id2
  # proxy1 and proxy2 denote the same object
else
  # proxy1 and proxy2 denote different objects
end

```

- **ice_isA**

The `ice_isA` method determines whether the object denoted by the proxy supports a specific interface. The argument to `ice_isA` is a [type ID](#). For example, to see whether a proxy of type `ObjectPrx` denotes a `Printer` object, we can write:

```

Ruby

proxy = ...
if proxy && proxy.ice_isA("::Printer")
  # proxy denotes a Printer object
else
  # proxy denotes some other type of object
end
```

Note that we are testing whether the proxy is `nil` before attempting to invoke the `ice_isA` method. This avoids getting a run-time error if the proxy is `nil`.

- **ice_ids**

The `ice_ids` method returns an array of strings representing all of the [type IDs](#) that the object denoted by the proxy supports.

- **ice_id**

The `ice_id` method returns the [type ID](#) of the object denoted by the proxy. Note that the type returned is the type of the actual object, which may be more derived than the static type of the proxy. For example, if we have a proxy of type `BasePrx`, with a static type ID of `::Base`, the return value of `ice_id` might be `::Base`, or it might be something more derived, such as `::Derived`.

- **ice_ping**

The `ice_ping` method provides a basic reachability test for the object. If the object can physically be contacted (that is, the object exists and its server is running and reachable), the call completes normally; otherwise, it throws an exception that indicates why the object could not be reached, such as `ObjectNotExistException` or `ConnectTimeoutException`.

The `ice_isA`, `ice_ids`, `ice_id`, and `ice_ping` methods are remote operations and therefore support an additional overloading that accepts a [request context](#). Also note that there are [other methods](#) in `ObjectPrx`, not shown here. These methods provide different ways to dispatch a call and also provide access to an object's [facets](#).

Casting Proxies in Ruby

The Ruby mapping for a proxy also generates two class methods:

```

Ruby

class SimplePrx < Ice::ObjectPrx
  # ...

  def SimplePrx.checkedCast(proxy, facet='', ctx={})

  def SimplePrx.uncheckedCast(proxy, facet='')
end
```

The method names `checkedCast` and `uncheckedCast` are reserved for use in proxies. If a `Slice` interface defines an operation with either of those names, the mapping escapes the name in the generated proxy by prepending an underscore. For example, an interface that defines an operation named `checkedCast` is mapped to a proxy with a method named `_checkedCast`.

For `checkedCast`, if the passed proxy is for an object of type `Simple`, or a proxy for an object with a type derived from `Simple`, the cast returns a reference to a proxy of type `SimplePrx`; otherwise, if the passed proxy denotes an object of a different type (or if the passed proxy

is nil), the cast returns nil.

Given a proxy of any type, you can use a `checkedCast` to determine whether the corresponding object supports a given type, for example:

```

Ruby

obj = ...           # Get a proxy from somewhere...

simple = SimplePrx::checkedCast(obj)
if simple
  # Object supports the Simple interface...
else
  # Object is not of type Simple...
end

```

Note that a `checkedCast` contacts the server. This is necessary because only the server implementation has definite knowledge of the type of an object. As a result, a `checkedCast` may throw a `ConnectTimeoutException` or an `ObjectNotExistException`.

In contrast, an `uncheckedCast` does not contact the server and unconditionally returns a proxy of the requested type. However, if you do use an `uncheckedCast`, you must be certain that the proxy really does support the type you are casting to; otherwise, if you get it wrong, you will most likely get a run-time exception when you invoke an operation on the proxy. The most likely error for such a type mismatch is `OperationNotExistException`. However, other exceptions, such as a marshaling exception are possible as well. And, if the object happens to have an operation with the correct name, but different parameter types, no exception may be reported at all and you simply end up sending the invocation to an object of the wrong type; that object may do rather nonsensical things. To illustrate this, consider the following two interfaces:

```

Slice

interface Process {
  void launch(int stackSize, int dataSize);
};

// ...

interface Rocket {
  void launch(float xCoord, float yCoord);
};

```

Suppose you expect to receive a proxy for a `Process` object and use an `uncheckedCast` to down-cast the proxy:

```

Ruby

obj = ...           # Get proxy...
process = ProcessPrx::uncheckedCast(obj) # No worries...
process.launch(40, 60)           # Oops...

```

If the proxy you received actually denotes a `Rocket` object, the error will go undetected by the Ice run time: because `int` and `float` have the same size and because the Ice protocol does not tag data with its type on the wire, the implementation of `Rocket::launch` will simply misinterpret the passed integers as floating-point numbers.

In fairness, this example is somewhat contrived. For such a mistake to go unnoticed at run time, both objects must have an operation with

the same name and, in addition, the run-time arguments passed to the operation must have a total marshaled size that matches the number of bytes that are expected by the unmarshaling code on the server side. In practice, this is extremely rare and an incorrect `uncheckedCast` typically results in a run-time exception.

Using Proxy Methods in Ruby

The base proxy class `ObjectPrx` supports a variety of [methods for customizing a proxy](#). Since proxies are immutable, each of these "factory methods" returns a copy of the original proxy that contains the desired modification. For example, you can obtain a proxy configured with a ten second timeout as shown below:

```
Ruby
```

```
proxy = communicator.stringToProxy(...)
proxy = proxy.ice_timeout(10000)
```

A factory method returns a new proxy object if the requested modification differs from the current proxy, otherwise it returns the current proxy. With few exceptions, factory methods return a proxy of the same type as the current proxy, therefore it is generally not necessary to repeat a down-cast after using a factory method. The example below demonstrates these semantics:

```
Ruby
```

```
base = communicator.stringToProxy(...)
hello = Demo::HelloPrx::checkedCast(base)
hello = hello.ice_timeout(10000) # Type is not discarded
hello.sayHello()
```

The only exceptions are the factory methods `ice_facet` and `ice_identity`. Calls to either of these methods may produce a proxy for an object of an unrelated type, therefore they return a base proxy that you must subsequently down-cast to an appropriate type.

Object Identity and Proxy Comparison in Ruby

Proxy objects support comparison using the comparison operators `==`, `!=`, and `<=>`, as well as the `eq1?` method. Note that proxy comparison uses *all* of the information in a proxy for the comparison. This means that not only the object identity must match for a comparison to succeed, but other details inside the proxy, such as the protocol and endpoint information, must be the same. In other words, comparison tests for *proxy* identity, *not* object identity. A common mistake is to write code along the following lines:

```
Ruby
```

```
p1 = ...           # Get a proxy...
p2 = ...           # Get another proxy...

if p1 != p2
  # p1 and p2 denote different objects      # WRONG!
else
  # p1 and p2 denote the same object       # Correct
end
```

Even though `p1` and `p2` differ, they may denote the same Ice object. This can happen because, for example, both `p1` and `p2` embed the same object identity, but each uses a different protocol to contact the target object. Similarly, the protocols may be the same, but denote

different endpoints (because a single Ice object can be contacted via several different transport endpoints). In other words, if two proxies compare equal, we know that the two proxies denote the same object (because they are identical in all respects); however, if two proxies compare unequal, we know absolutely nothing: the proxies may or may not denote the same object.

To compare the object identities of two proxies, you can use helper functions in the `Ice` module:

```

Ruby

def proxyIdentityCompare(lhs, rhs)
def proxyIdentityAndFacetCompare(lhs, rhs)
```

`proxyIdentityCompare` allows you to correctly compare proxies for identity:

```

Ruby

p1 = ...      # Get a proxy...
p2 = ...      # Get another proxy...

if Ice.proxyIdentityCompare(p1, p2) != 0
  # p1 and p2 denote different objects      # Correct
else
  # p1 and p2 denote the same object      # Correct
end
```

The function returns 0 if the identities are equal, -1 if `p1` is less than `p2`, and 1 if `p1` is greater than `p2`. (The comparison uses `name` as the major sort key and `category` as the minor sort key.)

The `proxyIdentityAndFacetCompare` function behaves similarly, but compares both the identity and the [facet name](#).

See Also

- [Interfaces, Operations, and Exceptions](#)
- [Proxies](#)
- [Type IDs](#)
- [Ruby Mapping for Operations](#)
- [Request Contexts](#)
- [Operations on Object](#)
- [Proxy Methods](#)
- [Facets and Versioning](#)
- [IceStorm](#)

Ruby Mapping for Operations

On this page:

- [Basic Ruby Mapping for Operations](#)
- [Normal and `idempotent` Operations in Ruby](#)
- [Passing Parameters in Ruby](#)
 - [In-Parameters in Ruby](#)
 - [Out-Parameters in Ruby](#)
 - [Parameter Type Mismatches in Ruby](#)
 - [Null Parameters in Ruby](#)
 - [Optional Parameters in Ruby](#)
- [Exception Handling in Ruby](#)

Basic Ruby Mapping for Operations

As we saw in the [Ruby mapping for interfaces](#), for each `operation` on an interface, the proxy class contains a corresponding method with the same name. To invoke an operation, you call it via the proxy. For example, here is part of the definitions for our [file system](#):

```

Slice

module Filesystem {
  interface Node {
    idempotent string name();
  };
  // ...
};
```

The `name` operation returns a value of type `string`. Given a proxy to an object of type `Node`, the client can invoke the operation as follows:

```

Ruby

node = ...           # Initialize proxy
name = node.name()  # Get name via RPC
```

Normal and `idempotent` Operations in Ruby

You can add an `idempotent` qualifier to a `Slice` operation. As far as the signature for the corresponding proxy method is concerned, `idempotent` has no effect. For example, consider the following interface:

```

Slice

interface Example {
    string op1();
    idempotent string op2();
};
```

The proxy class for this is:

Ruby

```
class ExamplePrx < Ice::ObjectPrx
  def op1(_ctx=nil)

  def op2(_ctx=nil)
end
```

Because `idempotent` affects an aspect of call dispatch, not interface, it makes sense for the two methods to look the same.

Passing Parameters in Ruby**In-Parameters in Ruby**

All parameters are passed by reference in the Ruby mapping; it is guaranteed that the value of a parameter will not be changed by the invocation.

Here is an interface with operations that pass parameters of various types from client to server:

Slice

```
struct NumberAndString {
  int x;
  string str;
};

sequence<string> StringSeq;

dictionary<long, StringSeq> StringTable;

interface ClientToServer {
  void op1(int i, float f, bool b, string s);
  void op2(NumberAndString ns, StringSeq ss, StringTable st);
  void op3(ClientToServer* proxy);
};
```

The Slice compiler generates the following proxy for this definition:

Ruby

```
class ClientToServerPrx < Ice::ObjectPrx
  def op1(i, f, b, s, _ctx=nil)

  def op2(ns, ss, st, _ctx=nil)

  def op3(proxy, _ctx=nil)
end
```

Given a proxy to a `ClientToServer` interface, the client code can pass parameters as in the following example:

```

Ruby

p = ... # Get proxy...

p.op1(42, 3.14, true, "Hello world!") # Pass simple literals

i = 42
f = 3.14
b = true
s = "Hello world!"
p.op1(i, f, b, s) # Pass simple variables

ns = NumberAndString.new()
ns.x = 42
ns.str = "The Answer"
ss = [ "Hello world!" ]
st = {}
st[0] = ns
p.op2(ns, ss, st) # Pass complex variables

p.op3(p) # Pass proxy

```

Out-Parameters in Ruby

As in Java, Ruby functions do not support reference arguments. That is, it is not possible to pass an uninitialized variable to a Ruby function in order to have its value initialized by the function. The [Java mapping](#) overcomes this limitation with the use of *holder classes* that represent each `out` parameter. The Ruby mapping takes a different approach, one that is more natural for Ruby users.

The semantics of `out` parameters in the Ruby mapping depend on whether the operation returns one value or multiple values. An operation returns multiple values when it has declared multiple `out` parameters, or when it has declared a non-`void` return type and at least one `out` parameter.

If an operation returns multiple values, the client receives them in the form of a *result array*. A non-`void` return value, if any, is always the first element in the result array, followed by the `out` parameters in the order of declaration.

If an operation returns only one value, the client receives the value itself.

Here again are the same Slice definitions we saw earlier, but this time with all parameters being passed in the `out` direction:

Slice

```

struct NumberAndString {
    int x;
    string str;
};

sequence<string> StringSeq;

dictionary<long, StringSeq> StringTable;

interface ServerToClient {
    int op1(out float f, out bool b, out string s);
    void op2(out NumberAndString ns,
             out StringSeq ss,
             out StringTable st);
    void op3(out ServerToClient* proxy);
};

```

The Ruby mapping generates the following code for this definition:

Ruby

```

class ClientToServerPrx < Ice::ObjectPrx
  def op1(_ctx=nil)

  def op2(_ctx=nil)

  def op3(_ctx=nil)
end

```

Given a proxy to a `ServerToClient` interface, the client code can receive the results as in the following example:

Ruby

```

p = ...           # Get proxy...
i, f, b, s = p.op1()
ns, ss, st = p.op2()
stcp = p.op3()

```

The operations have no `in` parameters, therefore no arguments are passed to the proxy methods. Since `op1` and `op2` return multiple values, their result arrays are unpacked into separate values, whereas the return value of `op3` requires no unpacking.

Parameter Type Mismatches in Ruby

Although the Ruby compiler cannot check the types of arguments passed to a method, the Ice run time does perform validation on the arguments to a proxy invocation and reports any type mismatches as a `TypeError` exception.

Null Parameters in Ruby

Some Slice types naturally have "empty" or "not there" semantics. Specifically, sequences, dictionaries, and strings all can be `nil`, but the corresponding Slice types do not have the concept of a null value. To make life with these types easier, whenever you pass `nil` as a parameter or return value of type sequence, dictionary, or string, the Ice run time automatically sends an empty sequence, dictionary, or string to the receiver.

This behavior is useful as a convenience feature: especially for deeply-nested data types, members that are sequences, dictionaries, or strings automatically arrive as an empty value at the receiving end. This saves you having to explicitly initialize, for example, every string element in a large sequence before sending the sequence in order to avoid a run-time error. Note that using null parameters in this way does *not* create null semantics for Slice sequences, dictionaries, or strings. As far as the object model is concerned, these do not exist (only *empty* sequences, dictionaries, and strings do). For example, it makes no difference to the receiver whether you send a string as `nil` or as an empty string: either way, the receiver sees an empty string.

Optional Parameters in Ruby

Optional parameters use the same mapping as required parameters. The only difference is that `Ice::Unset` can be passed as the value of an optional parameter or return value. Consider the following operation:

```
Slice
```

```
optional(1) int execute(optional(2) string params, out optional(3) float
value);
```

A client can invoke this operation as shown below:

```
Ruby
```

```
i, v = proxy.execute("--file log.txt")
i, v = proxy.execute(Ice::Unset)

if v != Ice::Unset
  puts "value = " + v.to_s
end
```

A well-behaved program must always compare an optional parameter to `Ice::Unset` prior to using its value.

Exception Handling in Ruby

Any operation invocation may throw a **run-time exception** and, if the operation has an exception specification, may also throw **user exceptions**. Suppose we have the following simple interface:

```
Slice
```

```
exception Tantrum {
  string reason;
};

interface Child {
  void askToCleanUp() throws Tantrum;
};
```

Slice exceptions are thrown as Ruby exceptions, so you can simply enclose one or more operation invocations in a `begin-rescue` block:

```

Ruby

child = ...          # Get child proxy...

begin
  child.askToCleanUp()
rescue Tantrum => t
  puts "The child says: #{t.reason}"
end
```

Typically, you will catch only a few exceptions of specific interest around an operation invocation; other exceptions, such as unexpected run-time errors, will usually be handled by exception handlers higher in the hierarchy. For example:

```

Ruby

def run()
  child = ...          # Get child proxy...
  begin
    child.askToCleanUp()
  rescue Tantrum => t
    puts "The child says: #{t.reason}"
    child.scold()      # Recover from error...
  end
  child.praise()      # Give positive feedback...
end

begin
  # ...
  run()
  # ...
rescue Ice::Exception => ex
  print ex.backtrace.join("\n")
end
```

This code handles a specific exception of local interest at the point of call and deals with other exceptions generically. (This is also the strategy we used for our first simple application in [Hello World Application](#).)

See Also

- [Operations](#)
- [Hello World Application](#)
- [Slice for a Simple File System](#)
- [Ruby Mapping for Operations](#)
- [Ruby Mapping for Interfaces](#)
- [Ruby Mapping for Exceptions](#)

Ruby Mapping for Classes

On this page:

- [Basic Ruby Mapping for Classes](#)
- [Inheritance from `Ice::Object` in Ruby](#)
- [Class Data Members in Ruby](#)
- [Class Constructors in Ruby](#)
- [Class Operations in Ruby](#)
- [Receiving Objects in Ruby](#)
- [Class Factories in Ruby](#)

Basic Ruby Mapping for Classes

A Slice `class` maps to a Ruby class with the **same name**. For each Slice data member, the generated class contains an instance variable and accessors to read and write it, just as for structures and exceptions. Consider the following class definition:

Slice	
<pre>class TimeOfDay { short hour; // 0 - 23 short minute; // 0 - 59 short second; // 0 - 59 string format(); // Return time as hh:mm:ss };</pre>	

The Ruby mapping generates the following code for this definition:

Ruby

```

module TimeOfDay_mixin
  include ::Ice::Object_mixin

  # ...

  def inspect
    # ...
  end

  #
  # Operation signatures.
  #
  # def format()

  attr_accessor :hours, :minutes, :seconds
end
class TimeOfDay
  include TimeOfDay_mixin

  def initialize(hour=0, minute=0, second=0)
    @hour = hour
    @minute = minute
    @second = second
  end

  def TimeOfDay.ice_staticId()
    '::M::TimeOfDay'
  end

  # ...
end

```

There are a number of things to note about the generated code:

1. The generated class `TimeOfDay` includes the mixin module `TimeOfDay_mixin`, which in turn includes `Ice::Object_mixin`. This reflects the semantics of Slice classes in that all classes implicitly inherit from `Object`, which is the ultimate ancestor of all classes. Note that `Object` is *not* the same as `Ice::ObjectPrx`. In other words, you *cannot* pass a class where a proxy is expected and vice versa.
2. The constructor defines an instance variable for each Slice data member.
3. The class defines the class method `ice_staticId`.
4. A comment summarizes the method signatures for each Slice operation.

There is quite a bit to discuss here, so we will look at each item in turn.

Inheritance from `Ice::Object` in Ruby

In other language mappings, the inheritance relationship between `Object` and a user-defined Slice class is stated explicitly, in that the generated class derives from a language-specific representation of `Object`. Although its class type allows single inheritance, Ruby's

loosely-typed nature places less emphasis on class hierarchies and relies more on *duck typing*.

i In Ruby, an object's type is typically less important than the methods it supports. *If it looks like a duck, and acts like a duck, then it is a duck.*

The Slice mapping for a class follows this convention by placing most of the necessary machinery in a mixin module that the generated class includes into its definition. The Ice run time requires an instance of a Slice class to include the mixin module and define values for the declared data members, but does not require that the object be an instance of the generated class.

As shown in the illustration below, classes have no relationship to `Ice::ObjectPrx` (which is at the base of the inheritance hierarchy for proxies), therefore you cannot pass a class where a proxy is expected (and vice versa).

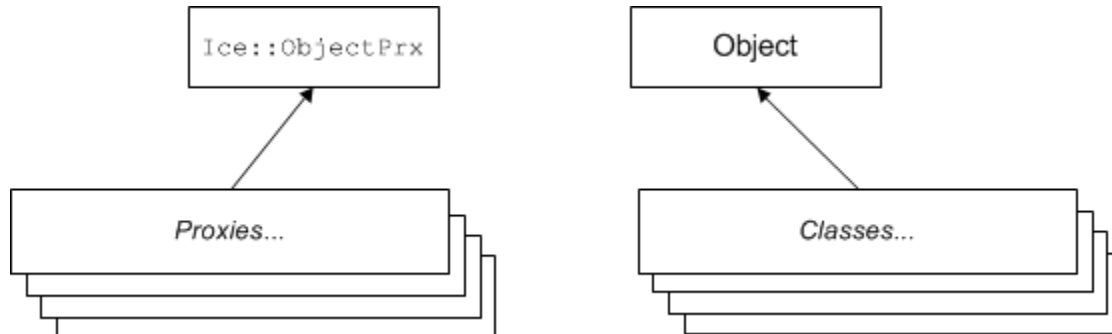

Inheritance from `Ice::ObjectPrx` and `Object`.

An instance of a Slice class `C` supports a number of methods:

```

Ruby
def ice_isA(id, current=nil)

def ice_ping(current=nil)

def ice_ids(current=nil)

def ice_id(current=nil)

def C.ice_staticId()

def ice_preMarshal()

def ice_postUnmarshal()

```

The methods behave as follows:

- `ice_isA`
This method returns `true` if the object supports the given `type ID`, and `false` otherwise.
- `ice_ping`
As for interfaces, `ice_ping` provides a basic reachability test for the object.
- `ice_ids`
This method returns a string sequence representing all of the `type IDs` supported by this object, including `::Ice::Object`.
- `ice_id`

This method returns the actual run-time [type ID](#) of the object. If you call `ice_id` through a reference to a base instance, the returned type id is the actual (possibly more derived) type ID of the instance.

- `ice_staticId`
This method returns the static [type ID](#) of the class.
- `ice_preMarshal`
If the object supports this method, the Ice run time invokes it just prior to marshaling the object's state, providing the opportunity for the object to validate its declared data members.
- `ice_postUnmarshal`
If the object supports this method, the Ice run time invokes it after unmarshaling the object's state. An object typically defines this method when it needs to perform additional initialization using the values of its declared data members.

The mixin module `Ice::Object_mixin` supplies default definitions of `ice_isA` and `ice_ping`. For each Slice class, the generated mixin module defines `ice_ids` and `ice_id`, and the generated class defines the `ice_staticId` method.

Note that neither `Ice::Object` nor the generated class override `hash` and `==`, so the default implementations apply.

Class Data Members in Ruby

By default, data members of classes are mapped exactly as for structures and exceptions: for each data member in the Slice definition, the generated class contains a corresponding instance variable and accessor methods.

[Optional data members](#) use the same mapping as required data members, but an optional data member can also be set to the marker value `Ice::Unset` to indicate that the member is unset. A well-behaved program must compare an optional data member to `Ice::Unset` before using the member's value:

Ruby
<pre>v = ... if v.optionalMember == Ice::Unset puts "optionalMember is unset" else puts "optionalMember = " + v.optionalMember end</pre>

If you wish to restrict access to a data member, you can modify its visibility using the `protected` metadata directive. The presence of this directive causes the Slice compiler to generate the data member with protected visibility. As a result, the member can be accessed only by the class itself or by one of its subclasses. For example, the `TimeOfDay` class shown below has the `protected` metadata directive applied to each of its data members:

Slice
<pre>class TimeOfDay { ["protected"] short hour; // 0 - 23 ["protected"] short minute; // 0 - 59 ["protected"] short second; // 0 - 59 string format(); // Return time as hh:mm:ss };</pre>

The Slice compiler produces the following generated code for this definition:

Ruby

```

module TimeOfDay_mixin
  include ::Ice::Object_mixin

  # ...

  #
  # Operation signatures.
  #
  # def format()

  attr_accessor :hours, :minutes, :seconds
  protected :hours, :hours=
  protected :minutes, :minutes=
  protected :seconds, :seconds=
end
class TimeOfDay
  include TimeOfDay_mixin

  def initialize(hour=0, minute=0, second=0)
    @hour = hour
    @minute = minute
    @second = second
  end

  # ...
end

```

For a class in which all of the data members are protected, the metadata directive can be applied to the class itself rather than to each member individually. For example, we can rewrite the `TimeOfDay` class as follows:

Slice

```

["protected"] class TimeOfDay {
  short hour;           // 0 - 23
  short minute;        // 0 - 59
  short second;        // 0 - 59
  string format();     // Return time as hh:mm:ss
};

```

Class Constructors in Ruby

Classes have a constructor that assigns to each data member a default value appropriate for its type. You can also declare different default values for data members of primitive and enumerated types.

For derived classes, the constructor has one parameter for each of the base class's data members, plus one parameter for each of the derived class's data members, in base-to-derived order.

Pass the marker value `Ice::Unset` as the value of any [optional data members](#) that you wish to be unset.

Class Operations in Ruby

Operations of classes are mapped to methods in the generated class. This means that, if a class contains operations (such as the `format` operation of our `TimeOfDay` class), objects representing instances of `TimeOfDay` must define equivalent methods. For example:

```

Ruby
class TimeOfDayI < TimeOfDay
  def format(current=nil)
    sprintf("%02d:%02d:%02d", @hour, @minute, @second)
  end
end
```

In this case our implementation class `TimeOfDayI` derives from the generated class `TimeOfDay`. An alternative is to include the generated mixin module, which makes it possible for the class to derive from a different base class if necessary:

```

Ruby
class TimeOfDayI < SomeOtherClass
  include TimeOfDay_mixin

  def format(current=nil)
    sprintf("%02d:%02d:%02d", @hour, @minute, @second)
  end
end
```

As explained [earlier](#), an implementation of a `Slice` class must include the mixin module but is not required to derive from the generated class.

Ruby allows an existing class to be reopened in order to augment or replace its functionality. This feature provides another way for us to implement a `Slice` class: reopen the generated class and define the necessary methods:

```

Ruby
class TimeOfDay
  def format(current=nil)
    sprintf("%02d:%02d:%02d", @hour, @minute, @second)
  end
end
```

As an added benefit, this strategy eliminates the need to define a class factory. The next section describes this subject in more detail.

A `Slice` class such as `TimeOfDay` that declares or inherits an operation is inherently abstract. Ruby does not support the notion of abstract classes or abstract methods, therefore the mapping merely summarizes the required method signatures in a comment for your convenience.

You may notice that the mapping for an operation adds an optional trailing parameter named `current`. For now, you can ignore this parameter and pretend it does not exist.

Receiving Objects in Ruby

We have discussed the ways you can implement a Slice class, but we also need to examine the semantics of receiving an object as the return value or as an out-parameter from an operation invocation. Consider the following simple interface:

```

Slice
interface Time {
    TimeOfDay get();
};

```

When a client invokes the `get` operation, the Ice run time must instantiate and return an instance of the `TimeOfDay` class. Unless we tell it otherwise, the Ice run time in Ruby does exactly that: it instantiates the generated class `TimeOfDay`. Although `TimeOfDay` is logically an abstract class because its Slice equivalent defined an operation, Ruby has no notion of abstract classes and therefore it is legal to create an instance of this class. Furthermore, there are situations in which this is exactly the behavior you want:

- when you have reopened the generated class to define its operations, or
- when your program uses only the data members of an object and does not invoke any of its operations.

On the other hand, if you have defined a Ruby class that implements the Slice class, you need the Ice run time to return an instance of your class and not an instance of the generated class. The Ice run time cannot magically know about your implementation class, therefore you must inform the Ice run time by installing a class factory.

Class Factories in Ruby

The Ice run time invokes a class factory when it needs to instantiate an object of a particular type. If no factory is found, the Ice run time instantiates the generated class as described [above](#). To install a factory, we use operations provided by the `Ice::Communicator` interface:

```

Slice
module Ice {
    local interface ObjectFactory {
        Object create(string type);
        void destroy();
    };

    local interface Communicator {
        void addObjectFactory(ObjectFactory factory,
            string id);
        ObjectFactory findObjectFactory(string id);
        // ...
    };
};

```

To supply the Ice run time with a factory for our `TimeOfDayI` class, we must create an object that supports the `Ice::ObjectFactory` interface:

Ruby

```
class ObjectFactory
  def create(type)
    fail unless type == M::TimeOfDay::ice_staticId()
    TimeOfDayI.new
  end

  def destroy
    # Nothing to do
  end
end
```

The object factory's `create` method is called by the Ice run time when it needs to instantiate a `TimeOfDay` class. The factory's `destroy` method is called by the Ice run time when its communicator is destroyed.

The `create` method is passed the **type ID** of the class to instantiate. For our `TimeOfDay` class, the type ID is `"::M::TimeOfDay"`. Our implementation of `create` checks the type ID: if it matches, the method instantiates and returns a `TimeOfDayI` object. For other type IDs, the method fails because it does not know how to instantiate other types of objects.

Note that we used the `ice_staticId` method to obtain the type ID rather than embedding a literal string. Using a literal type ID string in your code is discouraged because it can lead to errors that are only detected at run time. For example, if a `Slice` class or one of its enclosing modules is renamed and the literal string is not changed accordingly, a receiver will fail to unmarshal the object and the Ice run time will raise `NoObjectFactoryException`. By using `ice_staticId` instead, we avoid any risk of a misspelled or obsolete type ID, and we can discover at compile time if a `Slice` class or module has been renamed.

Given a factory implementation, such as our `ObjectFactory`, we must inform the Ice run time of the existence of the factory:

Ruby

```
ic = ... # Get Communicator...
ic.addObjectFactory(ObjectFactory.new, M::TimeOfDay::ice_staticId())
```

Now, whenever the Ice run time needs to instantiate a class with the type ID `"::M::TimeOfDay"`, it calls the `create` method of the registered `ObjectFactory` instance.

The `destroy` operation of the object factory is invoked by the Ice run time when the communicator is destroyed. This gives you a chance to clean up any resources that may be used by your factory. Do not call `destroy` on the factory while it is registered with the communicator — if you do, the Ice run time has no idea that this has happened and, depending on what your `destroy` implementation is doing, may cause undefined behavior when the Ice run time tries to next use the factory.

The run time guarantees that `destroy` will be the last call made on the factory, that is, `create` will not be called concurrently with `destroy`, and `create` will not be called once `destroy` has been called. However, calls to `create` can be made concurrently.

Note that you cannot register a factory for the same type ID twice: if you call `addObjectFactory` with a type ID for which a factory is registered, the Ice run time throws an `AlreadyRegisteredException`.

Finally, keep in mind that if a class has only data members, but no operations, you need not create and register an object factory to transmit instances of such a class.

See Also

- [Classes](#)
- [Type IDs](#)

- [Optional Data Members](#)
- [The Current Object](#)

Code Generation in Ruby

The Ruby mapping supports two forms of code generation: dynamic and static.

On this page:

- [Dynamic Code Generation in Ruby](#)
 - [Ice::loadSlice Options in Ruby](#)
 - [Locating Slice Files in Ruby](#)
 - [Loading Multiple Slice Files in Ruby](#)
 - [Limitations of Dynamic Code Generation in Ruby](#)
- [Static Code Generation in Ruby](#)
 - [Compiler Output in Ruby](#)
 - [Include Files in Ruby](#)
- [Static Versus Dynamic Code Generation in Ruby](#)
 - [Application Considerations for Code Generation in Ruby](#)
 - [Mixing Static and Dynamic Generation in Ruby](#)
- [slice2rb Command-Line Options](#)

Dynamic Code Generation in Ruby

Using dynamic code generation, Slice files are "loaded" at run time and dynamically translated into Ruby code, which is immediately compiled and available for use by the application. This is accomplished using the `Ice::loadSlice` method, as shown in the following example:

Ruby
<pre>Ice::loadSlice("Color.ice") puts "My favorite color is #{M::Color.blue.to_s}"</pre>

For this example, we assume that `Color.ice` contains the following definitions:

Slice
<pre>module M { enum Color { red, green, blue }; };</pre>

Ice::loadSlice Options in Ruby

The `Ice::loadSlice` method behaves like a Slice compiler in that it accepts command-line arguments for specifying preprocessor options and controlling code generation. The arguments must include at least one Slice file.

The function has the following Ruby definition:

Ruby
<pre>def loadSlice(cmd, args=[])</pre>

The command-line arguments can be specified entirely in the first argument, `cmd`, which must be a string. The optional second argument can be used to pass additional command-line arguments as a list; this is useful when the caller already has the arguments in list form. The function always returns `nil`.

For example, the following calls to `Ice::loadSlice` are functionally equivalent:

```
Ruby
```

```
Ice::loadSlice("-I/opt/IceRuby/slice Color.ice")
Ice::loadSlice("-I/opt/IceRuby/slice", ["Color.ice"])
Ice::loadSlice("", ["-I/opt/IceRuby/slice", "Color.ice"])
```

In addition to the [standard compiler options](#), `Ice::loadSlice` also supports the following command-line options:

- `--all`
Generate code for all Slice definitions, including those from included files.
- `--checksum`
Generate [checksums](#) for Slice definitions.

Locating Slice Files in Ruby

If your Slice files depend on Ice types, you can avoid hard-coding the path name of your Ice installation directory by calling the `Ice::getSliceDir` function:

```
Ruby
```

```
Ice::loadSlice("-I" + Ice::getSliceDir() + " Color.ice")
```

This function attempts to locate the `slice` subdirectory of your Ice installation using an algorithm that succeeds for the following scenarios:

- Installation of a binary Ice archive
- Installation of an Ice source distribution using `make install`
- Installation via a Windows installer
- RPM installation on Linux
- Execution inside a compiled Ice source distribution

If the `slice` subdirectory can be found, `getSliceDir` returns its absolute path name, otherwise the function returns `nil`.

Loading Multiple Slice Files in Ruby

You can specify as many Slice files as necessary in a single invocation of `Ice::loadSlice`, as shown below:

```
Ruby
```

```
Ice::loadSlice("Syscall.ice Process.ice")
```

Alternatively, you can call `Ice::loadSlice` several times:

```
Ruby
```

```
Ice::loadSlice("Syscall.ice")
Ice::loadSlice("Process.ice")
```

If a Slice file includes another file, the default behavior of `Ice::loadSlice` generates Ruby code only for the named file. For example,

suppose `Syscall.ice` includes `Process.ice` as follows:

```

Slice

// Syscall.ice
#include <Process.ice>
...
```

If you call `Ice::loadSlice("-I. Syscall.ice")`, Ruby code is not generated for the `Slice` definitions in `Process.ice` or for any definitions that may be included by `Process.ice`. If you also need code to be generated for included files, one solution is to load them individually in subsequent calls to `Ice::loadSlice`. However, it is much simpler, not to mention more efficient, to use the `--all` option instead:

```

Ruby

Ice::loadSlice("--all -I. Syscall.ice")
```

When you specify `--all`, `Ice::loadSlice` generates Ruby code for all `Slice` definitions included directly or indirectly from the named `Slice` files.

There is no harm in loading a `Slice` file multiple times, aside from the additional overhead associated with code generation. For example, this situation could arise when you need to load multiple top-level `Slice` files that happen to include a common subset of nested files. Suppose that we need to load both `Syscall.ice` and `Kernel.ice`, both of which include `Process.ice`. The simplest way to load both files is with a single call to `Ice::loadSlice`:

```

Ruby

Ice::loadSlice("--all -I. Syscall.ice Kernel.ice")
```

Although this invocation causes the `Ice` extension to generate code twice for `Process.ice`, the generated code is structured so that the interpreter ignores duplicate definitions. We could have avoided generating unnecessary code with the following sequence of steps:

```

Ruby

Ice::loadSlice("--all -I. Syscall.ice")
Ice::loadSlice("-I. Kernel.ice")
```

In more complex cases, however, it can be difficult or impossible to completely avoid this situation, and the overhead of code generation is usually not significant enough to justify such an effort.

Limitations of Dynamic Code Generation in Ruby

The `Ice::loadSlice` method must be called outside of any module scope. For example, the following code is incorrect:

Ruby

```
# WRONG
module M
  Ice::loadSlice("--all -I. Syscall.ice Kernel.ice")
  ...
end
```

Static Code Generation in Ruby

You should be familiar with static code generation if you have used other Slice language mappings, such as C++ or Java. Using static code generation, the Slice compiler `slice2rb` generates Ruby code from your Slice definitions.

Compiler Output in Ruby

For each Slice file `x.ice`, `slice2rb` generates Ruby code into a file named `x.rb` in the output directory. The default output directory is the current working directory, but a different directory can be specified using the `--output-dir` option.

Include Files in Ruby

It is important to understand how `slice2rb` handles include files. In the absence of the `--all` option, the compiler does not generate Ruby code for Slice definitions in included files. Rather, the compiler translates Slice `#include` statements into Ruby `require` statements in the following manner:

1. Determine the full pathname of the included file.
2. Create the shortest possible relative pathname for the included file by iterating over each of the include directories (specified using the `-I` option) and removing the leading directory from the included file if possible.
For example, if the full pathname of an included file is `/opt/App/slice/OS/Process.ice`, and we specified the options `-I/opt/App` and `-I/opt/App/slice`, then the shortest relative pathname is `OS/Process.ice` after removing `/opt/App/slice`.
3. Replace the `.ice` extension with `.rb`. Continuing our example from the previous step, the translated `require` statement becomes

```
require "OS/Process.rb"
```

As a result, you can use `-I` options to tailor the `require` statements generated by the compiler in order to avoid absolute pathnames and match the organizational structure of your application's source files.

Static Versus Dynamic Code Generation in Ruby

There are several issues to consider when evaluating your requirements for code generation.

Application Considerations for Code Generation in Ruby

The requirements of your application generally dictate whether you should use dynamic or static code generation. Dynamic code generation is convenient for a number of reasons:

- It avoids the intermediate compilation step required by static code generation.
- It makes the application more compact because the application requires only the Slice files, not the additional files produced by static code generation.
- It reduces complexity, which is especially helpful during testing, or when writing short or transient programs.

Static code generation, on the other hand, is appropriate in many situations:

- when an application uses a large number of Slice definitions and the startup delay must be minimized

- when it is not feasible to deploy Slice files with the application
- when a number of applications share the same Slice files
- when Ruby code is required in order to utilize third-party Ruby tools.

Mixing Static and Dynamic Generation in Ruby

You can safely use a combination of static and dynamic translation in an application. For it to work properly, you must correctly manage the include paths for Slice translation and the Ruby interpreter so that the statically-generated code can be imported properly by `require`.

For example, suppose you want to dynamically load the following Slice definitions:

```

Slice

#include <Glacier2/Session.ice>

module MyApp {
  interface MySession extends Glacier2::Session {
    // ...
  };
};
```

Whether the included file `Glacier2/Session.ice` is loaded dynamically or statically is determined by the presence of the `--all` option:

```

Ruby

sliceDir = "-I#{ENV['ICE_HOME']}/slice"

# Load Glacier2/Session.ice dynamically:
Ice::loadSlice(sliceDir + " --all MySession.ice")

# Load Glacier2/Session.ice statically:
Ice::loadSlice(sliceDir + " MySession.ice")
```

In this example, the first invocation of `loadSlice` uses the `--all` option so that code is generated dynamically for all included files. The second invocation omits `--all`, therefore the Ruby interpreter executes the equivalent of the following statement:

```

require "Glacier2/Session.rb"
```

As a result, before we can call `loadSlice` we must first ensure that the interpreter can locate the statically-generated file `Glacier2/Session.rb`. We can do this in a number of ways, including:

- adding the parent directory (e.g., `/opt/IceRuby/ruby`) to the `RUBYLIB` environment variable
- specifying the `-I` option when starting the interpreter
- modifying the search path at run time, as shown below:

```

$: .unshift( "/opt/IceRuby/ruby" )
```

`slice2rb` Command-Line Options

The Slice-to-Ruby compiler, `slice2rb`, offers the following command-line options in addition to the [standard options](#):

- `--all`
Generate code for all Slice definitions, including those from included files.
- `--checksum`
Generate [checksums](#) for Slice definitions.

See Also

- [Using the Slice Compilers](#)
- [Using Slice Checksums in Ruby](#)

The main Program in Ruby

On this page:

- [Initializing the Ice Run Time in Ruby](#)
- [The `Ice::Application` Class in Ruby](#)
 - [Catching Signals in Ruby](#)
 - [Ice::Application and Properties in Ruby](#)
 - [Limitations of `Ice::Application` in Ruby](#)

Initializing the Ice Run Time in Ruby

The main entry point to the Ice run time is represented by the local interface `Ice::Communicator`. You must initialize the Ice run time by calling `Ice::initialize` before you can do anything else in your program.

`Ice::initialize` returns a reference to an instance of `Ice::Communicator`:

Ruby
<pre>require 'Ice' status = 0 ic = nil begin ic = Ice::initialize(ARGV) # ... rescue => ex puts ex status = 1 end # ...</pre>

`Ice::initialize` accepts the argument list that is passed to the program by the operating system. The function scans the argument list for any [command-line options](#) that are relevant to the Ice run time; any such options are removed from the argument list so, when `Ice::initialize` returns, the only options and arguments remaining are those that concern your application. If anything goes wrong during initialization, `initialize` throws an exception.

Before leaving your program, you *must* call `Communicator.destroy`. The `destroy` operation is responsible for finalizing the Ice run time. In particular, `destroy` ensures that any outstanding threads are joined with and reclaims a number of operating system resources, such as file descriptors and memory. Never allow your program to terminate without calling `destroy` first; doing so has undefined behavior.

The general shape of our program is therefore as follows:

Ruby

```

require 'Ice'

status = 0
ic = nil
begin
  ic = Ice::initialize(ARGV)
  # ...
rescue => ex
  puts ex
  status = 1
end

if ic
  begin
    ic.destroy()
  rescue => ex
    puts ex
    status = 1
  end
end

exit(status)

```

Note that the code places the call to `Ice::initialize` into a `begin` block and takes care to return the correct exit status to the operating system. Also note that an attempt to destroy the communicator is made only if the initialization succeeded.

The `Ice::Application` Class in Ruby

The preceding program structure is so common that `Ice` offers a class, `Ice::Application`, that encapsulates all the correct initialization and finalization activities. The synopsis of the class is as follows (with some detail omitted for now):

Ruby

```

module Ice
  class Application
    def main(args, configFile=nil, initData=nil)

    def run(args)

    def Application.appName()

    def Application.communicator()
  end
end
end

```

The intent of this class is that you specialize `Ice::Application` and implement the abstract `run` method in your derived class. Whatever

code you would normally place in your main program goes into `run` instead. Using `Ice::Application`, our program looks as follows:

```

Ruby

require 'Ice'

class Client < Ice::Application
  def run(args)
    # Client code here...
    return 0
  end
end

app = Client.new()
status = app.main(ARGV)
exit(status)

```

If you prefer, you can also reopen `Ice::Application` and define `run` directly:

```

Ruby

require 'Ice'

class Ice::Application
  def run(args)
    # Client code here...
    return 0
  end
end

app = Ice::Application.new()
status = app.main(ARGV)
exit(status)

```

You may also call `main` with an optional file name or an `InitializationData` structure. If you pass a [configuration file name](#) to `main`, the settings in this file are overridden by settings in a file identified by the `ICE_CONFIG` environment variable (if defined). Property settings supplied on the [command line](#) take precedence over all other settings.

The `Application.main` method does the following:

1. It installs an exception handler. If your code fails to handle an exception, `Application.main` prints the exception information before returning with a non-zero return value.
2. It initializes (by calling `Ice::initialize`) and finalizes (by calling `Communicator.destroy`) a communicator. You can get access to the communicator for your program by calling the static `communicator` accessor.
3. It scans the argument list for options that are relevant to the Ice run time and removes any such options. The argument list that is passed to your `run` method therefore is free of Ice-related options and only contains options and arguments that are specific to your application.
4. It provides the name of your application via the static `appName` method. The return value from this call is the first element of the argument vector passed to `Application.main`, so you can get at this name from anywhere in your code by calling `Ice::Application::appName` (which is often necessary for error messages).
5. It installs a signal handler that properly shuts down the communicator.

Using `Ice::Application` ensures that your program properly finalizes the Ice run time, whether your program terminates normally or in response to an exception or signal. We recommend that all your programs use this class; doing so makes your life easier. In addition `Ice::Application` also provides features for signal handling and configuration that you do not have to implement yourself when you use this class.

Catching Signals in Ruby

A program typically needs to perform some cleanup work before terminating, such as flushing database buffers or closing network connections. This is particularly important on receipt of a signal or keyboard interrupt to prevent possible corruption of database files or other persistent data.

To make it easier to deal with signals, `Ice::Application` encapsulates Ruby's signal handling capabilities, allowing you to cleanly shut down on receipt of a signal:

```

Ruby

class Application
  def Application.destroyOnInterrupt()

  def Application.ignoreInterrupt()

  def Application.callbackOnInterrupt()

  def Application.holdInterrupt()

  def Application.releaseInterrupt()

  def Application.interrupted()

  def interruptCallback(sig):
    # Default implementation does nothing.
  end
  # ...
end
```

The methods behave as follows:

- `destroyOnInterrupt`
This method installs a signal handler that destroys the communicator if it is interrupted. This is the default behavior.
- `ignoreInterrupt`
This method causes signals to be ignored.
- `callbackOnInterrupt`
This function configures `Ice::Application` to invoke `interruptCallback` when a signal occurs, thereby giving the subclass responsibility for handling the signal.
- `holdInterrupt`
This method temporarily blocks signal delivery.
- `releaseInterrupt`
This method restores signal delivery to the previous disposition. Any signal that arrives after `holdInterrupt` was called is delivered when you call `releaseInterrupt`.
- `interrupted`

This method returns `True` if a signal caused the communicator to shut down, `False` otherwise. This allows us to distinguish intentional shutdown from a forced shutdown that was caused by a signal. This is useful, for example, for logging purposes.

- `interruptCallback`

A subclass implements this function to respond to signals. The function may be called concurrently with any other thread and must not raise exceptions.

By default, `Ice::Application` behaves as if `destroyOnInterrupt` was invoked, therefore our program requires no change to ensure that the program terminates cleanly on receipt of a signal. (You can disable the signal-handling functionality of `Ice::Application` by passing the constant `NoSignalHandling` to the constructor. In that case, signals retain their default behavior, that is, terminate the process.) However, we add a diagnostic to report the occurrence of a signal, so our program now looks like:

```

Ruby

require 'Ice'

class MyApplication < Ice::Application
  def run(args)
    # Client code here...

    if Ice::Application::interrupted()
      print Ice::Application::appName() + ": terminating"
    end

    return 0
  end
end

app = MyApplication.new()
status = app.main(ARGV)
exit(status)
```

Ice::Application and Properties in Ruby

Apart from the functionality shown in this section, `Ice::Application` also takes care of initializing the Ice run time with property values. `Properties` allow you to configure the run time in various ways. For example, you can use properties to control things such as the thread pool size or the trace level for diagnostic output. The `main` method of `Ice::Application` accepts an optional second parameter allowing you to specify the name of a configuration file that will be processed during initialization.

Limitations of Ice::Application in Ruby

`Ice::Application` is a singleton class that creates a single communicator. If you are using multiple communicators, you cannot use `Ice::Application`. Instead, you must structure your code as we saw in [Hello World Application](#) (taking care to always destroy the communicator).

See Also

- [Hello World Application](#)
- [Properties and Configuration](#)
- [Communicator Initialization](#)
- [Logger Facility](#)

Using Slice Checksums in Ruby

The Slice compilers can optionally generate [checksums](#) of Slice definitions. For `slice2rb`, the `--checksum` option causes the compiler to generate code that adds checksums to the hash collection `Ice::SliceChecksums`. The checksums are installed automatically when the Ruby code is first parsed; no action is required by the application.

In order to verify a server's checksums, a client could simply compare the two hash objects using a comparison operator. However, this is not feasible if it is possible that the server might return a superset of the client's checksums. A more general solution is to iterate over the local checksums as demonstrated below:

```

Ruby



```
serverChecksums = ...
for i in Ice::SliceChecksums.keys
 if not serverChecksums.has_key?(i)
 # No match found for type id!
 elif Ice::SliceChecksums[i] != serverChecksums[i]
 # Checksum mismatch!
 end
end
end
```

```

In this example, the client first verifies that the server's dictionary contains an entry for each Slice type ID, and then it proceeds to compare the checksums.

See Also

- [Slice Checksums](#)

Example of a File System Client in Ruby

This page presents a very simple client to access a server that implements the file system we developed in [Slice for a Simple File System](#). The Ruby code shown here hardly differs from the code you would write for an ordinary Ruby program. This is one of the biggest advantages of using Ice: accessing a remote object is as easy as accessing an ordinary, local Ruby object. This allows you to put your effort where you should, namely, into developing your application logic instead of having to struggle with arcane networking APIs.

We now have seen enough of the client-side Ruby mapping to develop a complete client to access our remote file system. For reference, here is the Slice definition once more:

```

Slice

module Filesystem {
  interface Node {
    idempotent string name();
  };

  exception GenericError {
    string reason;
  };

  sequence<string> Lines;

  interface File extends Node {
    idempotent Lines read();
    idempotent void write(Lines text) throws GenericError;
  };

  sequence<Node*> NodeSeq;

  interface Directory extends Node {
    idempotent NodeSeq list();
  };
};
```

To exercise the file system, the client does a recursive listing of the file system, starting at the root directory. For each node in the file system, the client shows the name of the node and whether that node is a file or directory. If the node is a file, the client retrieves the contents of the file and prints them.

The body of the client code looks as follows:

```

Ruby

require 'Filesystem.rb'

# Recursively print the contents of directory "dir"
# in tree fashion. For files, show the contents of
# each file. The "depth" parameter is the current
# nesting level (for indentation).

def listRecursive(dir, depth)
  indent = ''
```

```

depth = depth + 1
for i in (0...depth)
  indent += "\t"
end

contents = dir.list()

for node in contents
  subdir = Filesystem::DirectoryPrx::checkedCast(node)
  file = Filesystem::FilePrx::uncheckedCast(node)
  print indent + node.name() + " "
  if subdir
    puts "(directory):"
    listRecursive(subdir, depth)
  else
    puts "(file):"
    text = file.read()
    for line in text
      puts indent + "\t" + line
    end
  end
end
end

status = 0
ic = nil
begin
  # Create a communicator
  #
  ic = Ice::initialize(ARGV)

  # Create a proxy for the root directory
  #
  obj = ic.stringToProxy("RootDir:default -p 10000")

  # Down-cast the proxy to a Directory proxy
  #
  rootDir = Filesystem::DirectoryPrx::checkedCast(obj)

  # Recursively list the contents of the root directory
  #
  puts "Contents of root directory:"
  listRecursive(rootDir, 0)
rescue => ex
  puts ex
  print ex.backtrace.join("\n")
  status = 1
end

if ic

```

```
# Clean up
#
begin
  ic.destroy()
rescue => ex
  puts ex
  print ex.backtrace.join("\n")
  status = 1
end
end
```

```
exit(status)
```

The program first defines the `listRecursive` function, which is a helper function to print the contents of the file system, and the main program follows. Let us look at the main program first:

1. The structure of the code follows what we saw in [Hello World Application](#). After initializing the run time, the client creates a proxy to the root directory of the file system. For this example, we assume that the server runs on the local host and listens using the default protocol (TCP/IP) at port 10000. The object identity of the root directory is known to be `RootDir`.
2. The client down-casts the proxy to `DirectoryPrx` and passes that proxy to `listRecursive`, which prints the contents of the file system.

Most of the work happens in `listRecursive`. The function is passed a proxy to a directory to list, and an indent level. (The indent level increments with each recursive call and allows the code to print the name of each node at an indent level that corresponds to the depth of the tree at that node.) `listRecursive` calls the `list` operation on the directory and iterates over the returned sequence of nodes:

1. The code does a `checkedCast` to narrow the `Node` proxy to a `Directory` proxy, as well as an `uncheckedCast` to narrow the `Node` proxy to a `File` proxy. Exactly one of those casts will succeed, so there is no need to call `checkedCast` twice: if the `Node` is-a `Directory`, the code uses the `DirectoryPrx` returned by the `checkedCast`; if the `checkedCast` fails, we know that the `Node` is-a `File` and, therefore, an `uncheckedCast` is sufficient to get a `FilePrx`.
In general, if you know that a down-cast to a specific type will succeed, it is preferable to use an `uncheckedCast` instead of a `checkedCast` because an `uncheckedCast` does not incur any network traffic.
2. The code prints the name of the file or directory and then, depending on which cast succeeded, prints "(directory)" or "(file)" following the name.
3. The code checks the type of the node:
 - If it is a directory, the code recurses, incrementing the indent level.
 - If it is a file, the code calls the `read` operation on the file to retrieve the file contents and then iterates over the returned sequence of lines, printing each line.

Assume that we have a small file system consisting of a two files and a a directory as follows:

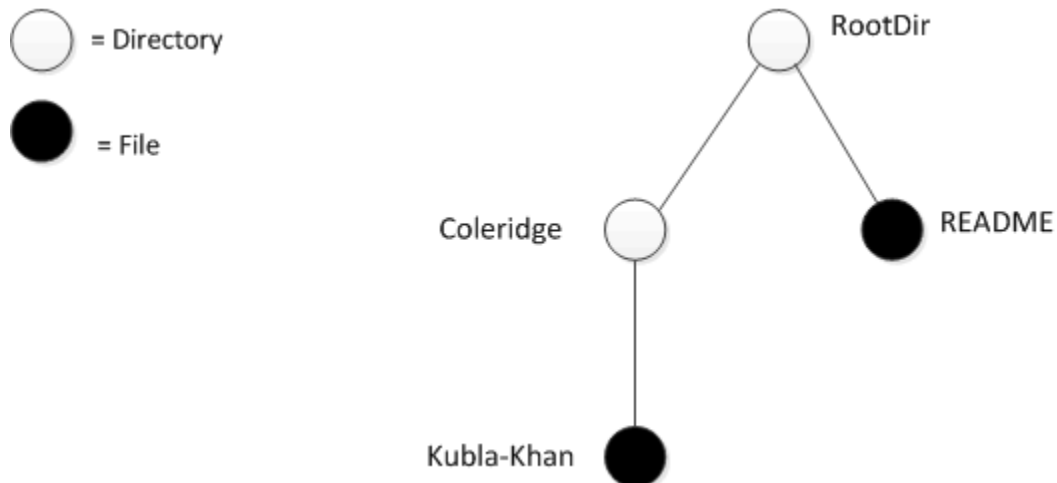

A small file system.

The output produced by the client for this file system is:

```
Contents of root directory:
```

```
  README (file):
```

```
    This file system contains a collection of poetry.
```

```
  Coleridge (directory):
```

```
    Kubla_Khan (file):
```

```
      In Xanadu did Kubla Khan
```

```
      A stately pleasure-dome decree:
```

```
      Where Alph, the sacred river, ran
```

```
      Through caverns measureless to man
```

```
      Down to a sunless sea.
```

Note that, so far, our client is not very sophisticated:

- The protocol and address information are hard-wired into the code.
- The client makes more remote procedure calls than strictly necessary; with minor redesign of the Slice definitions, many of these calls can be avoided.

We will see how to address these shortcomings in our discussions of [IceGrid](#) and [object life cycle](#).

See Also

- [Hello World Application](#)
- [Slice for a Simple File System](#)
- [Object Life Cycle](#)
- [IceGrid](#)

PHP Mapping

Ice currently provides a client-side mapping for PHP, but not a server-side mapping.

Topics

- [Client-Side Slice-to-PHP Mapping](#)

Client-Side Slice-to-PHP Mapping

The client-side Slice-to-PHP mapping defines how Slice data types are translated to PHP types, and how clients invoke operations, pass parameters, and handle errors. Much of the PHP mapping is intuitive. For example, Slice sequences map to PHP arrays, so there is essentially nothing new you have to learn in order to use Slice sequences in PHP.

Much of what appears in this chapter is reference material. We suggest that you skim the material on the initial reading and refer back to specific sections as needed. However, we recommend that you read at least the mappings for [exceptions](#), [interfaces](#), and [operations](#) in detail because these sections cover how to call operations from a client, pass parameters, and handle exceptions.



In order to use the PHP mapping, you should need no more than the Slice definition of your application and knowledge of the PHP mapping rules. In particular, looking through the generated code in order to discern how to use the PHP mapping is likely to be inefficient, due to the amount of detail. Of course, occasionally, you may want to refer to the generated code to confirm a detail of the mapping, but we recommend that you otherwise use the material presented here to see how to write your client-side code.



The Ice Module

All of the APIs for the Ice run time are nested in the `Ice` module, to avoid clashes with definitions for other libraries or applications. Some of the contents of the `Ice` module are generated from Slice definitions; other parts of the `Ice` module provide special-purpose definitions that do not have a corresponding Slice definition. We will incrementally cover the contents of the `Ice` module throughout the remainder of the manual.

A PHP application can load the Ice run time using the `require` statement:

```
require 'Ice.php';
```

If the statement executes without error, the Ice run time is loaded and available for use. You can determine the version of the Ice run time you have just loaded by calling the `stringVersion` function:

```
$icever = Ice_stringVersion();
```

Using the namespace mapping, you can refer to a global Ice function such as `stringVersion` either by its flattened name (as shown above) or by its namespace equivalent:

```
$icever = \Ice\stringVersion();
```

Topics

- [PHP Mapping for Identifiers](#)
- [PHP Mapping for Modules](#)
- [PHP Mapping for Built-In Types](#)
- [PHP Mapping for Enumerations](#)
- [PHP Mapping for Structures](#)
- [PHP Mapping for Sequences](#)
- [PHP Mapping for Dictionaries](#)
- [PHP Mapping for Constants](#)
- [PHP Mapping for Exceptions](#)
- [PHP Mapping for Interfaces](#)
- [PHP Mapping for Operations](#)
- [PHP Mapping for Classes](#)
- [slice2php Command-Line Options](#)
- [Application Notes for PHP](#)
- [Using Slice Checksums in PHP](#)
- [Example of a File System Client in PHP](#)

PHP Mapping for Identifiers

A Slice [identifier](#) maps to an identical PHP identifier. For example, the Slice identifier `clock` becomes the PHP identifier `clock`. There is one exception to this rule: if a Slice identifier is the same as a PHP keyword or is an identifier reserved by the Ice run time (such as `checkedCast`), the corresponding PHP identifier is prefixed with an underscore. For example, the Slice identifier `while` is mapped as `_while`.

 You should try to [avoid such identifiers](#) as much as possible.

A single Slice identifier often results in several PHP identifiers. For example, for a Slice interface named `Foo`, the generated PHP code uses the identifiers `Foo` and `FooPrx` (among others). If the interface has the name `while`, the generated identifiers are `_while` and `whilePrx` (*not* `_whilePrx`), that is, the underscore prefix is applied only to those generated identifiers that actually require it.

See Also

- [Lexical Rules](#)
- [PHP Mapping for Modules](#)
- [PHP Mapping for Built-In Types](#)
- [PHP Mapping for Enumerations](#)
- [PHP Mapping for Structures](#)
- [PHP Mapping for Sequences](#)
- [PHP Mapping for Dictionaries](#)
- [PHP Mapping for Constants](#)
- [PHP Mapping for Exceptions](#)

PHP Mapping for Modules

By default, identifiers defined within a Slice `module` are mapped to a flattened symbol that uses underscores as module separators. Consider the following Slice definition:

Slice
<pre> module M { module N { enum Color { red, green, blue }; }; }; </pre>

The Slice identifier `Color` maps to `M_N_Color` by default because PHP releases prior to version 5.3 lacked language support for namespaces. If you prefer to use namespaces instead, you can enable an alternate mapping in which Slice modules map to PHP namespaces with the same name as the Slice module. This mapping preserves the nesting of the Slice definitions. Using the namespace mapping, the Slice identifier `Color` maps to `\M\N\Color`.

Be aware that using underscores in your Slice definitions can lead to name collisions in the flattened mapping. Consider the following example:

Slice
<pre> module M { module N { enum Color { red, green, blue }; }; }; module M_N { interface Color { }; }; </pre>

Although these definitions are syntactically correct, they both map to the flattened PHP symbol `M_N_Color`.

See Also

- [Modules](#)
- [PHP Mapping for Identifiers](#)
- [PHP Mapping for Built-In Types](#)
- [PHP Mapping for Enumerations](#)
- [PHP Mapping for Structures](#)
- [PHP Mapping for Sequences](#)
- [PHP Mapping for Dictionaries](#)
- [PHP Mapping for Constants](#)
- [PHP Mapping for Exceptions](#)

PHP Mapping for Built-In Types

On this page:

- [Mapping of Slice Built-In Types to PHP Types](#)
- [String Mapping in PHP](#)

Mapping of Slice Built-In Types to PHP Types

PHP has a limited set of primitive types: `boolean`, `integer`, `double`, and `string`. The Slice `built-in` types are mapped to PHP types as shown in the table below:

Slice	Ruby
<code>bool</code>	<code>true</code> or <code>false</code>
<code>byte</code>	<code>integer</code>
<code>short</code>	<code>integer</code>
<code>int</code>	<code>integer</code>
<code>long</code>	<code>integer</code>
<code>float</code>	<code>double</code>
<code>double</code>	<code>double</code>
<code>string</code>	<code>string</code>

PHP's `integer` type may not accommodate the range of values supported by Slice's `long` type, therefore `long` values that are outside this range are mapped as strings. Scripts must be prepared to receive an `integer` or `string` from any operation that returns a `long` value.

String Mapping in PHP

String values returned as the result of a Slice operation (including return values, out parameters, and data members) contain UTF-8 encoded strings unless the program has installed a [string converter](#), in which case string values use the converter's native encoding instead.

As string input values for a remote Slice operation, Ice accepts `null` in addition to `string` objects; each occurrence of `null` is marshaled as an empty string. Ice assumes that all `string` objects contain valid UTF-8 encoded strings unless the program has installed a string converter, in which case Ice assumes that `string` objects use the native encoding expected by the converter.

See Also

- [Basic Types](#)
- [PHP Mapping for Identifiers](#)
- [PHP Mapping for Modules](#)
- [PHP Mapping for Enumerations](#)
- [PHP Mapping for Structures](#)
- [PHP Mapping for Sequences](#)
- [PHP Mapping for Dictionaries](#)
- [PHP Mapping for Constants](#)
- [PHP Mapping for Exceptions](#)
- [C++ Strings and Character Encoding](#)

PHP Mapping for Enumerations

PHP does not have an enumerated type, so a Slice [enumeration](#) is mapped to a PHP class: the name of the Slice enumeration becomes the name of the PHP class; for each enumerator, the class contains a constant with the same name as the enumerator. For example:

Slice
<pre>enum Fruit { Apple, Pear, Orange };</pre>

The generated PHP class looks as follows:

PHP
<pre>class Fruit { const Apple = 0; const Pear = 1; const Orange = 2; }</pre>

Suppose we modify the Slice definition to include a [custom enumerator value](#):

Slice
<pre>enum Fruit { Apple, Pear = 3, Orange };</pre>

The generated PHP class changes accordingly:

PHP
<pre>class Fruit { const Apple = 0; const Pear = 3; const Orange = 4; }</pre>

Since enumerated values are mapped to integer constants, application code is not required to use the generated constants. When an enumerated value enters the Ice run time, Ice validates that the given integer is a valid value for the enumeration. However, to minimize the potential for defects in your code, we recommend using the generated constants instead of literal integers.

See Also

- [Enumerations](#)
- [PHP Mapping for Identifiers](#)
- [PHP Mapping for Modules](#)
- [PHP Mapping for Built-In Types](#)
- [PHP Mapping for Structures](#)
- [PHP Mapping for Sequences](#)
- [PHP Mapping for Dictionaries](#)

- [PHP Mapping for Constants](#)
- [PHP Mapping for Exceptions](#)

PHP Mapping for Structures

A Slice [structure](#) maps to a PHP class containing a public variable for each member of the structure. For example, here is our [Employee](#) structure once more:

Slice
<pre>struct Employee { long number; string firstName; string lastName; };</pre>

The PHP mapping generates the following definition for this structure:

PHP
<pre>class Employee { public function __construct(\$number=0, \$firstName='', \$lastName=''); public function __toString(); public \$number; public \$firstName; public \$lastName; }</pre>

The class provides a constructor whose arguments correspond to the data members. This allows you to instantiate and initialize the class in a single statement (instead of having to first instantiate the class and then assign to its members). Each argument provides a default value appropriate for the member's type. You can also declare different [default values](#) for members of primitive and enumerated types.

The mapping also includes a definition for the `__toString` magic method, which returns a string representation of the structure.

See Also

- [Structures](#)
- [PHP Mapping for Identifiers](#)
- [PHP Mapping for Modules](#)
- [PHP Mapping for Built-In Types](#)
- [PHP Mapping for Enumerations](#)
- [PHP Mapping for Sequences](#)
- [PHP Mapping for Dictionaries](#)
- [PHP Mapping for Constants](#)
- [PHP Mapping for Exceptions](#)

PHP Mapping for Sequences

A Slice [sequence](#) maps to a native PHP indexed array. The first element of the Slice sequence is contained at index 0 (zero) of the PHP array, followed by the remaining elements in ascending index order.

Consider this example:

Slice
<pre>sequence<Fruit> FruitPlatter;</pre>

You can create an instance of `FruitPlatter` as shown below:

PHP
<pre>// Make a small platter with one Apple and one Orange // \$platter = array(Fruit::Apple, Fruit::Orange);</pre>

The Ice run time validates the elements of an array to ensure that they are compatible with the declared type and raises `InvalidArgumentException` if an incompatible type is encountered.

See Also

- [Sequences](#)
- [PHP Mapping for Identifiers](#)
- [PHP Mapping for Modules](#)
- [PHP Mapping for Built-In Types](#)
- [PHP Mapping for Enumerations](#)
- [PHP Mapping for Structures](#)
- [PHP Mapping for Dictionaries](#)
- [PHP Mapping for Constants](#)
- [PHP Mapping for Exceptions](#)

PHP Mapping for Dictionaries

A Slice [dictionary](#) maps to a native PHP associative array. The PHP mapping does not currently support all Slice dictionary types, however, because native PHP associative arrays support only integers and strings as keys.

A Slice dictionary whose key type is an enumeration or one of the primitive types `boolean`, `byte`, `short`, `int`, or `long` is mapped as an associative array with an integer key.



Boolean values are treated as integers, with false equivalent to 0 (zero) and true equivalent to 1 (one).

A Slice dictionary with a `string` key type is mapped as an associative array with a string key. All other key types cause a warning to be generated.

Here is the definition of our `EmployeeMap`:

```
Slice
```

```
dictionary<long, Employee> EmployeeMap;
```

You can create an instance of this dictionary as shown below:

```
PHP
```

```
$e1 = new Employee;
$e1->number = 42;
$e1->firstName = "Stan";
$e1->lastName = "Lipmann";

$e2 = new Employee;
$e2->number = 77;
$e2->firstName = "Herb";
$e2->lastName = "Sutter";

$em = array($e1->number => $e1, $e2->number => $e2);
```

The Ice run time validates the elements of a dictionary to ensure that they are compatible with the declared type; `InvalidArgumentException` exception is raised if an incompatible type is encountered.

See Also

- [Dictionaries](#)
- [PHP Mapping for Identifiers](#)
- [PHP Mapping for Modules](#)
- [PHP Mapping for Built-In Types](#)
- [PHP Mapping for Enumerations](#)
- [PHP Mapping for Structures](#)
- [PHP Mapping for Sequences](#)
- [PHP Mapping for Constants](#)
- [PHP Mapping for Exceptions](#)

PHP Mapping for Constants

A Slice `constant` maps to a PHP constant. Consider the following definitions:

Slice
<pre> module M { const bool AppendByDefault = true; const byte LowerNibble = 0x0f; const string Advice = "Don't Panic!"; const short TheAnswer = 42; const double PI = 3.1416; enum Fruit { Apple, Pear, Orange }; const Fruit FavoriteFruit = Pear; }; </pre>

The mapping for these constants is shown below:

PHP
<pre> define('M_AppendByDefault', true); define('M_LowerNibble', 15); define('M_Advice', "Don't Panic!"); define('M_TheAnswer', 42); define('M_PI', 3.1416); define('M_FavoriteFruit', M_Fruit::Pear); </pre>

An application refers to a constant using its flattened name:

PHP
<pre> \$ans = M_TheAnswer; </pre>

Using the namespace mapping, Slice constants are mapped to PHP constants in the enclosing namespace:

PHP
<pre> \$ans = \M\TheAnswer; </pre>

See Also

- [Constants and Literals](#)
- [PHP Mapping for Identifiers](#)
- [PHP Mapping for Modules](#)
- [PHP Mapping for Built-In Types](#)
- [PHP Mapping for Enumerations](#)
- [PHP Mapping for Structures](#)
- [PHP Mapping for Sequences](#)

- [PHP Mapping for Dictionaries](#)
- [PHP Mapping for Exceptions](#)

PHP Mapping for Exceptions

On this page:

- [Inheritance Hierarchy for Exceptions in PHP](#)
- [PHP Mapping for User Exceptions](#)
- [PHP Mapping for Run-Time Exceptions](#)

Inheritance Hierarchy for Exceptions in PHP

The mapping for exceptions is based on the inheritance hierarchy shown below:

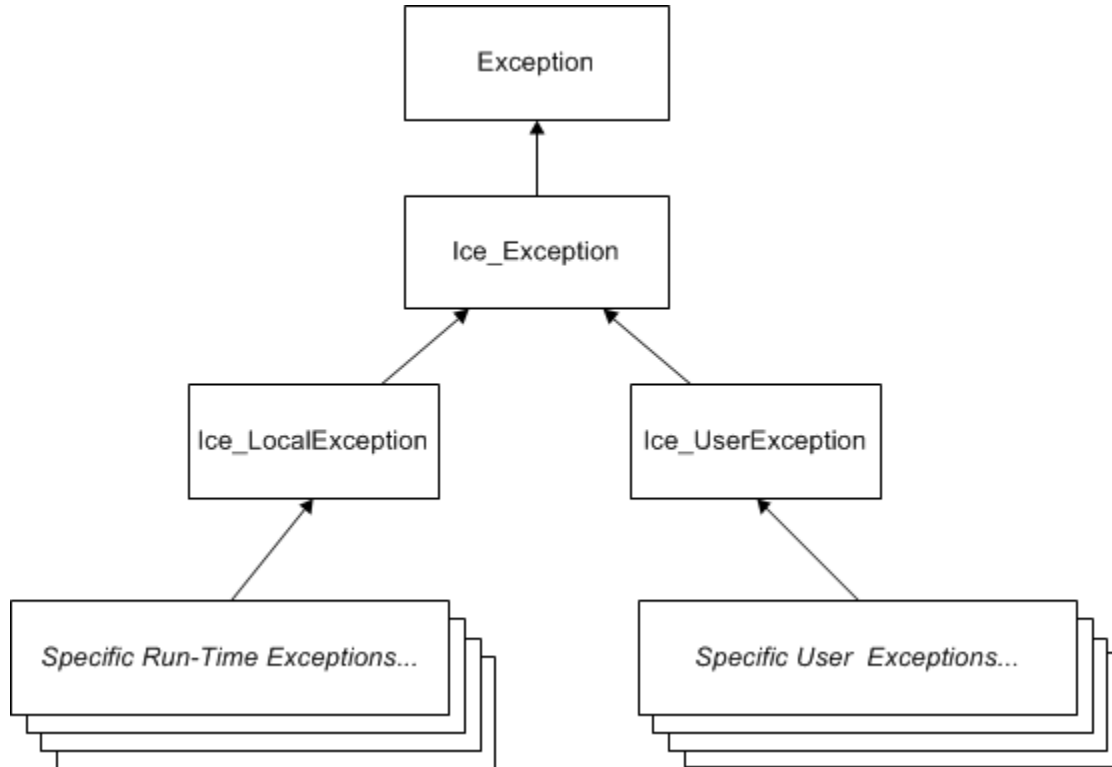

Inheritance structure for Ice exceptions.

The ancestor of all exceptions is `Exception`, from which `Ice_Exception` is derived. `Ice_LocalException` and `Ice_UserException` are derived from `Ice_Exception` and form the base for all run-time and user exceptions.

PHP Mapping for User Exceptions

Here is a fragment of the Slice definition for our world time server once more:

```

Slice
exception GenericError {
    string reason;
};
exception BadTimeVal extends GenericError {};
exception BadZoneName extends GenericError {};
  
```

These exception definitions map to the abbreviated PHP class definitions shown below:

PHP
<pre> class GenericError extends Ice_UserException { public function __construct(\$reason=''); public function ice_name(); public function __toString(); public \$reason; } class BadTimeVal extends GenericError { public function __construct(\$reason=''); public function ice_name(); public function __toString(); } class BadZoneName extends GenericError { public function __construct(\$reason=''); public function ice_name(); public function __toString(); } </pre>

Each Slice exception is mapped to a PHP class with the same name. The inheritance structure of the Slice exceptions is preserved for the generated classes, so `BadTimeVal` and `BadZoneName` inherit from `GenericError`.

Each exception member corresponds to an instance variable of the instance, which the constructor initializes to a default value appropriate for its type. You can also declare different [default values](#) for members of primitive and enumerated types. For derived exceptions, the constructor has one parameter for each of the base exception's data members, plus one parameter for each of the derived exception's data members, in base-to-derived order. As an example, although `BadTimeVal` and `BadZoneName` do not declare data members, their constructors still accept a value for the inherited data member `reason` in order to pass it to the constructor of the base exception `GenericError`.

[Optional data members](#) use the same mapping as required data members, but an optional data member can also be set to the marker value `Ice_Unset` to indicate that the member is unset. A well-behaved program must compare an optional data member to `Ice_Unset` before using the member's value:

PHP

```
try {
    ...
} catch($ex) {
    if($ex->optionalMember == Ice_Unset)
        echo "optionalMember is unset\n";
    else
        echo "optionalMember = " . $ex->optionalMember . "\n";
}
```

Each exception also defines the `ice_name` method to return the exception's type name, as well as the `__toString` magic method to return a stringified representation of the exception and its members.

All user exceptions are derived from the base class `Ice_UserException`. This allows you to catch all user exceptions generically by installing a handler for `Ice_UserException`. Similarly, you can catch all Ice run-time exceptions with a handler for `Ice_LocalException`, and you can catch all Ice exceptions with a handler for `Ice_Exception`.

PHP Mapping for Run-Time Exceptions

The Ice run time throws [run-time exceptions](#) for a number of pre-defined error conditions. All run-time exceptions directly or indirectly derive from `Ice_LocalException` (which, in turn, derives from `Ice_Exception`).

By catching exceptions at the appropriate point in the inheritance hierarchy, you can handle exceptions according to the category of error they indicate:

- `Ice_LocalException`
This is the root of the inheritance tree for run-time exceptions.
- `Ice_UserException`
This is the root of the inheritance tree for user exceptions.
- `Ice_TimeoutException`
This is the base exception for both operation-invocation and connection-establishment timeouts.
- `Ice_ConnectTimeoutException`
This exception is raised when the initial attempt to establish a connection to a server times out.

For example, `Ice_ConnectTimeoutException` can be handled as `Ice_ConnectTimeoutException`, `Ice_TimeoutException`, `Ice_LocalException`, or `Ice_Exception`.

You will probably have little need to catch run-time exceptions as their most-derived type and instead catch them as `Ice_LocalException`; the fine-grained error handling offered by the remainder of the hierarchy is of interest mainly in the implementation of the Ice run time.

Exceptions to this rule are the exceptions related to [facet](#) and [object](#) life cycles, which you may want to catch explicitly. These exceptions are `Ice_FacetNotExistException` and `Ice_ObjectNotExistException`, respectively.

See Also

- [User Exceptions](#)
- [Run-Time Exceptions](#)
- [PHP Mapping for Identifiers](#)
- [PHP Mapping for Modules](#)
- [PHP Mapping for Built-In Types](#)
- [PHP Mapping for Enumerations](#)
- [PHP Mapping for Structures](#)
- [PHP Mapping for Sequences](#)

- [PHP Mapping for Dictionaries](#)
- [PHP Mapping for Constants](#)
- [Optional Data Members](#)
- [Facets and Versioning](#)
- [Object Life Cycle](#)

PHP Mapping for Interfaces

The mapping of Slice [interfaces](#) revolves around the idea that, to invoke a remote operation, you call a member function on a local class instance that is a [proxy](#) for the remote object. This makes the mapping easy and intuitive to use because making a remote procedure call is no different from making a local procedure call (apart from error semantics).

On this page:

- [Proxy Objects in PHP](#)
- [Ice_ObjectPrx Class in PHP](#)
- [Casting Proxies in PHP](#)
 - [Proxy Backward Compatibility in PHP](#)
- [Using Proxy Methods in PHP](#)
- [Object Identity and Proxy Comparison in PHP](#)

Proxy Objects in PHP

Slice interfaces are implemented by instances of the `Ice_ObjectPrx` class. In the client's address space, an instance of `ObjectPrx` is the local ambassador for a remote instance of an interface in a server and is known as a *proxy instance*. All the details about the server-side object, such as its address, what protocol to use, and its object identity are encapsulated in that instance.

The PHP mapping for proxies differs from that of other Ice language mappings in that the `ObjectPrx` class is used to implement *all* Slice interfaces. The primary motivation for this design is minimizing the amount of code that is generated for each interface. As a result, a proxy object returned by the communicator operations `stringToProxy` and `propertyToProxy` is *untyped*, meaning it is not associated with a user-defined Slice interface. Once you narrow the proxy to a particular interface, you can use that proxy to invoke your Slice operations.

Proxy instances are always created on behalf of the client by the Ice run time, so client code never has any need to instantiate a proxy directly.

A value of `null` denotes the null proxy. The null proxy is a dedicated value that indicates that a proxy points "nowhere" (denotes no object).

For each operation in the interface, the proxy object supports a method of the same name. Each operation accepts an optional trailing parameter representing the operation context. This parameter is an associative string array for use by the Ice run time to store information about how to deliver a request. You normally do not need to use it. (We examine the context parameter in detail in [Request Contexts](#). The parameter is also used by `IceStorm`.)

Ice_ObjectPrx Class in PHP

In the PHP language mapping, all proxies are instances of `Ice_ObjectPrx`. This class provides a number of methods:

PHP
<pre>class Ice_ObjectPrx { function ice_getIdentity(); function ice_isA(\$id); function ice_ids(); function ice_id(); function ice_ping(); # ... }</pre>

The methods behave as follows:

- **ice_getIdentity**
This method returns the identity of the object denoted by the proxy. The identity of an Ice object has the following Slice type:

Slice

```
module Ice {
    struct Identity {
        string name;
        string category;
    };
};
```

To see whether two proxies denote the same object, first obtain the identity for each object and then compare the identities:

PHP

```
$proxy1 = ...
$proxy2 = ...
$id1 = $proxy1->ice_getIdentity();
$id2 = $proxy2->ice_getIdentity();

if($id1 == $id2)
    // proxy1 and proxy2 denote the same object
else
    // proxy1 and proxy2 denote different objects
```

- **ice_isA**

The `ice_isA` method determines whether the object denoted by the proxy supports a specific interface. The argument to `ice_isA` is a **type ID**. For example, to see whether a proxy of type `ObjectPrx` denotes a `Printer` object, we can write:

PHP

```
$proxy = ...
if($proxy != null && $proxy->ice_isA("::Printer"))
    // proxy denotes a Printer object
else
    // proxy denotes some other type of object
```

Note that we are testing whether the proxy is `null` before attempting to invoke the `ice_isA` method. This avoids getting a run-time error if the proxy is `null`.

- **ice_ids**

The `ice_ids` method returns an array of strings representing all of the **type IDs** that the object denoted by the proxy supports.

- **ice_id**

The `ice_id` method returns the **type ID** of the object denoted by the proxy. Note that the type returned is the type of the actual object, which may be more derived than the static type of the proxy. For example, if we have a proxy of type `BasePrx`, with a static type ID of `::Base`, the return value of `ice_id` might be `::Base`, or it might be something more derived, such as `::Derived`.

- **ice_ping**

The `ice_ping` method provides a basic reachability test for the object. If the object can physically be contacted (that is, the object exists and its server is running and reachable), the call completes normally; otherwise, it throws an exception that indicates why the

object could not be reached, such as `ObjectNotExistException` or `ConnectTimeoutException`.

The `ObjectPrx` class also defines an operator for comparing two proxies for equality. Note that all aspects of proxies are compared by this operation, such as the communication endpoints for the proxy. This means that, in general, if two proxies compare unequal, that does *not* imply that they denote different objects. For example, if two proxies denote the same Ice object via different transport endpoints, `==` returns `false` even though the proxies denote the same object.

The `ice_isA`, `ice_ids`, `ice_id`, and `ice_ping` methods are remote operations and therefore support an additional overloading that accepts a `request context`. Also note that there are [other methods](#) in `ObjectPrx`, not shown here. These methods provide different ways to dispatch a call and also provide access to an object's [facets](#).

Casting Proxies in PHP

The PHP mapping for a proxy generates a class with two static methods. For example, the following class is generated for the `Simple` interface named `Simple`:

PHP
<pre>class SimplePrxHelper { public static function checkedCast(\$proxy, \$facetOrCtx=null, \$ctx=null); public static function uncheckedCast(\$proxy, \$facet=null); }</pre>

The method names `checkedCast` and `uncheckedCast` are reserved for use in proxies. If a Slice interface defines an operation with either of those names, the mapping escapes the name in the generated proxy by prepending an underscore. For example, an interface that defines an operation named `checkedCast` is mapped to a proxy with a method named `_checkedCast`.

For `checkedCast`, if the passed proxy is for an object of type `Simple`, or a proxy for an object with a type derived from `Simple`, the cast returns a proxy narrowed to that type; otherwise, if the passed proxy denotes an object of a different type (or if the passed proxy is `null`), the cast returns `null`.

The arguments are described below:

- `$proxy`
The proxy to be narrowed.
- `$facetOrCtx`
This optional argument can be either a string representing a desired [facet](#), or an associative string array representing a [context](#).
- `$ctx`
If `$facetOrCtx` contains a facet name, use this argument to supply an associative string array representing a [context](#).
- `$facet`
Specifies the name of the desired [facet](#).

Given a proxy of any type, you can use a `checkedCast` to determine whether the corresponding object supports a given type, for example:

PHP

```
$obj = ...           // Get a proxy from somewhere...

$simple = SimplePrxHelper::checkedCast($obj);
if($simple != null)
    // Object supports the Simple interface...
else
    // Object is not of type Simple...
```

Note that a `checkedCast` contacts the server. This is necessary because only the server implementation has definite knowledge of the type of an object. As a result, a `checkedCast` may throw a `ConnectTimeoutException` or an `ObjectNotExistException`.

In contrast, an `uncheckedCast` does not contact the server and unconditionally returns a proxy of the requested type. However, if you do use an `uncheckedCast`, you must be certain that the proxy really does support the type you are casting to; otherwise, if you get it wrong, you will most likely get a run-time exception when you invoke an operation on the proxy. The most likely error for such a type mismatch is `OperationNotExistException`. However, other exceptions, such as a marshaling exception are possible as well. And, if the object happens to have an operation with the correct name, but different parameter types, no exception may be reported at all and you simply end up sending the invocation to an object of the wrong type; that object may do rather nonsensical things. To illustrate this, consider the following two interfaces:

Slice

```
interface Process {
    void launch(int stackSize, int dataSize);
};

// ...

interface Rocket {
    void launch(float xCoord, float yCoord);
};
```

Suppose you expect to receive a proxy for a `Process` object and use an `uncheckedCast` to down-cast the proxy:

PHP

```
$obj = ...           // Get proxy...
$process = ProcessPrxHelper::uncheckedCast($obj); // No worries...
$process->launch(40, 60);           // Oops...
```

If the proxy you received actually denotes a `Rocket` object, the error will go undetected by the Ice run time: because `int` and `float` have the same size and because the Ice protocol does not tag data with its type on the wire, the implementation of `Rocket::launch` will simply misinterpret the passed integers as floating-point numbers.

In fairness, this example is somewhat contrived. For such a mistake to go unnoticed at run time, both objects must have an operation with the same name and, in addition, the run-time arguments passed to the operation must have a total marshaled size that matches the number of bytes that are expected by the unmarshaling code on the server side. In practice, this is extremely rare and an incorrect `uncheckedCast` typically results in a run-time exception.

Proxy Backward Compatibility in PHP

Prior releases of the PHP language mapping provided two proxy methods for narrowing a proxy:

```

PHP
class Ice_ObjectPrx
{
    function ice_checkedCast($type, $facetOrCtx=null, $ctx=null);
    function ice_uncheckedCast($type, $facet=null);
    # ...
}

```

For example, a proxy can be narrowed as follows:

```

PHP
$proxy = $proxy->ice_checkedCast("::Demo::Hello");

```

Embedding such type ID strings in your application is a potential source of defects because the strings are not validated until run time. Although these methods are still supported for the sake of backward compatibility, we recommend using the static methods that are generated in the helper class corresponding to each interface, as shown below:

```

PHP
$proxy = Demo_HelloPrxHelper::checkedCast($proxy);

```

Not only are these static methods consistent with the APIs of other Ice language mappings, they also avoid the need to hard-code type ID strings in your application.

Using Proxy Methods in PHP

The base proxy class `ObjectPrx` supports a variety of [methods for customizing a proxy](#). Since proxies are immutable, each of these "factory methods" returns a copy of the original proxy that contains the desired modification. For example, you can obtain a proxy configured with a ten second timeout as shown below:

```

PHP
$proxy = $communicator->stringToProxy(...);
$proxy = $proxy->ice_timeout(10000);

```

A factory method returns a new proxy object if the requested modification differs from the current proxy, otherwise it returns the current proxy. With few exceptions, factory methods return a proxy of the same type as the current proxy, therefore it is generally not necessary to repeat a down-cast after using a factory method. The example below demonstrates these semantics:

PHP

```
$base = $communicator->stringToProxy(...);
$hello = Demo_HelloPrxHelper::checkedCast($base);
$hello = $hello->ice_timeout(10000); // Type is not discarded
$hello->sayHello();
```

The only exceptions are the factory methods `ice_facet` and `ice_identity`. Calls to either of these methods may produce a proxy for an object of an unrelated type, therefore they return an untyped proxy that you must subsequently down-cast to an appropriate type.

Object Identity and Proxy Comparison in PHP

Proxy objects support comparison using the comparison operators `==` and `!=`. Note that proxy comparison uses *all* of the information in a proxy for the comparison. This means that not only the object identity must match for a comparison to succeed, but other details inside the proxy, such as the protocol and endpoint information, must be the same. In other words, comparison tests for *proxy* identity, *not* object identity. A common mistake is to write code along the following lines:

PHP

```
$p1 = ...           // Get a proxy...
$p2 = ...           // Get another proxy...

if($p1 != $p2)
    // p1 and p2 denote different objects        // WRONG!
else
    // p1 and p2 denote the same object          // Correct
```

Even though `p1` and `p2` differ, they may denote the same Ice object. This can happen because, for example, both `p1` and `p2` embed the same object identity, but each uses a different protocol to contact the target object. Similarly, the protocols may be the same, but denote different endpoints (because a single Ice object can be contacted via several different transport endpoints). In other words, if two proxies compare equal, we know that the two proxies denote the same object (because they are identical in all respects); however, if two proxies compare unequal, we know absolutely nothing: the proxies may or may not denote the same object.

To compare the object identities of two proxies, you can use helper functions in the `Ice` module:

PHP

```
function Ice_proxyIdentityCompare($lhs, $rhs);
function Ice_proxyIdentityAndFacetCompare($lhs, $rhs);
```

`proxyIdentityCompare` allows you to correctly compare proxies for identity:

PHP

```
$p1 = ...           // Get a proxy...
$p2 = ...           // Get another proxy...

if(Ice_proxyIdentityCompare($p1, $p2) != 0)
    // p1 and p2 denote different objects        // Correct
else
    // p1 and p2 denote the same object          // Correct
```

The function returns 0 if the identities are equal, -1 if `p1` is less than `p2`, and 1 if `p1` is greater than `p2`. (The comparison uses `name` as the major sort key and `category` as the minor sort key.)

The `proxyIdentityAndFacetCompare` function behaves similarly, but compares both the identity and the [facet name](#).

See Also

- [Interfaces, Operations, and Exceptions](#)
- [Proxies](#)
- [Type IDs](#)
- [PHP Mapping for Operations](#)
- [Request Contexts](#)
- [Facets and Versioning](#)
- [IceStorm](#)

PHP Mapping for Operations

On this page:

- [Basic PHP Mapping for Operations](#)
- [Normal and `idempotent` Operations in PHP](#)
- [Passing Parameters in PHP](#)
 - [In-Parameters in PHP](#)
 - [Out-Parameters in PHP](#)
 - [Parameter Type Mismatches in PHP](#)
 - [Null Parameters in PHP](#)
 - [Optional Parameters in PHP](#)
- [Exception Handling in PHP](#)

Basic PHP Mapping for Operations

As we saw in the [PHP mapping for interfaces](#), for each `operation` on an interface, a proxy object narrowed to that type supports a corresponding method with the same name. To invoke an operation, you call it via the proxy. For example, here is part of the definitions for our `file system`:

```

Slice

module Filesystem {
    interface Node {
        idempotent string name();
    };
    // ...
};
```

The `name` operation returns a value of type `string`. Given a proxy to an object of type `Node`, the client can invoke the operation as follows:

```

PHP

$node = ... // Initialize proxy
$name = $node->name(); // Get name via RPC
```

Normal and `idempotent` Operations in PHP

You can add an `idempotent` qualifier to a `Slice` operation. As far as the signature for the corresponding proxy method is concerned, `idempotent` has no effect.

Passing Parameters in PHP

In-Parameters in PHP

The PHP mapping for `in` parameters guarantees that the value of a parameter will not be changed by the invocation.

Here is an interface with operations that pass parameters of various types from client to server:

Slice

```

struct NumberAndString {
    int x;
    string str;
};

sequence<string> StringSeq;

dictionary<long, StringSeq> StringTable;

interface ClientToServer {
    void op1(int i, float f, bool b, string s);
    void op2(NumberAndString ns, StringSeq ss, StringTable st);
    void op3(ClientToServer* proxy);
};

```

A proxy object narrowed to the `ClientToServer` interface supports the following methods:

PHP

```

function op1($i, $f, $b, $s, $_ctx=null);
function op2($ns, $ss, $st, $_ctx=null);
function op3($proxy, $_ctx=null);

```

Given a proxy to a `ClientToServer` interface, the client code can pass parameters as in the following example:

PHP

```

$p = ... // Get proxy...

$p->op1(42, 3.14, true, "Hello world!"); // Pass simple literals

$i = 42;
$f = 3.14;
$b = true;
$s = "Hello world!";
$p->op1($i, $f, $b, $s); // Pass simple variables

$ns = new NumberAndString;
$ns->x = 42;
$ns->str = "The Answer";
$ss = array("Hello world!");
$st = array();
$st[0] = $ns;
$p->op2($ns, $ss, $st); // Pass complex variables

$p->op3($p); // Pass proxy

```

Out-Parameters in PHP

Out parameters are passed by reference. Here is the same Slice definition we saw earlier, but this time with all parameters being passed in the out direction:

Slice

```

struct NumberAndString {
    int x;
    string str;
};

sequence<string> StringSeq;

dictionary<long, StringSeq> StringTable;

interface ServerToClient {
    int op1(out float f, out bool b, out string s);
    void op2(out NumberAndString ns,
             out StringSeq ss,
             out StringTable st);
    void op3(out ServerToClient* proxy);
};

```

The PHP mapping looks the same as it did for the in-parameters version:

PHP

```
function op1($i, $f, $b, $s, $_ctx=null);
function op2($ns, $ss, $st, $_ctx=null);
function op3($proxy, $_ctx=null);
```

Given a proxy to a `ServerToClient` interface, the client code can receive the results as in the following example:

PHP

```
$p = ... // Get proxy...
$p->op1($i, $f, $b, $s);
$p->op2($ns, $ss, $st);
$p->op3($stcp);
```

Note that it is not necessary to use the reference operator (&) before each argument because the Ice run time forces each `out` parameter to have reference semantics.

Parameter Type Mismatches in PHP

The Ice run time performs validation on the arguments to a proxy invocation and reports any type mismatches as `InvalidArgumentException`.

Null Parameters in PHP

Some Slice types naturally have "empty" or "not there" semantics. Specifically, sequences, dictionaries, and strings all can be `null`, but the corresponding Slice types do not have the concept of a null value. To make life with these types easier, whenever you pass `null` as a parameter or return value of type sequence, dictionary, or string, the Ice run time automatically sends an empty sequence, dictionary, or string to the receiver.

This behavior is useful as a convenience feature: especially for deeply-nested data types, members that are sequences, dictionaries, or strings automatically arrive as an empty value at the receiving end. This saves you having to explicitly initialize, for example, every string element in a large sequence before sending the sequence in order to avoid a run-time error. Note that using null parameters in this way does *not* create null semantics for Slice sequences, dictionaries, or strings. As far as the object model is concerned, these do not exist (only *empty* sequences, dictionaries, and strings do). For example, it makes no difference to the receiver whether you send a string as `null` or as an empty string: either way, the receiver sees an empty string.

Optional Parameters in PHP

[Optional parameters](#) use the same mapping as required parameters. The only difference is that `Ice_Unset` can be passed as the value of an optional parameter or return value. Consider the following operation:

Slice

```
optional(1) int execute(optional(2) string params, out optional(3) float
value);
```

A client can invoke this operation as shown below:

PHP

```

$i = $proxy->execute("--file log.txt", $v);
$i = $proxy->execute(Ice_Unset, $v);

if($v != Ice_Unset)
    echo "value = " . $v . "\n";

```

A well-behaved program must always compare an optional parameter to `Ice_Unset` prior to using its value.

Exception Handling in PHP

Any operation invocation may throw a [run-time exception](#) and, if the operation has an exception specification, may also throw [user exceptions](#). Suppose we have the following simple interface:

Slice

```

exception Tantrum {
    string reason;
};

interface Child {
    void askToCleanUp() throws Tantrum;
};

```

Slice exceptions are thrown as PHP exceptions, so you can simply enclose one or more operation invocations in a `try-catch` block:

PHP

```

$child = ... // Get child proxy...

try
{
    $child->askToCleanUp();
}
catch(Tantrum $t)
{
    echo "The child says: " . $t->reason . "\n";
}

```

Typically, you will catch only a few exceptions of specific interest around an operation invocation; other exceptions, such as unexpected run-time errors, will usually be handled by exception handlers higher in the hierarchy. For example:

PHP

```
function run()
{
    $schild = ...           // Get child proxy...
    try
    {
        $schild->askToCleanUp();
    }
    catch(Tantrum $t)
    {
        echo "The child says: " . $t->reason . "\n";
        $schild->scold(); // Recover from error...
    }
    $schild->praise();      // Give positive feedback...
}

try
{
    // ...
    run();
    // ...
}
catch(Ice_Exception $ex)
{
    echo $ex->__toString() . "\n";
}
```

This code handles a specific exception of local interest at the point of call and deals with other exceptions generically. (This is also the strategy we used for our first simple application in Hello World Application.)

See Also

- [Operations](#)
- [Hello World Application](#)
- [Slice for a Simple File System](#)
- [PHP Mapping for Interfaces](#)
- [PHP Mapping for Exceptions](#)

PHP Mapping for Classes

On this page:

- [Basic PHP Mapping for Classes](#)
- [Inheritance from `Object` in PHP](#)
- [Class Data Members in PHP](#)
- [Class Constructors in PHP](#)
- [Class Operations in PHP](#)
- [Class Factories in PHP](#)

Basic PHP Mapping for Classes

A Slice `class` maps to a Ruby class with the same name. For each Slice data member, the generated class contains a member variable, just as for structures and exceptions. Consider the following class definition:

```

Slice



```
class TimeOfDay {
 short hour; // 0 - 23
 short minute; // 0 - 59
 short second; // 0 - 59
 string format(); // Return time as hh:mm:ss
};
```

```

The PHP mapping generates the following code for this definition:

PHP

```

abstract class TimeOfDay extends Ice_ObjectImpl
{
    public function __construct($hour=0, $minute=0, $second=0)
    {
        $this->hour = $hour;
        $this->minute = $minute;
        $this->second = $second;
    }

    abstract public function format();

    public static function ice_staticId()
    {
        return '::TimeOfDay';
    }

    public function __toString()
    {
        // ...
    }

    public $hour;
    public $minute;
    public $second;
}

```

There are a number of things to note about the generated code:

1. The generated class `TimeOfDay` inherits from `Ice_ObjectImpl`. This reflects the semantics of Slice classes in that all classes implicitly inherit from `Object`, which is the ultimate ancestor of all classes. Note that `Object` is *not* the same as `Ice_ObjectPrx`. In other words, you *cannot* pass a class where a proxy is expected and vice versa.
2. The constructor initializes an instance variable for each Slice data member.
3. The class includes an abstract function declaration corresponding to the Slice operation `format`.
4. The class defines the class method `ice_staticId`.

There is quite a bit to discuss here, so we will look at each item in turn.

Inheritance from `Object` in PHP

Like interfaces, classes implicitly inherit from a common base class, `Ice_Object`. However, classes inherit from `Ice_Object` instead of `Ice_ObjectPrx`, therefore you cannot pass a class where a proxy is expected (and vice versa) because the base types for classes and proxies are not compatible.

`Ice_Object` contains a number of member functions:

PHP

```
interface Ice_Object
{
    public function ice_isA($id);

    public function ice_ping();

    public function ice_ids();

    public function ice_id();

    public function ice_preMarshal();

    public function ice_postUnmarshal();
}
```

The member functions of `Ice_Object` behave as follows:

- `ice_isA`
This method returns `true` if the object supports the given [type ID](#), and `false` otherwise.
- `ice_ping`
As for interfaces, `ice_ping` provides a basic reachability test for the object.
- `ice_ids`
This method returns a string sequence representing all of the [type IDs](#) supported by this object, including `::Ice::Object`.
- `ice_id`
This method returns the actual run-time [type ID](#) of the object. If you call `ice_id` through a reference to a base instance, the returned type ID is the actual (possibly more derived) type ID of the instance.
- `ice_preMarshal`
If the object supports this method, the Ice run time invokes it just prior to marshaling the object's state, providing the opportunity for the object to validate its declared data members.
- `ice_postUnmarshal`
If the object supports this method, the Ice run time invokes it after unmarshaling the object's state. An object typically defines this method when it needs to perform additional initialization using the values of its declared data members.

All Slice classes derive from `Ice_Object` via the `Ice_ObjectImpl` abstract base class, which provides default implementations of the `Ice_Object` methods.

Class Data Members in PHP

By default, data members of classes are mapped exactly as for structures and exceptions: for each data member in the Slice definition, the generated class contains a corresponding member variable.

[Optional data members](#) use the same mapping as required data members, but an optional data member can also be set to the marker value `Ice_Unset` to indicate that the member is unset. A well-behaved program must compare an optional data member to `Ice_Unset` before using the member's value:

PHP

```

$v = ...;
if($v->optionalMember == Ice_Unset)
    echo "optionalMember is unset\n";
else
    echo "optionalMember = " . $v->optionalMember . "\n";

```

If you wish to restrict access to a data member, you can modify its visibility using the `protected` metadata directive. The presence of this directive causes the Slice compiler to generate the data member with protected visibility. As a result, the member can be accessed only by the class itself or by one of its subclasses. For example, the `TimeOfDay` class shown below has the `protected` metadata directive applied to each of its data members:

Slice

```

class TimeOfDay {
    ["protected"] short hour;    // 0 - 23
    ["protected"] short minute; // 0 - 59
    ["protected"] short second; // 0 - 59
    string format();           // Return time as hh:mm:ss
};

```

The Slice compiler produces the following generated code for this definition:

PHP

```

abstract class TimeOfDay extends Ice_ObjectImpl
{
    public function __construct($hour=0, $minute=0, $second=0)
    {
        $this->hour = $hour;
        $this->minute = $minute;
        $this->second = $second;
    }

    abstract public function format();

    public static function ice_staticId()
    {
        return '::TimeOfDay';
    }

    public function __toString()
    {
        // ...
    }

    protected $hour;
    protected $minute;
    protected $second;
}

```

For a class in which all of the data members are protected, the metadata directive can be applied to the class itself rather than to each member individually. For example, we can rewrite the `TimeOfDay` class as follows:

Slice

```

["protected"] class TimeOfDay {
    short hour;           // 0 - 23
    short minute;        // 0 - 59
    short second;        // 0 - 59
    string format();     // Return time as hh:mm:ss
};

```

Class Constructors in PHP

Classes have a constructor that assigns to each data member a default value appropriate for its type. You can also declare different default values for data members of primitive and enumerated types.

For derived classes, the constructor has one parameter for each of the base class's data members, plus one parameter for each of the derived class's data members, in base-to-derived order.

Pass the marker value `Ice_Unset` as the value of any optional data members that you wish to be unset.

Class Operations in PHP

Operations of classes are mapped to abstract member functions in the generated class. This means that, if a class contains operations (such as the `format` operation of our `TimeOfDay` class), you must provide an implementation of the operation in a class that is derived from the generated class. For example:

```

PHP
class TimeOfDayI extends TimeOfDay
{
    public function format()
    {
        return strftime("%X");
    }
}

```

Class Factories in PHP

Having created a class such as `TimeOfDayI`, we have an implementation and we can instantiate the `TimeOfDayI` class, but we cannot receive it as the return value or as an out-parameter from an operation invocation. To see why, consider the following simple interface:

```

Slice
interface Time {
    TimeOfDay get();
};

```

When a client invokes the `get` operation, the Ice run time must instantiate and return an instance of the `TimeOfDay` class. However, `TimeOfDay` is an abstract class that cannot be instantiated. Unless we tell it, the Ice run time cannot magically know that we have created a `TimeOfDayI` class that implements the abstract `format` operation of the `TimeOfDay` abstract class. In other words, we must provide the Ice run time with a factory that knows that the `TimeOfDay` abstract class has a `TimeOfDayI` concrete implementation. The `Ice::CommunicatorI` interface provides us with the necessary operations:

```

Slice
module Ice {
    local interface ObjectFactory {
        Object create(string type);
        void destroy();
    };

    local interface Communicator {
        void addObjectFactory(ObjectFactory factory, string id);
        ObjectFactory findObjectFactory(string id);
        // ...
    };
};

```

To supply the Ice run time with a factory for our `TimeOfDayI` class, we must implement the `ObjectFactory` interface:

PHP

```
class ObjectFactory implements Ice_ObjectFactory {
    public function create($type) {
        if ($type == TimeOfDay::ice_staticId()) {
            return new TimeOfDayI;
        }
        assert(false);
        return null;
    }

    public function destroy() {
        // Nothing to do
    }
}
```

The object factory's `create` method is called by the Ice run time when it needs to instantiate a `TimeOfDay` class. The factory's `destroy` method is called by the Ice run time when its communicator is destroyed.

The `create` method is passed the [type ID](#) of the class to instantiate. For our `TimeOfDay` class, the type ID is `"::TimeOfDay"`. Our implementation of `create` checks the type ID: if it matches, the method instantiates and returns a `TimeOfDayI` object. For other type IDs, the method asserts because it does not know how to instantiate other types of objects.

Note that we used the `ice_staticId` method to obtain the type ID rather than embedding a literal string. Using a literal type ID string in your code is discouraged because it can lead to errors that are only detected at run time. For example, if a `Slice` class or one of its enclosing modules is renamed and the literal string is not changed accordingly, a receiver will fail to unmarshal the object and the Ice run time will raise `NoObjectFactoryException`. By using `ice_staticId` instead, we avoid any risk of a misspelled or obsolete type ID, and we can discover at compile time if a `Slice` class or module has been renamed.

Given a factory implementation, such as our `ObjectFactory`, we must inform the Ice run time of the existence of the factory:

PHP

```
$communicator = ...;
$communicator->addObjectFactory(new ObjectFactory,
    TimeOfDay::ice_staticId());
```

Now, whenever the Ice run time needs to instantiate a class with the type ID `"::TimeOfDay"`, it calls the `create` method of the registered `ObjectFactory` instance.

The `destroy` operation of the object factory is invoked by the Ice run time when the communicator is destroyed. This gives you a chance to clean up any resources that may be used by your factory. Do not call `destroy` on the factory while it is registered with the communicator — if you do, the Ice run time has no idea that this has happened and, depending on what your `destroy` implementation is doing, may cause undefined behavior when the Ice run time tries to next use the factory.

The run time guarantees that `destroy` will be the last call made on the factory, that is, `create` will not be called concurrently with `destroy`, and `create` will not be called once `destroy` has been called.

Note that you cannot register a factory for the same type ID twice: if you call `addObjectFactory` with a type ID for which a factory is registered, the Ice run time throws an `AlreadyRegisteredException`.

Finally, keep in mind that if a class has only data members, but no operations, you need not create and register an object factory to transmit instances of such a class. Only if a class has operations do you have to define and register an object factory.

See Also

- [Classes](#)
- [Type IDs](#)
- [Optional Data Members](#)

slice2php Command-Line Options

On this page:

- [slice2php Command-Line Options](#)
- [Compiler Output in PHP](#)
- [Include Files in PHP](#)

slice2php Command-Line Options

The Slice-to-PHP compiler, `slice2php`, offers the following command-line options in addition to the [standard options](#):

- `--all`
Generate code for all Slice definitions, including those included by the main Slice file.
- `-n, --namespace`
Generate code using PHP namespaces. Note that namespaces are only supported in PHP 5.3 or later. Also note that the Ice extension for PHP must be built with namespace support enabled.
- `--checksum`
Generate [checksums](#) for Slice definitions.

Compiler Output in PHP

For each Slice file `X.ice`, `slice2php` generates PHP code into a file named `X.php` in the output directory. The default output directory is the current working directory, but a different directory can be specified using the `--output-dir` option.

Include Files in PHP

It is important to understand how `slice2php` handles include files. In the absence of the `--all` option, the compiler does not generate PHP code for Slice definitions in included files. Rather, the compiler translates Slice `#include` statements into PHP `require` statements in the following manner:

1. Determine the full pathname of the included file.
2. Create the shortest possible relative pathname for the included file by iterating over each of the include directories (specified using the `-I` option) and removing the leading directory from the included file if possible.
For example, if the full pathname of an included file is `/opt/App/slice/OS/Process.ice`, and we specified the options `-I/opt/App` and `-I/opt/App/slice`, then the shortest relative pathname is `OS/Process.ice` after removing `/opt/App/slice`.
3. Replace the `.ice` extension with `.php`. Continuing our example from the previous step, the translated `require` statement becomes

```
require "OS/Process.php";
```

As a result, you can use `-I` options to tailor the `require` statements generated by the compiler in order to avoid absolute path names and match the organizational structure of your application's source files.

See Also

- [Using the Slice Compilers](#)

Application Notes for PHP

On this page:

- [PHP Request Semantics](#)
- [Using Communicators in PHP](#)
- [Managing Property Sets in PHP](#)
 - [Default Property Set in PHP](#)
 - [Profiles in PHP](#)
 - [Using Property Sets in PHP](#)
 - [Security Considerations for Property Sets in PHP](#)
- [Timeouts in PHP](#)
- [Registered Communicators in PHP](#)
 - [Limitations of Registered Communicators in PHP](#)
 - [Using Registered Communicators in PHP](#)
 - [Security Considerations for Registered Communicators in PHP](#)
 - [Lifetime of Object Factories in PHP](#)

PHP Request Semantics

In PHP terminology, a *request* is the execution of a PHP script on behalf of a Web client. Each request essentially runs in its own instance of the PHP interpreter, isolated from any other requests that may be executing concurrently. Upon the completion of a request, the interpreter reclaims memory and other resources that were acquired during the request, including objects created by the Ice extension.

Using Communicators in PHP

A communicator represents an instance of the Ice run time. A PHP script that needs to invoke an operation on a remote Ice object must initialize a communicator, obtain and narrow a proxy, and make the invocation. For example, here is a minimal (but complete) Ice script:

PHP

```

<?php
require 'Ice.php';
require 'Hello.php';

$communicator = null;

try
{
    $data = new Ice_InitializationData;
    $data->properties = Ice_createProperties();
    $data->properties->load("props.cfg");
    $communicator = Ice_initialize($data);
    $proxy = $communicator->stringToProxy("...");
    $hello = Demo_HelloPrxHelper::checkedCast($proxy);
    $hello->sayHello();
}
catch(Ice_LocalException $ex)
{
    // Deal with exception...
}

if($communicator)
{
    try
    {
        $communicator->destroy();
    }
    catch(Ice_LocalException $ex)
    {
        // Ignore.
    }
}
?>

```

By default, the Ice extension automatically destroys any communicator that was created during a request. This means a script can usually omit the call to `destroy` unless there is an application-specific reason to destroy the communicator explicitly. Consequently, we can simplify our script to the following:

PHP

```

<?php
require 'Ice.php';
require 'Hello.php';

try
{
    $data = new Ice_InitializationData;
    $data->properties = Ice_createProperties();
    $data->properties->load("props.cfg");
    $communicator = Ice_initialize($data);
    $proxy = $communicator->stringToProxy("...");
    $hello = Demo_HelloPrxHelper::checkedCast($proxy);
    $hello->sayHello();
}
catch(Ice_LocalException $ex)
{
    // Deal with exception...
}
?>

```

Now we allow the Ice extension to destroy our communicator automatically. (The extension traps and ignores any exception raised by `destroy`.)

Although the automatic destruction of communicators is convenient, it is important to consider the performance characteristics of this script. Specifically, each execution of the script involves the following activities:

1. Create an Ice property set
2. Load and parse a property file
3. Initialize a communicator with the given configuration properties
4. Obtain a proxy for the remote Ice object
5. Establish a socket connection to the server
6. Send a request message and wait for the reply
7. Destroy the communicator, which closes the socket connection

Of primary concern are the activities that involve system calls, such as opening and reading files, creating and using sockets, and so on. The overhead incurred by these calls may not matter if the script is only executed infrequently, but for an application with high request rates it is necessary to minimize this overhead:

- A [pre-configured property set](#) eliminates the need to parse a property file in each request.
- [Timeouts](#) prevent a script from blocking indefinitely in case Ice encounters delays while performing socket operations.
- [Registering a communicator](#) avoids the need to create and destroy a communicator in every request.
- Be aware of the number of "round trips" (request-reply pairs) your script makes. For example, the script above uses `checkedCast` to verify that the remote Ice object supports the desired Slice interface. However, calling `checkedCast` causes the Ice run time to send a request to the server and await its reply, therefore this script is actually making two remote invocations. It is unnecessary to perform a checked cast if it is safe for the client to assume that the Ice object supports the correct interface, in which case using an `uncheckedCast` instead avoids the extra round trip.

Managing Property Sets in PHP

A PHP application can manually construct a [property set](#) for configuring its communicator. The Ice extension also provides a PHP-specific property set API that helps to minimize the overhead associated with initializing a communicator, allowing you to configure a default property

set along with an unlimited number of named property sets (or *profiles*). You can populate a property set using a configuration file, command-line options, or both. Property sets are initialized using the normal Ice semantics: command-line options override any settings from a configuration file.

The Ice extension creates these property sets during web server startup, which means any subsequent changes you might make to the configuration have no effect until the web server is restarted. Also keep in mind that specifying a relative path name for a configuration file usually means the path name is evaluated relative to the web server's working directory.

Default Property Set in PHP

The INI directives `ice.config` and `ice.options` specify the configuration file and the command-line options for the default property set, respectively. These directives must appear in PHP's configuration file, which is usually named `php.ini`:

```
; Snippet from php.ini on Linux
extension=IcePHP.so
ice.config=/opt/MyApp/default.cfg
ice.options="--Ice.Override.Timeout=2000"
```

Profiles in PHP

Profiles are useful when several unrelated applications execute in the same web server, or when a script needs to choose among multiple configurations. To configure your profiles, add an `ice.profiles` directive to PHP's configuration file. The value of this directive is a file containing profile definitions:

```
; Snippet from php.ini on Linux
ice.profiles=/opt/MyApp/profiles
```

The profile definition file uses INI syntax:

```
[Production]
config=/opt/MyApp/prod.cfg
options="..."

[Debug]
config=/opt/MyApp/debug.cfg
options="--Ice.Trace.Network=3 ..."
```

The name of each profile is enclosed in square brackets. The configuration file and command-line options for each profile are defined using the `config` and `options` entries, respectively.

Using Property Sets in PHP

The `Ice_getProperties` function allows a script to obtain a copy of a property set. When called without an argument, or with an empty string, the function returns the default property set. Otherwise, the function expects the name of a configured profile and returns the property set associated with that profile. The return value is an instance of `Ice_Properties`, or `null` if no matching profile was found.

Note that the Ice extension always creates the default property set, which is empty if the `ice.config` and `ice.options` directives are not defined. Also note that changes a script might make to a property set returned by this function have no effect on other requests because the script is modifying a *copy* of the original property set.

Now we can modify our script to use `Ice_getProperties` and avoid the need to load a configuration file in each request:

PHP

```

<?php
require 'Ice.php';
require 'Hello.php';

try
{
    $data = new Ice_InitializationData;
    $data->properties = Ice_getProperties();
    $communicator = Ice_initialize($data);
    $proxy = $communicator->stringToProxy("...");
    $hello = Demo_HelloPrxHelper::checkedCast($proxy);
    $hello->sayHello();
}
catch(Ice_LocalException $ex)
{
    // Deal with exception...
}
?>

```

Security Considerations for Property Sets in PHP

Ice configuration properties may contain sensitive information such as the path name of the private key for an X.509 certificate. If multiple untrusted PHP applications run in the same web server, avoid the use of the default property set and choose sufficiently unique names for your named profiles. The Ice extension does not provide a means for enumerating the names of the configured profiles, therefore a malicious script would have to guess the name of a profile in order to examine its configuration properties.

To prevent a script from using the value of `ice.profiles` to open the profile definition file directly, enable the `ice.hide_profiles` directive to cause the Ice extension to replace the `ice.profiles` setting after it has processed the file. The `ice.hide_profiles` directive is enabled by default.

Timeouts in PHP

All twoway remote invocations made by a PHP script have synchronous semantics: the script does not regain control until Ice receives a reply from the server. As a result, we recommend configuring a suitable `timeout` value for all of your proxies as a defensive measure against network delays.

Registered Communicators in PHP

You can register a communicator to prevent it from being destroyed at the completion of a script. For example, a session-based PHP application can create a communicator for each new session and register it for reuse in subsequent requests of the same session. Reusing a communicator in this way avoids the overhead associated with creating and destroying a communicator in each request. Furthermore, it allows socket connections established by the Ice run time to remain open and available for use in another request.

Limitations of Registered Communicators in PHP

A communicator object is local to the process that created it, which in the case of PHP is usually a web server process. The usefulness of a registered communicator is therefore limited to situations in which an application can ensure that subsequent page requests are handled by the same web server process as the one that originally created the registered communicator. For example, registered communicators would not be appropriate in a typical CGI configuration because the CGI process terminates at the end of each request. A simple (but often

impractical) solution is to configure your web server to use a single persistent process. The topic of configuring a web server to take advantage of registered communicators is outside the scope of this manual.

Using Registered Communicators in PHP

The API for registered communicators consists of three functions:

- `Ice_register($communicator, $name, $expires=0)`
Registers a communicator with the given name. On success, the function returns true. If another communicator is already registered with the same name, the function returns false. The `expires` argument specifies a timeout value in minutes; if `expires` is greater than zero, the Ice extension automatically destroys the communicator if it has not been retrieved (via `Ice_find`) for the specified number of minutes. The default value (zero) means the communicator never expires, in which case the Ice extension only destroys the communicator when the current process terminates.
It is legal to register a communicator with more than one name. In that case, the most recent value of `expires` takes precedence.
- `Ice_unregister($name)`
Removes the registration for a communicator with the given name. Returns true if a match was found or false otherwise. Calling `Ice_unregister` does not cause the communicator to be destroyed; rather, the communicator is destroyed as soon as all pending requests that are currently using the communicator have completed. Destroying a registered communicator explicitly also removes its registration.
- `Ice_find($name)`
Retrieves the communicator associated with the given name. Returns `null` if no match is found.

An application typically uses registered communicators as follows:

PHP

```

<?php
require 'Ice.php';

$communicator = Ice_find('MyCommunicator');
$expires = ...;
if($communicator == null)
{
    $communicator = Ice_initialize(...);
    Ice_register($communicator, 'MyCommunicator', $expires);
}

...
?>

```

Note that communicators consume resources such as threads, sockets, and memory, therefore an application should be designed to minimize the number of communicators it registers. Using a suitable expiration timeout prevents registered communicators from accumulating indefinitely.

A simple application that demonstrates the use of registered communicators can be found in the `Glacier2/hello` subdirectory of the PHP sample programs.

Security Considerations for Registered Communicators in PHP

There are risks associated with allowing untrusted applications to gain access to a registered communicator. For example, if a malicious script obtains a registered communicator that is configured with SSL credentials, the script could potentially make secure invocations as if it were the trusted script.

Registering a communicator with a sufficiently unique name reduces the chance that a malicious script could guess the communicator's

name. For applications that make use of PHP's session facility, the session ID is a reasonable choice for a communicator name. The sample application in `Glacier2/hello` demonstrates this solution.

Lifetime of Object Factories in PHP

PHP reclaims all memory at the end of each request, which means any object factories that a script might have installed in a registered communicator are destroyed when the request completes even if the communicator is not destroyed. As a result, a script must install its object factories in a registered communicator for *every* request, as shown in the example below:

PHP
<pre> <?php require 'Ice.php'; \$communicator = Ice_find('MyCommunicator'); \$expires = ...; if(\$communicator == null) { \$communicator = Ice_initialize(...); Ice_register(\$communicator, 'MyCommunicator', \$expires); } \$communicator->addObjectFactory(new MyFactory, MyClass::ice_staticId()); ... ?> </pre>

The Ice extension invokes the `destroy` method of each factory prior to the completion of a request.

See Also

- [Properties and Configuration](#)
- [Connection Timeouts](#)

Using Slice Checksums in PHP

The Slice compilers can optionally generate [checksums](#) of Slice definitions. For `slice2php`, the `--checksum` option causes the compiler to generate code that adds checksums to the global array `Ice_sliceChecksums`. The checksums are installed automatically when the PHP code is first parsed; no action is required by the application.

In order to verify a server's checksums, a client could simply compare the two array objects using a comparison operator. However, this is not feasible if it is possible that the server might return a superset of the client's checksums. A more general solution is to iterate over the local checksums as demonstrated below:

PHP
<pre> global \$Ice_sliceChecksums; \$serverChecksums = ... foreach(\$Ice_sliceChecksums as \$key => \$value) { if(!isset(\$serverChecksums[\$key])) // No match found for type id! elseif(\$Ice_sliceChecksums[\$key] != \$serverChecksums[\$key]) // Checksum mismatch! } </pre>

In this example, the client first verifies that the server's dictionary contains an entry for each Slice type ID, and then it proceeds to compare the checksums.

See Also

- [Slice Checksums](#)

Example of a File System Client in PHP

This page presents a very simple client to access a server that implements the file system we developed in [Slice for a Simple File System](#). The PHP code shown here hardly differs from the code you would write for an ordinary PHP program. This is one of the biggest advantages of using Ice: accessing a remote object is as easy as accessing an ordinary, local PHP object. This allows you to put your effort where you should, namely, into developing your application logic instead of having to struggle with arcane networking APIs.

We now have seen enough of the client-side PHP mapping to develop a complete client to access our remote file system. For reference, here is the Slice definition once more:

```

Slice
module Filesystem {
    interface Node {
        idempotent string name();
    };

    exception GenericError {
        string reason;
    };

    sequence<string> Lines;

    interface File extends Node {
        idempotent Lines read();
        idempotent void write(Lines text) throws GenericError;
    };

    sequence<Node*> NodeSeq;

    interface Directory extends Node {
        idempotent NodeSeq list();
    };
};

```

To exercise the file system, the client does a recursive listing of the file system, starting at the root directory. For each node in the file system, the client shows the name of the node and whether that node is a file or directory. If the node is a file, the client retrieves the contents of the file and prints them.

The body of the client code looks as follows:

```

PHP
<?php
require 'Ice.php';
require 'Filesystem.php';

// Recursively print the contents of directory "dir"
// in tree fashion. For files, show the contents of
// each file. The "depth" parameter is the current
// nesting level (for indentation).

```

```

function listRecursive($dir, $depth = 0)
{
    $indent = str_repeat("\t", ++$depth);

    $contents = $dir->_list(); // list is a reserved word in PHP

    foreach ($contents as $i) {
        $dir = Filesystem_DirectoryPrxHelper::checkedCast($i);
        $file = Filesystem_FilePrxHelper::uncheckedCast($i);
        echo $indent . $i->name() .
($dir ? " (directory):" : " (file):") . "\n";
        if ($dir) {
            listRecursive($dir, $depth);
        } else {
            $text = $file->read();
            foreach ($text as $j)
                echo $indent . "\t" . $j . "\n";
        }
    }
}

$ic = null;
try
{
    // Create a communicator
    //
    $ic = Ice_initialize();

    // Create a proxy for the root directory
    //
    $obj = $ic->stringToProxy("RootDir:default -p 10000");

    // Down-cast the proxy to a Directory proxy
    //
    $rootDir = Filesystem_DirectoryPrxHelper::checkedCast($obj);

    // Recursively list the contents of the root directory
    //
    echo "Contents of root directory:\n";
    listRecursive($rootDir);
}
catch(Ice_LocalException $ex)
{
    print_r($ex);
}

if($ic)
{
    // Clean up
    //

```

```
try
{
    $ic->destroy();
}
catch(Exception $ex)
{
    print_r($ex);
}
```

```
}
?>
```

The program first defines the `listRecursive` function, which is a helper function to print the contents of the file system, and the main program follows. Let us look at the main program first:

1. The client first creates a proxy to the root directory of the file system. For this example, we assume that the server runs on the local host and listens using the default protocol (TCP/IP) at port 10000. The object identity of the root directory is known to be `RootDir`.
2. The client down-casts the proxy to the `Directory` interface and passes that proxy to `listRecursive`, which prints the contents of the file system.

Most of the work happens in `listRecursive`. The function is passed a proxy to a directory to list, and an indent level. (The indent level increments with each recursive call and allows the code to print the name of each node at an indent level that corresponds to the depth of the tree at that node.) `listRecursive` calls the `list` operation on the directory and iterates over the returned sequence of nodes:

1. The code uses `checkedCast` to narrow the `Node` proxy to a `Directory` proxy, and uses `uncheckedCast` to narrow the `Node` proxy to a `File` proxy. Exactly one of those casts will succeed, so there is no need to call `checkedCast` twice: if the `Node` *is-a* `Directory`, the code uses the proxy returned by `checkedCast`; if `checkedCast` fails, we *know* that the `Node` *is-a* `File` and, therefore, `uncheckedCast` is sufficient to get a `File` proxy. In general, if you know that a down-cast to a specific type will succeed, it is preferable to use `uncheckedCast` instead of `checkedCast` because `uncheckedCast` does not incur any network traffic.
2. The code prints the name of the file or directory and then, depending on which cast succeeded, prints "(directory)" or "(file)" following the name.
3. The code checks the type of the node:
 - If it is a directory, the code recurses, incrementing the indent level.
 - If it is a file, the code calls the `read` operation on the file to retrieve the file contents and then iterates over the returned sequence of lines, printing each line.

Assume that we have a small file system consisting of a two files and a a directory as follows:

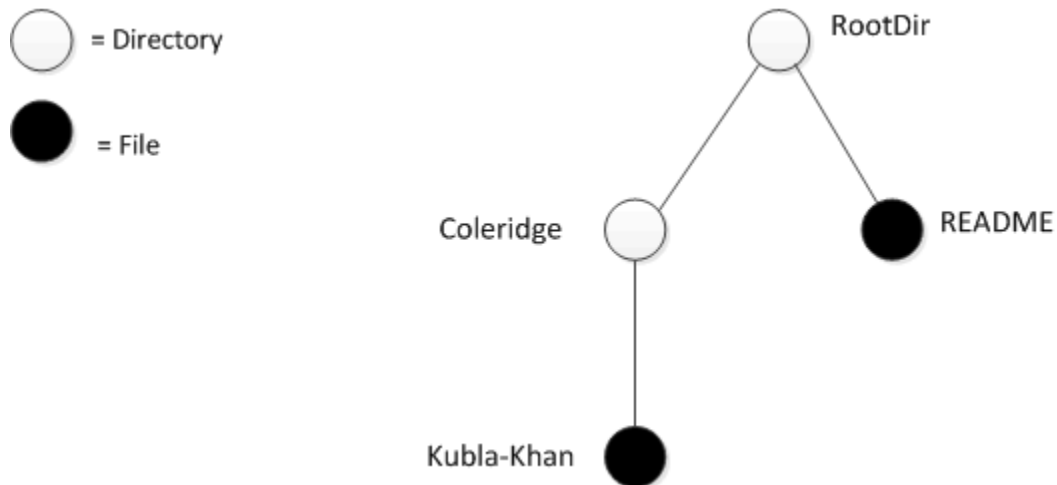

A small file system.

The output produced by the client for this file system is:

```
Contents of root directory:
```

```
  README (file):
```

```
    This file system contains a collection of poetry.
```

```
  Coleridge (directory):
```

```
    Kubla_Khan (file):
```

```
      In Xanadu did Kubla Khan
```

```
      A stately pleasure-dome decree:
```

```
      Where Alph, the sacred river, ran
```

```
      Through caverns measureless to man
```

```
      Down to a sunless sea.
```

Note that, so far, our client is not very sophisticated:

- The protocol and address information are hard-wired into the code.
- The client makes more remote procedure calls than strictly necessary; with minor redesign of the Slice definitions, many of these calls can be avoided.

We will see how to address these shortcomings in our discussions of [IceGrid](#) and [object life cycle](#).

See Also

- [Hello World Application](#)
- [Slice for a Simple File System](#)
- [Object Life Cycle](#)
- [IceGrid](#)

Properties and Configuration

Ice uses a configuration mechanism that allows you to control many aspects of the behavior of your Ice applications at run time, such as the maximum message size, the number of threads, or whether to produce network trace messages. The configuration mechanism is not only useful for configuring Ice, but also for configuring your own applications. The configuration mechanism is simple to use with a minimal API, yet flexible enough to cope with the needs of most applications.

Topics

- [Properties Overview](#)
- [Configuration File Syntax](#)
- [Setting Properties on the Command Line](#)
- [Using Configuration Files](#)
- [Alternate Property Stores](#)
- [Command-Line Parsing and Initialization](#)
- [The Properties Interface](#)
- [Reading Properties](#)
- [Setting Properties](#)
- [Parsing Properties](#)

Properties Overview

Ice and its various subsystems are configured by properties. A property is a name-value pair, for example:

```
Ice.UDP.SndSize=65535
```

In this example, the *property name* is `Ice.UDP.SndSize`, and the *property value* is `65535`.

You can find a complete list of the properties used to configure Ice in the [property reference](#).

Note that Ice reads properties that control the Ice run time and its services (that is, properties that start with one of the reserved prefixes, such as `Ice`, `Glacier2`, etc.) only once on start-up, when you create a communicator. This means that you must set Ice-related properties to their correct values *before* you create a communicator. If you change the value of an Ice-related property after that point, it is likely that the new setting will simply be ignored.

On this page:

- [Property Categories](#)
- [Reserved Prefixes for Properties](#)
- [Property Name Syntax](#)
- [Property Value Syntax](#)
- [Unused Properties](#)

Property Categories

By convention, Ice properties use the following naming scheme:

```
<application>.<category>[.<sub-category>]
```

Note that the sub-category is optional and not used by all Ice properties.

This two- or three-part naming scheme is by convention only — if you use properties to configure your own applications, you can use property names with any number of categories.

Reserved Prefixes for Properties

Ice reserves properties with the following prefixes:

- `Ice`
- `IceBox`
- `IceGrid`
- `IcePatch2`
- `IceSSL`
- `IceStorm`
- `Freeze`
- `Glacier2`

You cannot use a property beginning with one of these prefixes to configure your own application.

Property Name Syntax

A property name consists of any number of characters. For example, the following are valid property names:

```
foo
Foo
foo.bar
foo bar    White space is allowed
foo=bar    Special characters are allowed
.
```

Note that there is no special significance to a period in a property name. (Periods are used to make property names more readable and are not treated specially by the property parser.)

Property names cannot contain leading or trailing white space. (If you create a property name with leading or trailing white space, that white space is silently stripped.)

Property Value Syntax

A property value consists of any number of characters. The following are examples of property values:

```
65535
yes
This is a = property value.
../../config
```

Unused Properties

During the destruction of a communicator, the Ice run time can optionally emit a warning for properties that were set but never read. To enable this warning, set `Ice.Warn.UnusedProperties` to a non-zero value. This property is useful for detecting mis-spelled properties, such as `Filesystem.MaxFileSize`. By default, the warning is disabled.

See Also

- [Property Reference](#)

Configuration File Syntax

This page describes the syntax of an Ice configuration file.

On this page:

- [Configuration File Format](#)
- [Special Characters in Configuration Files](#)

Configuration File Format

A configuration file contains any number of name-value pairs, with each pair on a separate line. Empty lines and lines consisting entirely of white space characters are ignored. The # character introduces a comment that extends to the end of the current line.

Configuration files can be ASCII text files or use the UTF-8 character encoding with a byte order marker (BOM) at the beginning of the file.

Here is a simple configuration file:

```
# Example config file for Ice

Ice.MessageSizeMax = 2048      # Largest message size is 2MB
Ice.Trace.Network=3           # Highest level of tracing for network
Ice.Trace.Protocol=           # Disable protocol tracing
```

Leading and trailing white space is always ignored for property *names* (whether the white space is escaped or not), but white space within property *values* is preserved.

For property values, you can preserve leading and trailing white space by escaping the white space with a backslash. For example:

```
# White space example

My.Prop = a property          # Value is "a property"
My.Prop = a  property        # Value is "a  property"
My.Prop = \ \ a  property\ \  # Value is " a  property "
My.Prop = \ \ a \ \ property\ \ # Value is " a  property "
My.Prop = a  \ \ property     # Value is "a \ property"
```

This example shows that leading and trailing white space for property values is ignored unless escaped with a backslash whereas, white space that is surrounded by non-white space characters is preserved exactly, whether it is escaped or not. As usual, you can insert a literal backslash into a property value by using a double backslash.

If you set the same property more than once, the last setting prevails and overrides any previous setting. Note that assigning nothing to a property clears that property (that is, sets it to the empty string).

A property that contains the empty string (such as `Ice.Trace.Protocol` in the preceding example) is indistinguishable from a property that is not mentioned at all. This is because the API for [retrieving a property value](#) returns the empty string for non-existent properties.

Property values can include characters from non-English alphabets. The Ice run time expects the configuration file to use UTF-8 encoding for such characters. (With C++, you can specify a [string converter](#) when you read the file.)

Special Characters in Configuration Files

The characters = and # have special meaning in a configuration file:

- = marks the end of the property name and the beginning of the property value

- # starts a comment that extends to the end of the line

These characters must be escaped when they appear in a property name. Consider the following examples:

```
foo\=bar=1      # Name is "foo=bar", value is "1"
foo\#bar  = 2   # Name is "foo#bar", value is "2"
foo bar  =3     # Name is "foo bar", value is "3"
```

In a property value, a # character must be escaped to prevent it from starting a comment, but an = character does not require an escape. Consider these examples:

```
A=1           # Name is "A", value is "1"
B= 2 3 4      # Name is "B", value is "2 3 4"
C=5=\#6 # 7   # Name is "C", value is "5=#6"
```

Note that, two successive backslashes in a property value become a single backslash. To get two consecutive backslashes, you must escape each one with another backslash:

```
Aserver=\\\\server\dir   # Value is "\\server\dir"
Bserver=\\server\\dir    # Value is "\server\dir"
```

The preceding example also illustrates that, if a backslash is not followed by a backslash, #, or =, the backslash and the character following it are both preserved.

See Also

- [Using Configuration Files](#)
- [Reading Properties](#)
- [Setting Properties on the Command Line](#)
- [Communicator Initialization](#)
- [C++ Strings and Character Encoding](#)

Setting Properties on the Command Line

In addition to setting properties in a [configuration file](#), you can also set properties on the command line, for example:

```
$ ./server --Ice.UDP.SndSize=65535 --IceSSL.Trace.Security=2
```

Any command line option that begins with `--` and is followed by one of the [reserved prefixes](#) is read and converted to a property setting when you create a communicator. Property settings on the command line override settings in a configuration file. If you set the same property more than once on the same command line, the last setting overrides any previous ones.

For convenience, any property not explicitly set to a value is set to the value 1. For example,

```
$ ./server --Ice.Trace.Protocol
```

is equivalent to

```
$ ./server --Ice.Trace.Protocol=1
```

Note that this feature only applies to properties that are set on the command line, but not to properties that are set from a configuration file.

You can also clear a property from the command line as follows:

```
$ ./server --Ice.Trace.Protocol=
```

As for properties set from a configuration file, assigning nothing to a property clears that property.

See Also

- [Properties Overview](#)
- [Using Configuration Files](#)

Using Configuration Files

The ability to configure an application's properties externally provides a great deal of flexibility: you can use any combination of command-line options and configuration files to achieve the desired settings, all without having to modify your application. This page describes two ways of loading property settings from a file.

On this page:

- [Prerequisites for Using Configuration Files](#)
- [The `ICE_CONFIG` Environment Variable](#)
- [The `Ice.Config` Property](#)

Prerequisites for Using Configuration Files

The Ice run time automatically loads a configuration file during the creation of a *property set*, which is an instance of the `Ice::Properties` interface. Every communicator has its own property set from which it derives its configuration. If an application does not supply a property set when it calls `Ice::initialize` (or the equivalent in other language mappings), the Ice run time internally creates a *property set* for the new communicator.

Note however that Ice loads a configuration file automatically only when the application creates a property set using an argument vector. This occurs when the application passes an argument vector to create a property set explicitly, or when the application passes an argument vector to `Ice::initialize`.

Both of the mechanisms described below can also retrieve property settings from [additional sources](#).

The `ICE_CONFIG` Environment Variable

Ice automatically loads the contents of the configuration file named in the `ICE_CONFIG` environment variable (assuming the [prerequisites](#) are met). For example:

```
$ export ICE_CONFIG=/usr/local/filesystem/config
$ ./server
```

This causes the server to read its property settings from the configuration file in `/usr/local/filesystem/config`.

If you use the `ICE_CONFIG` environment variable together with command-line options for other properties, the settings on the command line override the settings in the configuration file. For example:

```
$ export ICE_CONFIG=/usr/local/filesystem/config
$ ./server --Ice.MessageSizeMax=4096
```

This sets the value of the `Ice.MessageSizeMax` property to 4096 regardless of any setting of this property in `/usr/local/filesystem/config`.

You can use multiple configuration files by specifying a list of configuration file names separated by commas. For example:

```
$ export ICE_CONFIG=/usr/local/filesystem/config,./config
$ ./server
```

This causes property settings to be retrieved from `/usr/local/filesystem/config`, followed by any settings in the file `config` in the current directory; settings in `./config` override settings `/usr/local/filesystem/config`.

The Ice.Config Property

The `Ice.Config` property has special meaning to the Ice run time: it determines the path name of a configuration file from which to read property settings. For example:

```
$ ./server --Ice.Config=/usr/local/filesystem/config
```

This causes property settings to be read from the configuration file in `/usr/local/filesystem/config`.

The `--Ice.Config` command-line option overrides any setting of the `ICE_CONFIG` environment variable, that is, if the `ICE_CONFIG` environment variable is set and you also use the `--Ice.Config` command-line option, the configuration file specified by the `ICE_CONFIG` environment variable is ignored.

If you use the `--Ice.Config` command-line option together with settings for other properties, the settings on the command line override the settings in the configuration file. For example:

```
$ ./server --Ice.Config=/usr/local/filesystem/config --Ice.MessageSizeMax=4096
```

This sets the value of the `Ice.MessageSizeMax` property to 4096 regardless of any setting of this property in `/usr/local/filesystem/config`. The placement of the `--Ice.Config` option on the command line has no influence on this precedence. For example, the following command is equivalent to the preceding one:

```
$ ./server --Ice.MessageSizeMax=4096 --Ice.Config=/usr/local/filesystem/config
```

Settings of the `Ice.Config` property inside a configuration file are ignored, that is, you can set `Ice.Config` only on the command line.

If you use the `--Ice.Config` option more than once, only the last setting of the option is used and the preceding ones are ignored. For example:

```
$ ./server --Ice.Config=file1 --Ice.Config=file2
```

This is equivalent to using:

```
$ ./server --Ice.Config=file2
```

You can use multiple configuration files by specifying a list of configuration file names separated by commas. For example:

```
$ ./server --Ice.Config=/usr/local/filesystem/config,./config
```

This causes property settings to be retrieved from `/usr/local/filesystem/config`, followed by any settings in the file `config` in the current directory; settings in `./config` override settings `/usr/local/filesystem/config`.

See Also

- [Alternate Property Stores](#)
- [The Properties Interface](#)

Alternate Property Stores

In addition to regular files, Ice also supports storing property settings in the Windows registry and Java resources.

On this page:

- [Loading Properties from the Windows Registry](#)
- [Loading Properties from Java Resources](#)

Loading Properties from the Windows Registry

You can use the Windows registry to store property settings. Property settings must be stored with a key underneath `HKEY_LOCAL_MACHINE`. To inform the Ice run time of this key, you must set the `Ice.Config` property to the key. For example:

```
$ client --Ice.Config=HKLM\MyCompany\MyApp
```

The Ice run time examines the value of `Ice.Config`; if that value begins with `HKLM`, the remainder of the property is taken to be a key to a number of string values. For the preceding example, the Ice run time looks for the key `HKEY_LOCAL_MACHINE\MyCompany\MyApp`. The string values stored under this key are used to initialize the properties.

The name of each string value is the name of the property (such as `Ice.Trace.Network`). Note that the value must be a string (even if the property setting is numeric). For example, to set `Ice.Trace.Network` to 3, you must store the string "3" as the value, not a binary or `DWORD` value.

String values in the registry can be regular strings (`REG_SZ`) or expandable strings (`REG_EXPAND_SZ`). Expandable strings allow you to include symbolic references to environment variables (such as `%ICE_HOME%`).



Depending on whether you use 32-bit or 64-bit binaries, you must set the registry keys in the corresponding 32-bit or 64-bit registry. See <http://support.microsoft.com/kb/305097> for more information.

Loading Properties from Java Resources

The Ice run time for Java supports the ability to load a configuration file as a class loader resource, which is especially useful for deploying an Ice application in a self-contained JAR file. For example, suppose we define `ICE_CONFIG` as shown below:

```
$ export ICE_CONFIG=app_config
```

During the creation of a property set (which often occurs implicitly when initializing a new communicator), Ice asks the Java run time to search the application's class path for a file named `app_config`. This file might reside in the same JAR file as the application's class files, or in a different JAR file in the class path, or it might be a regular file located in one of the directories in the class path. If Java is unable to locate the configuration file in the class path, Ice attempts to open the file in the local file system.

The class path resource always takes precedence over a regular file. In other words, if a class path resource and a regular file are both present with the same path name, Ice always loads the class path resource in preference to the regular file.

The path name for a class path resource uses a relative Unix-like format such as `subdir/myfile`. Java searches for the resource relative to each JAR file or subdirectory in an application's class path.

See Also

- [Using Configuration Files](#)

Command-Line Parsing and Initialization

On this page:

- [Parsing Command Line Options](#)
- [The `Ice.ProgramName` Property](#)

Parsing Command Line Options

When you initialize the Ice run time by calling `Ice::initialize` (C++/Ruby), `Ice.Util.initialize` (Java/C#), `Ice.initialize` (Python), or `Ice_initialize` (PHP), you can pass an argument vector to the initialization call.

For C++, `Ice::initialize` accepts a C++ *reference* to `argc`:

```
C++
```

```
namespace Ice {
    CommunicatorPtr initialize(int& argc, char* argv[]);
}
```

`Ice::initialize` parses the argument vector and initializes its property settings accordingly. In addition, it removes any arguments from `argv` that are property settings. For example, assume we invoke a server as:

```
$ ./server --myoption --Ice.Config=config -x a --Ice.Trace.Network=3 -y
  opt file
```

Initially, `argc` has the value 9, and `argv` has ten elements: the first nine elements contain the program name and the arguments, and the final element, `argv[argc]`, contains a null pointer (as required by the ISO C++ standard). When `Ice::initialize` returns, `argc` has the value 7 and `argv` contains the following elements:

```
./server
--myoption
-x
a
-y
opt
file
0           # Terminating null pointer
```

This means that you should initialize the Ice run time before you parse the command line for your application-specific arguments. That way, the Ice-related options are stripped from the argument vector for you so you do not need to explicitly skip them. If you use the `Ice::Application` helper class, the `run` member function is passed an argument vector with the Ice-related options already stripped. The same is true for the `runWithSession` member function called by the `Glacier2::Application` helper class.

For Java, `Ice.Util.initialize` is overloaded. The signatures are:

Java

```

package Ice;
public final class Util {

    public static Communicator
    initialize();

    public static Communicator
    initialize(String[] args);

    public static Communicator
    initialize(StringSeqHolder args);

    public static Communicator
    initialize(InitializationData id);

    public static Communicator
    initialize(String[] args, InitializationData id);

    public static Communicator
    initialize(StringSeqHolder args, InitializationData id);

    // ...
}

```

The versions that accept an argument vector of type `String[]` do not strip Ice-related options for you, so, if you use one of these methods, your code must ignore options that start with one of the [preserved prefixes](#). The versions that accept a `StringSeqHolder` behave like the C++ version and strip the Ice-related options from the passed argument vector.

In C#, the argument vector is passed by reference to the `initialize` method, allowing it to strip the Ice-related options:

```

C#
namespace Ice {

    public sealed class Util {

        public static Communicator
        initialize();

        public static Communicator
        initialize(ref string[] args);

        public static Communicator
        initialize(InitializationData id);

        public static Communicator
        initialize(ref string[] args, InitializationData id);

        // ...

    }
}

```

The Python, Ruby, and PHP implementations of `initialize` have the same semantics as C++ and .NET; they expect the argument vector to be passed as a list from which all Ice-related options are removed.

If you use the `Ice.Application` helper class, the `run` method is passed the cleaned-up argument vector. The `Ice.Application` class is described separately for each language mapping.

The `Ice.ProgramName` Property

For C++, Python, and Ruby, `initialize` sets the `Ice.ProgramName` property to the name of the current program (`argv[0]`). In C#, `initialize` sets `Ice.ProgramName` to the value of `System.AppDomain.CurrentDomain.FriendlyName`. Your application code can read this property and use it for activities such as logging diagnostic or trace messages.

Even though `Ice.ProgramName` is initialized for you, you can still override its value from a [configuration file](#) or by setting the property on the command line.

For Java, the program name is not supplied as part of the argument vector — if you want to use the `Ice.ProgramName` property in your application, you must set it before initializing a communicator.

See Also

- [Using Configuration Files](#)
- [Reading Properties](#)
- [Communicator Initialization](#)
- [Glacier2 Helper Classes](#)

The Properties Interface

You can use the same [configuration file](#) and [command-line](#) mechanisms to set application-specific properties. For example, we could introduce a property to control the maximum file size for our file system application:

```
# Configuration file for file system application

Filesystem.MaxFileSize=1024    # Max file size in kB
```

The Ice run time stores the `Filesystem.MaxFileSize` property like any other property and makes it accessible via the `Properties` interface.

To access property values from within your program, you need to acquire the communicator's properties by calling `getProperties`:

```

Slice
module Ice {

    local interface Properties; // Forward declaration

    local interface Communicator {

        Properties getProperties();

        // ...
    };
};

```

The `Properties` interface is shown below:

Slice

```

module Ice {
    local dictionary<string, string> PropertyDict;

    local interface Properties {

        string getProperty(string key);
        string getPropertyWithDefault(string key, string value);
        int getPropertyAsInt(string key);
        int getPropertyAsIntWithDefault(string key, int value);
        PropertyDict getPropertiesForPrefix(string prefix);

        void setProperty(string key, string value);

        StringSeq getCommandLineOptions();
        StringSeq parseCommandLineOptions(string prefix,
StringSeq options);
        StringSeq parseIceCommandLineOptions(StringSeq options);

        void load(string file);

        Properties clone();
    };
};

```

Most of the operations involve [reading properties](#), [setting properties](#), and [parsing properties](#).

The `Properties` interface also provides two utility operations that are useful if you need to work with multiple communicators that use different property sets:

- `clone`
This operation makes a copy of an existing property set. The copy contains exactly the same properties and values as the original.
- `load`
This operation accepts a path name to a configuration file and initializes the property set from that file. If the specified file cannot be read (for example, because it does not exist or the caller does not have read permission), the operation throws a `FileException`. In Java, the given path name can refer to a [class loader resource](#) or a regular file.

See Also

- [Using Configuration Files](#)
- [Reading Properties](#)
- [Setting Properties](#)
- [Parsing Properties](#)
- [Alternate Property Stores](#)

Reading Properties

The `Properties` interface provides the following operations for reading property values:

- `string getProperty(string key)`
This operation returns the value of the specified property. If the property is not set, the operation returns the empty string.
- `string getPropertyWithDefault(string key, string value)`
This operation returns the value of the specified property. If the property is not set, the operation returns the supplied default value.
- `int getPropertyAsInt(string key)`
This operation returns the value of the specified property as an integer. If the property is not set or contains a string that does not parse as an integer, the operation returns zero.
- `int getPropertyAsIntWithDefault(string key, int value)`
This operation returns the value of the specified property as an integer. If the property is not set or contains a string that does not parse as an integer, the operation returns the supplied default value.
- `PropertyDict getPropertiesForPrefix(string prefix)`
This operation returns all properties that begin with the specified prefix as a dictionary of type `PropertyDict`. This operation is useful if you want to extract the properties for a specific subsystem. For example, `getPropertiesForPrefix("Filesystem")` returns all properties that start with the prefix `Filesystem`, such as `Filesystem.MaxFileSize`. You can then use the usual dictionary lookup operations to extract the properties of interest from the returned dictionary.

With these operations, using application-specific properties now becomes the simple matter of initializing a communicator as usual, getting access to the communicator's properties, and examining the desired property value. For example:

```

C++

// ...

Ice::CommunicatorPtr ic;

// ...

ic = Ice::initialize(argc, argv);

// Get the maximum file size.
//
Ice::PropertiesPtr props = ic->getProperties();
Ice::Int maxSize
= props->getPropertyAsIntWithDefault("Filesystem.MaxFileSize", 1024);

// ...
```

Assuming that you have created a configuration file that sets the `Filesystem.MaxFileSize` property (and that you have set the `ICE_CONFIG` variable or the `--Ice.Config` option accordingly), your application will pick up the configured value of the property.

 The technique shown above allows you to obtain application-specific properties from a *configuration file*. If you also want the ability to set application-specific properties on the command line, you will need to [parse command-line options](#) for your prefix. (Calling `initialize` to create a communicator only parses those command line options having a [reserved prefix](#).)

See Also

- [The Properties Interface](#)
- [Using Configuration Files](#)
- [Setting Properties](#)
- [Parsing Properties](#)

Setting Properties

The `setProperty` operation on the `Properties` interface sets a property to the specified value:

Slice
<pre> module Ice { local interface Properties { void setProperty(string key, string value); // ... }; }; </pre>

You can clear a property by setting it to the empty string.

For properties that control the Ice run time and its services (that is, properties that start with one of the [reserved prefixes](#)), this operation is useful only if you call it *before* you call `initialize`. This is because property values are usually read by the Ice run time only once, when you call `initialize`, so the Ice run time does not pay attention to a property value that is changed after you have initialized a communicator. Of course, this begs the question of how you can set a property value and have it also recognized by a communicator.

To permit you to set properties before initializing a communicator, the Ice run time provides an overloaded helper function called `createProperties` that creates a property set. In C++, the function is in the `Ice` namespace:

C++
<pre> namespace Ice { PropertiesPtr createProperties(const StringConverterPtr& = 0); PropertiesPtr createProperties(StringSeq&, const PropertiesPtr& = 0, const StringConverterPtr& = 0); PropertiesPtr createProperties(int&, char*[], const PropertiesPtr& = 0, const StringConverterPtr& = 0); } </pre>

The `StringConverter` parameter allows you to parse properties whose values contain non-ASCII characters and to correctly convert these characters into the native codeset. The converter that is passed to `createProperties` remains attached to the returned property set for the life time of the property set.

The function is overloaded to accept either an `argc/argv` pair or a `StringSeq`, to aid in [parsing properties](#).

In Java, the functions are static methods of the `Util` class inside the `Ice` package:

Java

```

package Ice;

public final class Util
{
    public static Properties
    createProperties();

    public static Properties
    createProperties(StringSeqHolder args);

    public static Properties
    createProperties(StringSeqHolder args, Properties defaults);

    public static Properties
    createProperties(String[] args);

    public static Properties
    createProperties(String[] args, Properties defaults);

    // ...
}

```

In C#, the `Util` class in the `Ice` namespace supplies equivalent methods:

C#

```

namespace Ice {
    public sealed class Util {
        public static Properties createProperties();
        public static Properties createProperties(ref string[] args);
        public static Properties
        createProperties(ref string[] args, Properties defaults);
    }
}

```

The Python and Ruby methods reside in the `Ice` module:

```

def createProperties(args=[], defaults=None)

```

In PHP, use the `Ice_createProperties` method:

PHP

```
function Ice_createProperties(args=array(), defaults=null)
```

As for `initialize`, `createProperties` strips Ice-related command-line options from the passed argument vector. (For Java, only the versions that accept a `StringSeqHolder` do this.)

The functions behave as follows:

- The parameter-less version of `createProperties` simply creates an empty property set. It does *not* check `ICE_CONFIG` for a configuration file to parse.
- The other overloads of `createProperties` accept an argument vector and a default property set. The returned property set contains all the property settings that are passed as the default, plus any property settings in the argument vector. If the argument vector sets a property that is also set in the passed default property set, the setting in the argument vector overrides the default. The overloads that accept an argument vector also look for the `--Ice.Config` option; if the argument vector specifies a configuration file, the configuration file is parsed. The order of precedence of property settings, from lowest to highest, is:
 - Property settings passed in the default parameter
 - Property settings set in the configuration file
 - Property settings in the argument vector.

The overloads that accept an argument vector also look for the setting of the `ICE_CONFIG` environment variable and, if that variable specifies a configuration file, parse that file. (However, an explicit `--Ice.Config` option in the argument vector or the `defaults` parameter overrides any setting of the `ICE_CONFIG` environment variable.)

`createProperties` is useful if you want to ensure that a property is set to a particular value, regardless of any setting of that property in a configuration file or in the argument vector. Here is an example:

C++

```
// Get the initialized property set.
//
Ice::PropertiesPtr props = Ice::createProperties(argc, argv);

// Make sure that network and protocol tracing are off.
//
props->setProperty("Ice.Trace.Network", "0");
props->setProperty("Ice.Trace.Protocol", "0");

// Initialize a communicator with these properties.
//
Ice::InitializationData id;
id.properties = props;
Ice::CommunicatorPtr ic = Ice::initialize(id);

// ...
```

The equivalent Java code looks as follows:

Java

```
Ice.StringSeqHolder argsH = new Ice.StringSeqHolder(args);
Ice.Properties properties = Ice.Util.createProperties(argsH);
properties.setProperty("Ice.Warn.Connections", "0");
properties.setProperty("Ice.Trace.Protocol", "0");
Ice.InitializationData id = new Ice.InitializationData();
id.properties = properties;
communicator = Ice.Util.initialize(id);
```

We first convert the argument array to an initialized `StringSeqHolder`. This is necessary so `createProperties` can strip Ice-specific settings. In that way, we first obtain an initialized property set, then override the settings for the two tracing properties, and then set the properties in the `InitializationData` structure.

The equivalent Python code is shown next:

Python

```
props = Ice.createProperties(sys.argv)
props.setProperty("Ice.Trace.Network", "0")
props.setProperty("Ice.Trace.Protocol", "0")
id = Ice.InitializationData()
id.properties = props
ic = Ice.initialize(id)
```

This is the equivalent code in Ruby:

Ruby

```
props = Ice::createProperties(ARGV)
props.setProperty("Ice.Trace.Network", "0")
props.setProperty("Ice.Trace.Protocol", "0")
id = Ice::InitializationData.new
id.properties = props
ic = Ice::initialize(id)
```

Finally, we present the code in PHP:

PHP

```
$props = Ice_createProperties($args);
$props->setProperty("Ice.Trace.Network", "0");
$props->setProperty("Ice.Trace.Protocol", "0");
$id = new Ice_InitializationData();
$id->properties = $props;
$ic = Ice_initialize($id);
```

See Also

- [The Properties Interface](#)
- [Using Configuration Files](#)
- [Command-Line Parsing and Initialization](#)
- [Reading Properties](#)
- [Parsing Properties](#)
- [Communicator Initialization](#)
- [C++ Strings and Character Encoding](#)

Parsing Properties

The `Properties` interface provides several operations for converting properties to and from command-line options.

On this page:

- [Converting Properties to Command-Line Options](#)
- [Converting Command-Line Options to Properties](#)
- [Converting Reserved Command-Line Options to Properties](#)

Converting Properties to Command-Line Options

The `getCommandLineOptions` operation converts an initialized set of properties into a sequence of equivalent command-line options:

Slice
<pre> module Ice { local interface Properties { StringSeq getCommandLineOptions(); // ... }; }; </pre>

For example, if you have set the `Filesystem.MaxFileSize` property to 1024 and call `getCommandLineOptions`, the setting is returned as the string `--Filesystem.MaxFileSize=1024`. This operation is useful for diagnostic purposes, for example, to dump the setting of all properties to a [logging facility](#), or if you want to fork a new process with the same property settings as the current process.

Converting Command-Line Options to Properties

The `parseCommandLineOptions` operation examines the passed argument vector for command-line options that have the specified prefix:

Slice
<pre> module Ice { local interface Properties { StringSeq parseCommandLineOptions(string prefix, StringSeq options); // ... }; }; </pre>

All options having the form `--prefix.Key=Value` are converted to property settings (that is, they initialize the corresponding properties). The operation returns an argument vector containing the options that did not match the prefix.

The value for `prefix` has an implicit trailing period if one is not present. For example, when calling `parseCommandLineOptions` with a prefix value of `"File"`, the option `--File.Owner=root` would match but the option `--Filesystem.MaxFileSize=1024` would not

match.

The operation parses command-line options using the same [syntax rules](#) as for properties in a configuration file. However, the user's command shell can cause differences in parsing behavior. Suppose we define the following property in a configuration file:

```
MyApp.Home=C:\Program Files\MyApp
```

The presence of whitespace in the property definition is not an issue in a configuration file but can be an issue on the command line, where the equivalent option is `--MyApp.Home=C:\Program Files\MyApp`. If the user is not careful, the program may receive this as two separate options: `--MyApp.Home=C:\Program` and `Files\MyApp`. In the end, it is the user's responsibility to ensure that the property's complete key and value are contained within a single command-line option.

Because `parseCommandLineOptions` expects a sequence of strings, but C++ programs are used to dealing with `argc` and `argv`, Ice provides two utility functions that convert an `argc/argv` vector into a sequence of strings and vice-versa:

```
C++
```

```
namespace Ice {

    StringSeq argsToStringSeq(int argc, char* argv[]);

    void stringSeqToArgs(const StringSeq& args,
        int& argc, char* argv[]);

}
```

You need to use `parseCommandLineOptions` (and the utility functions) if you want to permit application-specific properties to be set from the command line. For example, to allow the `--Filesystem.MaxFileSize` option to be used on the command line, we need to initialize our program as follows:

C++

```

int
main(int argc, char* argv[])
{
    // Create an empty property set.
    //
    Ice::PropertiesPtr props = Ice::createProperties();

    // Convert argc/argv to a string sequence.
    //
    Ice::StringSeq args = Ice::argsToStringSeq(argc, argv);

    // Strip out all options beginning with --Filesystem.
    //
    args = props->parseCommandLineOptions("Filesystem", args);

    // args now contains only those options that were not
    // stripped. Any options beginning with --Filesystem have
    // been converted to properties.

    // Convert remaining arguments back to argc/argv vector.
    //
    Ice::stringSeqToArgs(args, argc, argv);

    // Initialize communicator.
    //
    Ice::InitializationData id;
    id.properties = props;
    Ice::CommunicatorPtr ic = Ice::initialize(argc, argv, id);

    // At this point, argc/argv only contain options that
    // set neither an Ice property nor a Filesystem property,
    // so we can parse these options as usual.
    //
    // ...
}

```

Using this code, any options beginning with `--Filesystem` are converted to properties and are available via the property lookup operations as usual. The call to `initialize` then removes any Ice-specific command-line options so, once the communicator is created, `argc/argv` only contains options and arguments that are not related to setting either a filesystem or an Ice property.

An easier way to achieve the same thing is to use the overload of `Ice::initialize` that accepts a string sequence, instead of an `argc/argv` pair:

C++

```

int
main(int argc, char* argv[])
{
    // Create an empty property set.
    //
    Ice::PropertiesPtr props = Ice::createProperties();

    // Convert argc/argv to a string sequence.
    //
    Ice::StringSeq args = Ice::argsToStringSeq(argc, argv);

    // Strip out all options beginning with --Filesystem.
    //
    args = props->parseCommandLineOptions("Filesystem", args);

    // args now contains only those options that were not
    // stripped. Any options beginning with --Filesystem have
    // been converted to properties.

    // Initialize communicator.
    //
    Ice::InitializationData id;
    id.properties = props;
    Ice::CommunicatorPtr ic = Ice::initialize(args, id);

    // At this point, args only contains options that
    // set neither an Ice property nor a Filesystem property,
    // so we can parse these options as usual.
    //
    // ...
}

```

This version of the code avoids having to convert the string sequence back into an `argc/argv` pair before calling `Ice::initialize`.

Converting Reserved Command-Line Options to Properties

The `parseIceCommandLineOptions` operation behaves like `parseCommandLineOptions`, but removes the reserved Ice-specific options from the argument vector:

Slice

```
module Ice {
  local interface Properties {

    StringSeq parseIceCommandLineOptions(StringSeq options);

    // ...
  };
};
```

This operation is also used internally by the Ice run time to parse Ice-specific options in `initialize`.

See Also

- [Properties Overview](#)
- [The Properties Interface](#)
- [Reading Properties](#)
- [Setting Properties](#)
- [Command-Line Parsing and Initialization](#)
- [Logger Facility](#)

Threads and Concurrency with C++

Threading and concurrency control vary widely with different operating systems. To make threads programming easier and portable, Ice provides a simple thread abstraction layer that allows you to write portable source code regardless of the underlying platform.

This section looks at the threading and concurrency control mechanisms in Ice for C++. It explains the threading abstractions provided by Ice: mutexes, monitors, and threads. Using these APIs allows you to make your code thread safe and to create threads of your own without having to use non-portable APIs that differ in syntax or semantics across different platforms: Ice not only provides a portable API but also guarantees that the semantics of the various functions are the same across different platforms. This makes it easier to create thread-safe applications and lets you move your code between platforms with simple recompilation.



This section assumes you are familiar with light-weight threads and concurrency control. See [\[1\]](#) for an excellent treatment of programming with threads. Also see [The Ice Threading Model](#), which provides a language-neutral introduction to the Ice threading model.

Library Overview

The Ice threading library provides the following thread-related abstractions:

- mutexes
- recursive mutexes
- monitors
- a thread abstraction that allows you to create, control, and destroy threads

The synchronization primitives permit you to implement concurrency control at different levels of granularity. In addition, the thread abstraction allows you to, for example, create a separate thread that can respond to GUI or other asynchronous events. All of the threading APIs are part of the `IceUtil` namespace.

Topics

- [The C++ Mutex Class](#)
- [The C++ RecMutex Class](#)
- [The C++ Monitor Class](#)
- [The C++ Cond Class](#)
- [The C++ Thread Classes](#)
- [Priority Inversion in C++](#)
- [Portable Signal Handling in C++](#)

References

1. Butenhof, D. 1996. [Programming with POSIX Threads](#). Reading, MA: Addison-Wesley.

The C++ Mutex Class

This page describes how to use mutexes — one of the available synchronization primitives.

On this page:

- [Mutex Member Functions](#)
- [Adding Thread Safety to the File System Application in C++](#)
- [Guaranteed Unlocking of Mutexes in C++](#)

Mutex Member Functions

The class `IceUtil::Mutex` (defined in `IceUtil/Mutex.h`) provides a simple non-recursive mutual exclusion mechanism:

```

C++

namespace IceUtil {
    enum MutexProtocol { PrioInherit, PrioNone };

    class Mutex {
    public:
        Mutex();
        Mutex(MutexProtocol p);
        ~Mutex();

        void lock() const;
        bool tryLock() const;
        void unlock() const;

        typedef LockT<Mutex> Lock;
        typedef TryLockT<Mutex> TryLock;
    };
}
```

The member functions of this class work as follows:

- `Mutex()`
`Mutex(MutexProtocol p)`
 You can optionally specify a mutex protocol when you construct a mutex. The mutex protocol controls how the mutex behaves with respect to [thread priorities](#). Default-constructed mutexes use a system-wide default.
- `lock`
 The `lock` function attempts to acquire the mutex. If the mutex is already locked, it suspends the calling thread until the mutex becomes available. The call returns once the calling thread has acquired the mutex.
- `tryLock`
 The `tryLock` function attempts to acquire the mutex. If the mutex is available, the call returns true with the mutex locked. Otherwise, if the mutex is locked by another thread, the call returns false.
- `unlock`
 The `unlock` function unlocks the mutex.

Note that `IceUtil::Mutex` is a non-recursive mutex implementation. This means that you must adhere to the following rules:

- Do not call `lock` on the same mutex more than once from a thread. The mutex is not recursive so, if the owner of a mutex attempts to lock it a second time, the behavior is undefined.

- Do not call `unlock` on a mutex unless the calling thread holds the lock. Calling `unlock` on a mutex that is not currently held by any thread, or calling `unlock` on a mutex that is held by a different thread, results in undefined behavior.

Use the `IceUtil::RecMutex` class if you need recursive semantics.

Adding Thread Safety to the File System Application in C++

Recall that the implementation of the `read` and `write` operations for our `file system server` is not thread safe:

```

C++



```

Filesystem::Lines
Filesystem::FileI::read(const Ice::Current&) const
{
 return _lines; // Not thread safe!
}

void
Filesystem::FileI::write(const Filesystem::Lines& text,
 const Ice::Current&)
{
 _lines = text; // Not thread safe!
}

```

```

The problem here is that, if we receive concurrent invocations of `read` and `write`, one thread will be assigning to the `_lines` vector while another thread is reading that same vector. The outcome of such concurrent data access is undefined; to avoid the problem, we need to serialize access to the `_lines` member with a mutex. We can make the mutex a data member of the `FileI` class and lock and unlock it in the `read` and `write` operations:

C++

```

#include <IceUtil/Mutex.h>
// ...

namespace Filesystem {
    // ...

    class FileI : virtual public File,
                  virtual public Filesystem::NodeI {
    public:
        // As before...
    private:
        Lines _lines;
        IceUtil::Mutex _fileMutex;
    };
    // ...
}

Filesystem::Lines
Filesystem::FileI::read(const Ice::Current&) const
{
    _fileMutex.lock();
    Lines l = _lines;
    _fileMutex.unlock();
    return l;
}

void
Filesystem::FileI::write(const Filesystem::Lines& text,
const Ice::Current&)
{
    _fileMutex.lock();
    _lines = text;
    _fileMutex.unlock();
}

```

The `FileI` class here is identical to the original implementation, except that we have added the `_fileMutex` data member. The `read` and `write` operations lock and unlock the mutex to ensure that only one thread can read or write the file at a time. Note that, by using a separate mutex for each `FileI` instance, it is still possible for multiple threads to concurrently read or write files, as long as they each access a *different* file. Only concurrent accesses to the *same* file are serialized.

The implementation of `read` is somewhat awkward here: we must make a local copy of the file contents while we are holding the lock and return that copy. Doing so is necessary because we must unlock the mutex before we can return from the function. However, as we will see in the next section, the copy can be avoided by using a helper class that unlocks the mutex automatically when the function returns.

Guaranteed Unlocking of Mutexes in C++

Using the raw `lock` and `unlock` operations on mutexes has an inherent problem: if you forget to unlock a mutex, your program will deadlock. Forgetting to unlock a mutex is easier than you might suspect, for example:

C++

```

Filesystem::Lines
Filesystem::File::read(const Ice::Current&) const
{
    _fileMutex.lock();           // Lock the mutex
    Lines l = readFileContents(); // Read from database
    _fileMutex.unlock();        // Unlock the mutex
    return l;
}

```

Assume that we are keeping the contents of the file on secondary storage, such as a database, and that the `readFileContents` function accesses the file. The code is almost identical to the previous example but now contains a latent bug: if `readFileContents` throws an exception, the `read` function terminates without ever unlocking the mutex. In other words, this implementation of `read` is not exception-safe.

The same problem can easily arise if you have a larger function with multiple return paths. For example:

C++

```

void
SomeClass::someFunction(/* params here... */)
{
    _mutex.lock();           // Lock a mutex

    // Lots of complex code here...

    if (someCondition) {
        // More complex code here...
        return;             // Oops!!!
    }

    // More code here...

    _mutex.unlock();        // Unlock the mutex
}

```

In this example, the early return from the middle of the function leaves the mutex locked. Even though this example makes the problem quite obvious, in large and complex pieces of code, both exceptions and early returns can cause hard-to-track deadlock problems. To avoid this, the `Mutex` class contains two type definitions for helper classes, called `Lock` and `TryLock`:

C++

```

namespace IceUtil {

    class Mutex {
        // ...

        typedef LockT<Mutex> Lock;
        typedef TryLockT<Mutex> TryLock;
    };
}

```

`LockT` and `TryLockT` are simple templates that primarily consist of a constructor and a destructor; the `LockT` constructor calls `lock` on its argument, and the `TryLockT` constructor calls `tryLock` on its argument. The destructors call `unlock` if the mutex is locked when the template goes out of scope. By instantiating a local variable of type `Lock` or `TryLock`, we can avoid the deadlock problem entirely:

C++

```

void
SomeClass::someFunction(/* params here... */)
{
    IceUtil::Mutex::Lock lock(_mutex); // Lock a mutex

    // Lots of complex code here...

    if (someCondition) {
        // More complex code here...
        return; // No problem
    }

    // More code here...
} // Destructor of lock unlocks the mutex

```

 This is an example of the *RAII (Resource Acquisition Is Initialization)* idiom [1].

On entry to `someFunction`, we instantiate a local variable `lock`, of type `IceUtil::Mutex::Lock`. The constructor of `lock` calls `lock` on the mutex so the remainder of the function is inside a critical region. Eventually, `someFunction` returns, either via an ordinary `return` (in the middle of the function or at the end) or because an exception was thrown somewhere in the function body. Regardless of how the function terminates, the C++ run time unwinds the stack and calls the destructor of `lock`, which unlocks the mutex, so we cannot get trapped by the deadlock problem we had previously.

Both the `Lock` and `TryLock` templates have a few member functions:

- `void acquire() const`
This function attempts to acquire the lock and blocks the calling thread until the lock becomes available. If the caller calls `acquire` on a mutex it has locked previously, the function throws `ThreadLockedException`.
- `bool tryAcquire() const`

This function attempts to acquire the mutex. If the mutex can be acquired, it returns true with the mutex locked; if the mutex cannot be acquired, it returns false. If the caller calls `tryAcquire` on a mutex it has locked previously, the function throws `ThreadLockedException`.

- `void release() const`

This function releases a previously locked mutex. If the caller calls `release` on a mutex it has unlocked previously, the function throws `ThreadLockedException`.

- `bool acquired() const`

This function returns true if the caller has locked the mutex previously, otherwise it returns false. If you use the `TryLock` template, you must call `acquired` after instantiating the template to test whether the lock actually was acquired.

These functions are useful if you want to use the `Lock` and `TryLock` templates for guaranteed unlocking, but need to temporarily release the lock:

C++

```

{
    IceUtil::Mutex::TryLock m(someMutex);

    if (m.acquired())
    {
        // Got the lock, do processing here...

        if (release_condition) {
            m.release();
        }

        // Mutex is now unlocked, someone else can lock it.
        // ...

        m.acquire(); // Block until mutex becomes available.

        // ...

        if (release_condition) {
            m.release();
        }

        // Mutex is now unlocked, someone else can lock it.

        // ...

        // Spin on the mutex until it becomes available.
        while (!m.tryLock()) {
            // Do some other processing here...
        }

        // Mutex locked again at this point.

        // ...
    }

} // Close scope, m is unlocked by its destructor.

```

**Tip**

You should make it a habit to always use the `Lock` and `TryLock` helpers instead of calling `lock` and `unlock` directly. Doing so results in code that is easier to understand and maintain.

Using the `Lock` helper, we can rewrite the implementation of our `read` and `write` operations as follows:

C++

```

Filesystem::Lines
Filesystem::FileI::read(const Ice::Current&) const
{
    IceUtil::Mutex::Lock lock(_fileMutex);
    return _lines;
}

void
Filesystem::FileI::write(const Filesystem::Lines& text,
const Ice::Current&)
{
    IceUtil::Mutex::Lock lock(_fileMutex);
    _lines = text;
}

```

Note that this also eliminates the need to make a copy of the `_lines` data member: the return value is initialized under protection of the mutex and cannot be modified by another thread once the destructor of `lock` unlocks the mutex.

See Also

- [Example of a File System Server in C++](#)
- [Priority Inversion in C++](#)
- [The C++ RecMutex Class](#)

References

1. Stroustrup, B. 1997. *The C++ Programming Language*. Reading, MA: Addison-Wesley.

The C++ RecMutex Class

A [non-recursive mutex](#) cannot be locked more than once, even by the thread that holds the lock. This frequently becomes a problem if a program contains a number of functions, each of which must acquire a mutex, and you want to call one function as part of the implementation of another function:

C++
<pre> IceUtil::Mutex _mutex; void f1() { IceUtil::Mutex::Lock lock(_mutex); // ... } void f2() { IceUtil::Mutex::Lock lock(_mutex); // Some code here... // Call f1 as a helper function f1(); // Deadlock! // More code here... } </pre>

`f1` and `f2` each correctly lock the mutex before manipulating data but, as part of its implementation, `f2` calls `f1`. At that point, the program deadlocks because `f2` already holds the lock that `f1` is trying to acquire. For this simple example, the problem is obvious. However, in complex systems with many functions that acquire and release locks, it can get very difficult to track down this kind of situation: the locking conventions are not manifest anywhere but in the source code and each caller must know which locks to acquire (or not to acquire) before calling a function. The resulting complexity can quickly get out of hand.

Ice provides a recursive mutex class `RecMutex` (defined in `IceUtil/RecMutex.h`) that avoids this problem:

C++

```

namespace IceUtil {

    class RecMutex {
    public:
        RecMutex();
        RecMutex(MutexProtocol p);
        ~RecMutex();

        void lock() const;
        bool tryLock() const;
        void unlock() const;

        typedef LockT<RecMutex> Lock;
        typedef TryLockT<RecMutex> TryLock;
    };
}

```

Note that the signatures of the operations are the same as for `IceUtil::Mutex`. However, `RecMutex` implements a recursive mutex:

- `RecMutex()`
`RecMutex(MutexProtocol p)`
 You can optionally specify a mutex protocol when you construct a mutex. The mutex protocol controls how the mutex behaves with respect to [thread priorities](#). Default-constructed mutexes use a system-wide default.
- `lock`
 The `lock` function attempts to acquire the mutex. If the mutex is already locked by another thread, it suspends the calling thread until the mutex becomes available. If the mutex is available or is already locked by the calling thread, the call returns immediately with the mutex locked.
- `tryLock`
 The `tryLock` function works like `lock`, but, instead of blocking the caller, it returns `false` if the mutex is locked by another thread. Otherwise, the return value is `true`.
- `unlock`
 The `unlock` function unlocks the mutex.

As for non-recursive mutexes, you must adhere to a few simple rules for recursive mutexes:

- Do not call `unlock` on a mutex unless the calling thread holds the lock.
- You must call `unlock` as many times as you called `lock` for the mutex to become available to another thread. (Internally, a recursive mutex is implemented with a counter that is initialized to zero. Each call to `lock` increments the counter and each call to `unlock` decrements the counter; the mutex is made available to another thread when the counter returns to zero.)

Using recursive mutexes, the code fragment shown earlier works correctly:

C++

```

#include <IceUtil/RecMutex.h>
// ...

IceUtil::RecMutex _mutex;          // Recursive mutex

void
f1()
{
    IceUtil::RecMutex::Lock lock(_mutex);
    // ...
}

void
f2()
{
    IceUtil::RecMutex::Lock lock(_mutex);
    // Some code here...

    // Call f1 as a helper function
    f1();                               // Fine

    // More code here...
}

```

Note that the type of the mutex is now `RecMutex` instead of `Mutex`, and that we are using the `Lock` type definition provided by the `RecMutex` class, not the one provided by the `Mutex` class.

See Also

- [The C++ Mutex Class](#)
- [Priority Inversion in C++](#)

The C++ Monitor Class

The [recursive](#) and [non-recursive](#) mutex classes implement a simple mutual exclusion mechanism that allows only a single thread to be active in a critical region at a time. In particular, for a thread to enter the critical region, another thread must leave it. This means that, with mutexes, it is impossible to suspend a thread inside a critical region and have that thread wake up again at a later time, for example, when a condition becomes true.

To address this problem, Ice provides a monitor. Briefly, a monitor is a synchronization mechanism that protects a critical region: as for a mutex, only one thread may be active at a time inside the critical region. However, a monitor allows you to suspend a thread inside the critical region; doing so allows another thread to enter the critical region. The second thread can either leave the monitor (thereby unlocking the monitor), or it can suspend itself inside the monitor; either way, the original thread is woken up and continues execution inside the monitor. This extends to any number of threads, so several threads can be suspended inside a monitor.

i The monitors provided by Ice have *Mesa* semantics, so called because they were first implemented by the Mesa programming language [1]. Mesa monitors are provided by a number of languages, including Java and Ada. With Mesa semantics, the signalling thread continues to run and another thread gets to run only once the signalling thread suspends itself or leaves the monitor.

Monitors provide a more flexible mutual exclusion mechanism than mutexes because they allow a thread to check a condition and, if the condition is false, put itself to sleep; the thread is woken up by some other thread that has changed the condition.

On this page:

- [Monitor Member Functions](#)
- [Using Monitors in C++](#)
- [Efficient Notification using Monitors in C++](#)

Monitor Member Functions

Ice provides monitors with the `IceUtil::Monitor` class (defined in `IceUtil/Monitor.h`):

C++

```

namespace IceUtil {

    template <class T>
    class Monitor {
    public:
        void lock() const;
        void unlock() const;
        bool tryLock() const;

        void wait() const;
        bool timedWait(const Time&) const;
        void notify();
        void notifyAll();

        typedef LockT<Monitor<T> > Lock;
        typedef TryLockT<Monitor<T> > TryLock;
    };
}

```

Note that `Monitor` is a template class that requires either `Mutex` or `RecMutex` as its template parameter. (Instantiating a `Monitor` with a `RecMutex` makes the monitor recursive.)

The member functions behave as follows:

- `lock`
This function attempts to lock the monitor. If the monitor is currently locked by another thread, the calling thread is suspended until the monitor becomes available. The call returns with the monitor locked.
- `tryLock`
This function attempts to lock a monitor. If the monitor is available, the call returns true with the monitor locked. If the monitor is locked by another thread, the call returns false.
- `unlock`
This function unlocks a monitor. If other threads are waiting to enter the monitor (are blocked inside a call to `lock`), one of the threads is woken up and locks the monitor.
- `wait`
This function suspends the calling thread and, at the same time, releases the lock on the monitor. A thread suspended inside a call to `wait` can be woken up by another thread that calls `notify` or `notifyAll`. When the call returns, the suspended thread resumes execution with the monitor locked.
- `timedWait`
This function suspends the calling thread for up to the specified timeout. If another thread calls `notify` or `notifyAll` and wakes up the suspended thread before the timeout expires, the call returns true and the suspended thread resumes execution with the monitor locked. Otherwise, if the timeout expires, the function returns false. Wait intervals are represented by instances of the `Time` class.
- `notify`
This function wakes up a single thread that is currently suspended in a call to `wait` or `timedWait`. If no thread is suspended in a call to `wait` or `timedWait` at the time `notify` is called, the notification is lost (that is, calls to `notify` are *not* remembered if there is no thread to be woken up). Note that notifying does not run another thread immediately. Another thread gets to run only once the notifying thread either calls `wait` or `timedWait` or unlocks the monitor (Mesa semantics).
- `notifyAll`
This function wakes up all threads that are currently suspended in a call to `wait` or `timedWait`. As for `notify`, calls to `notifyAll` are lost if no threads are suspended at the time. Also as for `notify`, `notifyAll` causes other threads to run only once the notifying thread has either called `wait` or `timedWait` or unlocked the monitor (Mesa semantics).

You must adhere to a few rules for monitors to work correctly:

- Do not call `unlock` unless you hold the lock. If you instantiate a monitor with a recursive mutex, you get recursive semantics, that is, you must call `unlock` as many times as you have called `lock` (or `tryLock`) for the monitor to become available.
- Do not call `wait` or `timedWait` unless you hold the lock.
- Do not call `notify` or `notifyAll` unless you hold the lock.
- When returning from a `wait` call, you *must* re-test the condition before proceeding (as shown below).

Using Monitors in C++

To illustrate how to use a monitor, consider a simple unbounded queue of items. A number of producer threads add items to the queue, and a number of consumer threads remove items from the queue. If the queue becomes empty, consumers must wait until a producer puts a new item on the queue. The queue itself is a critical region, that is, we cannot allow a producer to put an item on the queue while a consumer is removing an item. Here is a very simple implementation of a such a queue:

C++

```
template<class T> class Queue {
public:
    void put(const T& item) {
        _q.push_back(item);
    }

    T get() {
        T item = _q.front();
        _q.pop_front();
        return item;
    }

private:
    list<T> _q;
};
```

As you can see, producers call the `put` method to enqueue an item, and consumers call the `get` method to dequeue an item. Obviously, this implementation of the queue is not thread-safe and there is nothing to stop a consumer from attempting to dequeue an item from an empty queue.

Here is a version of the queue that uses a monitor to suspend a consumer if the queue is empty:

C++

```

#include <IceUtil/Monitor.h>

template<class T> class Queue
: public IceUtil::Monitor<IceUtil::Mutex> {
public:
    void put(const T& item) {
        IceUtil::Monitor<IceUtil::Mutex>::Lock lock(*this);
        _q.push_back(item);
        notify();
    }

    T get() {
        IceUtil::Monitor<IceUtil::Mutex>::Lock lock(*this);
        while (_q.size() == 0)
            wait();
        T item = _q.front();
        _q.pop_front();
        return item;
    }

private:
    list<T> _q;
};

```

Note that the `Queue` class now inherits from `IceUtil::Monitor<IceUtil::Mutex>`, that is, `Queue` *is-a* monitor.

Both the `put` and `get` methods lock the monitor when they are called. As for mutexes, instead of calling `lock` and `unlock` directly, we are using the `Lock` helper which automatically locks the monitor when it is instantiated and unlocks the monitor again when it is destroyed.

The `put` method first locks the monitor and then, now being in sole possession of the critical region, enqueues an item. Before returning (thereby unlocking the monitor), `put` calls `notify`. The call to `notify` will wake up any consumer thread that may be asleep in a `wait` call to inform the consumer that an item is available.

The `get` method also locks the monitor and then, before attempting to dequeue an item, tests whether the queue is empty. If so, the consumer calls `wait`. This suspends the consumer inside the `wait` call and unlocks the monitor, so a producer can enter the monitor to enqueue an item. Once that happens, the producer calls `notify`, which causes the consumer's `wait` call to complete, with the monitor again locked for the consumer. The consumer now dequeues an item and returns (thereby unlocking the monitor).

For this machinery to work correctly, the implementation of `get` does two things:

- `get` tests whether the queue is empty *after* acquiring the lock.
- `get` re-tests the condition in a loop around the call to `wait`; if the queue is still empty after `wait` returns, the `wait` call is re-entered.

You *must* always write your code to follow the same pattern:

- *Never* test a condition unless you hold the lock.
- *Always* re-test the condition in a loop around `wait`. If the test still shows the wrong outcome, call `wait` again.

Not adhering to these conditions will eventually result in a thread accessing shared data when it is not in its expected state, for the following reasons:

1. If you test a condition without holding the lock, there is nothing to prevent another thread from entering the monitor and changing its

state before you can acquire the lock. This means that, by the time you get around to locking the monitor, the state of the monitor may no longer be in agreement with the result of the test.

2. Some thread implementations suffer from a problem known as *spurious wake-up*: occasionally, more than one thread may wake up in response to a call to `notify`, or a thread may wake up without any call to `notify` at all. As a result, each thread that returns from a call to `wait` must re-test the condition to ensure that the monitor is in its expected state: the fact that `wait` returns does *not* indicate that the condition has changed.

Efficient Notification using Monitors in C++

The previous implementation of our [thread-safe queue](#) unconditionally notifies a waiting reader whenever a writer deposits an item into the queue. If no reader is waiting, the notification is lost and does no harm. However, unless there is only a single reader and writer, many notifications will be sent unnecessarily, causing unwanted overhead.

Here is one way to fix the problem:

```

C++

#include <IceUtil/Monitor.h>

template<class T> class Queue : public IceUtil::Monitor<IceUtil::Mutex>
{
public:
    void put(const T& item) {
        IceUtil::Monitor<IceUtil::Mutex>::Lock lock(*this);
        _q.push_back(item);
        if (_q.size() == 1)
            notify();
    }

    T get() {
        IceUtil::Monitor<IceUtil::Mutex>::Lock lock(*this);
        while (_q.size() == 0)
            wait();
        T item = _q.front();
        _q.pop_front();
        return item;
    }

private:
    list<T> _q;
};
```

The only difference between this code and the implementation shown earlier is that a writer calls `notify` only if the queue length has just changed from empty to non-empty. That way, unnecessary `notify` calls are never made. However, this approach works only for a single reader thread. To see why, consider the following scenario:

1. Assume that the queue currently contains a number of items and that we have five reader threads.
2. The five reader threads continue to call `get` until the queue becomes empty and all five readers are waiting in `get`.
3. The scheduler schedules a writer thread. The writer finds the queue empty, deposits an item, and wakes up a single reader thread.
4. The awakened reader thread dequeues the single item on the queue.
5. The reader calls `get` a second time, finds the queue empty, and goes to sleep again.

The net effect of this is that there is a good chance that only one reader thread will ever be active; the other four reader threads end up being

permanently asleep inside the `get` method.

One way around this problem is call `notifyAll` instead of `notify` once the queue length exceeds a certain amount, for example:

```

C++

#include <IceUtil/Monitor.h>

template<class T> class Queue : public IceUtil::Monitor<IceUtil::Mutex>
{
public:
    void put(const T& item) {
        IceUtil::Monitor<IceUtil::Mutex>::Lock lock(*this);
        _q.push_back(item);
        if (_q.size() >= _wakeupThreshold)
            notifyAll();
    }

    T get() {
        IceUtil::Monitor<IceUtil::Mutex>::Lock lock(*this);
        while (_q.size() == 0)
            wait();
        T item = _q.front();
        _q.pop_front();
        return item;
    }

private:
    list<T> _q;
    const int _wakeupThreshold = 100;
};

```

Here, we have added a private data member `_wakeupThreshold`; a writer wakes up *all* waiting readers once the queue length exceeds the threshold, in the expectation that all the readers will consume items more quickly than they are produced, thereby reducing the queue length below the threshold again.

This approach works, but has drawbacks as well:

- The appropriate value of `_wakeupThreshold` is difficult to determine and sensitive to things such as speed and number of processors and I/O bandwidth.
- If multiple readers are asleep, they are all made runnable by the thread scheduler once a writer calls `notifyAll`. On a multiprocessor machine, this may result in all readers running at once (one per CPU). However, as soon as the readers are made runnable, each of them attempts to reacquire the mutex that protects the monitor before returning from `wait`. Of course, only one of the readers actually succeeds and the remaining readers are suspended again, waiting for the mutex to become available. The net result is a large number of thread context switches as well as repeated and unnecessary locking of the system bus.

A better option than calling `notifyAll` is to wake up waiting readers one at a time. To do this, we keep track of the number of waiting readers and call `notify` only if a reader needs to be woken up:

C++

```

#include <IceUtil/Monitor.h>

template<class T> class Queue
: public IceUtil::Monitor<IceUtil::Mutex> {
public:
    Queue() : _waitingReaders(0) {}

    void put(const T& item) {
        IceUtil::Monitor<IceUtil::Mutex>::Lock lock(*this);
        _q.push_back(item);
        if (_waitingReaders)
            notify();
    }

    T get() {
        IceUtil::Monitor<IceUtil::Mutex>::Lock lock(*this);
        while (_q.size() == 0) {
            try {
                ++_waitingReaders;
                wait();
                --_waitingReaders;
            } catch (...) {
                --_waitingReaders;
                throw;
            }
        }
        T item = _q.front();
        _q.pop_front();
        return item;
    }

private:
    list<T> _q;
    short _waitingReaders;
};

```

This implementation uses a member variable `_waitingReaders` to keep track of the number of readers that are suspended. The constructor initializes the variable to zero and the implementation of `get` increments and decrements the variable around the call to `wait`. Note that these statements are enclosed in a `try-catch` block; this ensures that the count of waiting readers remains accurate even if `wait` throws an exception. Finally, `put` calls `notify` only if there is a waiting reader.

The advantage of this implementation is that it minimizes contention on the monitor mutex: a writer wakes up only a single reader at a time, so we do not end up with multiple readers simultaneously trying to lock the mutex. Moreover, the monitor `notify` implementation signals a waiting thread only *after* it has unlocked the mutex. This means that, when a thread wakes up from its call to `wait` and tries to reacquire the mutex, the mutex is likely to be unlocked. This results in more efficient operation because acquiring an unlocked mutex is typically very efficient, whereas forcefully putting a thread to sleep on a locked mutex is expensive (because it forces a thread context switch).

See Also

- [The C++ Mutex Class](#)
- [The C++ RecMutex Class](#)
- [The C++ Time Class](#)

References

1. Mitchell, J. G., et al. 1979. *Mesa Language Manual*. CSL-793. Palo Alto, CA: Xerox PARC.

The C++ Cond Class

Condition variables are similar to [monitors](#) in that they allow a thread to enter a critical region, test a condition, and sleep inside the critical region while releasing its lock. Another thread then is free to enter the critical region, change the condition, and eventually signal the sleeping thread, which resumes at the point where it went to sleep and with the critical region once again locked.

Note that condition variables provide a subset of the functionality of monitors, so a monitor can always be used instead of a condition variable. However, condition variables are smaller, which may be important if you are seriously constrained with respect to memory.

Condition variables are provided by the `IceUtil::Cond` class. Here is its interface:

```

C++

class Cond : private noncopyable {
public:

    Cond();
    ~Cond();

    void signal();
    void broadcast();

    template<typename Lock>
    void wait(const Lock& lock) const;

    template<typename Lock>
    bool timedWait(const Lock& lock, const Time& timeout) const;
};
```

Using a condition variable is very similar to using a monitor. The main difference in the `Cond` interface is that the `wait` and `timedWait` member functions are template functions, instead of the entire class being a template. The member functions behave as follows:

- `wait`
This function suspends the calling thread and, at the same time, releases the lock of the condition variable. A thread suspended inside a call to `wait` can be woken up by another thread that calls `signal` or `broadcast`. When `wait` completes, the suspended thread resumes execution with the lock held.
- `timedWait`
This function suspends the calling thread for up to the specified timeout. If another thread calls `signal` or `broadcast` and wakes up the suspended thread before the timeout expires, the call returns true and the suspended thread resumes execution with the lock held. Otherwise, if the timeout expires, the function returns false. Wait intervals are represented by instances of the [Time](#) class.
- `signal`
This function wakes up a single thread that is currently suspended in a call to `wait` or `timedWait`. If no thread is suspended in a call to `wait` or `timedWait` at the time `signal` is called, the signal is lost (that is, calls to `signal` are *not* remembered if there is no thread to be woken up). Note that signalling does not necessarily run another thread immediately; the thread calling `signal` may continue to run. However, depending on the underlying thread library, `signal` may also cause an immediate context switch to another thread.
- `broadcast`
This function wakes up all threads that are currently suspended in a call to `wait` or `timedWait`. As for `signal`, calls to `broadcast` are lost if no threads are suspended at the time.

You must adhere to a few rules for condition variables to work correctly:

- Do not call `wait` or `timedWait` unless you hold the lock.
- When returning from a `wait` call, you *must re-test the condition* before proceeding, just as for a monitor.

In contrast to monitors, which require you to call `notify` and `notifyAll` with the lock held, condition variables permit you to call `signal` and `broadcast` without holding the lock. Here is a code example that changes a condition and signals on a condition variable:

```

C++

Mutex m;
Cond c;

// ...

{
    Mutex::Lock sync(m);

    // Change some condition other threads may be sleeping on...

    c.signal();

    // ...
} // m is unlocked here
```

This code is correct and will work as intended, but it is potentially inefficient. Consider the code executed by the waiting thread:

```

C++

{
    Mutex::Lock sync(m);

    while(!condition) {
        c.wait(sync);
    }

    // Condition is now true, do some processing...

} // m is unlocked here
```

Again, this code is correct and will work as intended. However, consider what can happen once the first thread calls `signal`. It is possible that the call to `signal` will cause an immediate context switch to the waiting thread. But, even if the thread implementation does not cause such an immediate context switch, it is possible for the signalling thread to be suspended after it has called `signal`, but before it unlocks the mutex `m`. If this happens, the following sequence of events occurs:

1. The waiting thread is still suspended inside the implementation of `wait` and is now woken up by the call to `signal`.
2. The now-awake thread tries to acquire the mutex `m` but, because the signalling thread has not yet released the mutex, is suspended again waiting for the mutex to be unlocked.
3. The signalling thread is scheduled again and leaves the scope enclosing `sync`, which unlocks the mutex, making the thread waiting for the mutex runnable.
4. The thread waiting for the mutex acquires the mutex and retests its condition.

While the preceding scenario is functionally correct, it is inefficient because it incurs two extra context switches between the signalling thread

and the waiting thread. Because context switches are expensive, this can have quite a large impact on run-time performance, especially if the critical region is small and the condition changes frequently.

You can avoid the inefficiency by unlocking the mutex *before* calling `signal`:

```

C++

Mutex m;
Cond c;

// ...

{
    Mutex::Lock sync(m);

    // Change some condition other threads may be sleeping on...

} // m is unlocked here

c.signal(); // Signal with the lock available
```

By arranging the code as shown, you avoid the additional context switches because, when the waiting thread is woken up by the call to `signal`, it succeeds in acquiring the mutex before returning from `wait` without being suspended and woken up again first.

As for monitors, you should exercise caution in using `broadcast`, particularly if you have many threads waiting on a condition. Condition variables suffer from the same potential problem as monitors with respect to `broadcast`, namely, that all threads that are currently suspended inside `wait` can immediately attempt to acquire the mutex, but only one of them can succeed and all other threads are suspended again. If your application is sensitive to this condition, you may want to consider [waking threads in a more controlled manner](#).

See Also

- [The C++ Monitor Class](#)
- [The C++ Time Class](#)

The C++ Thread Classes

The server-side Ice run time by default creates a [thread pool](#) for you and automatically dispatches each incoming request in its own thread. As a result, you usually only need to worry about synchronization among threads to protect critical regions when you implement a server. However, you may wish to create threads of your own. For example, you might need a dedicated thread that responds to input from a user interface. And, if you have complex and long-running operations that can exploit parallelism, you might wish to use multiple threads for the implementation of that operation.

Ice provides a simple thread abstraction that permits you to write portable source code regardless of the native threading platform. This shields you from the native underlying thread APIs and guarantees uniform semantics regardless of your deployment platform.

On this page:

- [The C++ Thread Class](#)
- [Implementing Threads in C++](#)
- [Creating Threads in C++](#)
- [The C++ ThreadControl Class](#)
- [C++ Thread Example](#)

The C++ Thread Class

The basic thread abstraction in Ice is provided by two classes, `ThreadControl` and `Thread` (defined in `IceUtil/Thread.h`):

C++

```

namespace IceUtil {

    class Time;

    class ThreadControl {
    public:
#ifdef _WIN32
        typedef DWORD ID;
#else
        typedef pthread_t ID;
#endif

        ThreadControl();
#ifdef _WIN32
        ThreadControl(HANDLE, DWORD);
#else
        ThreadControl(explicit pthread_t);
#endif
        ID id() const;

        void join();
        void detach();

        static void sleep(const Time&);
        static void yield();

        bool operator==(const ThreadControl&) const;
        bool operator!=(const ThreadControl&) const;

    };

    class Thread :virtual public Shared {
    public:
        virtual void run() = 0;

        ThreadControl start(size_t stBytes = 0);
        ThreadControl start(size_t stBytes, int priority);
        ThreadControl getThreadControl() const;
        bool isAlive() const;

        bool operator==(const Thread&) const;
        bool operator!=(const Thread&) const;
        bool operator<(const Thread&) const;
    };
    typedef Handle<Thread> ThreadPtr;
}

```

The `Thread` class is an abstract base class with a pure virtual `run` method. To create a thread, you must specialize the `Thread` class and implement the `run` method (which becomes the starting stack frame for the new thread). Note that you must not allow any exceptions to escape from `run`. The Ice run time installs an exception handler that calls `::std::terminate` if `run` terminates with an exception.

The remaining member functions behave as follows:

- `start(size_t stBytes = 0)`
`start(size_t stBytes, int priority)`

This member function starts a newly-created thread (that is, calls the `run` method). The `stBytes` parameter specifies a stack size (in bytes) for the thread. The default value of zero creates the thread with a default stack size that is determined by the operating system.

You can also specify a priority for the thread. (If you do not supply a priority, the thread is created with the system default priority.) The priority value is system-dependent; on POSIX systems, the value must be a legal value for the `SCHED_RR` real-time scheduling policy. (`SCHED_RR` requires root privileges.) On Windows systems, the priority value is passed through to the Windows `setThreadPriority` function. [Priority Inversion in C++](#) provides information about how you can deal with priority inversion.

The return value is a `ThreadControl` object for the new thread.

You can start a thread only once; calling `start` on an already-started thread raises `ThreadStartedException`.

If the calling thread passes an invalid priority or, on POSIX systems, does not have root privileges, `start` raises `ThreadSyscallException`.

- `getThreadControl`
This member function returns a `ThreadControl` object for the thread on which it is invoked. Calling this method before calling `start` raises a `ThreadNotStartedException`.
- `id`
This method returns the underlying thread ID (`DWORD` for Windows and `pthread_t` for POSIX threads). This method is provided mainly for debugging purposes. Note also that `pthread_t` is, strictly-speaking, an opaque type, so you should not make any assumptions about what you can do with a thread ID.
- `isAlive`
This method returns `false` before a thread's `start` method has been called and after a thread's `run` method has completed; otherwise, while the thread is still running, it returns `true`. `isAlive` is useful to implement a non-blocking join:

```

C++

ThreadPtr p = new MyThread();
// ...
while(p->isAlive()) {
    // Do something else...
}
p->getThreadControl().join(); // Will not block
```

- `operator==`
`operator!=`
`operator<`

These member functions compare the in-memory address of two threads. They are provided so you can use `Thread` objects in sorted STL containers.

Note that `IceUtil` also defines the type `ThreadPtr`. This is the usual reference-counted [smart pointer](#) to guarantee automatic clean-up: the `Thread` destructor calls `delete` this once its reference count drops to zero.

Implementing Threads in C++

To illustrate how to implement threads, consider the following code fragment:

```

C++

#include <IceUtil/Thread.h>
// ...

Queue q;

class ReaderThread : public IceUtil::Thread {
    virtual void run() {
        for (int i = 0; i < 100; ++i)
            cout << q.get() << endl;
    }
};

class WriterThread : public IceUtil::Thread {
    virtual void run() {
        for (int i = 0; i < 100; ++i)
            q.put(i);
    }
};
```

This code fragment defines two classes, `ReaderThread` and `WriterThread`, that inherit from `IceUtil::Thread`. Each class implements the pure virtual `run` method it inherits from its base class. For this simple example, a writer thread places the numbers from 1 to 100 into an instance of the thread-safe `Queue` class we defined in our discussion of [monitors](#), and a reader thread retrieves 100 numbers from the queue and prints them to `stdout`.

Creating Threads in C++

To create a new thread, we simply instantiate the thread and call its `start` method:

```

C++

IceUtil::ThreadPtr t = new ReaderThread;
t->start();
// ...
```

Note that we assign the return value from `new` to a smart pointer of type `ThreadPtr`. This ensures that we do not suffer a memory leak:

1. When the thread is created, its reference count is set to zero.
2. Prior to calling `run` (which is called by the `start` method), `start` increments the reference count of the thread to 1.
3. For each `ThreadPtr` for the thread, the reference count of the thread is incremented by 1, and for each `ThreadPtr` that is destroyed, the reference count is decremented by 1.
4. When `run` completes, `start` decrements the reference count again and then checks its value: if the value is zero at this point, the `Thread` object deallocates itself by calling `delete this`; if the value is non-zero at this point, there are other smart pointers that reference this `Thread` object and deletion happens when the last smart pointer goes out of scope.

Note that, for all this to work, you *must* allocate your `Thread` objects on the heap — stack-allocated `Thread` objects will result in

deallocation errors:

```
C++
```

```
ReaderThread thread;
IceUtil::ThreadPtr t = &thread; // Bad news!!!
```

This is wrong because the destructor of `t` will eventually call `delete`, which has undefined behavior for a stack-allocated object.

Similarly, you *must* use a `ThreadPtr` for an allocated thread. Do not attempt to explicitly delete a thread:

```
C++
```

```
Thread* t = new ReaderThread();

// ...

delete t; // Disaster!
```

This will result in a double deallocation of the thread because the thread's destructor will call `delete this`.

It is legal for a thread to call `start` on itself from within its own constructor. However, if so, the thread must not be (very) short lived:

```
C++
```

```
class ActiveObject : public Thread() {
public:
    ActiveObject() {
        start();
    }

    void done() {
        getThreadControl().join();
    }

    virtual void run() {
        // *Very* short lived...
    }
};
typedef Handle<ActiveObject> ActiveObjectPtr;

// ...

ActiveObjectPtr ao = new ActiveObject;
```

With this code, it is possible for `run` to complete before the assignment to the smart pointer `ao` completes; in that case, `start` will call `delete this` before it returns and `ao` ends up deleting an already-deleted object. However, note that this problem can arise only if `run` is indeed very short-lived and moreover, the scheduler allows the newly-created thread to run to completion before the assignment of the return value of `operator new` to `ao` takes place. This is highly unlikely to happen — if you are concerned about this scenario, do not call `s`

start from within a thread's own constructor. That way, the smart pointer is assigned first, and the thread started second, so the problem cannot arise.

The C++ ThreadControl Class

The start method returns an object of type ThreadControl. The member functions of ThreadControl behave as follows:

- ThreadControl

The default constructor returns a ThreadControl object that refers to the calling thread. This allows you to get a handle to the current (calling) thread even if you had not previously saved a handle to that thread. For example:

```

C++
IceUtil::ThreadControl self;    // Get handle to self
cout << self.id() << endl;    // Print thread ID

```

This example also explains why we have two classes, Thread and ThreadControl: without a separate ThreadControl, it would not be possible to obtain a handle to an arbitrary thread. (Note that this code works even if the calling thread was not created by the Ice run time; for example, you can create a ThreadControl object for a thread that was created by the operating system.)

The (implicit) copy constructor and assignment operator create a ThreadControl object that refers to the same underlying thread as the source ThreadControl object.

Note that the constructor is overloaded. For Windows, the signature is

```

C++
ThreadControl(HANDLE, DWORD);

```

For Unix, the signature is

```

C++
ThreadControl(pthread_t);

```

These constructors allow you to create a ThreadControl object for the specified thread.

- join

This method suspends the calling thread until the thread on which join is called has terminated. For example:

```

C++
IceUtil::ThreadPtr t = new ReaderThread; // Create a thread
IceUtil::ThreadControl tc = t->start(); // Start it
tc.join(); // Wait for it

```

If the reader thread has finished by the time the creating thread calls join, the call to join returns immediately; otherwise, the creating thread is suspended until the reader thread terminates.

Note that the `join` method of a thread must be called from only one other thread, that is, only one thread can wait for another thread to terminate. Calling `join` on a thread from more than one other thread has undefined behavior.

Calling `join` on a thread that was previously joined with or calling `join` on a detached thread has undefined behavior. You must join with each thread you create; failure to join with a thread has undefined behavior.

- `detach`

This method detaches a thread. Once a thread is detached, it cannot be joined with.

Calling `detach` on an already detached thread, or calling `detach` on a thread that was previously joined with has undefined behavior.

Note that, if you have detached a thread, you must ensure that the detached thread has terminated before your program leaves its `main` function. This means that, because detached threads cannot be joined with, they must have a life time that is shorter than that of the main thread.

- `sleep`

This method suspends the calling thread for the amount of time specified by the `Time` class.

- `yield`

This method causes the calling thread to relinquish the CPU, allowing another thread to run.

- `operator==`
`operator!=`

These operators compare thread IDs. (Note that `operator<` is not provided because it cannot be implemented portably.) These operators yield meaningful results only for threads that have not been detached or joined with.

As for all the synchronization primitives, you must adhere to a few rules when using threads to avoid undefined behavior:

- Do not allow `run` to throw an exception.
- Do not join with or detach a thread that you have not created yourself.
- For every thread you create, you must either join with that thread exactly once or detach it exactly once; failure to do so may cause resource leaks.
- Do not call `join` on a thread from more than one other thread.
- Do not leave `main` until all other threads you have created have terminated.
- Do not leave `main` until after you have destroyed all `Ice::Communicator` objects you have created (or use the `Ice::Application` class).
- A common mistake is to call `yield` from within a critical region. Doing so is usually pointless because the call to `yield` will look for another thread that can be run but, when that thread is run, it will most likely try to enter the critical region that is held by the yielding thread and go to sleep again. At best, this achieves nothing and, at worst, it causes many additional context switches for no gain. If you call `yield`, do so only in circumstances where there is at least a fair chance that another thread will actually be able to run and do something useful.

C++ Thread Example

Following is a small example that uses the `Queue` class we defined in our discussion of [monitors](#). We create five writer and five reader threads. The writer threads each deposit 100 numbers into the queue, and the reader threads each retrieve 100 numbers and print them to `stdout`:

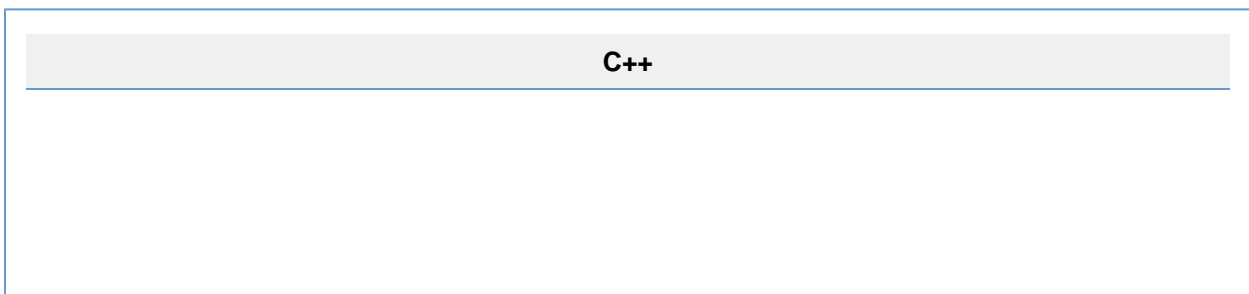

```

#include <vector>
#include <IceUtil/Thread.h>
// ...

Queue q;

class ReaderThread : public IceUtil::Thread {
    virtual void run() {
        for (int i = 0; i < 100; ++i)
            cout << q.get() << endl;
    }
};

class WriterThread : public IceUtil::Thread {
    virtual void run() {
        for (int i = 0; i < 100; ++i)
            q.put(i);
    }
};

int
main()
{
    vector<IceUtil::ThreadControl> threads;
    int i;

    // Create five reader threads and start them
    //
    for (i = 0; i < 5; ++i) {
        IceUtil::ThreadPtr t = new ReaderThread;
        threads.push_back(t->start());
    }

    // Create five writer threads and start them
    //
    for (i = 0; i < 5; ++i) {
        IceUtil::ThreadPtr t = new WriterThread;
        threads.push_back(t->start());
    }

    // Wait for all threads to finish
    //
    for (vector<IceUtil::ThreadControl>::iterator i = threads.begin();
         i != threads.end(); ++i) {
        i->join();
    }
}

```

The code uses the `threads` variable, of type `vector<IceUtil::ThreadControl>`, to keep track of the created threads. The code

creates five reader and five writer threads, storing the `ThreadControl` object for each thread in the `threads` vector. Once all the threads are created and running, the code joins with each thread before returning from `main`.

Note that you must not leave `main` without first joining with the threads you have created: many threading libraries crash if you return from `main` with other threads still running. (This is also the reason why you must not terminate a program without first calling `Communicator::destroy`; the `destroy` implementation joins with all outstanding threads before it returns.)

See Also

- [Smart Pointers for Classes](#)
- [The Server-Side main Function in C++](#)
- [The C++ Monitor Class](#)
- [The Ice Threading Model](#)
- [The C++ Time Class](#)

Priority Inversion in C++

In real-time systems, if you have threads with different priorities, it is possible to encounter a priority inversion. A priority inversion occurs when a low-priority thread prevents a higher-priority thread from running. This situation arises when a low-priority thread acquires a mutex and is pre-empted by one or more medium-priority threads that do not relinquish the CPU. If a high-priority thread then attempts to acquire the mutex locked by the low-priority thread, it will wait (potentially forever) for the medium-priority threads to complete.

One way to deal with this problem is to use a priority inheritance protocol. If a low-priority thread holds a mutex and a high-priority thread attempts to acquire the mutex, the priority of the thread holding the mutex is temporarily raised to the level of the thread waiting for the mutex. This allows the low-priority thread to keep running until it releases the mutex; as soon as it does, its priority is reduced back to its previous level and the high-priority thread acquires the mutex.

Ice supports the priority inheritance protocol on many POSIX platforms. (Windows does not provide such a protocol.)

For POSIX platforms that support the priority inheritance protocol, mutexes by default do not use it. You can use the `getDefaultMutexProtocol` function to retrieve the current default for your platform:

```

C++

namespace IceUtil {
    enum MutexProtocol { PrioInherit, PrioNone };

    MutexProtocol getDefaultMutexProtocol();
}

```

On Posix systems that do not support priority inheritance and on Windows, this function always returns `PrioNone`.

The return value of `getDefaultMutexProtocol` determines whether a default-constructed `Mutex` or `RecMutex` uses priority inheritance. By default, this function returns `PrioNone`. You can override this default by explicitly specifying a different protocol when you construct a `Mutex` or `RecMutex`. On Windows, if you specify `PrioInherit` when you construct a mutex, the setting is ignored and the mutex is constructed as if you had specified `PrioNone`.

To change the value returned by `getDefaultMutexProtocol`, you can edit `cpp/config/Make.rules`, modify the value of the `DEFAULT_T_MUTEX_PROTOCOL` macro, and then rebuild the `IceUtil` library.

See Also

- [The C++ Mutex Class](#)
- [The C++ RecMutex Class](#)

Portable Signal Handling in C++

The `IceUtil::CtrlCHandler` class provides a portable mechanism to handle Ctrl+C and similar signals sent to a C++ process. On Windows, `IceUtil::CtrlCHandler` is a wrapper for `SetConsoleCtrlHandler`; on POSIX platforms, it handles `SIGHUP`, `SIGTERM` and `SIGINT` with a dedicated thread that waits for these signals using `sigwait`. Signals are handled by a callback function implemented and registered by the user. The callback is a simple function that takes an `int` (the signal number) and returns `void`; it must not throw any exception:

```

C++

namespace IceUtil {

    typedef void (*CtrlCHandlerCallback)(int);

    class CtrlCHandler {
    public:
        CtrlCHandler(CtrlCHandlerCallback = 0);
        ~CtrlCHandler();

        void setCallback(CtrlCHandlerCallback);
        CtrlCHandlerCallback getCallback() const;
    };
}

```

The member functions of `CtrlCHandler` behave as follows:

- `CtrlCHandler`
Constructs an instance with a callback function. Only one instance of `CtrlCHandler` can exist in a process at a given moment in time. On POSIX platforms, the constructor masks `SIGHUP`, `SIGTERM` and `SIGINT`, then starts a thread that waits for these signals using `sigwait`. For signal masking to work properly, it is imperative that the `CtrlCHandler` instance be created before starting any thread, and in particular before initializing an Ice communicator.
- `~CtrlCHandler`
Destroys the instance, after which the default signal processing behavior is restored on Windows (`TerminateProcess`). On POSIX platforms, the "sigwait" thread is terminated and joined, but the signal mask remains unchanged, so subsequent signals are ignored.
- `setCallback`
Sets a new callback function.
- `getCallback`
Gets the current callback function.

It is legal specify a value of zero (0) for the callback function, in which case signals are caught and ignored until a non-zero callback function is set.

A typical use for `CtrlCHandler` is to shutdown a communicator in an Ice server. For example, the `Ice::Application` class uses a `CtrlCHandler` in its implementation.

See Also

- [The Server-Side main Function in C++](#)

The Ice Run Time in Detail

This section describes in detail the server-side APIs of the Ice run time for synchronous, oneway, and datagram invocations. Communicators are the main handle to the Ice run time. They provide access to a number of run time resources and allow you to control the life cycle of a server. Object adapters provide a mapping between abstract Ice objects and concrete servants. Various implementation techniques are at your disposal to control the trade-off between performance and scalability; in particular, servant locators are a central mechanism that permits you to choose an implementation technique that matches the requirements of your application.

Ice provides both oneway and datagram invocations. These provide performance gains in situations where an application needs to provide numerous stateless updates. Batching such invocations permits you to increase performance even further.

The Ice logging mechanism is user extensible, so you can integrate Ice messages into arbitrary logging frameworks, and the metrics facility permits you to collect statistics about the Ice run time.

Finally, even though Ice is location transparent, in the interest of efficiency, collocated invocations do not behave in all respects like remote invocations. You need to be aware of these differences, especially for applications that are sensitive to thread context.

Topics

- [Communicators](#)
- [Communicator Initialization](#)
- [Object Adapters](#)
- [Object Identity](#)
- [The Current Object](#)
- [Servant Locators](#)
- [Default Servants](#)
- [Server Implementation Techniques](#)
- [Servant Evictors](#)
- [The Ice Threading Model](#)
- [Using Proxies](#)
- [Request Contexts](#)
- [Connection Timeouts](#)
- [Oneway Invocations](#)
- [Datagram Invocations](#)
- [Batched Invocations](#)
- [Locators](#)
- [Administrative Facility](#)
- [Instrumentation Facility](#)
- [Logger Facility](#)
- [Location Transparency](#)
- [Automatic Retries](#)
- [Dispatch Interceptors](#)
- [C++ Strings and Character Encoding](#)
- [Plug-in Facility](#)
- [Custom Class Loaders](#)
- [Understanding Objects and Exceptions](#)
- [Optional Values](#)

Communicators

The main entry point to the Ice run time is represented by the local interface `Ice::Communicator`. An instance of `Ice::Communicator` is associated with a number of run-time resources:

- **Client-side thread pool**
The client-side [thread pool](#) is used to process replies to asynchronous method invocations (AMI), to avoid deadlocks in callbacks, and to process incoming requests on [bidirectional connections](#).
- **Server-side thread pool**
Threads in this [pool](#) accept incoming connections and handle requests from clients.
- **Configuration properties**
Various aspects of the Ice run time can be configured via properties. Each communicator has its own set of such [configuration properties](#).
- **Object factories**
In order to instantiate [classes](#) that are derived from a known base type, the communicator maintains a set of object factories that can instantiate the class on behalf of the Ice run time. Object factories are discussed in each client-side language mapping.
- **Logger object**
A [logger](#) object implements the `Ice::Logger` interface and determines how log messages that are produced by the Ice run time are handled.
- **Default router**
A router implements the `Ice::Router` interface. Routers are used by [Glacier2](#) to implement the firewall functionality of Ice.
- **Default locator**
A [locator](#) is an object that resolves an object identity to a proxy. Locator objects are used to build location services, such as [IceGrid](#).
- **Plug-in manager**
[Plug-ins](#) are objects that add features to a communicator. For example, [IceSSL](#) is implemented as a plug-in. Each communicator has a plug-in manager that implements the `Ice::PluginManager` interface and provides access to the set of plug-ins for a communicator.
- **Object adapters**
[Object adapters](#) dispatch incoming requests and take care of passing each request to the correct servant.

Object adapters and objects that use different communicators are completely independent from each other. Specifically:

- Each communicator uses its own thread pool. This means that if, for example, one communicator runs out of threads for incoming requests, only objects using that communicator are affected. Objects using other communicators have their own thread pool and are therefore unaffected.
- Collocated invocations across different communicators are not optimized, whereas collocated invocations using the same communicator bypass much of the overhead of call dispatch.

Typically, servers use only a single communicator but, occasionally, multiple communicators can be useful. For example, [IceBox](#), uses a separate communicator for each Ice service it loads to ensure that different services cannot interfere with each other. Multiple communicators are also useful to avoid thread starvation: if one service runs out of threads, this leaves the remaining services unaffected.

The communicator's interface is defined in `Slice`. Part of this interface looks as follows:

Slice

```

module Ice {
  local interface Communicator {
    string proxyToString(Object* obj);
    Object* stringToProxy(string str);
    PropertyDict proxyToProperty(Object* proxy, string property);
    Object* propertyToProxy(string property);
    Identity stringToIdentity(string str);
    string identityToString(Identity id);
    ObjectAdapter createObjectAdapter(string name);
    ObjectAdapter createObjectAdapterWithEndpoints(string name,
string endpoints);
    ObjectAdapter createObjectAdapterWithRouter(string name,
Router* rtr);
    void shutdown();
    void waitForShutdown();
    bool isShutdown();
    void destroy();
    // ...
  };
  // ...
};

```

The communicator offers a number of operations:

- `proxyToString`
`stringToProxy`

These operations allow you to convert a proxy into its stringified representation and vice versa. Instead of calling `proxyToString` on the communicator, you can also use the `ice_toString` [proxy method](#) to stringify it. However, you can only stringify non-null proxies that way — to stringify a null proxy, you must use `proxyToString`. (The stringified representation of a null proxy is the empty string.)

- `proxyToProperty`
`propertyToProxy`

`proxyToProperty` returns the set of [proxy properties](#) for the supplied proxy. The `property` parameter specifies the base name for the properties in the returned set. `propertyToProxy` [retrieves](#) the configuration property with the given name and converts its value into a proxy. A null proxy is returned if no property is found with the specified name.

- `identityToString`
`stringToIdentity`

These operations allow you to convert an [identity](#) to a string and vice versa.

- `createObjectAdapter`
`createObjectAdapterWithEndpoints`
`createObjectAdapterWithRouter`

These operations create a new [object adapter](#). Each object adapter is associated with zero or more [transport endpoints](#). Typically, an object adapter has a single transport endpoint. However, an object adapter can also offer multiple endpoints. If so, these endpoints each lead to the same set of objects and represent alternative means of accessing these objects. This is useful, for

example, if a server is behind a firewall but must offer access to its objects to both internal and external clients; by binding the adapter to both the internal and external interfaces, the objects implemented in the server can be accessed via either interface.

An object adapter also can have no endpoint at all. In that case, the adapter can only be reached via colocated invocations originating from the same communicator as is used by the adapter.

Whereas `createObjectAdapter` determines its transport endpoints from configuration information, `createObjectAdapterWithEndpoints` allows you to supply the transport endpoints for the new adapter. Typically, you should use `createObjectAdapter` in preference to `createObjectAdapterWithEndpoints`. Doing so keeps transport-specific information, such as host names and port numbers, out of the source code and allows you to reconfigure the application by changing a property (and so avoid recompilation when a transport endpoint needs to be changed).

`createObjectAdapterWithRouter` creates a routed object adapter that allows clients to receive callbacks from servers that are behind a [router](#).

The newly-created adapter uses its name as a prefix for a collection of [configuration properties](#) that tailor the adapter's behavior. By default, the adapter prints a warning if other properties are defined having the same prefix, but you can disable this warning using the property `Ice.Warn.UnknownProperties`.

- `shutdown`

This operation shuts down the server side of the Ice run time:

- Operation invocations that are in progress at the time `shutdown` is called are allowed to complete normally. `shutdown` does *not* wait for these operations to complete; when `shutdown` returns, you know that no new incoming requests will be dispatched, but operations that were already in progress at the time you called `shutdown` may still be running. You can wait for still-executing operations to complete by calling `waitForShutdown`.
- Operation invocations that arrive after the server has called `shutdown` either fail with a `ConnectFailedException` or are transparently redirected to a new instance of the server (via [IceGrid](#)).
- Note that `shutdown` initiates deactivation of all object adapters associated with the communicator, so attempts to use an adapter once `shutdown` has completed raise an `ObjectAdapterDeactivatedException`.

- `waitForShutdown`

On the server side, this operation suspends the calling thread until the communicator has shut down (that is, until no more operations are executing in the server). This allows you to wait until the server is idle before you destroy the communicator.

On the client side, `waitForShutdown` simply waits until another thread has called `shutdown` or `destroy`.

- `isShutdown`

This operation returns true if `shutdown` has been invoked on the communicator. A return value of true does not necessarily indicate that the shutdown process has completed, only that it has been initiated. An application that needs to know whether shutdown is complete can call `waitForShutdown`. If the blocking nature of `waitForShutdown` is undesirable, the application can invoke it from a separate thread.

- `destroy`

This operation destroys the communicator and all its associated resources, such as threads, communication endpoints, object adapters, and memory resources. Once you have destroyed the communicator (and therefore destroyed the run time for that communicator), you must not call any other Ice operation (other than to create another communicator).

It is imperative that you call `destroy` before you leave the `main` function of your program. Failure to do so results in undefined behavior.

Calling `destroy` before leaving `main` is necessary because `destroy` waits for all running threads to terminate before it returns. If you leave `main` without calling `destroy`, you will leave `main` with other threads still running; many threading packages do not allow you to do this and end up crashing your program.

If you call `destroy` without calling `shutdown`, the call waits for all executing operation invocations to complete before it returns (that is, the implementation of `destroy` implicitly calls `shutdown` followed by `waitForShutdown`). `shutdown` (and, therefore, `destroy`) deactivates all object adapters that are associated with the communicator. Since `destroy` blocks until all operation invocations complete, a servant will deadlock if it invokes `destroy` on its own communicator while executing a dispatched operation.

On the client side, calling `destroy` while operations are still executing causes those operations to terminate with a `CommunicatorDestroyedException`.

See Also

- [Properties and Configuration](#)
- [Object Adapters](#)
- [Object Adapter Endpoints](#)
- [Object Identity](#)
- [Obtaining Proxies](#)
- [Proxy Methods](#)
- [Logger Facility](#)
- [The Ice Threading Model](#)
- [Bidirectional Connections](#)
- [IceGrid](#)
- [IceSSL](#)
- [Glacier2](#)
- [IceBox](#)

Communicator Initialization

During the creation of a communicator, the Ice run time initializes a number of features that affect the communicator's operation. Once set, these features remain in effect for the life time of the communicator, that is, you cannot change these features after you have created a communicator. Therefore, if you want to customize these features, you must do so when you create the communicator.

The following features can be customized at communicator creation time:

- the [property set](#)
- the [logger object](#)
- the [instrumentation observer](#)
- the narrow and wide [string converters](#) (C++ only)
- the [thread notification hook](#)
- the [dispatcher](#)
- the compact ID resolver (used by the [streaming interfaces](#) when extracting Ice objects)
- the [class loader](#) (Java only)

To establish these features, you initialize a structure or class of type `InitializationData` with the relevant settings. For C++ the structure is defined as follows:

C++

```

namespace Ice {
    struct InitializationData {
        PropertiesPtr properties;
        LoggerPtr logger;
        Instrumentation::CommunicatorObserverPtr observer;
        StringConverterPtr stringConverter;
        WstringConverterPtr wstringConverter;
        ThreadNotificationPtr threadHook;
        DispatcherPtr dispatcher;
        CompactIdResolverPtr compactIdResolver;
    };
}

```

For languages other than C++, `InitializationData` is a class with all data members public. (The data members supported by this class vary with each language mapping.)

For C++, `Ice::initialize` is overloaded as follows:

C++

```

namespace Ice {
    CommunicatorPtr initialize(int&, char*[],
        const InitializationData& = InitializationData(),
        Int = ICE_INT_VERSION);
    CommunicatorPtr initialize(StringSeq&,
        const InitializationData& = InitializationData(),
        Int = ICE_INT_VERSION);
    CommunicatorPtr initialize(
        const InitializationData& = InitializationData()
        Int = ICE_INT_VERSION);
}

```

The versions of `initialize` that accept an argument vector look for Ice-specific command-line options and remove them from the argument vector, as described in the [C++ language mapping](#). The version without an `argc/argv` pair is useful if you want to prevent property settings for a program from being changed by command-line arguments — you can use the [Properties](#) interface for this purpose.

To set a feature, you set the corresponding field in the `InitializationData` structure and pass the structure to `initialize`. For example, to establish a custom logger of type `MyLogger`, you can use:

```

Ice::InitializationData id;
id.logger = new MyLoggerI;
Ice::CommunicatorPtr ic = Ice::initialize(argc, argv, id);

```

For Java, C#, and Objective-C, `Ice.Util.initialize` is overloaded similarly (as is `Ice.initialize` for Python, `Ice::initialize` for Ruby, and `Ice_initialize` for PHP), so you can pass an `InitializationData` instance either with or without an argument vector.

 For Objective-C, the method name is `createCommunicator`.

Note that you must supply an [argument vector](#) if you want `initialize` to look for a configuration file in the `ICE_CONFIG` environment variable.

See Also

- [The Server-Side main Function in C++](#)
- [The Server-Side main Function in Objective-C](#)
- [Command-Line Parsing and Initialization](#)
- [The Properties Interface](#)

Object Adapters

A communicator contains one or more object adapters. An object adapter sits at the boundary between the Ice run time and the server application code and has a number of responsibilities:

- Maps Ice objects to servants for incoming requests and dispatches the requests to the application code in each servant (that is, an object adapter implements an up-call interface that connects the Ice run time and the application code in the server).
- Assists in life cycle operations so Ice objects and servants can be created and existing destroyed without race conditions.
- Provides one or more transport endpoints. Clients access the Ice objects provided by the adapter via those endpoints. (It is also possible to create an object adapter without endpoints. In this case the adapter is used for [bidirectional callbacks](#)).

Each object adapter has one or more servants that incarnate Ice objects, as well as one or more transport endpoints. If an object adapter has more than one endpoint, all servants registered with that adapter respond to incoming requests on any of the endpoints. In other words, if an object adapter has multiple transport endpoints, those endpoints represent alternative communication paths to the same set of objects (for example, via different transports).

Each object adapter belongs to exactly one communicator (but a single communicator can have many object adapters). Each object adapter has a name that distinguishes it from all other object adapters in the same communicator.

Each object adapter can optionally have its own [thread pool](#), enabled via the `<adapter-name>.ThreadPool.Size` property. If so, client invocations for that adapter are dispatched in a thread taken from the adapter's thread pool instead of using a thread from the communicator's server thread pool.

[Servants](#) are the physical manifestation of an Ice object, that is, they are entities that are implemented in a concrete programming language and instantiated in the server's address space. Servants provide the server-side behavior for operation invocations sent by clients. The same servant can be registered with one or more object adapters.

Topics

- [The Active Servant Map](#)
- [Creating an Object Adapter](#)
- [Servant Activation and Deactivation](#)
- [Object Adapter States](#)
- [Object Adapter Endpoints](#)
- [Creating Proxies with an Object Adapter](#)
- [Using Multiple Object Adapters](#)

See Also

- [Object Adapter Thread Pools](#)
- [Bidirectional Connections](#)

The Active Servant Map

Each object adapter maintains a data structure known as the active servant map.

On this page:

- [Role of the Active Servant Map](#)
- [Design Considerations for the Active Servant Map](#)

Role of the Active Servant Map

The *active servant map* (or *ASM*, for short) is a lookup table that maps object identities to servants: for C++, the lookup value is a smart pointer to the corresponding servant's location in memory; for Java and C#, the lookup value is a reference to the servant. When a client sends an operation invocation to the server, the request is targeted at a specific transport endpoint. Implicitly, the transport endpoint identifies the object adapter that is the target of the request (because no two object adapters can be bound to the same endpoint). The proxy via which the client sends its request contains the *object identity* for the corresponding object, and the client-side run time sends this object identity over the wire with the invocation. In turn, the object adapter uses that object identity to look in its ASM for the correct servant to dispatch the call to, as shown below:

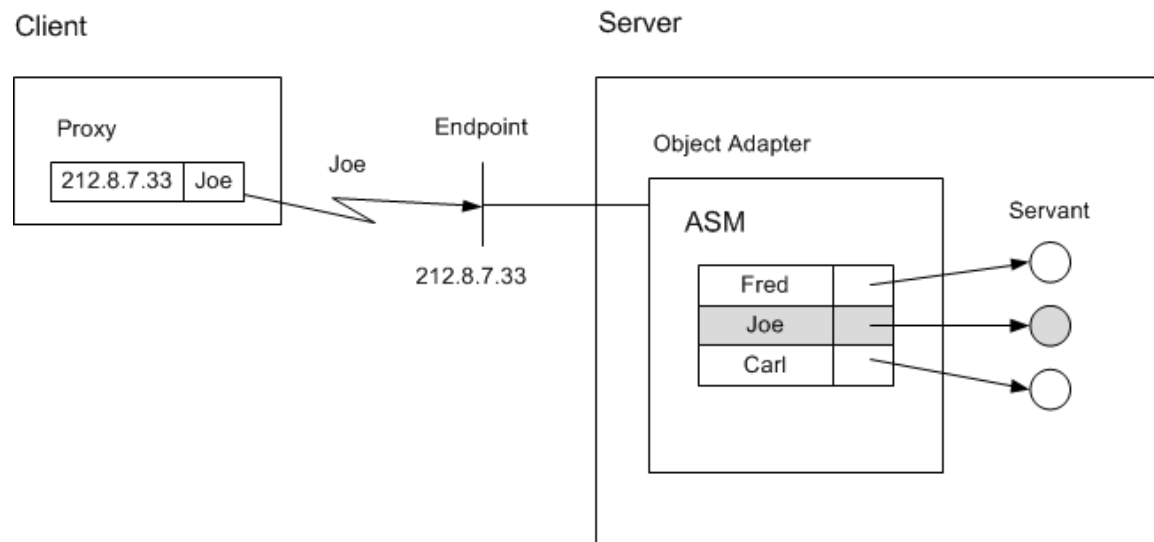

Binding a request to the correct servant.

The process of associating a request via a proxy to the correct servant is known as *binding*. The scenario depicted in the illustration shows direct binding, in which the transport endpoint is embedded in the proxy. Ice also supports an indirect binding mode, in which the correct transport endpoints are provided by the [IceGrid](#) service.

If a client request contains an object identity for which there is no entry in the adapter's ASM, the adapter returns an `ObjectNotExistException` to the client (unless you use a [default servant](#) or [servant locator](#)).

Design Considerations for the Active Servant Map

Using an adapter's ASM to map Ice objects to servants has a number of design implications:

- Each Ice object is represented by a different servant.

i It is possible to register a single servant with multiple identities. However, there is little point in doing so because a [default servant](#) achieves the same thing.

- All servants for all Ice objects are permanently in memory.

Using a separate servant for each Ice object in this fashion is common to many server implementations: the technique is simple to implement and provides a natural mapping from Ice objects to servants. Typically, on start-up, the server instantiates a separate servant for each Ice

object, activates each servant, and then calls `activate` on the object adapter to start the flow of requests.

There is nothing wrong with the above design, provided that two criteria are met:

1. The server has sufficient memory available to keep a separate servant instantiated for each Ice object at all times.
2. The time required to initialize all the servants on start-up is acceptable.

For many servers, neither criterion presents a problem: provided that the number of servants is small enough and that the servants can be initialized quickly, this is a perfectly acceptable design. However, the design does not scale well: the memory requirements of the server grow linearly with the number of Ice objects so, if the number of objects gets too large (or if each servant stores too much state), the server runs out of memory.

Ice offers two APIs that help you scale servers to larger numbers of objects: *servant locators* and *default servants*. A [default servant](#) is essentially a simplified version of a [servant locator](#) that satisfies the majority of use cases, whereas a servant locator provides more flexibility for those applications that require it.

See Also

- [Servant Locators](#)
- [Default Servants](#)
- [IceGrid](#)

Creating an Object Adapter

An object adapter is an instance of the local interface `ObjectAdapter`. You create an object adapter by calling one of several operations on a communicator:

Slice
<pre> module Ice { local interface ObjectAdapter { string getName(); Communicator getCommunicator(); // ... }; local interface Communicator { ObjectAdapter createObjectAdapter(string name); ObjectAdapter createObjectAdapterWithEndpoints(string name, string endpoints); ObjectAdapter createObjectAdapterWithRouter(string name, Router* rtr); // ... }; }; </pre>

The `ObjectAdapter` operations behave as follows:

- The `getName` operation returns the name of the adapter as passed to one of the [communicator operations](#) `createObjectAdapter`, `createObjectAdapterWithEndpoints`, or `createObjectAdapterWithRouter`.
- The `getCommunicator` operation returns the communicator that was used to create the adapter.

Note that there are other operations in the `ObjectAdapter` interface; we will explore these throughout the remainder of this discussion.

See Also

- [Communicators](#)

Servant Activation and Deactivation

The term *servant activation* refers to making the presence of a servant for a particular Ice object known to the Ice run time. Activating a servant adds an entry to the [Active Servant Map](#) (ASM). Another way of looking at servant activation is to think of it as creating a link between the [identity](#) of an Ice object and the corresponding programming-language servant that handles requests for that Ice object. Once the Ice run time has knowledge of this link, it can dispatch incoming requests to the correct servant. Without this link, that is, without a corresponding entry in the ASM, an incoming request for the identity results in an `ObjectNotExistException`. While a servant is activated, it is said to *incarnate* the corresponding Ice object.

The inverse operation is known as *servant deactivation*. Deactivating a servant removes an entry for a particular identity from the ASM. Thereafter, incoming requests for that identity are no longer dispatched to the servant and result in an `ObjectNotExistException`.

The object adapter offers a number of operations for managing servant activation and deactivation:

Slice

```

module Ice {
    local interface ObjectAdapter {
        // ...

        Object* add(Object servant, Identity id);
        Object* addWithUUID(Object servant);
        Object  remove(Identity id);
        Object  find(Identity id);
        Object  findByProxy(Object* proxy);

        // ...
    };
};

```

The operations behave as follows:

- `add`

The `add` operation adds a servant with the given identity to the ASM. Requests are dispatched to that servant as soon as `add` is called. The return value is the proxy for the Ice object incarnated by that servant. The proxy embeds the identity passed to `add`.

You cannot call `add` with the same identity more than once: attempts to add an already existing identity to the ASM result in an `AlreadyRegisteredException`. (It does not make sense to add two servants with the same identity because that would make it ambiguous as to which servant should handle incoming requests for that identity.)

Note that it is possible to activate the same servant multiple times with different identities. In that case, the same single servant incarnates multiple Ice objects. We explore the ramifications of this in more detail in our discussion of [server implementation techniques](#).

- `addWithUUID`

The `addWithUUID` operation behaves the same way as the `add` operation but does not require you to supply an identity for the servant. Instead, `addWithUUID` generates a UUID as the identity for the corresponding Ice object. You can retrieve the generated identity by calling the `ice_getIdentity` operation on the returned proxy. `addWithUUID` is useful to create identities for temporary objects, such as short-lived session objects. (You can also use `addWithUUID` for persistent objects that do not have a natural identity, as we have done for the file system application.)

- `remove`

The `remove` operation breaks the association between an identity and its servant by removing the corresponding entry from the ASM; it returns a reference to the removed servant.

Once the servant is deactivated, new incoming requests for the removed identity cause the client to receive an `ObjectNotExistException`. Requests that are executing inside the servant at the time `remove` is called are allowed to complete normally. Once the last request for the servant is complete, the object adapter drops its reference (or smart pointer, for C++) to the servant. At that point, the servant becomes available for garbage collection (or is destroyed, for C++), provided there are no other references or smart pointers to the servant. The net effect is that a deactivated servant is destroyed once it becomes idle.

Deactivating an `object adapter` implicitly calls `remove` on its active servants.

- `find`

The `find` operation performs a lookup in the ASM and returns the servant for the specified object identity. If no servant with that identity is registered, the operation returns null. Note that `find` does not consult any `servant locators` or `default servants`.

- `findByProxy`

The `findByProxy` operation performs a lookup in the ASM and returns the servant with the object identity and facet that are embedded in the proxy. If no such servant is registered, the operation returns null. Note that `findByProxy` does not consult any `servant locators` or `default servants`.

See Also

- [The Active Servant Map](#)
- [Object Identity](#)
- [Object Adapter States](#)
- [Server Implementation Techniques](#)
- [Servant Locators](#)
- [Default Servants](#)

Object Adapter States

On this page:

- [Object Adapter State Transitions](#)
- [Changing Object Adapter States](#)

Object Adapter State Transitions

An object adapter has a number of processing states:

- **Holding**

In this state, any incoming requests for the adapter are held, that is, not dispatched to servants.

For TCP/IP (and other stream-oriented protocols), the server-side run time stops reading from the corresponding transport endpoint while the adapter is in the holding state. In addition, it also does not accept incoming connection requests from clients. This means that if a client sends a request to an adapter that is in the holding state, the client eventually receives a `TimeoutException` or `ConnectTimeoutException` (unless the adapter is placed into the active state before the timer expires).

For UDP, client requests that arrive at an adapter that is in the holding state are thrown away.

Immediately after creation of an adapter, the adapter is in the holding state. This means that requests are not dispatched until you place the adapter into the active state.

Note that [bidirectional adapters](#) cannot be placed into the holding state. If you call `hold` on a bidirectional adapter, the call does nothing.

- **Active**

In this state, the adapter accepts incoming requests and dispatches them to servants. A newly-created adapter is initially in the holding state. The adapter begins dispatching requests as soon as you place it into the active state.

You can transition between the active and the holding state as many times as you wish.

Note that [bidirectional adapters](#) need not be activated. Further, calls to colocated servants (that is, to servants that are activated in the communicator that created the proxy) succeed even if the adapter is not activated, unless you have disabled [collocation optimization](#).

- **Inactive**

In this state, the adapter has conceptually been destroyed (or is in the process of being destroyed). Deactivating an adapter destroys all transport endpoints that are associated with the adapter. Requests that are executing at the time the adapter is placed into the inactive state are allowed to complete, but no new requests are accepted. (New requests are rejected with an exception). Any attempt to use a deactivated object adapter results in an `ObjectAdapterDeactivatedException`.

Changing Object Adapter States

The `ObjectAdapter` interface offers operations that allow you to change the adapter state, as well as to wait for a state change to be complete:

Slice

```

module Ice {
    local interface ObjectAdapter {
        // ...

        void activate();
        void hold();
        void waitForHold();
        void deactivate();
        void waitForDeactivate();
        void isDeactivated();
        void destroy();

        // ...
    };
};

```

The operations behave as follows:

- `activate`

The `activate` operation places the adapter into the [active](#) state. Activating an adapter that is already active has no effect. The Ice run time starts dispatching requests to servants for the adapter as soon as `activate` is called.

- `hold`

The `hold` operation places the adapter into the [holding](#) state. Requests that arrive after calling `hold` are held as described above. Requests that are in progress at the time `hold` is called are allowed to complete normally. Note that `hold` returns immediately without waiting for currently executing requests to complete.

- `waitForHold`

The `waitForHold` operation suspends the calling thread until the adapter has completed its transition to the holding state, that is, until all currently executing requests have finished. You can call `waitForHold` from multiple threads, and you can call `waitForHold` while the adapter is in the active state. If you call `waitForHold` on an adapter that is already in the holding state, `waitForHold` returns immediately.

- `deactivate`

The `deactivate` operation initiates deactivation of the adapter: requests that arrive after calling `deactivate` are rejected, but currently executing requests are allowed to complete. Once all requests have completed, the adapter enters the [inactive](#) state. Note that `deactivate` returns immediately without waiting for the currently executing requests to complete. A deactivated adapter cannot be reactivated; you can create a new adapter with the same name, but only after calling `destroy` on the existing adapter. Any attempt to use a deactivated object adapter results in an `ObjectAdapterDeactivatedException`.

- `waitForDeactivate`

The `waitForDeactivate` operation suspends the calling thread until the adapter has completed its transition to the [inactive](#) state, that is, until all currently executing requests have completed. You can call `waitForDeactivate` from multiple threads, and you can call `waitForDeactivate` while the adapter is in the active or holding state. Calling `waitForDeactivate` on an adapter that is in the inactive state does nothing and returns immediately.

- `isDeactivated`

The `isDeactivated` operation returns true if `deactivate` has been invoked on the adapter. A return value of true does not necessarily indicate that the adapter has fully transitioned to the inactive state, only that it has begun this transition. Applications that need to know when deactivation is completed can use `waitForDeactivate`.

- `destroy`

The `destroy` operation deactivates the adapter and releases all of its resources. Internally, `destroy` invokes `deactivate` followed by `waitForDeactivate`, therefore the operation blocks until all currently executing requests have completed. Furthermore, any servants associated with the adapter are destroyed, all transport endpoints are closed, and the adapter's name becomes available for reuse.

Destroying a communicator implicitly destroys all of its object adapters. Invoking `destroy` on an adapter is only necessary when you need to ensure that its resources are released prior to the destruction of its communicator.

Placing an adapter into the holding state is useful, for example, if you need to make state changes in the server that require the server (or a group of servants) to be idle. For example, you could place the implementation of your servants into a dynamic library and upgrade the implementation by loading a newer version of the library at run time without having to shut down the server.

Similarly, waiting for an adapter to complete its transition to the inactive state is useful if your server needs to perform some final clean-up work that cannot be carried out until all executing requests have completed.

Note that you can create an object adapter with the same name as a previous object adapter, but only once `destroy` on the previous adapter has completed.

See Also

- [Location Transparency](#)
- [Bidirectional Connections](#)

Object Adapter Endpoints

An object adapter maintains two sets of transport endpoints. One set identifies the network interfaces on which the adapter listens for new connections, and the other set is embedded in proxies created by the adapter and used by clients to communicate with it. We will refer to these sets of endpoints as the *physical endpoints* and the *published endpoints*, respectively. In most cases these sets are identical, but there are situations when they must be configured independently.

On this page:

- [Physical Object Adapter Endpoints](#)
- [Published Object Adapter Endpoints](#)
- [Refreshing Object Adapter Endpoints](#)
- [Timeouts in Object Adapter Endpoints](#)
- [Discovering Object Adapter Endpoints](#)
- [A Router's Effect on Object Adapter Endpoints](#)

Physical Object Adapter Endpoints

An object adapter's physical endpoints identify the network interfaces on which it receives requests from clients. These endpoints are configured via the `name.Endpoints` property, or they can be specified explicitly when [creating an adapter](#) using the operation `createObjectAdapterWithEndpoints`. The [endpoint syntax](#) generally consists of a transport protocol followed by an optional host name and port.

If a host name is specified, the object adapter listens only on the network interface associated with that host name. If no host name is specified but the property `Ice.Default.Host` is defined, the object adapter uses the property's value as the host name. Finally, if a host name is not specified, and the property `Ice.Default.Host` is undefined, the object adapter listens on all available network interfaces, including the loopback interface. You may also force the object adapter to listen on all interfaces by using one of the host names `0.0.0.0` or `*`. The adapter does *not* expand the list of interfaces when it is initialized. Instead, if no host is specified, or you use `-h *` or `-h 0.0.0.0`, the adapter binds to `INADDR_ANY` to listen for incoming requests.

If you want an adapter to accept requests on certain network interfaces, you must specify a separate endpoint for each interface. For example, the following property configures a single endpoint for the adapter named `MyAdapter`:

```
MyAdapter.Endpoints=tcp -h 10.0.1.1 -p 9999
```

This endpoint causes the adapter to accept requests on the network interface associated with the IP address `10.0.1.1` at port `9999`. Note however that this adapter configuration does not accept requests on the loopback interface (the one associated with address `127.0.0.1`). If both addresses must be supported, then both must be specified explicitly, as shown below:

```
MyAdapter.Endpoints=tcp -h 10.0.1.1 -p 9999:tcp -h 127.0.0.1 -p 9999
```

If these are the only two network interfaces available on the host, then a simpler configuration omits the host name altogether, causing the object adapter to listen on both interfaces automatically:

```
MyAdapter.Endpoints=tcp -p 9999
```

If you want to make your configuration more explicit, you can use one of the special host names mentioned earlier:

```
MyAdapter.Endpoints=tcp -h * -p 9999
```

One advantage of this last example is that it ensures the object adapter *always* listens on all interfaces, even if a definition for `Ice.Default.Host` is later added to your configuration. Without an explicit host name, the addition of `Ice.Default.Host` could potentially change the

interfaces on which the adapter is listening. For diagnostic purposes, you can determine the set of local addresses that Ice substitutes for the wildcard address by setting the property `Ice.Trace.Network=3` and reviewing the server's log output.

Careful consideration must also be given to the selection of a port for an endpoint. If no port is specified, the adapter uses a port that is selected (essentially at random) by the operating system, meaning the adapter will likely be using a different port each time the server is restarted. Whether that behavior is desirable depends on the application, but in many applications a client has a proxy containing the adapter's endpoint and expects that proxy to remain valid indefinitely. Therefore, an endpoint generally should contain a fixed port to ensure that the adapter is always listening at the same port.

However, there are certain situations where a fixed port is not required. For example, an adapter whose servants are transient does not need a fixed port, because the proxies for those objects are not expected to remain valid past the lifetime of the server process. Similarly, a server using indirect binding via `IceGrid` does not need a fixed port because its port is never published.

Published Object Adapter Endpoints

An object adapter publishes its endpoints in the proxies it creates, but it is not always appropriate to publish the adapter's physical endpoints in a proxy. For example, suppose a server is running on a host in a private network, protected from the public network by a firewall that can forward network traffic to the server. The adapter's physical endpoints must use the private network's address scheme, but a client in the public network would be unable to use those endpoints if they were published in a proxy. In this scenario, the adapter must publish endpoints in its proxies that direct the client to the firewall instead.

The published endpoints are configured using the adapter property `name.PublishedEndpoints`. If this property is not defined, the adapter publishes its physical endpoints by default, with one exception: endpoints for the loopback address (`127.0.0.1`) are not published unless the loopback interface is the only interface, or `127.0.0.1` (or `loopback`) is explicitly listed as an endpoint with the `-h` option. Otherwise, to force the inclusion of loopback endpoints when they would normally be excluded, you must define `name.PublishedEndpoints` explicitly.

As an example, the properties below configure the adapter named `MyAdapter` with physical and published endpoints:

```
MyAdapter.Endpoints=tcp -h 10.0.1.1 -p 9999
MyAdapter.PublishedEndpoints=tcp -h corpfw -p 25000
```

This example assumes that clients connecting to host `corpfw` at port `25000` are forwarded to the adapter's endpoint in the private network.

Another use case of published endpoints is for replicated servers. Suppose we have two instances of a stateless server running on separate hosts in order to distribute the load between them. We can supply the client with a bootstrap proxy containing the endpoints of both servers, and the Ice run time in the client will select one of the servers at random when a connection is established. However, should the client invoke an operation on a server that returns a proxy for another object, that proxy would normally contain only the endpoint of the server that created it. Invocations on the new proxy would always be directed at the same server, reducing the opportunity for load balancing.

We can alleviate this situation by configuring the adapters to publish the endpoints of both servers. For example, here is a configuration for the server on host `Sun1`:

```
MyAdapter.Endpoints=tcp -h Sun1 -p 9999
MyAdapter.PublishedEndpoints=tcp -h Sun1 -p 9999:tcp -h Sun2 -p 9999
```

Similarly, the configuration for host `Sun2` retains the same published endpoints:

```
MyAdapter.Endpoints=tcp -h Sun2 -p 9999
MyAdapter.PublishedEndpoints=tcp -h Sun1 -p 9999:tcp -h Sun2 -p 9999
```

For troubleshooting purposes, you can examine the published endpoints for an object adapter by setting the property `Ice.Trace.Network`

=3. Note however that this setting generates significant trace information about the Ice run time's network activity, therefore you may not want to use this setting by default.

Refreshing Object Adapter Endpoints

A host's network interfaces may change over time, for example, if a laptop moves in and out of range of a wireless network. The object adapter provides an operation to refresh its list of interfaces:

```

Slice

local interface ObjectAdapter {
    void refreshPublishedEndpoints();
    // ...
};
```

Calling `refreshPublishedEndpoints` causes the object adapter to update its internal list of available network interfaces and to use this updated information in the `name.PublishedEndpoints` property. This allows you to react to changing network interfaces while an object adapter is in use, but your application code is responsible for determining when it is necessary to call this operation.

Note that `refreshPublishedEndpoints` takes effect only for object adapters that specify published endpoints without a host, or that set the published endpoints to `-h *` or `-h 0.0.0.0`.

Timeouts in Object Adapter Endpoints

As a defense against hostile clients, we recommend that you specify a timeout for your physical object adapter endpoints. The timeout value you select affects tasks that the Ice run time normally does not expect to block for any significant amount of time, such as writing a reply message to a socket or waiting for SSL negotiation to complete. If you do not specify a timeout, the Ice run time waits indefinitely in these situations. As a result, malicious or misbehaving clients could consume excessive resources such as file descriptors.

Specifying a timeout in an object adapter endpoint is done exactly as in a proxy endpoint, using the `-t` option:

```
MyAdapter.Endpoints=tcp -p 9999 -t 5000
```

In this example, we specify a timeout of five seconds.

Discovering Object Adapter Endpoints

The object adapter provides operations for retrieving the physical and published endpoints:

Slice

```
module Ice {
  local interface ObjectAdapter {
    // ...

    EndpointSeq getEndpoints();
    EndpointSeq getPublishedEndpoints();

    // ...
  };
};
```

The sequences that are returned contain [Endpoint](#) objects representing the adapter's physical and published endpoints, respectively.

A Router's Effect on Object Adapter Endpoints

If an object adapter is configured with a router, the adapter's published endpoints are augmented to reflect the router. See [Glacier2](#) for more information on configuring an adapter with a router.

See Also

- [Proxy and Endpoint Syntax](#)
- [Ice Object Adapter Properties](#)
- [Ice Default and Override Properties](#)
- [IceGrid](#)
- [Using Connections](#)
- [Communicators](#)
- [Glacier2](#)

Creating Proxies with an Object Adapter

Proxies are created as a side-effect of using the [servant activation operations](#), but the [life cycle](#) of proxies is completely independent from that of servants. The `ObjectAdapter` interface provides several operations for creating a proxy for an object, regardless of whether a servant is currently activated for that object's [identity](#):

```

Slice

module Ice {
    local interface ObjectAdapter {
        // ...

        Object* createProxy(Identity id);
        Object* createDirectProxy(Identity id);
        Object* createIndirectProxy(Identity id);

        // ...
    };
};

```

These operations are described below:

- `createProxy`

The `createProxy` operation returns a new proxy for the object with the given identity. The adapter's configuration determines whether the return value is a [direct proxy](#) or an [indirect proxy](#). If the adapter is configured with an [adapter ID](#), the operation returns an indirect proxy that refers to the adapter ID. If the adapter is also configured with a [replica group ID](#), the operation returns an indirect proxy that refers to the replica group ID. Otherwise, if an adapter ID is not defined, `createProxy` returns a direct proxy containing the adapter's [published endpoints](#).

- `createDirectProxy`

The `createDirectProxy` operation returns a direct proxy containing the adapter's [published endpoints](#).

- `createIndirectProxy`

The `createIndirectProxy` operation returns an [indirect proxy](#). If the adapter is configured with an [adapter ID](#), the returned proxy refers to that adapter ID. Otherwise, the proxy refers only to the object's identity.

In contrast to `createProxy`, `createIndirectProxy` does not use the replica group ID. Therefore, the returned proxy always refers to a specific replica.

After using one of the operations discussed above to create a proxy, you will receive a proxy that is configured by default for twoway invocations. If you require the proxy to have a different configuration, you can use the [proxy factory methods](#) to create a new proxy with the desired configuration. As an example, the code below demonstrates how to configure the proxy for oneway invocations:

```

C++

Ice::ObjectAdapterPtr adapter = ...;
Ice::Identity id = ...;
Ice::ObjectPrx proxy = adapter->createProxy(id)->ice_oneway();

```

You can also instruct the object adapter to use a different default proxy configuration by setting the property `name.ProxyOptions`. For

example, the following property causes the object adapter to return proxies that are configured for oneway invocations by default:

```
MyAdapter.ProxyOptions=-o
```

See Also

- [Servant Activation and Deactivation](#)
- [Object Life Cycle](#)
- [Object Identity](#)
- [Terminology](#)
- [Object Adapter Endpoints](#)
- [Object Adapter Replication](#)
- [Proxy Methods](#)
- [Ice Object Adapter Properties](#)

Using Multiple Object Adapters

A typical server rarely needs to use more than one object adapter. If you are considering using multiple object adapters, we suggest that you check whether any of the considerations in the list below apply to your situation:

- You need fine-grained control over which objects are accessible. For example, you could have an object adapter with only secure endpoints to restrict access to some administrative objects, and another object adapter with non-secure endpoints for other objects. Because an object adapter is associated with one or more transport endpoints, you can firewall a particular port, so objects associated with the corresponding endpoint cannot be reached unless the firewall rules are satisfied.
- You need control over the number of threads in the pools for different sets of objects in your application. For example, you may not need concurrency on the objects connected to a particular object adapter, and multiple object adapters, each with its own [thread pool](#), can be useful to solve [deadlocks](#).
- You want to be able to temporarily disable processing new requests for a set of objects. This can be accomplished by placing an object adapter in the [holding state](#).
- You want to set up different request routing when using an Ice router with [Glacier2](#).

If none of the preceding items apply, chances are that you do not need more than one object adapter.

See Also

- [Object Adapter Thread Pools](#)
- [Nested Invocations](#)
- [Object Adapter States](#)
- [Glacier2](#)

Object Identity

On this page:

- [The Ice::Identity Type](#)
- [Syntax for Stringified Identities](#)
- [Identity Helper Functions](#)

The Ice::Identity Type

Each Ice object has an object identity defined as follows:

Slice
<pre> module Ice { struct Identity { string name; string category; }; }; </pre>

As you can see, an object identity consists of a pair of strings, a `name` and a `category`. The complete object identity is the combination of `name` and `category`, that is, for two identities to be equal, both `name` and `category` must be the same. The `category` member is usually the empty string, unless you are using [servant locators](#) or [default servants](#).

 [Glacier2](#) also uses the `category` member for filtering.

If `name` is an empty string, `category` must be the empty string as well. (An identity with an empty `name` and a non-empty `category` is illegal.) If a proxy contains an identity in which `name` is empty, Ice interprets that proxy as a null proxy.

Object identities can be represented as strings; the `category` part appears first and is followed by the `name`; the two components are separated by a `/` character, for example:

```
Factory/File
```

In this example, `Factory` is the `category`, and `File` is the `name`. If the `name` or `category` member themselves contain a `/` character, the stringified representation escapes the `/` character with a `\`, for example:

```
Factories\Factory/Node\File
```

In this example, the `category` is `Factories/Factory` and the `name` is `Node/File`.

Syntax for Stringified Identities

You rarely need to write identities as strings because, typically, your code will be using the [identity helper functions](#) `identityToString` and `stringToIdentity`, or simply deal with proxies instead of identities. However, on occasion, you will need to use stringified identities in configuration files. If the identities happen to contain meta-characters (such as a slash or backslash), or characters outside the printable ASCII range, these characters must be escaped in the stringified representation. Here are rules that the Ice run time applies when parsing a stringified identity:

1. The parser scans the stringified identity for an un?escaped slash character (/). If such a slash character can be found, the substrings to the left and right of the slash are parsed as the `category` and `name` members of the identity, respectively; if no such slash character can be found, the entire string is parsed as the `name` member of the identity, and the `category` member is the empty string.
2. Each of the `category` (if present) and `name` substrings is parsed according to the following rules:
 - All characters in the string must be in the ASCII range 32 (space) to 126 (~); characters outside this range cause the parse to fail.
 - Any character that is not part of an escape sequence is treated as that character.
 - The parser recognizes the following escape sequences and replaces them with their equivalent character:
 - `\\` (backslash)
 - `\'` (single quote)
 - `\"` (double quote)
 - `\b` (space)
 - `\f` (form feed)
 - `\n` (new line)
 - `\r` (carriage return)
 - `\t` (tab)
 - An escape sequence of the form `\o`, `\oo`, or `\ooo` (where `o` is a digit in the range 0 to 7) is replaced with the ASCII character with the corresponding octal value. Parsing for octal digits allows for at most three consecutive digits, so the string `\0763` is interpreted as the character with octal value 76 (>) followed by the character 3. Parsing for octal digits terminates as soon as it encounters a character that is not in the range 0 to 7, so `\7x` is the character with octal value 7 (bell) followed by the character `x`. Octal escape sequences must be in the range 0 to 255 (octal 000 to 377); escape sequences outside this range cause a parsing error. For example, `\539` is an illegal escape sequence.
 - If a character follows a backslash, but is not part of a recognized escape sequence, the backslash is ignored, so `\x` is the character `x`.

Identity Helper Functions

To make conversion of identities to and from strings easier, the `Communicator` interface provides appropriate conversion functions:

Slice

```

local interface Communicator {
    string identityToString(Identity id);
    Identity stringToIdentity(string id);
};

```

For C++, Ruby, and PHP, the operations on the communicator are the only way to convert between identities and strings. For other languages, the conversion functions are provided as operations on the communicator as well but, in addition, the language mappings provide static utility functions. (The utility functions have the advantage that you can call them without holding a reference to the communicator.)



For C++, the static utility functions are not provided due to the need to apply string conversions, and the [string converters](#) are registered on the communicator.

For Java, the utility functions are in the `Ice.Util` class and are defined as:

Java

```
package Ice;

public final class Util {
    public static String  identityToString(Identity id);
    public static Identity stringToIdentity(String s);
}
```

For C#, the utility functions are in the `Ice.Util` class and are defined as:

C#

```
namespace Ice
{
    public sealed class Util
    {
        public static string  identityToString(Identity id);
        public static Identity stringToIdentity(string s);
    }
}
```

The Python functions are in the `Ice` module:

Python

```
def identityToString(ident)
def stringToIdentity(str)
```

These functions correctly encode and decode characters that might otherwise cause problems (such as control characters).

As mentioned in [Servant Activation and Deactivation](#), each entry in the ASM for an object adapter must be unique: you cannot add two servants with the same identity to the ASM.

See Also

- [Servant Activation and Deactivation](#)
- [Servant Locators](#)
- [Default Servants](#)
- [C++ Strings and Character Encoding](#)
- [Glacier2](#)

The Current Object

Up to now, we have tacitly ignored the trailing parameter of type `Ice::Current` that is passed to each skeleton operation on the server side. The `Current` structure is defined as follows:

Slice

```

module Ice {
    local dictionary<string, string> Context;

    enum OperationMode { Normal, \Idempotent };

    local struct Current {
        ObjectAdapter    adapter;
        Connection        con;
        Identity          id;
        string            facet;
        string            operation;
        OperationMode    mode;
        Context           ctx;
        int               requestId;
        EncodingVersion  encoding;
    };
};

```

Note that the `Current` value provides access to information about the currently executing request to the implementation of an operation in the server:

- `adapter`
The `adapter` member provides access to the object adapter via which the request is being dispatched. In turn, the adapter provides access to its communicator (via the `getCommunicator` operation).
- `con`
The `con` member provides information about the `connection` over which this request was received.
- `id`
The `id` member provides the `object identity` for the current request.
- `facet`
The `facet` member provides access to the `facet` for the request.
- `operation`
The `operation` member contains the name of the operation that is being invoked. Note that the operation name may indicate one of the `operations on Ice::Object`, such as `ice_ping` or `ice_isA`. (`ice_isA` is invoked if a client performs a `checkedCast`.)
- `mode`
The `mode` member contains the invocation mode for the operation (`Normal` or `Idempotent`), which influences the `retry behavior` of the Ice run time.
- `ctx`
The `ctx` member contains the current `request context` for the invocation.
- `requestId`
The Ice protocol uses request IDs to associate replies with their corresponding requests. The `requestId` member provides this ID. For oneway requests (which do not have replies), the request ID is 0. For collocated requests (which do not use the Ice protocol),

the request ID is `-1`.

- [encoding](#)
The [encoding](#) version used to encode the input and output parameters.

If you implement your server such that it uses a separate servant for each Ice object, the contents of `Current` are not particularly interesting. (You would most likely access `Current` to read the `adapter` member, for example, to activate or deactivate a servant.) However, as we will see in our discussion of [default servants](#) and [servant locators](#), the `Current` object is essential for more sophisticated (and more scalable) servant implementations.

See Also

- [Object Identity](#)
- [Default Servants](#)
- [Servant Locators](#)
- [Request Contexts](#)
- [Facets and Versioning](#)
- [Using Connections](#)
- [The Ice Protocol](#)

Servant Locators

In a nutshell, a servant locator is a local object that you implement and attach to an [object adapter](#). Once an adapter has a servant locator, it consults its [active servant map \(ASM\)](#) to locate a servant for an incoming request as usual. If a servant for the request can be found in the ASM, the request is dispatched to that servant. However, if the ASM does not have an entry for the [object identity](#) of the request, the object adapter calls back into the servant locator to ask it to provide a servant for the request. The servant locator either:

- locates an existing servant or instantiates a new servant and passes it to the Ice run time, in which case the request is dispatched to that servant, or
- the servant locator indicates failure to locate a servant to the Ice run time, in which case the client receives an `ObjectNotExistException`.

This simple mechanism allows us to scale servers to provide access to an unlimited number of Ice objects. For example, instead of instantiating a separate servant for each and every Ice object in existence, the server can instantiate servants only for those Ice objects that are actually used by clients. Similar to a [Default Servant](#), the server can also instantiate only one single servant that the locator returns for a group of Ice objects with similar properties.

Servant locators are most commonly used by servers that provide access to databases: typically, the number of entries in the database is far larger than what the server can hold in memory. Servant locators allow the server to only instantiate servants for those Ice objects that are actually used by clients.

Another common use for servant locators is in servers that are used for process control or network management: in that case, there is no database but, instead, there is a potentially very large number of devices or network elements that must be controlled via the server. Otherwise, this scenario is the same as for large databases: the number of Ice objects exceeds the number of servants that the server can hold in memory and, therefore, requires an approach that allows the number of instantiated servants to be less than the number of Ice objects.

Topics

- [The ServantLocator Interface](#)
- [Threading Guarantees for Servant Locators](#)
- [Registering a Servant Locator](#)
- [Servant Locator Example](#)
- [Using Identity Categories with Servant Locators](#)
- [Using Cookies with Servant Locators](#)

See Also

- [Object Adapters](#)
- [The Active Servant Map](#)
- [Object Identity](#)
- [Object Life Cycle](#)
- [Default Servants](#)

The ServantLocator Interface

A servant locator has the following interface:

```

Slice



```

module Ice {
 local interface ServantLocator {
 ["UserException"]
 Object locate(Current curr, out LocalObject cookie);

 ["UserException"]
 void finished(Current curr, Object servant, LocalObject cookie);

 void deactivate(string category);
 };
};

```

```

Note that `ServantLocator` is a [local interface](#). To create an actual implementation of a servant locator, you must define a class that is derived from `Ice::ServantLocator` and provide implementations of the `locate`, `finished`, and `deactivate` operations. The Ice run time invokes the operations on your derived class as follows:

- `locate`

Whenever a request arrives for which no entry exists in the [active servant map \(ASM\)](#), the Ice run time calls `locate` and supplies the `Current` object for the request. The implementation of `locate` (which you provide as part of the derived class) is supposed to return a servant that can process the incoming request. Your implementation of `locate` can behave in three possible ways:

This page contains macros or features from a plugin which requires a valid license.

You will need to:

1. Install the [Plugin Licensing Manager](#).
2. Visit the Plugin Licensing Manager and acquire the necessary licenses.

[Licensing Help?](#)

The Adaptavist Content Formatting Macros plugin requires a license.

This page contains macros or features from a plugin which requires a valid license.

You will need to:

- a. Install the [Plugin Licensing Manager](#).
- b. Visit the Plugin Licensing Manager and acquire the necessary licenses.

[Licensing Help?](#)

The Adaptavist Content Formatting Macros plugin requires a license.

1. Locate an existing or instantiate a new servant, and return this servant for the current request. In this case, the Ice run time dispatches the request to this servant.

This page contains macros or features from a plugin which requires a valid license.

You will need to:

- a. Install the [Plugin Licensing Manager](#).

- b. Visit the Plugin Licensing Manager and acquire the necessary licenses.

[Licensing Help?](#)

The Adaptavist Content Formatting Macros plugin requires a license.

2. Return null. In this case, the Ice run time raises an `ObjectNotExistException` in the client.

This page contains macros or features from a plugin which requires a valid license.

You will need to:

- a. Install the [Plugin Licensing Manager](#).
- b. Visit the Plugin Licensing Manager and acquire the necessary licenses.

[Licensing Help?](#)

The Adaptavist Content Formatting Macros plugin requires a license.

3. Throw a run-time exception. In this case, the Ice run time propagates the thrown exception back to the client. Keep in mind that all run-time exceptions, apart from `ObjectNotExistException`, `OperationNotExistException`, and `FacetNotExistException`, are presented as `UnknownLocalException` to the client.

You can also throw user exceptions from `locate`. If the user exception is in the corresponding operation's exception specification, that user exception is returned to the client. User exceptions thrown by `locate` that are not listed in the exception specification of the corresponding operation are also returned to the client, and then thrown in the client as `UnknownUserException`. Non-Ice exceptions are returned to the client as `UnknownException`.

The `cookie` out-parameter to `locate` allows you to return a local object to the object adapter. The object adapter does not care about the contents of that object (and it is legal to return a null cookie). Instead, the Ice run time passes whatever cookie you return from `locate` back to you when it calls `finished`. This allows you to pass an arbitrary amount of state from `locate` to the corresponding call to `finished`.

- `finished`

If a call to `locate` has returned a servant to the Ice run time, the Ice run time dispatches the incoming request to the servant. Once the request is complete (that is, the operation being invoked has completed), the Ice run time calls `finished`, passing the servant whose operation has completed, the `Current` object for the request, and the cookie that was initially created by `locate`. This means that every call to `locate` is balanced by a corresponding call to `finished` (provided that `locate` actually returned a servant).

If you throw an exception from `finished`, the Ice run time propagates the thrown exception back to the client. As for `locate`, you can throw user exceptions from `finished`. If a user exception is in the corresponding operation's exception specification, that user exception is returned to the client. User exceptions that are not in the corresponding operation's exception specification are also returned to the client, and then thrown by the client as `UnknownUserException`.

`finished` can also throw [run-time exceptions](#). However, only `ObjectNotExistException`, `OperationNotExistException`, and `FacetNotExistException` are propagated without change to the client; other run-time exceptions are returned to the client as `UnknownLocalException`.

Non-Ice exceptions thrown from `finished` are returned to the client as `UnknownException`.

If both the operation implementation and `finished` throw a user exception, the exception thrown by `finished` overrides the exception thrown by the operation.

- `deactivate`

The `deactivate` operation allows a servant locator to clean up once it is no longer needed. (For example, the locator might close a database connection.) The Ice run time passes the category of the servant locator being deactivated to the `deactivate` operation.

The run time calls `deactivate` when destroying the object adapter to which the servant locator is attached. More precisely, `deactivate` is called when you call `destroy` on the object adapter, or when you call `destroy` on the communicator (which implicitly calls `destroy` on the object adapter).

Once the run time has called `deactivate`, it is guaranteed that no further calls to `locate` or `finished` can happen, that is, `deactivate` is called exactly once, after all operations dispatched via this servant locator have completed.

This also explains why `deactivate` is not called as part of `ObjectAdapter::deactivate`: `ObjectAdapter::deactivate` initiates `deactivation` and returns immediately, so it cannot call `ServantLocator::deactivate` directly, because there might still be outstanding requests dispatched via this servant locator that have to complete first — in turn, this would mean that either `ObjectAdapter::deactivate` could block (which it must not do) or that a call to `ServantLocator::deactivate` could be followed by one or more calls to `finished` (which must not happen either).

It is important to realize that the Ice run time does not "remember" the servant that is returned by a particular call to `locate`. Instead, the Ice run time simply dispatches an incoming request to the servant returned by `locate` and, once the request is complete, calls `finished`. In particular, if two requests for the same servant arrive more or less simultaneously, the Ice run time calls `locate` and `finished` once for each request. In other words, `locate` establishes the association between an object identity and a servant; that association is valid only for a single request and is never used by the Ice run time to dispatch a different request.

See Also

- [The Active Servant Map](#)
- [The Current Object](#)
- [Run-Time Exceptions](#)
- [Object Adapter States](#)

Threading Guarantees for Servant Locators

The Ice run time guarantees that every operation invocation that involves a [servant locator](#) is bracketed by calls to `locate` and `finished`, that is, every call to `locate` is balanced by a corresponding call to `finished` (assuming that the call to `locate` actually returned a servant, of course).

In addition, the Ice run time guarantees that `locate`, the operation, and `finished` are called by the same thread. This guarantee is important because it allows you to use `locate` and `finished` to implement thread-specific pre- and post-processing around operation invocations. (For example, you can start a transaction in `locate` and commit or roll back that transaction in `finished`, or you can acquire a lock in `locate` and release the lock in `finished`.)

 Both transactions and locks usually are thread-specific, that is, only the thread that started a transaction can commit it or roll it back, and only the thread that acquired a lock can release the lock.

 If you are using [asynchronous method dispatch](#), the thread that starts a call is not necessarily the thread that finishes it. In that case, `finished` is called by whatever thread executes the operation implementation, which may be a different thread than the one that called `locate`.

The Ice run time also guarantees that `deactivate` is called when you destroy the object adapter to which the servant locator is attached. The `deactivate` call is made only once all operations that involved the servant locator are finished, that is, `deactivate` is guaranteed not to run concurrently with `locate` or `finished`, and is guaranteed to be the last call made to a servant locator.

Beyond this, the Ice run time provides no threading guarantees for servant locators. In particular, it is possible for invocations of:

- `locate` to proceed concurrently (for the same object identity or for different object identities).
- `finished` to proceed concurrently (for the same object identity or for different object identities).
- `locate` and `finished` to proceed concurrently (for the same object identity or for different object identities).

These semantics allow you to extract the maximum amount of parallelism from your application code (because the Ice run time does not serialize invocations when serialization may not be necessary). Of course, this means that you must [protect access to shared data](#) from `locate` and `finished` with mutual exclusion primitives as necessary.

See Also

- [The ServantLocator Interface](#)
- [The Ice Threading Model](#)

Registering a Servant Locator

On this page:

- [Servant Locator Registration](#)
- [Call Dispatch Semantics for Servant Locators](#)

Servant Locator Registration

An [object adapter](#) does not automatically know when you create a [servant locator](#). Instead, you must explicitly register a servant locator with the object adapter:

```

Slice

module Ice {
    local interface ObjectAdapter {
        // ...

        void addServantLocator(ServantLocator locator, string category);

        ServantLocator removeServantLocator(string category);

        ServantLocator findServantLocator(string category);

        // ...
    };
};

```

As you can see, the object adapter allows you to add, remove, and find servant locators. Note that, when you register a servant locator, you must provide an argument for the `category` parameter. The value of the `category` parameter controls which [object identities](#) the servant locator is responsible for: only object identities with a matching `category` member trigger a corresponding call to `locate`. An incoming request for which no explicit entry exists in the [active servant map \(ASM\)](#) and with a category for which no servant locator is registered returns an `ObjectNotExistException` to the client.

`addServantLocator` has the following semantics:

- You can register exactly one servant locator for a specific category. Attempts to call `addServantLocator` for the same category more than once raise an `AlreadyRegisteredException`.
- You can register different servant locators for different categories, or you can register the same single servant locator multiple times (each time for a different category). In the former case, the category is implicit in the servant locator instance that is called by the Ice run time; in the latter case, the implementation of `locate` can find out which category the incoming request is for by examining the object identity member of the [Current](#) object that is passed to `locate`.
- It is legal to register a servant locator for the empty category. Such a servant locator is known as a *default servant locator*: if a request comes in for which no entry exists in the ASM, and whose category does not match the category of any other registered servant locator, the Ice run time calls `locate` on the default servant locator.

`removeServantLocator` removes and returns the servant locator for a specific category (including the empty category) with the following semantics:

- If no servant locator is registered for the specified category, the operation raises `NotRegisteredException`.
- Once a servant locator is successfully removed for the specified category, the Ice run time guarantees that no new incoming requests for that category are dispatched to the servant locator.
- A call to `removeServantLocator` returns immediately without waiting for the completion of any pending requests on that servant locator; such requests still complete normally by calling `finished` on the servant locator.
- Removing a servant locator does not cause Ice to invoke `deactivate` on that servant locator, as `deactivate` is only called when a registered servant locator's object adapter is destroyed.

`findServantLocator` allows you to retrieve the servant locator for a specific category (including the empty category). If no match is found, the operation returns null.

Call Dispatch Semantics for Servant Locators

The preceding rules may seem complicated, so here is a summary of the actions taken by the Ice run time to locate a servant for an incoming request.

Every incoming request implicitly identifies a specific object adapter for the request (because the request arrives at a specific transport endpoint and, therefore, identifies a particular object adapter). The incoming request carries an object identity that must be mapped to a servant. To locate a servant, the Ice run time goes through the following steps, in the order shown:

1. Look for the identity in the ASM. If the ASM contains an entry, dispatch the request to the corresponding servant.
2. If the category of the incoming object identity is non-empty, look for a [default servant](#) that is registered for that category. If such a default servant is registered, dispatch the request to that servant.
3. If the category of the incoming object identity is empty, or no default servant could be found for the category in step 2, look for a default servant that is registered for the empty category. If such a default servant is registered, dispatch the request to that servant.
4. If the category of the incoming object identity is non-empty and no servant could be found in the preceding steps, look for a servant locator that is registered for that category. If such a servant locator is registered, call `locate` on the servant locator and, if `locate` returns a servant, dispatch the request to that servant, followed by a call to `finished`; otherwise, if the call to `locate` returns null, raise `ObjectNotExistException` or `FacetNotExistException` in the client.
5. If the category of the incoming object identity is empty, or no servant locator could be found for the category in step 4, look for a default servant locator (that is, a servant locator that is registered for the empty category). If a default servant locator is registered, dispatch the request as for step 4.
6. Raise `ObjectNotExistException` or `FacetNotExistException` in the client. (`ObjectNotExistException` is raised if the ASM does not contain a servant with the given identity at all, `FacetNotExistException` is raised if the ASM contains a servant with a matching identity, but a non-matching [facet](#).)

It is important to keep these call dispatch semantics in mind because they enable a number of powerful implementation techniques. Each technique allows you to streamline your server implementation and to precisely control the trade-off between performance, memory consumption, and scalability. To illustrate the possibilities, we will outline a number of the most common implementation techniques.

See Also

- [Object Adapters](#)
- [Object Identity](#)
- [The Active Servant Map](#)
- [Default Servants](#)
- [Facets and Versioning](#)
- [Servant Locator Example](#)

Servant Locator Example

To illustrate the [servant locator](#) concepts outlined so far, let us examine a (very simple) implementation. Consider that we want to create an electronic phone book for the entire world's telephone system (which, clearly, involves a very large number of entries, certainly too many to hold the entire phone book in memory). The actual phone book entries are kept in a large database. Also assume that we have a search operation that returns the details of a phone book entry. The Slice definitions for this application might look something like the following:

Slice
<pre> struct Details { // Lots of details about the entry here... }; interface PhoneEntry { idempotent Details getDetails(); idempotent void updateDetails(Details d); // ... }; struct SearchCriteria { // Fields to permit searching... }; interface PhoneBook { idempotent PhoneEntry* search(SearchCriteria c); // ... }; </pre>

The details of the application do not really matter here; the important point to note is that each phone book entry is represented as an interface for which we need to create a servant eventually, but we cannot afford to keep servants for all entries permanently in memory.

Each entry in the phone database has a unique identifier. This identifier might be an internal database identifier, or a combination of field values, depending on exactly how the database is constructed. The important point is that we can use this database identifier to link the [proxy](#) for an Ice object to its persistent state: we simply use the database identifier as the [object identity](#). This means that each proxy contains the primary access key that is required to locate the persistent state of each Ice object and, therefore, instantiate a servant for that Ice object.

What follows is an outline implementation in C++. The class definition of our servant locator looks as follows:

C++

```

class MyServantLocator : public virtual Ice::ServantLocator {
public:

    virtual Ice::ObjectPtr locate(const Ice::Current& c,
Ice::LocalObjectPtr& cookie);

    virtual void finished(const Ice::Current& c,
const Ice::ObjectPtr& servant,
                        const Ice::LocalObjectPtr& cookie);

    virtual void deactivate(const std::string& category);
};

```

Note that `MyServantLocator` inherits from `Ice::ServantLocator` and implements the pure virtual functions that are generated by the `slice2cpp` compiler for the `Ice::ServantLocator` interface. Of course, as always, you can add additional member functions, such as a constructor and destructor, and you can add private data members as necessary to support your implementation.

In C++, you can implement the `locate` member function along the following lines:

C++

```

Ice::ObjectPtr
MyServantLocator::locate(const Ice::Current& c,
Ice::LocalObjectPtr& cookie)
{
    // Get the object identity. (We use the name member
    // as the database key.)
    //
    std::string name = c.id.name;

    // Use the identity to retrieve the state from the database.
    //
    ServantDetails d;
    try {
        d = DB_lookup(name);
    } catch (const DB_error&)
        return 0;
    }

    // We have the state, instantiate a servant and return it.
    //
    return new PhoneEntryI(d);
}

```

For the time being, the implementations of `finished` and `deactivate` are empty and do nothing.

The `DB_lookup` call in the preceding example is assumed to access the database. If the lookup fails (presumably, because no matching

record could be found), `DB_lookup` throws a `DB_error` exception. The code catches that exception and returns zero instead; this raises `ObjectNotExistException` in the client to indicate that the client used a proxy to a [no-longer existent Ice object](#).

Note that `locate` instantiates the servant on the heap and returns it to the Ice run time. This raises the question of when the servant will be destroyed. The answer is that the Ice run time holds onto the servant for as long as necessary, that is, long enough to invoke the operation on the returned servant and to call `finished` once the operation has completed. Thereafter, the servant is no longer needed and the Ice run time destroys the smart pointer that was returned by `locate`. In turn, because no other smart pointers exist for the same servant, this causes the destructor of the `PhoneEntryI` instance to be called, and the servant to be destroyed.

The upshot of this design is that, for every incoming request, we instantiate a servant and allow the Ice run time to destroy the servant once the request is complete. Depending on your application, this may be exactly what is needed, or it may be prohibitively expensive — we will explore designs that avoid creation and destruction of a servant for every request shortly.

In Java, the implementation of our servant locator looks very similar:

Java

```
public class MyServantLocator implements Ice.ServantLocator {

    public Ice.Object locate(Ice.Current c,
Ice.LocalObjectHolder cookie)
    {
        // Get the object identity. (We use the name member
        // as the database key.
        String name = c.id.name;

        // Use the identity to retrieve the state
        // from the database.
        //
        ServantDetails d;
        try {
            d = DB.lookup(name);
        } catch (DB.error e) {
            return null;
        }

        // We have the state, instantiate a servant and return it.
        //
        return new PhoneEntryI(d);
    }

    public void finished(Ice.Current c, Ice.Object servant,
java.lang.Object cookie)
    {
    }

    public void deactivate(String category)
    {
    }
}
```





The C# implementation is virtually identical to the Java implementation, so we do not show it here.

All implementations of `locate` follow the pattern illustrated by the previous pseudo-code:

1. Use the `id` member of the passed `Current` object to obtain the object identity. Typically, only the `name` member of the identity is used to retrieve servant state. The `category` member is normally used to select a servant locator. (We will explore [use of the category member](#) shortly.)
2. Retrieve the state of the Ice object from secondary storage (or the network) using the object identity as a key.
 - If the lookup succeeds, you have retrieved the state of the Ice object.
 - If the lookup fails, return null. In that case, the Ice object for the client's request truly does not exist, presumably, because that Ice object was deleted earlier, but the client still has a proxy to the now-deleted object.
3. Instantiate a servant and use the state retrieved from the database to initialize the servant. (In this example, we pass the retrieved state to the servant constructor.)
4. Return the servant.

Of course, before we can use our servant locator, we must inform the adapter of its existence prior to activating the adapter, for example (in Java or C#):

```
MyServantLocator sl = new MyServantLocator();
adapter.addServantLocator(sl, "");
```

Note that, in this example, we have installed the servant locator for the empty category. This means that `locate` on our servant locator will be called for invocations to any of our Ice objects (because the empty category acts as the default). In effect, with this design, we are not using the `category` member of the object identity. This is fine, as long as all our servants all have the same, single interface. However, if we need to support several different interfaces in the same server, this simple strategy is no longer sufficient.

See Also

- [Servant Locators](#)
- [Object Identity](#)
- [Object Life Cycle](#)
- [The Current Object](#)
- [Using Identity Categories with Servant Locators](#)

Using Identity Categories with Servant Locators

Our [simple example](#) always instantiates a servant of type `PhoneEntryI`. In other words, the servant locator implicitly is aware of the type of servant the incoming request is for. This is not a very realistic assumption for most servers because, usually, a server provides access to objects with several different interfaces. This poses a problem for our `locate` implementation: somehow, we need to decide inside `locate` what type of servant to instantiate. You have several options for solving this problem:

- Use a separate object adapter for each interface type and use a separate servant locator for each object adapter.

This technique works fine, but has the down-side that each object adapter requires a separate transport endpoint, which is wasteful.

- Mangle a type identifier into the `name` component of the [object identity](#).

This technique uses part of the object identity to denote what type of object to instantiate. For example, in our file system application, we have directory and file objects. By convention, we could prepend a 'd' to the identity of every directory and prepend an 'f' to the identity of every file. The servant locator then can use the first letter of the identity to decide what type of servant to instantiate:

```

C++



Ice::ObjectPtr
MyServantLocator::locate(const Ice::Current& c,
Ice::LocalObjectPtr& cookie)
{
    // Get the object identity. (We use the name member
    // as the database key.)
    //
    std::string name = c.id.name;
    std::string realId = c.id.name.substr(1);
    try {
        if (name[0] == 'd') {
            // The request is for a directory.
            //
            DirectoryDetails d = DB_lookup(realId);
            return new DirectoryI(d);
        } else {
            // The request is for a file.
            //
            FileDetails d = DB_lookup(realId);
            return new FileI(d);
        }
    } catch (DatabaseNotFoundException&) {
        return 0;
    }
}
```

While this works, it is awkward: not only do we need to parse the `name` member to work out what type of object to instantiate, but we also need to modify the implementation of `locate` whenever we add a new type to our application.

- Use the `category` member of the object identity to denote the type of servant to instantiate.

This is the recommended approach: for every interface type, we assign a separate identifier as the value of the `category` member of the object identity. (For example, we can use 'd' for directories and 'f' for files.) Instead of registering a single servant locator, we

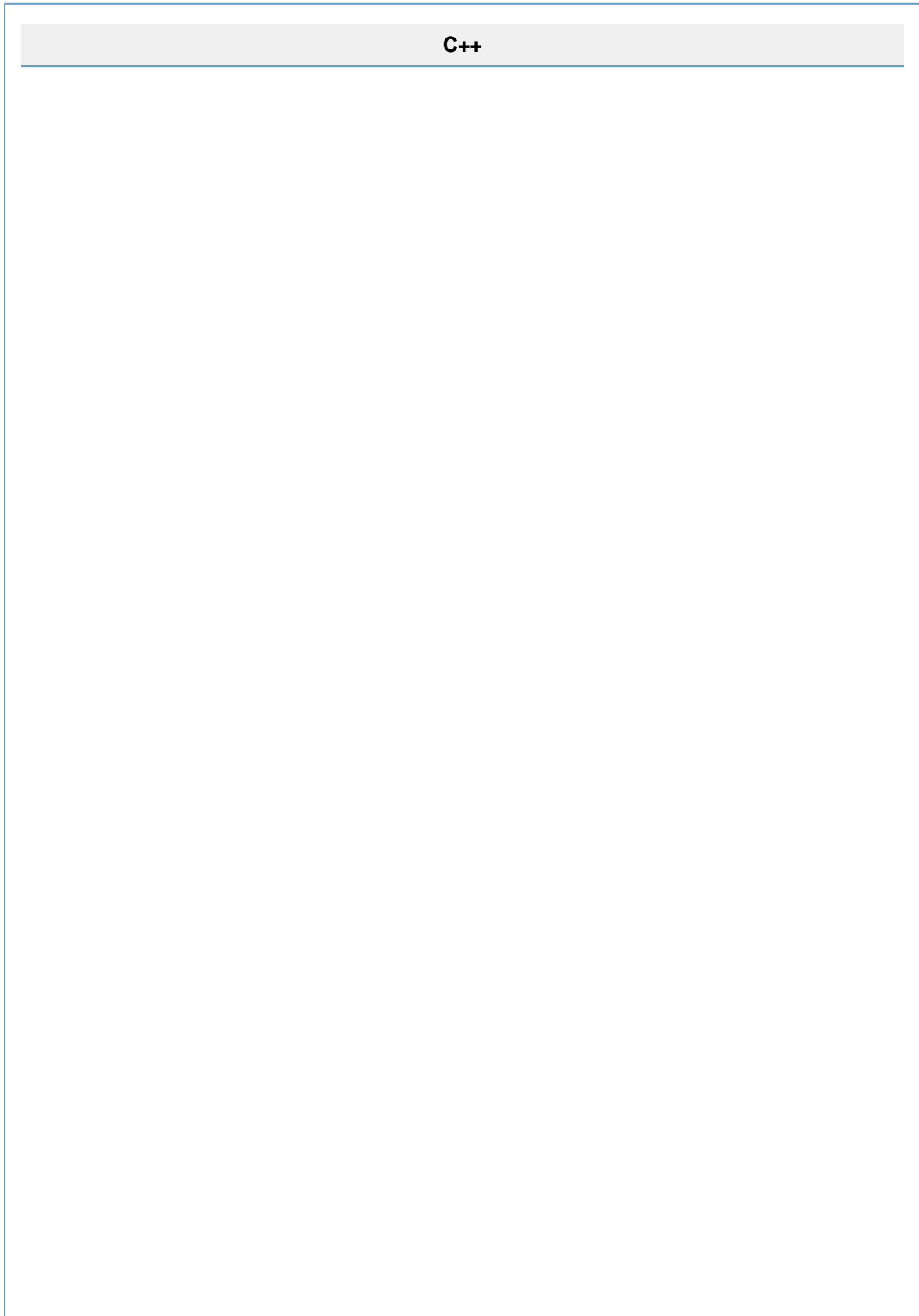
create two different servant locator implementations, one for directories and one for files, and then register each locator for the appropriate category:



```

class DirectoryLocator : public virtual Ice::ServantLocator {
public:

    virtual Ice::ObjectPtr locate(const Ice::Current& c,
Ice::LocalObjectPtr& cookie)
    {
        // Code to locate and instantiate a directory here...
    }

    virtual void finished(const Ice::Current& c,
const Ice::ObjectPtr& servant,
                        const Ice::LocalObjectPtr& cookie)
    {
    }

    virtual void deactivate(const std::string& category)
    {
    }
};

class FileLocator : public virtual Ice::ServantLocator {
public:

    virtual Ice::ObjectPtr locate(const Ice::Current& c, Ice::LocalObjectPtr& cookie)
    {
        // Code to locate and instantiate a file here...
    }

    virtual void finished(const Ice::Current& c,
const Ice::ObjectPtr& servant,
                        const Ice::LocalObjectPtr& cookie)
    {
    }

    virtual void deactivate(const std::string& category)
    {
    }
};

// ...

// Register two locators, one for directories and
// one for files.
//
adapter->addServantLocator(new DirectoryLocator(), "d");
adapter->addServantLocator(new FileLocator(), "f");

```

Yet another option is to use the `category` member of the object identity, but to use a single default servant locator (that is, a locator for the

empty category). With this approach, all invocations go to the single default servant locator, and you can switch on the `category` value inside the implementation of the `locate` operation to determine which type of servant to instantiate. However, this approach is harder to maintain than the previous one; the `category` member of the Ice object identity exists specifically to support servant locators, so you might as well use it as intended.

See Also

- [Servant Locator Example](#)
- [Object Identity](#)

Using Cookies with Servant Locators

Occasionally, it can be useful for a [servant locator](#) to pass information between `locate` and `finished`. For example, the implementation of `locate` could choose among a number of alternative database backends, depending on load or availability and, to properly finalize state, the implementation of `finished` might need to know which database was used by `locate`. To support such scenarios, you can create a cookie in your `locate` implementation; the Ice run time passes the value of the cookie to `finished` after the operation invocation has completed. The cookie must derive from `Ice::LocalObject` and can contain whatever state and member functions are useful to your implementation:

```

C++

class MyCookie : public virtual Ice::LocalObject {
public:
    // Whatever is useful here...
};

typedef IceUtil::Handle<MyCookie> MyCookiePtr;

class MyServantLocator : public virtual Ice::ServantLocator {
public:

    virtual Ice::ObjectPtr locate(const Ice::Current& c,
Ice::LocalObjectPtr& cookie)
    {
        // Code as before...

        // Allocate and initialize a cookie.
        //
        cookie = new MyCookie(...);

        return new PhoneEntryI;
    }

    virtual void finished(const Ice::Current& c,
const Ice::ObjectPtr& servant,
                        const Ice::LocalObjectPtr& cookie)
    {
        // Down-cast cookie to actual type.
        //
        MyCookiePtr mc = MyCookiePtr::dynamicCast(cookie);

        // Use information in cookie to clean up...
        //
        // ...
    }

    virtual void deactivate(const std::string& category);
};
```

See Also

- [Servant Locators](#)

Default Servants

On this page:

- [Overview of Default Servants](#)
- [Default Servant API](#)
- [Threading Guarantees for Default Servants](#)
- [Call Dispatch Semantics for Default Servants](#)
- [Guidelines for Implementing Default Servants](#)
 - [Object Identity is the Key](#)
 - [Minimize Contention](#)
 - [Combine Strategies](#)
 - [Categories Denote Interfaces](#)
 - [Plan for the Future](#)
 - [Throw exceptions](#)
 - [Handle `ice_ping`](#)
 - [Consider Interceptors](#)
 - [Use a `Blobject` Default Servant to Forward Messages](#)

Overview of Default Servants

The *Active Servant Map* (ASM) is a simple lookup table that maintains a one-to-one mapping between object identities and servants. Although the ASM is easy to understand and offers efficient indexing, it does not scale well when the number of objects is very large. Scalability is a common problem with object-oriented middleware: servers frequently are used as front ends to large databases that are accessed remotely by clients. The server's job is to present an object-oriented view to clients of a very large number of records in the database. Typically, the number of records is far too large to instantiate servants for even a fraction of the database records.

A common technique for solving this problem is to use *default servants*. A default servant is a servant that, for each request, takes on the persona of a different Ice object. In other words, the servant changes its behavior according to the *object identity* that is accessed by a request, on a per-request basis. In this way, it is possible to allow clients access to an unlimited number of Ice objects with only a single servant in memory. A default servant is essentially a specialized version of a *servant locator* that satisfies the majority of use cases with a simpler API, whereas a servant locator provides more flexibility for those applications that require it.

Default servant implementations are attractive not only because of the memory savings they offer, but also because of the simplicity of implementation: in essence, a default servant is a facade [1] to the persistent state of an object in the database. This means that the programming required to implement a default servant is typically minimal: it simply consists of the code required to read and write the corresponding database records.

A default servant is a regular servant that you implement and register with an *object adapter*. For each incoming request, the object adapter first attempts to locate a servant in its ASM. If no servant is found, the object adapter dispatches the request to a default servant. With this design, a default servant is the object adapter's servant of last resort if no match was found in the ASM.

Implementing a default servant requires a somewhat different mindset than the typical "one servant per Ice object" strategy used in less advanced applications. The most important quality of a default servant is its statelessness: it must be prepared to dispatch multiple requests simultaneously for different objects. The price we have to pay for the unlimited scalability and reduced memory footprint is performance: default servants typically make a database access for every invoked operation, which is obviously slower than caching state in memory as part of a servant that has been added to the ASM. However, this does not mean that default servants carry an unacceptable performance penalty: databases often provide sophisticated caching, so even though the operation implementations read and write the database, as long as they access cached state, performance may be entirely acceptable.

Default Servant API

The default servant API consists of the following operations in the object adapter interface:

Slice

```

module Ice {
    local interface ObjectAdapter {
        void addDefaultServant(Object servant, string category);
        Object removeDefaultServant(string category);
        Object findDefaultServant(string category);

        // ...
    };
};

```

As you can see, the object adapter allows you to add, remove, and find default servants. Note that, when you register a default servant, you must provide an argument for the `category` parameter. The value of the `category` parameter controls which object identities the default servant is responsible for: only object identities with a matching `category` member trigger a dispatch to this default servant. An incoming request for which no explicit entry exists in the ASM and with a category for which no default servant is registered returns an `ObjectNotExistException` to the client.

`addDefaultServant` has the following semantics:

- You can register exactly one default servant for a specific category. Attempts to call `addDefaultServant` for the same category more than once raise an `AlreadyRegisteredException`.
- You can register different default servants for different categories, or you can register the same single default servant multiple times (each time for a different category). In the former case, the category is implicit in the default servant instance that is called by the Ice run time; in the latter case, the servant can find out which category the incoming request is for by examining the object identity member of the `Current` object that is passed to the dispatched operation.
- It is legal to register a default servant for the empty category. Such a servant is used if a request comes in for which no entry exists in the ASM, and whose category does not match the category of any other registered default servant.

`removeDefaultServant` removes the default servant for the specified category. Attempts to remove a non-existent default servant raise an `NotRegisteredException`. The operation returns the removed default servant. Once a default servant is successfully removed for the specified category, the Ice run time guarantees that no new incoming requests for that category are dispatched to the servant.

The `findDefaultServant` operation allows you to retrieve the default servant for a specific category (including the empty category). If no default servant is registered for the specified category, `findDefaultServant` returns null.

Threading Guarantees for Default Servants

The threading semantics for a default servant are no different than for a servant registered in the ASM: operations may be dispatched on a default servant concurrently, for the same object identity or for different object identities. If you have configured the communicator with multiple `dispatch threads`, your default servant must protect access to shared data with appropriate locks.

Call Dispatch Semantics for Default Servants

This section summarizes the actions taken by the Ice run time to locate a servant for an incoming request.

Every incoming request implicitly identifies a specific object adapter for the request (because the request arrives at a specific `transport endpoint` and, therefore, identifies a particular object adapter). The incoming request carries an object identity that must be mapped to a servant. To locate a servant, the Ice run time goes through the following steps, in the order shown:

1. Look for the identity in the ASM. If the ASM contains an entry, dispatch the request to the corresponding servant.
2. If the category of the incoming object identity is non-empty, look for a default servant that is registered for that category. If such a default servant is registered, dispatch the request to that servant.
3. If the category of the incoming object identity is empty, or no default servant could be found for the category in step 2, look for a

- default servant that is registered for the empty category. If such a default servant is registered, dispatch the request to that servant.
4. If the category of the incoming object identity is non-empty and no servant could be found in the preceding steps, look for a `servant locator` that is registered for that category. If such a servant locator is registered, call `locate` on the servant locator and, if `locate` returns a servant, dispatch the request to that servant, followed by a call to `finished`; otherwise, if the call to `locate` returns null, raise `ObjectNotExistException` or `FacetNotExistException` in the client. (`ObjectNotExistException` is raised if the ASM does not contain a servant with the given identity at all, `FacetNotExistException` is raised if the ASM contains a servant with a matching identity, but a non-matching `facet`.)
 5. If the category of the incoming object identity is empty, or no servant locator could be found for the category in step 4, look for a default servant locator (that is, a servant locator that is registered for the empty category). If a default servant locator is registered, dispatch the request as for step 4.
 6. Raise `ObjectNotExistException` or `FacetNotExistException` in the client. (`ObjectNotExistException` is raised if the ASM does not contain a servant with the given identity at all, `FacetNotExistException` is raised if the ASM contains a servant with a matching identity, but a non-matching `facet`.)

It is important to keep these call dispatch semantics in mind because they enable a number of powerful implementation techniques. Each technique allows you to streamline your server implementation and to precisely control the trade-off between performance, memory consumption, and scalability.

Guidelines for Implementing Default Servants

This section provides some guidelines to assist you in implementing default servants effectively.

Object Identity is the Key

When an incoming request is dispatched to the default servant, the target object identity is provided in the `Current` argument. The `name` field of the identity typically supplies everything the default servant requires in order to satisfy the request. For instance, it may serve as the key in a database query, or even hold an encoded structure in some proprietary format that your application uses to convey more than just a string.

Naturally, the client can also pass arguments to the operation that assist the default servant in retrieving whatever state it requires. However, this approach can easily introduce implementation artifacts into your `Slice` interfaces, and in most cases the client should not need to know that the server is implemented with a default servant. If at all possible, use only the object identity.

Minimize Contention

For better scalability, the default servant's implementation should strive to eliminate contention among the dispatch threads. As an example, when a database holds the default servant's state, each of the servant's operations usually begins with a query. Assuming that the database API is thread-safe, the servant needs to perform no explicit locking of its own. With a copy of the state in hand, the implementation can work with function-local data to satisfy the request.

Combine Strategies

The ASM still plays a useful role even in applications that are ideally suited for default servants. For example, there is no need to implement a singleton object as a default servant: if there can only be one instance of the object, implementing it as a default servant does nothing to improve your application's scalability.

Applications often install a handful of servants in the ASM while servicing the majority of requests in a default servant. For example, a database application might install a singleton query object in the ASM while using a default servant to process all invocations on the database records.

Categories Denote Interfaces

In general, all of the objects serviced by a default servant must have the same interface. If you only need a default servant for one interface, you can register the default servant with an empty category string. However, to implement several interfaces, you will need a default servant implementation for each one. Furthermore, you must take steps to ensure that the object adapter dispatches an incoming request to the appropriate default servant. The `category` field of the object identity is intended to serve this purpose.

For example, a process control system might have interfaces named `Sensor` and `Switch`. To direct requests to the proper default servant,

the application uses the symbol `Sensor` or `Switch` as the category of each object's identity, and registers corresponding default servants having those same categories with the object adapter.

Plan for the Future

If you suspect that you might eventually need to implement more than one interface with default servants, we recommend using a non-empty category even if you start out having only one default servant. Adding another default servant later becomes much easier if the application is already designed to operate correctly with categories.

Throw exceptions

If a request arrives for an object that no longer exists, it is the default servant's responsibility to raise `ObjectNotExistException` to properly manage [object life cycles](#).

Handle `ice_ping`

One issue you need to be aware of with default servants is the need to override `ice_ping`: the default implementation of `ice_ping` that the servant inherits from its skeleton class always succeeds. For servants that are registered with the ASM, this is exactly what we want; however, for default servants, `ice_ping` must fail if a client uses a proxy to an Ice object that **no longer exists**. To avoid getting successful `ice_ping` invocations for non-existent Ice objects, you must override `ice_ping` in the default servant. The implementation must check whether the object identity for the request denotes a still-existing Ice object and, if not, raise `ObjectNotExistException`.

It is good practice to override `ice_ping` if you are using default servants. Because you cannot override operations on `Ice::Object` using a Java or C# tie servant (or an Objective-C delegate servant), you must implement default servants by deriving from the generated skeleton class if you choose to override `ice_ping`.

Consider Interceptors

A [dispatch interceptor](#) is often installed as a default servant.

Use a `Blobject` Default Servant to Forward Messages

Message forwarding services, such as [Glacier2](#), can be implemented simply and efficiently with a `Blobject` default servant. Such a servant simply chooses a destination to forward a request to, without decoding any of the parameters.

See Also

- [The Active Servant Map](#)
- [Object Identity](#)
- [Servant Locators](#)
- [Object Adapters](#)
- [The Current Object](#)
- [The Ice Threading Model](#)
- [Facets and Versioning](#)
- [Dispatch Interceptors](#)
- [Dynamic Invocation and Dispatch Overview](#)
- [Glacier2](#)

References

1. Gamma, E., et al. 1994. [Design Patterns](#). Reading, MA: Addison-Wesley.

Server Implementation Techniques

As mentioned in [Servant Locators](#), instantiating a servant for each Ice object on server start-up is a viable design, provided that you can afford the amount of memory required by the servants, as well as the delay in start-up of the server. However, Ice supports more flexible mappings between Ice objects and servants; these alternate mappings allow you to precisely control the trade-off between memory consumption, scalability, and performance. We outline a few of the more common implementation techniques here.

On this page:

- [Incremental Server Initialization](#)
- [Implementing a Server using Default Servants](#)
 - [Overriding `ice_ping`](#)
- [Combining Server Implementation Techniques](#)

Incremental Server Initialization

If you use a [servant locator](#), the servant returned by `locate` is used only for the current request, that is, the Ice run time does not add the servant to the [Active Servant Map](#) (ASM). Of course, this means that if another request comes in for the same Ice object, `locate` must again retrieve the object state and instantiate a servant. A common implementation technique is to add each servant to the ASM as part of `locate`. This means that only the first request for each Ice object triggers a call to `locate`; thereafter, the servant for the corresponding Ice object can be found in the ASM and the Ice run time can immediately dispatch another incoming request for the same Ice object without having to call the servant locator.

An implementation of `locate` to do this would look something like the following:

C++

```

Ice::ObjectPtr
MyServantLocator::locate(const Ice::Current& c, Ice::LocalObjectPtr&)
{
    // Get the object identity. (We use the name member
    // as the database key.)
    //
    std::string name = c.id.name;

    // Use the identity to retrieve the state from the database.
    //
    ServantDetails d;
    try {
        d = DB_lookup(name);
    } catch (const DB_error&)
        return 0;
    }

    // We have the state, instantiate a servant.
    //
    Ice::ObjectPtr servant = new PhoneEntryI(d);

    // Add the servant to the ASM.
    //
    c.adapter->add(servant, c.id);    // NOTE: Incorrect!

    return servant;
}

```

This is almost identical to the implementation seen in our [earlier example](#) — the only difference is that we also [add the servant to the ASM](#) by calling `ObjectAdapter::add`. Unfortunately, this implementation is wrong because it suffers from a race condition. Consider the situation where we do not have a servant for a particular Ice object in the ASM, and two clients more or less simultaneously send a request for the same Ice object. It is entirely possible for the thread scheduler to schedule the two incoming requests such that the Ice run time completes the lookup in the ASM for both requests and, for each request, concludes that no servant is in memory. The net effect is that `locate` will be called twice for the same Ice object, and our servant locator will instantiate two servants instead of a single servant. Because the second call to `ObjectAdapter::add` will raise an `AlreadyRegisteredException`, only one of the two servants will be added to the ASM.

Of course, this is hardly the behavior we expect. To avoid the race condition, our implementation of `locate` must check whether a concurrent invocation has already instantiated a servant for the incoming request and, if so, return that servant instead of instantiating a new one. The Ice run time provides the `ObjectAdapter::find` operation to allow us to test whether an entry for a specific identity already exists in the ASM:

Slice

```

module Ice {
    local interface ObjectAdapter {
        // ...

        Object find(Identity id);

        // ...
    };
};

```

`find` returns the servant if it exists in the ASM and null, otherwise. Using this lookup function, together with a mutex, allows us to correctly implement `locate`. The class definition of our servant locator now has a private mutex so we can establish a critical region inside `locate`:

C++

```

class MyServantLocator : public virtual Ice::ServantLocator {
public:

    virtual Ice::ObjectPtr locate(const Ice::Current& c,
Ice::LocalObjectPtr&);

    // Declaration of finished() and deactivate() here...

private:
    IceUtil::Mutex _m;
};

```

The `locate` member locks the mutex and tests whether a servant is already in the ASM: if so, it returns that servant; otherwise, it instantiates a new servant and adds it to the ASM as before:

C++

```

Ice::ObjectPtr
MyServantLocator::locate(const Ice::Current& c, Ice::LocalObjectPtr&)
{
    IceUtil::Mutex::Lock lock(_m);

    // Check if we have instantiated a servant already.
    //
    Ice::ObjectPtr servant = c.adapter.find(c.id);

    if (!servant) {        // We don't have a servant already

        // Instantiate a servant.
        //
        ServantDetails d;
        try {
            d = DB_lookup(c.id.name);
        } catch (const DB_error&) {
            return 0;
        }
        servant = new PhoneEntryI(d);

        // Add the servant to the ASM.
        //
        c.adapter->add(servant, c.id);
    }

    return servant;
}

```

The Java version of this locator is almost identical, but we use the `synchronized` qualifier instead of a mutex to make `locate` a critical region:

Java

```
synchronized public Ice.Object
locate(Ice.Current c, Ice.LocalObjectHolder cookie)
{
    // Check if we have instantiated a servant already.
    //
    Ice.Object servant = c.adapter.find(c.id);

    if (servant == null) { // We don't have a servant already

        // Instantiate a servant
        //
        ServantDetails d;
        try {
            d = DB.lookup(c.id.name);
        } catch (DB.error&) {
            return null;
        }
        servant = new PhoneEntryI(d);

        // Add the servant to the ASM.
        //
        c.adapter.add(servant, c.id);
    }

    return servant;
}
```

 In C#, you can place the body of `locate` into a `lock(this)` statement.

Using a servant locator that adds the servant to the ASM has a number of advantages:

- Servants are instantiated on demand, so the cost of initializing the servants is spread out over many invocations instead of being incurred all at once during server start-up.
- The memory requirements for the server are reduced because servants are instantiated only for those Ice objects that are actually accessed by clients. If clients only access a subset of the total number of Ice objects, the memory savings can be substantial.

In general, incremental initialization is beneficial if instantiating servants during start-up is too slow. The memory savings can be worthwhile as well but, as a rule, are realized only for comparatively short-lived servers: for long-running servers, chances are that, sooner or later, every Ice object will be accessed by some client or another; in that case, there are no memory savings because we end up with an instantiated servant for every Ice object regardless.

Implementing a Server using Default Servants

[Default servants](#) are a very effective tool for conserving memory when a server hosts a large number of Ice objects.

To create a default servant implementation, we need as many default servants as there are non-abstract interfaces in the system. For example, for our [file system application](#), we require two default servants, one for directories and one for files. In addition, the [object identities](#) we create use the `category` member of the object identity to encode the type of interface of the corresponding Ice object. The value of the

category field can be anything that identifies the interface, such as the 'd' and 'f' convention we [suggested earlier](#). Alternatively, you could use "Directory" and "File", or use the type ID of the corresponding interface, such as "::Filesystem::Directory" and "::Filesystem::File". The name member of the object identity must be set to whatever identifier we can use to retrieve the persistent state of each directory and file from secondary storage. (For our file system application, we used a UUID as a unique identifier.)

Registration of the default servants is as follows:

```
C++
```

```
adapter->addDefaultServant(new DirectoryI, "d");
adapter->addDefaultServant(new FileI, "f");
```

All the action happens in the implementation of the operations, using the following steps for each operation:

1. Use the passed `Current` object to get the identity for the current request.
2. Use the `name` member of the identity to locate the persistent state of the servant on secondary storage. If no record can be found for the identity, throw an `ObjectNotExistException`.
3. Implement the operation to operate on that retrieved state (returning the state or updating the state as appropriate for the operation).

This might look something like the following:

```
C++
```

```
Filesystem::NodeSeq
Filesystem::DirectoryI::list(const Ice::Current& c) const
{
    // Use the identity of the directory to retrieve
    // its contents.
    DirectoryContents dc;
    try {
        dc = DB_getDirectory(c.id.name);
    } catch(const DB_error&) {
        throw Ice::ObjectNotExistException(__FILE__, __LINE__);
    }

    // Use the records retrieved from the database to
    // initialize return value.
    //
    Filesystem::NodeSeq ns;
    // ...

    return ns;
}
```

Note that the servant implementation is completely stateless: the only state it operates on is the identity of the Ice object for the current request (and that identity is passed as part of the `Current` parameter).

Overriding `ice_ping`

We [recommended](#) that a default servant implementation take steps to preserve the semantics of the `ice_ping` operation, which is used to test whether an Ice object exists. If a default servant fails to override `ice_ping`, clients may mistakenly believe that a non-existent Ice object

still exists. The code below demonstrates how we can override the operation in our file system application:

```

C++

void
Filesystem::DirectoryI::ice_ping(const Ice::Current& c) const
{
    try {
        d = DB_lookup(c.id.name);
    } catch (const DB_error&) {
        throw Ice::ObjectNotExistException(__FILE__, __LINE__);
    }
}

```

It is good practice to override `ice_ping` if you are using default servants.

Combining Server Implementation Techniques

Depending on the nature of your application, you may be able to steer a middle path that provides better performance while keeping memory requirements low: if your application has a number of frequently-accessed objects that are performance-critical, you can add servants for those objects to the ASM. If you store the state of these objects in data members inside the servants, you effectively have a cache of these objects.

The remaining, less-frequently accessed objects can be implemented with a default servant. For example, in our file system implementation, we could choose to instantiate directory servants permanently, but to have file objects implemented with a default servant. This provides efficient navigation through the directory tree and incurs slower performance only for the (presumably less frequent) file accesses.

This technique could be augmented with a cache of recently-accessed files, along similar lines to the buffer pool used by the Unix kernel [1]. The point is that you can combine use of the ASM with servant locators and default servants to precisely control the trade-offs among scalability, memory consumption, and performance to suit the needs of your application.

See Also

- [Servant Locators](#)
- [Servant Locator Example](#)
- [Servant Activation and Deactivation](#)
- [Using Identity Categories with Servant Locators](#)
- [Default Servants](#)

References

1. McKusick, M. K., et al. 1996. [The Design and Implementation of the 4.4BSD Operating System](#). Reading, MA: Addison-Wesley.

Servant Evictors

A particularly interesting use of a [servant locator](#) is as an *evictor* [1]. An evictor is a servant locator that maintains a cache of servants:

- Whenever a request arrives (that is, `locate` is called by the Ice run time), the evictor checks to see whether it can find a servant for the request in its cache. If so, it returns the servant that is already instantiated in the cache; otherwise, it instantiates a servant and adds it to the cache.
- The cache is a queue that is maintained in least-recently used (LRU) order: the least-recently used servant is at the tail of the queue, and the most-recently used servant is at the head of the queue. Whenever a servant is returned from or added to the cache, it is moved from its current queue position to the head of the queue, that is, the "newest" servant is always at the head, and the "oldest" servant is always at the tail.
- The queue has a configurable length that corresponds to how many servants will be held in the cache; if a request arrives for an Ice object that does not have a servant in memory and the cache is full, the evictor removes the least-recently used servant at the tail of the queue from the cache in order to make room for the servant about to be instantiated at the head of the queue.

The figure below illustrates an evictor with a cache size of five after five invocations have been made, for object identities 1 to 5, in that order.

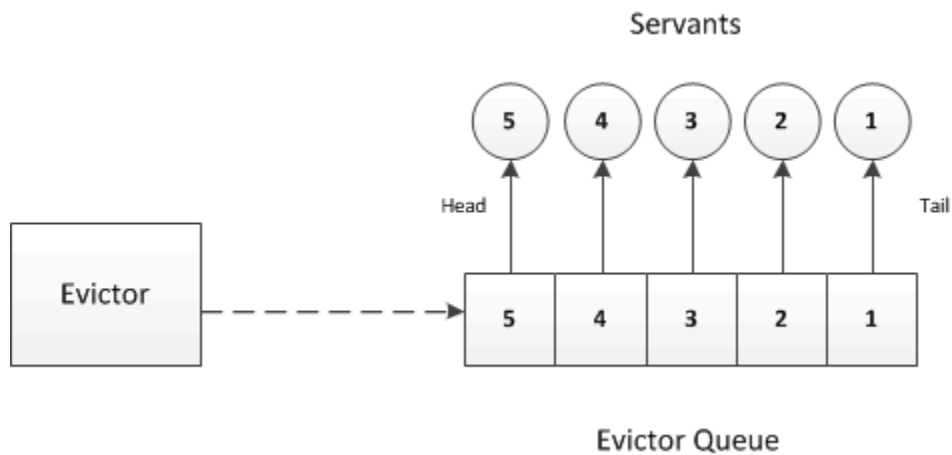

An evictor after five invocations for object identities 1 to 5.

At this point, the evictor has instantiated five servants, and has placed each servant onto the evictor queue. Because requests were sent by the client for object identities 1 to 5 (in that order), servant 5 ends up at the head of the queue (at the most-recently used position), and servant 1 ends up at the tail of the queue (at the least-recently used position).

Assume that the client now sends a request for servant 3. In this case, the servant is found on the evictor queue and moved to the head position. The resulting ordering is shown below:

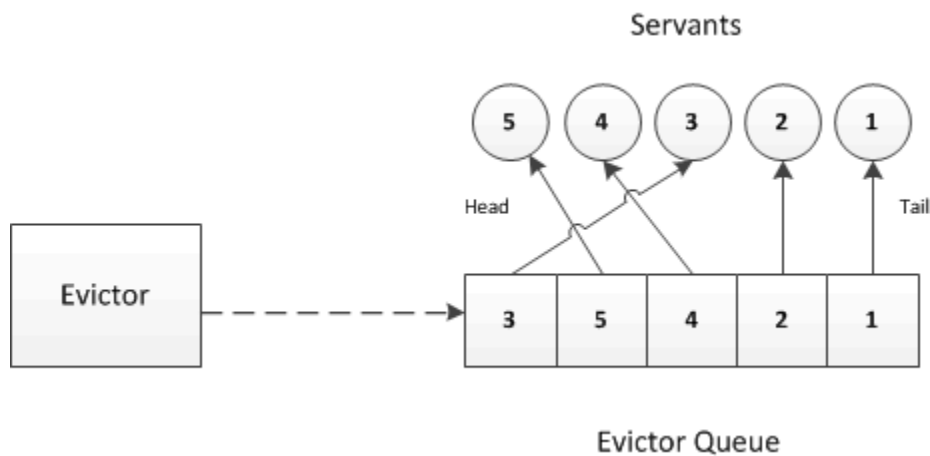

The evictor after accessing servant 3.

Assume that the next client request is for object identity 6. The evictor queue is fully populated, so the evictor creates a servant for object

identity 6, places that servant at the head of the queue, and evicts the servant with identity 1 (the least-recently used servant) at the tail of the queue, as you can see here:

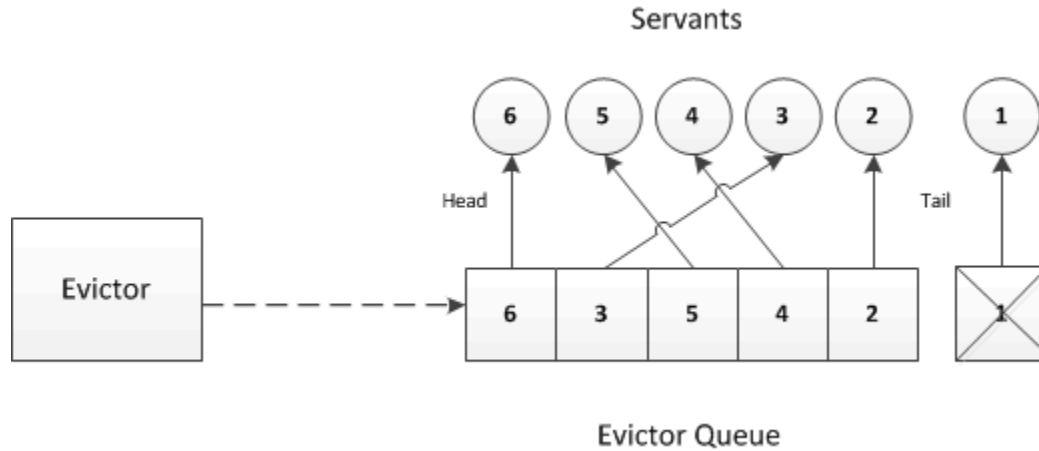

The evictor after evicting servant 1.

The evictor pattern combines the advantages of the ASM with the advantages of a [default servant](#): provided that the cache size is sufficient to hold the working set of servants in memory, most requests are served by an already instantiated servant, without incurring the overhead of creating a servant and accessing the database to initialize servant state. By setting the cache size, you can control the trade-off between performance and memory consumption as appropriate for your application.

The following pages show how to implement an evictor in several languages. (You can also find the source code for the evictor with the code examples for this manual in the Ice distribution.)

Topics

- [Implementing a Servant Evictor in C++](#)
- [Implementing a Servant Evictor in Java](#)
- [Implementing a Servant Evictor in C-Sharp](#)

See Also

- [Servant Locators](#)
- [Default Servants](#)

References

1. Henning, M., and S. Vinoski. 1999. *Advanced CORBA Programming with C++*. Reading, MA: Addison-Wesley.

Implementing a Servant Evictor in C++

On this page:

- [The EvictorBase Class in C++](#)
- [Using Servant Evictors in C++](#)

The EvictorBase Class in C++

The `evictor` we show here is designed as an abstract base class: in order to use it, you derive a class from the `EvictorBase` base class and implement two methods that are called by the evictor when it needs to add or evict a servant. This leads to a class definition as follows:

```

C++

class EvictorBase : public Ice::ServantLocator {
public:
    EvictorBase(int size = 1000);

    virtual Ice::ObjectPtr locate(const Ice::Current& c,
Ice::LocalObjectPtr& cookie);

    virtual void finished(const Ice::Current& c, const Ice::ObjectPtr&,
const Ice::LocalObjectPtr& cookie);

    virtual void deactivate(const std::string&);

protected:
    virtual Ice::ObjectPtr add(const Ice::Current&,
Ice::LocalObjectPtr&) = 0;

    virtual void evict(const Ice::ObjectPtr&,
const Ice::LocalObjectPtr&) = 0;

private:
    // ...
};

typedef IceUtil::Handle<EvictorBase> EvictorBasePtr;
```

Note that the evictor has a constructor that sets the size of the queue, with a default argument to set the size to 1000.

The `locate`, `finished`, and `deactivate` functions are inherited from the `ServantLocator` base class; these functions implement the logic to maintain the queue in LRU order and to add and evict servants as needed.

The `add` and `evict` functions are called by the evictor when it needs to add a new servant to the queue and when it evicts a servant from the queue. Note that these functions are pure virtual, so they must be implemented in a derived class. The job of `add` is to instantiate and initialize a servant for use by the evictor. The `evict` function is called by the evictor when it evicts a servant, allowing the subclass to perform any cleanup. Note that `add` can return a cookie that the evictor passes to `evict`, so you can move context information from `add` to `evict`.

Next, we need to consider the data structures that are needed to support our evictor implementation. We require two main data structures:

1. A map that maps [object identities](#) to servants, so we can efficiently decide whether we have a servant for an incoming request in memory or not.

2. A list that implements the evictor queue. The list is kept in LRU order at all times.

The evictor map not only stores servants but also keeps track of some administrative information:

1. The map stores the cookie that is returned from `add`, so we can pass that same cookie to `evict`.
2. The map stores an iterator into the evictor queue that marks the position of the servant in the queue. Storing the queue position is not strictly necessary — we store the position for efficiency reasons because it allows us to locate a servant's position in the queue in constant time instead of having to search through the queue in order to maintain its LRU property.
3. The map stores a use count that is incremented whenever an operation is dispatched into a servant, and decremented whenever an operation completes.

The need for the use count deserves some extra explanation: suppose a client invokes a long-running operation on an Ice object with identity *I*. In response, the evictor adds a servant for *I* to the evictor queue. While the original invocation is still executing, other clients invoke operations on various Ice objects, which leads to more servants for other object identities being added to the queue. As a result, the servant for identity *I* gradually migrates toward the tail of the queue. If enough client requests for other Ice objects arrive while the operation on object *I* is still executing, the servant for *I* could be evicted while it is still executing the original request.

By itself, this will not do any harm. However, if the servant is evicted and a client then invokes another request on object *I*, the evictor would have no idea that a servant for *I* is still around and would add a second servant for *I*. However, having two servants for the same Ice object in memory is likely to cause problems, especially if the servant's operation implementations write to a database.

The use count allows us to avoid this problem: we keep track of how many requests are currently executing inside each servant and, while a servant is busy, avoid evicting that servant. As a result, the queue size is not a hard upper limit: long-running operations can temporarily cause more servants than the limit to appear in the queue. However, as soon as excess servants become idle, they are evicted as usual.

The evictor queue does not store the identity of the servant. Instead, the entries on the queue are iterators into the evictor map. This is useful when the time comes to evict a servant: instead of having to search the map for the identity of the servant to be evicted, we can simply delete the map entry that is pointed at by the iterator at the tail of the queue. We can get away with storing an iterator into the evictor queue as part of the map, and storing an iterator into the evictor map as part of the queue because both `std::list` and `std::map` do not invalidate forward iterators when we add or delete entries (except for invalidating iterators that point at a deleted entry, of course).



Reverse iterators *can* be invalidated by modification of list entries: if a reverse iterator points at `r_end` and the element at the head of the list is erased, the iterator pointing at `r_end` is invalidated.

Finally, our `locate` and `finished` implementations will need to exchange a cookie that contains a smart pointer to the entry in the evictor map. This is necessary so that `finished` can decrement the servant's use count.

This leads to the following definitions in the private section of our evictor:

C++

```

class EvictorBase : public Ice::ServantLocator {
    // ...

private:

    struct EvictorEntry;
    typedef IceUtil::Handle<EvictorEntry> EvictorEntryPtr;

    typedef std::map<Ice::Identity, EvictorEntryPtr> EvictorMap;
    typedef std::list<EvictorMap::iterator> EvictorQueue;

    struct EvictorEntry : public Ice::LocalObject
    {
        Ice::ObjectPtr servant;
        Ice::LocalObjectPtr userCookie;
        EvictorQueue::iterator queuePos;
        int useCount;
    };

    EvictorMap _map;
    EvictorQueue _queue;
    Ice::Int _size;

    IceUtil::Mutex _mutex;

    void evictServants();
};

```

Note that the evictor stores the evictor map, queue, and the queue size in the private data members `_map`, `_queue`, and `_size`. In addition, we use a private `_mutex` data member so we can correctly serialize access to the evictor's data structures.

The `evictServants` member function takes care of evicting servants when the queue length exceeds its limit — we will discuss this function in more detail shortly.

The `EvictorEntry` structure serves as the cookie that we pass from `locate` to `finished`; it stores the servant, the servant's position in the evictor queue, the servant's use count, and the cookie that we pass from `add` to `evict`.

The implementation of the constructor is trivial. The only point of note is that we ignore negative sizes:

C++

```

EvictorBase::EvictorBase(Ice::Int size) : _size(size)
{
    if (_size < 0)
        _size = 1000;
}

```



We could have stored the size as a `size_t` instead. However, for consistency with the Java implementation, which cannot use unsigned integers, we use `Ice::Int` to store the size.

Almost all the action of the evictor takes place in the implementation of `locate`:

C++

```
Ice::ObjectPtr
EvictorBase::locate(const Ice::Current& c, Ice::LocalObjectPtr& cookie)
{
    IceUtil::Mutex::Lock lock(_mutex);

    //
    // Check if we have a servant in the map already.
    //
    EvictorEntryPtr entry;
    EvictorMap::iterator i = _map.find(c.id);
    if (i != _map.end()) {
        //
        // Got an entry already, dequeue the entry from
        // its current position.
        //
        entry = i->second;
        _queue.erase(entry->queuePos);
    } else {
        //
        // We do not have an entry. Ask the derived class to
        // instantiate a servant and add a new entry to the map.
        //
        entry = new EvictorEntry;
        entry->servant = add(c, entry->userCookie); // Down-call
        if (!entry->servant) {
            return 0;
        }
        entry->useCount = 0;
        i = _map.insert(std::make_pair(c.id, entry)).first;
    }

    //
    // Increment the use count of the servant and enqueue
    // the entry at the front, so we get LRU order.
    //
    ++(entry->useCount);
    entry->queuePos = _queue.insert(_queue.begin(), i);

    cookie = entry;

    return entry->servant;
}
```

The first step in `locate` is to lock the `_mutex` data member. This protects the evictor's data structures from concurrent access. The next step is to instantiate a smart pointer to an `EvictorEntry`. That smart pointer acts as the cookie that is returned from `locate` and will be passed by the Ice run time to the corresponding call to `finished`. That same smart pointer is also the value type of our map entries, so we do not store two copies of the same information redundantly — instead, smart pointers ensure that a single copy of each `EvictorEntry` structure is shared by both the cookie and the map.

The next step is to look in the evictor map to see whether we already have an entry for this object identity. If so, we remove the entry from its current queue position.

Otherwise, we do not have an entry for this object identity yet, so we have to create one. The code creates a new evictor entry, and then calls `add` to get a new servant. This is a down-call to the concrete class that will be derived from `EvictorBase`. The implementation of `add` must attempt to locate the object state for the Ice object with the identity passed inside the `Current` object and either return a servant as usual, or return null or throw an exception to indicate failure. If `add` returns null, we return zero to let the Ice run time know that no servant could be found for the current request. If `add` succeeds, we initialize the entry's use count to zero and insert the entry into the evictor map.

The last few lines of `locate` add the entry for the current request to the head of the evictor queue to maintain its LRU property, increment the use count of the entry, set the cookie that is returned from `locate` to point at the `EvictorEntry`, and finally return the servant to the Ice run time.

The implementation of `finished` is comparatively simple. It decrements the use count of the entry and then calls `evictServants` to get rid of any servants that might need to be evicted:

```

C++

void
EvictorBase::finished(const Ice::Current&,
                     const Ice::ObjectPtr&,
                     const Ice::LocalObjectPtr& cookie)
{
    IceUtil::Mutex::Lock lock(_mutex);

    EvictorCookiePtr ec = EvictorCookiePtr::dynamicCast(cookie);

    // Decrement use count and check if
    // there is something to evict.
    //
    --(ec->entry->useCount);
    evictServants();
}

```

In turn, `evictServants` examines the evictor queue: if the queue length exceeds the evictor's size, the excess entries are scanned. Any entries with a zero use count are then evicted:

C++

```

void
EvictorBase::evictServants()
{
    //
    // If the evictor queue has grown larger than the limit,
    // look at the excess elements to see whether any of them
    // can be evicted.
    //
    EvictorQueue::reverse_iterator p = _queue.rbegin();
    int excessEntries = static_cast<int>(_map.size() - _size);

    for (int i = 0; i < excessEntries; ++i) {
        EvictorMap::iterator mapPos = *p;
        if (mapPos->second->useCount == 0) {
            evict(mapPos->second->servant, mapPos->second->userCookie);
            p = EvictorQueue::reverse_iterator(_queue.erase(mapPos->second->queuePos));
            _map.erase(mapPos);
        }
        else
            ++p;
    }
}

```

The code scans the excess entries, starting at the tail of the evictor queue. If an entry has a zero use count, it is evicted: after calling the `evict` member function in the derived class, the code removes the evicted entry from both the map and the queue.

Finally, the implementation of `deactivate` sets the evictor size to zero and then calls `evictServants`. This results in eviction of all servants. The Ice run time **guarantees** to call `deactivate` only once no more requests are executing in an object adapter; as a result, it is guaranteed that all entries in the evictor will be idle and therefore will be evicted.

C++

```

void
EvictorBase::deactivate(const std::string& category)
{
    IceUtil::Mutex::Lock lock(_mutex);

    _size = 0;
    evictServants();
}

```

Note that, with this implementation of `evictServants`, we only scan the tail section of the evictor queue for servants to evict. If we have long-running operations, this allows the number of servants in the queue to remain above the evictor size if the servants in the tail section have a non-zero use count. This means that, even immediately after calling `evictServants`, the queue length can still exceed the evictor size.

We can adopt a more aggressive strategy for eviction: instead of scanning only the excess entries in the queue, if, after looking in the tail section of the queue, we still have more servants in the queue than the queue size, we keep scanning for servants with a zero use count until the queue size drops below the limit. This alternative version of `evictServants` looks as follows:

```

C++

void
EvictorBase::evictServants()
{
    //
    // If the evictor queue has grown larger than the limit,
    // try to evict servants until the length drops
    // below the limit.
    //
    EvictorQueue::reverse_iterator p = _queue.rbegin();
    int numEntries = static_cast<int>_map.size();

    for (int i = 0; i < numEntries && _map.size() > _size; ++i) {
        EvictorMap::iterator mapPos = *p;
        if (mapPos->second->useCount == 0) {
            evict(mapPos->second->servant, mapPos->second->userCookie);
            p = EvictorQueue::reverse_iterator(_queue.erase(mapPos->second->queuePos));
            _map.erase(mapPos);
        }
        else
            ++p;
    }
}

```

The only difference in this version is that the terminating condition for the `for`-loop has changed: instead of scanning only the excess entries for servants with a use count, this version keeps scanning until the evictor size drops below the limit.

Which version is more appropriate depends on your application: if locating and evicting servants is expensive, and memory is not at a premium, the first version (which only scans the tail section) is more appropriate; if you want to keep memory consumption to a minimum, the second version is more appropriate. Also keep in mind that the difference between the two versions is significant only if you have long-running operations and many concurrent invocations from clients; otherwise, there is no point in more aggressively scanning for servants to remove because they are going to become idle again very quickly and get evicted as soon as the next request arrives.

Using Servant Evictors in C++

Using a servant evictor is simply a matter of deriving a class from `EvictorBase` and implementing the `add` and `evict` methods. You can turn a servant locator into an evictor by simply taking the code that you wrote for `locate` and placing it into `add` — `EvictorBase` then takes care of maintaining the cache in least-recently used order and evicting servants as necessary. Unless you have clean-up requirements for your servants (such as closing network connections or database handles), the implementation of `evict` can be left empty.

One of the nice aspects of evictors is that you do not need to change anything in your servant implementation: the servants are ignorant of the fact that an evictor is in use. This makes it very easy to add an evictor to an already existing code base with little disturbance of the source code.

Evictors can provide substantial performance improvements over [default servants](#): especially if initialization of servants is expensive (for example, because servant state must be initialized by reading from a network), an evictor performs much better than a default servant, while keeping memory requirements low.

See Also

- [Servant Evictors](#)
- [Object Identity](#)
- [Default Servants](#)

Implementing a Servant Evictor in Java

On this page:

- [The `EvictorBase` Class in Java](#)
- [Using Servant Evictors in Java](#)

The `EvictorBase` Class in Java

The `evictor` we show here is designed as an abstract base class: in order to use it, you derive a class from the `Evictor.EvictorBase` base class and implement two methods that are called by the evictor when it needs to add or evict a servant. This leads to a class definition as follows:

Java

```

package Evictor;

public abstract class EvictorBase implements Ice.ServantLocator
{
    public
    EvictorBase()
    {
        _size = 1000;
    }

    public
    EvictorBase(int size)
    {
        _size = size < 0 ? 1000 : size;
    }

    public abstract Ice.Object
    add(Ice.Current c, Ice.LocalObjectHolder cookie);

    public abstract void
    evict(Ice.Object servant, java.lang.Object cookie);

    synchronized public final Ice.Object
    locate(Ice.Current c, Ice.LocalObjectHolder cookie)
    {
        // ...
    }

    synchronized public final void
    finished(Ice.Current c, Ice.Object o, java.lang.Object cookie)
    {
        // ...
    }

    synchronized public final void
    deactivate(String category)
    {
        // ...
    }

    // ...

    private int _size;
}

```

Note that the evictor has constructors to set the size of the queue, with a default size of 1000.

The `locate`, `finished`, and `deactivate` methods are inherited from the `ServantLocator` base class; these methods implement the logic to maintain the queue in LRU order and to add and evict servants as needed. The methods are synchronized, so the evictor's internal data structures are protected from concurrent access.

The `add` and `evict` methods are called by the evictor when it needs to add a new servant to the queue and when it evicts a servant from the queue. Note that these functions are abstract, so they must be implemented in a derived class. The job of `add` is to instantiate and initialize a servant for use by the evictor. The `evict` function is called by the evictor when it evicts a servant, allowing the subclass to perform any cleanup. Note that `add` can return a cookie that the evictor passes to `evict`, so you can move context information from `add` to `evict`.

Next, we need to consider the data structures that are needed to support our evictor implementation. We require two main data structures:

1. A map that maps `object identities` to servants, so we can efficiently decide whether we have a servant for an incoming request in memory or not.
2. A list that implements the evictor queue. The list is kept in LRU order at all times.

The evictor map not only stores servants but also keeps track of some administrative information:

1. The map stores the cookie that is returned from `add`, so we can pass that same cookie to `evict`.
2. The map stores an iterator into the evictor queue that marks the position of the servant in the queue.
3. The map stores a use count that is incremented whenever an operation is dispatched into a servant, and decremented whenever an operation completes.

The last two points deserve some extra explanation.

- The evictor queue must be maintained in least-recently used order, that is, every time an invocation arrives and we find an entry for the identity in the evictor map, we also must locate the servant's identity on the evictor queue and move it to the front of the queue. However, scanning for that entry is inefficient because it requires $O(n)$ time. To get around this, we store an iterator in the evictor map that marks the corresponding entry's position in the evictor queue. This allows us to dequeue the entry from its current position and enqueue it at the head of the queue in $O(1)$ time.

Unfortunately, the various lists provided by `java.util` do not allow us to keep an iterator to a list position without invalidating that iterator as the list is updated. To deal with this, we use a special-purpose linked list implementation, `Evictor.LinkedList`, that does not have this limitation. `LinkedList` has an interface similar to `java.util.LinkedList` but does not invalidate iterators other than iterators that point at an element that is removed. For brevity, we do not show the implementation of this list here — you can find the implementation in the code examples for this manual in the Ice distribution.

- We maintain a use count as part of the map in order to avoid incorrect eviction of servants. Suppose a client invokes a long-running operation on an Ice object with identity `I`. In response, the evictor adds a servant for `I` to the evictor queue. While the original invocation is still executing, other clients invoke operations on various Ice objects, which leads to more servants for other object identities being added to the queue. As a result, the servant for identity `I` gradually migrates toward the tail of the queue. If enough client requests for other Ice objects arrive while the operation on object `I` is still executing, the servant for `I` could be evicted while it is still executing the original request.

By itself, this will not do any harm. However, if the servant is evicted and a client then invokes another request on object `I`, the evictor would have no idea that a servant for `I` is still around and would add a second servant for `I`. However, having two servants for the same Ice object in memory is likely to cause problems, especially if the servant's operation implementations write to a database.

The use count allows us to avoid this problem: we keep track of how many requests are currently executing inside each servant and, while a servant is busy, avoid evicting that servant. As a result, the queue size is not a hard upper limit: long-running operations can temporarily cause more servants than the limit to appear in the queue. However, as soon as excess servants become idle, they are evicted as usual.

Finally, our `locate` and `finished` implementations will need to exchange a cookie that contains a smart pointer to the entry in the evictor map. This is necessary so that `finished` can decrement the servant's use count.

This leads to the following definitions in the private section of our evictor:

Java

```

package Evictor;

public abstract class EvictorBase implements Ice.ServantLocator
{
    // ...

    private class EvictorEntry
    {
        Ice.Object servant;
        java.lang.Object userCookie;
        java.util.Iterator<Ice.Identity> queuePos;
        int useCount;
    }

    private void evictServants()
    {
        // ...
    }

    private java.util.Map<Ice.Identity, EvictorEntry> _map =
        new java.util.HashMap<Ice.Identity, EvictorEntry>();
    private Evictor.LinkedList<Ice.Identity> _queue =
        new Evictor.LinkedList<Ice.Identity>();
    private int _size;
}

```

Note that the evictor stores the evictor map, queue, and the queue size in the private data members `_map`, `_queue`, and `_size`. The map key is the identity of the Ice object, and the lookup value is of type `EvictorEntry`. The queue simply stores identities, of type `Ice::Identity`.

The `evictServants` member function takes care of evicting servants when the queue length exceeds its limit — we will discuss this function in more detail shortly.

Almost all the action of the evictor takes place in the implementation of `locate`:

Java

```

synchronized public final Ice.Object
locate(Ice.Current c, Ice.LocalObjectHolder cookie)
{
    //
    // Check if we have a servant in the map already.
    //
    EvictorEntry entry = _map.get(c.id);
    if (entry != null) {
        //
        // Got an entry already, dequeue the entry from
        // its current position.
        //
        entry.queuePos.remove();
    } else {
        //
        // We do not have entry. Ask the derived class to
        // instantiate a servant and add a new entry to the map.
        //
        entry = new EvictorEntry();
        Ice.LocalObjectHolder cookieHolder =
new Ice.LocalObjectHolder();
        entry.servant = add(c, cookieHolder); // Down-call
        if (entry.servant == null) {
            return null;
        }
        entry.userCookie = cookieHolder.value;
        entry.useCount = 0;
        _map.put(c.id, entry);
    }

    //
    // Increment the use count of the servant and enqueue
    // the entry at the front, so we get LRU order.
    //
    ++(entry.useCount);
    _queue.addFirst(c.id);
    entry.queuePos = _queue.iterator();
    entry.queuePos.next(); // Position iterator on the element.

    cookie.value = entry;
    return entry.servant;
}

```

The code uses an `EvictorEntry` as the cookie that is returned from `locate` and will be passed by the Ice run time to the corresponding call to `finished`.

We first look for an existing entry in the evictor map, using the object identity as the key. If we have an entry in the map already, we dequeue

the corresponding identity from the evictor queue. (The `queuePos` member of `EvictorEntry` is an iterator that marks that entry's position in the evictor queue.)

Otherwise, we do not have an entry in the map, so we create a new one and call the `add` method. This is a down-call to the concrete class that will be derived from `EvictorBase`. The implementation of `add` must attempt to locate the object state for the Ice object with the identity passed inside the `Current` object and either return a servant as usual, or return null or throw an exception to indicate failure. If `add` returns null, we return null to let the Ice run time know that no servant could be found for the current request. If `add` succeeds, we initialize the entry's use count to zero and insert the entry into the evictor map.

The final few lines of code increment the entry's use count, add the entry at the head of the evictor queue, store the entry's position in the queue, and assign the entry to the cookie that is returned from `locate`, before returning the servant to the Ice run time.

The implementation of `finished` is comparatively simple. It decrements the use count of the entry and then calls `evictServants` to get rid of any servants that might need to be evicted:

```

Java

synchronized public final void
finished(Ice.Current c, Ice.Object o, java.lang.Object cookie)
{
    EvictorEntry entry = (EvictorEntry)cookie;

    // Decrement use count and check if
    // there is something to evict.
    //
    --(entry.useCount);
    evictServants();
}

```

In turn, `evictServants` examines the evictor queue: if the queue length exceeds the evictor's size, the excess entries are scanned. Any entries with a zero use count are then evicted:

Java

```

private void evictServants()
{
    //
    // If the evictor queue has grown larger than the limit,
    // look at the excess elements to see whether any of them
    // can be evicted.
    //
    java.util.Iterator<Ice.Identity> p = _queue.riterator();
    int excessEntries = _map.size() - _size;
    for (int i = 0; i < excessEntries; ++i) {
        Ice.Identity id = p.next();
        EvictorEntry e = _map.get(id);
        if (e.useCount == 0) {
            evict(e.servant, e.userCookie); // Down-call
            e.queuePos.remove();
            _map.remove(id);
        }
    }
}

```

The code scans the excess entries, starting at the tail of the evictor queue. If an entry has a zero use count, it is evicted: after calling the `evict` member function in the derived class, the code removes the evicted entry from both the map and the queue.

Finally, the implementation of `deactivate` sets the evictor size to zero and then calls `evictServants`. This results in eviction of all servants. The Ice run time [guarantees](#) to call `deactivate` only once no more requests are executing in an object adapter; as a result, it is guaranteed that all entries in the evictor will be idle and therefore will be evicted.

Java

```

synchronized public final void
deactivate(String category)
{
    _size = 0;
    evictServants();
}

```

Note that, with this implementation of `evictServants`, we only scan the tail section of the evictor queue for servants to evict. If we have long-running operations, this allows the number of servants in the queue to remain above the evictor size if the servants in the tail section have a non-zero use count. This means that, even immediately after calling `evictServants`, the queue length can still exceed the evictor size.

We can adopt a more aggressive strategy for eviction: instead of scanning only the excess entries in the queue, if, after looking in the tail section of the queue, we still have more servants in the queue than the queue size, we keep scanning for servants with a zero use count until the queue size drops below the limit. This alternative version of `evictServants` looks as follows:

Java

```
private void evictServants()
{
    //
    // If the evictor queue has grown larger than the limit,
    // look at the excess elements to see whether any of them
    // can be evicted.
    //
    java.util.Iterator<Ice.Identity> p = _queue.riterator();
    int numEntries = _map.size();
    for (int i = 0; i < excessEntries && _map.size() > _size;
        ++i) {
        Ice.Identity id = p.next();
        EvictorEntry e = _map.get(id);
        if (e.useCount == 0) {
            evict(e.servant, e.userCookie); // Down-call
            e.queuePos.remove();
            _map.remove(id);
        }
    }
}
```

The only difference in this version is that the terminating condition for the `for`-loop has changed: instead of scanning only the excess entries for servants with a use count, this version keeps scanning until the evictor size drops below the limit.

Which version is more appropriate depends on your application: if locating and evicting servants is expensive, and memory is not at a premium, the first version (which only scans the tail section) is more appropriate; if you want to keep memory consumption to a minimum, the second version is more appropriate. Also keep in mind that the difference between the two versions is significant only if you have long-running operations and many concurrent invocations from clients; otherwise, there is no point in more aggressively scanning for servants to remove because they are going to become idle again very quickly and get evicted as soon as the next request arrives.

Using Servant Evictors in Java

Using a servant evictor is simply a matter of deriving a class from `EvictorBase` and implementing the `add` and `evict` methods. You can turn a servant locator into an evictor by simply taking the code that you wrote for `locate` and placing it into `add` — `EvictorBase` then takes care of maintaining the cache in least-recently used order and evicting servants as necessary. Unless you have clean-up requirements for your servants (such as closing network connections or database handles), the implementation of `evict` can be left empty.

One of the nice aspects of evictors is that you do not need to change anything in your servant implementation: the servants are ignorant of the fact that an evictor is in use. This makes it very easy to add an evictor to an already existing code base with little disturbance of the source code.

Evictors can provide substantial performance improvements over [default servants](#): especially if initialization of servants is expensive (for example, because servant state must be initialized by reading from a network), an evictor performs much better than a default servant, while keeping memory requirements low.

See Also

- [Servant Evictors](#)
- [Object Identity](#)
- [Default Servants](#)

Implementing a Servant Evictor in C-Sharp

On this page:

- [A Linked List to Support Eviction in C#](#)
- [The `EvictorBase` Class in C#](#)
- [Using Servant Evictors in C#](#)

A Linked List to Support Eviction in C#

The `System.Collections` classes do not provide a container that does not invalidate iterators when we modify the contents of the container but, to efficiently implement an `evictor`, we need such a container. To deal with this, we use a special-purpose linked list implementation, `Evictor.LinkedList`, that does not invalidate iterators when we delete or add an element. For brevity, we only show the interface of `LinkedList` here — you can find the implementation in the code examples for this manual in the Ice distribution.

C#

```

namespace Evictor
{
    public class LinkedList<T> : ICollection<T>, ICollection, ICloneable
    {
        public LinkedList();

        public int Count { get; }

        public void Add(T value);
        public void AddFirst(T value);
        public void Clear();
        public bool Contains(T value);
        public bool Remove(T value);

        public IEnumerator GetEnumerator();

        public class Enumerator : IEnumerator<T>, IEnumerator,
IDisposable
        {
            public void Reset();

            public T Current { get; }

            public bool MoveNext();
            public bool MovePrev();
            public void Remove();
            public void Dispose();
        }

        public void CopyTo(T[] array, int index);
        public void CopyTo(Array array, int index);

        public object Clone();

        public bool IsReadOnly { get; }
        public bool IsSynchronized { get; }
        public object SyncRoot { get; }
    }
}

```

The `Add` method appends an element to the list, and the `AddFirst` method prepends an element to the list. `GetEnumerator` returns an enumerator for the list elements; immediately after calling `GetEnumerator`, the enumerator does not point at any element until you call either `MoveNext` or `MovePrev`, which position the enumerator at the first and last element, respectively. `Current` returns the element at the enumerator position, and `Remove` deletes the element at the current position and leaves the enumerator pointing at no element. Calling `MoveNext` or `MovePrev` after calling `Remove` positions the enumerator at the element following or preceding the deleted element, respectively. `MoveNext` and `MovePrev` return true if they have positioned the enumerator on an element; otherwise, they return false and leave the enumerator position on the last and first element, respectively.

The EvictorBase Class in C#

Given this `LinkedList`, we can implement the evictor. The evictor we show here is designed as an abstract base class: in order to use it, you derive a class from the `Evictor.EvictorBase` base class and implement two methods that are called by the evictor when it needs to add or evict a servant. This leads to a class definition as follows:

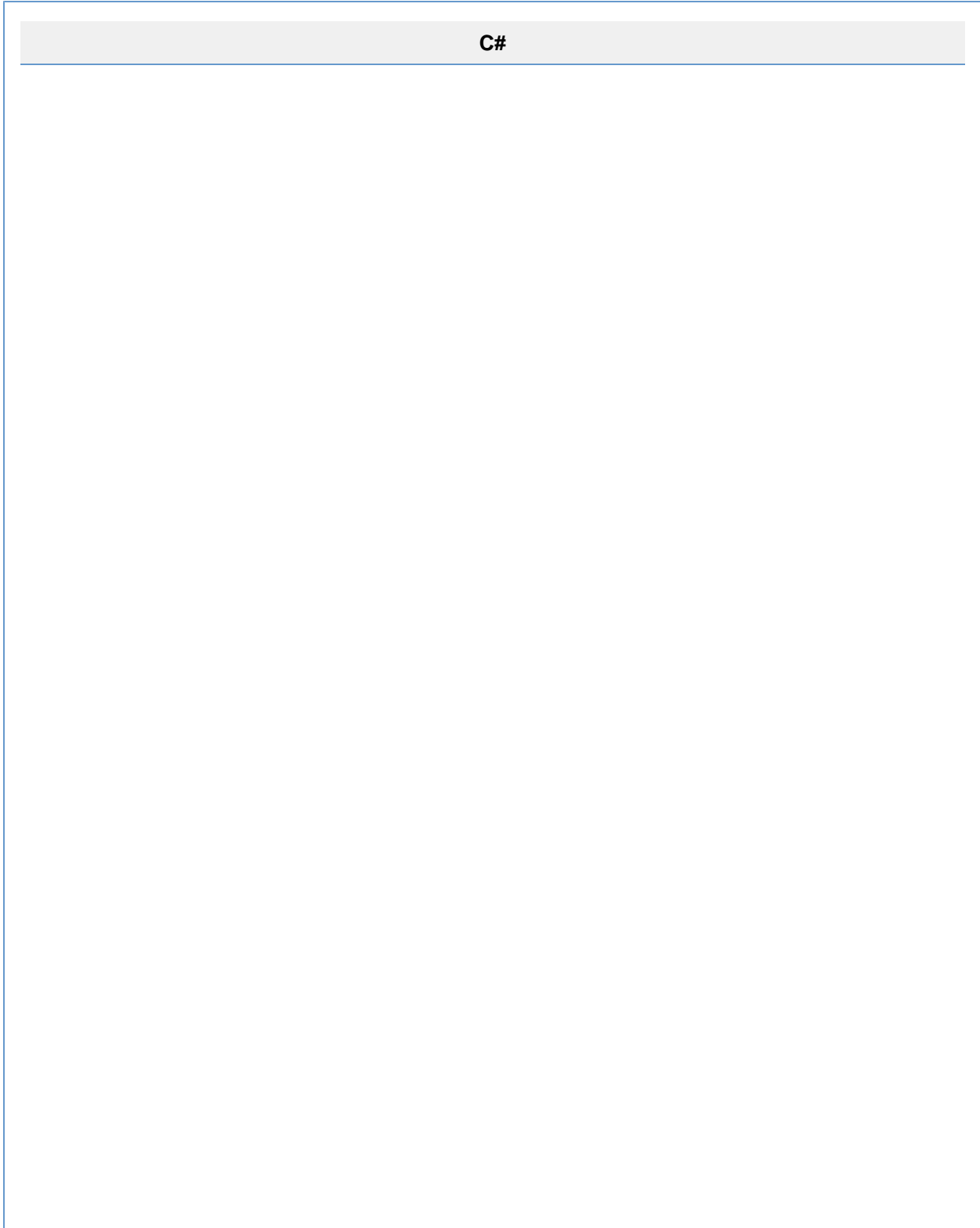

```

namespace Evictor
{
    public abstract class EvictorBase : Ice.ServantLocator
    {
        public EvictorBase()
        {
            _size = 1000;
        }

        public EvictorBase(int size)
        {
            _size = size < 0 ? 1000 : size;
        }

        protected abstract Ice.Object add(Ice.Current c,
out object cookie);

        protected abstract void evict(Ice.Object servant,
object cookie);

        public Ice.Object locate(Ice.Current c, out object cookie)
        {
            lock(this)
            {
                // ...
            }
        }

        public void finished(Ice.Current c, Ice.Object o, object cookie)
        {
            lock(this)
            {
                // ...
            }
        }

        public void deactivate(string category)
        {
            lock(this)
            {
                // ...
            }
        }

        private int _size;
    }
}

```

Note that the evictor has constructors to set the size of the queue, with a default size of 1000.

The `locate`, `finished`, and `deactivate` methods are inherited from the `ServantLocator` base class; these methods implement the logic to maintain the queue in LRU order and to add and evict servants as needed. The methods use a `lock(this)` statement for their body, so the evictor's internal data structures are protected from concurrent access.

The `add` and `evict` methods are called by the evictor when it needs to add a new servant to the queue and when it evicts a servant from the queue. Note that these functions are abstract, so they must be implemented in a derived class. The job of `add` is to instantiate and initialize a servant for use by the evictor. The `evict` function is called by the evictor when it evicts a servant, allowing the subclass to perform any cleanup. Note that `add` can return a cookie that the evictor passes to `evict`, so you can move context information from `add` to `evict`.

Next, we need to consider the data structures that are needed to support our evictor implementation. We require two main data structures:

1. A map that maps `object identities` to servants, so we can efficiently decide whether we have a servant for an incoming request in memory or not.
2. A list that implements the evictor queue. The list is kept in LRU order at all times.

The evictor map not only stores servants but also keeps track of some administrative information:

1. The map stores the cookie that is returned from `add`, so we can pass that same cookie to `evict`.
2. The map stores an iterator into the evictor queue that marks the position of the servant in the queue.
3. The map stores a use count that is incremented whenever an operation is dispatched into a servant, and decremented whenever an operation completes.

The last two points deserve some extra explanation.

- The evictor queue must be maintained in least-recently used order, that is, every time an invocation arrives and we find an entry for the identity in the evictor map, we also must locate the servant's identity on the evictor queue and move it to the front of the queue. However, scanning for that entry is inefficient because it requires $O(n)$ time. To get around this, we store an iterator in the evictor map that marks the corresponding entry's position in the evictor queue. This allows us to dequeue the entry from its current position and enqueue it at the head of the queue in $O(1)$ time, using the `Evictor.LinkedList` implementation.
- We maintain a use count as part of the map in order to avoid incorrect eviction of servants. Suppose a client invokes a long-running operation on an Ice object with identity *I*. In response, the evictor adds a servant for *I* to the evictor queue. While the original invocation is still executing, other clients invoke operations on various Ice objects, which leads to more servants for other object identities being added to the queue. As a result, the servant for identity *I* gradually migrates toward the tail of the queue. If enough client requests for other Ice objects arrive while the operation on object *I* is still executing, the servant for *I* could be evicted while it is still executing the original request.

By itself, this will not do any harm. However, if the servant is evicted and a client then invokes another request on object *I*, the evictor would have no idea that a servant for *I* is still around and would add a second servant for *I*. However, having two servants for the same Ice object in memory is likely to cause problems, especially if the servant's operation implementations write to a database.

The use count allows us to avoid this problem: we keep track of how many requests are currently executing inside each servant and, while a servant is busy, avoid evicting that servant. As a result, the queue size is not a hard upper limit: long-running operations can temporarily cause more servants than the limit to appear in the queue. However, as soon as excess servants become idle, they are evicted as usual.

Finally, our `locate` and `finished` implementations will need to exchange a cookie that contains a reference to the entry in the evictor map. This is necessary so that `finished` can decrement the servant's use count.

This leads to the following definitions in the private section of our evictor:

C#

```

namespace Evictor
{
    using System.Collections.Generic;

    public abstract class EvictorBase : Ice.ServantLocator
    {
        // ...

        private class EvictorEntry
        {
            internal Ice.Object servant;
            internal object userCookie;
            internal LinkedList<Ice.Identity>.Enumerator queuePos;
            internal int useCount;
        }

        private void evictServants()
        {
            // ...
        }

        private Dictionary<Ice.Identity, EvictorEntry> _map =
            new Dictionary<Ice.Identity, EvictorEntry>();
        private LinkedList<Ice.Identity> _queue =
            new LinkedList<Ice.Identity>();
        private int _size;
    }
}

```

Note that the evictor stores the evictor map, queue, and the queue size in the private data members `_map`, `_queue`, and `_size`. The map key is the identity of the Ice object, and the lookup value is of type `EvictorEntry`. The queue simply stores identities, of type `Ice.Identity`.

The `evictServants` member function takes care of evicting servants when the queue length exceeds its limit — we will discuss this function in more detail shortly.

Almost all the action of the evictor takes place in the implementation of `locate`:

C#

```

public Ice.Object locate(Ice.Current c, out object cookie)
{
    lock(this)
    {
        //
        // Check if we a servant in the map already.
        //
        EvictorEntry entry = _map[c.id];
        if (entry != null) {
            //
            // Got an entry already, dequeue the entry from
            // its current position.
            //
            entry.queuePos.Remove();
        } else {
            //
            // We do not have an entry. Ask the derived class to
            // instantiate a servant and add an entry to the map.
            //
            entry = new EvictorEntry();
            entry.servant = add(c, out entry.userCookie);
            if (entry.servant == null) {
                cookie = null;
                return null;
            }
            entry.useCount = 0;
            _map[c.id] = entry;
        }

        //
        // Increment the use count of the servant and enqueue
        // the entry at the front, so we get LRU order.
        //
        ++(entry.useCount);
        _queue.AddFirst(c.id);
        entry.queuePos = (LinkedList<Ice.Identity>.Enumerator)_queue.Ge
tEnumerator();
        entry.queuePos.MoveNext();

        cookie = entry;

        return entry.servant;
    }
}

```

The code uses an `EvictorEntry` as the cookie that is returned from `locate` and will be passed by the Ice run time to the corresponding call to `finished`.

We first look for an existing entry in the evictor map, using the object identity as the key. If we have an entry in the map already, we dequeue the corresponding identity from the evictor queue. (The `queuePos` member of `EvictorEntry` is an iterator that marks that entry's position in the evictor queue.)

Otherwise, we do not have an entry in the map, so we create a new one and call the `add` method. This is a down-call to the concrete class that will be derived from `EvictorBase`. The implementation of `add` must attempt to locate the object state for the Ice object with the identity passed inside the `Current` object and either return a servant as usual, or return null or throw an exception to indicate failure. If `add` returns null, we return null to let the Ice run time know that no servant could be found for the current request. If `add` succeeds, we initialize the entry's use count to zero and insert the entry into the evictor map.

The final few lines of code increment the entry's use count, add the entry at the head of the evictor queue, store the entry's position in the queue, and initialize the cookie that is returned from `locate`, before returning the servant to the Ice run time.

The implementation of `finished` is comparatively simple. It decrements the use count of the entry and then calls `evictServants` to get rid of any servants that might need to be evicted:

```

C#

public void finished(Ice.Current c, Ice.Object o, object cookie)
{
    lock(this)
    {
        EvictorEntry entry = (EvictorEntry)cookie;

        //
        // Decrement use count and check if
        // there is something to evict.
        //
        --(entry.useCount);
        evictServants();
    }
}

```

In turn, `evictServants` examines the evictor queue: if the queue length exceeds the evictor's size, the excess entries are scanned. Any entries with a zero use count are then evicted:

C#

```

private void evictServants()
{
    //
    // If the evictor queue has grown larger than the limit,
    // look at the excess elements to see whether any of them
    // can be evicted.
    //
    LinkedList<Ice.Identity>.Enumerator p =
        (LinkedList<Ice.Identity>.Enumerator)_queue.GetEnumerator();
    int excessEntries = _map.Count - _size;
    for (int i = 0; i < excessEntries; ++i) {
        p.MovePrev();
        Ice.Identity id = p.Current;
        EvictorEntry e = _map[id];
        if (e.useCount == 0) {
            evict(e.servant, e.userCookie); // Down-call
            p.Remove();
            _map.Remove(id);
        }
    }
}

```

The code scans the excess entries, starting at the tail of the evictor queue. If an entry has a zero use count, it is evicted: after calling the `evict` member function in the derived class, the code removes the evicted entry from both the map and the queue.

Finally, the implementation of `deactivate` sets the evictor size to zero and then calls `evictServants`. This results in eviction of all servants. The Ice run time [guarantees](#) to call `deactivate` only once no more requests are executing in an object adapter; as a result, it is guaranteed that all entries in the evictor will be idle and therefore will be evicted.

C#

```

public void deactivate(string category)
{
    lock(this)
    {
        _size = 0;
        evictServants();
    }
}

```

Note that, with this implementation of `evictServants`, we only scan the tail section of the evictor queue for servants to evict. If we have long-running operations, this allows the number of servants in the queue to remain above the evictor size if the servants in the tail section have a non-zero use count. This means that, even immediately after calling `evictServants`, the queue length can still exceed the evictor size.

We can adopt a more aggressive strategy for eviction: instead of scanning only the excess entries in the queue, if, after looking in the tail section of the queue, we still have more servants in the queue than the queue size, we keep scanning for servants with a zero use count until the queue size drops below the limit. This alternative version of `evictServants` looks as follows:

C#

```

private void evictServants()
{
    //
    // If the evictor queue has grown larger than the limit,
    // look at the excess elements to see whether any of them
    // can be evicted.
    //
    LinkedList<Ice.Identity>.Enumerator p =
        (LinkedList<Ice.Identity>.Enumerator)_queue.GetEnumerator();
    int numEntries = _map.Count;
    for (int i = 0; i < numEntries && _map.Count > _size; ++i) {
        p.MovePrev();
        Ice.Identity id = p.Current;
        EvictorEntry e = _map[id];
        if (e.useCount == 0) {
            evict(e.servant, e.userCookie); // Down-call
            p.Remove();
            _map.Remove(id);
        }
    }
}

```

The only difference in this version is that the terminating condition for the `for`-loop has changed: instead of scanning only the excess entries for servants with a use count, this version keeps scanning until the evictor size drops below the limit.

Which version is more appropriate depends on your application: if locating and evicting servants is expensive, and memory is not at a premium, the first version (which only scans the tail section) is more appropriate; if you want to keep memory consumption to a minimum, the second version is more appropriate. Also keep in mind that the difference between the two versions is significant only if you have long-running operations and many concurrent invocations from clients; otherwise, there is no point in more aggressively scanning for servants to remove because they are going to become idle again very quickly and get evicted as soon as the next request arrives.

Using Servant Evictors in C#

Using a servant evictor is simply a matter of deriving a class from `EvictorBase` and implementing the `add` and `evict` methods. You can turn a servant locator into an evictor by simply taking the code that you wrote for `locate` and placing it into `add` — `EvictorBase` then takes care of maintaining the cache in least-recently used order and evicting servants as necessary. Unless you have clean-up requirements for your servants (such as closing network connections or database handles), the implementation of `evict` can be left empty.

One of the nice aspects of evictors is that you do not need to change anything in your servant implementation: the servants are ignorant of the fact that an evictor is in use. This makes it very easy to add an evictor to an already existing code base with little disturbance of the source code.

Evictors can provide substantial performance improvements over [default servants](#): especially if initialization of servants is expensive (for example, because servant state must be initialized by reading from a network), an evictor performs much better than a default servant, while keeping memory requirements low.

See Also

- [Servant Evictors](#)
- [Object Identity](#)
- [Default Servants](#)

The Ice Threading Model

Ice is inherently a multi-threaded platform. There is no such thing as a single-threaded server in Ice. As a result, you must concern yourself with concurrency issues: if a thread reads a data structure while another thread updates the same data structure, havoc will ensue unless you protect the data structure with appropriate locks. In order to build Ice applications that behave correctly, it is important that you understand the threading semantics of the Ice run time. Here we discuss Ice's *thread pool* concurrency model and provide guidelines for writing thread-safe Ice applications.

Topics

- [Thread Pools](#)
- [Object Adapter Thread Pools](#)
- [Thread Pool Design Considerations](#)
- [Nested Invocations](#)
- [Thread Safety](#)
- [Dispatching Invocations to User Threads](#)

Thread Pools

A thread pool is a collection of threads that the Ice run time draws upon to perform specific tasks.

On this page:

- [Introduction to Thread Pools](#)
- [Configuring Thread Pools](#)
- [Dynamic Thread Pools](#)

Introduction to Thread Pools

Each communicator creates two thread pools:

- The *client thread pool* services outgoing connections, which primarily involves handling the replies to outgoing requests and includes notifying AMI callback objects. If a connection is used in [bidirectional mode](#), the client thread pool also dispatches incoming callback requests.
- The *server thread pool* services incoming connections. It dispatches incoming requests and, for bidirectional connections, processes replies to outgoing requests.

By default, these two thread pools are shared by all of the communicator's [object adapters](#). If necessary, you can configure individual object adapters to use a [private thread pool](#) instead.

If a thread pool is exhausted because all threads are currently dispatching a request, additional incoming requests are transparently delayed until a request completes and relinquishes its thread; that thread is then used to dispatch the next pending request. Ice minimizes thread context switches in a thread pool by using a leader-follower implementation [\[1\]](#).

Configuring Thread Pools

Each thread pool has a unique name that serves as the prefix for its configuration properties:

- [name.Size](#)
This property specifies the initial size of the thread pool. If not defined, the default value is one.
- [name.SizeMax](#)
This property specifies the maximum size of the thread pool. If not defined, the default value is one. If the value of this property is less than that of [name.Size](#), this property is adjusted to be equal to [name.Size](#).
- [name.SizeWarn](#)
This property sets a high water mark; when the number of threads in a pool reaches this value, the Ice run time logs a warning message. If you see this warning message frequently, it could indicate that you need to increase the value of [name.SizeMax](#). The default value is zero, which disables the warning.
- [name.StackSize](#)
This property specifies the number of bytes to use as the stack size of threads in the thread pool. The operating system's default is used if this property is not defined or is set to zero.
- [name.Serialize](#)
Setting this property to a value greater than zero forces the thread pool to serialize all messages received over a connection. It is unnecessary to enable serialization for a thread pool whose maximum size is one because such a thread pool is already limited to processing one message at a time. For thread pools with more than one thread, serialization has a negative impact on latency and throughput. If not defined, the default value is zero. We discuss this feature in more detail in [Thread Pool Design Considerations](#).
- [name.ThreadIdleTime](#)
This property specifies the number of seconds that a thread in the thread pool must be idle before it terminates. The default value is 60 seconds if this property is not defined. Setting it to zero disables the termination of idle threads.

For configuration purposes, the names of the client and server thread pools are `Ice.ThreadPool.Client` and `Ice.ThreadPool.Server`, respectively. As an example, the following properties establish the initial and maximum sizes for these thread pools:

```
Ice.ThreadPool.Client.Size=1
Ice.ThreadPool.Client.SizeMax=10
Ice.ThreadPool.Server.Size=1
Ice.ThreadPool.Server.SizeMax=10
```

To monitor the thread pool activities of the Ice run time, you can enable the `Ice.Trace.ThreadPool` property. Setting this property to a non-zero value causes the Ice run time to log a message when it creates a thread pool, as well as each time the size of a thread pool increases or decreases.

Dynamic Thread Pools

A *dynamic* thread pool can grow and shrink when necessary in response to changes in an application's work load. All thread pools have at least one thread, but a dynamic thread pool can grow as the demand for threads increases, up to the pool's maximum size. Threads may also be terminated automatically when they have been idle for some time.

The dynamic nature of a thread pool is determined by the configuration properties `name.Size`, `name.SizeMax`, and `name.ThreadIdleTime`. A thread pool is not dynamic in its default configuration because `name.Size` and `name.SizeMax` are both set to one, meaning the pool can never grow to contain more than a single thread. To configure a dynamic thread pool, you must set at least one of `name.Size` or `name.SizeMax` to a value greater than one. We can use several configuration scenarios to explore the semantics of dynamic thread pools in greater detail:

- `name.SizeMax=5`

This thread pool initially contains a single thread because `name.Size` has a default value of one, and Ice can grow the pool up to the maximum of five threads. During periods of inactivity, idle threads terminate after 60 seconds (the default value for `name.ThreadIdleTime`) until the pool contains just one thread again.

- `name.Size=3`
`name.SizeMax=5`

This thread pool starts with three active threads but otherwise behaves the same as in the previous configuration. The pool can still shrink to a size of one as threads become idle.

- `name.Size=3`
`name.ThreadIdleTime=10`

This thread pool starts with three active threads and shrinks quickly to one thread during periods of inactivity. As demand increases again, the thread pool can return to its maximum size of three threads (`name.SizeMax` defaults to the value of `name.Size`).

- `name.SizeMax=5`
`name.ThreadIdleTime=0`

This thread pool can grow from its initial size of one thread to contain up to five threads, but it will never shrink because `name.ThreadIdleTime` is set to zero.

- `name.Size=5`
`name.ThreadIdleTime=0`

This thread pool starts with five threads and can neither grow nor shrink.

To summarize, the value of `name.ThreadIdleTime` determines whether (and how quickly) a thread pool can shrink to a size of one. A thread pool that shrinks can also grow to its maximum size. Finally, setting `name.SizeMax` to a value larger than `name.Size` allows a thread pool to grow beyond its initial capacity.

See Also

- [Thread Pool Design Considerations](#)
- [Bidirectional Connections](#)
- [Object Adapters](#)
- [Object Adapter Thread Pools](#)
- [Ice Thread Pool Properties](#)

References

1. Schmidt, D. C. et al. 2000. "Leader/Followers: A Design Pattern for Efficient Multi-Threaded Event Demultiplexing and Dispatching". In *Proceedings of the 7th Pattern Languages of Programs Conference*, WUCS-00-29, Seattle, WA: University of Washington.

Object Adapter Thread Pools

The default behavior of an [object adapter](#) is to share the [thread pools](#) of its communicator and, for many applications, this behavior is entirely sufficient. However, the ability to configure an object adapter with its own thread pool is useful in certain situations:

- When the concurrency requirements of an object adapter does not match those of its communicator. In a server with multiple object adapters, the configuration of the communicator's client and server thread pools may be a good match for some object adapters, but others may have different requirements. For example, the servants hosted by one object adapter may not support concurrent access, in which case limiting that object adapter to a single-threaded pool eliminates the need for synchronization in those servants. On the other hand, another object adapter might need a multi-threaded pool for better performance.
- To ensure that a minimum number of threads is available for dispatching requests to an adapter's servants. This is especially important for eliminating the possibility of deadlocks when using [nested invocations](#).

An object adapter's thread pool supports all of the properties described in [Configuring Thread Pools](#). For configuration purposes, the name of an adapter's thread pool is `adapter.ThreadPool`, where `adapter` is the name of the adapter.

An adapter creates its own thread pool when at least one of the following properties has a value greater than zero:

- `adapter.ThreadPool.Size`
- `adapter.ThreadPool.SizeMax`

These properties have the same semantics as those described earlier except they both have a default value of zero, meaning that an adapter uses the communicator's thread pools by default.

As an example, the properties shown below configure a thread pool for the object adapter named `PrinterAdapter`:

```
PrinterAdapter.ThreadPool.Size=3
PrinterAdapter.ThreadPool.SizeMax=15
PrinterAdapter.ThreadPool.SizeWarn=14
```

See Also

- [Thread Pools](#)
- [Object Adapters](#)
- [Nested Invocations](#)
- [Ice Object Adapter Properties](#)

Thread Pool Design Considerations

Improper configuration of a [thread pool](#) can have a serious impact on the performance of your application. This page discusses some issues that you should consider when designing and configuring your applications.

On this page:

- [Single-Threaded Pool](#)
- [Multi-Threaded Pool](#)
- [Serializing Requests in a Multi-Threaded Pool](#)

Single-Threaded Pool

There are several implications of using a thread pool with a maximum size of one thread:

- **Only one message can be dispatched at a time.**

This can be convenient because it lets you avoid (or postpone) dealing with [thread-safety issues](#) in your application. However, it also eliminates the possibility of dispatching requests concurrently, which can be a bottleneck for applications running on multi-CPU systems or that perform blocking operations. Another option is to enable [serialization](#) in a multi-threaded pool.

- **Only one AMI reply can be processed at a time.**

An application must increase the size of the client thread pool in order to process multiple AMI callbacks in parallel.

- **Nested twoway invocations are limited.**

At most one level of [nested twoway invocations](#) is possible.

It is important to remember that a communicator's client and server thread pools have a default maximum size of one thread, therefore these limitations also apply to any object adapter that shares the communicator's thread pools.

Multi-Threaded Pool

Configuring a thread pool to support multiple threads implies that the application is prepared for the Ice run time to dispatch operation invocations or AMI callbacks concurrently. Although greater effort is required to design a thread-safe application, you are rewarded with the ability to improve the application's scalability and throughput.

Choosing an appropriate maximum size for a thread pool requires careful analysis of your application. For example, in compute-bound applications it is best to limit the number of threads to the number of physical processor cores or threads on the host machine; adding any more threads only increases context switches and reduces performance. Increasing the size of the pool beyond the number of cores can improve responsiveness when threads can become blocked while waiting for the operating system to complete a task, such as a network or file operation. On the other hand, a thread pool configured with too many threads can have the opposite effect and negatively impact performance. Testing your application in a realistic environment is the recommended way of determining the optimum size for a thread pool.

If your application uses [nested invocations](#), it is very important that you evaluate whether it is possible for thread starvation to cause a deadlock. Increasing the size of a thread pool can lessen the chance of a deadlock, but other design solutions are usually preferred.

Serializing Requests in a Multi-Threaded Pool

When using a multi-threaded pool, the nondeterministic nature of thread scheduling means that requests from the same connection may not be dispatched in the order they were received. Some applications cannot tolerate this behavior, such as a transaction processing server that must guarantee that requests are executed in order. There are two ways of satisfying this requirement:

1. Use a single-threaded pool.
2. [Configure a multi-threaded pool](#) to serialize requests using its `Serialize` property.

At first glance these two options may seem equivalent, but there is a significant difference: a single-threaded pool can only dispatch one request at a time and therefore serializes requests from *all* connections, whereas a multi-threaded pool configured for serialization can dispatch requests from different connections concurrently while serializing requests from the same connection.

You can obtain the same behavior from a multi-threaded pool without enabling serialization, but only if you design the clients so that they do not send requests from multiple threads, do not send requests over more than one connection, and only use synchronous twoway invocations. In general, however, it is better to avoid such tight coupling between the implementations of the client and server.

Enabling serialization can improve responsiveness and performance compared to a single-threaded pool, but there is an associated cost. The extra synchronization that the pool must perform to serialize requests adds significant overhead and results in higher latency and reduced throughput.

As you can see, thread pool serialization is not a feature that you should enable without analyzing whether the benefits are worthwhile. For example, it might be an inappropriate choice for a server with long-running operations when the client needs the ability to have several operations in progress simultaneously. If serialization was enabled in this situation, the client would be forced to work around it by [opening several connections](#) to the server, which again tightly couples the client and server implementations. If the server must keep track of the order of client requests, a better solution would be to use serialization in conjunction with [asynchronous dispatch](#) to queue the incoming requests for execution by other threads.

See Also

- [Thread Pools](#)
- [Nested Invocations](#)
- [Thread Safety](#)
- [Connection Establishment](#)

Nested Invocations

A *nested invocation* is one that is made within the context of another Ice operation. For instance, the implementation of an operation in a servant might need to make a nested invocation on some other object, or an AMI callback object might invoke an operation in the course of processing a reply to an asynchronous request. It is also possible for one of these invocations to result in a nested callback to the originating process. The maximum depth of such invocations is determined by the size of the thread pools used by the communicating parties.

On this page:

- [Deadlocks with Nested Invocations](#)
- [Analyzing an Application for Nested Invocations](#)

Deadlocks with Nested Invocations

Applications that use nested invocations must be carefully designed to avoid the potential for deadlock, which can easily occur when invocations take a circular path. For example, this illustration presents a deadlock scenario when using the default thread pool configuration:

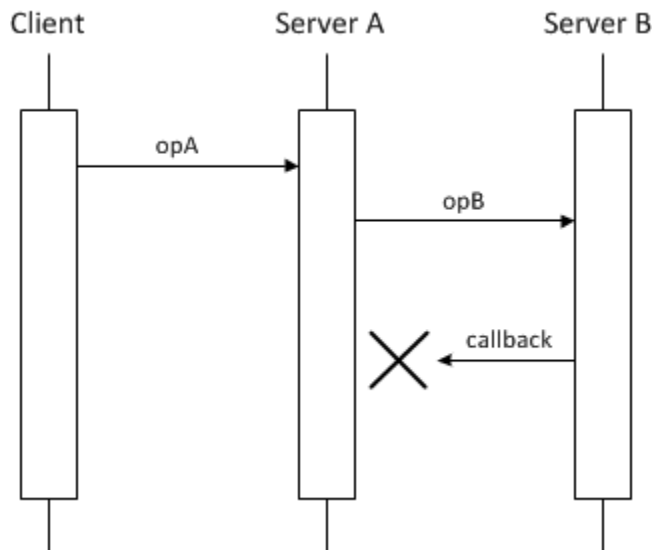

Nested invocation deadlock.

In this diagram, the implementation of `opA` makes a nested twoway invocation of `opB`, but the implementation of `opB` causes a deadlock when it tries to make a nested callback. As mentioned in [Thread Pools](#), the communicator's thread pools have a maximum size of one thread unless explicitly configured otherwise. In Server A, the only thread in the server thread pool is busy waiting for its invocation of `opB` to complete, and therefore no threads remain to handle the callback from Server B. The client is now blocked because Server A is blocked, and they remain blocked indefinitely unless timeouts are used.

There are several ways to avoid a deadlock in this scenario:

- **Increase the maximum size of the server thread pool in Server A.**

Configuring the server thread pool in Server A to support more than one thread allows the nested callback to proceed. This is the simplest solution, but it requires that you know in advance how deeply nested the invocations may occur, or that you set the maximum size to a sufficiently large value that exhausting the pool becomes unlikely. For example, setting the maximum size to two avoids a deadlock when a single client is involved, but a deadlock could easily occur again if multiple clients invoke `opA` simultaneously. Furthermore, setting the maximum size too large can cause its own [set of problems](#).

- **Use a oneway invocation.**

If Server A called `opB` using a [oneway invocation](#), it would no longer need to wait for a response and therefore `opA` could complete, making a thread available to handle the callback from Server B. However, we have made a significant change in the semantics of `opA` because now there is no guarantee that `opB` has completed before `opA` returns, and it is still possible for the oneway invocation of `opB` to block.

- **Create another object adapter for the callbacks.**

No deadlock occurs if the callback from Server B is directed to a different object adapter that is configured with its [own thread pool](#).

- **Implement `opA` using asynchronous dispatch and invocation.**

By declaring `opA` as an AMD operation and invoking `opB` using AMI, Server A can avoid blocking the thread pool's thread while it waits for `opB` to complete. This technique, known as *asynchronous request chaining*, is used extensively in Ice services such as IceGrid and Glacier2 to eliminate the possibility of deadlocks.

As another example, consider a client that makes a nested invocation from an AMI callback object using the default thread pool configuration. The (one and only) thread in the client thread pool receives the reply to the asynchronous request and invokes its callback object. If the callback object in turn makes a nested twoway invocation, a deadlock occurs because no more threads are available in the client thread pool to process the reply to the nested invocation. The solutions are similar to some of those presented in the above illustration: increase the maximum size of the client thread pool, use a oneway invocation, or call the nested invocation using AMI.

Analyzing an Application for Nested Invocations

A number of factors must be considered when evaluating whether an application is properly designed and configured for nested invocations:

- The thread pool configurations in use by all communicating parties have a significant impact on an application's ability to use nested invocations. While analyzing the path of circular invocations, you must pay careful attention to the threads involved to determine whether sufficient threads are available to avoid deadlock. This includes not just the threads that dispatch requests, but also the threads that make the requests and process the replies. Enabling the `Ice.Trace.ThreadPool` property can give you a better understanding of the thread pool behavior in your application.
- Bidirectional connections are another complication, since you must be aware of which threads are used on either end of the connection.
- Finally, the synchronization activities of the communicating parties must also be scrutinized. For example, a deadlock is much more likely when a lock is held while making an invocation.

As you can imagine, tracing the call flow of a distributed application to ensure there is no possibility of deadlock can quickly become a complex and tedious process. In general, it is best to avoid circular invocations if at all possible.

See Also

- [Thread Pools](#)
- [Object Adapter Thread Pools](#)
- [Thread Pool Design Considerations](#)
- [Oneway Invocations](#)

Thread Safety

The Ice run time itself is fully thread safe, meaning multiple application threads can safely call methods on objects such as communicators, object adapters, and proxies without synchronization problems. As a developer, you must also be concerned with thread safety because the Ice run time can dispatch multiple invocations concurrently in a server. In fact, it is possible for multiple requests to proceed in parallel within the same servant and within the same operation on that servant. It follows that, if the operation implementation manipulates non-stack storage (such as member variables of the servant or global or static data), you must interlock access to this data to avoid data corruption.

The need for thread safety in an application depends on its configuration. Using the default [thread pool](#) configuration typically makes synchronization unnecessary because at most one operation can be dispatched at a time. Thread safety becomes an issue once you increase the maximum size of a thread pool.

Ice uses the native synchronization and threading primitives of each platform. For C++ users, Ice provides a collection of convenient and portable [wrapper classes](#) for use by Ice applications.

On this page:

- [Threading Issues with Marshaling](#)
- [Thread Creation and Destruction Hooks](#)
- [Installing Thread Hooks with a Plug-in](#)

Threading Issues with Marshaling

The marshaling semantics of the Ice run time present a subtle thread safety issue that arises when an operation returns data by reference. In C++, the only relevant case is returning an instance of a Slice class, either directly or nested as a member of another type. In Java, .NET, and the scripting languages, Slice structures, sequences, and dictionaries are also affected.

The potential for corruption occurs whenever a servant returns data by reference, yet continues to hold a reference to that data. For example, consider the following Java implementation:

```

Java



```

public class GridI extends _GridDisp
{
 GridI()
 {
 _grid = // ...
 }

 public int[][]
 getGrid(Ice.Current curr)
 {
 return _grid;
 }

 public void
 setValue(int x, int y, int val, Ice.Current curr)
 {
 _grid[x][y] = val;
 }

 private int[][] _grid;
}

```

```

Suppose that a client invoked the `getGrid` operation. While the Ice run time marshals the returned array in preparation to send a reply message, it is possible for another thread to dispatch the `setValue` operation on the same servant. This race condition can result in several unexpected outcomes, including a failure during marshaling or inconsistent data in the reply to `getGrid`. Synchronizing the `getGrid` and `setValue` operations would not fix the race condition because the Ice run time performs its marshaling outside of this synchronization.

One solution is to implement accessor operations, such as `getGrid`, so that they return copies of any data that might change. There are several drawbacks to this approach:

- Excessive copying can have an adverse affect on performance.
- The operations must return deep copies in order to avoid similar problems with nested values.
- The code to create deep copies is tedious and error-prone to write.

Another solution is to make copies of the affected data only when it is modified. In the revised code shown below, `setValue` replaces `_grid` with a copy that contains the new element, leaving the previous contents of `_grid` unchanged:

```

Java

public class GridI extends _GridDisp
{
    ...

    public synchronized int[][]
    getGrid(Ice.Current curr)
    {
        return _grid;
    }

    public synchronized void
    setValue(int x, int y, int val, Ice.Current curr)
    {
        int[][] newGrid = // shallow copy...
        newGrid[x][y] = val;
        _grid = newGrid;
    }

    ...
}

```

This allows the Ice run time to safely marshal the return value of `getGrid` because the array is never modified again. For applications where data is read more often than it is written, this solution is more efficient than the previous one because accessor operations do not need to make copies. Furthermore, intelligent use of shallow copying can minimize the overhead in mutating operations.

Finally, a third approach changes accessor operations to use AMD in order to regain control over marshaling. After annotating the `getGrid` operation with `amd` metadata, we can revise the servant as follows:

Java

```
public class GridI extends _GridDisp
{
    ...

    public synchronized void
    getGrid_async(AMD_Grid_getGrid cb, Ice.Current curr)
    {
        cb.ice_response(_grid);
    }

    public synchronized void
    setValue(int x, int y, int val, Ice.Current curr)
    {
        _grid[x][y] = val;
    }

    ...
}
```

Normally, AMD is used in situations where the servant needs to delay its response to the client without blocking the calling thread. For `getGrid`, that is not the goal; instead, as a side-effect, AMD provides the desired marshaling behavior. Specifically, the Ice run time marshals the reply to an asynchronous request at the time the servant invokes `ice_response` on the AMD callback object. Because `getGrid` and `setValue` are synchronized, this guarantees that the data remains in a consistent state during marshaling.

Thread Creation and Destruction Hooks

On occasion, it is necessary to intercept the creation and destruction of threads created by the Ice run time, for example, to interoperate with libraries that require applications to make thread-specific initialization and finalization calls (such as COM's `CoInitializeEx` and `CoUninitialize`). Ice provides callbacks to inform an application when each run-time thread is created and destroyed. For C++, the callback class looks as follows:

C++

```
class ThreadNotification : public IceUtil::Shared {
public:
    virtual void start() = 0;
    virtual void stop() = 0;
};
typedef IceUtil::Handle<ThreadNotification> ThreadNotificationPtr;
```

To receive notification of thread creation and destruction, you must derive a class from `ThreadNotification` and implement the `start` and `stop` member functions. These functions will be called by the Ice run by each thread as soon as it is created, and just before it exits. You must install your callback class in the Ice run time when you [create a communicator](#) by setting the `threadHook` member of the `InitializationData` structure.

For example, you could define a callback class and register it with the Ice run time as follows:

C++

```

class MyHook : public virtual Ice::ThreadNotification {
public:
    void start()
    {
        cout << "start: id = " << ThreadControl().id() << endl;
    }
    void stop()
    {
        cout << "stop: id = " << ThreadControl().id() << endl;
    }
};

int
main(int argc, char* argv[])
{
    // ...

    Ice::InitializationData id;
    id.threadHook = new MyHook;
    communicator = Ice::initialize(argc, argv, id);

    // ...
}

```

The implementation of your `start` and `stop` methods can make whatever thread-specific calls are required by your application.

For Java and C#, `Ice.ThreadNotification` is an interface:

Java/C#

```

public interface ThreadNotification {
    void start();
    void stop();
}

```

To receive the thread creation and destruction callbacks, you must derive a class from this interface that implements the `start` and `stop` methods, and register an instance of that class when you create the communicator. (The code to do this is analogous to the C++ version.)

For Python, the interface is:

Python

```
class ThreadNotification(object):
    def __init__(self):
        pass

    # def start():
    # def stop():
```

The Ice run time calls the `start` and `stop` methods of the class instance you provide to `Ice.initialize` when it creates and destroys threads.

Installing Thread Hooks with a Plug-in

The thread hook facility described [above](#) requires that you modify a program's source code in order to receive callbacks when threads in the Ice run time are created and destroyed. It is also possible to install thread hooks using the [Ice plug-in facility](#), which is useful for adding thread hooks to an existing program that you cannot (or prefer not to) modify.

Ice provides a base class named `ThreadHookPlugin` for C++, Java, and C# that supplies the necessary functionality. The C++ class definition is shown below:

C++

```
namespace Ice {
class ThreadHookPlugin : public Ice::Plugin {
public:

    ThreadHookPlugin(const CommunicatorPtr& communicator,
const ThreadNotificationPtr&);

    virtual void initialize();

    virtual void destroy();
};
}
```

The equivalent definitions for Java and C# are quite similar and therefore not presented here.

The `ThreadHookPlugin` constructor installs the given `ThreadNotification` object into the specified communicator. The `initialize` and `destroy` methods are empty, but you can subclass `ThreadHookPlugin` and override these methods if necessary.

In order to create a thread hook plug-in, you must do the following:

- Define and export a factory class (for Java and C#) or factory function (for C++) that returns an instance of `ThreadHookPlugin`, as described in the [plug-in API](#).
- Implement the `ThreadNotification` object that you will pass to the `ThreadHookPlugin` constructor.
- Package your code into a format that is suitable for dynamic loading, such as a shared library or DLL for C++ or an assembly for C#.

To install your plug-in, use a configuration property like the one shown below:

```
Ice.Plugin.MyThreadHookPlugin=MyHooks:createPlugin ...
```

The first component of the property value represents the plug-in's entry point. For C++, this value includes the abbreviated name of the shared library or DLL (`MyHooks`) and the name of a factory function (`createPlugin`).

If your property value is language-specific and the configuration file containing this property is shared by programs in multiple implementation languages, you can use an alternate syntax that is loaded only by the Ice run time for a certain language. For example, here is the C++-specific version:

```
Ice.Plugin.MyThreadHookPlugin.cpp=MyHooks:createPlugin ...
```

For more information, see [Ice Plug-In Properties](#).

See Also

- [Communicator Initialization](#)
- [Threads and Concurrency with C++](#)
- [Plug-in Facility](#)
- [Plug-in API](#)
- [Ice Plug-In Properties](#)

Dispatching Invocations to User Threads

By default, operation invocations and AMI callbacks are executed by a thread from a [thread pool](#). This behavior is simple and convenient for applications because they need not concern themselves with thread creation and destruction. However, there are situations where it is necessary to respond to operation invocations or AMI callbacks in a particular thread. For example, in a server, you might need to update a database that does not permit concurrent access from different threads or, in a client, you might need to update a user interface with the results of an invocation. (Many UI frameworks require all UI updates to be made by a specific thread.)

In Ice for C++, Java, .NET, and Objective-C, you can control which thread receives operation invocations and AMI callbacks, so you can ensure that all updates are made by a thread you choose. The implementation techniques vary slightly for each language and are explained in the sections that follow.

On this page:

- [C++ Dispatcher API](#)
 - [Dispatching with C++11 Lambda Functions](#)
- [Java Dispatcher API](#)
- [C# Dispatcher API](#)
- [Objective-C Dispatcher API](#)
- [Dispatcher Implementation Notes](#)

C++ Dispatcher API

To install a dispatcher, you must instantiate a class that derives from `Ice::Dispatcher` and [initialize a communicator](#) with that instance in the `InitializationData` structure. All invocations that arrive for this communicator are made via the specified dispatcher. For example:

C++

```

class MyDispatcher : public Ice::Dispatcher /*, ... */
    // ...
};

int
main(int argc, char* argv[])
{
    Ice::CommunicatorPtr communicator;

    try {
        Ice::InitializationData initData;
        initData.properties = Ice::createProperties(argc, argv);
        initData.dispatcher = new MyDispatcher();
        communicator = Ice::initialize(argc, argv, initData);

        // ...
    } catch (const Ice::Exception& ex) {
        // ...
    }

    // ...
}

```

The `Ice::Dispatcher` abstract base class has the following interface:

C++

```

class Dispatcher : virtual public IceUtil::Shared
{
public:
    virtual void dispatch(const DispatcherCallPtr&,
const ConnectionPtr&) = 0;
};

typedef IceUtil::Handle<Dispatcher> DispatcherPtr;

```

The Ice run time invokes the `dispatch` method whenever an operation invocation arrives or an AMI invocation completes, passing an instance of `DispatcherCall` and the connection via which the invocation arrived. The job of `dispatch` is to pass the incoming invocation to an operation implementation.

The connection parameter allows you to decide how to dispatch the operation based on the connection via which it was received. This value may be nil if no connection currently exists.

You can write `dispatch` such that it blocks and waits for completion of the invocation because `dispatch` is called by a thread in the server-side thread pool (for incoming operation invocations) or the client-side thread pool (for AMI callbacks).

The `DispatcherCall` instance encapsulates all the details of the incoming call. It is another abstract base class with the following interface:

C++

```

class DispatcherCall : virtual public IceUtil::Shared
{
public:
    virtual ~DispatcherCall() { }

    virtual void run() = 0;
};

typedef IceUtil::Handle<DispatcherCall> DispatcherCallPtr;

```

Your implementation of `dispatch` is expected to call `run` on the `DispatcherCall` instance (or, more commonly, to cause `run` to be called some time later). When you call `run`, the Ice run time processes the invocation in the thread that calls `run`.

A very simple way to implement `dispatch` would be as follows:

C++

```

class MyDispatcher : public Ice::Dispatcher
public:
    virtual void dispatch(const Ice::DispatcherCallPtr& d,
const Ice::ConnectionPtr&)
    {
        d->run(); // Does not throw, blocks until op completes.
    }
};

```

Whenever the Ice run time receives an incoming operation invocation or when an AMI invocation completes, it calls `dispatch` which, in turn, calls `run` on the `DispatcherCall` instance.

With this simple example, `dispatch` immediately calls `run`, and `run` does not return until the corresponding operation invocation is complete. As a result, this implementation ties up a thread in the thread pool for the duration of the call.

So far, we really have not gained anything because all we have is a callback method that is called by the Ice run time. However, this simple mechanism is sufficient to ensure that we can update a UI from the correct thread.

A common technique to avoid blocking is to use [asynchronous method invocation](#). In response to a UI event (such as the user pressing a "Submit" button), the application initiates an operation invocation from the corresponding UI callback by calling the operation's `begin_method`. This is guaranteed not to block the caller, so the UI remains responsive. Some time later, when the operation completes, the Ice run time invokes an AMI callback from one of the threads in its thread pool. That callback now has to update the UI, but that can only be done from the UI thread. By using a dispatcher, you can easily delegate the update to the correct thread. For example, here is how you can arrange for AMI callbacks to be passed to the UI thread with MFC:

C++

```

class MyDialog : public CDialog { ... };

class MyDispatcher : public Ice::Dispatcher {
public:
    MyDispatcher(MyDialog* dialog) : _dialog(dialog)
    {
    }

    virtual void
    dispatch(const Ice::DispatcherCallPtr& call,
const Ice::ConnectionPtr&)
    {
        _dialog->PostMessage(WM_AMI_CALLBACK, 0,
reinterpret_cast<LPARAM>(new Ice::DispatcherCallPtr(call)));
    }

private:
    MyDialog* _dialog;
};

```

The `MyDispatcher` class simply stores the `CDialog` handle for the UI and calls `PostMessage`, passing the `DispatcherCall` instance. In turn, this causes the UI thread to receive an event and invoke the UI callback method that was registered to respond to `WM_AMI_CALLBACK` events.

In turn, the implementation of the callback method calls `run`:

```

C++

LRESULT
MyDialog::OnAMICallback(WPARAM, LPARAM lParam)
{
    try {
        Ice::DispatcherCallPtr* call =
reinterpret_cast<Ice::DispatcherCallPtr*>(lParam);
        (*call)->run();
        delete call;
    } catch (const Ice::Exception& ex) {
        // ...
    }
    return 0;
}

```

The Ice run time calls `dispatch` once the asynchronous operation invocation is complete. In turn, this causes the `OnAMICallback` to trigger, which calls `run`. Because the operation has completed already, `run` does not block, so the UI remains responsive.

Please see the MFC demo in your Ice distribution for a fully-functional UI client that uses this technique.

Dispatching with C++11 Lambda Functions

With a suitable C++ compiler and an Ice installation that was built with C++11 features enabled, you can use lambda functions instead of defining a callback class. The dispatcher API includes the following helper function:

```

C++

namespace Ice {
inline DispatcherPtr
newDispatcher(const std::function<void (const Ice::DispatcherCallPtr&,
const Ice::ConnectionPtr)>& cb)
{
    return ...;
}
}

```

The return value of `newDispatcher` is a `Dispatcher` object that delegates to your lambda function. You can invoke `newDispatcher` as shown below:

C++

```
Ice::DispatcherPtr disp = Ice::newDispatcher([](const
Ice::DispatcherCallPtr& d,
                                                    const
Ice::ConnectionPtr&) {
    d->run();
});
initData.dispatcher = disp;
communicator = Ice::initialize(...);
```

Java Dispatcher API

To install a dispatcher, you must instantiate a class that implements `Ice.Dispatcher` and **initialize a communicator** with that instance in the `InitializationData` structure. All invocations that arrive for this communicator are made via the specified dispatcher. For example:

Java

```

public class MyDispatcher implements Ice.Dispatcher
{
    // ...
}

public class Server
{
    public static void
    main(String[] args)
    {
        Ice.Communicator communicator;

        try {
            Ice.InitializationData initData =
new Ice.InitializationData();
            initData.properties = Ice.Util.createProperties(args);
            initData.dispatcher = new MyDispatcher();
            communicator = Ice.Util.initialize(args, initData);

            // ...
        } catch (Ice.LocalException & ex) { {
            // ...
        }

        // ...
    }

    // ...
}

```

The `Ice.Dispatcher` interface looks as follows:

Java

```

public interface Dispatcher
{
    void dispatch(Runnable runnable, Ice.Connection con);
}

```

The Ice run time invokes the `dispatch` method whenever an operation invocation arrives, passing a `Runnable` and the connection via which the invocation arrived. The job of `dispatch` is to pass the incoming invocation to an operation implementation.

The connection parameter allows you to decide how to dispatch the operation based on the connection via which it was received. This value may be null if no connection currently exists.

You can write `dispatch` such that it blocks and waits for completion of the invocation because `dispatch` is called by a thread in the server-side thread pool (for incoming operation invocations) or the client-side thread pool (for AMI callbacks).

Your implementation of `dispatch` is expected to call `run` on the `Runnable` instance (or, more commonly, to cause `run` to be called some time later). When you call `run`, the Ice run time processes the invocation in the thread that calls `run`.

A very simple way to implement `dispatch` would be as follows:

```

Java



```
public class MyDispatcher implements Ice.Dispatcher
{
 public void
 dispatch(Runnable runnable, Ice.Connection connection)
 {
 // Does not throw, blocks until op completes.
 runnable.run();
 }
}
```

```

Whenever the Ice run time receives an incoming operation invocation or when an AMI invocation completes, it calls `dispatch` which, in turn, calls `run` on the `Runnable` instance.

With this simple example, `dispatch` immediately calls `run`, and `run` does not return until the corresponding operation invocation is complete. As a result, this implementation ties up a thread in the thread pool for the duration of the call.

So far, we really have not gained anything because all we have is a callback method that is called by the Ice run time. However, this simple mechanism is sufficient to ensure that we can update a UI from the correct thread.

A common technique to avoid blocking is to use [asynchronous method invocation](#). In response to a UI event (such as the user pressing a "Submit" button), the application initiates an operation invocation from the corresponding UI callback by calling the operation's `begin_` method. This is guaranteed not to block the caller, so the UI remains responsive. Some time later, when the operation completes, the Ice run time invokes an AMI `response` callback from one of the threads in its thread pool. That callback now has to update the UI, but that can only be done from the UI thread. By using a dispatcher, you can easily delegate the update to the correct thread. For example, here is how you can arrange for AMI callbacks to be passed to the UI thread with Swing:

Java

```

public class Client extends JFrame
{
    public static void main(final String[] args)
    {
        SwingUtilities.invokeLater(new Runnable()
        {
            public void run()
            {
                try {
                    new Client(args);
                } catch (Ice.LocalException e) {
                    JOptionPane.showMessageDialog(
                        null, e.toString(),
                        "Initialization failed",
                        JOptionPane.ERROR_MESSAGE);
                }
            }
        });
    }

    Client(String[] args)
    {
        Ice.Communicator communicator;

        try {
            Ice.InitializationData initData =
new Ice.InitializationData();
            initData.dispatcher = new Ice.Dispatcher()
            {
                public void
                dispatch(Runnable runnable, Ice.Connection connection)
                {
                    SwingUtilities.invokeLater(runnable);
                }
            };
            communicator = Ice.Util.initialize(args, initData);
        }
        catch(Throwable ex)
        {
            // ...
        }
        // ...
    }

    // ...
}

```

The `dispatch` method simply delays the call to `run` by calling `invokeLater`, passing it the `Runnable` that is provided by the Ice run time. This causes the Swing UI thread to eventually make the call to `run`. Because the Ice run time does not call `dispatch` until the asynchronous invocation is complete, that call to `run` does not block and the UI remains responsive.

Please see the `swing` demo in your Ice distribution for a fully-functional UI client that uses this technique.

C# Dispatcher API

To install a dispatcher, you must initialize a communicator with a delegate of type `Ice.Dispatcher` in the `InitializationData` structure. All invocations that arrive for this communicator are made via the specified dispatcher. For example:

```

C#

public class Server
{
    public static void Main(string[] args)
    {
        Ice.Communicator communicator = null;

        try {
            Ice.InitializationData initData =
new Ice.InitializationData();
            initData.dispatcher = new MyDispatcher().dispatch;
            communicator = Ice.Util.initialize(ref args, initData);
            // ...
        } catch (System.Exception ex) {
            // ...
        }

        // ...
    }

    // ...
}

```

The `Ice.Dispatcher` delegate is defined as follows:

```

C#

public delegate void Dispatcher(System.Action call, Connection con);

```

The Ice run time calls your delegate whenever an operation invocation arrives, passing a `System.Action` delegate and the connection via which the invocation arrived. The job of your delegate is to pass the incoming invocation to an operation implementation.

The connection parameter allows you to decide how to dispatch the operation based on the connection via which it was received. This value may be null if no connection currently exists.

In this example, the delegate calls a method `dispatch` on an instance of a `MyDispatcher` class. You can write `dispatch` such that it blocks and waits for completion of the invocation because `dispatch` is called by a thread in the server-side thread pool (for incoming operation invocations) or the client-side thread pool (for AMI callbacks).

Your implementation of `dispatch` is expected to invoke the `call` delegate (or, more commonly, to cause it to be invoked some time later). When you invoke the `call` delegate, the Ice run time processes the invocation in the thread that invokes the delegate.

A very simple way to implement `dispatch` would be as follows:

```

C#



```
public class MyDispatcher
{
 public void
 dispatch(System.Action call, Ice.Connection con)
 {
 // Does not throw, blocks until op completes.
 call();
 }
};
```

```

Whenever the Ice run time receives an incoming operation invocation or when an AMI invocation completes, it calls `dispatch` which, in turn, invokes the `call` delegate.

With this simple example, `dispatch` immediately invokes the delegate, and that call does not return until the corresponding operation invocation is complete. As a result, this implementation ties up a thread in the thread pool for the duration of the call.

So far, we really have not gained anything because all we have is a callback method that is called by the Ice run time. However, this simple mechanism is sufficient to ensure that we can update a UI from the correct thread.

A common technique to avoid blocking is to use [asynchronous method invocation](#). In response to a UI event (such as the user pressing a "Submit" button), the application initiates an operation invocation from the corresponding UI callback by calling the operation's `begin_` method. This is guaranteed not to block the caller, so the UI remains responsive. Some time later, when the operation completes, the Ice run time invokes an AMI callback from one of the threads in its thread pool. That callback now has to update the UI, but that can only be done from the UI thread. By using a dispatcher, you can easily delegate the update to the correct thread. For example, here is how you can arrange for AMI callbacks to be passed to the UI thread with WPF:

C#

```

public partial class MyWindow : Window
{
    private void Window_Loaded(object sender, EventArgs e)
    {
        Ice.Communicator communicator = null;

        try
        {
            Ice.InitializationData initData =
new Ice.InitializationData();
            initData.dispatcher =
                delegate(System.Action action,
Ice.Connection connection)
                {
                    Dispatcher.BeginInvoke(DispatcherPriority.Normal, actio
n);
                };
            communicator = Ice.Util.initialize(initData);
        }
        catch(Ice.LocalException ex)
        {
            // ...
        }
    }

    // ...
}

```

The delegate calls `Dispatcher.BeginInvoke` on the `action` delegate. This causes WPF to queue the actual asynchronous invocation of `action` for later execution by the UI thread. Because the Ice run time does not invoke your delegate until an asynchronous operation invocation is complete, when the UI thread executes the corresponding call to the `EndInvoke` method, that call does not block and the UI remains responsive.

The net effect is that you can invoke an operation asynchronously from a UI callback method without the risk of blocking the UI thread. For example:

C#

```

public partial class MyWindow : Window
{
    private void someOp_Click(object sender, RoutedEventArgs e)
    {
        MyIntfPrx p = ...;

        // Call remote operation asynchronously.
        // Response is processed in UI thread.
        p.begin_someOp().whenCompleted(this.opResponse,
this.opException);
    }

    public void opResponse()
    {
        // Update UI...
    }

    public void opException(Ice.Exception ex)
    {
        // Update UI...
    }
}

```

Please see the `wpf` demo in your Ice distribution for a fully-functional UI client that uses this technique.

Objective-C Dispatcher API

To install a dispatcher, you must [initialize a communicator](#) with a callback (as an Objective-C block) in the `ICEInitializationData` structure. All invocations that arrive for this communicator are made via the specified callback. For example:

Objective-C

```

int
main(int argc, char* argv[])
{
    objc_startCollectorThread();
    id<ICECommunicator> communicator = nil;
    @try
    {
        ICEInitializationData* initData = [ICEInitializationData
initializationData];
        initData.dispatcher =
            ^(id<ICEDispatcherCall> call, id<ICEConnection> con)
            {
                // ...
            };
        communicator = [ICEUtil createCommunicator:&argc argv:argv
initData:initData];
        // ...
    }
    @catch(ICELocalException* ex)
    {
        // ...
    }

    // ...
}

```

The type of the dispatcher callback must match the following block signature:

Objective-C

```
void(^)(id<ICEDispatcherCall> call, id<ICEConnection> connection)
```

The Ice run time invokes the dispatcher callback whenever an operation invocation arrives, passing an object implementing the `ICEDispatcherCall` protocol and the connection via which the invocation arrived. The job of your callback implementation is to execute the given call.

The connection parameter allows you to decide how to dispatch the operation based on the connection via which it was received. This value may be `nil` if no connection currently exists.

You can write the callback such that it blocks and waits for completion of the invocation because the callback is called by a thread in the server-side thread pool (for incoming operation invocations) or the client-side thread pool (for AMI callbacks).

The `ICEDispatcherCall` protocol defines how to execute the incoming call:

Objective-C

```
@protocol ICEDispatcherCall <NSObject>
-(void) run;
@end
```

Your callback is expected to call `run` on the `ICEDispatcherCall` instance (or, more commonly, to cause `run` to be called some time later). When you call `run`, the Ice run time processes the invocation in the thread that calls `run`.

A very simple way to implement the dispatcher callback would be as follows:

Objective-C

```
void(^myDispatcher)(id<ICEDispatcherCall>, id<ICEConnection>) =
  ^(id<ICEDispatcherCall> call, id<ICEConnection> con)
  {
    // Does not throw, blocks until op completes.
    [call run];
  };
```

Whenever the Ice run time receives an incoming operation invocation or when an AMI invocation completes, it calls the dispatcher callback which, in turn, invokes the `run` method on the call.

With this simple example, the dispatcher callback immediately invokes `run`, and `run` does not return until the corresponding operation invocation is complete. As a result, this implementation ties up a thread in the thread pool for the duration of the call.

So far, we really have not gained anything because all we have is a callback method that is called by the Ice run time. However, this simple mechanism is sufficient to ensure that we can update a UI from the correct thread.

A common technique to avoid blocking is to use [asynchronous method invocation](#). In response to a UI event (such as the user pressing a "Submit" button), the application initiates an operation invocation from the corresponding UI callback by calling the operation's `begin_` method. This is guaranteed not to block the caller, so the UI remains responsive. Some time later, when the operation completes, the Ice run time invokes an AMI callback from one of the threads in its thread pool. That callback now has to update the UI, but that can only be done from the UI thread. By using a dispatcher, you can easily delegate the update to the correct thread. For example, here is how you can arrange for AMI callbacks to be passed to Cocoa or Cocoa Touch main thread:

Objective-C

```

-(void)viewDidLoad
{
    ICEInitializationData* initData = [ICEInitializationData
initializationData];
    initData.dispatcher =
        ^(id<ICEDispatcherCall> call, id<ICEConnection> con)
        {
            dispatch_sync(dispatch_get_main_queue(), ^ { [call run]; });
        };

    communicator = [[ICEUtil createCommunicator:initData] retain];

    // ....
}

```

The dispatcher callback calls `dispatch_sync` on the main queue. This queues the actual call for later execution by the main thread. Because the Ice run time does not invoke the dispatcher callback until an asynchronous operation invocation is complete, when the UI thread executes the corresponding call, that call does not block and the UI remains responsive.

The net effect is that you can invoke an operation asynchronously from a UI callback method without the risk of blocking the UI thread. For example:

Objective-C

```

-(void)someOp:(id)sender
{
    id<MyIntfPrx> p = ...;
    [p begin_someOp:^( [self response]; }
        exception:^(ICEException* ex) { [self exception:ex]; }];
}

-(void) response
{
    // Update UI...
}

-(void) exception:(ICEException* ex)
{
    // Update UI...
}

```

Please see the Cocoa or iPhone demos in your Ice Touch distribution for fully-functional UI clients that use this technique.

Dispatcher Implementation Notes

An application that uses a custom dispatcher must adhere to the following rules to avoid a deadlock:

- Dispatcher implementations must ensure that all requests are dispatched. Failing to dispatch all requests will cause `Communicator`

`::destroy` to hang indefinitely. If a dispatcher has resources that must be reclaimed (e.g., joining with a helper thread), it can safely do so after `Communicator::destroy` has completed.

- Never make a blocking invocation from the dispatch thread, such as a synchronous proxy operation or a proxy method that can potentially block, such as `ice_getConnection`. These invocations depend on the dispatcher for their own completion, therefore blocking the dispatch thread will inevitably lead to deadlock.

See Also

- [Asynchronous Method Invocation \(AMI\) in C++](#)
- [Asynchronous Method Invocation \(AMI\) in Java](#)
- [Asynchronous Method Invocation \(AMI\) in C-Sharp](#)
- [Asynchronous Method Invocation \(AMI\) in Objective-C](#)

Using Proxies

The introduction to proxies provided in [Terminology](#) describes a proxy as a local artifact that makes a remote invocation as easy to use as a regular function call. In fact, processing remote invocations is just one of a proxy's many responsibilities. A proxy also encapsulates the information necessary to contact the object, including its [identity](#) and addressing details such as [endpoints](#). [Proxy methods](#) provide access to configuration and connection information, and act as factories for creating new proxies. Finally, a proxy initiates the establishment of a [new connection](#) when necessary.

Topics

- [Obtaining Proxies](#)
- [Proxy Methods](#)
- [Proxy Endpoints](#)
- [Filtering Proxy Endpoints](#)
- [Proxy Defaults and Overrides](#)
- [Proxy and Endpoint Syntax](#)

See Also

- [Terminology](#)
- [Object Identity](#)
- [Proxy Methods](#)
- [Connection Establishment](#)

Obtaining Proxies

This page describes the ways an application can obtain a proxy.

On this page:

- [Obtaining a Proxy from a String](#)
- [Obtaining a Proxy from Properties](#)
- [Obtaining a Proxy using Factory Methods](#)
- [Obtaining a Proxy by Invoking Operations](#)

Obtaining a Proxy from a String

The communicator operation `stringToProxy` creates a proxy from its stringified representation, as shown in the following C++ example:

```
C++
```

```
Ice::ObjectPrx p = communicator->stringToProxy("ident:tcp -p 5000");
```

Obtaining a Proxy from Properties

Rather than hard-coding a stringified proxy as the previous example demonstrated, an application can gain more flexibility by externalizing the proxy in a configuration property. For example, we can define a property that contains our stringified proxy as follows:

```
MyApp.Proxy=ident:tcp -p 5000
```

We can use the communicator operation `propertyToProxy` to convert the property's value into a proxy, as shown below in Java:

```
Java
```

```
Ice.ObjectPrx p = communicator.propertyToProxy("MyApp.Proxy");
```

As an added convenience, `propertyToProxy` allows you to define subordinate properties that configure the proxy's local settings. The properties below demonstrate this feature:

```
MyApp.Proxy=ident:tcp -p 5000
MyApp.Proxy.PreferSecure=1
MyApp.Proxy.EndpointSelection=Ordered
```

These additional properties simplify the task of customizing a proxy (as you can with [proxy methods](#)) without the need to change the application's code. The properties shown above are equivalent to the following statements:

```
Java
```

```
Ice.ObjectPrx p = communicator.stringToProxy("ident:tcp -p 5000");
p = p.ice_preferSecure(true);
p = p.ice_endpointSelection(Ice.EndpointSelectionType.Ordered);
```

The list of [supported proxy properties](#) includes the most commonly-used proxy settings. The communicator prints a warning by default if it

does not recognize a subordinate property. You can disable this warning using the property `Ice.Warn.UnknownProperties`.

Note that proxy properties can themselves have proxy properties. For example, the following sets the `PreferSecure` property on the default locator's router:

```
Ice.Default.Locator.Router.PreferSecure=1
```

Obtaining a Proxy using Factory Methods

Proxy factory methods allow you to modify aspects of an existing proxy. Since proxies are immutable, factory methods always return a new proxy if the desired modification differs from the proxy's current configuration. Consider the following C# example:

```
C#
Ice.ObjectPrx p = communicator.stringToProxy("...");
p = p.ice_oneway();
```

`ice_oneway` is considered a factory method because it returns a proxy configured to use oneway invocations. If the original proxy uses a different invocation mode, the return value of `ice_oneway` is a new proxy object.

The `checkedCast` and `uncheckedCast` methods can also be considered factory methods because they return new proxies that are narrowed to a particular Slice interface. A call to `checkedCast` or `uncheckedCast` typically follows the use of other factory methods, as shown below:

```
C#
Ice.ObjectPrx p = communicator.stringToProxy("...");
Ice.LocatorPrx loc =
Ice.LocatorPrxHelper.checkedCast(p.ice_secure(true));
```

Note however that, once a proxy has been narrowed to a Slice interface, it is not normally necessary to perform another down-cast after using a factory method. For example, we can rewrite this example as follows:

```
C#
Ice.ObjectPrx p = communicator.stringToProxy("...");
Ice.LocatorPrx loc = Ice.LocatorPrxHelper.checkedCast(p);
loc = (Ice.LocatorPrx)p.ice_secure(true);
```

A language-specific cast may be necessary, as shown here for C#, because the factory methods are declared to return the type `ObjectPrx`, but the proxy object itself retains its narrowed type. The only exceptions are the factory methods `ice_facet` and `ice_identity`. Calls to either of these methods may produce a proxy for an object of an unrelated type, therefore they return a base proxy that you must subsequently down-cast to an appropriate type.

Obtaining a Proxy by Invoking Operations

An application can also obtain a proxy as the result of an Ice invocation. Consider the following Slice definitions:

Slice

```
interface Account { ... };  
interface Bank {  
    Account* findAccount(string id);  
};
```

Invoking the `findAccount` operation returns a proxy for an `Account` object. There is no need to use `checkedCast` or `uncheckedCast` on this proxy because it has already been narrowed to the `Account` interface. The C++ code below demonstrates how to invoke `findAccount`:

C++

```
BankPrx bank = ...  
AccountPrx acct = bank->findAccount(id);
```

Of course, the application must have already obtained a proxy for the bank object using one of the techniques shown above.

See Also

- [Communicators](#)
- [Proxy and Endpoint Syntax](#)
- [Proxy Methods](#)
- [Ice Proxy Properties](#)
- [Ice Warning Properties](#)

Proxy Methods

Although the core proxy functionality is supplied by a language-specific base class, we can describe the proxy methods in terms of Slice operations as shown below:

Slice
<pre> bool ice_isA(string id); void ice_ping(); StringSeq ice_ids(); string ice_id(); Communicator ice_getCommunicator(); string ice_toString(); Object* ice_identity(Identity id); Identity ice_getIdentity(); Object* ice_adapterId(string id); string ice_getAdapterId(); Object* ice_endpoints(EndpointSeq endpoints); EndpointSeq ice_getEndpoints(); Object* ice_endpointSelection(EndpointSelectionType t); EndpointSelectionType ice_getEndpointSelection(); Object* ice_context(Context ctx); Context ice_getContext(); Object* ice_defaultContext(); Object* ice_facet(string facet); string ice_getFacet(); Object* ice_twoway(); bool ice_isTwoway(); Object* ice_oneway(); bool ice_isOneway(); Object* ice_batchOneway(); bool ice_isBatchOneway(); Object* ice_datagram(); bool ice_isDatagram(); Object* ice_batchDatagram(); bool ice_isBatchDatagram(); Object* ice_secure(bool b); bool ice_isSecure(); EncodingVersion ice_getEncodingVersion(); Object* ice_encodingVersion(EncodingVersion v); Object* ice_preferSecure(bool b); bool ice_isPreferSecure(); Object* ice_compress(bool b); Object* ice_timeout(int timeout); Object* ice_router(Router* rtr); Router* ice_getRouter(); Object* ice_locator(Locator* loc); Locator* ice_getLocator(); Object* ice_locatorCacheTimeout(int seconds); int ice_getLocatorCacheTimeout(); Object* ice_collocationOptimized(bool b); </pre>

```
bool ice_isCollocationOptimized();  
Object* ice_connectionId(string id);  
string ice_getConnectionId();  
Connection ice_getConnection();  
Connection ice_getCachedConnection();  
Object* ice_connectionCached(bool b);  
bool ice_isConnectionCached();  
void ice_flushBatchRequests();
```

```
bool ice_invoke(string operation, OperationMode mode,
               ByteSeq inParams, out ByteSeq outParams);
```

These methods can be categorized as follows:

- Remote inspection: methods that return information about the remote object. These methods make remote invocations and therefore accept an optional trailing argument of type `Ice::Context`.
- Local inspection: methods that return information about the proxy's local configuration.
- Factory: methods that return new proxy instances configured with different features.
- Request processing: methods that flush batch requests and send "dynamic" Ice invocations.

Proxies are immutable, so factory methods allow an application to obtain a new proxy with the desired configuration. Factory methods essentially clone the original proxy and modify one or more features of the new proxy.

Many of the factory methods are not supported by [fixed proxies](#), which are used in conjunction with [bidirectional connections](#). Attempting to invoke one of these methods causes the Ice run time to raise `FixedProxyException`.

The core proxy methods are explained in greater detail in the following table:

Method	Description	Remote
<code>ice_isA</code>	Returns <code>true</code> if the remote object supports the type indicated by the <code>id</code> argument, otherwise <code>false</code> . This method can only be invoked on a twoway proxy.	Yes
<code>ice_ping</code>	Determines whether the remote object is reachable. Does not return a value.	Yes
<code>ice_ids</code>	Returns the type IDs of the types supported by the remote object. The return value is an array of strings. This method can only be invoked on a twoway proxy.	Yes
<code>ice_id</code>	Returns the type ID of the most-derived type supported by the remote object. This method can only be invoked on a twoway proxy.	Yes
<code>ice_getCommunicator</code>	Returns the communicator that was used to create this proxy.	No
<code>ice_toString</code>	Returns the string representation of the proxy.	No
<code>ice_identity</code>	Returns a new proxy having the given identity .	No
<code>ice_getIdentity</code>	Returns the identity of the Ice object represented by the proxy.	No
<code>ice_adapterId</code>	Returns a new proxy having the given adapter ID .	No
<code>ice_getAdapterId</code>	Returns the proxy's adapter ID , or an empty string if no adapter ID is configured.	No
<code>ice_endpoints</code>	Returns a new proxy having the given endpoints .	No

<code>ice_getEndpoints</code>	Returns a sequence of <code>Endpoint</code> objects representing the proxy's endpoints.	No
<code>ice_endpointSelection</code>	Returns a new proxy having the given <code>endpoint selection</code> policy (random or ordered).	No
<code>ice_getEndpointSelection</code>	Returns the <code>endpoint selection</code> policy for the proxy.	No
<code>ice_context</code>	Returns a new proxy having the given <code>request context</code> .	No
<code>ice_getContext</code>	Returns the <code>request context</code> associated with the proxy.	No
<code>ice_facet</code>	Returns a new proxy having the given <code>facet name</code> .	No
<code>ice_getFacet</code>	Returns the name of the <code>facet</code> associated with the proxy, or an empty string if no facet has been set.	No
<code>ice_twoway</code>	Returns a new proxy for making twoway invocations.	No
<code>ice_isTwoway</code>	Returns <code>true</code> if the proxy uses twoway invocations, otherwise <code>false</code> .	No
<code>ice_oneway</code>	Returns a new proxy for making oneway invocations.	No
<code>ice_isOneway</code>	Returns <code>true</code> if the proxy uses oneway invocations, otherwise <code>false</code> .	No
<code>ice_batchOneway</code>	Returns a new proxy for making <code>batch oneway invocations</code> .	No
<code>ice_isBatchOneway</code>	Returns <code>true</code> if the proxy uses batch oneway invocations, otherwise <code>false</code> .	No
<code>ice_datagram</code>	Returns a new proxy for making <code>datagram invocations</code> .	No
<code>ice_isDatagram</code>	Returns <code>true</code> if the proxy uses <code>datagram invocations</code> , otherwise <code>false</code> .	No
<code>ice_batchDatagram</code>	Returns a new proxy for making <code>batch datagram invocations</code> .	No
<code>ice_isBatchDatagram</code>	Returns <code>true</code> if the proxy uses <code>batch datagram invocations</code> , otherwise <code>false</code> .	No
<code>ice_secure</code>	Returns a new proxy whose endpoints may be <code>filtered</code> depending on the boolean argument. If <code>true</code> , only endpoints using secure transports are allowed, otherwise all endpoints are allowed.	No
<code>ice_getEncodingVersion</code>	Returns the <code>encoding</code> version that is used to encode requests invoked on this proxy.	No

<code>ice_encodingVersion</code>	Returns a new proxy that uses the given encoding version to encode requests. Raises <code>UnsupportedEncodingException</code> if the version is invalid.	No
<code>ice_isSecure</code>	Returns <code>true</code> if the proxy uses only secure endpoints, otherwise <code>false</code> .	No
<code>ice_preferSecure</code>	Returns a new proxy whose endpoints are filtered depending on the boolean argument. If <code>true</code> , endpoints using secure transports are given precedence over endpoints using non-secure transports. If <code>false</code> , the default behavior gives precedence to endpoints using non-secure transports.	No
<code>ice_isPreferSecure</code>	Returns <code>true</code> if the proxy prefers secure endpoints, otherwise <code>false</code> .	No
<code>ice_compress</code>	Returns a new proxy whose protocol compression capability is determined by the boolean argument. If <code>true</code> , the proxy uses protocol compression if it is supported by the endpoint. If <code>false</code> , protocol compression is never used.	No
<code>ice_timeout</code>	Returns a new proxy with the given timeout value in milliseconds. A value of <code>-1</code> disables timeouts.	No
<code>ice_router</code>	Returns a new proxy configured with the given router proxy.	No
<code>ice_getRouter</code>	Returns the router that is configured for the proxy (null if no router is configured).	No
<code>ice_locator</code>	Returns a new proxy with the specified locator .	No
<code>ice_getLocator</code>	Returns the locator that is configured for the proxy (null if no locator is configured).	No
<code>ice_locatorCacheTimeout</code>	Returns a new proxy with the specified locator cache timeout. When binding a proxy to an endpoint, the run time caches the proxy returned by the locator and uses the cached proxy while the cached proxy has been in the cache for less than the timeout. Proxies older than the timeout cause the run time to rebind via the locator. A value of <code>0</code> disables caching entirely, and a value of <code>-1</code> means that cached proxies never expire. The default value is <code>-1</code> .	No
<code>ice_getLocatorCacheTimeout</code>	Returns the locator cache timeout value in seconds.	No

<code>ice_collocationOptimized</code>	Returns a new proxy configured for collocation optimization . If <code>true</code> , collocated optimizations are enabled. The default value is <code>true</code> .	No
<code>ice_isCollocationOptimized</code>	Returns <code>true</code> if the proxy uses collocation optimization , otherwise <code>false</code> .	No
<code>ice_connectionId</code>	Returns a new proxy having the given connection ID .	No
<code>ice_getConnectionId</code>	Returns the connection ID , or an empty string if no connection ID has been configured.	No
<code>ice_getConnection</code>	Returns an object representing the connection used by the proxy. If the proxy is not currently associated with a connection, the Ice run time attempts to establish a connection first.	No
<code>ice_getCachedConnection</code>	Returns an object representing the connection used by the proxy, or null if the proxy is not currently associated with a connection.	No
<code>ice_connectionCached</code>	Enables or disables connection caching for the proxy.	No
<code>ice_isConnectionCached</code>	Returns <code>true</code> if the proxy uses connection caching , otherwise <code>false</code> .	No
<code>ice_flushBatchRequests</code> <code>begin_ice_flushBatchRequests</code>	Sends a batch of operation invocations synchronously or asynchronously.	Yes
<code>ice_invoke</code> <code>begin_ice_invoke</code>	Allows dynamic invocation of an operation without the need for compiled Slice definitions. Requests can be sent synchronously or asynchronously .	Yes

See Also

- [Request Contexts](#)
- [Oneway Invocations](#)
- [Batched Invocations](#)
- [Facets and Versioning](#)
- [Connection Timeouts](#)
- [Connection Establishment](#)
- [Using Connections](#)
- [Dynamic Invocation and Dispatch](#)
- [Asynchronous Dynamic Invocation and Dispatch](#)
- [Bidirectional Connections](#)
- [Glacier2](#)
- [Data Encoding](#)

Proxy Endpoints

Proxy endpoints are the client-side equivalent of [object adapter endpoints](#). A proxy endpoint identifies the protocol information used to contact a remote object, as shown in the following example:

```
tcp -h www.zeroc.com -p 10000
```

This endpoint states that an object is reachable via TCP on the host `www.zeroc.com` and the port `10000`.

A proxy must have, or be able to obtain, at least one endpoint in order to be useful. A *direct proxy* contains one or more endpoints:

```
MyObject:tcp -h www.zeroc.com -p 10000:ssl -h www.zeroc.com -p 10001
```

In this example the object with the identity `MyObject` is available at two separate endpoints, one using TCP and the other using SSL.

If a direct proxy does not contain the `-h` option (that is, no host is specified), the Ice run time uses the value of the `Ice.Default.Host` property. If `Ice.Default.Host` is not defined, the `localhost` interface is used.

An *indirect proxy* uses a [locator](#) to retrieve the endpoints dynamically. One style of indirect proxy contains an adapter identifier:

```
MyObject @ MyAdapter
```

When this proxy requires the endpoints associated with `MyAdapter`, it requests them from the locator.

See Also

- [Terminology](#)
- [Object Adapter Endpoints](#)
- [Locators](#)

Filtering Proxy Endpoints

A proxy's configuration determines how its [endpoints](#) are used. For example, a proxy configured for secure communication will only use endpoints having a secure protocol, such as SSL.

The [factory methods](#) listed in the table below allow applications to manipulate endpoints indirectly. Calling one of these methods returns a new proxy whose endpoints are used in accordance with the proxy's new configuration.

Method	Description
<code>ice_secure</code>	Selects only endpoints using a secure protocol (e.g., SSL).
<code>ice_datagram</code>	Selects only endpoints using a datagram protocol (e.g., UDP).
<code>ice_batchDatagram</code>	Selects only endpoints using a datagram protocol (e.g., UDP).
<code>ice_twoway</code>	Selects only endpoints capable of making twoway invocations (e.g., TCP, SSL). For example, this disables datagram endpoints.
<code>ice_oneway</code>	Selects only endpoints capable of making reliable oneway invocations (e.g., TCP, SSL). For example, this disables datagram endpoints.
<code>ice_batchOneway</code>	Selects only endpoints capable of making reliable oneway batch invocations (e.g., TCP, SSL). For example, this disables datagram endpoints.

Upon return, the set of endpoints in the new proxy is unchanged from the old one. However, the new proxy's configuration drives a filtering process that the Ice run time performs during [connection establishment](#).

The factory methods do not raise an exception if they produce a proxy with no viable endpoints. For example, the C++ statement below creates such a proxy:

C++

```
proxy = comm->stringToProxy("id:tcp -p 10000")->ice_datagram();
```

It is always possible that a proxy could become viable after additional factory methods are invoked, therefore the Ice run time does not raise an exception until connection establishment is attempted. At that point, the application can expect to receive `NoEndpointException` if the filtering process eliminates all endpoints.

An application can also create a proxy with a specific set of endpoints using the `ice_endpoints` factory method, whose only argument is a sequence of `Ice::Endpoint` objects. At present, an application is not able to create new instances of `Ice::Endpoint`, but rather can only incorporate instances obtained by calling `ice_getEndpoints` on a proxy. Note that `ice_getEndpoints` may return an empty sequence if the proxy has no endpoints, as is the case with an [indirect proxy](#).

See Also

- [Proxy Endpoints](#)
- [Proxy Methods](#)
- [Connection Establishment](#)

Proxy Defaults and Overrides

It is important to understand how proxies are influenced by Ice configuration properties and settings. The relevant properties can be classified into two categories: defaults and overrides.

On this page:

- [Proxy Default Properties](#)
- [Proxy Override Properties](#)

Proxy Default Properties

Default properties affect proxies created as the result of an Ice invocation, or by calling `stringToProxy` or `propertyToProxy` on a `communicator`. These properties do not influence proxies created by **proxy factory methods**.

For example, suppose we define the following default property:

```
Ice.Default.PreferSecure=1
```

We can verify that the property has the desired affect using the following C++ code:

```
C++
```

```
Ice::ObjectPrx p = communicator->stringToProxy(...);
assert(p->ice_isPreferSecure());
```

Furthermore, we can verify that the property does not affect proxies returned by factory methods:

```
Ice::ObjectPrx p2 = p->ice_preferSecure(false);
assert(!p2->ice_isPreferSecure());
Ice::ObjectPrx p3 = p2->ice_oneway();
assert(!p3->ice_isPreferSecure());
```

Proxy Override Properties

Defining an **override property** causes the Ice run time to ignore any equivalent proxy setting and use the override property value instead. For example, consider the following property definition:

```
Ice.Override.Secure=1
```

This property instructs the Ice run time to use only secure endpoints, producing the same semantics as calling `ice_secure(true)` on every proxy. However, the property does not alter the settings of an existing proxy, but rather directs the Ice run time to use secure endpoints regardless of the proxy's security setting. We can verify that this is the case using the following C++ code:

```
C++
```

```
Ice::ObjectPrx p = communicator->stringToProxy(...);
p = p->ice_secure(false);
assert(!p->ice_isSecure()); // The security setting is retained.
```

See Also

- [Communicators](#)
- [Ice Default and Override Properties](#)

Proxy and Endpoint Syntax

On this page:

- [Syntax for Stringified Proxies](#)
- [Syntax for Stringified Endpoints](#)
 - [Address Syntax](#)
 - [TCP Endpoint Syntax](#)
 - [UDP Endpoint Syntax](#)
 - [SSL Endpoint Syntax](#)
 - [Opaque Endpoint Syntax](#)

Syntax for Stringified Proxies

Synopsis

```
identity -f facet -e encoding -p protocol -t -o -O -d -D -s @ adapter_id : endpoints
```

Description

A stringified proxy consists of an identity, proxy options, and an optional object adapter identifier or endpoint list. White space (the space, tab (\t), line feed (\n), and carriage return (\r) characters) act as token delimiters; if a white space character appears as part of a component of a stringified proxy (such as the identity), it must be quoted or escaped as described below.

A proxy containing an identity with no endpoints, or an identity with an object adapter identifier, represents an indirect proxy that will be resolved using the [Ice locator](#).

Proxy options configure the invocation mode:

<code>-f <i>facet</i></code>	Select a facet of the Ice object.
<code>-e <i>encoding</i></code>	Specify the Ice encoding version to use when an invocation on this proxy marshals parameters.
<code>-p <i>protocol</i></code>	Specify the Ice protocol version to use when sending a request with this proxy.
<code>-t</code>	Configures the proxy for twoway invocations (default).
<code>-o</code>	Configures the proxy for oneway invocations.
<code>-O</code>	Configures the proxy for batch oneway invocations.
<code>-d</code>	Configures the proxy for datagram invocations.
<code>-D</code>	Configures the proxy for batch datagram invocations.
<code>-s</code>	Configures the proxy for secure invocations.

The proxy options `-t`, `-o`, `-O`, `-d`, and `-D` are mutually exclusive.

The object identity *identity* is structured as [*category*/]*name*, where the *category* component and slash separator are optional. If *identity* contains white space or either of the characters `:` or `@`, it must be enclosed in single or double quotes. The *category* and *name* components are UTF-8 strings that use the encoding described below. Any occurrence of a slash (`/`) in *category* or *name* must be escaped with a backslash (i.e., `\`).

The *facet* argument of the `-f` option represents a [facet](#) name. If *facet* contains white space, it must be enclosed in single or double quotes. A facet name is a UTF-8 string that uses the encoding described below.

The object adapter identifier *adapter_id* is a UTF-8 string that uses the encoding described below. If *adapter_id* contains white space, it must be enclosed in single or double quotes.

Single or double quotes can be used to prevent white space characters from being interpreted as delimiters. Double quotes prevent interpretation of a single quote as an opening or closing quote, for example:

```
"a string with a ' quote"
```

Single quotes prevent interpretation of a double quote as an opening or closing quote. For example:

```
'a string with a " quote'
```

Escape sequences such as `\b` are interpreted within single and double quotes.

UTF-8 strings are encoded using ASCII characters for the ordinal range 32--126 (inclusive). Characters outside this range must be encoded using escape sequences (`\b`, `\f`, `\n`, `\r`, `\t`) or octal notation (e.g., `\007`). Single and double quotes can be escaped using a backslash, as can the backslash itself.

If *endpoints* are specified, they must be separated with a colon (`:`) and formatted as described in the [endpoint syntax](#). The order of endpoints in the stringified proxy is not necessarily the order in which connections are attempted during binding: when a stringified proxy is converted into a proxy instance, by default, the endpoint list is randomized as a form of load balancing. You can change this default behavior using the properties `Ice.Default.EndpointSelection` and `name.EndpointSelection`.

If the `-s` option is specified, only those endpoints that support secure invocations are considered during binding. If no valid endpoints are found, the application receives `Ice::NoEndpointException`.

Otherwise, if the `-s` option is not specified, the endpoint list is ordered so that non-secure endpoints have priority over secure endpoints during binding. In other words, connections are attempted on all non-secure endpoints before any secure endpoints are attempted.

The `-e` and `-p` options specify the encoding and protocol versions supported by the target object, respectively. The Ice run time in the client is responsible for using a compatible version of the encoding or protocol, where *compatible* means the same major version and a minor version that is equal to or less than the specified minor version. If the `-e` option is not defined, the proxy uses the default version specified by `Ice.Default.EncodingVersion`.

If an unknown option is specified, or the stringified proxy is malformed, the application receives `Ice::ProxyParseException`. If an endpoint is malformed, the application receives `Ice::EndpointParseException`.

Syntax for Stringified Endpoints

Synopsis

```
endpoint : endpoint
```

Description

An endpoint list comprises one or more endpoints separated by a colon (`:`).

An endpoint has the following format:

```
protocol option
```

The supported protocols are `tcp`, `udp`, `ssl`, and `default`. If `default` is used, it is replaced by the value of the `Ice.Default.Protocol` property. If an endpoint is malformed, or an unknown protocol is specified, the application receives `Ice::EndpointParseException`. The `ssl` protocol is only available if the `IceSSL` plug-in is installed.

Ice uses endpoints for two similar but distinct purposes:

1. In a client context (that is, in a proxy), endpoints determine how Ice establishes a connection to a server.
2. In a server context (that is, in an object adapter's configuration), endpoints define the addresses and transports over which new

incoming connections are accepted. These endpoints are also embedded in the proxies created by the object adapter, unless a separate set of "published" endpoints are explicitly configured.

The sections that follow discuss the addressing component of endpoints, as well as the protocols and their supported options.

 See [Object Adapter Endpoints](#) for examples.

Address Syntax

Synopsis

host : *hostname* | *x.x.x.x* (IPv4)

host : *hostname* | "*:x:x:x:x:x:x*" (IPv6)

Description

Ice supports Internet Protocol (IP) versions 4 and 6 in all language mappings.

 IPv6 is not supported when using Ice for Java with Java 6 on Windows due to a [limitation](#) in the JVM.

Support for these protocols is configured using the properties `Ice.IPv4` and `Ice.IPv6` (both enabled by default).

In the endpoint descriptions below, the *host* parameter represents either a host name that is resolved via the Domain Name System (DNS), an IPv4 address in dotted quad notation, or an IPv6 address in 128-bit hexadecimal format and enclosed in double quotes. Due to limitation of the DNS infrastructure, host and domain names are restricted to the ASCII character set.

The presence (or absence) of the *host* parameter has a significant influence on the behavior of the Ice run time. The table below describes these semantics:

Value	Client Semantics	Server Semantics
None	If <i>host</i> is not specified in a proxy, Ice uses the value of the <code>Ice.Default.Host</code> property. If that property is not defined, outgoing connections are only attempted over loopback interfaces.	If <i>host</i> is not specified in an object adapter endpoint, Ice uses the value of the <code>Ice.Default.Host</code> property. If that property is not defined, the adapter behaves as if the wildcard symbol <code>*</code> was specified (see below).
Host name	The host name is resolved via DNS. Outgoing connections are attempted to each address returned by the DNS query.	The host name is resolved via DNS, and the object adapter listens on the network interfaces corresponding to each address returned by the DNS query. The specified host name is embedded in proxies created by the adapter.
IPv4 address	An outgoing connection is attempted to the given address.	The object adapter listens on the network interface corresponding to the address. The specified address is embedded in proxies created by the adapter.
IPv6 address	An outgoing connection is attempted to the given address.	The object adapter listens on the network interface corresponding to the address. The specified address is embedded in proxies created by the adapter.
0.0.0.0 (IPv4)	A "wildcard" IPv4 address that causes Ice to try all local interfaces when establishing an outgoing connection.	Equivalent to <code>*</code> (see below).

" :: " (IPv6)	A "wildcard" IPv6 address that causes Ice to try all local interfaces when establishing an outgoing connection.	Equivalent to * (see below).
* (IPv4, IPv6)	Not supported in proxies.	The adapter listens on all network interfaces (including the loopback interface), that is, binds to INADDR_ANY for the enabled protocols (IPv4 and/or IPv6). Endpoints for all addresses except loopback and IPv6 link-local are published in proxies (unless loopback is the only available interface, in which case only loopback is published). Using Mono, proxies created by an object adapter listening on the IPv6 wildcard address contain only the IPv6 loopback address unless published endpoints are configured.

There is one additional benefit in specifying a wildcard address for *host* (or not specifying it at all) in an object adapter's endpoint: if the list of network interfaces on a host may change while the application is running, using a wildcard address for *host* ensures that the object adapter automatically includes the updated interfaces. Note however that the list of published endpoints is not changed automatically; rather, the application must explicitly [refresh the object adapter's endpoints](#). For diagnostic purposes, you can set the configuration property `Ice.Trace.Network=3` to cause Ice to log the current list of local addresses that it is substituting for the wildcard address.

When IPv4 and IPv6 are enabled, an object adapter endpoint that uses an IPv6 (or wildcard) address can accept both IPv4 and IPv6 connections. This is true for all supported platforms except Windows XP and Windows Server 2003, where you must define separate IPv4 and IPv6 endpoints if you want the object adapter to accept both types of connections.

Java's default network stack always accepts both IPv4 and IPv6 connections regardless of the settings of `Ice.IPv6`. You can configure the Java run time to use only IPv4 by starting your application with the following JVM option:

Java

```
java -Djava.net.preferIPv4Stack=true ...
```

TCP Endpoint Syntax

Synopsis

```
tcp -h host -p port -t timeout -z
```

Description

A `tcp` endpoint supports the following options:

Option	Description	Client Semantics	Server Semantics
-h <i>host</i>	Specifies the host name or IP address of the endpoint. If not specified, the value of <code>Ice.Default.Host</code> is used instead.	See #Address Syntax .	See #Address Syntax .
-p <i>port</i>	Specifies the port number of the endpoint.	Determines the port to which a connection attempt is made (required).	The port will be selected by the operating system if this option is not specified or <i>port</i> is zero.

<code>-t <i>timeout</i></code>	Specifies the endpoint timeout in milliseconds.	If <i>timeout</i> is greater than zero, it specifies the timeout used by the client to open or close connections and to read or write data. It also specifies how long the run time waits for an invocation to complete. If a timeout occurs, the application receives <code>Ice::TimeoutException</code> .	If <i>timeout</i> is greater than zero, it specifies the timeout used by the server to accept or close connections and to read or write data (see Timeouts in Object Adapter Endpoints and Connection Timeouts). <i>timeout</i> also controls the timeout that is published in proxies created by the object adapter.
<code>-z</code>	Specifies bzip2 compression.	Determines whether compressed requests are sent.	Determines whether compression is advertised in proxies created by the adapter.

UDP Endpoint Syntax

Synopsis

```
udp -h host -p port -z --ttl TTL --interface INTF
```

Description

A `udp` endpoint supports either unicast or multicast delivery; the address resolved by *host* argument determines the delivery mode. To use multicast in IPv4, select an IP address in the range 233.0.0.0 to 239.255.255.255. In IPv6, use an address that begins with `ff`, such as `ff01::1:1`.

A `udp` endpoint supports the following options:

Option	Description	Client Semantics	Server Semantics
<code>-h <i>host</i></code>	Specifies the host name or IP address of the endpoint. If not specified, the value of <code>Ice.Default.Host</code> is used instead.	See #Address Syntax .	See #Address Syntax .
<code>-p <i>port</i></code>	Specifies the port number of the endpoint.	Determines the port to which datagrams are sent (required).	The port will be selected by the operating system if this option is not specified or port is zero.
<code>-z</code>	Specifies bzip2 compression.	Determines whether compressed requests are sent.	Determines whether compression is advertised in proxies created by the adapter.
<code>--ttl <i>TTL</i></code>	Specifies the time-to-live (also known as "hops") of multicast messages.	Determines whether multicast messages are forwarded beyond the local network. If not specified, or the value of <i>TTL</i> is <code>-1</code> , multicast messages are not forwarded. The maximum value is 255.	N/A
<code>--interface <i>INTF</i></code>	Specifies the network interface or group for multicast messages (see below).	Selects the network interface for outgoing multicast messages. If not specified, multicast messages are sent using the default interface.	Selects the network interface to use when joining the multicast group. If not specified, the group is joined on the default network interface.

**Deprecated options**

With the 1.0 encoding, UDP endpoints supported 2 additional options: the `-e major.minor` and `-v major.minor` options. These 2 options specified which encoding and protocol was supported by the endpoint. These two options are deprecated with the 1.1 encoding and are ignored (a deprecation warning will be emitted when parsed by the communicator `stringToProxy` method). The supported protocol and encoding is specified on the proxy with the 1.1 encoding.

Multicast Interfaces

When *host* denotes a multicast address, the `--interface INTF` option selects a particular network interface to be used for communication. The format of *INTF* depends on the language and IP version:

- C++ and .NET (IPv4)
INTF can be an interface name, such as `eth0`, or an IP address. Interface names on Windows may contain spaces, such as `Local Area Connection`, therefore they must be enclosed in double quotes.
- C++ and .NET (IPv6)
INTF can be an interface name, such as `eth0`, or an interface index.
- Java
INTF can be an interface name, such as `eth0`, or an IP address. On Windows, Java maps interface names to Unix-style nicknames.

SSL Endpoint Syntax**Synopsis**

```
ssl -h host -p port -t timeout -z
```

Description

An `ssl` endpoint supports the following options:

Option	Description	Client Semantics	Server Semantics
<code>-h <i>host</i></code>	Specifies the host name or IP address of the endpoint. If not specified, the value of <code>Ice.Default.Host</code> is used instead.	See #Address Syntax .	See #Address Syntax .
<code>-p <i>port</i></code>	Specifies the port number of the endpoint.	Determines the port to which a connection attempt is made (required).	The port will be selected by the operating system if this option is not specified or port is zero.
<code>-t <i>timeout</i></code>	Specifies the endpoint timeout in milliseconds.	If <i>timeout</i> is greater than zero, it specifies the timeout used by the client to open or close connections and to read or write data. It also specifies how long the run time waits for an invocation to complete. If a timeout occurs, the application receives <code>Ice::TimeoutException</code> .	If <i>timeout</i> is greater than zero, it specifies the timeout used by the server to accept or close connections and to read or write data (see Timeouts in Object Adapter Endpoints and Connection Timeouts). <i>timeout</i> also controls the timeout that is published in proxies created by the object adapter.
<code>-z</code>	Specifies bzip2 compression.	Determines whether compressed requests are sent.	Determines whether compression is advertised in proxies created by the adapter.

Opaque Endpoint Syntax

Synopsis

```
opaque -t type -e encoding -v value
```

Description

Proxies can contain endpoints that are not universally understood by Ice processes. For example, a proxy can contain an SSL endpoint; if that proxy is marshaled to a receiver without the IceSSL plug-in, the SSL endpoint does not make sense to the receiver.

Ice preserves such unknown endpoints when they are received over the wire. For the preceding example, if the receiver remarshals the proxy and sends it back to an Ice process that does have the IceSSL plug-in, that process can invoke on the proxy using its SSL transport. This mechanism allows proxies containing endpoints for arbitrary transports to pass through processes that do not understand these endpoints without losing information.

If an Ice process stringifies a proxy containing an unknown endpoint, it writes the endpoint as an opaque endpoint. For example:

```
opaque -t 2 -e 1.0 -v CTEyNy4wLjAuMREnAAD/////AA==
```

This is how a process without the IceSSL plug-in stringifies an SSL endpoint. When a process with the IceSSL plug-in unstringifies this endpoint and converts it back into a string, it produces:

```
ssl -h 127.0.0.1 -p 10001
```

An `opaque` endpoint supports the following options:

Option	Description
<code>-t <i>type</i></code>	Specifies the transport for the endpoint. Transports are indicated by positive integers (1 for TCP, 2 for SSL, and 3 for UDP).
<code>-e <i>encoding</i></code>	Specifies the encoding version used to encode the endpoint marshaled data.
<code>-v <i>value</i></code>	Specifies the marshaled encoding of the endpoint in base-64 encoding.

Exactly one each of the `-t` and `-v` options must be present in an opaque endpoint. If `-e` is not specified, the current encoding supported by the Ice runtime is assumed.

See Also

- [The Ice Protocol](#)
- [Object Adapter Endpoints](#)
- [Connection Timeouts](#)

Request Contexts

Methods on a proxy are overloaded with a trailing parameter representing a *request context*. The Slice definition of this parameter is as follows:

```

Slice



```
module Ice {
 dictionary<string, string> Context;
};
```

```

As you can see, a context is a dictionary that maps strings to strings or, conceptually, a context is a collection of name-value pairs. The contents of this dictionary (if any) are implicitly marshaled with every request to the server, that is, if the client populates a context with a number of name-value pairs and uses that context for an invocation, the name-value pairs that are sent by the client are available to the server.

On the server side, the operation implementation can access the received `Context` via the `ctx` member of the `Ice::Current` parameter and extract the name-value pairs that were sent by the client.

Context names beginning with an underscore are reserved for use by Ice.

Topics

- [Explicit Request Contexts](#)
- [Per-Proxy Request Contexts](#)
- [Implicit Request Contexts](#)
- [Design Considerations for Request Contexts](#)

See Also

- [The Current Object](#)

Explicit Request Contexts

[Request contexts](#) provide a means of sending an unlimited number of parameters from client to server without having to mention these parameters in the signature of an operation. For example, consider the following definition:

```

Slice



```

struct Address {
 // ...
};

interface Person {
 string setAddress(Address a);
 // ...
};

```

```

Assuming that the client has a proxy to a `Person` object, it could do something along the following lines:

```

C++



```

PersonPrx p = ...;
Address a = ...;

Ice::Context ctx;
ctx["write policy"] = "immediate";

p->setAddress(a, ctx);

```

```

In Java, the same code would look as follows:

```

Java



```

PersonPrx p = ...;
Address a = ...;

java.util.Map<String, String> ctx = new java.util.HashMap<String,
String>();
ctx.put("write policy", "immediate");

p.setAddress(a, ctx);

```

```

In C#, the code is almost identical:

C#

```
using System.Collections.Generic;

PersonPrx p = ...;
Address a = ...;

Dictionary<string, string> ctx = new Dictionary<string, string>();
ctx["write policy"] = "immediate";

p.setAddress(a, ctx);
```

On the server side, we can extract the policy value set from the `Current` object to influence how the implementation of `setAddress` works. A C++ implementation might look like this:

C++

```
void
PersonI::setAddress(const Address& a, const Ice::Current& c)
{
    Ice::Context::const_iterator i = c.ctx.find("write policy");
    if (i != c.ctx.end() && i->second == "immediate") {

        // Update the address details and write through to the
        // data base immediately...

    } else {

        // Write policy was not set (or had a bad value), use
        // some other database write strategy.

    }
}
```

For this example, the server examines the value of the context with the key `"write policy"` and, if that value is `"immediate"`, writes the update sent by the client straight away; if the write policy is not set or contains a value that is not recognized, the server presumably applies a more lenient write policy (such as caching the update in memory and writing it later).

See Also

- [Request Contexts](#)
- [The Current Object](#)

Per-Proxy Request Contexts

Instead of passing a context [explicitly](#) with an invocation, you can also use a *per-proxy context*. Per-proxy contexts allow you to set a context on a particular proxy once and, thereafter, whenever you use that proxy to invoke an operation, the previously-set context is sent with each invocation. The [proxy methods](#) `ice_context` and `ice_getContext` set and retrieve the context, respectively. The Slice definitions of these methods would look as follows:

Slice
<pre>Object* ice_context(Context ctx); Context ice_getContext();</pre>

`ice_context` creates a new proxy that stores the given context. Calling `ice_getContext` returns the stored context, or an empty dictionary if no per-proxy context has been configured for the proxy.

Here is an example in C++:

C++
<pre>Ice::Context ctx; ctx["write policy"] = "immediate"; PersonPrx p1 = ...; PersonPrx p2 = p1->ice_context(ctx); Address a = ...; p1->setAddress(a); // Sends no context p2->setAddress(a); // Sends ctx implicitly Ice::Context ctx2; ctx2["write policy"] = "delayed"; p2->setAddress(a, ctx2); // Sends ctx2 instead</pre>

As the example illustrates, once we have created the `p2` proxy, any invocation via `p2` automatically sends the configured context. The final line of the example shows that it is also possible to explicitly send a context for an invocation even if the proxy is configured with a context — an explicit context always overrides any per-proxy context.

Note that, once you have set a per-proxy context, that context becomes immutable: if you subsequently change the context you have passed to `ice_context`, such a change does not affect the per-proxy context of any proxies you previously created with that context because each proxy on which you set a per-proxy context stores its own copy of the dictionary.

See Also

- [Explicit Request Contexts](#)
- [Proxy Methods](#)

Implicit Request Contexts

On this page:

- [Using Implicit Request Contexts](#)
- [Scope of the Implicit Context](#)

Using Implicit Request Contexts

In addition to [explicit](#) and [per-proxy](#) request contexts, you can also establish an implicit context on a communicator. This implicit context is sent with all invocations made via proxies created by that communicator, provided that you do not supply an explicit context with the call.

Access to this implicit context is provided by the `Communicator` interface:

```

Slice
module Ice {
    local interface Communicator
    {
        ImplicitContext getImplicitContext();

        // ...
    };
};

```

`getImplicitContext` returns the implicit context object. If a communicator has no implicit context, the operation returns null.

You can manipulate the contents of the implicit context via the `ImplicitContext` interface:

```

Slice
local interface ImplicitContext
{
    Context getContext();
    void setContext(Context newContext);

    string get(string key);
    string put(string key, string value);
    string remove(string key);
    bool containsKey(string key);
};

```

The `getContext` operation returns the currently-set context dictionary. The `setContext` operation replaces the currently-set context in its entirety.

The remaining operations allow you to manipulate specific entries:

- `get`
This operation returns the value associated with `key`. If `key` was not previously set, the operation returns the empty string.
- `put`
This operation adds the key-value pair specified by `key` and `value`. It returns the previous value associated with `key`; if no value was previously associated with `key`, it returns the empty string. It is legal to add the empty string as a value.

- `remove`
This operation removes the key-value pair specified by `key`. It returns the previously-set value (or the empty string if `key` was not previously set).
- `containsKey`
This operation returns true if `key` is currently set and false, otherwise. You can use this operation to distinguish between a key-value pair that was explicitly added with an empty string as a value, and a key-value pair that was never added at all.

Scope of the Implicit Context

You establish the implicit context on a communicator by setting a property, `Ice.ImplicitContext`. This property controls whether a communicator has an implicit context and, if so, at what scope the context applies. The property can be set to the following values:

- `None`
With this setting (or if `Ice.ImplicitContext` is not set at all), the communicator has no implicit context, and `getImplicitContext` returns null.
- `Shared`
The communicator has a single implicit context that is shared by all threads. Access to the context via its `ImplicitContext` interface is interlocked, so different threads can concurrently manipulate the context without risking data corruption or reading stale values.
- `PerThread`
The communicator maintains a separate implicit context for each thread. This allows you to propagate contexts that depend on the sending thread (for example, to send per-thread transaction IDs).

See Also

- [Explicit Request Contexts](#)
- [Per-Proxy Request Contexts](#)

Design Considerations for Request Contexts

On this page:

- [Request Context Interactions](#)
- [Request Context Use Cases](#)
- [Recommendations for Request Contexts](#)

Request Context Interactions

If you use `explicit`, `per-proxy`, and `implicit` contexts, it is important to be aware of their interactions:

- If you send an explicit context with an invocation, *only* that context is sent with the call, regardless of whether the proxy has a per-proxy context and whether the communicator has an implicit context.
- If you send an invocation via a proxy that has a per-proxy context, and the communicator also has an implicit context, the contents of the per-proxy and implicit context dictionaries are combined, so the *combination* of context entries of both contexts is transmitted to the server. If the per-proxy context and the implicit context contain the same key, but with different values, the *per-proxy* value takes precedence.

Request Context Use Cases

The purpose of `Ice::Context` is to permit services to be added to Ice that require some contextual information with every request. Contextual information can be used by services such as a transaction service (to provide the context of a currently established transaction) or a security service (to provide an authorization token to the server). `IceStorm` uses the context to provide an optional `cost` parameter to the service that influences how the service propagates messages to down-stream subscribers, and `Glacier2` uses the context to influence request routing.

In general, services that require such contextual information can be implemented much more elegantly using contexts because this hides explicit Slice parameters that would otherwise have to be supplied by the application programmer with every call. For a request-forwarding intermediary service such as `IceStorm` or `Glacier2`, using a parameter is not an option because the service does not know the signatures of the requests that it is forwarding, but the service does have access to the context. For this use case, the context is a convenient way for the caller to annotate a request.

In addition, contexts, because they are optional, permit a single Slice definition to apply to implementations that use the context, as well as to implementations that do not use it. In this way, to add transactional semantics to an existing service, you do not need to modify the Slice definitions to add an extra parameter to each operation. (Adding an extra parameter would not only be inconvenient for clients, but would also split the type system into two halves: without contexts, we would need different Slice definitions for transactional and non-transactional implementations of (conceptually) a single service.)

Finally, per-proxy contexts permit context information to be passed through intermediate parts of your program without cooperation of those intermediate parts. For example, suppose you set a per-proxy context on a proxy and then pass that proxy to another function. When that function uses the proxy to invoke an operation, the per-proxy context will still be sent. In other words, per-proxy contexts allow you to transparently propagate information via intermediaries that are ignorant of the presence of any context.

Keep in mind though that this works only within a single process. If you stringify a proxy or transmit it as a parameter over the wire, the per-proxy context is *not* preserved. (Ice does not write the per-proxy context into stringified proxies and does not marshal the per-proxy context when a proxy is marshaled.)

Recommendations for Request Contexts

Contexts are a powerful mechanism for transparent propagation of context information, *if used correctly*. In particular, you may be tempted to use contexts as a means of versioning an application as it evolves over time. For example, version 2 of your application may accept two parameters on an operation that, in version 1, used to accept only a single parameter. Using contexts, you could supply the second parameter as a name-value pair to the server and avoid changing the Slice definition of the operation in order to maintain backward compatibility.

We *strongly* urge you to resist any temptation to use contexts in this manner. The strategy is fraught with problems:

- **Missing context**
There is nothing that would compel a client to actually send a context when the server expects to receive a context: if a client forgets

to send a context, the server, somehow, has to make do without it (or throw an exception).

- **Missing or incorrect keys**
Even if the client does send a context, there is no guarantee that it has set the correct key. (For example, a simple spelling error can cause the client to send a value with the wrong key.)
- **Incorrect values**
The value of a context is a string, but the application data that is to be sent might be a number, or it might be something more complex, such as a structure with several members. This forces you to encode the value into a string and decode the value again on the server side. Such parsing is tedious and error prone, and far less efficient than sending strongly-typed parameters. In addition, the server has to deal with string values that fail to decode correctly (for example, because of an encoding error made by the client).

None of the preceding problems can arise if you use proper Slice parameters: parameters cannot be accidentally omitted and they are strongly typed, making it much less likely for the client to accidentally send a meaningless value. Furthermore, as of Ice 3.5 you can use [optional parameters](#) to modify the signature of an operation without breaking backward compatibility. For a large-scale solution to application versioning, we recommend using [ICE facets](#).

Contexts are meant to be used to transmit simple tokens (such as a transaction identifier) for services that cannot be reasonably implemented without them; you should restrict your use of contexts to that purpose and resist any temptation to use contexts for any other purpose.

Finally, be aware that, if a request is routed via one or more Ice routers, contexts may be dropped by intermediate routers if they consider them illegal. This means that, in general, you cannot rely on an arbitrary context value that is created by an application to actually still be present when a request arrives at the server — only those context values that are known to routers and that are considered legitimate are passed on. It follows that you should not abuse contexts to pass things that really should be passed as parameters.

See Also

- [Explicit Request Contexts](#)
- [Per-Proxy Request Contexts](#)
- [Implicit Request Contexts](#)
- [Optional Values](#)
- [Facets and Versioning](#)
- [IceStorm](#)

Connection Timeouts

A synchronous remote invocation does not complete on the client side until the server has finished processing it. Occasionally, it is useful to be able to force an invocation to terminate after some time, even if it has not completed. The `ice_timeout` factory method is provided for this purpose. The Slice definition of `ice_timeout` would look as follows:

Slice
<pre>Object* ice_timeout(int t);</pre>

This method returns a new proxy with the configured timeout. For example:

C++
<pre>Filesystem::FilePrx myFile = ...; Filesystem::FilePrx timeoutFile = myFile->ice_timeout(5000); try { Lines text = timeoutFile->read(); // Read with timeout } catch(const Ice::TimeoutException&) { cerr << "invocation timed out" << endl; } Lines text = myFile->read(); // Read without timeout</pre>

The parameter to `ice_timeout` determines the timeout value in milliseconds. A value of `-1` indicates no timeout. In the preceding example, the timeout is set to five seconds; if an invocation of `read` via the `timeoutFile` proxy does not complete within five seconds, the operation terminates with an `Ice::TimeoutException`. On the other hand, invocations via the `myFile` proxy are unaffected by the timeout, that is, `ice_timeout` sets the timeout on a per-proxy basis.

The timeout value set on a proxy affects all networking operations: reading and writing of data as well as opening and closing of connections. If any of these operations does not complete within the timeout, the client receives an exception. Note that, if the Ice run time encounters a recoverable error condition and transparently retries an invocation, this means that the timeout applies separately to each attempt. Similarly, if a large amount of data is sent with an operation invocation in several `write` system calls, the timeout applies to each write, not to the invocation overall.

Timeouts that expire during reading or writing of data are indicated by a `TimeoutException`. For opening and closing of connections, the Ice run time uses more specific exceptions:

- `ConnectTimeoutException`
This exception indicates that a connection could not be established within the specified time.
- `CloseTimeoutException`
This exception indicates that a connection could not be closed within the specified time.

An application normally configures a proxy's timeout using the `ice_timeout` method. However, a proxy that originated from a string may already have a timeout specified, as shown in the following example:

C++
<pre>string s = "ident:tcp -h somehost -t 5000:ssl -h somehost -t 5000";</pre>

In this case, both the TCP and SSL endpoints define a timeout of five seconds. When the Ice run time establishes a connection using one of these endpoints, it uses the endpoint's timeout unless one was specified explicitly via `ice_timeout`.

The Ice run time also supports two configuration properties that override the timeouts of every proxy regardless of the settings established via `ice_timeout` or the options defined in stringified proxies:

- `Ice.Override.ConnectTimeout`
This property defines a timeout that is only used for connection establishment. If not defined, its default value is `-1` (no timeout). If a proxy has multiple endpoints, the timeout applies to each endpoint separately.
- `Ice.Override.Timeout`
This property defines the timeout for invocations. If no value is defined for `Ice.Override.ConnectTimeout`, the value of `Ice.Override.Timeout` is also used as the timeout for connection establishment. If not defined, the default value is `-1` (no timeout).

If you are considering the use of timeouts, please keep the following limitations in mind:

- Timeouts are "soft" timeouts, in the sense that they are not precise, real-time timeouts. (The precision is limited by the capabilities of the underlying operating system.)
- Timeouts are considered fatal error conditions by the Ice run time and result in connection closure on the client side. Furthermore, any other requests pending on the [same connection](#) also fail with an exception.
- Timeouts are meant to be used to prevent a client from blocking indefinitely in case something has gone wrong with the server; they are not meant as a mechanism to routinely abort requests that take longer than intended.
- Be careful when using [timeouts with Glacier2](#).

See Also

- [Proxy Methods](#)
- [Connection Establishment](#)

Oneway Invocations

On this page:

- [Design Considerations for Oneway Invocations](#)
- [Creating Oneway Proxies](#)

Design Considerations for Oneway Invocations

A [oneway invocation](#) is sent on the client side by writing the request to the client's local transport buffers; the invocation completes and returns control to the application code as soon as it has been accepted by the local transport. Of course, this means that a oneway invocation is unreliable: it may never be sent (for example, because of a network failure) or it may not be accepted in the server (for example, because the target object does not exist).

This is an issue in particular if you use [Active Connection Management \(ACM\)](#): if a server closes a connection at the wrong moment, it is possible for the client to lose already-buffered oneway requests. We therefore recommend that you disable active connection management for the server side if clients use oneway (or [batched oneway](#)) requests. In addition, if clients use oneway requests and your application initiates server shutdown, it is the responsibility of your application to ensure either that it can cope with the potential loss of buffered oneway requests, or that it does not shut down the server at the wrong moment (while clients still have oneway requests that are buffered, but not yet sent).

If anything goes wrong with a oneway request, the client-side application code does not receive any notification of the failure; the only errors that are reported to the client are local errors that occur on the client side during call invocation (such as failure to establish a connection, for example).

As a consequence of oneway invocation, if you call [ice_ping](#) on a oneway proxy, successful completion does *not* indicate that the target object exists and could successfully be contacted — you will receive an exception only if something goes wrong on the client side, but not if something goes wrong on the server side. Therefore, if you want to use [ice_ping](#) with a oneway proxy and be certain that the target object exists and can successfully be contacted, you must first convert the oneway proxy into a twoway proxy. For example, in C++:

```

C++

SomeObjectPrx onewayPrx = ...; // Get a oneway proxy

try {
    onewayPrx->ice_twoway()->ice_ping();
} catch(const Ice::Exception&)
    cerr << "object not reachable" << endl;
}
```

Oneway invocations are received and processed on the server side like any other incoming request. If necessary, a server can distinguish a oneway invocation by examining the `requestId` member of `Ice::Current`: a non-zero value denotes a twoway request, whereas a value of zero indicates a oneway request.

Oneway invocations do not incur any return traffic from the server to the client: the server never sends a [reply message](#) in response to a oneway invocation. This means that oneway invocations can result in large efficiency gains, especially for large numbers of small messages, because the client does not have to wait for the reply to each message to arrive before it can send the next message.

In order to be able to invoke an operation as oneway, two conditions must be met:

- The operation must have a `void` return type, must not have any out-parameters, and must not have an exception specification.

This requirement reflects the fact that the server does not send a reply for a oneway invocation to the client: without such a reply, there is no way to return any values or exceptions to the client. If you attempt to invoke an operation that returns values to the client as a oneway operation, the Ice run time throws a `TwowayOnlyException`.

- The proxy on which the operation is invoked must support a stream-oriented transport (such as TCP or SSL).

Oneway invocations require a stream-oriented transport. (To get something like a oneway invocation for datagram transports, you need to use a [datagram invocation](#).) If you attempt to create a oneway proxy for an object that does not offer a stream-oriented transport, the Ice run time throws a `NoEndpointException`.

Despite their theoretical unreliability, in practice, oneway invocations are reliable (but not infallible [1]): they are sent via a stream-oriented transport, so they cannot get lost except when the connection is [shutting down](#) or fails entirely. In particular, the transport uses its usual flow control, so the client cannot overrun the server with messages. On the client-side, the Ice run time will block if the client's transport buffers fill up, so the client-side application code cannot overrun its local transport.

Consequently, oneway invocations normally do not block the client-side application code and return immediately, provided that the client does not consistently generate messages faster than the server can process them. If the rate at which the client invokes operations exceeds the rate at which the server can process them, the client-side application code will eventually block in an operation invocation until sufficient room is available in the client's transport buffers to accept the invocation. If your application requires that oneway requests never block the calling thread, you can use asynchronous oneway invocations instead.

Regardless of whether the client exceeds the rate at which the server can process incoming oneway invocations, the execution of oneway invocations in the server proceeds asynchronously: the client's invocation completes before the message even arrives at the server.

One thing you need to keep in mind about oneway invocations is that they may appear to be reordered in the server: because oneway invocations are sent via a stream-oriented transport, they are guaranteed to be received in the order in which they were sent. However, the server's [thread pool](#) may dispatch each invocation in its own thread; because threads are scheduled preemptively, this may cause an invocation sent later by the client to be dispatched and executed before an invocation that was sent earlier. If oneway requests must be dispatched in order, you can use one of the serialization techniques described in [Thread Pool Design Considerations](#).

For these reasons, oneway invocations are usually best suited to simple updates that are otherwise stateless (that is, do not depend on the surrounding context or the state established by previous invocations).

Creating Oneway Proxies

Ice selects between twoway, oneway, and [datagram invocations](#) via the proxy that is used to invoke the operation. By default, all proxies are created as twoway proxies. To invoke an operation as oneway, you must create a new proxy configured specifically for oneway invocations. The `ice_oneway` [factory method](#) is provided for this purpose. The Slice definition of `ice_oneway` would look as follows:

Slice
<pre>Object* ice_oneway();</pre>

We can call `ice_oneway` to create a oneway proxy and then use the proxy to invoke an operation as follows:

C++

```

Ice::ObjectPrx o = communicator->stringToProxy(/* ... */);

// Get a oneway proxy.
//
Ice::ObjectPrx oneway;
try {
    oneway = o->ice_oneway();
} catch (const Ice::NoEndpointException&) {
    cerr << "No endpoint for oneway invocations" << endl;
}

// Down-cast to actual type.
//
PersonPrx onewayPerson = PersonPrx::uncheckedCast(oneway);

// Invoke an operation as oneway.
//
try {
    onewayPerson->someOp();
} catch (const Ice::TwowayOnlyException&) {
    cerr << "someOp() is not oneway" << endl;
}

```

Note that we use an `uncheckedCast` to down-cast the proxy from `ObjectPrx` to `PersonPrx`: for a oneway proxy, we cannot use a `checkedCast` because a `checkedCast` requires a reply from the server but, of course, a oneway proxy does not permit that reply. If instead you want to use a safe down-cast, you can first down-cast the twoway proxy to the actual object type and then obtain the oneway proxy:

C++

```

Ice::ObjectPrx o = communicator->stringToProxy(/* ... */);

// Safe down-cast to actual type.
//
PersonPrx person = PersonPrx::checkedCast(o);

if (person) {
    // Get a oneway proxy.
    //
    PersonPrx onewayPerson;
    try {
        onewayPerson = person->ice_oneway();
    } catch (const Ice::NoEndpointException&) {
        cerr << "No endpoint for oneway invocations" << endl;
    }

    // Invoke an operation as oneway.
    //
    try {
        onewayPerson->someOp();
    } catch (const Ice::TwowayOnlyException&) {
        cerr << "someOp() is not oneway" << endl;
    }
}

```

Note that, while the second version of this code is somewhat safer (because it uses a safe down-cast), it is also slower (because the safe down-cast incurs the cost of an additional twoway message).

See Also

- [Terminology](#)
- [Active Connection Management](#)
- [Batched Invocations](#)
- [The Current Object](#)
- [The Ice Threading Model](#)
- [Datagram Invocations](#)
- [The Ice Protocol](#)

References

1. Snader, J. C. 2000. *Effective TCP/IP Programming*. Reading, MA: Addison-Wesley.

Datagram Invocations

On this page:

- [Design Considerations for Datagram Invocations](#)
- [Creating Datagram Proxies](#)

Design Considerations for Datagram Invocations

[Datagram invocations](#) are the equivalent of [oneway invocations](#) for datagram transports. As for oneway invocations, datagram invocations can be sent only for operations that have a `void` return type and do not have out-parameters or an exception specification. Attempts to use a datagram invocation with an operation that does not meet these criteria result in a `TwowayOnlyException`. In addition, datagram invocations can only be used if the proxy's endpoints include at least one UDP transport; otherwise, the Ice run time throws a `NoEndpointException`.

The semantics of datagram invocations are similar to oneway invocations: no return traffic flows from the server to the client and proceed asynchronously with respect to the client; a datagram invocation completes as soon as the client's transport has accepted the invocation into its buffers. However, datagram invocations differ in one respect from oneway invocations in that datagram invocations optionally support multicast semantics. Furthermore, datagram invocations have additional error semantics:

- Individual invocations may be lost or received out of order.

On the wire, datagram invocations are sent as true datagrams, that is, individual datagrams may be lost, or arrive at the server out of order. As a result, not only may operations be dispatched out of order, an individual invocation out of a series of invocations may be lost. (This cannot happen for oneway invocations because, if a connection fails, *all* invocations are lost once the connection breaks down.)

- UDP packets may be duplicated by the transport.

Because of the nature of UDP routing, it is possible for datagrams to arrive in duplicate at the server. This means that, for datagram invocations, Ice does *not* guarantee [at-most-once semantics](#): if UDP datagrams are duplicated, the same invocation may be dispatched more than once in the server.

- UDP packets are limited in size.

The maximum size of an IP datagram is 65,535 bytes. Of that, the IP header consumes 20 bytes, and the UDP header consumes 8 bytes, leaving 65,507 bytes as the maximum payload. If the marshaled form of an invocation, including the Ice [request header](#) exceeds that size, the invocation is lost. (Exceeding the size limit for a UDP datagram is indicated to the application by a `DatagramLimitException`.)

Because of their unreliable nature, datagram invocations are best suited to simple update messages that are otherwise stateless. In addition, due to the high probability of loss of datagram invocations over wide area networks, you should restrict use of datagram invocations to local area networks, where they are less likely to be lost. (Of course, regardless of the probability of loss, you must design your application such that it can tolerate lost or duplicated messages.)

Creating Datagram Proxies

To invoke an operation as datagram, you must create a new proxy configured specifically for datagram invocations. The `ice_datagram` factory method is provided for this purpose. The Slice definition of `ice_datagram` would look as follows:

```

Slice
-----
Object* ice_datagram();

```

We can call `ice_datagram` to create a oneway proxy and then use the proxy to invoke an operation as follows:

C++

```

Ice::ObjectPrx o = communicator->stringToProxy(/* ... */);

// Get a datagram proxy.
//
Ice::ObjectPrx datagram;
try {
    datagram = o->ice_datagram();
} catch (const Ice::NoEndpointException&) {
    cerr << "No endpoint for datagram invocations" << endl;
}

// Down-cast to actual type.
//
PersonPrx datagramPerson = PersonPrx::uncheckedCast(datagram);

// Invoke an operation as a datagram.
//
try {
    datagramPerson->someOp();
} catch (const Ice::TwowayOnlyException&) {
    cerr << "someOp() is not oneway" << endl;
}

```

As for the [oneway example](#), you can alternatively choose to first do a safe down-cast to the actual type of interface and then obtain the datagram proxy, rather than relying on an unsafe down-cast, as shown above. However, doing so may be disadvantageous for two reasons:

- Safe down-casts are sent via a stream-oriented transport. This means that using a safe down-cast will result in opening a connection for the sole purpose of verifying that the target object has the correct type. This is expensive if all the other traffic to the object is sent via datagrams.
- If the proxy does not offer a stream-oriented transport, the `checkedCast` fails with a `NoEndpointException`, so you can use this approach only for proxies that offer both a UDP endpoint and a TCP/IP and/or SSL endpoint.

See Also

- [Terminology](#)
- [Oneway Invocations](#)
- [The Ice Protocol](#)

Batched Invocations

[Oneway](#) and [datagram](#) invocations are normally sent as individual messages, that is, the Ice run time sends the oneway or datagram invocation to the server immediately, as soon as the client makes the call. If a client sends a number of oneway or datagram invocations in succession, the client-side run time traps into the OS kernel for each message, which is expensive. In addition, each message is sent with its own [message header](#), that is, for N messages, the bandwidth for N message headers is consumed. In situations where a client sends a number of oneway or datagram invocations, the additional overhead can be considerable.

To avoid the overhead of sending many small messages, you can send oneway and datagram invocations in a batch: instead of being sent as a separate message, a batch invocation is placed into a client-side buffer by the Ice run time. Successive batch invocations are added to the buffer and accumulated on the client side until they are flushed, either explicitly by the client or automatically by the Ice run time.

On this page:

- [Proxy Methods for Batched Invocations](#)
- [Automatically Flushing Batched Invocations](#)
- [Flushing Batched Invocations for Communicators and Connections](#)
- [Considerations for Batched Datagrams](#)
- [Compressing Batched Invocations](#)
- [Active Connection Management and Batched Invocations](#)

Proxy Methods for Batched Invocations

Several [proxy methods](#) support the use of batched invocations. In Slice, these methods would look as follows:

```

Slice
Object* ice_batchOneway();
Object* ice_batchDatagram();
void ice_flushBatchRequests();

```

The `ice_batchOneway` and `ice_batchDatagram` methods create a new proxy configured for batch invocations. Once you obtain a batch proxy, messages sent via that proxy are buffered in the client-side run time instead of being sent immediately. Once the client has invoked one or more operations on a batch proxy, it can call `ice_flushBatchRequests` to explicitly flush the batched invocations. This causes the batched messages to be sent "in bulk", preceded by a single message header. On the server side, batched messages are dispatched by a single thread, in the order in which they were written into the batch. This means that messages from a single batch cannot appear to be reordered in the server. Moreover, either all messages in a batch are delivered or none of them. (This is true even for batched datagrams.)

Asynchronous versions of `ice_flushBatchRequests` are also available; see the relevant language mapping for more information.

Automatically Flushing Batched Invocations

The default behavior of the Ice run time, as governed by the configuration property `Ice.BatchAutoFlush`, automatically flushes batched invocations as soon as a batched request causes the accumulated message to exceed the maximum allowable size. When this occurs, the Ice run time immediately flushes the existing batch of requests and begins a new batch with this latest request as its first element.

For batched oneway invocations, the maximum message size is established by the property `Ice.MessageSizeMax`, which defaults to 1MB. In the case of batched datagram invocations, the maximum message size is the smaller of the system's maximum size for datagram packets and the value of `Ice.MessageSizeMax`.

A client that sends batch requests cannot determine the size of the message that the Ice run time is accumulating for it; automatic flushing is enabled by default as a convenience for clients that unknowingly exceed the maximum message size. A client that requires more deterministic behavior should flush batched requests explicitly at regular intervals.

Flushing Batched Invocations for Communicators and Connections

The `Communicator` and `Connection` interfaces support synchronous and asynchronous versions of `flushBatchRequests`. As you might expect, the `Connection::flushBatchRequests` operation flushes all batch requests queued for a particular connection, and the `communicator::flushBatchRequests` operation flushes the batch requests of every connection created by a communicator.

The synchronous versions of `flushBatchRequests` block the calling thread until the batch requests have been successfully written to the local transport. To avoid the risk of blocking, you must use the asynchronous versions instead (assuming they are supported by your chosen language mapping). Note also that the asynchronous version of `Communicator::flushBatchRequests` never raises an exception, even if an error occurs while flushing one of its connections.

Considerations for Batched Datagrams

For batched datagram invocations, you need to keep in mind that, if the data for the invocations in a batch substantially exceeds the PDU size of the network, it becomes increasingly likely for an individual UDP packet to get lost due to fragmentation. In turn, loss of even a single packet causes the entire batch to be lost. For this reason, batched datagram invocations are most suitable for simple interfaces with a number of operations that each set an attribute of the target object (or interfaces with similar semantics). Batched oneway invocations do not suffer from this risk because they are sent over stream-oriented transports, so individual packets cannot be lost.

Compressing Batched Invocations

Batched invocations are more efficient if you also enable `compression` for the transport: many isolated and small messages are unlikely to compress well, whereas batched messages are likely to provide better compression because the compression algorithm has more data to work with.



Regardless of whether you used batched messages or not, you should enable compression only on lower-speed links. For high-speed LAN connections, the CPU time spent doing the compression and decompression is typically longer than the time it takes to just transmit the uncompressed data.

Active Connection Management and Batched Invocations

As for `oneway invocations`, you should disable server-side `Active Connection Management` (ACM) when using batched invocations over TCP/IP or SSL. With server-side ACM enabled, it is possible for a server to close the connection at the wrong moment and not process a batch (with no indication being returned to the client that the batch was lost).

See Also

- [Oneway Invocations](#)
- [Datagram Invocations](#)
- [Communicators](#)
- [Using Connections](#)
- [The Ice Protocol](#)
- [Protocol Compression](#)
- [Active Connection Management](#)

Locators

In [Terminology](#), we described briefly how the Ice run time uses an intermediary, known as a *location service*, to convert the symbolic information in an indirect proxy into an endpoint that it can use to communicate with a server. This section expands on that introduction to explain in more detail how the Ice run time interacts with a location service. You can create your own location service or you can use [IceGrid](#), which is an implementation of a location service and provides many other useful features as well. Describing how to implement a location service is outside the scope of this manual.

A *locator* is an Ice object that is implemented by a location service. A locator object must support the Slice interface `Ice::Locator`, which defines operations that satisfy the location requirements of the Ice run time. Applications do not normally use these operations directly, but the locator object may support an implementation-specific interface derived from `Ice::Locator` that provides additional functionality. For example, IceGrid's locator object implements the derived interface `IceGrid::Query` to allow applications to perform [more sophisticated queries](#).

Topics

- [Locator Semantics for Clients](#)
- [Locator Configuration for a Client](#)
- [Locator Semantics for Servers](#)
- [Locator Configuration for a Server](#)

See Also

- [Terminology](#)
- [IceGrid](#)
- [\[Queries](#)

Locator Semantics for Clients

On this page:

- [Invocations with an Indirect Proxy](#)
- [Replication with a Locator](#)
- [Locator Cache](#)
- [Locator Cache Timeout](#)
- [Proxy Connection Caching](#)
- [Simple Load Balancing](#)
- [Load Balancing with a Locator](#)

Invocations with an Indirect Proxy

On the first use of an indirect proxy in an application, the Ice run time may issue a remote invocation on the locator object. This activity is transparent to the application, as shown below:

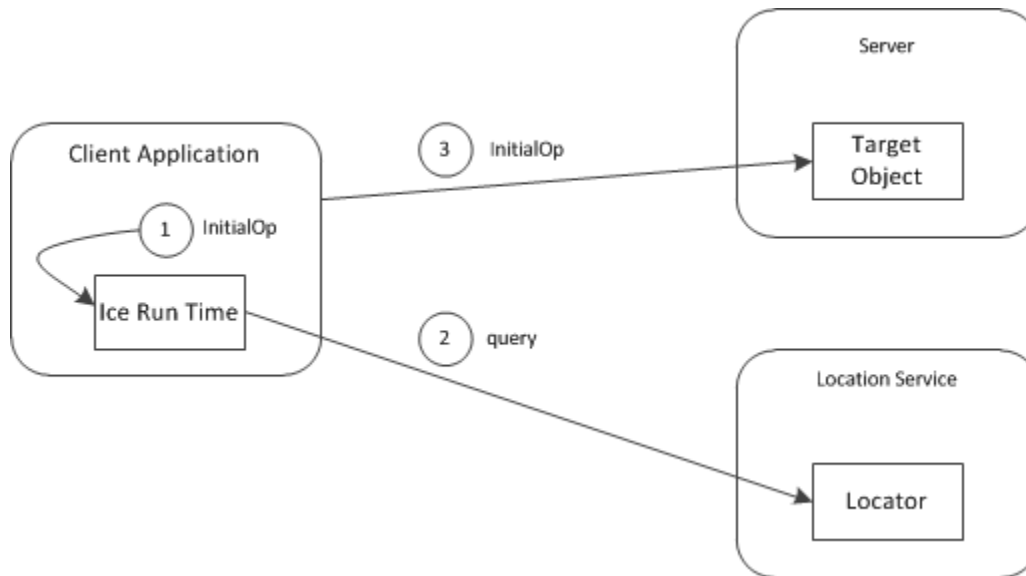

Locating an object.

1. The client invokes the operation `initialOp` on an indirect proxy.
2. The Ice run time checks an internal cache (called the *locator cache*) to determine whether a query has already been issued for the symbolic information in the proxy. If so, the cached endpoint is used and an invocation on the locator object is avoided. Otherwise, the Ice run time issues a locate request to the locator.
3. If the object is successfully located, the locator returns its current endpoints. The Ice run time in the client caches this information, [establishes a connection](#) to one of the endpoints, and proceeds to send the invocation as usual.
4. If the object's endpoints cannot be determined, the client receives an exception. `NotRegisteredException` is raised when an identity, object adapter identifier or replica group identifier is not known. A client may also receive `NoEndpointException` if the location service failed to determine the current endpoints.

As far as the Ice run time is concerned, the locator simply converts the information in an indirect proxy into usable endpoints. Whether the locator's implementation is more sophisticated than a simple lookup table is irrelevant to the Ice run time. However, the act of performing this conversion may have additional semantics that the application must be prepared to accept.

For example, when using IceGrid as your location service, the target server may be launched automatically if it is not currently running, and the locate request does not complete until that server is started and ready to receive requests. As a result, the initial request on an indirect proxy may incur additional overhead as all of this activity occurs.

Replication with a Locator

An indirect proxy may substitute a [replica group](#) identifier in place of the object adapter identifier. In fact, the Ice run time does not distinguish

between these two cases and considers a replica group identifier as equivalent to an object adapter identifier for the purposes of resolving the proxy. The location service implementation must be able to distinguish between replica groups and object adapters using only this identifier.

The location service may return multiple endpoints in response to a locate request for an adapter or replica group identifier. These endpoints might all correspond to a single object adapter that is available at several addresses, or to multiple object adapters each listening at a single address, or some combination thereof. The Ice run time attaches no semantics to the collection of endpoints, but the application can make assumptions based on its knowledge of the location service's behavior.

When a location service returns more than one endpoint, the Ice run time behaves exactly as if the proxy had contained several endpoints. As always, the goal of the Ice run time is to [establish a connection](#) to one of the endpoints and deliver the client's request. By default, all requests made via the proxy that initiated the connection are sent to the same server until that connection is closed.

After the connection is closed, such as by [Active Connection Management \(ACM\)](#), subsequent use of the proxy causes the Ice run time to obtain another connection. Whether that connection uses a different endpoint than previous connections depends on a number of factors, but it is possible for the client to connect to a different server than for previous requests.

Locator Cache

After successfully resolving an indirect proxy, the location service must return at least one endpoint. How the service derives the list of endpoints that corresponds to the proxy is entirely implementation dependent. For example, IceGrid's location service can be configured to respond in a variety of ways; one possibility uses a simple round-robin scheme, while another selects endpoints based on the system load of the target hosts.

A locate request has the potential to significantly increase the latency of the application's invocation with a proxy, and this is especially true if the locate request triggers additional implicit actions such as starting a new server process. Fortunately, this overhead is normally incurred only during the application's initial invocation on the proxy, but this impact is influenced by the Ice run time's caching behavior.

To minimize the number of locate requests, the Ice run time caches the results of previous requests. By default, the results are cached indefinitely, so that once the Ice run time has obtained the endpoints associated with an indirect proxy, it never issues another locate request for that proxy. Furthermore, the default behavior of a proxy is to [cache its connection](#), that is, once a proxy has obtained a connection, it continues to use that connection indefinitely.

Taken together, these two caching characteristics represent the Ice run time's best efforts to optimize an application's use of a location service: after a proxy is associated with a connection, all future invocations on that proxy are sent on the same connection without any need for cache lookups, locate requests, or new connections.

If a proxy's connection is closed, the next invocation on the proxy prompts the Ice run time to consult its locator cache to obtain the endpoints from the prior locate request. Next, the Ice run time searches for an [existing connection](#) to any of those endpoints and uses that if possible, otherwise it attempts to establish a new connection to each of the endpoints until one succeeds. Only if that process fails does the Ice run time clear the entry from its cache and issue a new locate request with the expectation that a usable endpoint is returned.

The Ice run time's default behavior is optimized for applications that require minimal interaction with the location service, but some applications can benefit from more frequent locate requests. Normally this is desirable when implementing a load-balancing strategy, as we discuss in more detail below. In order to increase the frequency of locate requests, an application must configure a timeout for the locator cache and manipulate the connections of its proxies.

Locator Cache Timeout

An application can define a timeout to control the lifetime of entries in the locator cache. This timeout can be specified globally using the `Ice.Default.LocatorCacheTimeout` property and for individual proxies using the [proxy method](#) `ice_locatorCacheTimeout`. The Ice run time's default behavior is equivalent to a timeout value of `-1`, meaning the cache entries never expire. Using a timeout value greater than zero causes the cache entries to expire after the specified number of seconds. Finally, a timeout value of zero disables the locator cache altogether.

The previous section explained the circumstances in which the Ice run time consults the locator cache. Briefly, this occurs only when the application has invoked an operation on a proxy and the proxy is not currently associated with a connection. If the timeout is set to zero, the

Ice run time issues a new locate request immediately. Otherwise, for a non-zero timeout, the Ice run time examines the locator cache to determine whether the endpoints from the previous locate request have expired. If so, the Ice run time discards them and issues a new locate request.

Given this behavior, if your goal is to force a proxy invocation to issue locate requests more frequently, you can do so only when the proxy is not associated with a connection. You can accomplish that in several ways:

- create a new proxy, which is inherently not connected by default
- [explicitly close](#) the proxy's existing connection
- disabling the proxy's connection caching behavior

Of these choices, the last is the most common.

Proxy Connection Caching

By default a proxy remembers its connection and uses it for all invocations until that connection is closed. You can prevent a proxy from caching its connection by calling the `ice_connectionCached` proxy method with an argument of false. Once connection caching is disabled, each invocation on a proxy causes the Ice run time to execute its connection establishment process.

Note that each invocation on such a proxy does not necessarily cause the Ice run time to establish a new connection. It only means that the Ice run time does not assume that it can reuse the connection of the proxy's previous invocation. Whether the Ice run time actually needs to [establish a new connection](#) for the next invocation depends on several factors.

As with any feature, you should only use it when the benefits outweigh the risks. With respect to a proxy's connection caching behavior, there is certainly a small amount of computational overhead associated with executing the connection establishment process for each invocation, as well as the risk of significant overhead each time a new connection is actually created.

Simple Load Balancing

Several forms of load balancing are available to Ice applications. The simplest form uses only the endpoints contained in a direct proxy and does not require a location service. In this configuration, the application can configure the proxy to use the desired [endpoint selection type](#) and [connection caching](#) behavior to achieve the desired results.

For example, suppose that a proxy contains several endpoints. In its default configuration, it uses the `Random` endpoint selection type and caches its connection. Upon the first invocation, the Ice run time selects one of the proxy's endpoints at random and uses that connection for all subsequent invocations until the connection is closed. For some applications, this form of load balancing may be sufficient.

Suppose now that we use the `Ordered` endpoint selection type instead. In this case, the Ice run time always attempts to establish connections using the endpoints in the order they appear in the proxy. Normally an application uses this configuration when there is a preferred order to the servers. Again, once connected, the application uses whichever connection was chosen indefinitely.

By disabling the proxy's connection caching behavior, the semantics undergo a significant change. Using the `Random` endpoint selection type, the Ice run time selects one of the endpoints at random and establishes a connection to it if one is not already established, and this process is repeated prior to each subsequent invocation. This is called *per-request load balancing* because each request can be directed to a different server. Using the `Ordered` endpoint selection type is not as common in this scenario; its main purpose would be to fall back on a secondary server if the primary server is not available, but it causes the Ice run time to attempt to contact the primary server during each request.

Load Balancing with a Locator

A disadvantage of relying solely on the simple form of load balancing described above is that the client cannot make any intelligent decisions based on the status of the servers. If you want to distribute your requests in a more sophisticated way, you must either modify your clients to query the servers directly, or use a location service that can transparently direct a client to an appropriate server. For example, the IceGrid location service can monitor the system load on each server host and use that information when responding to locate requests.

The location service may return only one endpoint, which presumably represents the best server (at that moment) for the client to use. With only one endpoint available, changing the proxy's endpoint selection type makes no difference. However, by disabling connection caching and modifying the locator cache timeout, the application can force the Ice run time to periodically retrieve an updated endpoint from the

location service. For example, an application can set a locator cache timeout of thirty seconds and communicate with the selected server for that period. After the timeout has expired, the next invocation prompts the Ice run time to issue a new locate request, at which point the client might be directed to a different server.

If the location service returns multiple endpoints, the application must be designed with knowledge of how to interpret them. For instance, the location service may attach semantics to the order of the endpoints (such as least-loaded to most-loaded) and intend that the application use the endpoints in the order provided. Alternatively, the client may be free to select any of the endpoints. As a result, the application and the location service must cooperate to achieve the desired results.

You can combine the simple form of load balancing described in the previous section with an intelligent location service to gain even more flexibility. For example, suppose an application expects to receive multiple endpoints from the location service and has configured its proxy to disable connection caching and set a locator cache timeout. For each invocation, Ice run time selects one of the endpoints provided by the location service. When the timeout expires, the Ice run time issues a new locate request and obtains a fresh set of endpoints from which to choose.

See Also

- [Terminology](#)
- [Proxy Methods](#)
- [Connection Establishment](#)
- [Active Connection Management](#)
- [Ice Default and Override Properties](#)

Locator Configuration for a Client

An Ice client application must supply a proxy for the `locator` object, which it can do in several ways:

- by explicitly configuring an indirect proxy using the `ice_locator proxy method`
- by calling `setDefaultLocator` on a communicator, after which all new proxies use the given locator by default
- by defining the `Ice.Default.Locator` configuration property, which causes all proxies to use the given locator by default

The Ice run time's efforts to resolve an indirect proxy can be traced by setting the following configuration properties:

```
Ice.Trace.Network=2
Ice.Trace.Protocol=1
Ice.Trace.Locator=2
```

See [Ice Trace Properties](#) for more information on these properties.

See Also

- [Locator Semantics for Clients](#)
- [Proxy Methods](#)
- [Ice Default and Override Properties](#)

Locator Semantics for Servers

A location service must know the endpoints of any [object adapter](#) whose identifier can be used in an indirect proxy. For example, suppose a client uses the following proxy:

```
Object1@PublicAdapter
```

The Ice run time in the client includes the identifier `PublicAdapter` in its [locate request](#) and expects to receive the associated endpoints. The only way the location service can know these endpoints is if it is given them. When you consider that an object adapter's endpoints may not specify fixed ports, and therefore the endpoint addresses may change each time the object adapter is activated, it is clear that the best source of endpoint information is the object adapter itself. As a result, an object adapter that is [properly configured](#) contacts the locator during activation to supply its identifier and current endpoints. More specifically, the object adapter registers itself with an object implementing the `Ice::LocatorRegistry` interface, whose proxy the object adapter obtains from the locator.

A location service may require that all object adapters be pre-registered via some implementation-specific mechanism. ([IceGrid](#) behaves this way by default.) This implies that activation can fail if the object adapter supplies an identifier that is unknown to the location service. In such a situation, the object adapter's `activate` operation raises `NotRegisteredException`.

In a similar manner, an object adapter that participates in a [replica group](#) includes the group's identifier in the locator request that is sent during activation. If the location service requires replica group members to be configured in advance, `activate` raises `NotRegisteredException` if the object adapter's identifier is not one of the group's [registered participants](#).

See Also

- [Object Adapters](#)
- [Locator Semantics for Clients](#)
- [Locator Configuration for a Server](#)
- [IceGrid](#)
- [Terminology](#)
- [Object Adapter Replication](#)

Locator Configuration for a Server

On this page:

- [Configuring an Object Adapter with a Locator](#)
- [Registering a Process with a Locator](#)

Configuring an Object Adapter with a Locator

An [object adapter](#) must be able to obtain a [locator proxy](#) in order to register itself with a location service. Each object adapter can be configured with its own locator proxy by defining its `Locator` property, as shown in the example below for the object adapter named `SampleAdapter`:

```
SampleAdapter.Locator=IceGrid/Locator:tcp -h locatorhost -p 10000
```

Alternatively, a server may call `setLocator` on the object adapter prior to activation. If the object adapter is not explicitly configured with a locator proxy, it uses the [default locator](#) as provided by its communicator.

Two other configuration properties influence an object adapter's interactions with a location service during activation:

- [AdapterId](#)
Configuring a non-empty identifier for the `AdapterId` property causes the object adapter to register itself with the location service. A locator proxy must also be configured.
- [ReplicaGroupId](#)
Configuring a non-empty identifier for the `ReplicaGroupId` property indicates that the object adapter is a member of a [replica group](#). For this property to have an effect, `AdapterId` must also be configured with a non-empty value.

We can use these properties as shown below:

```
SampleAdapter.AdapterId=SampleAdapterId
SampleAdapter.ReplicaGroupId=SampleGroupId
SampleAdapter.Locator=IceGrid/Locator:tcp -h locatorhost -p 10000
```

Note that a location service may enforce [pre-registration requirements](#).

Registering a Process with a Locator

An activation service, such as an [IceGrid](#) node, needs a reliable way to gracefully deactivate a server. One approach is to use a platform-specific mechanism, such as POSIX signals. This works well on POSIX platforms when the server is prepared to [intercept signals](#) and react appropriately. On Windows platforms, it works less reliably for C++ servers, and not at all for Java servers. For these reasons, Ice provides an alternative that is both portable and reliable:

Slice

```
module Ice {
  interface Process {
    void shutdown();
    void writeMessage(string message, int fd);
  };
};
```

The Slice interface `Process` allows an activation service to request a graceful shutdown of the server. When `shutdown` is invoked, the object implementing this interface is expected to initiate the termination of its server process. The activation service may expect the server to terminate within a certain period of time, after which it may terminate the server abruptly.

One of the benefits of the Ice `administrative facility` is that it creates an implementation of `Process` and makes it available via an administrative object adapter. Furthermore, IceGrid automatically enables this facility on the servers that it activates.

See Also

- [Object Adapters](#)
- [Locators](#)
- [Locator Configuration for a Client](#)
- [Locator Semantics for Servers](#)
- [Portable Signal Handling in C++](#)
- [The Process Facet](#)
- [Administrative Facility](#)
- [IceGrid](#)

Administrative Facility

Ice applications often require remote administration, such as when an IceGrid node needs to [gracefully deactivate](#) a running server. The Ice run time provides an extensible, centralized facility for exporting administrative functionality. This facility consists of an [object adapter](#) named `Ice.Admin`, an Ice object activated on this adapter, and configuration properties that enable the facility and specify its features.

Topics

- [The admin Object](#)
- [The Administrative Object Adapter](#)
- [Using the admin Object](#)
- [The Process Facet](#)
- [The Properties Facet](#)
- [The Metrics Facet](#)
- [Filtering Administrative Facets](#)
- [Custom Administrative Facets](#)
- [Security Considerations for Administrative Facets](#)

See Also

- [Locator Configuration for a Server](#)
- [Object Adapters](#)

The admin Object

On this page:

- [Overview of the admin Object](#)
- [Facets of the admin Object](#)

Overview of the admin Object

The `Ice.Admin` object adapter hosts a single object whose `identity` name is `admin`. Although this identity name cannot be changed, you can define the identity category using the configuration property `Ice.Admin.InstanceName`. If you enable the `Ice.Admin` object adapter without defining this property, the category uses a UUID by default and therefore the object's identity changes with each instance of the process.

In this manual, we refer to the administrative object as the *admin object*.

Facets of the admin Object

An Ice object is actually a collection of sub-objects known as `facets` whose types are not necessarily related. Although facets are typically used for extending and versioning types, they also allow a group of interfaces with a common purpose to be consolidated into a single Ice object with an established interface for navigation. These qualities make facets an excellent match for the requirements of the administrative facility.

Each facet of the `admin` object represents a distinct administrative capability. The object does not have a default facet (that is, a facet with an empty name). However, the Ice run time implements several built-in facets that it adds to the `admin` object:

- the `Process` facet
- the `Properties` facet
- the `Metrics` facet

An application can [control which facets are installed](#) with a configuration property. An application can also [install its own facets](#) if necessary. Administrative facets are not required to inherit from a common `Slice` interface.

See Also

- [The Administrative Object Adapter](#)
- [Object Identity](#)
- [Facets and Versioning](#)
- [The Process Facet](#)
- [The Properties Facet](#)
- [Filtering Administrative Facets](#)
- [Custom Administrative Facets](#)
- [Ice Administrative Properties](#)

The Administrative Object Adapter

The administrative facility is disabled by default. To enable it, you must specify endpoints for the administrative object adapter using the property `Ice.Admin.Endpoints`. In addition, you must do one of the following:

- Define the `Ice.Admin.InstanceName` property. If you do not supply a value for `Ice.Admin.InstanceName`, Ice uses a UUID by default.
- Define the `Ice.Admin.ServerId` and `Ice.Default.Locator` properties.

The `Ice.Admin.ServerId` and `Ice.Default.Locator` properties are typically used in conjunction with an [activation service](#) such as IceGrid.



The administrative facility introduces additional [security considerations](#), therefore the endpoints for the `Ice.Admin` adapter must be chosen with caution.

It may be necessary to postpone the creation of the administrative object adapter until all facets are installed or other initialization activities have taken place. In this situation, you can enable the `Ice.Admin.DelayCreation` property. When set to a non-zero value, the administrative facility is disabled until the application invokes the `getAdmin` operation on the communicator.

See Also

- [Ice Administrative Properties](#)
- [IceGrid and the Administrative Facility](#)
- [Security Considerations for Administrative Facets](#)
- [Using the admin Object](#)

Using the admin Object

A program can obtain a proxy for its `admin` object by calling the `getAdmin` operation on a communicator:

Slice
<pre> module Ice { local interface Communicator { // ... Object* getAdmin(); }; }; </pre>

This operation returns a null proxy if the administrative facility is disabled. The proxy returned by `getAdmin` cannot be used for invoking operations because it refers to the default facet and, as we mentioned [previously](#), the `admin` object does not support a default facet. A program must first obtain a new version of the proxy that is configured with the name of a particular administrative facet before invoking operations on it. Although it cannot be used for invocations, the original proxy is still useful because it contains the endpoints of the [administrative object adapter](#) (`Ice.Admin`) and therefore the program may elect to export that proxy to a remote client.

To administer a program remotely, somehow you must obtain a proxy for the program's `admin` object. There are several ways for the administrative client to accomplish this:

- Construct the proxy itself, assuming that it knows the `admin` object's identity, facets, and endpoints. The format of the [stringified proxy](#) is as follows:
instance-name/admin -f admin-facet:admin-endpoints
 The identity category, represented here by *instance-name*, is the value of the `Ice.Admin.InstanceName` property or a UUID if that property is not defined. (Clearly, the use of a UUID makes the proxy much more difficult for a client to construct on its own.) The name of the administrative facet is supplied as the value of the `-f` option, and the endpoints of the `Ice.Admin` adapter appear last in the proxy.
- Invoke an application-specific interface for retrieving the `admin` object's proxy.
- Use the `getServerAdmin` operation on the `IceGrid::Admin` interface, if the remote program was activated by IceGrid (see [Configuring Automatic Retries](#)).

Having obtained the proxy, the administrative client must select a facet before invoking any operations. For example, the code below shows how to obtain the configuration properties of the remote program:

C++
<pre> // C++ Ice::ObjectPrx adminObj = ...; Ice::PropertiesAdminPrx propAdmin = Ice::PropertiesAdminPrx::checkedCast(adminObj, "Properties"); Ice::PropertyDict props = propAdmin->getPropertiesForPrefix(""); </pre>

Here we used an overloaded version of `checkedCast` to supply the facet name of interest (`Properties`). We could have selected the facet using the [proxy method](#) `ice_facet` instead, as shown below:

C++

```
// C++
Ice::ObjectPrx adminObj = ...;
Ice::PropertiesAdminPrx propAdmin =
Ice::PropertiesAdminPrx::checkedCast(
    adminObj->ice_facet("Properties"));
Ice::PropertyDict props = propAdmin->getPropertiesForPrefix("");
```

This code is functionally equivalent to the first example.

A remote client must also know (or be able to determine) which facets are available in the target server. Typically this information is statically configured in the client, since the client must also know the interface types of any facets that it uses. If an invocation on a facet raises `FacetNotExistException`, the client may have used an incorrect facet name, or the server may have disabled the facet in question.

See Also

- [The admin Object](#)
- [The Administrative Object Adapter](#)
- [Ice Administrative Properties](#)
- [Proxy and Endpoint Syntax](#)
- [Automatic Retries](#)
- [Facets and Versioning](#)

The Process Facet

An activation service, such as an [IceGrid](#) node, needs a reliable way to gracefully deactivate a server. One approach is to use a platform-specific mechanism, such as POSIX signals. This works well on POSIX platforms when the server is prepared to [intercept signals](#) and react appropriately. On Windows platforms, it works less reliably for C++ servers, and not at all for Java servers. For these reasons, the `Process` facet provides an alternative that is both portable and reliable.

 Be aware of the [security considerations](#) associated with enabling the `Process` facet.

On this page:

- [The `Process` Interface](#)
- [Application Requirements for the Process Facet](#)
- [Replacing the Process Facet](#)
- [Integrating the Process Facet with an Activation Service](#)

The `Process` Interface

The Slice interface `Ice::Process` allows an activation service to request a graceful shutdown of the program:

```

Slice
module Ice {
  interface Process {
    void shutdown();
    void writeMessage(string message, int fd);
  };
};

```

When `shutdown` is invoked, the object implementing this interface is expected to initiate the termination of its process. The activation service may expect the program to terminate within a certain period of time, after which it may terminate the program abruptly.

The `writeMessage` operation allows remote clients to print a message to the program's standard output (`fd == 1`) or standard error (`fd == 2`) channels.

Application Requirements for the Process Facet

The default implementation of the `Process` facet requires cooperation from an application in order to successfully terminate a process. Specifically, the facet invokes `shutdown` on its [communicator](#) and assumes that the application uses this event as a signal to commence its termination procedure. For example, an application typically uses a thread (often the main thread) to call the communicator operation `waitForShutdown`, which blocks the calling thread until the communicator is shut down or destroyed. After `waitForShutdown` returns, the calling thread can initiate a graceful shutdown of its process.

Replacing the Process Facet

You can replace the default `Process` facet if your application requires a different scheme for gracefully shutting itself down. To define your own facet, create a servant that implements the `Ice::Process` interface. As an example, the servant definition shown below duplicates the functionality of the default `Process` facet:

C++

```

class ProcessI : public Ice::Process {
public:
    ProcessI(const Ice::CommunicatorPtr& communicator) :
        _communicator(communicator)
    {}

    void shutdown(const Ice::Current&)
    {
        _communicator->shutdown();
    }

    void writeMessage(const string& msg, Ice::Int fd,
const Ice::Current&)
    {
        if(fd == 1) cout << msg << endl;
        else if(fd == 2) cerr << msg << endl;
    }

private:
    const Ice::CommunicatorPtr _communicator;
};

```

As you can see, the default implementation of `shutdown` simply shuts down the communicator, which initiates an orderly termination of the Ice run time's server-side components and prevents object adapters from dispatching any new requests. You can add your own application-specific behavior to the `shutdown` method to ensure that your program terminates in a timely manner.



A servant must not invoke `destroy` on its communicator while executing a dispatched operation.

To avoid the risk of a race condition, the recommended strategy for replacing the `Process` facet is to delay creation of the administrative facets so that your application has a chance to replace the facet:

```
Ice.Admin.DelayCreation=1
```

With `Ice.Admin.DelayCreation` enabled, the application can safely remove the default `Process` facet and install its own:

C++

```

Ice::CommunicatorPtr communicator = ...
communicator->removeAdminFacet("Process");
Ice::ProcessPtr myProcessFacet = new MyProcessFacet(...);
communicator->addAdminFacet(myProcessFacet, "Process");

```

The final step is to activate the administrative facility by calling `getAdmin` on the communicator:

C++

```
communicator->getAdmin();
```

Integrating the Process Facet with an Activation Service

If the `Ice.Admin.ServerId` and `Ice.Default.Locator` properties are defined, the Ice run time performs the following steps after creating the `Ice.Admin` object adapter:

- Obtains proxies for the `Process` facet and the default locator
- Invokes `getRegistry` on the proxy to obtain a proxy for the locator registry
- Invokes `setServerProcessProxy` on the locator registry and supplies the value of `Ice.Admin.ServerId` along with a proxy for the `Process` facet

The identifier specified by `Ice.Admin.ServerId` must uniquely identify the process within the locator registry.

In the case of `IceGrid`, the node defines the `Ice.Admin.ServerId` and `Ice.Default.Locator` properties for each deployed server. The node also supplies a value for `Ice.Admin.Endpoints` if the property is not defined by the server.

See Also

- [Communicators](#)
- [Facets and Versioning](#)
- [Portable Signal Handling in C++](#)
- [Security Considerations for Administrative Facets](#)
- [Object Adapters](#)
- [The Administrative Object Adapter](#)
- [Ice Administrative Properties](#)
- [IceGrid](#)

The Properties Facet

On this page:

- [The PropertiesAdmin Interface](#)
- [Property Update Notifications](#)
 - [Implementing a Property Update Callback in C++](#)
 - [Implementing a Property Update Callback in Java](#)
 - [Implementing a Property Update Callback in C#](#)

The PropertiesAdmin Interface

An administrator may find it useful to be able to view or modify the configuration properties of a remote Ice application. For example, the Ice Grid administrative tools allow you to query and update the properties of active servers. The `Properties` facet supplies this functionality.

The `Ice::PropertiesAdmin` interface provides access to the communicator's configuration properties:

Slice

```

module Ice {
  interface PropertiesAdmin {
    string getProperty(string key);
    PropertyDict getPropertiesForPrefix(string prefix);
    void setProperties(PropertyDict newProperties);
  };
};

```

The `getProperty` operation retrieves the value of a single property, and the `getPropertiesForPrefix` operation returns a dictionary of properties whose keys match the given prefix. These operations have the same semantics as those in the `Ice::Properties` interface.

The `setProperties` operation merges the entries in `newProperties` with the communicator's existing properties. If an entry in `newProperties` matches the name of an existing property, that property's value is replaced with the new value. If the new value is an empty string, the property is removed. Any existing properties that are not modified or removed by the entries in `newProperties` are retained with their original values. If the `Ice.Trace.Admin.Properties` property is enabled, Ice logs a message if a call to `setProperties` results in any changes to the property set.



Modifying a program's configuration properties at run time may not have an effect on the program. For example, many of Ice's standard configuration properties are read once during communicator initialization, and never again.

Property Update Notifications

The Ice run time can notify an application whenever its properties change due to invocations of the `setProperties` operation on the `PropertiesAdmin` interface. This section describes the native API for receiving property updates.

Implementing a Property Update Callback in C++

The `Properties` facet object provided by the Ice run time derives from the class `NativePropertiesAdmin`:

C++

```

namespace Ice {
class NativePropertiesAdmin : virtual public IceUtil::Shared {
public:
    virtual void addUpdateCallback(const
PropertiesAdminUpdateCallbackPtr& cb);
    virtual void removeUpdateCallback(const
PropertiesAdminUpdateCallbackPtr& cb);
};
typedef IceUtil::Handle<NativePropertiesAdmin> NativePropertiesAdminPtr;
}

```

The application must supply an instance of `PropertiesAdminUpdateCallback`:

C++

```

namespace Ice {
class PropertiesAdminUpdateCallback : virtual public Ice::LocalObject {
public:
    virtual void updated(const PropertyDict& changes) = 0;
};
typedef IceUtil::Handle<PropertiesAdminUpdateCallback>
PropertiesAdminUpdateCallbackPtr;
}

```

The `updated` method receives a `dictionary<string, string>` value representing the properties that were added, changed or removed, with removed properties denoted by an entry whose value is an empty string. It is legal for the `updated` implementation to modify the set of callbacks, and Ice ignores any exceptions it might raise.

The following code demonstrates how to register a callback:

C++

```

Ice::ObjectPtr obj = communicator->findAdminFacet("Properties");
if(obj) { // May be nil if the facet is not enabled
    Ice::NativePropertiesAdminPtr facet =
Ice::NativePropertiesAdminPtr::dynamicCast(obj);
    Ice::PropertiesAdminUpdateCallbackPtr myCallback = new ...;
    facet->addUpdateCallback(myCallback);
}

```

Implementing a Property Update Callback in Java

The `Properties` facet object provided by the Ice run time derives from the class `NativePropertiesAdmin`:

Java

```
package Ice;

public interface NativePropertiesAdmin {
    void addUpdateCallback(PropertiesAdminUpdateCallback callback);
    void removeUpdateCallback(PropertiesAdminUpdateCallback callback);
}
```

The application must supply an instance of `PropertiesAdminUpdateCallback`:

Java

```
package Ice;

public interface PropertiesAdminUpdateCallback {
    void updated(java.util.Map<String, String> changes);
}
```

The `updated` method receives a `dictionary<string, string>` value representing the properties that were added, changed or removed, with removed properties denoted by an entry whose value is an empty string. It is legal for the `updated` implementation to modify the set of callbacks, and Ice ignores any exceptions it might raise.

The following code demonstrates how to register a callback:

Java

```
Ice.Object obj = communicator.findAdminFacet("Properties");
if(obj != null) { // May be nil if the facet is not enabled
    Ice.NativePropertiesAdmin facet = (Ice.NativePropertiesAdmin)obj;
    Ice.PropertiesAdminUpdateCallback myCallback = new ...;
    facet.addUpdateCallback(myCallback);
}
```

Implementing a Property Update Callback in C#

The `Properties` facet object provided by the Ice run time derives from the class `NativePropertiesAdmin`:

C#

```
namespace Ice {
    public interface NativePropertiesAdmin {
        void addUpdateCallback(PropertiesAdminUpdateCallback callback);
        void removeUpdateCallback(PropertiesAdminUpdateCallback
callback);
    }
}
```

The application must supply an instance of `PropertiesAdminUpdateCallback`:

```
C#
```

```
namespace Ice {
    public interface PropertiesAdminUpdateCallback {
        void updated(System.Collections.Generic.Dictionary<string,
string> changes);
    }
}
```

The `updated` method receives a `dictionary<string, string>` value representing the properties that were added, changed or removed, with removed properties denoted by an entry whose value is an empty string. It is legal for the `updated` implementation to modify the set of callbacks, and Ice ignores any exceptions it might raise.

The following code demonstrates how to register a callback:

```
C#
```

```
Ice.Object obj = communicator.findAdminFacet("Properties");
if(obj != null) { // May be nil if the facet is not enabled
    Ice.NativePropertiesAdmin facet = obj as Ice.NativePropertiesAdmin;
    Ice.PropertiesAdminUpdateCallback myCallback = new ...;
    facet.addUpdateCallback(myCallback);
}
```

See Also

- [Properties and Configuration](#)
- [Facets and Versioning](#)
- [IceGrid](#)

The Metrics Facet

The `Metrics` facet implements the [Instrumentation Facility](#) to provide convenient access to metrics for the Ice run time and select Ice services. The metrics provided by this facet include the number of threads currently running and their state, the number of connections, information on invocations and dispatch, as well as connection establishment and endpoint name resolution.

On this page:

- [Metrics Terminology](#)
- [Metrics Types](#)
- [The `MetricsAdmin` Interface](#)
- [Metrics Attributes](#)

Metrics Terminology

- **metric:** an "analytical measurement intended to quantify the state of a system", recorded by the Ice run time, such as bytes sent over a connection.
- **metric name:** the name of the metric, such as "number of connections".
- **metrics map:** a collection of metrics objects.
- **metrics view:** a collection of metrics maps. A view contains metrics maps of different types (e.g., connections and threads). Several metrics views can be configured with different purposes. For example, you can have a "debug" metrics view to get detailed metrics of each of the instrumented objects in the Ice communicator. This view can be enabled from time to time for debugging purposes but it's disabled most of the time. You could also have a more coarse-grained metrics view to collect data at a higher level, such as the amount of bytes received and sent by all the connections from the communicator. This metrics view can be enabled all the time.

Metrics Types

Metrics are specified as Slice classes defined in the `Ice/Metrics.ice` Slice file. All the metrics types are defined in the `IceMX` module.

The base class is `IceMX::Metrics`:

Slice
<pre>class Metrics { string id; long total = 0; int current = 0; long totalLifetime = 0; int failures = 0; };</pre>

A metrics object is an instance of `IceMX::Metrics` and represents metrics of one or more instrumented objects. An instrumented object can be anything that supports instrumentation. The Ice run time supports instrumentation of the following objects and activities:

- Threads
- Connections
- Invocations
- Dispatch
- Connection establishment
- Endpoint resolution

The `id` of a metric identifies the instrumented object(s). The `total` and `current` members specify the total and current number of instrumented objects created since the creation of the Ice communicator, respectively. The `totalLifetime` member is the sum of the lifetime of each instrumented object and `failures` is the number of failures that have occurred for the metrics object(s).

Failures are specified using a separate `IceMX::MetricsFailures` structure:

Slice
<pre>struct MetricsFailures { string id; StringIntDict failures; };</pre>

The `failures` dictionary provides the count of each type of failure for a metric identified by `id`. Failures are dependent on the instrumented objects. For example, failures for Ice connections are represented with the name of the exception that caused the connection to fail (e.g., `Ice::ConnectionLostException` or `Ice::TimeoutException`).

A metrics map is simply defined as a sequence of `IceMX::Metrics` objects, and a metrics view is defined as a dictionary of metrics map:

Slice
<pre>sequence<Metrics> MetricsMap; dictionary<string, MetricsMap> MetricsView;</pre>

The key for the metrics view dictionary is a string that identifies the metrics map. The Ice run time supports the following metrics maps:

Metrics map name	Slice class	Description
Connection	<code>IceMX::ConnectionMetrics</code>	Connection metrics.
Thread	<code>IceMX::ThreadMetrics</code>	Thread metrics. The Ice run time instruments threads for the communicator's thread pools as well as threads used internally.
Invocation	<code>IceMX::InvocationMetrics</code>	Client-side proxy invocation metrics.
Dispatch	<code>IceMX::DispatchMetrics</code>	Server-side dispatch metrics.
EndpointLookup	<code>IceMX::Metrics</code>	Endpoint lookup metrics. For tcp, ssl and udp endpoints, this corresponds to the DNS lookups made to resolve the host names in endpoints.
ConnectionEstablishment	<code>IceMX::Metrics</code>	Connection establishment metrics.

A metrics map can also contain sub-metrics maps. An example is the `Invocation` metrics map, which provides a `Remote` sub-metrics map to record metrics associated with remote invocations. The Slice class for remote invocation metrics is `IceMX::Metrics`.

The MetricsAdmin Interface

The Slice interface `IceMX::MetricsAdmin` allows you to retrieve the metrics associated with the Ice communicator:

Slice

```

module IceMX {
exception UnknownMetricsView {};

interface MetricsAdmin {
    Ice::StringSeq getMetricsViewNames(out Ice::StringSeq disableViews);
    void enableMetricsView(string name)
        throws UnknownMetricsView;
    void disableMetricsView(string name)
        throws UnknownMetricsView;
    MetricsView getMetricsView(string view, out long timestamp)
        throws UnknownMetricsView;
    MetricsFailuresSeq getMapMetricsFailures(string view, string map)
        throws UnknownMetricsView;
    MetricsFailures getMetricsFailures(string view, string map, string
id)
        throws UnknownMetricsView;
};
};

```

The `getMetricsViewName` operation retrieves the names of the configured enabled and disabled views. The `enableMetricsView` and `disableMetricsView` allow to enable and disable a specific view. Calling those methods is equivalent to setting the view `Disabled` property to 1 or 0. The `getMetricsView` operation returns the metrics for the given view. The `getMapMetricsFailures` and `getMetricsFailures` operations retrieve the metrics failures for a given map or metrics id.

Metrics Attributes

Metrics views are configured with [IceMX Metrics properties](#).

The `GroupBy`, `Accept` and `Reject` properties are specified using attributes that are specific to each metrics map. The table below describes the attributes supported by the Ice run time's metrics maps.

Name	Maps	Description
id	All	A unique identifier to select the instrumented object or operation.
parent	All	The parent of the instrumented object or operation.
none	All	The none attribute is a special attribute that evaluates to the empty string.
endpoint	Connection, Dispatch, Remote, ConnectionEstablishment, EndpointLookup	The stringified endpoint.
endpointType	Connection, Dispatch, Remote, ConnectionEstablishment, EndpointLookup	The endpoint numerical type as defined in <code>Ice/Endpoint.ice</code> .
endpointIsDatagram	Connection, Dispatch, Remote, ConnectionEstablishment, EndpointLookup	A boolean indicating if the endpoint is a datagram endpoint.

endpointIsSecure	Connection, Dispatch, Remote, ConnectionEstablishment, EndpointLookup	A boolean indicating if the endpoint is secure.
endpointTimeout	Connection, Dispatch, Remote, ConnectionEstablishment, EndpointLookup	The endpoint timeout.
endpointCompress	Connection, Dispatch, Remote, ConnectionEstablishment, EndpointLookup	A boolean indicating if the endpoint requires compression.
endpointHost	Connection, Dispatch, Remote, ConnectionEstablishment, EndpointLookup	The endpoint host.
endpointPort	Connection, Dispatch, Remote, ConnectionEstablishment, EndpointLookup	The endpoint port.
connection	Dispatch	The connection description.
incoming	Connection, Dispatch, Remote	A boolean where true indicates an incoming (server) connection and false an outgoing (client) connection.
adapterName	Connection, Dispatch, Remote	If the connection is a server connection, adapterName returns the name of the adapter that created the connection, otherwise it is the empty string.
connectionId	Connection, Dispatch, Remote	The ID of the connection if one is set, otherwise it is the empty string.
localAddress	Connection, Dispatch, Remote	The connection's local address.
localPort	Connection, Dispatch, Remote	The connection's local port.
remoteAddress	Connection, Dispatch, Remote	The connection's remote address.
remotePort	Connection, Dispatch, Remote	The connection's remote port.
mcastAddress	Connection, Dispatch, Remote	The connection's multicast address.
mcastPort	Connection, Dispatch, Remote	The connection's multicast port.
state	Connection	The state of the connection.
operation	Dispatch, Invocation	The dispatched or invoked operation name.
identity	Dispatch, Invocation	The identity of the Ice object used for the dispatch or invocation.
facet	Dispatch, Invocation	The facet of the Ice object used for the dispatch or invocation.
mode	Dispatch, Invocation	The dispatch or invocation mode.
context.key	Dispatch, Invocation	The value of the dispatch or invocation context with the given key.
proxy	Invocation	The proxy used for the invocation.
encoding	Invocation	The proxy encoding.

The `id`, `parent` and `none` attributes are supported by all maps.

The value of the `parent` attribute depends on the map. For the `Connection`, `Dispatch` and `Remote` maps, the `parent` will either be

"Communicator" if the connection is a client connection, or the object adapter name if it's a server connection. For the Invocation, EndpointLookup, and ConnectionEstablishment maps, it will always be "Communicator". The `parent` attribute enables the filtering of metrics based on the object adapter. When used with the `GroupBy` property it also allows you to obtain metrics at the object adapter level. For instance, the following configuration does not monitor any metrics for the `Ice.Admin` object adapter and it groups all the metrics based on the object adapter or communicator:

```
IceMX.Metrics.MyView.GroupBy=parent
IceMX.Metrics.MyView.Reject.parent=Ice\.Admin
```

This configuration enables the communicator to get metrics on a per object adapter or communicator basis.

You can also use the `none` attribute to get metrics for the communicator including the metrics from object adapters, e.g., `IceMX.Metrics.MyView.GroupBy=none`. This provides the lowest possible level of detail as all the statistics will be recorded by a single metrics object.

The `id` attribute allows you to get a higher level of detail by recording metrics on a per instrumented object or operation basis. If you specify `IceMX.Metrics.MyView.GroupBy=id`, the `Metrics` facet will record metrics for each individual object or operation.

See Also

- [Instrumentation Facility](#)
- [The Administrative Object Adapter](#)
- [Ice Administrative Properties](#)

Filtering Administrative Facets

The Ice run time enables all of its built-in [administrative facets](#) by default, and an application may install its own [custom facets](#). You can control which facets the Ice run time enables using the `Ice.Admin.Facets` property. For example, the following property definition enables the `Properties` facet and leaves the `Process` facet (and any application-defined facets) disabled:

```
Ice.Admin.Facets=Properties
```

To specify more than one facet, separate them with a comma or white space. A facet whose name contains white space must be enclosed in single or double quotes.

See Also

- [The Process Facet](#)
- [The Properties Facet](#)
- [The Metrics Facet](#)
- [Custom Administrative Facets](#)
- [Ice Administrative Properties](#)

Custom Administrative Facets

An application can add and remove administrative facets using the `Communicator` operations shown below:

```

Slice



```
module Ice {
 local interface Communicator {
 // ...
 void addAdminFacet(Object servant, string facet);
 Object removeAdminFacet(string facet);
 };
};
```

```

The `addAdminFacet` operation installs a new facet with the given name, or raises `AlreadyRegisteredException` if a facet already exists with the same name. The `removeAdminFacet` operation removes (and returns) the facet with the given name, or raises `NotRegisteredException` if no matching facet is found.

The mechanism for [filtering administrative facets](#) also applies to application-defined facets. If you call `addAdminFacet` while a filter is in effect, and the name of your custom facet does not match the filter, the Ice run time will not expose your facet but instead keeps a reference to it so that a subsequent call to `removeAdminFacet` is possible.

We provide an example of using these communicator operations in our discussion of the [Process](#) facet.

See Also

- [Filtering Administrative Facets](#)
- [The Process Facet](#)

Security Considerations for Administrative Facets

Exposing administrative functionality naturally makes a program vulnerable, therefore it is important that proper precautions are taken. With respect to the default functionality, the `Properties` facet could expose sensitive configuration information, and the `Process` facet supports a `shutdown` operation that opens the door for a denial-of-service attack. Developers should carefully consider the security implications of any additional administrative facets that an application installs.

There are several approaches you can take to mitigate the possibility of abuse:

- Disable the administrative facility

The administrative facility is disabled by default, and remains disabled as long as its `prerequisites` are not met. Note that `IceGrid` enables the facility in servers that it activates for the following reasons:

This page contains macros or features from a plugin which requires a valid license.

You will need to:

1. Install the [Plugin Licensing Manager](#).
2. Visit the Plugin Licensing Manager and acquire the necessary licenses.

[Licensing Help?](#)

The Adaptavist Content Formatting Macros plugin requires a license.

This page contains macros or features from a plugin which requires a valid license.

You will need to:

1. Install the [Plugin Licensing Manager](#).
2. Visit the Plugin Licensing Manager and acquire the necessary licenses.

[Licensing Help?](#)

The Adaptavist Content Formatting Macros plugin requires a license.

- The `Process` facet allows the IceGrid node to gracefully terminate the process.

This page contains macros or features from a plugin which requires a valid license.

You will need to:

1. Install the [Plugin Licensing Manager](#).
2. Visit the Plugin Licensing Manager and acquire the necessary licenses.

[Licensing Help?](#)

The Adaptavist Content Formatting Macros plugin requires a license.

- The `Properties` facet enables IceGrid administrative clients to obtain configuration information about activated servers. You could disable a facet using filtering, but doing so may disrupt IceGrid's normal operation.

- Select a proper endpoint

A reasonably secure value for the `Ice.Admin.Endpoints` property is one that uses the local host interface (`-h 127.0.0.1`), which restricts access to clients that run on the same host. Incidentally, this is the default value that IceGrid defines for its servers, although you can override that if you like. Note that using a local host endpoint does not preclude [remote administration](#) for IceGrid servers because IceGrid transparently routes requests on `admin` objects to the appropriate server via its node. If your application must support administration from non-local hosts, we recommend the use of [SSL](#) and certificate-based access control.

- Filter the facets

After choosing a suitable endpoint, you can minimize risks by filtering the facets to enable only the functionality that is required. For

example, if you are not using IceGrid's [server activation](#) feature and do not require the ability to remotely terminate a program, you should disable the `Process` facet using the [filtering mechanism](#).

- Consider the object's identity

The default [identity](#) of the `admin` object has a UUID for its category, which makes it difficult for a hostile client to guess. Depending on your requirements, the use of a UUID may be an advantage or a disadvantage. For example, in a trusted environment, the use of a UUID may create additional work, such as the need to add an interface that an administrative client can use to obtain the identity or proxy of a remote `admin` object. An obscure identity might be more of a hindrance in this situation, and therefore specifying a static category via the `Ice.Admin.InstanceName` property is a reasonable alternative. In general, however, we recommend using the default behavior.

See Also

- [The admin Object](#)
- [The Properties Facet](#)
- [The Process Facet](#)
- [The Administrative Object Adapter](#)
- [IceGrid and the Administrative Facility](#)
- [Filtering Administrative Facets](#)
- [Ice Administrative Properties](#)
- [IceGrid](#)
- [IceSSL](#)

Instrumentation Facility

The Ice run time can be instrumented using observer interfaces that monitor many aspects of the run time's internal objects and activities, including connections, threads, servant dispatching, proxy invocations, endpoint lookups and connection establishment. We refer to these internal objects and activities as "instrumented objects" in the discussion below. The application is responsible for implementing the instrumentation observer interfaces. Note however that an implementation of these interfaces is provided by the [Metrics Facet](#), so most applications do not need to implement them and can instead collect metrics through the `MetricsAdmin` facet. The definition of the instrumentation interfaces can be found in the `Ice/Instrumentation.ice` Slice file.

The Ice run time uses the `Ice::Instrumentation::CommunicatorObserver` interface to obtain observers for instrumented objects created by the run time:

Slice
<pre> module Ice { module Instrumentation { local interface CommunicatorObserver { Observer getConnectionEstablishmentObserver(Endpoint endpt, string connector); Observer getEndpointLookupObserver(Endpoint endpt); ConnectionObserver getConnectionObserver(ConnectionInfo c, Endpoint e, ConnectionState s, ConnectionObserver o); ThreadObserver getThreadObserver(string parent, string id, ThreadState s, ThreadObserver o); InvocationObserver getInvocationObserver(Object* prx, string operation, Context ctx); DispatchObserver getDispatchObserver(Current c); void setObserverUpdater(ObserverUpdater updater); }; }; local interface Communicator { Ice::Instrumentation::CommunicatorObserver getObserver(); // ... }; }; </pre>

The Ice run time calls the appropriate `get...Observer` operation each time a new instrumented object is created. The implementation of these methods should return an observer, or `nil` if the implementation does not want to monitor the instrumented object. This observer is associated with the instrumented object and receives notifications of any changes to its attributes or state. All observer interfaces derive from the `Ice::Instrumentation::Observer` base interface:

Slice

```
local interface Observer {
    void attach();
    void detach();
    void failed(string exceptionName);
};
```

The `attach` operation is called upon association of the observer with the new instrumented object. The `detach` operation is called when the object is destroyed. The `failed` operation is called to report any failures that might occur during the lifetime of the instrumented object. Observer specializations provide additional operations for monitoring other attributes. For example, here is the `Ice::Instrumentation::ConnectionObserver` interface:

Slice

```
local interface ConnectionObserver extends Observer {
    void sentBytes(int num);
    void receivedBytes(int num);
};
```

The `sentBytes` and `receivedBytes` methods are called by the Ice connection when new bytes are received or sent over the connection.

Shown below is an implementation of the communicator and connection observer interfaces to record sent and received bytes on a per-connection basis. The observer dumps how many bytes were received and sent for the connection when it is detached:

C++

```
class ConnectionObserverImpl : public
Ice::Instrumentation::ConnectionObserver {
public:
    ConnectionObserverImpl(const Ice::ConnectionInfoPtr& connInfo) :
        info(connInfo), sentBytes(0), receivedBytes(0)
    {
    }

    void attach() {}

    void detach()
    {
        cerr << info->remoteHost << ":" << info->remotePort << ": sent
bytes = "
            << sentBytes << ", received bytes = " << receivedBytes <<
endl;
    }

    void sentBytes(int num)
    {
        sentBytes += num;
    }
};
```

```
void receivedBytes(int num)
{
    receivedBytes += num;
}

void failed(const std::string&)
{
}

private:

    Ice::ConnectionInfoPtr info;
    long sentBytes;
    long receivedBytes;
};

class CommunicatorObserverImpl : public
Ice::Instrumentation::CommunicatorObserver {
public:

    Ice::Instrumentation::ConnectionObserverPtr
    getConnectionObserver(const Ice::ConnectionInfoPtr& c, const
Ice::EndpointPtr& e,
                        Ice::Instrumentation::ConnectionState s,
                        const
Ice::Instrumentation::ConnectionObserverPtr& previous)
    {
        return new ConnectionObserverImpl(c);
    }
};
```



```

    }
};

```

For brevity we have omitted the implementation of the other `get...Observer` methods; they all return 0 as we are only interested in instrumenting connections.

To register your implementation, you must pass it in an `InitializationData` parameter when you [initialize a communicator](#):

C++

```

Ice::InitializationData id;
id.observer = new CommunicatorObserverImpl();
Ice::CommunicatorPtr ic = Ice::initialize(id);

```

You can install a `CommunicatorObserver` object on either the client or the server side (or both). Here is some example output produced by installing our `CommunicatorObserver` and `ConnectionObserver` object implementations in a simple server:

```

127.0.0.1:3487: sent bytes = 14, received bytes = 32
127.0.0.1:3487: sent bytes = 33, received bytes = 14
127.0.0.1:3490: sent bytes = 14, received bytes = 14
...

```

In addition to the operations for retrieving observers, the `CommunicatorObserver` interface also defines a `setObserverUpdater` operation that is called by the Ice run time on initialization to provide an updater object to the `CommunicatorObserver` implementation. This updater object can be used to "refresh" some of the created observers. The updater object provided by the Ice run time implements the following interface:

Slice

```

local interface ObserverUpdater {
    void updateConnectionObservers();
    void updateThreadObservers();
};

```

The `CommunicatorObserver` implementation can call these operations to update the observers associated with Ice connections or threads. When one of these operations is called, the Ice run time calls the matching `get...Observer` method on the `CommunicatorObserver` interface for each of the instrumented objects. For example, if you call `updateConnectionObservers`, your implementation of `getConnectionObserver` will be called again for each Ice connection in the communicator. The `previous` parameter to `getConnectionObserver` represents the observer that is currently associated with the connection.

This mechanism can be used to re-configure the observers associated with instrumented objects. For instance, the application might not wish to instrument connections all the time but only when needed. It can use the observer updater to enable or disable the instrumentation. Here is the example above modified to provide this functionality:

C++

```

class CommunicatorObserverImpl : public
Ice::Instrumentation::CommunicatorObserver,
                                private IceUtil::Mutex {
public:

    Ice::Instrumentation::ConnectionObserverPtr
    getConnectionObserver(const Ice::ConnectionInfoPtr& c, const
Ice::EndpointPtr& e,
                                Ice::Instrumentation::ConnectionState s,
                                const
Ice::Instrumentation::ConnectionObserverPtr& previous)
    {
        Lock sync(*this);
        return enabled ? new ConnectionObserverImpl(c) : 0;
    }

    void setEnabled(bool enabled)
    {
        {
            Lock sync(*this);
            if(this->enabled == enabled)
                return;
            this->enabled = enabled;
        }
        updater->updateConnections();
    }

    void setObserverUpdater(const
Ice::Instrumentation::ObserverUpdaterPtr& updater)
    {
        this->updater = updater;
    }

    const Ice::Instrumentation::ObserverUpdaterPtr updater;
    bool enabled;
};

```

As you can see in the example above, special care needs to be taken with respect to synchronization. The Ice run time can call observers with Ice internal locks held to guarantee consistency of the information passed to the `get...Observer` methods. It is therefore important that the implementation of your observers performs quickly and does not create deadlocks. Your observers should not make remote invocations or call Ice APIs that require acquiring locks on instrumented objects.

See Also

- [Communicator Initialization](#)
- [The Metrics Facet](#)

Logger Facility

Depending on the setting of [various properties](#), the Ice run time produces trace, warning, or error messages. These messages are written via the `Ice::Logger` interface:

```

Slice



```
module Ice {
 local interface Logger {
 void print(string message);
 void trace(string category, string message);
 void warning(string message);
 void error(string message);
 Logger cloneWithPrefix(string prefix);
 };
};
```

```

The `cloneWithPrefix` operation returns a new logger that logs to the same destination but with a different prefix. (The prefix is used to, for example, provide the name of the process writing the log messages.)

Topics

- [The Default Logger](#)
- [Custom Loggers](#)
- [Built-in Loggers](#)
- [Logger Plug-ins](#)
- [The Per-Process Logger](#)
- [C++ Logger Utility Classes](#)

See Also

- [Properties and Configuration](#)

The Default Logger

A default [logger](#) is instantiated when you create a communicator. The default logger writes its messages to the standard error output. The `trace` operation accepts a `category` parameter in addition to the error message; this allows you to separate trace output from different subsystems by sending the output through a filter.

You can obtain the logger that is attached to a communicator using the `getLogger` operation:

```

Slice



```
module Ice {
 local interface Communicator {
 Logger getLogger();
 // ...
 };
};
```

```

See Also

- [Logger Facility](#)

Custom Loggers

You have several options if you wish to install a logger other than the default one:

- Select one of the other [built-in loggers](#), which allow you to log to a file, to the `syslog` on Unix, and to the Windows event log
- Supply your own logger implementation in an `InitializationData` parameter when you create a communicator
- Load a logger implementation dynamically via the Ice [plug-in facility](#)

Changing the `Logger` object that is attached to a communicator allows you to integrate Ice messages into your own message handling system. For example, for a complex application, you might have an existing logging framework. To integrate Ice messages into that framework, you can create your own `Logger` implementation that logs messages to the existing framework.

When you destroy a communicator, its logger is *not* destroyed. This means that you can safely use a logger even beyond the lifetime of its communicator.

See Also

- [Built-in Loggers](#)
- [Communicator Initialization](#)
- [Logger Plug-ins](#)

Built-in Loggers

Ice provides a file-based logger as well as Unix- and Windows-specific logger implementations. For .NET, the default Ice logger uses a `TraceListener` and so can be customized at run time via configuration.

On this page:

- [File Logger](#)
- [Syslog Logger](#)
- [Windows Logger](#)
- [.NET Logger](#)

File Logger

The file-based logger is enabled via the `Ice.LogFile` property. This logger is available for all supported languages and platforms.

Syslog Logger

You can activate a logger that logs via the Unix `syslog` implementation by setting the `Ice.UseSyslog` property. This logger is available in Ice for C++, Java, and C#, as well as for scripting languages based on Ice for C++.

Windows Logger

On Windows, subclasses of `Ice::Service` use the Windows application event log by default. The event log implementation is available for C++ applications.

.NET Logger

The default logger in Ice for .NET writes its messages using the `System.Diagnostics.Trace` facility. By default, the Ice run time registers a `ConsoleTraceListener` that writes to `stderr`. You can disable the logging of messages via this trace listener by setting the property `Ice.ConsoleListener` to zero.

You can change the trace listener for your application via the application's configuration file. For example:

```
<configuration>
  <system.diagnostics>
    <trace autoflush="true" indentsize="4">
      <listeners>
        <add name="Console"
              type="System.Diagnostics.EventLogTraceListener"
              initializeData="true"/>
      </listeners>
    </trace>
  </system.diagnostics>
</configuration>
```

This configures a trace listener that logs to the Windows event log.

See Also

- [The Server-Side main Function in C++](#)

Logger Plug-ins

Installing a [custom logger](#) using the Ice plug-in facility has several advantages. Because the logger plug-in is specified by a configuration property and loaded dynamically by the Ice run time, an application requires no code changes in order to utilize a custom logger implementation. Furthermore, a logger plug-in takes precedence over the [per-process logger](#) and the logger supplied in the `InitializationData` argument during [communicator initialization](#), meaning you can use a logger plug-in to override the logger that an application installs by default.

On this page:

- [Installing a C++ Logger Plug-in](#)
- [Installing a Java Logger Plug-in](#)
- [Installing a C# Logger Plug-in](#)

Installing a C++ Logger Plug-in

To install a logger plug-in in C++, you must first define a subclass of `Ice::Logger`:

```

C++
class MyLoggerI : public Ice::Logger {
public:

    virtual void print(const std::string& message);
    virtual void trace(const std::string& category,
const std::string& message);
    virtual void warning(const std::string& message);
    virtual void error(const std::string& message);
    virtual LoggerPtr cloneWithPrefix(const string& prefix);

    // ...
};

```

Next, supply a factory function that installs your custom logger by returning an instance of `Ice::LoggerPlugin`:

```

C++
extern "C"
{

    ICE_DECLSPEC_EXPORT Ice::Plugin*
    createLogger(const Ice::CommunicatorPtr& communicator,
                const std::string& name,
                const Ice::StringSeq& args)
    {
        Ice::LoggerPtr logger = new MyLoggerI;
        return new Ice::LoggerPlugin(communicator, logger);
    }

}

```

The factory function can have any name you wish; we used `createLogger` in this example. Refer to the [plug-in API](#) for more information on

plug-in factories.

The definition of `LoggerPlugin` is shown below:

```
C++
```

```
namespace Ice {
class LoggerPlugin {
public:
    LoggerPlugin(const CommunicatorPtr&, const LoggerPtr&);

    virtual void initialize();
    virtual void destroy();
};
}
```

The constructor installs your logger into the given communicator. The `initialize` and `destroy` methods are empty, but you can subclass `LoggerPlugin` and override these methods if necessary.

Finally, define a configuration property that loads your plug-in into an application:

```
Ice.Plugin.MyLogger=mylogger:createLogger
```

The plug-in's name in this example is `MyLogger`; again, you can use any name you wish. The value of the property represents the plug-in's entry point, in which `mylogger` is the abbreviated form of its shared library or DLL, and `createLogger` is the name of the factory function.

If the configuration file containing this property is shared by programs in multiple implementation languages, you can use an alternate syntax that is loaded only by the Ice for C++ run time:

```
Ice.Plugin.MyLogger.cpp=mylogger:createLogger
```

Installing a Java Logger Plug-in

To install a logger plug-in in Java, you must first define a subclass of `Ice.Logger`:

```
Java
```

```
public class MyLoggerI implements Ice.Logger {

    public void print(String message) { ... }
    public void trace(String category, String message) { ... }
    public void warning(String message) { ... }
    public void error(String message) { ... }
    public Logger cloneWithPrefix(String prefix) { ... }

    // ...
}
```

Next, define a factory class that installs your custom logger by returning an instance of `Ice.LoggerPlugin`:

```

Java
public class MyLoggerPluginFactoryI implements Ice.PluginFactory {
    public Ice.Plugin create(Ice.Communicator communicator,
                            String name, String[] args)
    {
        Ice.Logger logger = new MyLoggerI();
        return new Ice.LoggerPlugin(communicator, logger);
    }
}

```

The factory class can have any name you wish; in this example, we used `MyLoggerPluginFactoryI`. Refer to the [plug-in API](#) for more information on plug-in factories.

The definition of `LoggerPlugin` is shown below:

```

Java
package Ice;

public class LoggerPlugin implements Plugin {
    public LoggerPlugin(Communicator communicator, Logger logger)
    {
        // ...
    }

    public void initialize() { }

    public void destroy() { }
}

```

The constructor installs your logger into the given communicator. The `initialize` and `destroy` methods are empty, but you can subclass `LoggerPlugin` and override these methods if necessary.

Finally, define a [configuration property](#) that loads your plug-in into an application:

```
Ice.Plugin.MyLogger=MyLoggerPluginFactoryI
```

The plug-in's name in this example is `MyLogger`; again, you can use any name you wish. The value of the property is the name of the factory class.

If the configuration file containing this property is shared by programs in multiple implementation languages, you can use an alternate syntax that is loaded only by the Ice for Java run time:

```
Ice.Plugin.MyLogger.java=MyLoggerPluginFactoryI
```

Installing a C# Logger Plug-in

To install a logger plug-in in .NET, you must first define a subclass of `Ice.Logger`:

```

C#
public class MyLoggerI : Ice.Logger {

    public void print(string message) { ... }
    public void trace(string category, string message) { ... }
    public void warning(string message) { ... }
    public void error(string message) { ... }
    public Logger cloneWithPrefix(string prefix) { ... }

    // ...
}

```

Next, define a factory class that installs your custom logger by returning an instance of `Ice.LoggerPlugin`:

```

C#
public class MyLoggerPluginFactoryI : Ice.PluginFactory {
    public Ice.Plugin create(Ice.Communicator communicator,
                           string name, string[] args)
    {
        Ice.Logger logger = new MyLoggerI();
        return new Ice.LoggerPlugin(communicator, logger);
    }
}

```

The factory class can have any name you wish; in this example, we used `MyLoggerPluginFactoryI`. Refer to the [plug-in API](#) for more information on plug-in factories. Typically the logger implementation and the factory are compiled into a single assembly.

The definition of `LoggerPlugin` is shown below:

```

C#
namespace Ice {
public partial class LoggerPlugin : Plugin {
    public LoggerPlugin(Communicator communicator, Logger logger)
    {
        // ...
    }

    public void initialize() { }

    public void destroy() { }
}
}

```

The constructor installs your logger into the given communicator. The `initialize` and `destroy` methods are empty, but you can subclass `LoggerPlugin` and override these methods if necessary.

Finally, define a configuration property that loads your plug-in into an application:

```
Ice.Plugin.MyLogger=mylogger.dll:MyLoggerPluginFactoryI
```

The plug-in's name in this example is `MyLogger`; again, you can use any name you wish. The value of the property is the entry point for the factory, consisting of an assembly name followed by the name of the factory class.

If the configuration file containing this property is shared by programs in multiple implementation languages, you can use an alternate syntax that is loaded only by the Ice for .NET run time:

```
Ice.Plugin.MyLogger.clr=mylogger.dll:MyLoggerPluginFactoryI
```

See Also

- [Custom Loggers](#)
- [The Per-Process Logger](#)
- [Communicator Initialization](#)
- [Plug-in API](#)
- [Ice Plug-In Properties](#)

The Per-Process Logger

Ice allows you to install a per-process [custom logger](#). This logger is used by all communicators that do not have their own specific logger established at the time a [communicator is created](#).

You can set a per-process logger in C++ by calling `Ice::setProcessLogger`, and you can retrieve the per-process logger by calling `Ice::getProcessLogger`:

C++

```
LoggerPtr getProcessLogger();
void setProcessLogger(const LoggerPtr&);
```

If you call `getProcessLogger` without having called `setProcessLogger` first, the Ice run time installs a default per-process logger. Note that if you call `setProcessLogger`, only communicators created after that point will use this per-process logger; communicators created earlier use the logger that was in effect at the time they were created. (This also means that you can call `setProcessLogger` multiple times; communicators created after that point will use whatever logger was established by the last call to `setProcessLogger`.)

`getProcessLogger` and `setProcessLogger` are language-specific APIs that are not defined in Slice. Therefore, for Java and C#, these methods appear in the `Ice.Util` class.

For applications that use the `Application` or `Service` convenience classes and do not explicitly configure a logger, these classes set a default per-process logger that uses the `Ice.ProgramName` property as a prefix for log messages. The `Application` class is described in the server-side language mapping chapters; more information on the `Service` class can be found in [The `Ice::Service` Class](#).

See Also

- [Custom Loggers](#)
- [Communicator Initialization](#)
- [The Server-Side main Function in C++](#)

C++ Logger Utility Classes

The Ice run time supplies a collection of utility classes that make use of the [logger facility](#) simpler and more convenient. Each of the `Logger` interface's four operations has a corresponding helper class:

```

C++

namespace Ice {
class Print {
public:
    Print(const LoggerPtr&);
    void flush();
    ...
};

class Trace {
public:
    Trace(const LoggerPtr&, const std::string&);
    void flush();
    ...
};

class Warning {
public:
    Warning(const LoggerPtr&);
    void flush();
    ...
};

class Error {
public:
    Error(const LoggerPtr&);
    void flush();
    ...
};
}

```

The only notable difference among these classes is the extra argument to the `Trace` constructor; this argument represents the trace category.

To use one of the helper classes in your application, you simply instantiate it and compose your message:

```

C++

if (errorCondition) {
    Error err(communicator->getLogger());
    err << "encountered error condition: " << errorCondition;
}

```

The Ice run time defines the necessary stream insertion operators so that you can treat an instance of a helper class as if it were a standard

C++ output stream. When the helper object is destroyed, its destructor logs the message you have composed. If you want to log more than one message using the same helper object, invoke the `flush` method on the object to log what you have composed so far and reset the object for a new message.

The helper classes also supply insertion operators to simplify the task of logging an exception. The operators accept instances of `std::exception` (from which all Ice exceptions derive) and log the string returned by the `what` method. On some platforms, you can also enable the configuration property `Ice.PrintStackTraces`, which causes the helper classes to log the stack trace of the exception in addition to the value of `what`.

See Also

- [Logger Facility](#)

Location Transparency

One of the useful features of the Ice run time is that it is *location transparent*: the client does not need to know where the implementation of an Ice object resides; an invocation on an object automatically is directed to the correct target, whether the object is implemented in the local address space, in another address space on the same machine, or in another address space on a remote machine. Location transparency is important because it allows us to change the location of an object implementation without breaking client programs and, by using `IceGrid`, addressing information such as host names and port numbers can be externalized so they do not appear in stringified proxies.

For invocations that cross address space boundaries (or more accurately, cross communicator boundaries), the Ice run time dispatches requests via the appropriate transport. However, for a proxy invocation in which the proxy and the servant that processes the invocation share the same communicator (so-called *collocated* invocations), the Ice run time, by default, does not send the invocation via the transport specified in the proxy. Instead, collocated invocations take a short-cut inside the Ice run time and are dispatched directly.



Note that if the proxy and the servant do not use the same communicator, the invocation is *not* collocated, even though caller and callee are in the same address space.

The reason for this is if collocated invocations were sent via TCP/IP, for example, invocations would still be sent via the operating system kernel (using the back plane instead of a network) and would incur the full cost of creating TCP/IP connections, marshaling requests into packets, trapping in and out of the kernel, and so on. By optimizing collocated requests, much of this overhead can be avoided, so collocated invocations are almost as fast as a local function call.

For efficiency reasons, collocated invocations are not completely location transparent, that is, a collocated call has semantics that differ in some ways from calls that cross address-space boundaries. Specifically, collocated invocations differ from ordinary invocations in the following respects:

- Collocated invocations are dispatched in the calling thread instead of being dispatched using the server's concurrency model.
- The object adapter holding state is ignored: collocated invocations proceed normally even if the target object's adapter is in the holding state.
- For collocated invocations, classes and exceptions are never sliced. Instead, the receiver always receives a class or exception as the derived type that was sent by the sender.
- If a collocated invocation throws an exception that is not in an operation's exception specification, the original exception is raised in the client instead of `UnknownUserException`. (This applies to the C++ mapping only.)
- Class factories are ignored for collocated invocations.
- Timeouts on invocations are ignored.
- If an operation implementation uses an in parameter that is passed by reference as a temporary variable, the change affects the value of the in parameter in the caller (instead of modifying a temporary copy of the parameter on the callee side only).
- Asynchronous semantics are not supported for collocated invocations.

In practice, these differences rarely matter. The most likely cause of surprises with collocated invocations is dispatch in the calling thread, that is, a collocated invocation behaves like a local, synchronous procedure call. This can cause problems if, for example, the calling thread acquires a lock that an operation implementation tries to acquire as well: unless you use [recursive mutexes](#), this will cause deadlock.

The Ice run time uses the following semantics to determine whether a proxy is eligible for the collocated optimization:

- For an indirect proxy, collocation optimization is used if the proxy's adapter ID matches the adapter ID or replica group ID of an object adapter in the same communicator.
- For a well-known proxy, the Ice run time queries each object adapter to determine if the servant is local.
- For a direct proxy, the Ice run time performs an endpoint search using the proxy's endpoints.

When an endpoint search is required, the Ice run time compares each of the proxy's endpoints against the endpoints of the communicator's object adapters. Only the transport, address and port are considered; other attributes of an endpoint, such as timeout settings, are not considered during this search. If a match is found, the invocation is dispatched using collocation optimization. Normally this search is executed only once, during the proxy's first invocation, although the proxy's [connection caching](#) setting influences this behavior.

Collocation optimization is enabled by default, but you can disable it for all proxies by setting the property `Ice.Default.CollocationOptimized=0`. You can also disable the optimization for an individual proxy using the [factory method](#) `ice_collocationOptimized(false)`. Finally, for proxies [created from a property](#) using `propertyToProxy`, the property `name.CollocationOptimized` configures the default setting for the proxy.

See Also

- [IceGrid](#)
- [Threads and Concurrency with C++](#)
- [Connection Establishment](#)
- [Proxy Methods](#)
- [Obtaining Proxies](#)

Automatic Retries

Ice may automatically retry a proxy invocation after a failure. This is a powerful feature that, when used in the proper situations, can significantly improve the robustness of your application without any additional programming effort. The retry facility is governed by one overriding principle: always respect at-most-once semantics. [At-most-once semantics](#) dictate that the Ice run time in the client must never retry a failed proxy invocation unless Ice guarantees that the server has not already received the request, or unless the application declares that it is safe for Ice to violate at-most-once semantics for the request.

To understand the importance of obeying at-most-once semantics, consider the following Slice definition:

Slice
<pre>interface Account { long withdraw(long amount); };</pre>

The `withdraw` operation removes funds from an account. If an invocation of `withdraw` fails, automatically retrying the request introduces the risk of a duplicate withdrawal unless Ice is absolutely sure that the server has not already executed the request.

This page examines automatic retries in more detail.

On this page:

- [Automatic Retries for Request Failures](#)
- [Automatic Retries for Idempotent Operations](#)
- [Configuring Automatic Retries](#)
 - [Retry Intervals](#)
 - [Retry Logging](#)
- [Timeouts and Automatic Retries](#)
- [Connections and Automatic Retries](#)
 - [Connection Errors](#)
 - [Connection Status](#)

Automatic Retries for Request Failures

Ice considers a request to have failed if any of the following conditions are true:

- A connection could not be established
- A connection was lost before the reply was received
- A timeout expired
- An exception occurred while sending the request or receiving the reply
- An error occurred in the server while dispatching the request that causes the server to return an `UnknownException` or `RequestFailedException`



Ice considers an invocation that results in a user exception to be successful and therefore excludes it from consideration for automatic retries.

Ice must determine the answers to several questions to decide whether to retry a failed request:

1. What kind of error caused the request to fail?

Ice does not bother retrying a request if it knows the same error is going to occur again. For example, Ice never retries an invocation that raises a `MarshalException`, which indicates that there was a problem while encoding or decoding a message. Retrying such an invocation is unlikely to change the outcome.

Ice also never retries exceptions that derive from `RequestFailedException` because they indicate a permanent failure. One such subclass is `OperationNotExistException`, whose occurrence signals a serious problem in the application. For instance, it might mean

that the client and server are using incompatible Slice definitions, or that the client is trying to invoke operations on the wrong object. The exception to this rule is `ObjectNotExistException`, which Ice does consider to be worthy of retry if the proxy in question is *indirect* because it gives an application the ability to transparently migrate an Ice object.

In addition to user exceptions and subclasses of `RequestFailedException`, a server can also return an instance of `UnknownException`, `UnknownLocalException`, or `UnknownUserException` to indicate that it encountered an unexpected exception while dispatching the request. These exceptions *are* eligible for retry.

2. When did the error occur?

If the error is still a candidate for retry, Ice needs to know whether the server has received the request. Naturally, the Ice run time in the client cannot possibly know that information until the server confirms it by sending a reply. However, to be conservative Ice assumes that the server has received the request as soon as Ice has written the *entire* protocol message to the client's local transport buffers. If the error occurred before Ice managed to write the complete message, retrying the request would not violate at-most-once semantics.

The Ice run time in the server also has the ability to notify the client that a request was not dispatched and therefore that it is safe for the Ice run time in the client to retry the request without violating at-most-once semantics. For example, this situation can occur when the server is shutting down while there are pending requests that have yet to be executed. Sending this notification allows a client to transparently fail over to another server.

3. Does the application require strict adherence to at-most-once semantics for this request?

An application can grant permission for Ice to violate at-most-once semantics for certain Slice operations by marking them as *idempotent*, causing Ice to retry a request that otherwise would be ineligible because the server has already received it. We discuss idempotent operations in more detail [below](#).

If Ice determines that an invocation cannot be retried, it raises the exception that caused the request failure to the application. On the other hand, if Ice does retry the invocation and the subsequent retries also fail, Ice raises the *last* exception to the application. For example, if the first attempt fails with `ConnectionRefusedException` and the retry fails with `ConnectTimeoutException`, the invocation raises `ConnectTimeoutException` to the application.

Automatic Retries for Idempotent Operations

Annotating a Slice operation with the `idempotent` keyword notifies Ice that it can safely violate at-most-once semantics:

Slice
<pre>interface Account { long withdraw(long amount); idempotent long getBalance(); };</pre>

Although `withdraw` clearly requires the stricter treatment, there is no harm in automatically retrying the `getBalance` operation even if the server executes the same request more than once.

In general, "read-only" operations are good candidates for the `idempotent` keyword whereas many mutating operations are not. However, the risk of duplicate requests is acceptable even for some kinds of mutating operations:

Slice
<pre>interface Account { long withdraw(long amount); idempotent long getBalance(); idempotent void changeAddress(string newAddress); };</pre>

Here we have marked `changeAddress` as idempotent because executing the request twice has the same effect as executing it only once.

The benefit of the `idempotent` keyword and the associated relaxation of retry semantics is that an invocation that otherwise might have raised an exception has at least one more chance to succeed. Furthermore, the application does not need to initiate the retry, and in fact the retry activities are completely transparent: if a subsequent retry succeeds, the application receives its results as if nothing went wrong. The invocation only raises an exception once Ice has reached its configured retry limits.

Configuring Automatic Retries

Retry Intervals

The `Ice.RetryIntervals` property configures the retry behavior for a communicator and affects invocations on every proxy created by that communicator. (Retry behavior cannot be configured on a per-proxy basis.) The value of this property consists of a series of integers separated by whitespace. The number of integers determines how many retry attempts Ice makes, and the value of each entry represents a delay in milliseconds. If this property is not defined, the default behavior is to retry once immediately after the first failure, which is equivalent to the following property definition:

```
Ice.RetryIntervals=0
```

You may want a more elaborate configuration for your application, such as a gradual increase in the delay between retries:

```
Ice.RetryIntervals=0 100 500 1000
```

With this setting, Ice retries immediately as in the default case. If the first retry attempt also fails, Ice waits 100 milliseconds before trying again, then 500 milliseconds, and finally tries one more time after waiting one second.

In some situations you may need to disable retries completely. For example, an application might implement its own retry logic and therefore require immediate notification when a failure occurs. Clients that establish a session with a [Glacier2 router](#) also need to disable retries. To prevent automatic retries, use a value of `-1`:

```
Ice.RetryIntervals=-1
```

Retry Logging

To monitor Ice's retry activities, configure your program with the property `Ice.Trace.Retry` set to a non-zero value:

```
Ice.Trace.Retry=1
```

When retry tracing is enabled, Ice logs a message each time it attempts a retry; the log message includes a description of the exception that prompted the retry. Ice also logs a message when it reaches the retry limit.

You can configure Ice to log even more information about retries by setting the property to `2`:

```
Ice.Trace.Retry=2
```

This setting prompts Ice to include additional details about connections and endpoints.

Timeouts and Automatic Retries

If a proxy invocation fails due to a [timeout](#), the application must be prepared for Ice to raise a `TimeoutException`. However, a developer that is testing timeouts in an application may be initially confused to discover that it is taking twice as long as expected for Ice to raise the `TimeoutException`. Automatic retries are usually the reason for this situation.

For example, suppose that a proxy is configured with a one-second timeout and automatic retries are enabled with the default setting. If an invocation on that proxy fails due to a timeout and Ice determines that the invocation is eligible for retry (using the criteria described [above](#)), Ice immediately tries the invocation again and waits for another timeout period to expire before finally raising `TimeoutException`. From the application's perspective, the invocation fails after approximately two seconds.

Consequently, you can compute an approximate worst-case timeout value as follows:

$$T = t * (N + 1) + D$$

where t is the timeout value, N is the number of retry intervals, and D is the sum of the retry intervals (the total delay between retries). Consider our example again:

```
Ice.RetryIntervals=0 100 500 1000
```

Using this configuration with a one-second timeout, our approximate worst-case timeout is $1 * 5 + 1.6 = 6.6$ seconds.

Connections and Automatic Retries

The behavior of automatic retries is intimately tied to the presence (and absence) of connections. This section describes the errors that cause Ice to close connections, and provides more details about how connections influence retries.

Connection Errors

Ice automatically closes a connection in response to certain fatal error conditions. Of these, the one that is the most likely to affect Ice applications is a [timeout](#). Other errors that prompt Ice to close a connection include the following:

- a socket failure while performing I/O on the connection
- receiving an improperly formatted message
- dispatching an operation to a Java servant raises `OutOfMemoryError` Or `AssertionError`

When Ice closes a connection in response to one of these errors, all other outstanding requests on the same connection also fail and may be retried if eligible.

Connection Status

One factor that influences retry behavior is the status of the connection on which the failed request was attempted. If the failure caused Ice to close the connection (as discussed in the previous section), or if the request failed because Ice could not [establish a connection](#), Ice must try to obtain another connection before it can retry the request.

It is also important to understand that Ice may not retry the invocation on the original endpoint *even if the connection that was used for the initial request remains open*. The retry behavior in this case depends on several criteria:

- whether the proxy [caches its connection](#)
- whether the proxy contains [multiple endpoints](#)
- whether other connections exist to any of the proxy's endpoints
- the proxy's configured [endpoint selection type](#)

Generally speaking, you must configure your application carefully if you need fine-grained control over Ice's retry behavior.

See Also

- Terminology
- Operations
- Connection Timeouts
- Connection Establishment
- Getting Started with Glacier2

Dispatch Interceptors

A dispatch interceptor is a server-side mechanism that allows you to intercept incoming client requests before they are given to a servant. The interceptor can examine the incoming request; in particular, it can see whether the request dispatch is collocation-optimized and examine the `Current` information for the request.

A dispatch interceptor can dispatch a request to a servant and check whether the dispatch was successful; if not, the interceptor can choose to retry the dispatch. This functionality is useful to automatically retry requests that have failed due to a recoverable error condition, such as a database deadlock exception. (Freeze uses dispatch interceptors for this purpose in its `evictor` implementations.)

On this page:

- [Dispatch Interceptor API](#)
 - [Objective-C Mapping for Dispatch Interceptors](#)
- [Using a Dispatch Interceptor](#)

Dispatch Interceptor API

Dispatch interceptors are not defined in Slice, but are provided as an API that is specific to each programming language. The remainder of this section presents the interceptor API for C++; for Java and .NET, the API is analogous, so we do not show it here.

In C++, a dispatch interceptor has the following interface:

```

C++

namespace Ice {
    class DispatchInterceptor : public virtual Object {
    public:
        virtual DispatchStatus dispatch(Request&) = 0;
    };

    typedef IceInternal::Handle<DispatchInterceptor>
    DispatchInterceptorPtr;
}

```

Note that a `DispatchInterceptor` *is-a* `Object`, that is, you use a dispatch interceptor as a servant.

To create a dispatch interceptor, you must derive a class from `DispatchInterceptor` and provide an implementation of the pure virtual `dispatch` function. The job of `dispatch` is to pass the request to the servant and to return a dispatch status, defined as follows:

```

C++

namespace Ice {
    enum DispatchStatus {
        DispatchOK, DispatchUserException, DispatchAsync
    };
}

```

The enumerators indicate how the request was dispatched:

- `DispatchOK`
The request was dispatched synchronously and completed without an exception.
- `DispatchUserException`

The request was dispatched synchronously and raised a user exception.

- `DispatchAsync`

The request was dispatched successfully as an asynchronous request; the result of the request is not available to the interceptor because the result is delivered to the AMD callback when the request completes.

The Ice run time provides basic information about the request to the `dispatch` function in the form of a `Request` object:

```

C++

namespace Ice {
    class Request {
    public:
        virtual bool isCollocated();
        virtual const Current& getCurrent();
    };
}
```

- `isCollocated` returns true if the dispatch is directly into the target servant as a [collocation-optimized dispatch](#). If the dispatch is not collocation-optimized, the function returns false.
- `getCurrent` provides access to the `Current` object for the request, which provides access to information about the request, such as the object identity of the target object, the object adapter used to dispatch the request, and the operation name.

Note that `Request`, for performance reasons, is *not* thread-safe. This means that you must not concurrently dispatch from different threads using the same `Request` object. (Concurrent dispatch for different requests does not cause any problems.)

To use a dispatch interceptor, you instantiate your derived class and register it as a servant with the Ice run time in the usual way, such as by adding the interceptor to the [Active Servant Map \(ASM\)](#), or returning the interceptor as a servant from a call to `locate` on a [servant locator](#).

Objective-C Mapping for Dispatch Interceptors

The Objective-C mapping in Ice Touch does not support AMD, therefore the return type of the `dispatch` method is simplified to a boolean:

```

Objective-C

@protocol ICEDispatchInterceptor <ICEObject>
-(BOOL) dispatch:(id<ICERequest>)request;
@end
```

A return value of `YES` is equivalent to `DispatchOK` and indicates that the request completed without an exception. A return value of `NO` is equivalent to `DispatchUserException`.

Similarly, the `ICERequest` protocol omits the `isCollocated` method because collocation optimization is not supported.

Using a Dispatch Interceptor

Your implementation of the `dispatch` function must dispatch the request to the actual servant. Here is a very simple example implementation of an interceptor that dispatches the request to the servant passed to the interceptor's constructor:

C++

```
class InterceptorI : public Ice::DispatchInterceptor {
public:
    InterceptorI(const Ice::ObjectPtr& servant)
        : _servant(servant) {}

    virtual Ice::DispatchStatus dispatch(Ice::Request& request) {
        return _servant->ice_dispatch(request);
    }

    Ice::ObjectPtr _servant;
};
```

Note that our implementation of `dispatch` calls `ice_dispatch` on the target servant to dispatch the request. `ice_dispatch` does the work of actually (synchronously) invoking the operation.

Also note that `dispatch` returns whatever is returned by `ice_dispatch`. For synchronous dispatch, you should always implement your interceptor in this way and not change this return value.

We can use this interceptor to intercept requests to a servant of any type as follows:

C++

```
ExampleIPtr servant = new ExampleI;
Ice::DispatchInterceptorPtr interceptor = new InterceptorI(servant);
adapter->add(interceptor,
communicator->stringToIdentity("ExampleServant"));
```

Note that, because dispatch interceptor *is-a* servant, this means that the servant to which the interceptor dispatches need not be the actual servant. Instead, it could be another dispatch interceptor that ends up dispatching to the real servant. In other words, you can chain dispatch interceptors; each interceptor's `dispatch` function is called until, eventually, the last interceptor in the chain dispatches to the actual servant.

A more interesting use of a dispatch interceptor is to retry a call if it fails due to a recoverable error condition. Here is an example that retries a request if it raises a local exception defined in Slice as follows:

Slice

```
local exception DeadlockException { /* ... */};
```

Note that this is a `local` exception. Local exceptions that are thrown by the servant propagate to `dispatch` and can be caught there. A database might throw such an exception if the database detects a locking conflict during an update. We can retry the request in response to this exception using the following `dispatch` implementation:

C++

```

virtual Ice::DispatchStatus dispatch(Ice::Request& request) {
    while (true) {
        try {
            return _servant->ice_dispatch(request);
        } catch (const DeadlockException&) {
            // Happens occasionally
        }
    }
}

```

Of course, a more robust implementation might limit the number of retries and possibly add a delay before retrying.

You can also retry an asynchronous dispatch. In this case, each asynchronous dispatch attempt creates a new AMD callback object.

- If the response for the retried request has been sent already, the interceptor receives a `ResponseSentException`. Your interceptor must either not handle this exception (or rethrow it) or return `DispatchAsync`.
- If the response for the request has not been sent yet, the Ice run time ignores any call to `ice_response` or `ice_exception` on the old AMD callback.

If an operation throws a user exception (as opposed to a local exception), the user exception cannot be caught by `dispatch` as an exception but, instead, is reported by the return value of `ice_dispatch`: a return value of `DispatchUserException` indicates that the operation raised a user exception. You can retry a request in response to a user exception as follows:

C++

```

virtual Ice::DispatchStatus dispatch(Ice::Request& request) {
    Ice::DispatchStatus d;
    do {
        d = _servant->ice_dispatch(request);
    } while (d == Ice::DispatchUserException);
    return d;
}

```

This is fine as far as it goes, but not particularly useful because the preceding code retries if *any* kind of user exception is thrown. However, typically, we want to retry a request only if a *specific* user exception is thrown. The problem here is that the `dispatch` function does not have direct access to the actual exception that was thrown — all it knows is that *some* user exception was thrown, but not which one.

To retry a request for a specific user exception, you need to implement your servants such that they leave some "footprint" behind if they throw the exception of interest. This allows your request interceptor to test whether the user exception should trigger a retry. There are various techniques you can use to achieve this. For example, you can use thread-specific storage to test a retry flag that is set by the servant if it throws the exception or, if you use transactions, you can attach the retry flag to the transaction context. However, doing so is more complex; the intended use case is to permit retry of requests in response to local exceptions, so we suggest you retry requests only for local exceptions.

The most common use case for a dispatch interceptor is as a [default servant](#). Rather than having an explicit interceptor for individual servants, you can register a dispatch interceptor as default servant. You can then choose the "real" servant to which to dispatch the request inside `dispatch`, prior to calling `ice_dispatch`. This allows you to intercept and selectively retry requests based on their outcome, which cannot be done using a servant locator.

See Also

- [The Current Object](#)
- [Location Transparency](#)
- [The Active Servant Map](#)
- [Servant Locators](#)
- [Freeze Evictors](#)
- [Default Servants](#)

C++ Strings and Character Encoding

On the wire, Ice [transmits](#) all strings as Unicode strings in UTF-8 encoding. For languages other than C++, Ice uses strings in their language-native Unicode representation and converts automatically to and from UTF-8 for transmission, so applications can transparently use characters from non-English alphabets.

However, for C++, how strings are represented inside a process depends on the platform as well as the mapping that is chosen for a particular string: the default mapping to `std::string`, or the [alternative mapping](#) to `std::wstring`.



This discussion is only relevant for C++. For scripting language mappings based on Ice for C++, it is possible to use [Ice's default string converter plug-in](#) and to [install your own string converter plug-in](#).

We will explore how strings are encoded by the Ice for C++ run time, and how you can achieve automatic conversion of strings in their native representation to and from UTF-8. For an example of using string converters in C++, refer to the sample program provided in the `demo/Ice/converter` subdirectory of your Ice distribution.

By default, the Ice run time encodes strings as follows:

- Narrow strings (that is, strings mapped to `std::string`) are presented to the application in UTF-8 encoding and, similarly, the application is expected to provide narrow strings in UTF-8 encoding to the Ice run time for transmission.

With this default behavior, the application code is responsible for converting between the native codeset for 8-bit characters and UTF-8. For example, if the native codeset is ISO Latin-1, the application is responsible for converting between UTF-8 and narrow (8-bit) characters in ISO Latin-1 encoding.

Also note that the default behavior does not require the application to do anything if it only uses characters in the ASCII range. (This is because a string containing only characters in the (7-bit) ASCII range is also a valid UTF-8 string.)

- Wide strings (that is, strings mapped to `std::wstring`) are automatically encoded as Unicode by the Ice run time as appropriate for the platform. For example, for Windows, the Ice run time converts between UTF-8 and UTF-16 in little-endian representation whereas, for Linux, the Ice run time converts between UTF-8 and UTF-32 in the endian-ness appropriate for the host CPU.

With this default behavior, wide strings are transparently converted between their on-the-wire representation and their native C++ representation as appropriate, so application code need not do anything special. (The exception is if an application uses a non-Unicode encoding, such as Shift-JIS, as its native `wstring` codeset.)

Topics

- [Installing String Converters](#)
- [UTF-8 Conversion](#)
- [String Parameters in Local Calls](#)
- [Built-in String Converters](#)
- [String Conversion Convenience Functions](#)
- [The iconv String Converter](#)
- [The Ice String Converter Plug-in](#)
- [Custom String Converter Plug-ins](#)

See Also

- [The Ice Protocol](#)
- [C++ Mapping for Built-In Types](#)

Installing String Converters

The default behavior of the run time can be changed by providing application-specific string converters. If you install such converters, all Slice strings will be passed to the appropriate converter when they are marshaled and unmarshaled. Therefore, the string converters allow you to convert all strings transparently into their native representation without having to insert explicit conversion calls whenever a string crosses a Slice interface boundary.

You can install string converters on a per-communicator basis when you [create a communicator](#) by setting the `stringConverter` and `wstringConverter` members of the `InitializationData` structure. Any strings that use the default (`std::string`) mapping are passed through the specified `stringConverter`, and any strings that use the wide (`std::wstring`) mapping are passed through the specified `wstringConverter`.

The string converters are defined as follows:

```

C++

namespace Ice {

class UTF8Buffer {
public:
    virtual Byte* getMoreBytes(size_t howMany, Byte* firstUnused) = 0;
    virtual ~UTF8Buffer() {}
};

template<typename charT>
class BasicStringConverter : public IceUtil::Shared {
public:
    virtual Byte*
    toUTF8(const charT* sourceStart, const charT* sourceEnd,
          UTF8Buffer& const = 0;

    virtual void fromUTF8(const Byte* sourceStart,
                          const Byte* sourceEnd,
                          std::basic_string<charT>& target) const;
};

typedef BasicStringConverter<char> StringConverter;
typedef IceUtil::Handle<StringConverter> StringConverterPtr;

typedef BasicStringConverter<wchar_t> WstringConverter;
typedef IceUtil::Handle<WstringConverter> WstringConverterPtr;

}

```

As you can see, both narrow and wide string converters are simply templates with either a narrow or a wide character (`char` or `wchar_t`) as the template parameter.

See Also

- [Communicator Initialization](#)
- [C++ Mapping for Built-In Types](#)

UTF-8 Conversion

On this page:

- [Converting to UTF-8](#)
- [Converting from UTF-8](#)

Converting to UTF-8

If you have [installed a string converter](#), the Ice run time calls the converter's `toUTF8` function whenever it needs to convert a native string into UTF-8 representation for transmission. The `sourceStart` and `sourceEnd` pointers point at the first byte and one-beyond-the-last byte of the source string, respectively. The implementation of `toUTF8` must return a pointer to the first unused byte following the converted string.

Your implementation of `toUTF8` must allocate the returned string by calling the `getMoreBytes` member function of the `UTF8Buffer` class that is passed as the third argument. (`getMoreBytes` throws a `std::bad_alloc` if it cannot allocate enough memory.) The `firstUnused` parameter must point at the first unused byte of the allocated memory region. You can make several calls to `getMoreBytes` to incrementally allocate memory for the converted string. If you do, `getMoreBytes` may relocate the buffer in memory. (If it does, it copies the part of the string that was converted so far into the new memory region.) The function returns a pointer to the first unused byte of the (possibly relocated) memory.

Conversion with `toUTF8` during marshaling can fail because `getMoreBytes` can cause the message size to exceed `Ice.MessageSizeMax`. In this case, you should let the `MemoryLimitException` thrown by `getMoreBytes` propagate to the caller.

Conversion can also fail because the encoding of the source string is internally incorrect. In that case, you should throw a `StringConversionFailed` exception from `toUTF8`.

After it has marshaled the returned string into an internal marshaling buffer, the Ice run time deallocates the string.

Converting from UTF-8

During unmarshaling, the Ice run time calls the `fromUTF8` member function on the corresponding string converter. The function converts a UTF-8 string into its native form as a `std::string`. (The string into which the function must place the converted characters is passed to `fromUTF8` as the `target` parameter.)

See Also

- [Installing String Converters](#)

String Parameters in Local Calls

In C++, and indirectly in Python, Ruby, and PHP, all Ice local APIs are narrow-string based, meaning you could not for example recompile `Properties.ice` to get property names and values as wide strings.

Installing a narrow-string converter could cause trouble for these local calls if UTF-8 conversion occurs in the underlying implementation. For example, the `stringToIdentity` operation creates an intermediary UTF-8 string. If this string contains characters that are not in your native codeset (as determined by the narrow-string converter), the `stringToIdentity` call will fail.

Likewise, when Ice reads `properties` from a configuration file, it converts the input (UTF-8 characters) into native strings. This conversion can also fail if the native encoding cannot convert some characters.

Most strings in local calls are never problematic because Ice does not perform any conversion, for example:

- adapter names in `createObjectAdapter`
- property names and values in `Properties`
- `ObjectAdapter::createProxy`, where the identity conversion occurs only when the proxy is marshaled

Finally, consider the Slice type `Ice::Context`, which is mapped in C++ as a `map<string, string>`. The mapping for `Context` cannot be changed to `map<wstring, wstring>`, therefore you cannot send or receive any context entry that is not in your narrow-string native encoding when a narrow-string converter is installed.

See Also

- [Object Identity](#)
- [Properties and Configuration](#)
- [Request Contexts](#)

Built-in String Converters

Ice provides three string converters to cover common conversion requirements:

- `UnicodeWstringConverter`
This is a string converter that converts between Unicode wide strings and UTF-8 strings. Unless you install a different string converter, this is the default converter that is used for wide strings.
- `IconvStringConverter` (Linux and Unix only)
The [iconv string converter](#) converts strings using the Linux and Unix `iconv` conversion facility. It can be used to convert either wide or narrow strings.
- `WindowsStringConverter` (Windows only)
This string converter converts between multi-byte and UTF-8 strings and uses `MultiByteToWideChar` and `WideCharToMultiByte` for its implementation.

These string converters are defined in the `Ice` namespace.

See Also

- [The iconv String Converter](#)

String Conversion Convenience Functions

The `Ice` namespace provides four convenience functions that make it easy to [convert strings](#) to and from UTF-8:

```

C++



```
namespace Ice {

 std::string
 nativeToUTF8(const Ice::StringConverterPtr&, const std::string&);

 std::string
 nativeToUTF8(const Ice::CommunicatorPtr&, const std::string&);

 std::string
 UTF8ToNative(const Ice::StringConverterPtr&, const std::string&);

 std::string
 UTF8ToNative(const Ice::CommunicatorPtr&, const std::string&);

}
```

```

The overloads allow you to either use the string converter that is configured on a communicator or to explicitly pass a specific string converter that performs the conversion.

See Also

- [UTF-8 Conversion](#)

The iconv String Converter

For Linux and Unix platforms, Ice provides an `IconvStringConverter` template class that uses the `iconv` conversion facility to convert between the native encoding and UTF-8. The only member function of interest is the constructor:

```

C++
template<typename charT>
class IconvStringConverter : public Ice::BasicStringConverter<charT>
{
public:
    IconvStringConverter(const char* = nl_langinfo(CODESET));

    // ...
};
```

To use this string converter, you specify whether the conversion you want is for narrow or wide characters via the template argument, and you specify the corresponding native encoding with the constructor argument. For example, to create a converter that converts between ISO Latin-1 and UTF-8, you can instantiate the converter as follows:

```

C++
InitializationData id;
id.stringConverter = new IconvStringConverter<char>("ISO-8859-1");
```

Similarly, to convert between the internal wide character encoding and UTF-8, you can instantiate a converter as follows:

```

C++
InititializationData id;
id.stringConverter = new IconvStringConverter<wchar_t>("WCHAR_T");
```

The string you pass to the constructor must be one of the values returned by `iconv -l`, which lists all the available character encodings for your machine.

Using the `IconvStringConverter` template makes it easy to install code converters for any available encoding without having to explicitly write (or call) conversion routines, whose implementation is typically non-trivial.

See Also

- [Installing String Converters](#)

The Ice String Converter Plug-in

The Ice run time includes a plug-in that supports [conversion](#) between UTF-8 and native encodings on Unix and Windows platforms. You can use this plug-in to install converters for narrow and wide strings into the communicator of an existing program. This feature is primarily intended for use in scripting language extensions such as Ice for Python; if you need to use string converters in your C++ application, we recommend using the technique described in [Installing String Converters](#) instead.

Note that an application must be designed to operate correctly in the presence of a string converter. A string converter assumes that it converts strings in the native encoding into the UTF-8 encoding, and vice versa. An application that performs its own conversions on strings that cross a Slice interface boundary can cause encoding errors when those strings are processed by a converter.

Configuring the Ice String Converter Plug-in

You can install the plug-in using a [configuration property](#) like the one shown below:

```
Ice.Plugin.Converter=Ice:createStringConverter iconv=encoding[,encoding]
windows=code-page
```

You can use any name you wish for the plug-in; in this example, we used `Converter`. The first component of the property value represents the plug-in's [entry point](#), which includes the abbreviated name of the shared library or DLL (`Ice`) and the name of a factory function (`createStringConverter`).

The plug-in accepts the following arguments:

- `iconv=encoding[,encoding]`
This argument is optional on Unix platforms and ignored on Windows platforms. If specified, it defines the `iconv` names of the narrow string encoding and the optional wide-string encoding. If this argument is not specified, the plug-in installs a narrow string converter that uses the default locale-dependent encoding.
- `windows=code-page`
This argument is required on Windows platforms and ignored on Unix platforms. The `code-page` value represents a code page number, such as 1252.

The plug-in's argument semantics are designed so that the same configuration property can be used on both Windows and Unix platforms, as shown in the following example:

```
Ice.Plugin.Converter=Ice:createStringConverter
iconv=ISO8859-1 windows=1252
```

If the configuration file containing this property is shared by programs in multiple implementation languages, you can use an alternate syntax that is loaded only by the Ice for C++ run time:

```
Ice.Plugin.Converter.cpp=Ice:createStringConverter iconv=ISO8859-1
windows=1252
```

See Also

- [UTF-8 Conversion](#)
- [Installing String Converters](#)
- [Plug-in Configuration](#)
- [Ice Plug-In Properties](#)

Custom String Converter Plug-ins

If the [default string converter plug-in](#) does not satisfy your requirements, you can implement your own solution with help from the `StringConverterPlugin` class:

```

C++

namespace Ice {
class StringConverterPlugin : public Ice::Plugin {
public:

    StringConverterPlugin(const CommunicatorPtr& communicator,
                          const StringConverterPtr&,
                          const WstringConverterPtr& = 0);

    virtual void initialize();

    virtual void destroy();
};
}
```

The converters are installed by the `StringConverterPlugin` constructor (you can supply an argument of 0 for either converter if you do not wish to install it). The `initialize` and `destroy` methods are empty, but you can subclass `StringConverterPlugin` and override these methods if necessary.

In order to create a string converter plug-in, you must do the following:

- Define and export a [factory function](#) that returns an instance of `StringConverterPlugin`.
- Implement the converter(s) that you will pass to the `StringConverterPlugin` constructor, or use the ones [included with Ice](#).
- Package your code into a shared library or DLL.

To install your plug-in, use a [configuration property](#) like the one shown below:

```
Ice.Plugin.MyConverterPlugin=myconverter:createConverter ...
```

The first component of the property value represents the plug-in's [entry point](#), which includes the abbreviated name of the shared library or DLL (`myconverter`) and the name of a factory function (`createConverter`).

If the configuration file containing this property is shared by programs in multiple implementation languages, you can use an alternate syntax that is loaded only by the Ice for C++ run time:

```
Ice.Plugin.MyConverterPlugin.cpp=myconverter:createConverter ...
```

See Also

- [The Ice String Converter Plug-in](#)
- [Plug-in API](#)
- [Ice Plug-In Properties](#)

Plug-in Facility

Ice supports a plug-in facility that allows you to add new features and install application-specific customizations. Plug-ins are defined using configuration properties and loaded dynamically by the Ice run time, making it possible to install a plug-in into an existing program without modification.

Ice uses the plug-in facility to implement some of its own features. Most well-known is [IceSSL](#), a plug-in that adds a secure transport for Ice communication. Other examples include the [logger plug-in](#) and the [string converter plug-in](#).

This section describes the plug-in facility in more detail and demonstrates how to implement an Ice plug-in.

Topics

- [Plug-in API](#)
- [Plug-in Configuration](#)
- [Advanced Plug-in Topics](#)

See Also

- [IceSSL](#)
- [Logger Plug-ins](#)
- [The Ice String Converter Plug-in](#)

Plug-in API

On this page:

- [The Plugin Interface](#)
- [C++ Plug-in Factory](#)
- [Java Plug-in Factory](#)
- [C# Plug-in Factory](#)

The Plugin Interface

The plug-in facility defines a local Slice interface that all plug-ins must implement:

Slice
<pre> module Ice { local interface Plugin { void initialize(); void destroy(); }; }; </pre>

The lifecycle of an Ice plug-in is structured to accommodate dependencies between plug-ins, such as when a logger plug-in needs to use IceSSL for its logging activities. Consequently, a plug-in object's lifecycle consists of four phases:

- **Construction**
The Ice run time uses a language-specific factory API for instantiating plug-ins. During construction, a plug-in can acquire resources but must not spawn new threads or perform activities that depend on other plug-ins.
- **Initialization**
After all plug-ins have been constructed, the Ice run time invokes `initialize` on each plug-in. The order in which plug-ins are initialized is undefined by default but can be [customized](#) using a configuration property. If a plug-in has a dependency on another plug-in, you must configure the Ice run time so that initialization occurs in the proper order. In this phase it is safe for a plug-in to spawn new threads; it is also safe for a plug-in to interact with other plug-ins and use their services, as long as those plug-ins have already been initialized. If `initialize` raises an exception, the Ice run time invokes `destroy` on all plug-ins that were successfully initialized (in the reverse order of initialization) and raises the original exception to the application.
- **Active**
The active phase spans the time between initialization and destruction. Plug-ins must be designed to operate safely in the context of multiple threads.
- **Destruction**
The Ice run time invokes `destroy` on each plug-in in the reverse order of initialization.

This lifecycle is repeated for each new communicator that an application creates and destroys.

C++ Plug-in Factory

In C++, the plug-in factory is an exported function with C linkage having the following signature:

C++

```
extern "C"
{
ICE_DECLSPEC_EXPORT Ice::Plugin*
functionName(const Ice::CommunicatorPtr& communicator,
             const std::string& name,
             const Ice::StringSeq& args);
}
```

You can define the function with any name you wish. We recommend that you use the `ICE_DECLSPEC_EXPORT` macro to ensure that the function is exported correctly on all platforms. Since the function uses C linkage, it must return the plug-in object as a regular C++ pointer and not as an Ice smart pointer. Furthermore, the function must not raise C++ exceptions; if an error occurs, the function must return zero.

The arguments to the function consist of the communicator that is in the process of being initialized, the name assigned to the plug-in, and any arguments that were specified in the [plug-in's configuration](#).

Java Plug-in Factory

In Java, a plug-in factory must implement the `Ice.PluginFactory` interface:

Java

```
package Ice;

public interface PluginFactory {
    Plugin create(Communicator communicator, String name,
String[] args);
}
```

The arguments to the `create` method consist of the communicator that is in the process of being initialized, the name assigned to the plug-in, and any arguments that were specified in the [plug-in's configuration](#).

The `create` method can return `null` to indicate that a general error occurred, or it can raise `PluginInitializationException` to provide more detailed information. If any other exception is raised, the Ice run time wraps it inside an instance of `PluginInitializationException`.

C# Plug-in Factory

In .NET, a plug-in factory must implement the `Ice.PluginFactory` interface:

C#

```
namespace Ice {
    public interface PluginFactory
    {
        Plugin create(Communicator communicator, string name,
            string[] args);
    }
}
```

The arguments to the `create` method consist of the communicator that is in the process of being initialized, the name assigned to the plug-in, and any arguments that were specified in the [plug-in's configuration](#).

The `create` method can return `null` to indicate that a general error occurred, or it can raise `PluginInitializationException` to provide more detailed information. If any other exception is raised, the Ice run time wraps it inside an instance of `PluginInitializationException`.

See Also

- [Plug-in Configuration](#)
- [Advanced Plug-in Topics](#)

Plug-in Configuration

Plug-ins are installed using a [configuration property](#) of the following form:

```
Ice.Plugin.Name=entry_point [arg ...]
```

In most cases you can assign an arbitrary name to a plug-in. In the case of [IceSSL](#), however, the plug-in requires that its name be `IceSSL`.

The value of `entry_point` is a language-specific representation of the plug-in's factory. In C++, it consists of the path name of the shared library or DLL containing the factory function, along with the name of the factory function. In Java and .NET, the entry point specifies the factory class.

The language-specific nature of plug-in properties can present a problem when applications that are written in multiple implementation languages attempt to share a configuration file. Ice supports an alternate syntax for plug-in properties that alleviates this issue:

```
Ice.Plugin.name.cpp=...      # C++ plug-in
Ice.Plugin.name.java=...    # Java plug-in
Ice.Plugin.name.clr=...     # .NET (Common Language Runtime) plug-in
```

Plug-in properties having a suffix of `.cpp`, `.java`, or `.clr` are loaded only by the appropriate Ice run time and ignored by others.

After extracting the plug-in's entry point from the property value, any remaining text is parsed using semantics similar to that of command-line arguments. Whitespace separates the arguments, and any arguments that contain whitespace must be enclosed in quotes:

```
Ice.Plugin.MyPlugin=entry_point --load "C:\Data Files\config.dat"
```

Ice passes these arguments to the plug-in's entry point during loading.

See Also

- [Ice Plug-In Properties](#)
- [IceSSL](#)

Advanced Plug-in Topics

This page discusses additional aspects of the Ice plug-in facility that may be of use to applications with special requirements.

On this page:

- [Plug-in Dependencies](#)
- [The Plug-in Manager](#)
- [Delayed Plug-in Initialization](#)

Plug-in Dependencies

If a plug-in has a dependency on another plug-in, you must ensure that Ice initializes the plug-ins in the proper order. Suppose that a custom logger implementation depends on `IceSSL`; for example, the logger may need to transmit log messages securely to another server. We start with the following C++ configuration:

```
Ice.Plugin.IceSSL=IceSSL:createIceSSL
Ice.Plugin.MyLogger=MyLogger:createMyLogger
```

The problem with this configuration is that it does not specify the order in which the plug-ins should be loaded and initialized. If the Ice run time happens to initialize `MyLogger` first, the plug-in's `initialize` method will fail if it attempts to use the services of the uninitialized `IceSSL` plug-in.

To remedy the situation, we need to add one more property:

```
Ice.Plugin.IceSSL=IceSSL:createIceSSL
Ice.Plugin.MyLogger=MyLogger:createMyLogger
Ice.PluginLoadOrder=IceSSL, MyLogger
```

Using the `Ice.PluginLoadOrder` property we can guarantee that the plug-ins are loaded in the correct order.



Plug-ins added manually via the [plug-in manager](#) are appended to the end of the plug-in list, in order of addition. The last plug-in added is the first to be destroyed.

The Plug-in Manager

`PluginManager` is the name of an internal Ice object that is responsible for managing all aspects of Ice plug-ins. This object supports a `local` Slice interface of the same name, and an application can obtain a reference to this object using the following communicator operation:

```

Slice
module Ice {
  local interface Communicator {
    PluginManager getPluginManager();
    // ...
  };
};
```

The `PluginManager` interface offers three operations:

Slice

```

module Ice {
  local interface PluginManager {
    void initializePlugins();
    Plugin getPlugin(string name);
    void addPlugin(string name, Plugin pi);
  };
};

```

The `initializePlugins` operation is used in special cases when an application needs to manually initialize one or more plug-ins, as discussed in the next section.

The `getPlugin` operation returns a reference to a specific plug-in. The `name` argument must match an installed plug-in, otherwise the operation raises `NotRegisteredException`. This operation is useful when a plug-in exports an interface that an application can use to query or customize its attributes or behavior.

Finally, `addPlugin` provides a way for an application to install a plug-in directly, without the use of a configuration property. This plug-in's `initialize` operation will be invoked if `initializePlugins` has not yet been called on the plug-in manager. If `initializePlugins` has already been called before a plug-in is added, Ice does not invoke `initialize` on the plug-in, but does invoke `destroy` during communicator destruction.

Delayed Plug-in Initialization

It is sometimes necessary for an application to manually configure a plug-in prior to its initialization. For example, SSL keys are often protected by a passphrase, but a developer may be understandably reluctant to specify that passphrase in a configuration file because it would be exposed in clear text. The developer would likely prefer to configure the `IceSSL` plug-in with a password callback instead; however, this must be done before the plug-in is initialized and attempts to load the SSL key. The solution is to configure the Ice run time so that it postpones the initialization of its plug-ins:

```
Ice.InitPlugins=0
```

When `Ice.InitPlugins` is set to zero, initializing plug-ins becomes the application's responsibility. The example below demonstrates how to perform this initialization:

C++

```

Ice::CommunicatorPtr ic = ...
Ice::PluginManagerPtr pm = ic->getPluginManager();
IceSSL::PluginPtr ssl = pm->getPlugin("IceSSL");
ssl->setPasswordPrompt(...);
pm->initializePlugins();

```

After obtaining the `IceSSL` plug-in and establishing the password callback, the application invokes `initializePlugins` on the plug-in manager object to commence plug-in initialization.

See Also

- [IceSSL](#)
- [Ice Plug-In Properties](#)

Custom Class Loaders

Certain features of the Ice for Java run-time necessitate dynamic class loading. Applications with special requirements can supply a custom class loader for Ice to use in the following situations:

- Unmarshaling [user exceptions](#) and instances of concrete Slice classes
- Loading Ice [plug-ins](#)
- Loading [IceSSL](#) certificate verifiers and password callbacks

If an application does not supply a class loader (or if the application-supplied class loader fails to locate a class), the Ice run time attempts to load the class using class loaders in the following order:

- current thread's class loader
- default class loader (that is, by calling `Class.forName()`)
- system class loader

Note that an application must install [object factories](#) for any abstract Slice classes it might receive, regardless of whether the application also installs a custom class loader.

To install a custom class loader, set the `classLoader` member of `Ice.InitializationData` prior to [creating a communicator](#):

Java

```
Ice.InitializationData initData = new Ice.InitializationData();
initData.classLoader = new MyClassLoader();
Ice.Communicator communicator = Ice.Util.initialize(args, initData);
```

See Also

- [Java Mapping for Exceptions](#)
- [Java Mapping for Classes](#)
- [Plug-in Facility](#)
- [IceSSL](#)
- [Communicator Initialization](#)

Understanding Objects and Exceptions

On this page:

- [Distinguishing Objects and Servants](#)
- [Design Considerations for Exceptions](#)
- [Design Considerations for Objects](#)
- [Composition using Slices](#)
- [The Factory Requirement](#)
- [Slice Formats](#)
 - [Compact Format](#)
 - [Sliced Format](#)
 - [Choosing a Format](#)
- [Optional Objects](#)
- [Preserving Slices](#)
- [Unknown Sliced Objects](#)

Distinguishing Objects and Servants

The term *Ice object* refers to a conceptual entity that is incarnated by a programming language object called a servant. An Ice object typically implements a Slice [interface](#), but could implement a Slice [class with operations](#) instead.

In addition, applications can transfer instances of Slice classes *by value*, using classes as just another type in the data model, along with other Slice types such as structures and sequences. We refer to this usage as transferring *objects by value*, to distinguish it from the formal concept of *Ice objects*.

As a refresher on Slice syntax, consider the following definitions:

```

Slice

class ClassWithOperations
{
    int cost;

    void updateCost();
};

interface Remote
{
    ClassWithOperations getByValue();
    ClassWithOperations* getByProxy();
};
```

As its name implies, the operation `getByValue` returns a `ClassWithOperations` object by value, whereas the `getByProxy` operation returns a proxy to a remote Ice object that implements `ClassWithOperations`. Although their syntax is quite similar, the semantics of these two operations are very different. Calling `getByValue`, a client receives a *local* instance of `ClassWithOperations` on which it can access the `cost` member and call the `updateCost` method. With `getByProxy`, a client can use the returned proxy to call `updateCost` as a remote invocation but cannot access the `cost` member, which is local state for the remote servant.

Design Considerations for Exceptions

Using exceptions to report error conditions is a generally accepted idiom, given its wide support in programming languages and its convenience in simplifying a developer's error-handling responsibilities. The alternatives, such as using numeric error codes, can be unwieldy in practice and lack the flexibility that a well-designed exception hierarchy provides. Slice does not impose any particular

error-handling style on developers, but if you choose to use Slice exceptions, you should understand their advantages and limitations.

Slice exception types support single inheritance, which allows you to compose hierarchies of related error conditions. Furthermore, exceptions may have any number of data members, meaning your errors can convey as little or as much detail as you like. One limitation of exceptions is that they are treated differently than other Slice data types: exceptions cannot be passed as parameters, and cannot be used as data members. The sole purpose of an exception type is to appear in the `throws` clause of an operation.

As an Ice developer, you are not expected to know the intricacies of how Ice transfers exceptions from server to client. However, it can be very useful for you to understand that [exceptions are composed of slices](#), that [multiple encoding formats](#) are available, and that [passing exceptions through intermediaries](#) may require additional effort.

Design Considerations for Objects

The motivation for using objects by value is not as simple as for exceptions. If you wish to use the exception idiom, you have no choice but to use the Slice exception model. However, an application is not forced to use objects by value. Other user-defined Slice types, such as sequences, dictionaries, and structures, may satisfy the data model requirements of many applications. Classes and structures may seem similar at first glance because they can both be used as data containers, but there are also some [significant differences](#) between them. Be sure you understand the [architectural implications of classes](#) before using them in your application. Granted, if your data model requires the use of inheritance, polymorphism, or self-referential capabilities, you really have no other choice but to use classes.

One aspect of using objects by value that must not be overlooked is overhead, both in terms of the processing effort required to encode and decode them, as well as the space consumed in messages that use them. In Ice 3.4 and earlier, objects by value were relatively expensive, likely causing many developers to use structures when classes might have been the more convenient choice. In Ice 3.5, the new [compact format](#) makes objects by value much more competitive with structures. Ice 3.5 also makes it possible to [forward objects of unknown types](#) for situations where flexibility takes precedence over compactness.

Composition using Slices

The data encoding rules for [classes](#) and [exceptions](#) rely on the concept of *slices* in which each slice corresponds to a level in the type hierarchy and contains the encoded data members defined at that level. The low-level details of the encoding rules are not relevant here, but having a basic understanding of how Ice marshals and unmarshals classes and exceptions can help you with your design decisions. Consider this example:

Slice
<pre>class A { int i; }; class B extends A { float f; }; class C extends B { string s; };</pre>

The encoded form of an instance of class C is summarized below:

Slice	Contents
C	string s
B	float f
A	int i

Notice that the instance is encoded in order from most-derived to least-derived. For the sake of simplicity, we have omitted many of the encoding details. For instance, we have not shown that the initial (most-derived) slice includes a type ID string such as "`::MyModule::C`" that identifies the object's type.



Although we used a class hierarchy in the example above, the behavior for exceptions is very similar.

Let's add the following interface to our discussion:

```

Slice
interface I
{
    B getObject();
};

```

Now suppose a client invokes `getObject`. Let's also suppose that the servant actually returns an instance of class `C`, which is perfectly legal given that `C` derives from `B`. The Ice run time in the client knows that the formal return type of the `getObject` operation is `B` and unmarshals the object as follows:

1. Extract the type ID of the initial slice ("`::MyModule::C`").
2. If this type is known to the client, instantiate the object, decode the state for each of its slices, and return the object.
3. If type `C` is *not* known to the client, which can occur when client and server are using different versions of the Slice definitions, the Ice run time discards the encoded data for slice `C` (also known as *slicing* the object), reads the type ID of the next slice, and repeats step 2.
4. If type `B` is also not known to the client then we have a problem. First, from a logical standpoint, the client *must* know type `B` because it is the statically-declared return type of the operation that the client just invoked. Second, we cannot slice this object any further because it would no longer be compatible with the formal signature of the operation; the returned object must at least be an instance of `B`, so we could not return an instance of `A`. In either case, the Ice run time would raise an exception.

Generally speaking, to unmarshal an instance of a class or exception, the Ice run time discards the slices of unknown types until it finds a type that it recognizes, exhausts all slices, or can no longer satisfy the formal type signature of the operation. This slicing feature allows the receiver, whose Slice definitions may be limited or outdated, to continue to function properly even when it does not recognize the most-derived type.

With this knowledge, we can now discuss new features introduced in Ice 3.5 that affect the run time's encoding rules for classes and exceptions. Namely, a choice of [encoding formats](#) and the ability to [preserve the slices](#) of unknown types. First, however, you should understand the need for object factories.

The Factory Requirement

For Slice classes that define data members but no operations, receiving an object by value is straightforward: the Ice run time examines the [type ID](#) encoded with the object, translates that (in a language-specific manner) into the corresponding generated class, and creates an instance of that class to represent the object. This happens without any help from the application. However, things get more complicated when a [class defines operations](#). By definition, such a class is abstract, therefore Ice cannot allocate an instance of the generated abstract class. Only the application knows which derived class implements an abstract Slice class, so Ice requires the application to supply factories for translating type IDs into their programming language equivalent objects.

 Ice does not require or support user-supplied factories for exceptions because exceptions cannot define operations.

The encoding for classes does not inform the receiver whether an object is abstract. As Ice processes each slice of an object, it first attempts to locate the corresponding generated class. If Ice cannot find the class, or finds the class but determines that it is abstract, the run time looks for a factory registered by the application for that type ID. If no factory is found to create the object, Ice may discard the slice as described above.

Here is some sample code to demonstrate the implementation and registration of a factory:

Java

```
private static class CWOFactory implements Ice.ObjectFactory
{
    public Ice.Object create(String typeId)
    {
        assert(typeId.equals(ClassWithOperations.ice_staticId()));
        return new ClassWithOperationsImpl();
    }

    public void destroy()
    {
    }
}

private static class ClassWithOperationsImpl extends ClassWithOperations
{
    public void updateCost()
    {
        // ...
    }
}

Ice.Communicator communicator = ...;
communicator.addObjectFactory(new CWOFactory(),
ClassWithOperations.ice_staticId());
```

Our factory is only intended to create instances of the `ClassWithOperations` type we defined earlier, which is the reason for the assertion. In your own application, you can partition the factory responsibilities however you wish. For example, you can define a separate factory class for each Slice class, or use a single factory class that knows how to create multiple types. Whatever you decide, you must register a factory for each abstract class that the program has the potential to receive, and the registrations must occur before any remote invocations are made that might return one of these types.

 You can also register a factory for a concrete Slice class if you wish to substitute a derived type, or simply because you want more control over the allocation of that type.

Slice Formats

Version 1.0 of the Ice encoding, which is used by all versions of Ice through 3.4, supports a single format for encoding the slices of classes and exceptions. The primary design goal for this format was the ability to support [slicing](#) at the expense of a somewhat larger encoding. The

fact that the encoding embeds the [type IDs](#) of each type in an instance's type hierarchy means the size of the encoded data is affected by the symbol names and nesting depth of the Slice definitions. Consider this example:

Slice

```

module TopLevelModule
{
    module IntermediateModule
    {
        class Account { ... };
        class SubcontractorAccount extends Account { ... };
    };
};

```

The encoding for an instance of `SubcontractorAccount` includes the following type ID strings:

- `::TopLevelModule::IntermediateModule::SubcontractorAccount`
- `::TopLevelModule::IntermediateModule::Account`
- `::Ice::Object`

The last ID serves as a terminator to indicate the last slice and reflects the fact that all object types ultimately derive from the base `Object` type.

As you can see, there is a non-trivial amount of overhead for passing objects by value. Note however that the encoding includes a lookup table for type IDs to minimize this overhead as much as possible, meaning each unique type ID is only encoded once per message. While sending a single instance of `SubcontractorAccount` might be relatively expensive, sending a collection of `SubcontractorAccount` objects amortizes this cost over a number of instances. We can contrive situations where a message contains many instances of unrelated types, in which case the encoded type IDs would have a greater impact on the size of the resulting message, but those scenarios are less common.



The slice format for classes and exceptions is nearly identical. The main difference is that, for an exception, there is no need for a type ID lookup table because there can never be more than one instance of an exception in a message.

With version 1.1 of the encoding introduced in Ice 3.5, you now have two slice formats to choose from: *compact* and *sliced*.

Compact Format

The compact format in version 1.1 of the encoding sacrifices the [slicing](#) feature of classes and exceptions to reduce the encoded size of these types. The format still encodes the type ID of the most-derived type, and continues to use a lookup table to prevent duplication of type IDs in a message, but omits the type IDs for any intermediate types. Version 1.1 of the encoding also eliminates the need to encode the type ID for the base `Object` type of class instances and, together with other optimizations, makes the encoded size of classes in the compact format much more competitive with that of structures.

Ice 3.5 uses the compact format by default. Existing applications that rely on the slicing feature may begin receiving `NoObjectFactoryException` errors after migrating to Ice 3.5, an indication that the run time does not recognize the most-derived type and cannot slice to a less-derived type because the compact format omits the necessary type information. These applications must use the [sliced format](#) instead, which behaves similarly to the format in version 1.0 of the encoding.

Using our previous example, an instance of `SubcontractorAccount` still includes the type ID string `"::TopLevelModule::IntermediateModule::SubcontractorAccount"` in the compact format, but omits the type ID strings for `Account` and `Object`. Clearly we could reduce this overhead even further by using shorter symbol names and eliminating the nested module, or we could omit the type ID string altogether by using a [compact type ID](#).

Sliced Format

The sliced format in version 1.1 of the encoding retains the [slicing](#) behavior of version 1.0: a receiver discards the slices of unknown types until it finds a type that it recognizes, exhausts all available slices, or slices so far that the result would violate the formal signature of the operation. The sliced format still encodes the type IDs of the most-derived type as well as all intermediate types. However, unlike the 1.0 encoding, Ice no longer encodes the type ID for the base `Object` type in class instances such that, along with other improvements in the 1.1 encoding, the sliced format is still more efficient than the 1.0 encoding.

Choosing a Format

Ice uses the [compact](#) format by default, so an application that needs slicing behavior must explicitly enable it as follows:

- Set the `Ice.Default.SlicedFormat` property to a non-zero value to force the Ice run time to use the sliced format by default.
- Annotate your Slice definitions with `format` metadata to selectively enable the sliced format for certain operations or interfaces.

For example, suppose an application can safely use the compact format most of the time, but still needs slicing in a few situations. In this case the application can use metadata to enable the sliced format where necessary:

Slice
<pre>interface Ledger { Account getAccount(string id); // Uses compact format ["format:sliced"] Account importAccount(string source); // Uses sliced format };</pre>

The semantics implied by these definitions state that the caller of `getAccount` assumes it will know every type that that might be returned, but the same cannot be said for `importAccount`. By enabling the sliced format here, we allow the client to "slice off" what it does not recognize, even if that means the client is left with only an instance of `Account` and not an instance of some derived type.

Now let's examine the opposite case: use the sliced format by default, and the compact format only in certain cases:

Slice
<pre>["format:sliced"] interface Ledger { ["format:compact"] Account getAccount(string id); // Uses compact format Account importAccount(string source); // Uses sliced format };</pre>

Here we specify that all operations in `Ledger` use the sliced format unless overridden at the operation level, which we do for `getAccount`.

Keep the following points in mind when using the `format` metadata:

- The chosen format only controls how Ice encodes a value and has no effect on the decoding process.
- The format affects the input parameters, output parameters, and exceptions of an operation. Consider this example:

Slice

```
exception IncompatibleAccount { ... };

interface Ledger
{
    ["format:compact"]
    Account migrateAccount(Account oldAccount) throws
    IncompatibleAccount;
};
```

The metadata forces the client to use the compact format when marshaling the input parameter `oldAccount`, and forces the server to use the compact format when marshaling the return value or the exception. For a given operation, it is not possible to use one format for the parameters and a different format for the exceptions.

- If you decide to use the `Ice.Default.SlicedFormat` property, be aware that this property only affects the sender of a class or exception. For example, if you enable this property in the client but not the server, then all objects sent by the client use the sliced format by default, but all objects and exceptions returned by the server use the compact format by default.

By offering two alternative formats, Ice gives you a great deal of flexibility in designing your applications. The compact format is ideal for applications that place a greater emphasis on efficiency, while the sliced format is helpful when clients and servers evolve independently.

Optional Objects

Declaring a data member of type `class` to be optional does not eliminate the Ice run time's requirement for type information. Suppose a client uses the following Slice definitions:

Slice

```
class UserInfo
{
    string name;
    optional(1) string organization;
};
```

Also suppose that the server is using a newer version of the definitions:

Slice

```
class GroupInfo
{
    ...;
};

class UserInfo
{
    string name;
    optional(1) string organization;
    optional(2) GroupInfo group;
};
```

When receiving an instance of `UserInfo`, the Ice run time in the client ignores the `group` member because it does not recognize its tag, but Ice must still be able to unmarshal (or skip) the `GroupInfo` instance data in the message. If the server used the compact format for its reply, the client will receive an exception while attempting to decode the message. On the other hand, this scenario would succeed when using the sliced format because the format embeds enough information for the receiver to skip instances of unknown types.

The lesson here is that adding a new class type to your application can have unexpected repercussions, especially when using the compact format. Remember that the *sender* can change formats without necessarily needing to update the receiver. For example, after adding the `group` member to `UserInfo`, the server could begin using the sliced format for all operations that return `UserInfo` to ensure that any existing clients would be able to ignore this member.

Preserving Slices

The concept of [slicing](#) involves discarding the slices of unknown types when decoding an instance of a Slice class or exception. Here is a simple example:

Slice

```

class Base
{
    int b;
};

class Intermediate extends Base
{
    int i;
};

class Derived extends Intermediate
{
    int d;
};

interface Relay
{
    Base transform(Base b);
};

```

The server implementing the `Relay` object must know the type `Base` (because it is statically referenced in the interface definition), but may not know `Intermediate` or `Derived`. Suppose the implementation of `transform` involves forwarding the object to another back-end server for processing and returning the transformed object to the caller. In effect, the `Relay` server is an intermediary. If the `Relay` server does not know the types `Intermediate` and `Derived`, it will slice an instance to `Base` and discard the data members of any more-derived types, which is clearly not the intended result because the back-end server *does* know those types. The only way the `Relay` server could successfully forward these objects is by knowing all possible derived types, which makes the application more difficult to evolve over time because the intermediary must be updated each time a new derived type is added.

To address this limitation, Ice supports a new metadata directive that allows an instance of a Slice class or exception to be forwarded with all of its slices intact, even if the intermediary does not know one or more of the instance's derived types. The new directive, `preserve-slice`, is shown below:

Slice

```

["preserve-slice"]
class Base
{
    int b;
};

class Intermediate extends Base
{
    int i;
};

class Derived extends Intermediate
{
    int d;
};

["format:sliced"]
interface Relay
{
    Base transform(Base b);
};

```

With this change, all instances of `Base`, and types derived from `Base`, are encoded in a format that allows them to be forwarded intact. Also notice the addition of the `format:sliced` metadata on the `Relay` interface, which ensures that its operations use the sliced format and not the default compact format.

Unknown Sliced Objects

The combination of preserved slices and the sliced format means Ice applications now have a subtle new capability that was not available prior to Ice 3.5. Suppose we modify our `Relay` example as shown below:

Slice

```

["preserve-slice"]
class Base
{
    int b;
};

class Intermediate extends Base
{
    int i;
};

class Derived extends Intermediate
{
    int d;
};

["format:sliced"]
interface Relay
{
    Object transform(Object b);
};

```

The only difference here is the signature of the `transform` operation, which now uses the `Object` type. Technically, it is not necessary for the intermediary server to know *any* of the class types that might be relayed via this new definition of `transform` because the formal types in its signature do not impose any requirements. As long as any object types known by the intermediary are marked with `preserve-slice`, and the `transform` operation uses the sliced format, this intermediary is capable of relaying objects of any type.

If the Ice run time in the intermediary does not know any of the types in an object's inheritance hierarchy, and the formal type is `Object`, Ice uses an instance of `UnknownSlicedObject` to represent the object:

C++

```

namespace Ice {
class UnknownSlicedObject : public Object, ... {
public:

    const std::string& getUnknownTypeId() const;
    SlicedDataPtr getSlicedData() const;

    ...
};
}

```

The implementation of `transform` receives an instance of `UnknownSlicedObject` and can use that object as its return value. If necessary, the implementation can determine the most-derived type of the object by calling `getUnknownTypeId`. The actual encoded state of the object is encapsulated by the `SlicedData` class:

Slice

```

namespace Ice {
struct SliceInfo : public IceUtil::Shared {
    std::string typeId;
    std::vector<Byte> bytes;
    std::vector<ObjectPtr> objects;
    bool hasOptionalMembers;
    bool isLastSlice;
};

class SlicedData : public ... {
public:
    SlicedData(const SliceInfoSeq&);
    const SliceInfoSeq slices;

    ...
};
}

```

Applications do not normally need to use these types, but they provide all of the information the run time requires to forward an instance.

The definition of `UnknownSlicedObject`, `SlicedData` and `SliceInfo` are very similar in the other language mappings and are not shown here.

See Also

- [Terminology](#)
- [Architectural Implications of Classes](#)
- [Classes Versus Structures](#)
- [Data Encoding for Classes](#)
- [Data Encoding for Exceptions](#)
- [Slice Metadata Directives](#)
- [Classes with Compact Type IDs](#)

Optional Values

Version 1.1 of the Ice [encoding](#) introduces a convenient new feature that allows you to declare data members and parameters as optional. Collectively called *optional values*, this feature provides two main benefits for Ice applications:

- It offers a simple and natively-supported mechanism for representing values that may or may not be present, without consuming any additional space in a message when an optional value is not used.
- It significantly improves the ability to gradually evolve components of an Ice application while maintaining backward compatibility with existing deployments.

On this page:

- [Motivation for Optional Values](#)
 - [Alternative Strategies for Modeling Optional Values](#)
 - [Addressing the Versioning Problem](#)
- [Overview of Optional Values](#)
 - [Optional Parameters in Operations](#)
 - [Optional Data Members in Classes and Exceptions](#)
- [Guidelines for using Optional Values](#)
- [Backward Compatibility with Encoding Version 1.0](#)
- [Using Optional Values Efficiently](#)

Motivation for Optional Values

This section describes the issues that prompted the development of this new feature.

Alternative Strategies for Modeling Optional Values

Prior to Ice 3.5, developers did not have a convenient way to model an optional value. One possibility was to wrap the value in a Slice class:

```

class OptionalInt
{
    int i;
};

interface Example
{
    void compute(int input, OptionalInt scale);
};

```

The ability to pass a nil value for a class instance means the receiver can interpret nil to mean "not present", and the four bytes required to encode a nil value are a reasonable price to pay. Although this is a workable strategy, it incurs significantly more overhead when the optional value is present because the encoding for class instances is expensive. In the example above, an integer value that would have consumed just four bytes when encoded becomes a class instance that could require ten times as much space in the encoding.



The new "compact" encoding for Slice classes would lower the overhead of this strategy, but it still cannot match the efficiency of the encoding for optional values.

A much more efficient alternative was to use a sequence:

Slice

```
sequence<int> OptionalInt;

interface Example
{
    void compute(int input, OptionalInt scale);
};
```

Passing an empty sequence signifies the "not present" case and consumes only a single byte in the encoding. When the value is present, passing a sequence with one element adds just one byte of overhead to the encoded value. Despite its minimal overhead, constructing temporary sequences in application code becomes awkward and tedious. Furthermore, depending on the language mapping in use, it is not always obvious that a given sequence parameter actually represents an optional value. Consider the Java language mapping for `compute`:

Java

```
public interface Example : ...
{
    void compute(int input, int[] scale, ...);
}
```

A developer looking at this API for the first time has no indication that the `scale` parameter is optional, which can lead to unintentional misuse and programming errors.

Addressing the Versioning Problem

Aside from the inability to conveniently model an optional value, another motivating factor is versioning. As an application evolves over time, it is only natural for its Slice definitions to change. However, there are only a few kinds of changes you can make to your Slice definitions if your goal is to maintain "on-the-wire" compatibility with existing deployments:

- Adding new interfaces
- Adding new data types that are only used by new operations and interfaces
- Adding new operations to existing interfaces
- Renaming existing parameters and data members
- Renaming structures, sequences, dictionaries, enumerations, and enumerators

The nature of the Ice [encoding rules](#) make these changes possible. For example, the encoding does not include the names of data members or parameters, therefore changing their names does not affect backward compatibility. Similarly, the fact that the encoding for an invocation uses the operation's name to select the target operation, and not some other identification scheme such as a numeric index, means you can add new operations to an existing interface without breaking backward compatibility.

Making any of the following modifications is considered a "breaking" change:

- Changing the type of a data member or parameter
- Changing the declaration order of data members or parameters
- Renaming an operation, interface, class, or exception

These changes directly impact the encoding and prevent an existing receiver from successfully decoding the message. Before the introduction of optional values, we recommended using [facets](#) to manage a breaking change. Now optional values give you an alternative solution, but only for [certain types of changes](#).

Overview of Optional Values

The optional syntax is the same for both parameters and data members:

```
optional(tag) type name
```

The `optional` keyword, new in Ice 3.5, denotes an optional value with the given tag. The value for `tag` must be a non-negative integer.



If your Slice definitions currently use `optional` as an identifier, you can continue using it as an identifier by escaping it as `\optional`.

Data members and parameters not marked as optional are considered *required*; a sender must supply values for all required parameters and members.

Each language mapping defines APIs for passing an optional value, indicating that an optional value is not set, and testing whether an optional value is set. For example, the three strongly-typed languages that Ice currently supports (C++, C#, and Java) all use a similar API: an `Optional` type wraps the optional value and provides methods for examining and changing its value. C++ and C# also define the "marker" value `None` that can be substituted for any optional value to indicate that it is unset. No `Optional` type is necessary for the scripting languages, where you simply pass the value (if set) or the marker value `Unset`. Refer to the language mapping sections for more details on optional values.



A well-behaved program must not assume that an optional data member or parameter always has a value.

An optional value incurs no additional overhead in the encoding when its value is unset. If an optional parameter or member has a value, its overhead depends on [several factors](#), including your choice of tag values.

Optional Parameters in Operations

An operation may [declare as optional](#) its return value and any of its parameters. The ordering rules for parameters remain unchanged: all input parameters must precede the output parameters.

The following Slice operation declares a mix of optional and required parameters, as well as an optional return value:

```

Slice



```
interface Database
{
 optional(3) Record
 lookup(string key, optional(1) Filter f, out optional(2) Cursor
matches);
};
```

```

We can invoke `lookup` in C++ as shown below:

C++

```

DatabasePrx proxy = ...;
Optional<Record> rec;
Optional<Cursor> matches;
rec = proxy->lookup("someKey", IceUtil::None, matches);
if(rec)
{
    // lookup returned a value

    if(matches)
    {
        // there are more matches
    }
}

```

Notice that we pass `IceUtil::None` for the `Filter` value to indicate that this parameter is unset.

Optional Data Members in Classes and Exceptions

[Data members](#) can be declared as optional in classes and exceptions. Structures do not support optional data members.

Consider the following example:

Slice

```

class Account
{
    string accountNo;
    optional(9) Account referrer;
};

```

We can use `Account` in C# as shown below:

C#

```

void printAccount(Account acct)
{
    Console.WriteLine("Account #: " + acct.accountNo);
    if(acct.referrer.HasValue)
        Console.WriteLine("Referrer: " + acct.referrer.Value.accountNo);
    else
        Console.WriteLine("Referrer: None");
}

Account a1 = new Account("100-21807", Ice.Util.None);
printAccount(a1);
Account a2 = new Account("165-75122", a1);
printAccount(a2);

```

Implicit conversion operators in C# allow us to pass a value of the declared type, or `Ice.Util.None` for an unset value, where an optional value is expected.

Guidelines for using Optional Values

Keep the following guidelines in mind while using optional values:

- Consider an optional value as a logical unit composed of its tag and type. The parameter or member name is not included in the Ice encoding, therefore changes to the name do not affect on-the-wire compatibility. Changing the tag of a value is equivalent to adding a new value: the previous iteration of the value still exists as long as there is at least one deployed program that might use it.
- To change the type of an optional value without affecting compatibility with existing deployments, you must also change its tag. You are essentially deprecating the old value and adding a new one.
- Whenever you change the tag of a value, we recommend making a note of the old definition (such as in a Slice comment) so that you do not accidentally reuse its tag.
- Adding a new optional parameter or member does not affect compatibility with existing deployments as long as its tag is not currently in use.
- Removing an optional parameter or member does not affect compatibility with existing deployments if programs are written correctly to test for the presence of the value prior to using it.
- The order of declaration is important for required members and parameters, but is not important for optional members and parameters. If you wish to maintain compatibility with existing deployments, do not change the order of declaration for required members and parameters. Compatibility is not affected by changes to the order of optional members and parameters.

Backward Compatibility with Encoding Version 1.0

Optional values require version 1.1 of the Ice encoding. If the intended receiver only supports version 1.0 of the encoding, the Ice run time in the sender will omit all optional parameters when marshaling the operation's parameters or results, and omit all optional data members. This behavior makes it possible for you to add optional parameters to an operation, or optional members to a class or exception, without affecting backward compatibility with existing deployments that use version 1.0 of the encoding, while gaining the ability to exchange optional values with new deployments that use version 1.1 of the encoding.

For example, suppose existing deployments use the following class definition:

Slice

```
// Version 1
class Person
{
    string firstName;
    string lastName;
};
```

We can safely add an optional member without affecting compatibility:

Slice

```
// Version 2
class Person
{
    string firstName;
    string lastName;
    optional(1) Date birthDate;
};
```

It is even safe to insert an optional member between two existing members:

Slice

```
// Version 3
class Person
{
    string firstName;
    optional(2) string middleName;
    string lastName;
    optional(1) Date birthDate;
};
```

When sending an instance of `Person` to a receiver that supports only encoding version 1.0, the optional members are omitted and the encoded form matches our initial version of the class.

A similar situation exists for operations. For example, the following three operations are compatible when using encoding version 1.0:

Slice

```

Person createPerson(string firstName, string lastName); // V1

Person createPerson(string firstName, string lastName, optional(1) Date
birthDate); // V2

Person createPerson(string firstName, optional(2) string middleName,
string lastName,
                    optional(1) Date birthDate); // V3

```

Note however that other types of changes can easily [break compatibility](#).

Using Optional Values Efficiently

The Ice [encoding](#) uses a self-describing format to minimize the overhead associated with optional data members and allow for efficient decoding in a receiver. The amount of overhead required for a member depends on the member's type and its tag. The type contributes between one and five bytes of overhead, while the tag value contributes an additional zero to five bytes. Tag values less than 30 add no additional overhead; tag values between 30 and 254 add a single byte, and tag values of 255 or greater add five bytes.



The overhead associated with the member's type is out of your control, but you have direct control of the overhead for tags. To minimize this overhead, use tags in the range zero to 29.

The table below describes the overhead associated with several common Slice types:

Type	Overhead (bytes)
Primitive (including <code>string</code>)	1
Proxy	5
Object	1
Sequence of <code>byte</code> , <code>bool</code>	1
Sequence	2-5
Enumerator	1
Structure	2-5
Dictionary	2-5

Refer to the encoding specification for more details on marshaling optional data members.

See Also

- [Data Encoding](#)
- [Optional Data Members](#)
- [Optional Parameters and Return Values](#)

Facets and Versioning

Facets provide a general-purpose mechanism for non-intrusively extending the type system of an application, by loosely coupling new type instances to existing ones. This shifts the type selection process from compile to run time and implements a form of late binding. This is particularly useful for versioning an application.

Due to their loose coupling among each other, facets are better suited to solve the versioning problem than other approaches. However, facets are not a panacea that would solve the versioning problem for free, and careful design is still necessary to come up with versioned systems that remain understandable and maintain consistent semantics.

Topics

- [Facet Concepts](#)
- [The Versioning Problem](#)
- [Versioning with Facets](#)

Facet Concepts

On this page:

- Ice Objects as Collections of Facets
- Server-Side Facet Operations
- Client-Side Facet Operations
- Facet Exception Semantics

Ice Objects as Collections of Facets

Up to this point, we have presented an Ice object as a single conceptual entity, that is, as an object with a single most-derived interface and a single *identity*, with the object being implemented by a single servant. However, an Ice object is more correctly viewed as a collection of one or more sub-objects known as facets, as shown below:

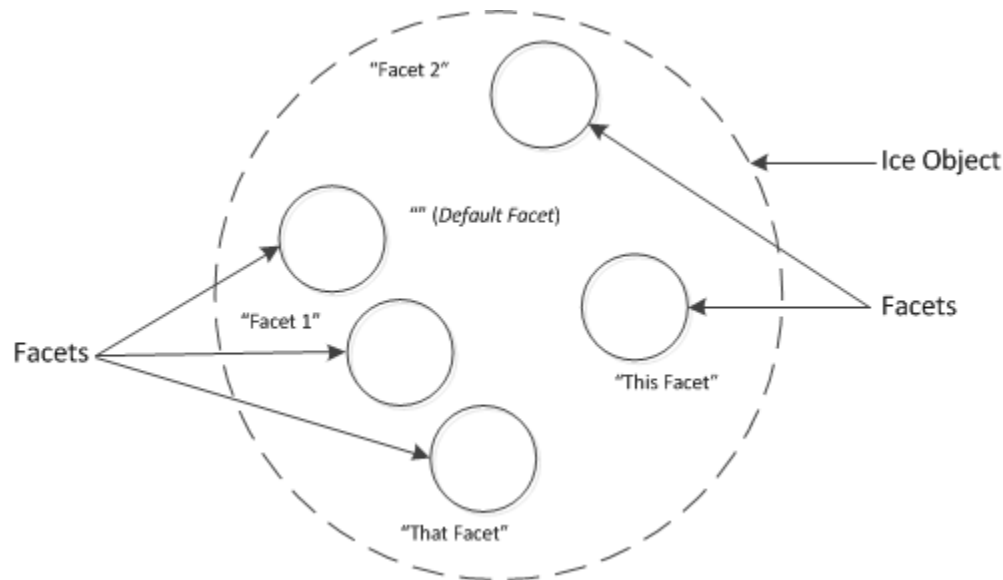

An Ice object with five facets sharing a single object identity.

The diagram above shows a single Ice object with five facets. Each facet has a name, known as the *facet name*. Within a single Ice object, all facets must have unique names. Facet names are arbitrary strings that are assigned by the server that implements an Ice object. A facet with an empty facet name is legal and known as the *default facet*. Unless you arrange otherwise, an Ice object has a single default facet; by default, operations that involve Ice objects and servants operate on the default facet.

Note that all the facets of an Ice object share the same single identity, but have different facet names. Recall the definition of `Ice::Current` once more:

Slice

```

module Ice {
  local dictionary<string, string> Context;

  enum OperationMode { Normal, \Nonmutating, \Idempotent };

  local struct Current {
    ObjectAdapter  adapter;
    Identity       id;
    string         facet;
    string         operation;
    OperationMode mode;
    Context        ctx;
    int            requestId;
    EncodingVersion encoding;
  };
};

```

By definition, if two facets have the same `id` field, they are part of the same Ice object. Also by definition, if two facets have the same `id` field, their `facet` fields have different values.

Even though Ice objects usually consist of just the default facet, it is entirely legal for an Ice object to consist of facets that all have non-empty names (that is, it is legal for an Ice object not to have a default facet).

Each facet has a single most-derived interface. There is no need for the interface types of the facets of an Ice object to be unique. It is legal for two facets of an Ice object to implement the same most-derived interface.

Each facet is implemented by a servant. All the usual implementation techniques for servants are available to implement facets — for example, you can implement a facet using a servant locator. Typically, each facet of an Ice object has a separate servant, although, if two facets of an Ice object have the same type, they can also be implemented by a single servant (for example, using a [default servant](#)).

Server-Side Facet Operations

On the server side, the [object adapter](#) offers a number of operations to support facets:

Slice

```

namespace Ice {
    dictionary<string, Object> FacetMap;

    local interface ObjectAdapter {
        Object* addFacet(Object servant, Identity id, string facet);
        Object* addFacetWithUUID(Object servant, string facet);
        Object  removeFacet(Identity id, string facet);
        Object  findFacet(Identity id, string facet);

        FacetMap findAllFacets(Identity id);
        FacetMap removeAllFacets(Identity id);
        // ...
    };
};

```

These operations have the same semantics as the corresponding "normal" operations for [servant activation and deactivation](#) (`add`, `addWithUUID`, `remove`, and `find`), but also accept a facet name. The corresponding "normal" operations are simply convenience operations that supply an empty facet name. For example, `remove(id)` is equivalent to `removeFacet(id, "")`, that is, `remove(id)` operates on the default facet.

`findAllFacets` returns a dictionary of `<facet-name, servant>` pairs that contains all the facets for the given identity.

`removeAllFacets` removes all facets for a given identity from the active servant map, that is, it removes the corresponding Ice object entirely. The operation returns a dictionary of `<facet-name, servant>` pairs that contains all the removed facets.

These operations are sufficient for the server to create Ice objects with any number of facets. For example, assume that we have the following Slice definitions:

Slice

```

module Filesystem {
    // ...

    interface File extends Node {
        idempotent Lines read();
        idempotent void write(Lines text) throws GenericError;
    };
};

module FilesystemExtensions {
    // ...

    class DateTime extends TimeOfDay {
        // ...
    };

    struct Times {
        DateTime createdDate;
        DateTime accessedDate;
        DateTime modifiedDate;
    };

    interface Stat {
        idempotent Times getTimes();
    };
};

```

Here, we have a `File` interface that provides operations to read and write a file, and a `Stat` interface that provides access to the file creation, access, and modification time. (Note that the `Stat` interface is defined in a different module and could also be defined in a different source file.) If the server wants to create an Ice object that contains a `File` instance as the default facet and a `Stat` instance that provides access to the time details of the file, it could do so as follows:

C++

```

// Create a File instance.
//
Filesystem::FilePtr file = new FileI;

// Create a Stat instance.
//
FilesystemExctensions::DateTimePtr dt
= new FilesystemExtensions::DateTime;
FilesystemExtensions::Times times;
times.createdDate = dt;
times.accessedDate = dt;
times.modifiedDate = dt;
FilesystemExtensions::StatPtr stat = new StatI(times);

// Register the File instance as the default facet.
//
Filesystem::FilePrx filePrx = myAdapter->addWithUUID(file);

// Register the Stat instance as a facet with name "Stat".
//
myAdapter->addFacet(stat, filePrx->ice_getIdentity(), "Stat");

```

The first few lines simply create and initialize a `FileI` and `StatI` instance. (The details of this do not matter here.) All the action is in the last two statements:

C++

```

Filesystem::FilePrx filePrx = myAdapter->addWithUUID(file);
myAdapter->addFacet(stat, filePrx->ice_getIdentity(), "Stat");

```

This registers the `FileI` instance with the object adapter as usual. (In this case, we let the Ice run time generate a UUID as the object identity.) Because we are calling `addWithUUID` (as opposed to `addFacetWithUUID`), the instance becomes the default facet.

The second line adds a facet to the instance with the facet name `Stat`. Note that we call `ice_getIdentity` on the `File` proxy to pass an object identity to `addFacet`. This guarantees that the two facets share the same object identity.

Note that, in general, it is a good idea to use `ice_getIdentity` to obtain the identity of an existing facet when adding a new facet. That way, it is guaranteed that the facets share the same identity. (If you accidentally pass a different identity to `addFacet`, you will not add a facet to an existing Ice object, but instead register a new Ice object; using `ice_getIdentity` makes this mistake impossible.)

Client-Side Facet Operations

On the client side, which facet a request is addressed to is implicit in the proxy that is used to send the request. For an application that does not use facets, the facet name is always empty so, by default, requests are sent to the default facet.

The client can use a `checkedCast` to obtain a proxy for a particular facet. For example, assume that the client obtains a proxy to a `File` instance as shown [above](#). The client can cast between the `File` facet and the `Stat` facet (and back) as follows:

C++

```

// Get a File proxy.
//
Filesystem::FilePrx file = ...;

// Get the Stat facet.
//
FilesystemExtensions::StatPrx stat =
    FilesystemExtensions::StatPrx::checkedCast(file, "Stat");

// Go back from the Stat facet to the File facet.
//
Filesystem::FilePrx file2 = Filesystem::FilePrx::checkedCast(stat, "");

assert(file2 == file); // The two proxies are identical.

```

This example illustrates that, given any facet of an Ice object, the client can navigate to any other facet by using a `checkedCast` with the facet name.

If an Ice object does not provide the specified facet, `checkedCast` returns null:

C++

```

FilesystemExtensions::StatPrx stat =
    FilesystemExtensions::StatPrx::checkedCast(file, "Stat");

if (!stat) {
    // No Stat facet on this object, handle error...
} else {
    FilesystemExtensions::Times times = stat->getTimes();

    // Use times struct...
}

```

Note that `checkedCast` also returns a null proxy if a facet exists, but the cast is to the wrong type. For example:

C++

```
// Get a File proxy.
//
Filesystem::FilePrx file = ...;

// Cast to the wrong type.
//
SomeTypePrx prx = SomeTypePrx::checkedCast(file, "Stat");

assert(!prx); // checkedCast returns a null proxy.
```

If you want to distinguish between non-existence of a facet and the facet being of the incorrect type, you can first obtain the facet as type `Object` and then down-cast to the correct type:

C++

```
// Get a File proxy.
//
Filesystem::FilePrx file = ...;

// Get the facet as type Object.
//
Ice::ObjectPrx obj = Ice::ObjectPrx::checkedCast(file, "Stat");
if (!obj) {
    // No facet with name "Stat" on this Ice object.
} else {
    FilesystemExtensions::StatPrx stat =
        FilesystemExtensions::StatPrx::checkedCast(file);
    if (!stat) {
        // There is a facet with name "Stat", but it is not
        // of type FilesystemExtensions::Stat.
    } else {
        // Use stat...
    }
}
}
```

This last example also illustrates that

C++

```
StatPrx::checkedCast(prx, "")
```

is *not* the same as

C++

```
StatPrx::checkedCast (prx)
```

The first version explicitly requests a cast to the default facet. This means that the Ice run time first looks for a facet with the empty name and then attempts to down-cast that facet (if it exists) to the type `Stat`.

The second version requests a down-cast that *preserves* whatever facet is currently effective in the proxy. For example, if the `prx` proxy currently holds the facet name "Joe", then (if `prx` points at an object of type `Stat`) the run time returns a proxy of type `StatPrx` that also stores the facet name "Joe".

It follows that, to navigate between facets, you must always use the two-argument version of `checkedCast`, whereas, to down-cast to another type while preserving the facet name, you must always use the single-argument version of `checkedCast`.

You can always check what the current facet of a proxy is by calling `ice_getFacet`:

C++

```
Ice::ObjectPrx obj = ...;

cout << obj->ice_getFacet() << endl; // Print facet name
```

This prints the facet name. (For the default facet, `ice_getFacet` returns the empty string.)

Facet Exception Semantics

The [common exceptions](#) `ObjectNotExistException` and `FacetNotExistException` have the following semantics:

- `ObjectNotExistException`
This exception is raised only if no facets exist at all for a given object identity.
- `FacetNotExistException`
This exception is raised only if at least one facet exists for a given object identity, but not the specific facet that is the target of an operation invocation.

If you are using [servant locators](#) or [default servants](#), you must take care to preserve these semantics. In particular, if you return null from a servant locator's `locate` operation, this appears to the client as an `ObjectNotExistException`. If the object identity for a request is known (that is, there is at least one facet with that identity), but no facet with the specified name exists, you must explicitly throw a `FacetNotExistException` from `locate` instead of simply returning null.

See Also

- [Object Identity](#)
- [Run-Time Exceptions](#)
- [Object Adapters](#)
- [Servant Locators](#)
- [Default Servants](#)
- [The Current Object](#)

The Versioning Problem

Once you have developed and deployed a distributed application, and once the application has been in use for some time, it is likely that you will want to make some changes to the application. For example, you may want to add new functionality to a later version of the application, or you may want to change some existing aspect of the application. Of course, ideally, such changes are accomplished without breaking already deployed software, that is, the changes should be backward compatible. Evolving an application in this way is generally known as *versioning*.

Versioning is an aspect that previous middleware technologies have addressed only poorly (if at all). One of the purposes of facets is to allow you to cleanly create new versions of an application without compromising compatibility with older, already deployed versions.

On this page:

- [Versioning by Addition](#)
- [Versioning by Derivation](#)
- [Explicit Versioning](#)

Versioning by Addition

Suppose that we have deployed our [file system](#) application and want to add extra functionality to a new version. Specifically, let us assume that the original version (version 1) only provides the basic functionality to use files, but does not provide extra information, such as the modification date or the file size. The question is then, how can we upgrade the existing application with this new functionality? Here is a small excerpt of the original (version 1) Slice definitions once more:

```

Slice



```
// Version 1

module Filesystem {
 // ...

 interface File extends Node {
 idempotent Lines read();
 idempotent void write(Lines text) throws GenericError;
 };
};
```

```

Your first attempt at upgrading the application might look as follows:

Slice

```
// Version 2

module Filesystem {
    // ...

    class DateTime extends TimeOfDay { // New in version 2
        // ...
    };

    struct Times { // New in version 2
        DateTime createdDate;
        DateTime accessedDate;
        DateTime modifiedDate;
    };

    interface File extends Node {
        idempotent Lines read();
        idempotent void write(Lines text) throws GenericError;

        idempotent Times getTimes(); // New in version 2
    };
};
```

Note that the version 2 definition does not change anything that was present in version 1; instead, it only adds two new types and adds an operation to the `File` interface. Version 1 clients can continue to work with both version 1 and version 2 `File` objects because version 1 clients do not know about the `getTimes` operation and therefore will not call it; version 2 clients, on the other hand, can take advantage of the new functionality. The reason this works is that the Ice protocol invokes an operation by sending the operation name as a string on the wire (rather than using an ordinal number or hash value to identify the operation). Ice guarantees that any future version of the protocol will retain this behavior, so it is safe to add a new operation to an existing interface without recompiling all clients.

However, this approach contains a pitfall: the tacit assumption built into this approach is that no version 2 client will ever use a version 1 object. If the assumption is violated (that is, a version 2 client uses a version 1 object), the version 2 client will receive an `OperationNotExistException` when it invokes the new `getTimes` operation because that operation is supported only by version 2 objects.

Whether you can make this assumption depends on your application. In some cases, it may be possible to ensure that version 2 clients will never access a version 1 object, for example, by simultaneously upgrading all servers from version 1 to version 2, or by taking advantage of application-specific constraints that ensure that version 2 clients only contact version 2 objects. However, for some applications, doing this is impractical.

Note that you could write version 2 clients to catch and react to an `OperationNotExistException` when they invoke the `getTimes` operation: if the operation succeeds, the client is dealing with a version 2 object, and if the operation raises `OperationNotExistsException`, the client is dealing with a version 1 object. However, doing this can be rather intrusive to the code, loses static type safety, and is rather inelegant. (There is no other way to tell a version 1 object from a version 2 object because both versions have the same type ID.)

In general, versioning by addition makes sense when you need to add an operation or two to an interface, and you can be sure that version 2 clients do not access version 1 objects. Otherwise, other approaches are needed.

Versioning by Derivation

Given the limitations of the preceding approach, you may decide instead to upgrade the application as follows:

Slice

```

module Filesystem {      // Version 1
    // ...

    interface File extends Node {
        idempotent Lines read();
        idempotent void write(Lines text) throws GenericError;
    };
};

module FilesystemV2 {    // New in version 2
    // ...

    class DateTime extends TimeOfDay {
        // ...
    };

    struct Times {
        DateTime createdDate;
        DateTime accessedDate;
        DateTime modifiedDate;
    };

    interface File extends Filesystem::File {
        idempotent Times getTimes();
    };
};

```

The idea is to present the new functionality in an interface that is derived from the version 1 interface. The version 1 types are unchanged and the new functionality is presented via new types that are backward compatible: a version 2 `File` object can be passed where a version 1 `File` object is expected because `FilesystemV2::File` is derived from `Filesystem::File`. Even better, if a version 2 component of the system receives a proxy of formal type `Filesystem::File`, it can determine at run time whether the actual run-time type is `FilesystemV2::File` by attempting a down-cast: if the down-cast succeeds, it is dealing with a version 2 object; if the down-cast fails, it is dealing with a version 1 object. This is essentially the same as versioning by addition, but it is cleaner as far as the type system is concerned because the two different versions can be distinguished via their type IDs.

At this point, you may think that versioning by derivation solves the problem elegantly. Unfortunately, the truth turns out to be a little harsher:

- As the system evolves further, and new versions are added, each new version adds a level of derivation to the inheritance tree. After a few versions, particularly if your application also uses inheritance for its own purposes, the resulting inheritance graph very quickly turns into a complex mess. (This becomes most obvious if the application uses multiple inheritance — after a few versioning steps, the resulting inheritance hierarchy is usually so complex that it exceeds the ability of humans to comprehend it.)
- Real-life versioning requirements are not as simple as adding a new operation to an object. Frequently, versioning requires changes such as adding a field to a structure, adding a parameter to an operation, changing the type of a field or a parameter, renaming an operation, or adding a new exception to an operation. However, versioning by derivation (and versioning by addition) can handle none of these changes.
- Quite often, functionality that is present in an earlier version needs to be removed for a later version (for example, because the older functionality has been supplanted by a different mechanism or turned out to be inappropriate). However, there is no way to *remove* functionality through versioning by derivation. The best you can do is to re-implement a base operation in the derived implementation

of an interface and throw an exception. However, the deprecated operation may not have an exception specification, or if it does, the exception specification may not include a suitable exception. And, of course, doing this perverts the type system: after all, if an interface has an operation that throws an exception whenever the operation is invoked, why does the operation exist in the first place?

There are other, more subtle reasons why versioning by derivation is unsuitable in real-life situations. Suffice it to say here that experience has shown the idea to be unworkable: projects that have tried to use this technique for anything but the most trivial versioning requirements have inevitably failed.

Explicit Versioning

Yet another twist on the versioning theme is to explicitly version everything, for example:

```

Slice

module Filesystem {
    // ...

    interface FileV1 extends NodeV1 {
        idempotent LinesV1 read();
        idempotent void write(LinesV1 text) throws GenericErrorV1;
    };

    class DateTimeV2 extends TimeOfDayV2 {
        // ...
    };

    struct TimesV2 {
        DateTimeV2 createdDate;
        DateTimeV2 accessedDate;
        DateTimeV2 modifiedDate;
    };

    interface FileV2 extends NodeV2 {
        idempotent LinesV2 read();
        idempotent void write(LinesV2 text) throws GenericErrorV2;
        idempotent TimesV2 getTimes();
    };
};

```

In essence, this approach creates as many separate definitions of each data type, interface, and operation as there are versions. It is easy to see that this approach does not work very well:

- Because, at the time version 1 is produced, it is unknown what might need to change for version 2 and later versions, *everything* has to be tagged with a version number. This very quickly leads to an incomprehensible type system.
- Because every version uses its own set of separate types, there is no type compatibility. For example, a version 2 type cannot be passed where a version 1 type is expected without explicit copying.
- Client code must be written to explicitly deal with each separate version. This pollutes the source code at all points where a remote call is made or a Slice data type is passed; the resulting code quickly becomes incomprehensible.

Other approaches, such as placing the definitions for each version into a separate module (that is, versioning the enclosing module instead of each individual type) do little to mitigate these problems; the type incompatibility issues and the need to explicitly deal with versioning

remain.

See Also

- [Slice for a Simple File System](#)

Versioning with Facets

We described several ways that a user might try to solve [the versioning problem](#). A negative aspect of all these approaches is that they change the type system in intrusive ways. In turn, this forces unacceptable programming contortions on clients. Facets allow you to solve the versioning problem more elegantly because they do not change an existing type system but extend it instead. We saw this approach [once already](#), where we added date information about a file to our file system application without disturbing any of the existing definitions.

In the most general sense, facets provide a mechanism for implementing multiple interfaces for a single object. The key point is that, to add a new interface to an object, none of the existing definitions have to be touched, so no compatibility issues can arise. More importantly, the decision as to which facet to use is made at run time instead of at compile time. In effect, facets implement a form of late binding and, therefore, are coupled to the type system more loosely than any of the previous approaches.

Used judiciously, facets can handle versioning requirements more elegantly than other mechanisms. Apart from the straight extension of an interface as shown [earlier](#), facets can also be used for more complex changes. For example, if you need to change the parameters of an operation or modify the fields of a structure, you can create a new facet with operations that operate on the changed data types. Quite often, the implementation of a version 2 facet in the server can even re-use much of the version 1 functionality, by delegating some version 2 operations to a version 1 implementation.

On this page:

- [Facet Selection](#)
- [Behavioral Versioning](#)
- [Facets Design Considerations](#)

Facet Selection

Given that we have decided to extend an application with facets, we have to deal with the question of how clients select the correct facet. The answer typically involves an explicit selection of a facet sometime during client start-up. For example, in our file system application, clients always begin their interactions with the file system by creating a proxy to the root directory. Let us assume that our versioning requirements have led to version 1 and version 2 definitions of directories as follows:

Slice

```

module Filesystem { // Original version
    // ...

    interface Directory extends Node {
        idempotent NodeSeq list();
        // ...
    };
};

module FilesystemV2 {
    // ...

    enum NodeType { Directory, File };

    class NodeDetails {
        NodeType type;
        string name;
        DateTime createdTime;
        DateTime accessedTime;
        DateTime modifiedTime;
        // ...
    };

    interface Directory extends Filesystem::Node {
        idempotent NodeDetailsSeq list();
        // ...
    };
};

```

In this case, the semantics of the `list` operation have changed in version 2. A version 1 client uses the following code to obtain a proxy to the root directory:

C++

```

// Create a proxy for the root directory
//
Ice::ObjectPrx base
= communicator()->stringToProxy("RootDir:default -p 10000");
if (!base)
    throw "Could not create proxy";

// Down-cast the proxy to a Directory proxy
//
Filesystem::DirectoryPrx rootDir
= Filesystem::DirectoryPrx::checkedCast(base);
if (!rootDir)
    throw "Invalid proxy";

```

For a version 2 client, the bootstrap code is almost identical — instead of down-casting to `Filesystem::Directory`, the client selects the "V2" facet during the down-cast to the type `FilesystemV2::Directory`:

C++

```

// Create a proxy for the root directory
//
Ice::ObjectPrx base
= communicator()->stringToProxy("RootDir:default -p 10000");
if (!base)
    throw "Could not create proxy";

// Down-cast the proxy to a V2 Directory proxy
//
FilesystemV2::DirectoryPrx rootDir
= FilesystemV2::DirectoryPrx::checkedCast(base, "V2");
if (!rootDir)
    throw "Invalid proxy";

```

Of course, we can also create a client that can deal with both version 1 and version 2 directories: if the down-cast to version 2 fails, the client is dealing with a version 1 server and can adjust its behavior accordingly.

Behavioral Versioning

On occasion, versioning requires changes in behavior that are not manifest in the interface of the system. For example, we may have an operation that performs some work, such as:

Slice

```
interface Foo {
    void doSomething();
};
```

The same operation on the same interface exists in both versions, but the *behavior* of `doSomething` in version 2 differs from that in version 1. The question is, how do we best deal with such behavioral changes?

Of course, one option is to simply create a version 2 facet and to carry that facet alongside the original version 1 facet. For example:

Slice

```
module V2 {

    interface Foo { // V2 facet
        void doSomething();
    };

};
```

This works fine, as far as it goes: a version 2 client asks for the "V2" facet and then calls `doSomething` to get the desired effect. Depending on your circumstances, this approach may be entirely reasonable. However, if there are such behavioral changes on several interfaces, the approach leads to a more complex type system because it duplicates each interface with such a change.

A better alternative can be to create two facets of the same type, but have the implementation of those facets differ. With this approach, both facets are of type `::Foo::doSomething`. However, the implementation of `doSomething` checks which facet was used to invoke the request and adjusts its behavior accordingly:

C++

```
void
FooI::doSomething(const Ice::Current& c)
{
    if (c.facet == "V2") {
        // Provide version 2 behavior...
    } else {
        // Provide version 1 behavior...
    }
}
```

This approach avoids creating separate types for the different behaviors, but has the disadvantage that version 1 and version 2 objects are no longer distinguishable to the type system. This can matter if, for example, an operation accepts a `Foo` proxy as a parameter. Let us assume that we also have an interface `FooProcessor` as follows:

Slice

```
interface FooProcessor {
    void processFoo(Foo* w);
};
```

If `FooProcessor` also exists as a version 1 and version 2 facet, we must deal with the question of what should happen if a version 1 `Foo` proxy is passed to a version 2 `processFoo` operation because, at the type level, there is nothing to prevent this from happening.

You have two options for dealing with this situation:

- Define working semantics for mixed-version invocations. In this case, you must come up with sensible system behavior for all possible combinations of versions.
- If some of the combinations are disallowed (such as passing a version 1 `Foo` proxy to a version 2 `processFoo` operation), you can detect the version mismatch in the server by looking at the `Current::facet` member and throwing an exception to indicate a version mismatch. Simultaneously, write your clients to ensure they only pass a permissible version to `processFoo`. Clients can ensure this by checking the facet name of a proxy before passing it to `processFoo` and, if there is a version mismatch, changing either the `Foo` proxy or the `FooProcessor` proxy to a matching facet:

C++

```
FooPrx foo = ...;           // Get a Foo...
FooProcessorPrx fooP = ...; // Get a FooProcessor...

string fooFacet = foo->ice_getFacet();
string fooPFacet = fooP->ice_getFacet();
if (fooFacet != fooPFacet) {
    if (fooPFacet == "V2") {
        error("Cannot pass a V1 Foo to a V2 FooProcessor");
    } else {
        // Upgrade FooProcessor from V1 to V2
        fooP = FooProcessorPrx::checkedCast(fooP, "V2");
        if (!fooP) {
            error("FooProcessor does not have a V2 facet");
        } else {
            fooP->processFoo(foo);
        }
    }
}
```

Facets Design Considerations

Facets allow you to add versioning to a system, but they are merely a mechanism, not a solution. You still have to make a decision as to how to version something. For example, eventually you may want to deprecate a previous version's behavior; at that point, you must make a decision how to handle requests for the deprecated version. For behavioral changes, you have to decide whether to use separate interfaces or use facets with the same interface. And, of course, you must have compatibility rules to determine what should happen if, for example, a version 1 object is passed to an operation that implements version 2 behavior. In other words, facets cannot do your thinking for you and are no panacea for the versioning problem.

The biggest advantage of facets is also the biggest drawback: facets delay the decision about the types that are used and their behavior until

run time. While this provides a lot of flexibility, it is significantly less type-safe than having explicit types that can be statically checked at compile time: if you have a problem relating to incorrect facet selection, the problem will be visible only at run time and, moreover, will be visible only if you actually execute the code that contains the problem, and execute it with just the right data.

Another danger of facets is the opportunity for abuse. As an extreme example, here is an interface that provides an arbitrary collection of objects of arbitrary type:

Slice

```
interface Collection {};
```

Even though this interface is empty, it can provide access to an unlimited number of objects of arbitrary type in the form of facets. While this example is extreme, it illustrates the design tension that is created by facets: you must decide, for a given versioning problem, how and at what point of the type hierarchy to split off a facet that deals with the changed functionality. The temptation may be to "simply add another facet" and be done with it. However, if you do that, your objects are in danger of being nothing more than loose conglomerates of facets without rhyme or reason, and with little visibility of their relationships in the type system.

In object modeling terms, the relationship among facets is weaker than an *is-a* relationship (because facets are often not type-compatible among each other). On the other hand, the relationship among facets is stronger than a *has-a* relationship (because all facets of an Ice object share the same [object identity](#)).

It is probably best to treat the relationship of a facet to its Ice object with the same respect as an inheritance relationship: if you were omniscient and could have designed your system for all current and future versions simultaneously, many of the operations that end up on separate facets would probably have been in the same interface instead. In other words, adding a facet to an Ice object most often implies that the facet has an *is-partly-a* relationship with its Ice object. In particular, if you think about the life cycle of an Ice object and find that, when an Ice object is deleted, all its facets must be deleted, this is a strong indication of a correct design. On the other hand, if you find that, at various times during an Ice object's life cycle, it has a varying number of facets of varying types, that is a good indication that you are using facets incorrectly.

Ultimately, the decision comes down to deciding whether the trade-off of static type safety versus dynamic type safety is worth the convenience and backward compatibility. The answer depends strongly on the design of your system and individual requirements, so we can only give broad advice here. Finally, there will be a point where no amount of facet trickery will get past the point when "yet one more version will be the straw that breaks the camel's back." At that point, it is time to stop supporting older versions and to redesign the system.

See Also

- [Facet Concepts](#)
- [The Versioning Problem](#)
- [The Current Object](#)
- [Object Identity](#)

Object Life Cycle

Topics

- [Understanding Object Life Cycle](#)
- [Object Existence and Non-Existence](#)
- [Life Cycle of Proxies, Servants, and Ice Objects](#)
- [Object Creation](#)
- [Object Destruction](#)
- [Removing Cyclic Dependencies](#)
- [Object Identity and Uniqueness](#)
- [Object Life Cycle for the File System Application](#)
- [Avoiding Server-Side Garbage](#)

Understanding Object Life Cycle

Object life cycle generally refers to how an object-oriented application (whether distributed or not) creates and destroys objects. For distributed applications, life cycle management presents particular challenges. For example, destruction of objects often can be surprisingly complex, especially in threaded applications. Before we go into the details of object creation and destruction, we need to have a closer look what we mean by the terms "life cycle" and "object" in this context.

Object life cycle refers to the act of creation and destruction of objects. For example, with our [file system](#) application, we may start out with an empty file system that only contains a root directory. Over time, clients (by as yet unspecified means) add new directories and files to the file system. For example, a client might create a new directory called `MyPoems` underneath the root directory. Some time later, the same or a different client might decide to remove this directory again, returning the file system to its previous empty state. This pattern of creation and destruction is known as object life cycle.

The life cycle of distributed objects raises a number of interesting and challenging questions. For example, what should happen if a client destroys a file while another client is reading or writing that file? And how do we prevent two files with the same name from existing in the same directory? Another interesting scenario is illustrated by the following sequence of events:

1. Client A creates a file called `DraftPoem` in the root directory and uses it for a while.
2. Some time later, client B destroys the `DraftPoem` file so it no longer exists.
3. Some time later still, client C creates a new `DraftPoem` file in the root directory, with different contents.
4. Finally, client A attempts to access the `DraftPoem` file it created earlier.

What should happen when, in the final step, client A tries to use the `DraftPoem` file? Should the client's attempt succeed and simply operate on the new contents of the file that were placed there by client C? Or should client A's attempt fail because, after all, the new `DraftPoem` file is, in a sense, a completely different file from the original one, even though it has the same name?

The answers to such questions cannot be made in general. Instead, meaningful answers depend on the semantics that each individual application attaches to object life cycle. In this chapter, we will explore the various possible interpretations and how to implement them correctly, particularly for threaded applications.

See Also

- [Slice for a Simple File System](#)

Object Existence and Non-Existence

Before we talk about how to create and destroy objects, we need to look at a more basic concept, namely that of object existence. What does it mean for an object to "exist" and, more fundamentally, what do we mean by the term "object"?

As mentioned in [Ice Objects](#), an *Ice object* is a conceptual entity, or abstraction that does not really exist. On the client side, the concrete representation of an Ice object is a proxy and, on the server side, the concrete representation of an Ice object is a servant. Proxies and servants are the concrete programming-language artifacts that represent Ice objects.

Because Ice objects are abstract, conceptual entities, they are invisible to the Ice run time and to the application code — only proxies and servants are real and visible. It follows that, to determine whether an *Ice object* exists, any determination must rely on proxies and servants, because they are the only tangible entities in the system.

On this page:

- [Object Non-Existence](#)
- [Object Existence](#)
- [Indeterminate Object State](#)
- [Authoritative Object Existence Semantics](#)

Object Non-Existence

Here is the definitive statement of what it means for an Ice object to *not* exist:

An Ice object does not exist if an invocation on the object raises an `ObjectNotExistException`.

This may seem self-evident but, on closer examination, is a little more subtle than you might expect. In particular, Ice object existence has meaning *only within the context of a particular invocation*. If that invocation raises `ObjectNotExistException`, the object is known to not exist. Note that this says nothing about whether concurrent or future requests to that object will also raise `ObjectNotExistException` — they may or may not, depending on the semantics that are implemented by the application.

Also note that, because all the Ice run time knows about are servants, an `ObjectNotExistException` really indicates that a *servant* for the request could not be found at the time the request was made. This means that, ultimately, it is the application that attaches the meaning "the Ice object does not exist" to this exception.

In theory, the application can attach any meaning it likes to `ObjectNotExistException` and a server can throw this exception for whatever reason it sees fit; in practice, however, we recommend that you do not do this because it breaks with existing convention and is potentially confusing. You should reserve this exception for its intended meaning and not abuse it for other purposes.

Object Existence

The preceding definition does not say anything about object existence if something other than `ObjectNotExistException` is returned in response to a particular request. So, here is the definitive statement of what it means for an Ice object to exist:

An Ice object exists if a twoway invocation on the object either succeeds, raises a user exception, or raises `FacetNotExistException` or `OperationNotExistException`.

It is self-evident that an Ice object exists if a twoway invocation on it succeeds: obviously, the object received the invocation, processed it, and returned a result. However, note the qualification: this is true only for *twoway* invocations; for *oneway* and *datagram* invocations, nothing can be inferred about the existence of the corresponding Ice object by invoking an operation on it: because there is no reply from the server, the client-side Ice run time has no idea whether the request was dispatched successfully in the server or not. This includes user exceptions, `ObjectNotExistException`, `FacetNotExistException`, and `OperationNotExistException` — these exceptions are never raised by oneway and datagram invocations, regardless of the actual state of the target object.

If a twoway invocation raises a user exception, the Ice object obviously exists: the Ice run time never raises user exceptions so, for an invocation to raise a user exception, the invocation was dispatched successfully in the server, and the operation implementation in the servant raised the exception.

If a twoway invocation raises `FacetNotExistException`, we do know that the corresponding Ice object indeed exists: the Ice run time raises `FacetNotExistException` only if it can find the identity of the target object in the [Active Servant Map \(ASM\)](#), but cannot find the *facet* that was specified by the client.

i Note that, if you use [servant locators](#), for these semantics to hold, your servant locator must correctly raise `FacetNotExistException` in the `locate` operation (instead of returning null or raising `ObjectNotExistException`) if an Ice object exists, but the particular target facet does not exist.

As a corollary to the preceding two definitions, we can state:

A facet does not exist if a twoway invocation on the object raises `ObjectNotExistException` or `FacetNotExistException`.

A facet exists if a twoway invocation on the object either succeeds, or raises `OperationNotExistException`.

These definitions simply capture the fact that a facet is a "sub-object" of an Ice object: if an invocation raises `ObjectNotExistException`, we know that the facet does not exist either because, for a facet to exist, its Ice object must exist.

If an operation raises `OperationNotExistException`, we know that both the target Ice object and the target facet exist. However, the operation that the client attempted to invoke does not. (This is possible only if you use [dynamic invocation](#) or if you have mis-matched Slice definitions for client and server.)

Indeterminate Object State

The preceding definitions clearly state under what circumstances we can conclude that an Ice object (or its facet) does or does not exist. However, the preceding definitions are incomplete because operation invocations can have outcomes other than success or failure with `ObjectNotExistException`, `FacetNotExistException`, or `OperationNotExistException`. For example, a client might receive a `MarshalException`, `UnknownLocalException`, `UnknownException`, or `TimeoutException`. In that case, the client cannot draw any conclusions about whether the Ice object on which it invoked a twoway operation exists or not — the exceptions simply indicate that something went wrong while the invocation was processed. So, to complete our definitions, we can state:

If a twoway invocation raises a run-time exception other than `ObjectNotExistException`, `FacetNotExistException`, or `OperationNotExistException`, nothing is known about the existence or non-existence of the Ice object that was the target of the invocation. Furthermore, it is impossible to determine the state of existence of an Ice object with a oneway or datagram invocation.

Authoritative Object Existence Semantics

The preceding definitions capture the fact that, to make a determination of object existence or non-existence, the client-side Ice run time must be able to contact the server and, moreover, receive a reply from the server:

- If the server can be contacted and returns a successful reply for an invocation, the Ice object exists.
- If the server can be contacted and returns an `ObjectNotExistException` (or `FacetNotExistException`), the Ice object (or facet) does not exist. If the server returns an `OperationNotExistException`, the Ice object (and its facet) exists, but does not provide the requested operation, which indicates a type mismatch due to client and server using out-of-sync Slice definitions or due to incorrect use of dynamic invocation.
- If the server cannot be contacted, does not return a reply (as for oneway and datagram invocations), or if anything at all goes wrong with the process of sending an invocation, processing it in the server, and returning the reply, nothing is known about the state of the Ice object, including its existence or non-existence.

Another way of looking at this is that a decision as to whether an object exists or not is *never* made by the Ice run time and, instead, is *always* made by the server-side *application* code:

- If an invocation completes successfully, the server-side application code was involved because it processed the invocation.
- If an invocation returns `ObjectNotExistException` or `FacetNotExistException`, the server-side application code was also involved:
 - either the Ice run time could not find a servant for the invocation in the ASM, in which case the application code was involved by virtue of not having added a servant to the ASM in the first place, or
 - the Ice run time consulted a servant locator that explicitly returned null or raised `ObjectNotExistException` or `FacetNotExistException`.

This means that `ObjectNotExistException` and `FacetNotExistException` are *authoritative*: when you receive these exceptions, you can always believe what they tell you — the Ice run time never raises these exceptions without consulting your code, either implicitly (via an ASM lookup) or explicitly (by calling a servant locator's `locate` operation).

These semantics are motivated by the need to keep the Ice run time stateless with respect to object existence. For example, it would be nice to have stronger semantics, such as a promise that "once an Ice object has existed and been destroyed, all future requests to that Ice object also raise `ObjectNotExistException`". However, to implement these semantics, the Ice run time would have to remember all object identities that were used in the past, and prevent their reuse for new Ice objects. Of course, this would be inherently non-scalable. In addition, it would prevent applications from controlling object identity; allowing such control for applications is important however, for example, to link the identity of an Ice object to its [persistent state](#) in a database.

Note that, if the implementation of an operation calls another operation, dealing with `ObjectNotExistException` may require some care. For example, suppose that the client holds a proxy to an object of type `Service` and invokes an operation `provideService` on it:

```

C++

ServicePrx service = ...;

try {
    service->provideService();
} catch (const ObjectNotExistException&) {
    // Service does not exist.
}

```

Here is the implementation of `provideService` in the server, which makes a call on a helper object to implement the operation:

```

C++

void
ServiceI::provideService(const Ice::Current&)
{
    // ...
    proxyToHelper->someOp();
    // ...
}

```

If `proxyToHelper` happens to point at an object that was destroyed previously, the call to `someOp` will throw `ObjectNotExistException`. If the implementation of `provideService` does not intercept this exception, the exception will propagate all the way back to the client, who will conclude that the service has been destroyed when, in fact, the service still exists but the helper object used to implement `provideService` no longer exists.

Usually, this scenario is not a serious problem. Most often, the helper object cannot be destroyed while it is needed by `provideService` due to the way the application is structured. In that case, no special action is necessary because `someOp` will never throw `ObjectNotExistException`. On the other hand, if it is possible for the helper object to be destroyed, `provideService` can wrap a try-catch block for `ObjectNotExistException` around the call to `someOp` and throw an appropriate user exception from the exception handler (such as `ResourceUnavailable` or similar).

See Also

- [Terminology](#)
- [Servant Locators](#)
- [Oneway Invocations](#)
- [Datagram Invocations](#)

- [Facets and Versioning](#)
- [Dynamic Ice](#)
- [Freeze](#)

Life Cycle of Proxies, Servants, and Ice Objects

It is important to be aware of the different roles of proxies, servants, and Ice objects in a system. Proxies are the client-side representation of Ice objects and servants are the server-side representation of Ice objects. Proxies, servants, and Ice objects have completely independent life cycles. Clients can create and destroy proxies with or without a corresponding servant or Ice object in existence, servers can create and destroy servants with or without a corresponding proxy or Ice object in existence and, most importantly, Ice objects can exist or not exist regardless of whether corresponding proxies or servants exist. Here are a few examples to illustrate this:

```

C++

{
    Ice::ObjectPtr obj
= communicator->stringToProxy("hello:tcp ?p 10000");
    // Proxy exists now.

} // Proxy ceases to exist.
```

This code creates a proxy to an Ice object with the identity `Hello`. The server for this Ice object is expected to listen for invocations on the same host as the client, on port 10000, using the TCP/IP protocol. The proxy exists as soon as the call to `stringToProxy` completes and, thereafter, can be used by the client to make invocations on the corresponding Ice object.

However, note that this code says nothing at all about whether or not the corresponding Ice object exists. In particular, there might not be any Ice object with the identity `Hello`. Or there might be such an object, but the server for it may be down or unreachable. It is only when the client makes an invocation on the proxy that we get to find out whether the object exists, does not exist, or cannot be reached.

Similarly, at the end of the scope enclosing the `obj` variable in the preceding code, the proxy goes out of scope and is destroyed. Again, this says nothing about the state of the corresponding Ice object or its servant. This shows that the life cycle of a proxy is completely independent of the life cycle of its Ice object and the servant for that Ice object: clients can create and destroy proxies whenever they feel like it, and doing so has no implications for Ice objects or servant creation or destruction.

Here is another code example, this time for the server side:

```

C++

{
    FileIPtr file = new FileI("DraftPoem", root);
    // Servant exists now.

} // Servant ceases to exist.
```

Here, the server instantiates a servant for a `File` object by creating a `FileI` instance. The servant comes into being as soon as the call to `new` completes and ceases to exist as soon as the scope enclosing the `file` variable closes. Note that, as for proxies, the life cycle of the servant is completely independent of the life cycle of proxies and Ice objects. Clearly, the server can create and destroy a servant regardless of whether there are any proxies in existence for the corresponding Ice object.

Similarly, an Ice object can exist even if no servants exist for it. For example, our Ice objects might be persistent and stored in a database; in that case, if we switch off the server for our Ice objects, no servants exist for these Ice objects, even though the Ice objects continue to exist — the Ice objects are temporarily inaccessible, but exist regardless and, once their server is restarted, will become accessible again.

Conversely, a servant can exist without its corresponding Ice object. The mere creation of a servant does nothing, as far as the Ice run time is concerned. It is only once a servant is added to the [Active Servant Map \(ASM\)](#) (or a [servant locator](#) returns the servant from `locate`) that the servant incarnates its Ice object.

Finally, an Ice object can exist independently of proxies and servants. For example, returning to the database example, we might have an

Ice server that acts as a front end to an online telephone book: each entry in the phone book corresponds to a separate Ice object. When a client invokes an operation, the server uses the [identity](#) of the incoming request to determine which Ice object is the target of the request and then contacts the back-end database to, for example, return the street address of the entry. With such a design, entries can be added to and removed from the back-end database quite independently of what happens to proxies and servants — the server finds out whether an Ice object exists only when it accesses the back-end database.

The only time that the life cycle of an Ice object and a servant are linked is during an invocation on that Ice object: for an invocation to complete successfully, a servant must exist for the *duration of the invocation*. What happens to the servant thereafter is irrelevant to clients and, in general, is irrelevant to the corresponding Ice object.

It is important to be clear about the independence of the life cycles of proxies, servants, and Ice objects because this independence has profound implications for how you need to implement object life cycle. In particular, to destroy an Ice object, a client cannot simply destroy its proxy for an object because the server is completely unaware when a client does this.



Distributed object systems such as DCOM implement these semantics. However, this design is inherently non-scalable because of the cost of globally tracking proxy creation and destruction.

See Also

- [The Active Servant Map](#)
- [Servant Locators](#)
- [Object Identity](#)

Object Creation

Now that we understand what it means for an Ice object to exist, we can look at what is involved in creating an Ice object. Fundamentally, there is only one way for an Ice object to come into being: the server must instantiate a servant for the object and add an entry for that servant to the [Active Servant Map](#) (ASM) (or, alternatively, arrange for a [servant locator](#) to return a servant from its `locate` operation).

i For the remainder of this chapter, we will ignore the distinction between using the ASM and a servant locator and simply assume that the code uses the ASM. This is because servant locators do not alter the discussion: if `locate` returns a servant, that is the same as a successful lookup in the ASM; if `locate` returns null or throws `ObjectNotExistException`, that is the same as an unsuccessful lookup in the ASM.

One obvious way for a server to create a servant is to, well, simply instantiate it and add it to the ASM of its own accord. For example:

C++

```
DirectoryIPtr root = new DirectoryI("/", 0);
adapter?>addWithUUID(root); // Ice object exists now
```

The servant exists as soon as the call to `new` completes, and the Ice object exists as soon as the code adds the servant to the ASM: at that point, the Ice object becomes reachable to clients who hold a proxy to it.

This is the way we created Ice objects for our file system application earlier in the manual. However, doing so is not all that interesting because the only files and directories that exist are those that the server decides to create when it starts up. What we really want is a way for *clients* to create and destroy directories and files.

On this page:

- [Creating an Object with a Factory](#)
- [Implementing a Factory Operation](#)

Creating an Object with a Factory

The canonical way to create an object is to use the factory pattern [1]. The factory pattern, in a nutshell, says that objects are created by invoking an operation (usually called `create`) on an object factory:

Slice

```
interface PhoneEntry {
    idempotent string name();
    idempotent string getNumber();
    idempotent void setNumber(string phNum);
};

exception PhoneEntryExists {
    string name;
    string phNum;
};

interface PhoneEntryFactory {
    PhoneEntry* create(string name, string phNum)
        throws PhoneEntryExists;
};
```



Rather than continue with the file system example, we will simplify the discussion for the time being by using the phone book example mentioned earlier; we will return to the file system application to explore [more complex issues](#).

The entries in the phone book consist of simple name-number pairs. The interface to each entry is called `PhoneEntry` and provides operations to read the name and to read and write the phone number. (For a real application, the objects would likely be more complex and encapsulate more state. However, these simple objects will do for the purposes of this discussion.)

To create a new entry, a client calls the `create` operation on a `PhoneEntryFactory` object. (The factory is a singleton object [1] — that is, only one instance of that interface exists in the server.) It is the job of `create` to create a new `PhoneEntry` object, using the supplied name as the [object identity](#).

An immediate consequence of using the name as the object identity is that `create` can raise a `PhoneEntryExists` exception: presumably, if a client attempts to create an entry with the same name as an already-existing entry, we need to let the client know about this. (Whether this is an appropriate design is something we examine more closely in [Object Identity and Uniqueness](#).)

`create` returns a proxy to the newly-created object, so the client can use that proxy to invoke operations. However, this is by convention only. For example, `create` could be a `void` operation if the client has some other way to eventually get a proxy to the new object (such as creating the proxy from a string, or locating the proxy via a search operation). Alternatively, you could define "bulk" creation operations that allow clients to create several new objects with a single RPC. As far as the Ice run time is concerned, there is nothing special about a factory operation: a factory operation is just like any other operation; it just so happens that a factory operation creates a new Ice object as a side effect of being called, that is, the *implementation* of the operation is what creates the object, not the Ice run time.

Also note that `create` accepts a `name` and a `phNum` parameter, so it can initialize the new object. This is not compulsory, but generally a good idea. An alternate factory operation could be:

Slice

```
interface PhoneEntryFactory {
    PhoneEntry* create(string name)
        throws PhoneEntryExists;
};
```

With this design, the assumption is that the client will call `setNumber` after it has created the object. However, in general, allowing objects

that are not fully initialized is a bad idea: it all too easily happens that a client either forgets to complete the initialization, or happens to crash or get disconnected before it can complete the initialization. Either way, we end up with a partially-initialized object in the system that can cause surprises later.



This is the approach taken by COM's `CoCreateObject`, which suffers from just that problem.

Similarly, so-called `generic` factories are also something to be avoided:

Slice

```
dictionary<string, string> Params;

exception CannotCreateException {
    string reason;
};

interface GenericFactory {
    Object* create(Params p)
        throws CannotCreateException;
};
```

The intent here is that a `GenericFactory` can be used to create any kind of object; the `Params` dictionary allows an arbitrary number of parameters to be passed to the `create` operation in the form of name — value pairs, for example:

C++

```
GenericFactoryPrx factory = ...;

Ice::ObjectPrx obj;
Params p;

// Make a car.
//
p["Make"] = "Ford";
p["Model"] = "Falcon";
obj = factory->create(p);
CarPrx car = CarPrx::checkedCast(obj);

// Make a horse.
//
p.clear();
p["Breed"] = "Clydesdale";
p["Sex"] = "Male";
obj = factory->create(p);
HorsePrx horse = HorsePrx::checkedCast(obj);
```

We strongly discourage you from creating factory interfaces such as this, unless you have a good overriding reason: generic factories undermine type safety and are much more error-prone than strongly-typed factories.

Implementing a Factory Operation

The implementation of an object factory is simplicity itself. Here is how we could implement the `create` operation for our `PhoneEntryFactory`:

```

C++

PhoneEntryPrx
PhoneEntryFactory::create(const string& name, const string& phNum,
const Current& c)
{
    try {
        CommunicatorPtr comm = c.adapter.getCommunicator();
        PhoneEntryPtr servant = new PhoneEntryI(name, phNum);
        return PhoneEntryPrx::uncheckedCast(c.adapter?>add(servant,
comm?>stringToIdentity(name)));
    } catch (const Ice::AlreadyRegisteredException&) {
        throw PhoneEntryExists(name, phNum);
    }
}

```

The `create` function instantiates a new `PhoneEntryI` object (which is the servant for the new `PhoneEntry` object), adds the servant to the ASM, and returns the proxy for the new object. Adding the servant to the ASM is what creates the new Ice object, and client requests are dispatched to the new object as soon as that entry appears in the ASM (assuming the `object adapter` is active).

Note that, even though this code contains no explicit lock, it is thread-safe. The `add` operation on the object adapter is atomic: if two clients concurrently add a servant with the same identity, exactly one thread succeeds in adding the entry to the ASM; the other thread receives an `AlreadyRegisteredException`. Similarly, if two clients concurrently call `create` for different entries, the two calls execute concurrently in the server (if the server is multi-threaded); the implementation of `add` in the Ice run time uses appropriate locks to ensure that concurrent updates to the ASM cannot corrupt anything.

See Also

- [The Active Servant Map](#)
- [Servant Locators](#)
- [Object Identity](#)
- [Object Identity and Uniqueness](#)
- [Object Life Cycle for the File System Application](#)
- [Object Adapter States](#)
- [Servant Activation and Deactivation](#)

References

1. Gamma, E., et al. 1994. [Design Patterns](#). Reading, MA: Addison-Wesley.

Object Destruction

Now that clients can create `PhoneEntry` objects, let us consider how to allow clients to destroy them again. One obvious design is to add a `destroy` operation to the factory — after all, seeing that a factory knows how to create objects, it stands to reason that it also knows how to destroy them again:

Slice
<pre> exception PhoneEntryNotExists { string name; string phNum; }; interface PhoneEntryFactory { PhoneEntry* create(string name, string phNum) throws PhoneEntryExists; void destroy(PhoneEntry* pe) // Bad idea! throws PhoneEntryNotExists; }; </pre>

While this works (and certainly can be implemented without problems), it is generally a bad idea. For one, an immediate problem we need to deal with is what should happen if a client passes a proxy to an already-destroyed object to `destroy`. We could raise an `ObjectNotExistException` to indicate this, but that is not a good idea because it makes it ambiguous as to which object does not exist: the factory, or the entry. (By convention, if a client receives an `ObjectNotExistException` for an invocation, what does not exist is the object the operation was targeted at, not some other object that in turn might be contacted by the operation.) This forces us to add a separate `PhoneEntryNotExists` exception to deal with the error condition, which makes the interface a little more complex.

A second and more serious problem with this design is that, in order to destroy an entry, the client must not only know which entry to destroy, but must also know *which factory created the entry*. For our example, with only a single factory, this is not a real concern. However, for more complex systems with dozens of factories (possibly in multiple server processes), it rapidly becomes a problem: for each object, the application code somehow has to keep track of which factory created what object; if any part of the code ever loses track of where an object originally came from, it can no longer destroy that object.

Of course, we could mitigate the problem by adding an operation to the `PhoneEntry` interface that returns a proxy to its factory. That way, clients could ask each object to provide the factory that created the object. However, that needlessly complicates the `Slice` definitions and really is just a band-aid on a fundamentally flawed design. A much better choice is to add the `destroy` operation to the `PhoneEntry` interface instead:

Slice
<pre> interface PhoneEntry { idempotent string name(); idempotent string getNumber(); idempotent void setNumber(string phNum); void destroy(); }; </pre>

With this approach, there is no need for clients to somehow keep track of which factory created what object. Instead, given a proxy to a `PhoneEntry` object, a client simply invokes the `destroy` operation on the object and the `PhoneEntry` obligingly commits suicide. Note that we also no longer need a separate exception to indicate the "object does not exist" condition because we can raise `ObjectNotExistException` instead — the exception exists precisely to indicate this condition and, because `destroy` is now an operation on the phone entry itself, there is no ambiguity about which object it is that does not exist.

Topics

- [Idempotency and Life Cycle Operations](#)
- [Implementing a destroy Operation](#)
- [Cleaning Up a Destroyed Servant](#)
- [Life Cycle and Collection Operations](#)
- [Life Cycle and Normal Operations](#)

See Also

- [Object Creation](#)

Idempotency and Life Cycle Operations

You may be tempted to write the life cycle operations as follows:

Slice
<pre>interface PhoneEntry { // ... idempotent void destroy(); // Wrong! }; interface PhoneEntryFactory { idempotent PhoneEntry* create(string name, string phNum) throws PhoneEntryExists; };</pre>

The idea is that `create` and `destroy` can be [idempotent operations](#) because it is safe to let the Ice run time retry the operation in the event of a temporary network failure. However, this assumption is not true. To see why, consider the following scenario:

1. A client invokes `destroy` on a phone entry.
2. The Ice run time sends the request to the server on the wire.
3. The connection goes down just after the request was sent, but before the reply for the request arrives in the client. It so happens that the request was received by the server and acted upon, and the reply from the server back to the client is lost because the connection is still down.
4. The Ice run time tries to read the reply for the request and realizes that the connection has gone down. Because the operation is marked idempotent, the run time attempts an [automatic retry](#) by re-establishing the connection and sending the request a second time, which happens to work.
5. The server receives the request to destroy the entry but, because the entry is destroyed already, the server returns an `ObjectNotExistException` to the client, which the Ice run time passes to the application code.
6. The application receives an `ObjectNotExistException` and falsely concludes that it tried to destroy a non-existent object when, in fact, the object did exist and was destroyed as intended.

A similar scenario can be constructed for `create`: in that case, the application will receive a `PhoneEntryExists` exception when, in fact, the entry did not exist and was created successfully.

These scenarios illustrate that `create` and `destroy` are *never* idempotent: sending one `create` or `destroy` invocation for a particular object is not the same as sending two invocations: the outcome depends on whether the first invocation succeeded or not, so `create` and `destroy` are not idempotent.

See Also

- [Idempotent Operations](#)
- [Automatic Retries](#)

Implementing a destroy Operation

As far as the Ice run time is concerned, the act of destroying an Ice object is to remove the mapping between its proxy and its servant. In other words, an Ice object is destroyed when we remove its entry from the [Active Servant Map](#) (ASM). Once the ASM entry is gone, incoming operations for the object raise `ObjectNotExistException`, as they should.

On this page:

- [Object Destruction and Concurrency](#)
- [Concurrent Execution of Life Cycle and Non-Life Cycle Operations](#)

Object Destruction and Concurrency

Here is the simplest version of `destroy`:

```

C++

void
PhoneEntryI::destroy(const Current& c)
{
    try {
        c.adapter?>remove(c.id);
    } catch (const Ice::NotRegisteredException&)
        throw Ice::ObjectNotExistException(__FILE__, __LINE__);
}

```

The implementation removes the ASM entry for the servant, thereby destroying the Ice object. If the entry does not exist (presumably, because the object was destroyed previously), `destroy` throws an `ObjectNotExistException`, as you would expect.

The ASM entry is removed as soon as `destroy` calls `remove` on the object adapter. Assuming that we implement `create` as we saw earlier, so no other part of the code retains a smart pointer to the servant, this means that the ASM holds the only smart pointer to the servant, so the servant's reference count is 1.



We use [smart pointers](#) in C++, which are analogous to object references in languages such as Java and C#.

Once the ASM entry is removed (and its smart pointer destroyed), the reference count of the servant drops to zero. In C++, this triggers a call to the destructor of the servant, and the heap-allocated servant is deleted just as it should be; in languages such as Java and C#, this makes the servant eligible for garbage collection, so it will be deleted eventually as well.

Things get more interesting if we consider concurrent scenarios. One such scenario involves concurrent calls to `create` and `destroy`. Suppose we have the following sequence of events:

1. Client A creates a phone entry.
2. Client A passes the proxy for the entry to client B.
3. Client A destroys the entry.
4. Client A calls `create` for the same entry (passing the same name, which serves as the [object identity](#)) and, concurrently, client B calls `destroy` on the entry.

Clearly, something is strange about this scenario, because it involves two clients asking for conflicting things, with one client trying to create an object that existed previously, while another client tries to destroy the object that — unbeknownst to that client — was destroyed earlier.

Exactly what is seen by client A and client B depends on how the operations are dispatched in the server. In particular, the outcome depends on the order in which the [calls on the object adapter](#) to add (in `create`) and `remove` (in `destroy`) on the servant are executed:

- If the thread processing client A's invocation executes `add` before the thread processing client B's invocation, client A's call to `add` succeeds. Internally, the calls to `add` and `remove` are serialized, and client B's call to `remove` blocks until client A's call to `add` has

completed. The net effect is that both clients see their respective invocations complete successfully.

- If the thread processing client B's invocation executes `remove` before the thread processing client A's invocation executes `add`, client B's thread receives a `NotRegisteredException`, which results in an `ObjectNotExistException` in client B. Client A's thread then successfully calls `add`, creating the object and returning its proxy.

This example illustrates that, if life cycle operations interleave in this way, the outcome depends on thread scheduling. However, as far as the Ice run time is concerned, doing this is perfectly safe: concurrent access does not cause problems for memory management or the integrity of data structures.

The preceding scenario allows two clients to attempt to perform conflicting operations. This is possible because clients can control the object identity of each phone entry: if the object identity were hidden from clients and assigned by the server (the server could assign a UUID to each entry, for example), the above scenario would not be possible. We will return to a more detailed discussion of such object identity issues in [Object Identity and Uniqueness](#).

Concurrent Execution of Life Cycle and Non-Life Cycle Operations

 This section applies to C++ only.

Another scenario relates to concurrent execution of ordinary (non-life cycle) operations and `destroy`:

- Client A holds a proxy to an existing object and passes that proxy to client B.
- Client B calls the `setNumber` operation on the object.
- Client A calls `destroy` on the object *while Client B's call to `setNumber` is still executing*.

The immediate question is what this means with respect to memory management. In particular, client A's thread calls `remove` on the object adapter while client B's thread is still executing inside the object. If this call to `remove` were to delete the servant immediately, it would delete the servant while client B's thread is still executing inside the servant, with potentially disastrous results.

The answer is that this cannot happen. Whenever the Ice run time dispatches an incoming invocation to a servant, it increments the servant's reference count for the duration of the call, and decrements the reference count again once the call completes. Here is what happens to the servant's reference count for the preceding scenario:

1. Initially, the servant is idle, so its reference count is at least 1 because the ASM entry stores a smart pointer to the servant. (The remainder of these steps assumes that the ASM stores the *only* smart pointer to the servant, so the reference count is exactly 1.)
2. Client B's invocation of `setNumber` arrives and the Ice run time increments the reference count to 2 before dispatching the call.
3. While `setNumber` is still executing, client A's invocation of `destroy` arrives and the Ice run time increments the reference count to 3 before dispatching the call.
4. Client A's thread calls `remove` on the object adapter, which destroys the smart pointer in the ASM and so decrements the reference to 2.
5. Either `setNumber` or `destroy` may complete first. It does not matter which call completes — either way, the Ice run time decrements the reference count as the call completes, so after one of these calls completes, the reference count drops to 1.
6. Eventually, when the final call (`setNumber` or `destroy`) completes, the Ice run time decrements the reference count once again, which causes the count to drop to zero. In turn, this triggers the call to `delete` (which calls the servant's destructor).

The net effect is that, while operations are executing inside a servant, the servant's reference count is always greater than zero. As the invocations complete, the reference count drops until, eventually, it reaches zero. However, that can only happen once no operations are executing, that is, once the servant is idle. This means that the Ice run time guarantees that a servant's destructor runs only once the final operation invocation has drained out of the servant, so it is impossible to "pull memory out from underneath an executing invocation".

 For garbage-collected languages, such as C# and Java, the language run time provides the same semantics: while the servant can be reached via any reference in the application or the Ice run time, the servant will not be reclaimed by the garbage collector.

See Also

- [The Active Servant Map](#)
- [Object Identity and Uniqueness](#)
- [Servant Activation and Deactivation](#)

Cleaning Up a Destroyed Servant

Here is a very simple implementation of our `PhoneEntryI` servant. (Methods are inlined for convenience only. Also note that, for the time being, this code ignores concurrency issues, which we return to in [Life Cycle and Normal Operations](#).)

```

C++

class PhoneEntryI : public PhoneEntry {
public:
    PhoneEntryI(const string& name, const string& phNum)
        : _name(name), _phNum(phNum)
    {
    }

    virtual string
    name(const Current&) {
        return _name;
    }

    virtual string
    getNumber(const Current&) {
        return _phNum;
    }

    virtual void
    setNumber(const string& phNum, const Current&) {
        _phNum = phNum;
    }

    virtual void
    destroy(const Current& c) {
        try {
            c.adapter?>remove(c.id);
        } catch (const Ice::NotRegisteredException&)
            throw Ice::ObjectNotExistException(__FILE__, __LINE__);
    }

private:
    const string _name;
    string _phNum;
};
```

With this servant, `destroy` does just the right thing: it calls `delete` on the servant once the servant is idle, which in turn calls the destructor, so the memory used by the `_name` and `_phNum` data members is reclaimed.

However, real servants are rarely this simple. In particular, destruction of an Ice object may involve non-trivial actions, such as flushing a file, committing a transaction, making a remote call on another object, or updating a hardware device. For example, instead of storing the details of a phone entry in member variables, the servant could be implemented to store the details in a file; in that case, destroying the Ice object would require closing the file. Seeing that the Ice run time calls the destructor of a servant only once the servant becomes idle, the destructor would appear to be an ideal place to perform such actions, for example:

C++

```

class PhoneEntryI : public PhoneEntry {
public:
    // ...

    ~PhoneEntryI()
    {
        _myStream.close(); // Bad idea
    }

private:
    fstream _myStream;
};

```

The problem with this code is that it can fail, for example, if the file system is full and buffered data cannot be written to the file. Such clean-up failure is a general issue for non-trivial servants: for example, a transaction can fail to commit, a remote call can fail if the network goes down, or a hardware device can be temporarily unresponsive.

If we encounter such a failure, we have a serious problem: we cannot inform the client of the error because, as far as the client is concerned, the `destroy` call completed just fine. The client will therefore assume that the Ice object was correctly destroyed. However, the system is now in an inconsistent state: the Ice object was destroyed (because its ASM entry was removed), but the object's state still exists (possibly with incorrect values), which can cause errors later.

Another reason for avoiding such state clean-up in C++ destructors is that destructors cannot throw exceptions: if they do, and do so in the process of being called during unwinding of the stack due to some other exception, the program goes directly to `terminate` and does not pass "Go". (There are a few exotic cases in which it is possible to throw from a destructor and get away with it but, in general, is an excellent idea to maintain the no-throw guarantee for destructors.) So, if anything goes wrong during destruction, we are in a tight spot: we are forced to swallow any exception that might be encountered by the destructor, and the best we can do is log the error, but not report it to the client.

Finally, using destructors to clean up servant state does not port well to languages such as Java and C#. For these languages, similar considerations apply to error reporting from a finalizer and, with Java, finalizers may not run at all. Therefore, we recommend that you perform any clean-up actions in the body of `destroy` instead of delaying clean-up until the servant's destructor runs.

Note that the foregoing does *not* mean that you cannot reclaim servant resources in destructors; after all, that is what destructors are for. But it *does* mean that you should not try to reclaim resources from a destructor if the attempt can fail (such as deleting records in an external system as opposed to, for example, deallocating memory or adjusting the value of variables in your program).

See Also

- [Life Cycle and Normal Operations](#)

Life Cycle and Collection Operations

On this page:

- [Factories and Collection Operations](#)
- [Cyclic Dependencies between Factories and Objects](#)

Factories and Collection Operations

The factory we defined [earlier](#) is what is known as a *pure* object factory because `create` is the only operation it provides. However, it is common for factories to do double duty and also act as collection managers that provide additional operations, such as `list` and `find`:

```

Slice

// ...

sequence<PhoneEntry*> PhoneEntries;

interface PhoneEntryFactory {
    PhoneEntry* create(string name, string phNum)
        throws PhoneEntryExists;

    idempotent PhoneEntry find(string name);
    idempotent PhoneEntries list();
};

```

`find` returns a proxy for the phone entry with the given name, and a null proxy if no such entry exists. `list` returns a sequence that contains the proxies of all existing entries.

Here is a simple implementation of `find`:

```

C++

PhoneEntryPrx
PhoneEntryFactory::find(const string& name, const Current& c)
{
    CommunicatorPtr comm = c.adapter?>getCommunicator();

    PhoneEntryPrx pe;
    Identity id = comm?>stringToIdentity(name);
    if (c.adapter?>find(id)) {
        pe = PhoneEntryPrx::uncheckedCast(c.adapter?>createProxy(id));
    }
    return pe;
}

```

If an entry exists in the [Active Servant Map](#) (ASM) for the given name, the code creates a proxy for the corresponding Ice object and returns it. This code works correctly even for threaded servers: because the look?up of the identity in the ASM is atomic, there is no problem with other threads concurrently modifying the ASM (for example, while servicing calls from other clients to `create` or `destroy`).

Cyclic Dependencies between Factories and Objects

Unfortunately, implementing `list` is not as simple because it needs to iterate over the collection of entries, but the object adapter does not provide any iterator for ASM entries.

i The reason for this is that, during iteration, the ASM would have to be locked to protect it against concurrent access, but locking the ASM would prevent call dispatch during iteration and easily cause deadlocks.

Therefore, we must maintain our own list of entries inside the factory:

```

C++
class PhoneEntryFactoryI : public PhoneEntryFactory
{
public:
    // ...

    void remove(const string&, const ObjectAdapterPtr&) {
        IceUtil::Mutex::Lock lock(_namesMutex);

        set<string>::iterator i = _names.find(name);
        if (i != _names.end())
            _names.erase(i);
    }

private:
    IceUtil::Mutex _namesMutex;
    set<string> _names;
};
```

The idea is to have a set of names of existing entries, and to update that set in `create` and `destroy` as appropriate. However, for threaded servers, that raises a concurrency issue: if we have clients that can concurrently call `create`, `destroy`, and `list`, we need to interlock these operations to avoid corrupting the `_names` set (because STL containers are not thread-safe). This is the purpose of the mutex `_namesMutex` in the factory: `create`, `destroy`, and `list` can each lock this mutex to ensure exclusive access to the `_names` set.

Another issue is that our implementation of `destroy` must update the set of entries that is maintained by the factory. This is the purpose of the `remove` member function: it removes the specified name from the `_names` set (of course, under protection of the `_namesMutex` lock). However, `destroy` is a method on the `PhoneEntryI` servant, whereas `remove` is a method on the factory, so the servant must know how to reach the factory. Because the factory is a singleton, we can fix this by adding a static `_factory` member to the `PhoneEntryI` class:

C++

```

class PhoneEntryI : public PhoneEntry {
public:
    // ...

    static PhoneEntryFactoryIPtr _factory;

private:
    const string _name;
    string _phNum;
};

```

The code in `main` then creates the factory and initializes the static member variable, for example:

C++

```

PersonI::_factory = new PersonFactoryI;

// Add factory to ASM and activate object
// adapter here...

```

This works, but it leaves a bad taste in our mouth because it sets up a cyclic dependency between the phone entry servants and the factory: the factory knows about the servants, and each servant knows about the factory so it can call `remove` on the factory. In general, such cyclic dependencies are a bad idea: if nothing else, they make a design harder to understand.

We could remove the cyclic dependency by moving the `_names` set and its associated mutex into a separate class instance that is referenced from both `PhoneEntryFactoryI` and `PhoneEntryI`. That would get rid of the cyclic dependency as far as the C++ type system is concerned but, as we will see later, it would not really help because the factory and its servants turn out to be mutually dependent regardless (because of concurrency issues). So, for the moment, we'll stay with this design and examine better alternatives after we have explored the concurrency issues in more detail.

With this design, we can implement `list` as follows:

C++

```

PhoneEntries
PhoneEntryFactoryI::list(const Current& c)
{
    Mutex::Lock lock(_namesMutex);

    CommunicatorPtr comm = c.adapter?>getCommunicator();

    PhoneEntries pe;
    set<string>::const_iterator i;
    for (i = _names.begin(); i != _names.end(); ++i) {
        ObjectPrx o = c.adapter?>createProxy(comm?>stringToIdentity(name));
        pe.push_back(PhoneEntryPrx::uncheckedCast(o));
    }

    return pe;
}

```

Note that `list` acquires a lock on the mutex, to prevent concurrent modification of the `_names` set by `create` and `destroy`. In turn, our `create` implementation now also locks the mutex:

```

PhoneEntryPrx
PhoneEntryFactory::create(const string& name, const string& phNum,
const Current& c)
{
    Mutex::Lock lock(_namesMutex);

    PhoneEntryPrx pe;
    try {
        CommunicatorPtr comm = c.adapter?>getCommunicator();
        PhoneEntryPtr servant = new PhoneEntryI(name, phNum);
        pe = PhoneEntryPrx::uncheckedCast(c.adapter?>add(servant,
comm?>stringToIdentity(name)));
    } catch (const Ice::AlreadyRegisteredException&) {
        throw PhoneEntryExists(name, phNum);
    }
    _names.insert(name);

    return pe;
}

```

With this implementation, we are safe if `create` and `list` run concurrently: only one of the two operations can acquire the lock at a time, so there is no danger of corrupting the `_names` set.

`destroy` is now trivial to implement: it simply removes the ASM entry and calls `remove` on the factory:

C++

```
void
PhoneEntryI::destroy(const Current& c)
{
    // Note: not quite correct yet.
    c.adapter?>remove(_name);
    _factory?>remove(_name, c.adapter);
}
```

Note that this is not quite correct because we have not yet considered concurrency issues for destroy. We will consider this issue next.

See Also

- [Object Creation](#)
- [The Active Servant Map](#)

Life Cycle and Normal Operations

So far, we have mostly ignored the implementations of the `getNumber` and `setNumber` operations we defined in our discussion of [object creation](#). Obviously, `getNumber` and `setNumber` must be interlocked against concurrent access — without this interlock, concurrent requests from clients could result in one thread writing to the `_phNum` member while another thread is reading it, with unpredictable results. (Conversely, the `name` operation need not have an interlock because the name of a phone entry is immutable.) To interlock `getNumber` and `setNumber`, we can add a mutex `_m` to `PhoneEntryI`:

```

C++

class PhoneEntryI : public PhoneEntry {
public:
    // ...

    static PhoneEntryFactoryIPtr _factory;

private:
    const string _name;
    string _phNum;
    Mutex _m;
};
```

The `getNumber` and `setNumber` implementations then lock `_m` to protect `_phNum` from concurrent access:

C++

```

string
PhoneEntryI::name(const Current&)
{
    return _name;
}

string
PhoneEntryI::getNumber(const Current&)
{
    // Incorrect implementation!

    Mutex::Lock lock(_m);

    return _phNum;
}

void
PhoneEntryI::setNumber(const string& phNum, const Current&)
{
    // Incorrect implementation!

    Mutex::Lock lock(_m);

    _phNum = phNum;
}

```

This looks good but, as it turns out, `destroy` throws a spanner in the works: as shown, this code suffers from a rare, but real, race condition. Consider the situation where a client calls `destroy` at the same time as another client calls `setNumber`. In a server with a [thread pool](#) with more than one thread, the calls can be dispatched in separate threads and can therefore execute concurrently.

The following sequence of events can occur:

- The thread dispatching the `setNumber` call locates the servant, enters the operation implementation, and is suspended by the scheduler immediately on entry to the operation, before it can lock `_m`.
- The thread dispatching the `destroy` call locates the servant, enters `destroy`, successfully removes the servant from the [Active Servant Map \(ASM\)](#) and the `_names` set, and returns.
- The thread that was suspended in `setNumber` is scheduled again, locks `_m`, and now operates on a conceptually already-destroyed Ice object.

Note that, even if we lock `_m` in `destroy`, the problem persists:

C++

```

void
PhoneEntryI::destroy(const Current& c)
{
    // Note: still not correct.

    IceUtil::Mutex::Lock lock(_m);

    c.adapter?>remove(_name);
    _factory?>remove(_name, c.adapter);
}

```

Even though `destroy` now locks `_m` and so cannot run concurrently with `getNumber` and `setNumber`, the preceding scenario can still arise. The problem here is that a thread can enter the servant and be suspended before it gets a chance to acquire a lock. With the code as it stands, this is not a problem: `setNumber` will simply update the `_phNum` member variable in a servant that no longer has an ASM entry. In other words, the Ice object is already destroyed — it just so happens that the servant for that Ice object is still hanging around because there is still an operation executing inside it. Any updates to the servant will succeed (even though they are useless because the servant's `destruct` or `will run` as soon as the last invocation leaves the servant.)

Note that this scenario is not unique to C++ and can arise even with Java synchronized operations: in that case, a thread can be suspended just after the Ice run time has identified the target servant, but before it actually calls the operation on the target servant. While the thread is suspended, another thread can execute `destroy`.

While this race condition does not affect our implementation, it does affect more complex applications, particularly if the servant modifies external state, such as a file system or database. For example, `setNumber` could modify a file in the file system; in that case, `destroy` would delete that file and probably close a file descriptor or stream. If we were to allow `setNumber` to continue executing after `destroy` has already done its job, we would likely encounter problems: `setNumber` might not find the file where it expects it to be or try to use the closed file descriptor and return an error; or worse, `setNumber` might end up re-creating the file in the process of updating the already-destroyed entry's phone number. (What exactly happens depends on how we write the code for each operation.)

Of course, we can try to anticipate these scenarios and handle the error conditions appropriately, but doing this for complex systems with complex servants rapidly gets out of hand: in each operation, we would have to ask ourselves what might happen if the servant is destroyed concurrently and, if so, take appropriate recovery action.

It is preferable to instead deal with interleaved invocations of `destroy` and other operations in a systematic fashion. We can do this by adding a `_destroyed` member to the `PhoneEntryI` servant. This member is initialized to false by the constructor and set to true by `destroy`. On entry to every operation (including `destroy`), we lock the mutex, test the `_destroyed` flag, and throw `ObjectNotExistException` if the flag is set:

C++

```

class PhoneEntryI : public PhoneEntry {
public:
    // ...

    static PhoneEntryFactoryIPtr _factory;

private:
    const string _name;
    string _phNum;
    bool _destroyed;
}

```

```

    Mutex _m;
};

PhoneEntryI::PhoneEntryI(const string& name, const string& phNum)
    : _name(name), _phNum(phNum), _destroyed(false)
{
}

string
PhoneEntryI::name(const Current&)
{
    Mutex::Lock lock(_m);

    if (_destroyed)
        throw ObjectNotExistException(__FILE__, __LINE__);

    return _name;
}

string
PhoneEntryI::getNumber(const Current&)
{
    Mutex::Lock lock(_m);

    if (_destroyed)
        throw ObjectNotExistException(__FILE__, __LINE__);

    return _phNum;
}

void
PhoneEntryI::setNumber(const string& phNum, const Current&)
{
    Mutex::Lock lock(_m);

    if (_destroyed)
        throw ObjectNotExistException(__FILE__, __LINE__);

    _phNum = phNum;
}

void
PhoneEntryI::destroy(const Current& c)
{
    Mutex::Lock lock(_m);

    if (_destroyed)
        throw ObjectNotExistException(__FILE__, __LINE__);

    _destroyed = true;
}

```

```
c.adapter?>remove(_name);
```



```
    _factory?>remove(_name, c.adapter); // Dubious!  
}
```

If you are concerned about the repeated code on entry to every operation, you can put that code into a member function or base class to make it reusable (although the benefits of doing so are probably too minor to make this worthwhile).

Using the `_destroyed` flag, if an operation is dispatched and suspended before it can lock the mutex and, meanwhile, `destroy` runs to completion in another thread, it becomes impossible for an operation to operate on the state of such a "zombie" servant: the test on entry to each operation ensures that any operation that runs after `destroy` immediately raises `ObjectNotExistException`.

Also note the "dubious" comment in `destroy`: the operation first locks `_m` and, while holding that lock, calls `remove` on the factory, which in turn locks its own `_namesMutex`. This is not wrong as such, but as we will see shortly, it can easily lead to deadlocks if we modify the application later.

See Also

- [Object Creation](#)
- [The Active Servant Map](#)
- [Implementing a destroy Operation](#)
- [The Ice Threading Model](#)

Removing Cyclic Dependencies

We mentioned [earlier](#) that factoring the `_names` set and its mutex into a separate class instance does not really solve the cyclic dependency problem, at least not in general. To see why, suppose that we want to extend our factory with a new `getDetails` operation:

```

Slice



```

// ...

struct Details {
 PhoneEntry* proxy;
 string name;
 string phNum;
};

sequence<Details> DetailsSeq;

interface PhoneEntryFactory {
 // ...

 DetailsSeq getDetails();
};

```

```

This type of operation is common in collection managers: instead of returning a simple list of proxies, `getDetails` returns a sequence of structures, each of which contains not only the object's proxy, but also some of the state of the corresponding object. The motivation for this is performance: with a plain list of proxies, the client, once it has obtained the list, is likely to immediately follow up with one or more remote calls for each object in the list in order to retrieve their state (for example, to display the list of objects to the user). Making all these additional remote procedure calls is inefficient, and an operation such as `getDetails` gets the job done with a single RPC instead.

To implement `getDetails` in the factory, we need to iterate over the set of entries and invoke the `getNumber` operation on each object. (These calls are collocated and therefore very efficient, so they do not suffer the performance problem that a client calling the same operations would suffer.) However, this is potentially dangerous because the following sequence of events is possible:

- Client A calls `getDetails`.
- The implementation of `getDetails` must lock `_namesMutex` to prevent concurrent modification of the `_names` set during iteration.
- Client B calls `destroy` on a phone entry.
- The implementation of `destroy` locks the entry's mutex `_m`, sets the `_destroyed` flag, and then calls `remove`, which attempts to lock `_namesMutex` in the factory. However, `_namesMutex` is already locked by `getDetails`, so `remove` blocks until `_m` is unlocked again.
- `getDetails`, while iterating over its set of entries, happens to call `getNumber` on the entry that is currently being destroyed by client B. `getNumber`, in turn, tries to lock its mutex `_m`, which is already locked by `destroy`.

At this point, the server deadlocks: `getDetails` holds a lock on `_namesMutex` and waits for `_m` to become available, and `destroy` holds a lock on `_m` and waits for `_namesMutex` to become available, so neither thread can make progress.

To get rid of the deadlock, we have two options:

- Rearrange the locking such that deadlock becomes impossible.
- Abandon the idea of calling back from the servants into the factory and use *reaping* instead.

We will explore both options in the following pages.

Topics

- [Acquiring Locks without Deadlocks](#)

- [Reaping Objects](#)

See Also

- [Life Cycle and Collection Operations](#)

Acquiring Locks without Deadlocks

For our example, it is fairly easy to avoid the deadlock caused by [cyclic dependencies](#): instead of holding the lock for the duration of `destroy`, we set the `_destroyed` flag under protection of the lock and unlock `_m` again before calling `remove` on the factory:

```

C++

void
PhoneEntryI::destroy(const Current& c)
{
    {
        Mutex::Lock lock(_m);

        if (_destroyed)
            throw ObjectNotExistException(__FILE__, __LINE__);

        _destroyed = true;

    } // _m is unlocked here.

    _factory->remove(_name, c.adapter);
}

```

Now deadlock is impossible because no function holds more than one lock, and no function calls another function while it holds a lock. However, rearranging locks in this fashion can be quite difficult for complex applications. In particular, if an application uses callbacks that do complex things involving several objects, it can be next to impossible to prove that the code is free of deadlocks. The same is true for applications that use condition variables and suspend threads until a condition becomes true.

At the core of the problem is that concurrency can create circular locking dependencies: an operation on the factory (such as `getDetails`) can require the same locks as a concurrent call to `destroy`. This is one reason why threaded code is harder to write than sequential code — the interactions among operations require locks, but dependencies among these locks are not obvious. In effect, locks set up an entirely separate and largely invisible set of dependencies. For example, it was easy to spot the mutual dependency between the factory and the servants due to the presence of `remove`; in contrast, it was much harder to spot the lurking deadlock in `destroy`. Worse, deadlocks may not be found during testing and discovered only after deployment, when it is much more expensive to rectify the problem.

See Also

- [Removing Cyclic Dependencies](#)

Reaping Objects

Instead of trying to arrange code such that it is deadlock-free in the presence of callbacks and [cyclic dependencies](#), it is often easier to change the code to avoid the callbacks entirely and to use an approach known as *reaping*:

- `destroy` marks the servant as destroyed and removes the [Active Servant Map](#) (ASM) entry as usual, but it does not call back into the factory to update the `_names` set.
- Whenever a collection manager operation, such as `list`, `getDetails`, or `find` is called, the factory checks for destroyed servants and, if it finds any, removes them from the `_names` set.

Reaping can make for a much cleaner design because it avoids both the cyclic type dependency and the cyclic locking dependency.

On this page:

- [A Simple Reaping Implementation](#)
- [Alternative Reaping Implementations](#)

A Simple Reaping Implementation

To implement reaping, we need to change our `PhoneEntryI` definition a little. It no longer has a static `_factory` smart pointer back to the factory (because it no longer calls `remove`). Instead, the servant now provides a member function `_isZombie` that the factory calls to check whether the servant was destroyed some time in the past:

```

C++

class PhoneEntryI : public PhoneEntry {
public:
    // ...

    bool _isZombie() const;

private:
    const string _name;
    string _phNum;
    bool _destroyed;
    Mutex _m;
};
```

The implementation of `_isZombie` is trivial: it returns the `_destroyed` flag under protection of the lock:

```

C++

bool
PhoneEntryI::_isZombie() const
{
    Mutex::Lock lock(_m);

    return _destroyed;
}
```

The `destroy` operation no longer calls back into the factory to update the `_names` set; instead, it simply sets the `_destroyed` flag and removes the ASM entry:

C++

```

void
PhoneEntryI::destroy(const Current& c)
{
    Mutex::Lock lock(_m);

    if (_destroyed)
        throw ObjectNotExistException(__FILE__, __LINE__);

    _destroyed = true;
    c.adapter?>remove(c.id);
}

```

The factory now, instead of storing just the names of existing servants, maintains a map that maps the name of each servant to its smart pointer:

C++

```

class PhoneEntryFactoryI : public PhoneEntryFactory
{
public:
    // Constructor and Slice operations here...

private:
    typedef map<string, PhoneEntryIPtr> PMap;
    PMap _entries;
    Mutex _entriesMutex;
};

```

During create (and other operations, such as list, getDetails, and find), we scan for zombie servants and remove them from the `_entries` map:

C++

```

PhoneEntryPrx
PhoneEntryFactory::create(const string& name, const string& phNum,
const Current& c)
{
    Mutex::Lock lock(_entriesMutex);

    PhoneEntryPrx pe;
    PhoneEntryIPtr servant = new PhoneEntryI(name, phNum);

    // Try to create new object.
    //
    try {
        CommunicatorPtr comm = c.adapter?>getCommunicator();
        pe = PhoneEntryPrx::uncheckedCast(
            c.adapter?>add(servant, comm?>stringToIdentity(name)));
    } catch (const Ice::AlreadyRegisteredException&) {
        throw PhoneEntryExists(name, phNum);
    }

    // Scan for zombies.
    //
    PMap::iterator i = _entries.begin();
    while (i != _entries.end())
    {
        if (i?>second?>_isZombie())
            _entries.erase(i++);
        else
            ++i;
    }
    _entries[name] = servant;

    return pe;
}

```

The implementations of `list`, `getDetails`, and `find` scan for zombies as well. Because they need to iterate over the existing entries anyway, reaping incurs essentially no extra cost:

C++

```

PhoneEntries
PhoneEntryFactoryI::list(const Current& c)
{
    Mutex::Lock lock(_entriesMutex);

    CommunicatorPtr comm = c.adapter?>getCommunicator();

    PhoneEntries pe;
    PMap::iterator i = _entries.begin();
    for (i = _entries.begin(); i != _entries.end(); ++i) {
        if (i?>second?>_isZombie()) {
            _entries.erase(i++);
        } else {
            ObjectPrx o = c.adapter?>createProxy(comm?>stringToIdentity
(i?>first));
            pe.push_back(PhoneEntryPrx::uncheckedCast(o));
            ++i;
        }
    }

    return pe;
}

// Similar for getDetails and find...

```

This is a much cleaner design: there is no cyclic dependency between the factory and the servants, either implicit (in the type system) or explicit (as a locking dependency). Moreover, the implementation is easier to understand once you get used to the idea of reaping: there is no need to follow complex callbacks and to carefully analyze the order of lock acquisition. (Note that, depending on how state is maintained for servants, you may also need to reap during start-up and shutdown.)

In general, we recommend that you use a reaping approach in preference to callbacks for all but the most trivial applications: it simply is a better approach that is easier to maintain and understand.

Alternative Reaping Implementations

You may be concerned that reaping increases the cost of `create` from $O(\log n)$ to $O(n)$ because `create` now iterates over all existing entries and locks and unlocks a mutex in each servant (whereas, previously, it simply added each new servant to the `_names` set). Often, this is not an issue because life cycle operations are called infrequently compared to normal operations. However, you will notice the additional cost if you have a large number of servants (in the thousands or more) and life cycle operations are called frequently.

If you find that `create` is a bottleneck (by profiling, not by guessing!), you can change to a more efficient implementation by adding zombie servants to a separate zombie list. Reaping then iterates over the zombie list and removes each servant in the zombie list from the `_entries` map before clearing the zombie list. This reduces the cost of reaping to be proportional to the number of zombie servants instead of the total number of servants. In addition, it allows us to remove the `_isZombie` member function and to lock and unlock `_entriesMutex` only once instead of locking a mutex in each servant as part of `_isZombie`. We will see such an implementation when we revisit the [file system application](#).

You may also be concerned about the number of zombie servants that can accumulate in the server if `create` is not called for some time. For most applications, this is not a problem: the servants occupy memory, but no other resources because `destroy` can clean up scarce resources, such as file descriptors or network connections before it turns the servant into a zombie. If you really need to prevent

accumulation of zombie servants, you can reap from a background thread that runs periodically, or you can count the number of zombies and trigger a reaping pass once that number exceeds some threshold.

See Also

- [Removing Cyclic Dependencies](#)
- [The Active Servant Map](#)
- [Object Life Cycle for the File System Application](#)

Object Identity and Uniqueness

When [creating an object with a factory](#), it may not be a good idea to allow clients to control the [object identity](#) of the Ice objects they create. Here is the scenario from our [previous discussion](#), re-cast in terms of our phone book application:

1. Client A creates a new phone entry for Fred.
2. Client A passes the proxy for the Fred entry as a parameter of a remote call to another part of the system, say, server B.
3. Server B remembers Fred's proxy.
4. Client A decides that the entry for Fred is no longer needed and calls Fred's destroy operation.
5. Some time later, client C creates a new phone entry for a different person whose name also happens to be Fred.
6. Server B decides to get Fred's phone number by calling `getNumber` on the proxy it originally obtained from client A.

At this point, things are likely to go wrong: server B thinks that it has obtained the phone number of the original Fred, but that entry no longer exists and has since been replaced by a new entry for a different person (who presumably has a different phone number).

What has happened here is that Fred has been reincarnated because the same object identity was used for two different objects. In general, such reused object identities are a bad idea. For example, consider the following interfaces:

Slice

```
interface Process {
    void launch(); // Start process.
};

interface Missile {
    void launch(); // Kill lots of people.
};
```

Replaying the preceding scenario, if client A creates a `Process` object called "Thunderbird" and destroys that object again, and client C creates a `Missile` object called "Thunderbird", when server B calls `launch`, it will launch a missile instead of a process.

To be fair, in reality, this scenario is unlikely because it tacitly assumes that both objects are implemented by the same object adapter but, in a realistic scenario, the same server would be unlikely to implement both launching of processes and missiles. However, if you have objects that derive from common base interfaces, so objects of different types share the same operation names, this problem is real: operation invocations can easily end up in a destroyed and later recreated object.

Specifically, the preceding scenario illustrates that, when the Ice run time dispatches a request, exactly three items determine where the request ends up being processed:

- the endpoint at which the server listens for incoming requests
- the identity of the Ice object that is the target of the request
- the name of the operation that is to be invoked on the Ice object

If object identities are insufficiently unique, a request intended for one object can end up being sent to a completely different object, provided that the original object used the same identity, that both provide an operation with the same name, and that the parameters passed to one operation happen to decode correctly when interpreted as the parameters to the other operation. (This is rare, but not impossible, depending on the type and number of parameters.)

The crucial question is, what do we mean by "insufficiently unique"? As far as the call dispatch is concerned, identities must be unique only per object adapter. This is because the ASM does not allow you to add two entries with the same object identity; by enforcing this, the [Active Servant Map](#) (ASM) ensures that each object identity belongs to exactly one servant. (Note that the converse, namely, that servants in ASM entries must be unique, is *not* the case: the ASM allows you to map different object identities to the same servant, which is useful to, for example, implement stateless facade objects — [default servants](#) are used for this purpose.) So, as far as the Ice run time is concerned, it is perfectly OK to reuse object identities for different Ice objects.

Note that the Ice run time cannot prevent reuse of object identities either. Doing so would require the run time to remember every object identity that has ever been used, which does not scale. Instead, the Ice run time makes the application responsible for ensuring that object

identities are "sufficiently unique".

You can deal with the identity reuse problem in several ways. One option is to do nothing and simply ignore the problem. While this sounds facetious, it is a viable option for many applications because, due to their nature, identity reuse is simply impossible. For example, if you use a social security number as a person's identity, the problem cannot arise because the social security number of a deceased person is not given to another person.

Another option is to allow identity reuse and to write your application such that it can deal with such identities: if nothing bad happens when an identity is reused, there is no problem. (This is the case if you know that the life cycles of the proxies for two different objects with the same identity can never overlap.)

The third option is to ensure that object identities are guaranteed unique, for example, by establishing naming conventions that make reuse impossible, or by using a [UUID as the object identity](#). This can be useful even for applications for which identity reuse does not pose a problem. For example, if you use [well-known objects](#), globally-unique object identities allow you to move a server to a different machine without invalidating proxies to these objects that are held by clients.

In general, we recommend that if an Ice object naturally contains a unique item of state (such as a social security number), you should use that item as the object identity. On the other hand, if the natural object identity is insufficiently unique (as is the case with names of phone book entries), you should use a UUID as the identity. (This is particularly useful for anonymous transient objects, such as session objects, that may not have a natural identity.)

See Also

- [Object Creation](#)
- [Object Identity](#)
- [The Active Servant Map](#)
- [Default Servants](#)
- [Servant Activation and Deactivation](#)
- [Understanding Object Life Cycle](#)
- [Well-Known Objects](#)

Object Life Cycle for the File System Application

Now that we have had a look at the issues around object life cycle, let us return to our [file system application](#) and add life cycle operations to it, so clients can create and destroy files and directories.

To destroy a file or directory, the obvious choice is to add a `destroy` operation to the `Node` interface:

```

Slice
module Filesystem {

    exception GenericError {
        string reason;
    };
    exception PermissionDenied extends GenericError {};
    exception NameInUse extends GenericError {};
    exception NoSuchName extends GenericError {};

    interface Node {
        idempotent string name();
        void destroy() throws PermissionDenied;
    };

    // ...
};

```

Note that `destroy` can throw a `PermissionDenied` exception. This is necessary because we must prevent attempts to destroy the root directory.

The `File` interface is unchanged:

```

Slice
module Filesystem {
    // ...

    sequence<string> Lines;

    interface File extends Node {
        idempotent Lines read();
        idempotent void write(Lines text) throws GenericError;
    };

    // ...
};

```

Note that, because `File` derives from `Node`, it inherits the `destroy` operation we defined for `Node`.

The `Directory` interface now looks somewhat different from the previous version:

- The `list` operation returns a sequence of structures instead of a list of proxies: for each entry in a directory, the `NodeDesc` structur

e provides the name, type, and proxy of the corresponding file or directory.

- Directories provide a `find` operation that returns the description of the nominated node. If the nominated node does not exist, the operation throws a `NoSuchName` exception.
- The `createFile` and `createDirectory` operations create a file and directory, respectively. If a file or directory already exists, the operations throw a `NameInUse` exception.

Here are the corresponding definitions:

```

Slice

module Filesystem {
    // ...

    enum NodeType { DirType, FileType };

    struct NodeDesc {
        string name;
        NodeType type;
        Node* proxy;
    };

    sequence<NodeDesc> NodeDescSeq;

    interface Directory extends Node {
        idempotent NodeDescSeq list();
        idempotent NodeDesc find(string name) throws NoSuchName;
        File* createFile(string name) throws NameInUse;
        Directory* createDirectory(string name) throws NameInUse;
    };
};

```

Note that this design is somewhat different from the factory we designed for the [phone book application](#). In particular, we do not have a single object factory; instead, we have as many factories as there are directories, that is, each directory creates files and directories only in that directory.

The motivation for this design is twofold:

- Because all files and directories that can be created are immediate descendants of their parent directory, we avoid the complexities of parsing path names for a separator such as `"/`. This keeps our example code to manageable size. (A real-world implementation of a distributed file system would, of course, be able to deal with path names.)
- Having more than one object factory presents interesting implementation issues that we will explore in the following discussion.

Let's move on to the implementation of this design in C++ and Java. You can find the full code of the implementation (including languages other than C++ and Java) in the `demo/book/lifecycle` directory of your Ice distribution.

Topics

- [Implementing Object Life Cycle in C++](#)
- [Implementing Object Life Cycle in Java](#)

See Also

- [Slice for a Simple File System](#)
- [Object Creation](#)

Implementing Object Life Cycle in C++

The implementation of our life cycle design has the following characteristics:

- It uses UUIDs as the object identities for nodes to avoid [object reincarnation problems](#).
- When `destroy` is called on a node, the node needs to destroy itself and inform its parent directory that it has been destroyed (because the parent directory is the node's factory and also acts as a collection manager for child nodes).

Note that, in contrast to the [initial version](#), the entire implementation resides in a `FilesystemI` namespace instead of being part of the `Filesystem` namespace. Doing this is not essential, but is a little cleaner because it keeps the implementation in a namespace that is separate from the Slice-generated namespace.

On this page:

- [Object Life Cycle Changes for the `NodeI` Class in C++](#)
- [Object Life Cycle Changes for the `DirectoryI` Class in C++](#)
- [Object Life Cycle Changes for the `FileI` Class in C++](#)
- [Object Life Cycle Concurrency Issues in C++](#)

Object Life Cycle Changes for the `NodeI` Class in C++

To begin with, let us look at the definition of the `NodeI` class:

```

C++
namespace FilesystemI {

    class DirectoryI;
    typedef IceUtil::Handle<DirectoryI> DirectoryIPtr;

    class NodeI : public virtual Filesystem::Node {
    public:
        virtual std::string name(const Ice::Current&);
        Ice::Identity id() const;

    protected:
        NodeI(const std::string& name, const DirectoryIPtr& parent);

        const std::string _name;
        const DirectoryIPtr _parent;
        bool _destroyed;
        Ice::Identity _id;
        IceUtil::Mutex _m;
    };

    // ...
}

```

The purpose of the `NodeI` class is to provide the data and implementation that are common to both `FileI` and `DirectoryI`, which use implementation inheritance from `NodeI`.

As in the [initial version](#), `NodeI` provides the implementation of the `name` operation and stores the name of the node and its parent directory in the `_name` and `_parent` members. (The root directory's `_parent` member is null.) These members are immutable and initialized by the constructor and, therefore, `const`.

The `_destroyed` member, protected by the mutex `_m`, prevents the [race condition](#) we discussed earlier. The constructor initializes `_destroyed` to `false` and creates an identity for the node (stored in the `_id` member):

```

C++
FilesystemI::NodeI::NodeI(const string& name,
const DirectoryIPtr& parent)
    : _name(name), _parent(parent), _destroyed(false)
{
    _id.name = parent ? IceUtil::generateUUID() : "RootDir";
}

```

The `id` member function returns a node's identity, stored in the `_id` data member. The node must remember this identity because it is a UUID and is needed when we create a proxy to the node:

```

C++
Identity
FilesystemI::NodeI::id() const
{
    return _id;
}

```

The data members of `NodeI` are protected instead of `private` to keep them accessible to the derived `FileI` and `DirectoryI` classes. (Because the implementation of `NodeI` and its derived classes is quite tightly coupled, there is little point in making these members `private` and providing separate accessors and mutators for them.)

The implementation of the Slice `name` operation simply returns the name of the node, but also [checks whether the node has been destroyed](#):

```

C++
string
FilesystemI::NodeI::name(const Current&)
{
    IceUtil::Mutex::Lock lock(_m);

    if (_destroyed)
        throw ObjectNotExistException(__FILE__, __LINE__);

    return _name;
}

```

This completes the implementation of the `NodeI` base class.

Object Life Cycle Changes for the `DirectoryI` Class in C++

Next, we need to look at the implementation of directories. The `DirectoryI` class derives from `NodeI` and the Slice-generated `Directory` skeleton class. Of course, it must implement the pure virtual member functions for its Slice operations, which leads to the following (not yet complete) definition:

C++

```

namespace FilesystemI {

    // ...

    class DirectoryI : virtual public NodeI,
                      virtual public Filesystem::Directory {
    public:
        virtual Filesystem::NodeDescSeq list(const Ice::Current&);
        virtual Filesystem::NodeDesc find(const std::string&,
const Ice::Current&);
        Filesystem::FilePrx createFile(const std::string&,
const Ice::Current&);
        Filesystem::DirectoryPrx createDirectory(const std::string&,
const Ice::Current&);
        virtual void destroy(const Ice::Current&);
        // ...

    private:
        // ...
    };
}

```

Each directory stores its contents in a map that maps the name of a directory to its servant:

C++

```

namespace FilesystemI {

    // ...

    class DirectoryI : virtual public NodeI,
                      virtual public Filesystem::Directory {
    public:
        // ...

        DirectoryI(const ObjectAdapterPtr& a,
                  const std::string& name,
                  const DirectoryIPtr& parent = 0);

        void removeEntry(const std::string& name);

    private:
        typedef std::map<std::string, NodeIPtr> Contents;
        Contents _contents;
        // ...
    };
}

```

Note that we use the inherited member `_m` to interlock operations.

The constructor simply initializes the `NodeI` base class:

C++

```

FilesystemI::DirectoryI::DirectoryI(const string& name,
const DirectoryIPtr& parent)
    : NodeI(name, parent)
{
}

```

The `removeEntry` member function is called by the child to remove itself from its parent's `_contents` map:

C++

```

void
FilesystemI::DirectoryI::removeEntry(const string& name)
{
    IceUtil::Mutex::Lock lock(_m);
    Contents::iterator i = _contents.find(name);
    if(i != _contents.end())
    {
        _contents.erase(i);
    }
}

```

Here is the `destroy` member function for directories:

C++

```

void
FilesystemI::DirectoryI::destroy(const Current& c)
{
    if (!_parent)
        throw PermissionDenied("Cannot destroy root directory");
    {
        IceUtil::Mutex::Lock lock(_m);

        if (_destroyed)
            throw ObjectNotExistException(__FILE__, __LINE__);

        if (!_contents.empty())
            throw PermissionDenied("Cannot destroy non?empty directory"
);

        c.adapter?>remove(id());
        _destroyed = true;
    }

    _parent?>removeEntry(_name);
}

```

The code first prevents destruction of the root directory and then checks whether this directory was destroyed previously. It then acquires the lock and checks that the directory is empty. Finally, `destroy` removes the [Active Servant Map \(ASM\)](#) entry for the destroyed directory and removes itself from its parent's `_contents` map. Note that we call `removeEntry` outside the synchronization to [avoid deadlocks](#).

The `createDirectory` implementation locks the mutex before checking whether the directory already contains a node with the given name (or an invalid empty name). If not, it creates a new servant, adds it to the ASM and the `_contents` map, and returns its proxy:

C++

```

DirectoryPrx
FilesystemI::DirectoryI::createDirectory(const string& name,
const Current& c)
{
    IceUtil::Mutex::Lock lock(_m);

    if (_destroyed)
        throw ObjectNotExistException(__FILE__, __LINE__);

    if (name.empty() || _contents.find(name) != _contents.end())
        throw NameInUse(name);

    DirectoryIPtr d = new DirectoryI(name, this);
    ObjectPrx node = c.adapter?>add(d, d?>id());
    _contents[name] = d;
    return DirectoryPrx::uncheckedCast(node);
}

```

The `createFile` implementation is identical, except that it creates a file instead of a directory:

C++

```

FilePrx
FilesystemI::DirectoryI::createFile(const string& name,
const Current& c)
{
    IceUtil::Mutex::Lock lock(_m);

    if (_destroyed)
        throw ObjectNotExistException(__FILE__, __LINE__);

    if (name.empty() || _contents.find(name) != _contents.end())
        throw NameInUse(name);

    FileIPtr f = new FileI(name, this);
    ObjectPrx node = c.adapter?>add(f, f?>id());
    _contents[name] = f;
    return FilePrx::uncheckedCast(node);
}

```

Here is the implementation of `list`:

C++

```

NodeDescSeq
FilesystemI::DirectoryI::list(const Current& c)
{
    IceUtil::Mutex::Lock lock(_m);

    if (_destroyed)
        throw ObjectNotExistException(__FILE__, __LINE__);

    NodeDescSeq ret;
    for (Contents::const_iterator i = _contents.begin();
i != _contents.end(); ++i)
    {
        NodeDesc d;
        d.name = i->first;
        d.type = FilePtr::dynamicCast(i->second) ? FileType : DirType;
        d.proxy = NodePrx::uncheckedCast(c.adapter->createProxy(i->second->id()));
        ret.push_back(d);
    }
    return ret;
}

```

After acquiring the lock, the code iterates over the directory's contents and adds a `NodeDesc` structure for each entry to the returned vector.

The `find` operation proceeds along similar lines:

C++

```

NodeDesc
FilesystemI::DirectoryI::find(const string& name, const Current& c)
{
    IceUtil::Mutex::Lock lock(_m);

    if (_destroyed)
        throw ObjectNotExistException(__FILE__, __LINE__);

    Contents::const_iterator pos = _contents.find(name);
    if (pos == _contents.end())
        throw NoSuchName(name);

    NodeIPtr p = pos?>second;
    NodeDesc d;
    d.name = name;
    d.type = FilePtr::dynamicCast(p) ? FileType : DirType;
    d.proxy = NodePrx::uncheckedCast(c.adapter?>createProxy(p?>id()));
    return d;
}

```

Object Life Cycle Changes for the FileI Class in C++

The constructor of `FileI` is trivial: it simply initializes the data members of its base class::

C++

```

FilesystemI::FileI::FileI(const string& name,
const DirectoryIPtr& parent)
    : NodeI(name, parent)
{
}

```

The implementation of the three member functions of the `FileI` class is also trivial, so we present all three member functions here:

C++

```

Lines
FilesystemI::FileI::read(const Current&)
{
    IceUtil::Mutex::Lock lock(_m);

    if (_destroyed)
        throw ObjectNotExistException(__FILE__, __LINE__);

    return _lines;
}

// Slice File::write() operation.

void
FilesystemI::FileI::write(const Lines& text, const Current&)
{
    IceUtil::Mutex::Lock lock(_m);

    if (_destroyed)
        throw ObjectNotExistException(__FILE__, __LINE__);

    _lines = text;
}

void
FilesystemI::FileI::destroy(const Current& c)
{
    {
        IceUtil::Mutex::Lock lock(_m);

        if (_destroyed)
            throw ObjectNotExistException(__FILE__, __LINE__);

        c.adapter?>remove(id());
        _destroyed = true;
    }

    _parent?>removeEntry(_name);
}

```

Object Life Cycle Concurrency Issues in C++

The preceding implementation is provably deadlock free. All member functions hold only one lock at a time, so they cannot deadlock with each other or themselves. While the locks are held, the functions do not call other member functions that acquire locks, so any potential deadlock can only arise by concurrent calls to another mutating function, either on the same node or on different nodes. For concurrent calls

on the same node, deadlock is impossible because such calls are strictly serialized on the mutex `_m`; for concurrent calls to `destroy` on different nodes, each node locks its respective mutex `_m`, releases `_m` again, and then acquires and releases a lock on its parent (by calling `removeEntry`), also making deadlock impossible.

See Also

- [Example of a File System Server in C++](#)
- [Life Cycle and Normal Operations](#)
- [Acquiring Locks without Deadlocks](#)
- [Object Identity and Uniqueness](#)
- [The Active Servant Map](#)

Implementing Object Life Cycle in Java

The implementation of our life cycle design has the following characteristics:

- It uses UUIDs as the object identities for nodes to avoid [object reincarnation problems](#).
- When `destroy` is called on a node, the node needs to destroy itself and inform its parent directory that it has been destroyed (because the parent directory is the node's factory and also acts as a collection manager for child nodes).

Note that, in contrast to the [initial version](#), the entire implementation resides in a `FilesystemI` package instead of being part of the `Filesystem` package. Doing this is not essential, but is a little cleaner because it keeps the implementation in a package that is separate from the Slice-generated package.

On this page:

- [Object Life Cycle Changes for the `NodeI` Class in Java](#)
- [Object Life Cycle Changes for the `DirectoryI` Class in Java](#)
- [Object Life Cycle Changes for the `FileI` Class in Java](#)
- [Object Life Cycle Concurrency Issues in Java](#)

Object Life Cycle Changes for the `NodeI` Class in Java

Our `DirectoryI` and `FileI` servants derive from a common `NodeI` base interface. This interface is not essential, but useful because it allows us to treat servants of type `DirectoryI` and `FileI` polymorphically:

```

Java



```

package FilesystemI;

public interface NodeI
{
 Ice.Identity id();
}

```

```

The only method is the `id` method, which returns the identity of the corresponding node.

Object Life Cycle Changes for the `DirectoryI` Class in Java

As in the [initial version](#), the `DirectoryI` class derives from the generated base class `_DirectoryDisp`. In addition, the class implements the `NodeI` interface. `DirectoryI` must implement each of the Slice operations, leading to the following outline:

Java

```

package FilesystemI;

import Ice.*;
import Filesystem.*;

public class DirectoryI extends _DirectoryDisp implements NodeI
{
    public Identity
    id();

    public synchronized String
    name(Current c);

    public synchronized NodeDesc[]
    list(Current c);

    public synchronized NodeDesc
    find(String name, Current c) throws NoSuchName;

    public synchronized FilePrx
    createFile(String name, Current c) throws NameInUse;

    public synchronized DirectoryPrx
    createDirectory(String name, Current c) throws NameInUse;

    public void
    destroy(Current c) throws PermissionDenied;

    // ...
}

```

To support the implementation, we also require a number of methods and data members:

Java

```

package FilesystemI;

import Ice.*;
import Filesystem.*;

public class DirectoryI extends _DirectoryDisp implements NodeI
{
    // ...

    public DirectoryI();
    public DirectoryI(String name, DirectoryI parent);

    public synchronized void
    removeEntry(String name);

    private String _name;          // Immutable
    private DirectoryI _parent;    // Immutable
    private Identity _id;         // Immutable
    private boolean _destroyed;
    private java.util.Map<String, NodeI> _contents;
}

```

The `_name` and `_parent` members store the name of this node and a reference to the node's parent directory. (The root directory's `_parent` member is null.) Similarly, the `_id` member stores the identity of this directory. The `_name`, `_parent`, and `_id` members are immutable once they have been initialized by the constructor. The `_destroyed` member prevents a [race condition](#); to interlock access to `_destroyed` (as well as the `_contents` member) we can use synchronized methods (as for the `name` method), or use a `synchronized(this)` block.

The `_contents` map records the contents of a directory: it stores the name of an entry, together with a reference to the child node.

Here are the two constructors for the class:

Java

```

public DirectoryI()
{
    this("/", null);
}

public DirectoryI(String name, DirectoryI parent)
{
    _name = name;
    _parent = parent;
    _id = new Identity();
    _destroyed = false;
    _contents = new java.util.HashMap<String, NodeI>();

    _id.name = parent == null ? "RootDir" : java.util.UUID.randomUUID()
.toString();
}

```

The first constructor is a convenience function to create the root directory with the fixed identity "RootDir" and a null parent.

The real constructor initializes the `_name`, `_parent`, `_id`, `_destroyed`, and `_contents` members. Note that nodes other than the root directory use a UUID as the object identity.

The `removeEntry` method is called by the child to remove itself from its parent's `_contents` map:

Java

```

public synchronized void
removeEntry(String name)
{
    _contents.remove(name);
}

```

The implementation of the Slice name operation simply returns the name of the node, but also checks whether the node has been destroyed:

Java

```

public synchronized String
name(Current c)
{
    if (_destroyed)
        throw new ObjectNotExistException();
    return _name;
}

```

Note that this method is synchronized, so the `_destroyed` member cannot be accessed concurrently.

Here is the `destroy` member function for directories:

Java

```

public void
destroy(Current c) throws PermissionDenied
{
    if (_parent == null)
        throw new PermissionDenied("Cannot destroy root directory");

    synchronized(this) {
        if (_destroyed)
            throw new ObjectNotExistException();

        if (_contents.size() != 0)
            throw new PermissionDenied("Cannot destroy non?empty direct
ory");

        c.adapter.remove(id());
        _destroyed = true;
    }

    _parent.removeEntry(_name);
}

```

The code first prevents destruction of the root directory and then checks whether this directory was destroyed previously. It then acquires the lock and checks that the directory is empty. Finally, `destroy` removes the [Active Servant Map](#) (ASM) entry for the destroyed directory and removes itself from its parent's `_contents` map. Note that we call `removeEntry` outside the synchronization to [avoid deadlocks](#).

The `createDirectory` implementation acquires the lock before checking whether the directory already contains a node with the given name (or an invalid empty name). If not, it creates a new servant, adds it to the ASM and the `_contents` map, and returns its proxy:

Java

```

public synchronized DirectoryPrx
createDirectory(String name, Current c) throws NameInUse
{
    if (_destroyed)
        throw new ObjectNotExistException();

    if (name.length() == 0 || _contents.containsKey(name))
        throw new NameInUse(name);

    DirectoryI d = new DirectoryI(name, this);
    ObjectPrx node = c.adapter.add(d, d.id());
    _contents.put(name, d);
    return DirectoryPrxHelper.uncheckedCast(node);
}

```

The `createFile` implementation is identical, except that it creates a file instead of a directory:

Java

```
public synchronized FilePrx
createFile(String name, Current c) throws NameInUse
{
    if (_destroyed)
        throw new ObjectNotExistException();

    if (name.length() == 0 || !_contents.containsKey(name))
        throw new NameInUse(name);

    FileI f = new FileI(name, this);
    ObjectPrx node = c.adapter.add(f, f.id());
    _contents.put(name, f);
    return FilePrxHelper.uncheckedCast(node);
}
```

Here is the implementation of list:

Java

```
public synchronized NodeDesc[]
list(Current c)
{
    if(_destroyed)
        throw new ObjectNotExistException();

    NodeDesc[] ret = new NodeDesc[_contents.size()];
    java.util.Iterator<java.util.Map.Entry<String, NodeI> > pos =
        _contents.entrySet().iterator();
    for(int i = 0; i < _contents.size(); ++i) {
        java.util.Map.Entry<String, NodeI> e = pos.next();
        NodeI p = e.getValue();
        ret[i] = new NodeDesc();
        ret[i].name = e.getKey();
        ret[i].type = p instanceof FileI
? NodeType.FileType : NodeType.DirType;
        ret[i].proxy = NodePrxHelper.uncheckedCast(c.adapter.createProxy(p.id()));
    }
    return ret;
}
```

After acquiring the lock, the code iterates over the directory's contents and adds a `NodeDesc` structure for each entry to the returned array.

The `find` operation proceeds along similar lines:

Java

```

public synchronized NodeDesc
find(String name, Current c) throws NoSuchName
{
    if (_destroyed)
        throw new ObjectNotExistException();

    NodeI p = _contents.get(name);
    if (p == null)
        throw new NoSuchName(name);

    NodeDesc d = new NodeDesc();
    d.name = name;
    d.type = p instanceof FileI ? NodeType.FileType : NodeType.DirType;
    d.proxy = NodePrxHelper.uncheckedCast(c.adapter.createProxy(p.id()))
);
    return d;
}

```

Object Life Cycle Changes for the FileI Class in Java

The FileI class is similar to the DirectoryI class. The data members store the name, parent, and identity of the file, as well as the _destroyed flag and the contents of the file (in the _lines member). The constructor initializes these members:

Java

```
package FilesystemI;

import Ice.*;
import Filesystem.*;
import FilesystemI.*;

public class FileI extends _FileDisp implements NodeI
{
    // ...

    public FileI(String name, DirectoryI parent)
    {
        _name = name;
        _parent = parent;
        _destroyed = false;
        _id = new Identity();
        _id.name = Util.generateUUID();
    }

    private String _name;
    private DirectoryI _parent;
    private boolean _destroyed;
    private Identity _id;
    private String[] _lines;
}
```

The implementation of the remaining member functions of the `FileI` class is trivial, so we present all of them here:

Java

```
public synchronized String
name(Current c)
{
    if (_destroyed)
        throw new ObjectNotExistException();
    return _name;
}

public Identity
id()
{
    return _id;
}

public synchronized String[]
read(Current c)
{
    if (_destroyed)
        throw new ObjectNotExistException();

    return _lines;
}

public synchronized void
write(String[] text, Current c)
{
    if (_destroyed)
        throw new ObjectNotExistException();

    _lines = (String[])text.clone();
}

public void
destroy(Current c)
{
    synchronized(this) {
        if (_destroyed)
            throw new ObjectNotExistException();

        c.adapter.remove(id());
        _destroyed = true;
    }

    _parent.removeEntry(_name);
}
```

Object Life Cycle Concurrency Issues in Java

The preceding implementation is provably deadlock free. All methods hold only one lock at a time, so they cannot deadlock with each other or themselves. While the locks are held, the methods do not call other methods that acquire locks, so any potential deadlock can only arise by concurrent calls to another mutating method, either on the same node or on different nodes. For concurrent calls on the same node, deadlock is impossible because such calls are strictly serialized on the instance; for concurrent calls to `destroy` on different nodes, each node locks itself, releases itself again, and then acquires and releases a lock on its parent (by calling `removeEntry`), also making deadlock impossible.

See Also

- [Example of a File System Server in Java](#)
- [Life Cycle and Normal Operations](#)
- [Object Identity and Uniqueness](#)
- [Acquiring Locks without Deadlocks](#)
- [The Active Servant Map](#)

Avoiding Server-Side Garbage

On this page:

- [Creating Garbage](#)
- [Garbage Collection Solutions](#)
- [Simple Mechanisms for Garbage Collection](#)
- [Using an Extra Level of Indirection to Collect Garbage](#)
- [Server-Side Changes for Garbage Collection](#)
- [Client-Side Changes for Garbage Collection](#)

Creating Garbage

We have discussed the implementation of [object life cycle](#), that is, how to correctly provide clients with the means to create and destroy objects. However, throughout this discussion, we have tacitly assumed that clients actually call `destroy` once they no longer need an object. What if this is actually not the case? For example, a client might intend to call `destroy` on an object it no longer needs but crash before it can actually make the call.

To see why this is a realistic (and serious) scenario, consider an on-line retail application. Typically, such an application provides a shopping cart to the client, into which the client can place items. Naturally, the cart and the items it contains will be modelled as server-side objects. The expectation is that, eventually, the client will either finalize or cancel the purchase, at which point the shopping cart and its contents can be destroyed. However, the client may never do that, for example, because it crashes or simply loses interest.

The preceding scenario applies to many different applications and shows up in various disguises. For example, the objects might be session objects that encapsulate security credentials of a client, or might be iterator objects that allow a client to iterate over a collection of values. The key point is that the interactions between client and server are stateful: the server creates state on behalf of a client, holds that state for the duration of several client-server interactions, and expects the client to inform the server when it can clean up that state. If the client never informs the server, whatever resources are associated with that client's state are leaked; these resources are termed *garbage*.

The garbage might be memory, file descriptors, network connections, disk space, or any number of other things. Unless the server takes explicit action, eventually, the garbage will accumulate to the point where the server fails because it has run out of memory, file descriptors, network connections, or disk space.

In the context of Ice, the garbage are servants and their associated resources. In this section, we examine strategies that a server can use avoid drowning in that garbage.

Garbage Collection Solutions

The server is presented with something of a dilemma by garbage objects. The difficulty is not in how to remove the garbage objects (after all, the server knows how to destroy each object), but how to identify whether a particular object is garbage or not. The server knows when a client uses an object (because the server receives an invocation for the object), but the server does not know when an object is no longer of interest to a client (because a dead client is indistinguishable from a slow one).

One approach to dealing with garbage is to avoid creating it in the first place: if all interactions between client and server are stateless, the garbage problem does not arise. Unfortunately, for many applications, implementing this approach is infeasible. The reason is that, in order to turn interactions that are inherently stateful (such as updating a database) into stateless ones, designers are typically forced to keep all the state on the client side, transmit whatever state is required by the server with each remote procedure call, and return the updated state back to the client. In many situations, this simply does not work: for one, the amount of state that needs to be transmitted with each call is often prohibitively large; second, replicating all the state on the client side creates other problems, such as different clients concurrently making conflicting updates to the same data.

The remainder of this section ignores stateless designs. This is not to say that stateless designs are undesirable: where suitable, they can be very effective. However, because many applications simply cannot use them, we focus instead on other ways to deal with garbage.

Mechanisms that identify and reclaim garbage objects are known as garbage collectors. Garbage collectors are well-understood for non-distributed systems. (For example, many programming languages, such as Java and C#, have built-in garbage collectors.)

Non-distributed garbage collectors keep track of all objects that are created, and perform some form of connectivity analysis to determine which objects are still reachable; any objects that are unreachable (that is, objects to which the application code no longer holds any reference) are garbage and are eventually reclaimed.

Unfortunately, for distributed systems, traditional approaches to garbage collection do not work because the cost of performing the connectivity analysis becomes prohibitively large. For example, DCOM provided a distributed garbage collector that turned out to be its Achilles' heel: the collector did not scale to large numbers of objects, particularly across WANs, and several attempts at making it scale failed.

An alternative to distributed garbage collection is to use timeouts to avoid the cost of doing a full connectivity analysis: if an object has not been used for a certain amount of time, the server assumes that it is garbage and reclaims the object. The drawback of this idea is that it is possible for objects to be collected while they are still in use. For example, a customer may have placed a number of items in a shopping cart and gone out to lunch, only to find on return that the shopping cart has disappeared in the mean time.

Yet another alternative is to use the evictor pattern: the server puts a cap on the total number of objects it is willing to create on behalf of clients and, once the cap is reached, destroys the least-recently used object in order to make room for a new one. This puts an upper limit on the resources used by the server and eventually gets rid of all unwanted objects. But the drawback is the same as with timeouts: just because an object has not been used for a while does not necessarily mean that it truly is garbage.

Neither timeouts nor evictors are true garbage collectors because they can collect objects that are not really garbage, but they do have the advantage that they reap objects even if the client is alive, but forgets to call `destroy` on some of these objects.

Simple Mechanisms for Garbage Collection

Traditional garbage collection fails in the distributed case for a number of reasons:

- Garbage collectors require connectivity analysis, which is prohibitively expensive. Furthermore, for distributed object systems that permit proxies to be externalized as strings, such as Ice, connectivity analysis is impossible because proxies can exist and travel by means that are invisible to the run time. For example, proxies can exist as records in a database and can travel as strings inside e-mail messages.
- Garbage collectors consider all objects in existence but, for the vast majority of applications, only a small subset of all objects actually ever needs collecting. The work spent in examining objects that can never become garbage is wasted.
- Garbage collectors examine connectivity at the granularity of a single object. However, for many distributed applications, objects are used in groups and, if one object in a group is garbage, all objects in the group are garbage. It would be useful to take advantage of this knowledge, but a garbage collector cannot do this because that knowledge is specific to each application.

In the remainder of this section, we examine a simple mechanism that allows you to get rid of garbage objects cheaply and effectively. The approach has the following characteristics:

- Only those objects that potentially can become garbage are considered for collection.
- Granularity of collection is under control of the application: you can have objects collected as groups of arbitrary size, down to a single object.
- Objects are guaranteed not to be collected prematurely.
- Objects are guaranteed to be collected if the client crashes or suffers loss of connectivity.
- The mechanism is simple to implement and has low run-time overhead.

It is equally important to be aware of the limitations of the approach:

- The approach collects objects if a client crashes, but offers no protection against clients that are still running, but have neglected to destroy objects that they no longer need. In other words, the server is protected against client-side hardware failure and catastrophic client crashes, but it is not protected against faulty programming logic of clients.
- The approach is not transparent at the interface level: it requires changes (albeit minor ones) to the interface definitions for an application.
- The approach requires the client to periodically call the server, thus consuming network resources even if the client is otherwise idle.

Despite the limitations, this approach to garbage collection is applicable to a wide variety of applications and meets the most pragmatic need: how to clean up in case something goes badly wrong (rather than how to clean up in case the client misbehaves).

Using an Extra Level of Indirection to Collect Garbage

Object factories are typically singleton objects that create objects on behalf of various clients. It is important for our garbage collector to know which client created what objects, so the collector can reap the objects created by a specific client if that client crashes. We can easily deal with this requirement by adding the proverbial level of indirection: instead of making a factory a singleton object, we provide a singleton object that creates factories. Clients first create a factory and then create all other objects they need using that factory:

Slice

```

interface Item { /* ...*/ };

interface Cart
{
    Item* create(/* ... */);
    idempotent string getName();
    void destroy();
    idempotent void refresh();
};

interface CartFactory // Singleton
{
    Cart* create(string name);
};

```

Clients obtain a proxy to the `CartFactory` singleton and call `create` to create a `Cart` object. In turn, the `Cart` object provides a `create` operation to place new objects of type `Item` into the cart. Note that the shopping cart name allows a client to distinguish different carts — the `name` parameter is *not* used to identify clients or to provide a unique identifier for carts. The `getName` operation on the `Cart` object returns the name that was used by the client to create it.

Each `Cart` object remembers which items it created. Because each client uses its own shopping cart, the server knows which objects were created by what client. In normal operation, a client first creates a shopping cart, and then uses the cart to create the items in the cart. Once the client has finished its job, it calls `destroy` on the cart. The implementation of `destroy` destroys both the cart and its items to reclaim resources.

To deal with crashed clients, the server needs to know when a cart is no longer in use. This is the purpose of the `refresh` operation: clients are expected to periodically call `refresh` on their cart objects. For example, the server might decide that, if a client's cart has not been refreshed for more than ten minutes, the cart is no longer in use and reclaim it. As long as the client calls `refresh` at least once every ten minutes, the cart (and the items it contains) remain alive; if more than ten minutes elapse, the server simply calls `destroy` on the cart. Of course, there is no need to hard-wire the timeout value — you can make it part of the application's configuration. However, to keep the implementation simple, it is useful to have the same timeout value for all carts, or to at least restrict the timeouts for different carts to a small number of fixed choices — this considerably simplifies the implementation in both client and server.

Server-Side Changes for Garbage Collection

The implementation of the interfaces on the server side almost suggests itself:

- Whenever `refresh` is called on a cart, the cart records the time at which the call was made.
- The server runs a reaper thread that wakes up once every ten minutes. The reaper thread examines the timestamp of all carts and, if it finds a cart last time-stamped more than ten minutes ago, it calls `destroy` on that cart.
- Each cart remembers the items it contains and destroys them as part of its `destroy` implementation.

Here then is the reaper thread in outline. (Note that we have simplified the code to show the essentials. For example, we have omitted the code that is needed to make the reaper thread terminate cleanly when the server shuts down. See the code in `demo/Ice/session` for more detail.)

C++

```

class ReapThread : public IceUtil::Thread,
                  public IceUtil::Monitor<IceUtil::Mutex>
{
public:
    ReapThread();
    virtual void run();
    void add(const CartPrx&, const CartIPtr&);

private:
    const IceUtil::Time _timeout;
    struct CartProxyPair
    {
        CartProxyPair(const CartPrx& p, const CartIPtr& c) :
            proxy(p), cart(c) { }
        const CartPrx proxy;
        const CartIPtr cart;
    };
    std::list<CartProxyPair> _carts;
};

typedef IceUtil::Handle<ReapThread> ReapThreadPtr;

```

Note that the reaper thread maintains a list of pairs. Each pair stores the proxy of a cart and its servant pointer. We need both the proxy and the pointer because we need to invoke methods on both the Slice interface and the implementation interface of the cart. Whenever a client creates a new cart, the server calls the `add` method on the reaper thread, passing it the new cart:

C++

```

void ReapThread::add(const CartPrx& proxy, const CartIPtr& cart)
{
    Lock sync(*this);
    _carts.push_back(CartProxyPair(proxy, cart));
}

```

The `run` method of the reaper thread is a loop that sleeps for ten minutes and calls `destroy` on any session that has not been refreshed within the preceding ten minutes:

C++

```

void ReapThread::run()
{
    Lock sync(*this);
    while (true) {
        timedWait(_timeout);
        list<CartProxyPair>::iterator p = _carts.begin();
        while (p != _carts.end()) {
            try {
                //
                // Cart destruction may take some time.
                // Therefore the current time is computed
                // for each iteration.
                //
                if ((IceUtil::Time::now() - p->cart->timestamp()) >
                    _timeout) {
                    p->proxy->destroy();
                    p = _carts.erase(p);
                } else {
                    ++p;
                }
            } catch (const Ice::ObjectNotExistException&) {
                p = _carts.erase(p);
            }
        }
    }
}

```

Note that the reaper thread catches `ObjectNotExistException` from the call to `destroy`, and removes the cart from its list in that case. This is necessary because it is possible for a client to call `destroy` explicitly, so a cart may be destroyed already by the time the reaper thread examines it.

The `CartFactory` implementation is trivial:

C++

```

class CartFactoryI : CartFactory
{
public:
    CartFactoryI(const ReapThreadPtr&);
    virtual CartPrx create(const std::string&, const Ice::Current&);

private:
    ReapThreadPtr _reaper;
};

```

The constructor is passed the instantiated reaper thread and remembers that thread in the `_reaper` member.

The `create` method adds each new cart to the reaper thread's list of carts:

```

C++

CartPrx CartFactoryI::create(const string& name, const Ice::Current& c)
{
    CartIPtr cart = new CartI(name);
    CartPrx proxy = CartPrx::uncheckedCast(
        c.adapter->addWithUUID(cart));
    _reaper->add(proxy, cart);

    return proxy;
}
```

Note that each cart internally has a unique ID that is unrelated to its name — the name exists purely as a convenience for the application.

The server's `main` function starts the reaper thread and instantiates the cart factory:

```

C++

ReapThreadPtr reaper = new ReapThread();
CartFactory factory = new CartFactoryI(reaper);
reaper->start();
adapter->add(factory, Ice::stringToIdentity(CartFactory));
adapter->activate();
```

This completes the implementation on the server side. Note that there is very little code here, and that much of this code is essentially the same for each application. For example, we could easily turn the `ReapThread` class into a template class to permit the same code to be used for something other than shopping carts.

Client-Side Changes for Garbage Collection

On the client side, the application code does what it would do with an ordinary factory, except for the extra level of indirection: the client first creates a cart, and then uses the cart as its factory.

As long as the client-side calls `refresh` at least once every ten minutes, the cart remains alive and, with it, all items the client created in that cart. Once the client misses a `refresh` call, the reaper thread in the server cleans up the cart and its items.

To keep the cart alive, you could sprinkle your application code with calls to `refresh` in the hope that at least one of these calls is made at least every ten minutes. However, that is not only error-prone, but also fails if the client blocks for some time. A much better approach is to run a thread in the client that automatically calls `refresh`. That way, the calls are guaranteed to happen even if the client's main thread blocks for some time, and the application code does not get polluted with `refresh` calls. Again, we show a simplified version of the refresh thread here that does not deal with issues such as clean shutdown and a few other irrelevant details:

C++

```

class CartRefreshThread : public IceUtil::Thread,
                          public IceUtil::Monitor<IceUtil::Mutex>
{
public:
    CartRefreshThread(const IceUtil::Time& timeout, const CartPrx& cart)
    :
        _cart(cart),
        _timeout(timeout) {}

    virtual void run() {
        Lock sync(*this);
        while(true) {
            timedWait(_timeout);
            try {
                _cart->refresh();
            } catch(const Ice::Exception& ex) {
                return;
            }
        }
    }

private:
    const CartPrx _cart;
    const IceUtil::Time _timeout;
};

typedef IceUtil::Handle<CartRefreshThread> CartRefreshThreadPtr;

```

The client's `main` function instantiates the reaper thread after creating a cart. We assume that the client has a proxy to the cart factory in the `factory` variable:

C++

```

CartPrx cart = factory->create(name);
CartRefreshThreadPtr refresh = new
CartRefreshThread(IceUtil::Time::seconds(480), cart);
refresh->start();

```

Note that, to be on the safe side and also allow for some network delays, the client calls `refresh` every eight minutes; this is to ensure that at least one call to `refresh` arrives at the server within each ten-minute interval.

See Also

- [Object Life Cycle](#)

Dynamic Ice

The Ice streaming API allows you to serialize and deserialize Slice types using either the Ice encoding or an encoding of your choice (for example, XML). This is useful, for example, if you want to store Slice types in a data base.

The dynamic invocation and dispatch interfaces allow you to write generic clients and servers that need not have compile-time knowledge of the Slice types used by an application. This makes it possible to create applications such as object browsers, protocol analyzers, or protocol bridges. In addition, the dynamic invocation and dispatch interfaces permit services such as IceStorm to be implemented without the need to unmarshal and remarshal every message, with considerable performance improvements.

Keep in mind that applications that use dynamic invocation and dispatch are tedious to implement and harder to prove correct (because what normally would be a compile-time error appears only as a run-time error with dynamic invocation and dispatch). Therefore, you should use the dynamic interfaces only if your application truly benefits from this trade-off.

Topics

- [Streaming Interfaces](#)
- [Dynamic Invocation and Dispatch](#)
- [Asynchronous Dynamic Invocation and Dispatch](#)

Streaming Interfaces

Ice provides convenient interfaces for streaming Slice types to and from a sequence of bytes. You can use these interfaces in many situations, such as when serializing types for persistent storage, and when using Ice's [dynamic invocation and dispatch facility](#).

The streaming interfaces are not defined in Slice, but are rather a collection of native classes provided by each language mapping.

 The streaming interfaces are currently supported in C++, Java, and .NET.

A default implementation of the interfaces uses the [Ice encoding](#), but other implementations are possible.

There are two primary abstract classes: `InputStream` and `OutputStream`. As you might guess, `InputStream` is used to extract Slice types from a sequence of bytes, while `OutputStream` is used to convert Slice types into a sequence of bytes. The classes provide the functions necessary to manipulate all of the core Slice types:

- Primitives (`bool`, `int`, `string`, etc.)
- Sequences of primitives
- Proxies
- Objects

The classes also provide functions that handle various details of the Ice encoding. Using these functions, you can manually insert and extract constructed types, such as dictionaries and structures, but doing so is tedious and error-prone. To make insertion and extraction of constructed types easier, the Slice compilers can optionally generate helper functions that manage the low-level details for you.

The remainder of this section describes the streaming interfaces for each supported language mapping. To properly use the streaming interfaces, you should be familiar with the [Ice encoding](#). An example that demonstrates the use of the streaming interfaces is located in `demo/ice/invoke` in your Ice distribution.

Topics

- [C++ Streaming Interfaces](#)
- [Java Streaming Interfaces](#)
- [C-Sharp Streaming Interfaces](#)

See Also

- [Dynamic Invocation and Dispatch](#)
- [Data Encoding](#)

C++ Streaming Interfaces

We discuss the stream classes first, followed by the helper functions, and finish with an advanced use case.

Topics

- The InputStream Interface in C++
- The OutputStream Interface in C++
- Intercepting Object Insertion and Extraction in C++
- Intercepting User Exception Insertion and Extraction in C++

The `InputStream` Interface in C++

On this page:

- [The `InputStream` API in C++](#)
- [Extracting from an `InputStream` in C++](#)
- [Extracting Sequences of Built-In Types using Zero-Copy in C++](#)
- [Other `InputStream` Methods in C++](#)

The `InputStream` API in C++

An `InputStream` that uses the Ice encoding can be created using the following functions:

C++

```

namespace Ice {
    InputStreamPtr createInputStream(
        const CommunicatorPtr& communicator,
        const std::vector<Ice::Byte>& data);

    InputStreamPtr createInputStream(
        const CommunicatorPtr& communicator,
        const std::vector<Ice::Byte>& data,
        const EncodingVersion& version);

    InputStreamPtr createInputStream(
        const CommunicatorPtr& communicator,
        const std::pair<const Ice::Byte*, const Ice::Byte*>& data);

    InputStreamPtr createInputStream(
        const CommunicatorPtr& communicator,
        const std::pair<const Ice::Byte*, const Ice::Byte*>& data,
        const EncodingVersion& version);

    InputStreamPtr wrapInputStream(
        const CommunicatorPtr& communicator,
        const std::vector<Ice::Byte>& data);

    InputStreamPtr wrapInputStream(
        const CommunicatorPtr& communicator,
        const std::vector<Ice::Byte>& data,
        const EncodingVersion& version);

    InputStreamPtr wrapInputStream(
        const CommunicatorPtr& communicator,
        const std::pair<const Ice::Byte*, const Ice::Byte*>& data);

    InputStreamPtr wrapInputStream(
        const CommunicatorPtr& communicator,
        const std::pair<const Ice::Byte*, const Ice::Byte*>& data,
        const EncodingVersion& version);
}

```

You can optionally specify an encoding version for the stream, otherwise the stream uses the communicator's default encoding version.

Note that the `createInputStream` functions make a copy of the supplied data, whereas the `wrapInputStream` functions avoid copies by keeping a reference to the data. If you use `wrapInputStream`, it is your responsibility to ensure that the memory buffer remains valid and unmodified for the lifetime of the `InputStream` object.

The `InputStream` class is shown below.

C++

```

namespace Ice {
    class InputStream : ... {
    public:
        virtual CommunicatorPtr communicator() const = 0;

        virtual void sliceObjects(bool slice) = 0;

        virtual void read(bool& v) = 0;
        virtual void read(Byte& v) = 0;
        virtual void read(Short& v) = 0;
        virtual void read(Int& v) = 0;
        virtual void read(Long& v) = 0;
        virtual void read(Float& v) = 0;
        virtual void read(Double& v) = 0;
        virtual void read(std::string& s, bool convert = true) = 0;
        virtual void read(std::vector<std::string>& s, bool convert) =
0;
        virtual void read(std::wstring& s) = 0;

        virtual void read(::std::vector<bool>&) = 0;

        Int readEnum(Int maxValue) { ... }

        template<typename T> inline void
        read(T& v) { ... }

        virtual void read(std::vector<std::string>& v,
bool convert) = 0;

        virtual void read(std::pair<const bool*, const bool*>&,
IceUtil::ScopedArray<bool>&) = 0;

        virtual void read(std::pair<const Byte*, const Byte*>&) = 0;

        virtual void read(std::pair<const Short*, const Short*>&,
IceUtil::ScopedArray<Short>&) = 0;

        virtual void read(std::pair<const Int*, const Int*>&,
IceUtil::ScopedArray<Int>&) = 0;

        virtual void read(std::pair<const Long*, const Long*>&,
IceUtil::ScopedArray<Long>&) = 0;

        virtual void read(std::pair<const Float*, const Float*>&,
IceUtil::ScopedArray<Float>&) = 0;

        virtual void read(std::pair<const Double*, const Double*>&,
IceUtil::ScopedArray<Double>&) = 0;

        virtual Int readSize() = 0;
    };
}

```

```

virtual Int readAndCheckSeqSize(int minWireSize) = 0;

virtual ObjectPrx readProxy() = 0;

template<typename T> inline void
read(IceInternal::ProxyHandle<T>& v) { ... }

virtual void readObject(const ReadObjectCallbackPtr& cb) = 0;

template<typename T> inline void
read(IceInternal::Handle<T>& v) { ... }

virtual void throwException() = 0;
virtual void throwException(const
UserExceptionReaderFactoryPtr&) = 0;

virtual void startObject() = 0;
virtual SlicedDataPtr endObject(bool preserve) = 0;

virtual void startException() = 0;
virtual SlicedDataPtr endException(bool preserve) = 0;

virtual std::string startSlice() = 0;
virtual void endSlice() = 0;
virtual void skipSlice() = 0;

virtual EncodingVersion startEncapsulation() = 0;
virtual void endEncapsulation() = 0;
virtual EncodingVersion skipEncapsulation() = 0;

virtual EncodingVersion getEncoding() = 0;

virtual void readPendingObjects() = 0;

virtual void rewind() = 0;

virtual void skip(Int sz) = 0;
virtual void skipSize() = 0;

virtual bool readOptional(Int tag, OptionalFormat fmt) = 0;

virtual void closure(void* p) = 0;
virtual void* closure() const = 0;
};

```

```

    typedef ... InputStreamPtr;
}

```

Extracting from an InputStream in C++

An `InputStream` provides a number of overloaded `read` member functions that allow you to read any parameter from the stream by simply calling `read`.

For example, you can extract a double value followed by a string from a stream as follows:

```

C++
vector<Ice::Byte> data = ...;
in = Ice::createInputStream(communicator, data);
double d;
in->read(d);
string s;
in->read(s);

```

Likewise, you can extract a sequence of a built-in type, or a complex type, or any other type from the stream as follows:

```

C++
vector<Ice::Byte> data = ...;
in = Ice::createInputStream(communicator, data);
// ...
IntSeq s; // Slice: sequence<int> IntSeq;
in->read(s);

ComplexType c;
in->read(c);

```

Extracting Sequences of Built-In Types using Zero-Copy in C++

`InputStream` provides a number of overloads that accept a pair of pointers. For example, you can extract a sequence of bytes as follows:

```

C++
vector<Ice::Byte> data = ...;
in = Ice::wrapInputStream(communicator, data);
std::pair<const Ice::Byte*, const Ice::Byte*> p;
in->read(p);

```

The same extraction works for the other built-in integral and floating-point types, such `int` and `double`.

If the extraction is for a byte sequence, the returned pointers always point at memory in the stream's internal marshaling buffer.

For the other built-in types, the pointers refer to the internal marshaling buffer only if the Ice encoding is compatible with the machine and compiler representation of the type, otherwise the pointers refer to a temporary array allocated to hold the unmarshaled data. The overloads

for zero-copy extraction accept an additional parameter of type `IceUtil::ScopedArray` that holds this temporary array when necessary.

Here is an example to illustrate how to extract a sequence of integers, regardless of whether the machine's encoding of integers matches the on-the-wire representation or not:

```

C++

#include <IceUtil/ScopedArray.h>
...
in = Ice::wrapInputStream(communicator, data);
std::pair<const Ice::Int*, const Ice::Int*> p;
IceUtil::ScopedArray<Ice::Int> a;
in->read(p, a);

for(const Ice::Int* i = p.first; i != p.second; ++i) {
    cout << *i << endl;
}

```

If the on-the-wire encoding matches that of the machine, and therefore zero-copy is possible, the returned pair of pointers points into the run time's internal marshaling buffer. Otherwise, the run time allocates an array, unmarshals the data into the array, and sets the pair of pointers to point into that array. Use of the `ScopedArray` helper template ensures that the array is deallocated once you let the `ScopedArray` go out of scope, so there is no need to call `delete[]`. `ScopedArray` is comparable to a `std::unique_ptr` for arrays.

Other InputStream Methods in C++

The remaining member functions of `InputStream` have the following semantics:

- `void sliceObjects(bool slice)`
Determines the behavior of the stream when extracting `Ice` objects. An `Ice` object is "sliced" when a factory cannot be found for a `Slice type ID`, resulting in the creation of an object of a less-derived type. Slicing is typically disabled when the application expects all object factories to be present, in which case the exception `NoObjectFactoryException` is raised. The default behavior is to allow slicing.
- `void read(std::string& v, bool convert = true)`
`void read(std::vector<std::string>& v, bool convert)`
The boolean argument determines whether the strings unmarshaled by these methods are processed by the `string converter`, if one is installed. The default behavior is to convert the strings.
- `Int readEnum(Int maxValue)`
Unmarshals the integer value of an enumerator. The `maxValue` argument represents the highest enumerator value in the `enumeration`. Consider the following definitions:

```

Slice

enum Color { red, green, blue };
enum Fruit { Apple, Pear=3, Orange };

```

The maximum value for `Color` is 2, and the maximum value for `Fruit` is 4.

In general, you should simply use `read` for your enum values. `read` with an enum parameter calls `readEnum` with the `maxValue` provided by the code generated by `slice2cpp`.

- `Ice::Int readSize()`
The `Ice` encoding has a compact representation to indicate size. This function extracts a size and returns it as an integer.

- `Ice::Int readAndCheckSeqSize(int minWireSize)`
Like `readSize`, this function reads a size and returns it, but also verifies that there is enough data remaining in the unmarshaling buffer to successfully unmarshal the elements of the sequence. The `minWireSize` parameter indicates the smallest possible [on-the-wire representation](#) of a single sequence element. If the unmarshaling buffer contains insufficient data to unmarshal the sequence, the function throws `UnmarshalOutOfBoundsException`.
- `Ice::ObjectPrx readProxy()`
This function returns an instance of the base proxy type, `ObjectPrx`. Calling `read` with a proxy parameter has the same effect.
- `void readObject(const Ice::ReadObjectCallbackPtr &)`
The [Ice encoding for class instances](#) requires extraction to occur in stages. The `readObject` function accepts a callback object of type `ReadObjectCallback`, whose definition is shown below:

```

C++

namespace Ice {
    class ReadObjectCallback : ... {
    public:
        virtual void invoke(const Ice::ObjectPtr&) = 0;
    };
    typedef ... ReadObjectCallbackPtr;
}

```

When the object instance is available, the callback object's `invoke` member function is called. The application must call `readPendingObjects` to ensure that all instances are properly extracted. If you are not interested in receiving a callback when the object is extracted, it is easier to call `read` with a `Ptr` parameter. Note that calling `endEncapsulation` implicitly calls `readPendingObjects` if necessary.

- `void throwException()`
`void throwException(const UserExceptionReaderFactoryPtr& factory)`
These functions [extract a user exception](#) from the stream and throw it. If the stored exception is of an unknown type, the functions attempt to extract and throw a less-derived exception. If that also fails, an exception is thrown: for the 1.0 encoding, the exception is `UnmarshalOutOfBoundsException`, for the 1.1 encoding, the exception is `UnknownUserException`.
- `void startObject()`
`SlicedDataPtr endObject(bool preserve)`
The `startObject` method must be called prior to reading the slices of an object. The `endObject` method must be called after all slices have been read. Pass true to `endObject` in order to preserve the slices of any unknown more-derived types, or false to discard the slices. If `preserve` is true and the stream actually preserved any slices, the return value of `endObject` is a non-nil `SlicedData` object that encapsulates the slice data. If the caller later wishes to forward the object with any preserved slices intact, it must supply this `SlicedData` object to the output stream.
- `void startException()`
`SlicedDataPtr endException(bool preserve)`
The `startException` method must be called prior to reading the slices of an exception. The `endException` method must be called after all slices have been read. Pass true to `endException` in order to preserve the slices of any unknown more-derived types, or false to discard the slices. If `preserve` is true and the stream actually preserved any slices, the return value of `endException` is a non-nil `SlicedData` object that encapsulates the slice data. If the caller later wishes to forward the exception with any preserved slices intact, it must supply this `SlicedData` object to the output stream.
- `std::string startSlice()`
`void endSlice()`
`void skipSlice()`

Start, end, and skip a slice of member data, respectively. These functions are used when manually extracting the slices of an [Ice object](#) or [user exception](#). The `startSlice` method returns the [type ID](#) of the next slice, which may be an empty string depending on the format used to encode the object or exception.

- `EncodingVersion startEncapsulation()`
`void endEncapsulation()`
`EncodingVersion skipEncapsulation()`
 Start, end, and skip an [encapsulation](#), respectively. The `startEncapsulation` and `skipEncapsulation` methods return the encoding version used to encode the contents of the encapsulation.
- `EncodingVersion getEncoding()`
 Returns the encoding version currently in use by the stream.
- `void readPendingObjects()`
 An application must call this function after all other data has been extracted. This function extracts the state of Ice objects and invokes their corresponding callback objects (see `readObject`). For backward compatibility with encoding version 1.0, this function must only be called when non-optional data members or parameters use class types.
- `void rewind()`
 Resets the position of the stream to the beginning.
- `void skip(Int sz)`
 Skips the given number of bytes.
- `void skipSize()`
 Reads a size at the current position and skips that number of bytes.
- `bool readOptional(Int tag, OptionalFormat fmt)`
 Returns true if an optional value with the given tag and format is present, or false otherwise. If this method returns true, the data associated with that optional value must be read next. Optional values must be read in order by tag from least to greatest. The `OptionalFormat` enumeration is defined as follows:

C++

```

namespace Ice {
    enum OptionalFormat {
        OptionalFormatF1, OptionalFormatF2, OptionalFormatF4,
        OptionalFormatF8,
        OptionalFormatSize, OptionalFormatVSize,
        OptionalFormatFSize,
        OptionalFormatEndMarker
    };
}

```

Refer to the [encoding](#) discussion for more information on the meaning of these values.

- `void closure(void* p)`
`void* closure() const`
 Allows an arbitrary value to be associated with the stream.

See Also

- [Smart Pointers for Classes](#)
- [slice2cpp Command-Line Options](#)
- [C++ Strings and Character Encoding](#)
- [Data Encoding for Classes](#)
- [Basic Data Encoding](#)

- [The C++ ScopedArray Template](#)

The OutputStream Interface in C++

On this page:

- [The OutputStream API in C++](#)
- [Inserting into an OutputStream in C++](#)
- [Inserting Sequences of Built-In Types using Zero-Copy in C++](#)
- [Other OutputStream Member Functions in C++](#)

The OutputStream API in C++

An OutputStream is created using the following functions:

```

C++
namespace Ice {
    OutputStreamPtr createOutputStream(const CommunicatorPtr& communica
tor);

    OutputStreamPtr createOutputStream(constCommunicatorPtr&
communicator,
                                     const EncodingVersion& version);
}

```

You can optionally specify an encoding version for the stream, otherwise the stream uses the communicator's default encoding version.

The OutputStream class is shown below.

```

C++
namespace Ice {
    class OutputStream : ... {
    public:
        virtual CommunicatorPtr communicator() const = 0;

        virtual void write(bool) = 0;
        virtual void write(Byte) = 0;
        virtual void write(Short) = 0;
        virtual void write(Int) = 0;
        virtual void write(Long) = 0;
        virtual void write(Float) = 0;
        virtual void write(Double) = 0;
        virtual void write(const std::string& v, bool convert = true) =
0;

        virtual void write(const char* v, bool convert = true) = 0;
        virtual void write(const std::wstring&) = 0;
        virtual void write(const std::vector<bool>&) = 0;

        virtual void write(const bool* begin, const bool* end) = 0;
        virtual void write(const Byte* begin, const Byte* end) = 0;
        virtual void write(const Short* begin, const Short* end) = 0;
        virtual void write(const Int* begin, const Int* end) = 0;
    };
}

```

```

virtual void write(const Long* begin, const Long* end) = 0;
virtual void write(const Float* begin, const Float* end) = 0;
virtual void write(const Double* begin,
const Double* end) = 0;

virtual void write(const std::vector<std::string>& v,
bool convert) = 0;

void writeEnum(Int v, Int maxValue) { ... }

virtual bool writeOptional(Int tag, OptionalFormat fmt) = 0;

template<typename T> inline void
write(const T& v) { ... }

virtual void writeSize(Int sz) = 0;
virtual void startSize() = 0;
virtual void endSize() = 0;

virtual void writeProxy(const ObjectPrx& v) = 0;

template<typename T> inline void
write(const IceInternal::ProxyHandle<T>& v) { ... }

virtual void writeObject(const ObjectPtr&) = 0;

template<typename T> inline void
write(const IceInternal::Handle<T>& v) { ... }

virtual void writeException(const UserException& e) = 0;

virtual void startObject(const SlicedDataPtr& sd) = 0;
virtual void endObject() = 0;

virtual void startException(const SlicedDataPtr& sd) = 0;
virtual void endException() = 0;

virtual void startSlice(const std::string& typeId, bool last) =
0;
virtual void endSlice() = 0;

virtual void startEncapsulation(const EncodingVersion& v,
FormatType fmt) = 0;
virtual void startEncapsulation() = 0;
virtual void endEncapsulation() = 0;

virtual EncodingVersion getEncoding() const = 0;

virtual void writePendingObjects() = 0;

```

```
virtual void finished(std::vector<Byte>& v) = 0;  
virtual std::pair<const Byte*, const Byte*> finished() = 0;  
  
virtual size_type pos() = 0;  
virtual void rewrite(Int v, size_type pos) = 0;  
  
virtual void reset(bool) = 0;
```

```

    };
}

```

Inserting into an OutputStream in C++

An `OutputStream` provides a number of overloaded `write` member functions that allow you to insert any parameter into the stream by simply calling `write`.

For example, you can insert a double value followed by a string into a stream as follows:

```

C++
out = Ice::createOutputStream(communicator);
Ice::Double d = 3.14;
out->write(d);
string s = "Hello";
out->write(s);

```

Likewise, you can insert a sequence of built-in type, or a sequence of a complex constructed type, or any other type, with the same syntax:

```

C++
out = Ice::createOutputStream(communicator);
IntSeq s = ...;
out->write(s);

ComplexType c = ...;
out->write(c);

```

Inserting Sequences of Built-In Types using Zero-Copy in C++

`OutputStream` provides a number of overloads that accept a pair of pointers. For example, you can insert a sequence of bytes as follows:

```

C++
out = Ice::createOutputStream(communicator);
vector<Ice::Byte> data = ...;
out->write(&v[0], &v[v.size()]);

```

The same insertion technique works for the other built-in integral and floating-point types, such `int` and `double`. Insertion in this way can avoid an additional data copy during marshaling if the internal representation of the data in memory is the same as the on-the-wire representation. (Note that the two pointers must point at a contiguous block of memory.)

Other OutputStream Member Functions in C++

The remaining member functions of `OutputStream` have the following semantics:

- `void write(const std::string& v, bool convert = true)`
`void write(const char* v, bool convert = true)`
`void write(const std::vector<std::string>&, bool convert)`
 The boolean argument determines whether the strings marshaled by these methods are processed by the [string converter](#), if one is installed. The default behavior is to convert the strings.
- `void writeEnum(Int val, Int maxValue)`
 Writes the integer value of an enumerator. The `maxValue` argument represents the highest enumerator value in the [enumeration](#). Consider the following definitions:

```
Slice
```

```
enum Color { red, green, blue };
enum Fruit { Apple, Pear=3, Orange };
```

The maximum value for `Color` is 2, and the maximum value for `Fruit` is 4.

In general, you should simply use `write` for your enum values. `write` with an enum parameter calls `writeEnum` with the `maxValue` provided by the code generated by `slice2cpp`.

- `void writeSize(Ice::Int sz)`
 The [Ice encoding](#) has a compact representation to indicate size. This function converts the given non-negative integer into the proper encoded representation.
- `void startSize()`
`void endSize()`
 The encoding for optional values uses a 32-bit integer to hold the size of variable-length types. Calling `startSize` writes a placeholder value for the size; after writing the data, call `endSize` to patch the placeholder with the actual size.
- `bool writeOptional(Int tag, OptionalFormat fmt)`
 Prepares the stream to write an optional value with the given tag and format. Returns true if the value should be written, or false otherwise. A return value of false indicates that the encoding version in use by the stream does not support optional values. If this method returns true, the data associated with that optional value must be written next. Optional values must be written in order by tag from least to greatest. The `OptionalFormat` enumeration is defined as follows:

```
C++
```

```
namespace Ice {
    enum OptionalFormat {
        OptionalFormatF1, OptionalFormatF2, OptionalFormatF4,
        OptionalFormatF8,
        OptionalFormatSize, OptionalFormatVSize,
        OptionalFormatFSize,
        OptionalFormatEndMarker
    };
}
```

Refer to the [encoding](#) discussion for more information on the meaning of these values.

- `void writeProxy(const Ice::ObjectPrx&)`
 Inserts a proxy into the stream. It is equivalent to calling `write` with a proxy parameter.
- `void writeObject(const Ice::ObjectPtr&)`
 Inserts an Ice object. The [Ice encoding for class instances](#) may cause the insertion of this object to be delayed, in which case the stream retains a reference to the given object and the stream does not insert its state until `writePendingObjects` is invoked on

the stream. It is equivalent to calling `write` with a `Ptr` parameter.

- `void writeException(const Ice::UserException & ex)`
Inserts a [user exception](#). It is equivalent to calling `write` with a user exception. The exception argument may be an instance of `UserExceptionWriter`, which allows you to [implement your own exception marshaling logic](#).
- `void startObject(const SlicedDataPtr& sd)`
`void endObject()`
When marshaling the slices of an object, the application must first call `startObject`, then marshal the slices, and finally call `endObject`. The caller can pass a `SlicedData` object containing the preserved slices of unknown more-derived types, or 0 if there are no preserved slices.
- `void startException(const SlicedDataPtr& sd)`
`void endException()`
When marshaling the slices of an exception, the application must first call `startException`, then marshal the slices, and finally call `endException`. The caller can pass a `SlicedData` object containing the preserved slices of unknown more-derived types, or 0 if there are no preserved slices.
- `void startSlice(const std::string& typeId, bool last)`
`void endSlice()`
Starts and ends a slice of [object](#) or [exception](#) member data. The call to `startSlice` must include the type ID for the current slice, and a boolean indicating whether this is the last slice of the object or exception.
- `void startEncapsulation(const EncodingVersion& v, FormatType fmt)`
`void startEncapsulation()`
`void endEncapsulation()`
Starts and ends an [encapsulation](#), respectively. The first overloading of `startEncapsulation` allows you to specify the encoding version as well as the format to use for any objects and exceptions marshaled within this encapsulation.
- `EncodingVersion getEncoding()`
Returns the encoding version currently being used by the stream.
- `void writePendingObjects()`
Encodes the state of [Ice objects](#) whose insertion was delayed during `writeObject`. This member function must only be called once. For backward compatibility with encoding version 1.0, this function must only be called when non-optional data members or parameters use class types.
- `void finished(std::vector< Ice::Byte >& data)`
`std::pair<const Byte*, const Byte*> finished()`
Indicates that marshaling is complete. This member function must only be called once. In the first overloading, the given byte sequence is filled with a copy of the encoded data. The second overloading avoids a copy by returning a pair of pointers to the stream's internal memory; these pointers are valid for the lifetime of the `OutputStream` object.
- `size_type pos()`
`void rewrite(Int v, size_type pos)`
The `pos` method returns the stream's current position, and `rewrite` allows you to overwrite a 32-bit integer value at the given position in the stream. Calling `rewrite` does not change the stream's current position.
- `void reset(bool clearBuffer)`
Resets the writing position of the stream to the beginning. If `clearBuffer` is true, the stream releases the memory it has allocated to hold the encoded data.

See Also

- [Basic Data Encoding](#)
- [slice2cpp Command-Line Options](#)
- [C++ Strings and Character Encoding](#)
- [Data Encoding for Classes](#)
- [Data Encoding for Exceptions](#)

Intercepting Object Insertion and Extraction in C++

In some situations it may be necessary for an application to intercept the insertion and extraction of Ice objects. For example, the [Ice extension for PHP](#) is implemented using Ice for C++ but represents Ice objects as native PHP objects. The PHP extension accomplishes this by manually encoding and decoding Ice objects as directed by the [data encoding](#) rules. However, the extension obviously cannot pass a native PHP object to the C++ stream function for writing objects. To bridge this gap between object systems, Ice supplies the helper classes described below.

On this page:

- [Inserting Objects in C++](#)
- [Extracting Objects in C++](#)

Inserting Objects in C++

The `ObjectWriter` base class facilitates the insertion of objects to a stream:

C++

```

namespace Ice {
    class ObjectWriter : public Ice::Object {
    public:
        virtual void write(const OutputStreamPtr&) const = 0;
        // ...
    };
    typedef ... ObjectWriterPtr;
}

```

A foreign Ice object is inserted into a stream using the following technique:

1. A C++ "wrapper" class is derived from `ObjectWriter`. This class wraps the foreign object and implements the `write` member function.
2. An instance of the wrapper class is passed to `writeObject`. (This is possible because `ObjectWriter` derives from `Ice::Object`.) Eventually, the `write` member function is invoked on the wrapper instance.
3. The implementation of `write` encodes the object's state as directed by the [data encoding rules for classes](#).

It is the application's responsibility to ensure that there is a one-to-one mapping between foreign Ice objects and wrapper objects. This is necessary in order to ensure the proper encoding of object graphs.

Extracting Objects in C++

The `ObjectReader` class facilitates the extraction of objects from a stream:

C++

```

namespace Ice {
    class ObjectReader : public Ice::Object {
    public:
        virtual void read(const InputStreamPtr&) = 0;
        // ...
    };
    typedef ... ObjectReaderPtr;

    class CompactIdResolver : public IceUtil::Shared {
    public:
        virtual std::string resolve(Ice::Int) const = 0;
    };
    typedef ... CompactIdResolverPtr;
}

```

Extracting the state of a foreign Ice object is more complicated than insertion:

1. A C++ "wrapper" class is derived from `ObjectReader`. An instance of this class represents a foreign Ice object.
2. An [object factory](#) is installed that returns instances of the wrapper class. Note that a single object factory can be used for all Slice types if it is registered with an empty Slice type ID.
3. A C++ callback class is derived from `ReadObjectCallback`. The implementation of `invoke` expects its argument to be either nil or an instance of the wrapper class as returned by the object factory.
4. An instance of the callback class is passed to `readObject`.
5. When the stream is ready to extract the state of an object, it invokes `read` on the wrapper class. The implementation of `read` decodes the object's state as directed by the [data encoding rules for classes](#).
6. The callback object passed to `readObject` is invoked, passing the instance of the wrapper object. All other callback objects representing the same instance in the stream (in case of object graphs) are invoked with the same wrapper object.

If your class definitions use [compact type IDs](#), you must also supply an implementation of `CompactIdResolver` when [initializing the communicator](#). This object is responsible for translating numeric type IDs into their string equivalents.

See Also

- [Client-Side Slice-to-PHP Mapping](#)
- [Data Encoding](#)
- [Data Encoding for Classes](#)
- [C++ Mapping for Classes](#)
- [Communicator Initialization](#)

Intercepting User Exception Insertion and Extraction in C++

Inserting a User Exception in C++

As in the case of [Ice objects](#), a Dynamic Ice application may represent user exceptions in a native format that is not directly compatible with the Ice API. If the application needs to raise such a user exception to the Ice run time (so that it will be marshaled and sent back to the client), the exception must be wrapped in a subclass of `Ice::UserException`. The Dynamic Ice API provides a class to simplify this process:

```

C++

namespace Ice {
  class UserExceptionWriter : public UserException {
  public:
    UserExceptionWriter(const CommunicatorPtr&);

    virtual void write(const OutputStreamPtr&) const = 0;

    virtual std::string ice_name() const = 0;
    virtual Ice::Exception* ice_clone() const = 0;
    virtual void ice_throw() const = 0;

    // ...
  };
  typedef ... UserExceptionWriterPtr;
}

```

A subclass of `UserExceptionWriter` is responsible for supplying a communicator to the constructor, and for implementing the following methods:

- `void write(const OutputStreamPtr&) const`
This method is invoked when the Ice run time is ready to marshal the exception. The subclass must marshal the exception using the [encoding rules for exceptions](#).
- `std::string ice_name() const`
Return the Slice name of the exception.
- `Ice::Exception* ice_clone() const`
Return a copy of the exception.
- `void ice_throw() const`
Raise the exception by calling `throw *this`.

Extracting a User Exception in C++

An application extracts a user exception by calling one of two versions of the `throwException` method defined in the [InputStream](#) class:

C++

```

namespace Ice {
    class InputStream : ... {
    public:
        virtual void throwException() = 0;
        virtual void throwException(const
UserExceptionReaderFactoryPtr&) = 0;

        // ...
    };
}

```

The version without any arguments attempts to locate and throw a C++ implementation of the encoded exception, relying on statically-generated type information emitted by the Slice-to-C++ compiler.

If your goal is to create an exception in another type system, such as a native PHP exception object, you must call the second version of `throwException` and pass an implementation of `UserExceptionReaderFactory`:

C++

```

namespace Ice {
    class UserExceptionReaderFactory : public IceUtil::Shared {
    public:
        virtual void createAndThrow(const std::string& typeId) const =
0;
    };
    typedef ... UserExceptionReaderFactoryPtr;
}

```

As the stream iterates over slices of an exception from most-derived to least-derived, it invokes `createAndThrow` passing the `type ID` of each slice, giving the application an opportunity to raise an instance of `UserExceptionReader`:

C++

```

namespace Ice {
  class UserExceptionReader : public UserException {
  public:
    UserExceptionReader(const CommunicatorPtr&);
    ~UserExceptionReader() throw();

    virtual void read(const InputStreamPtr&) const = 0;

    virtual std::string ice_name() const = 0;
    virtual UserException* ice_clone() const = 0;
    virtual void ice_throw() const = 0;
  protected:
    const CommunicatorPtr _communicator;
  };
}

```

Subclasses of `UserExceptionReader` must implement the pure virtual functions. In particular, the implementation of `read` must call `InputStream::startException`, unmarshal the remaining slices, and then call `InputStream::endException`.

See Also

- [Intercepting Object Insertion and Extraction in C++](#)
- [Data Encoding for Exceptions](#)

Java Streaming Interfaces

We discuss the stream classes first, followed by the helper functions, and finish with an advanced use case.

Topics

- [The InputStream Interface in Java](#)
- [The OutputStream Interface in Java](#)
- [Stream Helper Functions in Java](#)
- [Intercepting Object Insertion and Extraction in Java](#)
- [Intercepting User Exception Insertion and Extraction in Java](#)

The InputStream Interface in Java

An `InputStream` is created using the following functions:

```

Java
package Ice;

public class Util {
    public static InputStream
        createInputStream(Communicator communicator, byte[] data);

    public static InputStream
        createInputStream(Communicator communicator, byte[] data,
            EncodingVersion version);

    public static InputStream
        wrapInputStream(Communicator communicator, byte[] data);

    public static InputStream
        wrapInputStream(Communicator communicator, byte[] data,
            EncodingVersion version);
}

```

You can optionally specify an encoding version for the stream, otherwise the stream uses the communicator's default encoding version.

Note that the `createInputStream` functions make a copy of the supplied data, whereas the `wrapInputStream` functions avoid copies by keeping a reference to the data. If you use `wrapInputStream`, it is your responsibility to ensure that the byte array remains unmodified for the lifetime of the `InputStream` object.

The `InputStream` interface is shown below.

```

Java
package Ice;

public interface InputStream {
    Communicator communicator();

    void sliceObjects(boolean slice);

    boolean readBool();
    boolean[] readBoolSeq();

    byte readByte();
    byte[] readByteSeq();

    short readShort();
    short[] readShortSeq();

    int readInt();
}

```

```
int[] readIntSeq();

long readLong();
long[] readLongSeq();

float readFloat();
float[] readFloatSeq();

double readDouble();
double[] readDoubleSeq();

String readString();
String[] readStringSeq();

int readSize();
int readAndCheckSeqSize(int minSizeWireSize);

ObjectPrx readProxy();

void readObject(ReadObjectCallback cb);

int readEnum(int maxValue);

void throwException() throws UserException;
void throwException(UserExceptionReaderFactory factory) throws
UserException;

void startObject();
SlicedData endObject(boolean preserve);

void startException();
SlicedData endException(boolean preserve);

String startSlice();
void endSlice();
void skipSlice();

EncodingVersion startEncapsulation();
void endEncapsulation();
EncodingVersion skipEncapsulation();

EncodingVersion getEncoding();

void readPendingObjects();
java.io.Serializable readSerializable();

void rewind();

void skip(int sz);
void skipSize();
```

```
boolean readOptional(int tag, OptionalFormat format);  
  
int pos();
```

```

    void destroy();
}

```

Member functions are provided for extracting all of the primitive types, as well as sequences of primitive types; these are self-explanatory. The remaining member functions have the following semantics:

- `void sliceObjects(boolean slice)` Determines the behavior of the stream when extracting [Ice objects](#). An Ice object is "sliced" when a factory cannot be found for a [Slice type ID](#), resulting in the creation of an object of a less-derived type. Slicing is typically disabled when the application expects all object factories to be present, in which case the exception `NoObjectFactoryException` is raised. The default behavior is to allow slicing.
- `int readSize()`
The [Ice encoding](#) has a compact representation to indicate size. This function extracts a size and returns it as an integer.
- `int readAndCheckSeqSize(int minWireSize)`
Like `readSize`, this function reads a size and returns it, but also verifies that there is enough data remaining in the unmarshaling buffer to successfully unmarshal the elements of the sequence. The `minWireSize` parameter indicates the smallest possible [on-the-wire representation](#) of a single sequence element. If the unmarshaling buffer contains insufficient data to unmarshal the sequence, the function throws `UnmarshalOutOfBoundsException`.
- `Ice.ObjectPrx readProxy()`
This function returns an instance of the base proxy type, `ObjectPrx`. The Slice compiler optionally generates helper functions to extract proxies of user-defined types.
- `void readObject(ReadObjectCallback cb)`
The [Ice encoding for class instances](#) requires extraction to occur in stages. The `readObject` function accepts a callback object of type `ReadObjectCallback`, whose definition is shown below:

Java

```

package Ice;

public interface ReadObjectCallback {
    void invoke(Ice.Object obj);
}

```

When the object instance is available, the callback object's `invoke` member function is called. The application must call `readPendingObjects` to ensure that all instances are properly extracted. Note that applications rarely need to invoke this member function directly; the [helper functions](#) generated by the Slice compiler are easier to use.

- `int readEnum(int maxValue)`
Unmarshals the integer value of an enumerator. The `maxValue` argument represents the highest enumerator value in the enumeration. Consider the following definitions:

Slice

```

enum Color { red, green, blue };
enum Fruit { Apple, Pear=3, Orange };

```

The maximum value for `Color` is 2, and the maximum value for `Fruit` is 4.

- `void throwException()` throws `UserException`

```
void throwException(UserExceptionReaderFactory factory)
```

These functions [extract a user exception](#) from the stream and throw it. If the stored exception is of an unknown type, the functions attempt to extract and throw a less-derived exception. If that also fails, an exception is thrown: for the 1.0 encoding, the exception is `UnmarshalOutOfBoundsException`, for the 1.1 encoding, the exception is `UnknownUserException`.

- `String startSlice()`
`void endSlice()`
`void skipSlice()`
 Start, end, and skip a slice of member data, respectively. These functions are used when manually extracting the slices of an [Ice object](#) or [user exception](#). The `startSlice` method returns the [type ID](#) of the next slice, which may be an empty string depending on the format used to encode the object or exception.
- `void startObject()`
`SlicedData endObject(boolean preserve)`
 The `startObject` method must be called prior to reading the slices of an object. The `endObject` method must be called after all slices have been read. Pass true to `endObject` in order to preserve the slices of any unknown more-derived types, or false to discard the slices. If `preserve` is true and the stream actually preserved any slices, the return value of `endObject` is a non-nil `SlicedData` object that encapsulates the slice data. If the caller later wishes to forward the object with any preserved slices intact, it must supply this `SlicedData` object to the output stream.
- `void startException()`
`SlicedData endException(boolean preserve)`
 The `startException` method must be called prior to reading the slices of an exception. The `endException` method must be called after all slices have been read. Pass true to `endException` in order to preserve the slices of any unknown more-derived types, or false to discard the slices. If `preserve` is true and the stream actually preserved any slices, the return value of `endException` is a non-nil `SlicedData` object that encapsulates the slice data. If the caller later wishes to forward the exception with any preserved slices intact, it must supply this `SlicedData` object to the output stream.
- `EncodingVersion startEncapsulation()`
`void endEncapsulation()`
`EncodingVersion skipEncapsulation()`
 Start, end, and skip an [encapsulation](#), respectively. The `startEncapsulation` and `skipEncapsulation` methods return the encoding version used to encode the contents of the encapsulation.
- `EncodingVersion getEncoding()`
 Returns the encoding version currently in use by the stream.
- `void readPendingObjects()`
 An application must call this function after all other data has been extracted, but only if [Ice objects](#) were encoded. This function extracts the state of Ice objects and invokes their corresponding callback objects (see `readObject`). For backward compatibility with encoding version 1.0, this function must only be called when non-optional data members or parameters use class types.
- `java.io.Serializable readSerializable()`
 Reads a [serializable Java object](#) from the stream.
- `void rewind()`
 Resets the position of the stream to the beginning.
- `void skip(int sz)`
 Skips the given number of bytes.
- `void skipSize()`
 Reads a size at the current position and skips that number of bytes.
- `boolean readOptional(int tag, OptionalFormat fmt)`
 Returns true if an optional value with the given tag and format is present, or false otherwise. If this method returns true, the data associated with that optional value must be read next. Optional values must be read in order by tag from least to greatest. The `OptionalFormat` enumeration is defined as follows:

Java

```

package Ice;
enum OptionalFormat {
    OptionalFormatF1, OptionalFormatF2, OptionalFormatF4,
    OptionalFormatF8,
    OptionalFormatSize, OptionalFormatVSize, OptionalFormatFSize,
    OptionalFormatEndMarker
}

```

Refer to the [encoding](#) discussion for more information on the meaning of these values.

- `void destroy()`
Applications must call this function in order to reclaim resources.

Here is a simple example that demonstrates how to extract a boolean and a sequence of strings from a stream:

Java

```

byte[] data = ...
Ice.InputStream in =
    Ice.Util.createInputStream(communicator, data);
try {
    boolean b = in.readBool();
    String[] seq = in.readStringSeq();
} finally {
    in.destroy();
}

```

See Also

- [Basic Data Encoding](#)
- [Data Encoding for Classes](#)
- [Data Encoding for Exceptions](#)
- [Serializable Objects in Java](#)
- [Stream Helper Functions in Java](#)

The OutputStream Interface in Java

An `OutputStream` is created using the following function:

```

Java
package Ice;

public class Util {
    public static OutputStream
        createOutputStream(Communicator communicator);

    public static OutputStream
        createOutputStream(Communicator communicator, EncodingVersion
version);
}

```

You can optionally specify an encoding version for the stream, otherwise the stream uses the communicator's default encoding version.

The `OutputStream` class is shown below.

```

Java
package Ice;

public interface OutputStream {
    Communicator communicator();

    void writeBool(boolean v);
    void writeBoolSeq(boolean[] v);

    void writeByte(byte v);
    void writeByteSeq(byte[] v);

    void writeShort(short v);
    void writeShortSeq(short[] v);

    void writeInt(int v);
    void writeIntSeq(int[] v);

    void writeLong(long v);
    void writeLongSeq(long[] v);

    void writeFloat(float v);
    void writeFloatSeq(float[] v);

    void writeDouble(double v);
    void writeDoubleSeq(double[] v);

    void writeString(String v);
}

```

```
void writeStringSeq(String[] v);

void writeSize(int sz);

void writeProxy(ObjectPrx v);

void writeObject(Ice.Object v);

void writeEnum(int v, int maxValue);

void writeException(UserException ex);

void startObject(SlicedData sd);
void endObject();

void startException(SlicedData sd);
void endException();

void startSlice(String typeId, boolean last);
void endSlice();

void startEncapsulation(EncodingVersion encoding, FormatType
format);
void startEncapsulation();
void endEncapsulation();

EncodingVersion getEncoding();

void writePendingObjects();

boolean writeOptional(int tag, OptionalFormat format);

int pos();

void rewrite(int sz, int pos);

void startSize();
void endSize();

byte[] finished();

void reset(boolean clearBuffer);

void writeSerializable(java.io.Serializable o);
```



```

    void destroy();
}

```

Member functions are provided for inserting all of the primitive types, as well as sequences of primitive types; these are self-explanatory. The remaining member functions have the following semantics:

- `void writeSize(int sz)`
The [Ice encoding](#) has a compact representation to indicate size. This function converts the given non-negative integer into the proper encoded representation.
- `void writeProxy(Ice.ObjectPrx v)`
Inserts a proxy.
- `void writeObject(Ice.Object v)`
Inserts an Ice object. The [Ice encoding for class instances](#) may cause the insertion of this object to be delayed, in which case the stream retains a reference to the given object and does not insert its state until `writePendingObjects` is invoked on the stream.
- `void writeEnum(int val, int maxValue)`
Writes the integer value of an enumerator. The `maxValue` argument represents the highest enumerator value in the [enumeration](#). Consider the following definitions:

Slice

```

enum Color { red, green, blue };
enum Fruit { Apple, Pear=3, Orange };

```

The maximum value for `Color` is 2, and the maximum value for `Fruit` is 4.

- `void writeException(UserException ex)`
Inserts a [user exception](#). The exception argument may be an instance of `UserExceptionWriter`, which allows you to [implement your own exception marshaling logic](#).
- `void startObject(SlicedData sd)`
`void endObject()`
When marshaling the slices of an object, the application must first call `startObject`, then marshal the slices, and finally call `endObject`. The caller can pass a `SlicedData` object containing the preserved slices of unknown more-derived types, or 0 if there are no preserved slices.
- `void startException(SlicedData sd)`
`void endException()`
When marshaling the slices of an exception, the application must first call `startException`, then marshal the slices, and finally call `endException`. The caller can pass a `SlicedData` object containing the preserved slices of unknown more-derived types, or 0 if there are no preserved slices.
- `void startSlice(String typeId, boolean last)`
`void endSlice()`
Starts and ends a slice of [object](#) or [exception](#) member data. The call to `startSlice` must include the type ID for the current slice, and a boolean indicating whether this is the last slice of the object or exception.
- `void startEncapsulation(EncodingVersion encoding, FormatType format)`
`void startEncapsulation()`
`void endEncapsulation()`
Starts and ends an [encapsulation](#), respectively. The first overloading of `startEncapsulation` allows you to specify the encoding version as well as the format to use for any objects and exceptions marshaled within this encapsulation.
- `EncodingVersion getEncoding()`

Returns the encoding version currently being used by the stream.

- `void writePendingObjects()`
Encodes the state of Ice objects whose insertion was delayed during `writeObject`. This member function must only be called once. For backward compatibility with encoding version 1.0, this function must only be called when non-optional data members or parameters use class types.
- `boolean writeOptional(int tag, OptionalFormat fmt)`
Prepares the stream to write an optional value with the given tag and format. Returns true if the value should be written, or false otherwise. A return value of false indicates that the encoding version in use by the stream does not support optional values. If this method returns true, the data associated with that optional value must be written next. Optional values must be written in order by tag from least to greatest. The `OptionalFormat` enumeration is defined as follows:

Java
<pre>package Ice; enum OptionalFormat { OptionalFormatF1, OptionalFormatF2, OptionalFormatF4, OptionalFormatF8, OptionalFormatSize, OptionalFormatVSize, OptionalFormatFSize, OptionalFormatEndMarker }</pre>

Refer to the [encoding](#) discussion for more information on the meaning of these values.

- `int pos()`
`void rewrite(int sz, int pos)`
The `pos` method returns the stream's current position, and `rewrite` allows you to overwrite a 32-bit integer value at the given position in the stream. Calling `rewrite` does not change the stream's current position.
- `void startSize()`
`void endSize()`
The encoding for optional values uses a 32-bit integer to hold the size of variable-length types. Calling `startSize` writes a placeholder value for the size; after writing the data, call `endSize` to patch the placeholder with the actual size.
- `byte[] finished()`
Indicates that marshaling is complete and returns the encoded byte sequence. This member function must only be called once.
- `void reset(boolean clearBuffer)`
Resets the writing position of the stream to the beginning. The boolean argument `clearBuffer` determines whether the stream releases the internal buffer it allocated to hold the encoded data. If `clearBuffer` is true, the stream releases the buffer in order to make it eligible for garbage collection. If `clearBuffer` is false, the stream retains the buffer to avoid generating unnecessary garbage.
- `void writeSerializable(java.io.Serializable v)`
Writes a [serializable Java object](#) to the stream.
- `void destroy()`
Applications must call this function in order to reclaim resources.

Here is a simple example that demonstrates how to insert a boolean and a sequence of strings into a stream:

Java

```
final String[] seq = { "Ice", "rocks!" };
Ice.OutputStream out = Ice.Util.createOutputStream(communicator);
try {
    out.writeBool(true);
    out.writeStringSeq(seq);
    byte[] data = out.finished();
} finally {
    out.destroy();
}
```

See Also

- [Basic Data Encoding](#)
- [Data Encoding for Classes](#)
- [Data Encoding for Exceptions](#)
- [Serializable Objects in Java](#)

Stream Helper Functions in Java

The stream classes provide all of the low-level functions necessary for [encoding and decoding](#) Ice types. However, it would be tedious and error-prone to manually encode complex Ice types such as classes, structs, and dictionaries using these low-level functions. For this reason, the [Slice compiler](#) optionally generates helper functions for streaming complex Ice types.

We will use the following Slice definitions to demonstrate the language mapping:

```

Slice



```
module M {
 sequence<...> Seq;
 dictionary<...> Dict;
 struct S {
 ...
 };
 enum E { ... };
 class C {
 ...
 };
};
```

```

The Slice compiler generates the corresponding helper functions shown below:

Java

```

package M;

public class SeqHelper {
    public static T[] read(Ice.InputStream in);
    public static void write(Ice.OutputStream out, T[] v);
    public static void Ice.OptionalFormat optionalFormat();
}

public class DictHelper {
    public static java.util.Map read(Ice.InputStream in);
    public static void write(Ice.OutputStream out, java.util.Map<...,
...> v);
    public static void Ice.OptionalFormat optionalFormat();
}

public class SHelper {
    public static S read(Ice.InputStream in);
    public static void write(Ice.OutputStream out, S v);
    public static void Ice.OptionalFormat optionalFormat();
}

public class EHelper {
    public static E read(Ice.InputStream in);
    public static void write(Ice.OutputStream out, E v);
    public static void Ice.OptionalFormat optionalFormat();
}

public class CHelper {
    public static void read(Ice.InputStream in, CHolder h);
    public static void write(Ice.OutputStream out, C v);
    public static void Ice.OptionalFormat optionalFormat();
}

public class CPrxHelper {
    public static CPrx read(Ice.InputStream in);
    public static void write(Ice.OutputStream out, CPrx v);
    public static void Ice.OptionalFormat optionalFormat();
}

```

The `optionalFormat` method simplifies the task of writing [optional values](#).

The Slice compiler also generates the following member functions for `struct` and `enum` types:

Java

```
public class S ... {
    ...
    public void ice_read(Ice.InputStream in);
    public void ice_write(Ice.OutputStream out);
};
public class E... {
    ...
    public void ice_read(Ice.InputStream in);
    public void ice_write(Ice.OutputStream out);
}
```

Be aware that a call to `CHelper.read` does not result in the immediate extraction of an Ice object. The `value` member of the given `CHolder` object is updated when `readPendingObjects` is invoked on the [input stream](#).

See Also

- [Data Encoding](#)
- [Using the Slice Compiler for Java](#)
- [The InputStream Interface in Java](#)
- [Optional Values](#)

Intercepting Object Insertion and Extraction in Java

In some situations it may be necessary for an application to intercept the insertion and extraction of Ice objects. For example, the [Ice extension for PHP](#) is implemented using Ice for C++ but represents Ice objects as native PHP objects. The PHP extension accomplishes this by manually encoding and decoding Ice objects as directed by the [data encoding](#) rules. However, the extension obviously cannot pass a native PHP object to the C++ stream function for writing objects. To bridge this gap between object systems, Ice supplies the helper classes described below.

On this page:

- [Inserting Objects in Java](#)
- [Extracting Objects in Java](#)

Inserting Objects in Java

The `ObjectWriter` base class facilitates the insertion of objects to a stream:

```

Java

package Ice;

public abstract class ObjectWriter extends ObjectImpl {
    public abstract void write(OutputStream out);
    // ...
}
```

A foreign Ice object is inserted into a stream using the following technique:

1. A Java "wrapper" class is derived from `ObjectWriter`. This class wraps the foreign object and implements the `write` member function.
2. An instance of the wrapper class is passed to `writeObject`. (This is possible because `ObjectWriter` derives from `Ice.Object`.) Eventually, the `write` member function is invoked on the wrapper instance.
3. The implementation of `write` encodes the object's state as directed by the [data encoding rules for classes](#).

It is the application's responsibility to ensure that there is a one-to-one mapping between foreign Ice objects and wrapper objects. This is necessary in order to ensure the proper encoding of object graphs.

Extracting Objects in Java

The `ObjectReader` class facilitates the extraction of objects from a stream:

Java

```
package Ice;

public abstract class ObjectReader extends ObjectImpl {
    public abstract void read(InputStream in);
    // ...
}

public interface CompactIdResolver {
    String resolve(int id);
}
```

Extracting the state of a foreign Ice object is more complicated than insertion:

1. A Java "wrapper" class is derived from `ObjectReader`. An instance of this class represents a foreign Ice object.
2. An [object factory](#) is installed that returns instances of the wrapper class. Note that a single object factory can be used for all Slice types if it is registered with an empty Slice type ID.
3. A Java callback class implements the `ReadObjectCallback` interface. The implementation of `invoke` expects its argument to be either null or an instance of the wrapper class as returned by the object factory.
4. An instance of the callback class is passed to `readObject`.
5. When the stream is ready to extract the state of an object, it invokes `read` on the wrapper class. The implementation of `read` decodes the object's state as directed by the [data encoding rules for classes](#).
6. The callback object passed to `readObject` is invoked, passing the instance of the wrapper object. All other callback objects representing the same instance in the stream (in case of object graphs) are invoked with the same wrapper object.

If your class definitions use [compact type IDs](#), you must also supply an implementation of `CompactIdResolver` when [initializing the communicator](#). This object is responsible for translating numeric type IDs into their string equivalents.

See Also

- [Client-Side Slice-to-PHP Mapping](#)
- [Data Encoding](#)
- [Data Encoding for Classes](#)
- [Class Factories in Java](#)
- [Communicator Initialization](#)

Intercepting User Exception Insertion and Extraction in Java

Inserting a User Exception in Java

As in the case of [Ice objects](#), a Dynamic Ice application may represent user exceptions in a native format that is not directly compatible with the Ice API. If the application needs to raise such a user exception to the Ice run time, the exception must be wrapped in a subclass of `Ice.UserException`. The Dynamic Ice API provides a class to simplify this process:

```

                                Java
package Ice;

public abstract class UserExceptionWriter extends UserException {
    public UserExceptionWriter(Communicator communicator);

    public abstract void write(Ice.OutputStream os);

    // ...
}

```

A subclass of `UserExceptionWriter` is responsible for supplying a communicator to the constructor, and for implementing the following methods:

- `void write(OutputStream os)`
This method is invoked when the Ice run time is ready to marshal the exception. The subclass must marshal the exception using the [encoding rules for exceptions](#).

Extracting a User Exception in Java

An application extracts a user exception by calling one of two versions of the `throwException` method defined in the `InputStream` class:

```

                                Java
package Ice;

public interface InputStream {
    void throwException() throws UserException;
    void throwException(UserExceptionReaderFactory factory) throws
    UserException;

    // ...
}

```

The version without any arguments attempts to locate and throw a Java implementation of the encoded exception using classes generated by the Slice-to-Java compiler.

If your goal is to create an exception in another type system, such as a native PHP exception object, you must call the second version of `throwException` and pass an implementation of `UserExceptionReaderFactory`:

Java

```
package Ice;

public interface UserExceptionReaderFactory {
    void createAndThrow(String typeId) throws UserException;
}
```

As the stream iterates over slices of an exception from most-derived to least-derived, it invokes `createAndThrow` passing the `type ID` of each slice, giving the application an opportunity to raise an instance of `UserExceptionReader`:

Java

```
package Ice;

public abstract class UserExceptionReader extends UserException {
    protected UserExceptionReader(Communicator communicator);

    public abstract void read(InputStream is);

    public abstract String ice_name();

    protected Communicator _communicator;
}
```

Subclasses of `UserExceptionReader` must implement the abstract functions. In particular, the implementation of `read` must call `InputStream.startException`, unmarshal the remaining slices, and then call `InputStream.endException`.

See Also

- [Intercepting Object Insertion and Extraction in Java](#)
- [Data Encoding for Exceptions](#)

C-Sharp Streaming Interfaces

We discuss the stream classes first, followed by the helper functions, and finish with an advanced use case.

Topics

- [The InputStream Interface in C-Sharp](#)
- [The OutputStream Interface in C-Sharp](#)
- [Stream Helper Functions in C-Sharp](#)
- [Intercepting Object Insertion and Extraction in C-Sharp](#)
- [Intercepting User Exception Insertion and Extraction in C-Sharp](#)

The InputStream Interface in C-Sharp

An `InputStream` is created using the following function:

```

C#

namespace Ice
{
    public sealed class Util
    {
        public static InputStream createInputStream(
            Communicator communicator,
            byte[] bytes);

        public static InputStream createInputStream(
            Communicator communicator,
            byte[] bytes,
            EncodingVersion version);

        public static InputStream wrapInputStream(
            Communicator communicator,
            byte[] bytes);

        public static InputStream wrapInputStream(
            Communicator communicator,
            byte[] bytes,
            EncodingVersion version);
    }
}

```

You can optionally specify an encoding version for the stream, otherwise the stream uses the communicator's default encoding version.

Note that the `createInputStream` functions make a copy of the supplied data, whereas the `wrapInputStream` functions avoid copies by keeping a reference to the data. If you use `wrapInputStream`, it is your responsibility to ensure that the memory buffer remains unmodified for the lifetime of the `InputStream` object.

The `InputStream` interface is shown below.

```

C#

namespace Ice
{
    public interface InputStream
    {
        Communicator communicator();

        void sliceObjects(bool slice);

        bool readBool();
        bool[] readBoolSeq();
    }
}

```

```
byte readByte();
byte[] readByteSeq();

short readShort();
short[] readShortSeq();

int readInt();
int[] readIntSeq();

long readLong();
long[] readLongSeq();

float readFloat();
float[] readFloatSeq();

double readDouble();
double[] readDoubleSeq();

string readString();
string[] readStringSeq();

int readSize();
int readAndCheckSeqSize(int minSize);

ObjectPrx readProxy();

void readObject(ReadObjectCallback cb);

int readEnum(int maxValue);

void throwException();
void throwException(UserExceptionReaderFactory factory);

void startObject();
SlicedData endObject(bool preserve);

void startException();
SlicedData endException(bool preserve);

string startSlice();
void endSlice();
void skipSlice();

EncodingVersion startEncapsulation();
void endEncapsulation();
EncodingVersion skipEncapsulation();
EncodingVersion getEncoding();

void readPendingObjects();
```

```
object readSerializable();

void rewind();

void skip(int sz);
void skipSize();

bool readOptional(int tag, OptionalFormat format);

int pos();

void destroy();
```

```

    }
}

```

Member functions are provided for extracting all of the primitive types, as well as sequences of primitive types; these are self-explanatory. The remaining member functions have the following semantics:

- `void sliceObjects(boolean slice)`
Determines the behavior of the stream when extracting [Ice objects](#). An Ice object is "sliced" when a factory cannot be found for a Slice [type ID](#), resulting in the creation of an object of a less-derived type. Slicing is typically disabled when the application expects all object factories to be present, in which case the exception `NoObjectFactoryException` is raised. The default behavior is to allow slicing.
- `int readSize()`
The [Ice encoding](#) has a compact representation to indicate size. This function extracts a size and returns it as an integer.
- `int readAndCheckSeqSize(int minWireSize)`
Like `readSize`, this function reads a size and returns it, but also verifies that there is enough data remaining in the unmarshaling buffer to successfully unmarshal the elements of the sequence. The `minWireSize` parameter indicates the smallest possible [on-the-wire representation](#) of a single sequence element. If the unmarshaling buffer contains insufficient data to unmarshal the sequence, the function throws `UnmarshalOutOfBoundsException`.
- `Ice.ObjectPrx readProxy()`
This function returns an instance of the base proxy type, `ObjectPrx`. The Slice compiler optionally generates [helper functions](#) to extract proxies of user-defined types.
- `void readObject(ReadObjectCallback cb)`
The [Ice encoding for class instances](#) requires extraction to occur in stages. The `readObject` function accepts a callback object of type `ReadObjectCallback`, whose definition is shown below:

```

C#
namespace Ice {
    public interface ReadObjectCallback {
        void invoke(Ice.Object obj);
    }
}

```

When the object instance is available, the callback object's `invoke` member function is called. The application must call `readPendingObjects` to ensure that all instances are properly extracted. Note that applications rarely need to invoke this member function directly; the [helper functions](#) generated by the Slice compiler are easier to use.

- `int readEnum(int maxValue)`
Unmarshals the integer value of an enumerator. The `maxValue` argument represents the highest enumerator value in the enumeration. Consider the following definitions:

```

Slice
enum Color { red, green, blue };
enum Fruit { Apple, Pear=3, Orange };

```

The maximum value for `Color` is 2, and the maximum value for `Fruit` is 4.

- `void throwException()`

```
void throwException(UserExceptionReaderFactory factory)
```

These functions [extract a user exception](#) from the stream and throw it. If the stored exception is of an unknown type, the functions attempt to extract and throw a less-derived exception. If that also fails, an exception is thrown: for the 1.0 encoding, the exception is `UnmarshalOutOfBoundsException`, for the 1.1 encoding, the exception is `UnknownUserException`.

- `void startObject()`
`SlicedData endObject(bool preserve)`
 The `startObject` method must be called prior to reading the slices of an object. The `endObject` method must be called after all slices have been read. Pass true to `endObject` in order to preserve the slices of any unknown more-derived types, or false to discard the slices. If `preserve` is true and the stream actually preserved any slices, the return value of `endObject` is a non-nil `SlicedData` object that encapsulates the slice data. If the caller later wishes to forward the object with any preserved slices intact, it must supply this `SlicedData` object to the output stream.
- `void startException()`
`SlicedData endException(bool preserve)`
 The `startException` method must be called prior to reading the slices of an exception. The `endException` method must be called after all slices have been read. Pass true to `endException` in order to preserve the slices of any unknown more-derived types, or false to discard the slices. If `preserve` is true and the stream actually preserved any slices, the return value of `endException` is a non-nil `SlicedData` object that encapsulates the slice data. If the caller later wishes to forward the exception with any preserved slices intact, it must supply this `SlicedData` object to the output stream.
- `string startSlice()`
`void endSlice()`
`void skipSlice()`
 Start, end, and skip a slice of member data, respectively. These functions are used when manually extracting the slices of an [Ice object](#) or [user exception](#). The `startSlice` method returns the [type ID](#) of the next slice, which may be an empty string depending on the format used to encode the object or exception.
- `EncodingVersion startEncapsulation()`
`void endEncapsulation()`
`EncodingVersion skipEncapsulation()`
 Start, end, and skip an [encapsulation](#), respectively. The `startEncapsulation` and `skipEncapsulation` methods return the encoding version used to encode the contents of the encapsulation.
- `EncodingVersion getEncoding()`
 Returns the encoding version currently in use by the stream.
- `void readPendingObjects()`
 An application must call this function after all other data has been extracted, but only if [Ice objects](#) were encoded. This function extracts the state of Ice objects and invokes their corresponding callback objects (see `readObject`). Note that `endEncapsulation` implicitly calls `readPendingObjects` if necessary.
- `void readPendingObjects()`
 An application must call this function after all other data has been extracted, but only if [Ice objects](#) were encoded. This function extracts the state of Ice objects and invokes their corresponding callback objects (see `readObject`). For backward compatibility with encoding version 1.0, this function must only be called when non-optional data members or parameters use class types.
- `object readSerializable()`
 Reads a [serializable .NET object](#) from the stream.
- `void rewind()`
 Resets the position of the stream to the beginning.
- `void skip(int sz)`
 Skips the given number of bytes.
- `void skipSize()`
 Reads a size at the current position and skips that number of bytes.
- `bool readOptional(int tag, OptionalFormat fmt)`

Returns true if an optional value with the given tag and format is present, or false otherwise. If this method returns true, the data associated with that optional value must be read next. Optional values must be read in order by tag from least to greatest. The `OptionalFormat` enumeration is defined as follows:

```
C#
```

```
namespace Ice {
    enum OptionalFormat {
        OptionalFormatF1, OptionalFormatF2, OptionalFormatF4,
        OptionalFormatF8,
        OptionalFormatSize, OptionalFormatVSize,
        OptionalFormatFSize,
        OptionalFormatEndMarker
    }
}
```

Refer to the [encoding](#) discussion for more information on the meaning of these values.

- `void destroy()`
Applications must call this function in order to reclaim resources.

Here is a simple example that demonstrates how to extract a boolean and a sequence of strings from a stream:

```
C#
```

```
byte[] data = ...
Ice.InputStream inStream =
    Ice.Util.createInputStream(communicator, data);
try {
    bool b = inStream.readBool();
    string[] seq = inStream.readStringSeq();
} finally {
    inStream.destroy();
}
```

See Also

- [Basic Data Encoding](#)
- [Data Encoding for Classes](#)
- [Data Encoding for Exceptions](#)
- [Serializable Objects in C-Sharp](#)
- [Stream Helper Functions in C-Sharp](#)

The OutputStream Interface in C-Sharp

An OutputStream is created using the following function:

```

C#
namespace Ice
{
    public sealed class Util
    {
        public static OutputStream
        createOutputStream(Communicator communicator);

        public static OutputStream
        createOutputStream(Communicator communicator, EncodingVersion
        version);
    }
}

```

You can optionally specify an encoding version for the stream, otherwise the stream uses the communicator's default encoding version.

The OutputStream class is shown below.

```

C#
namespace Ice
{
    public interface OutputStream
    {
        Communicator communicator();

        void writeBool(bool v);
        void writeBoolSeq(bool[] v);

        void writeByte(byte v);
        void writeByteSeq(byte[] v);

        void writeShort(short v);
        void writeShortSeq(short[] v);

        void writeInt(int v);
        void writeIntSeq(int[] v);

        void writeLong(long v);
        void writeLongSeq(long[] v);

        void writeFloat(float v);
        void writeFloatSeq(float[] v);

        void writeDouble(double v);
    }
}

```

```
void writeDoubleSeq(double[] v);

void writeString(string v);
void writeStringSeq(string[] v);

void writeSize(int sz);

void writeProxy(ObjectPrx v);

void writeObject(Ice.Object v);

void writeEnum(int v, int maxValue);

void writeException(UserException ex);

void startObject(SlicedData sd);
void endObject();

void startException(SlicedData sd);
void endException();

void startSlice(string typeId, bool last);
void endSlice();

void startEncapsulation(EncodingVersion encoding, FormatType
format);
void startEncapsulation();
void endEncapsulation();

EncodingVersion getEncoding();

void writePendingObjects();

bool writeOptional(int tag, OptionalFormat format);

int pos();

void rewrite(int sz, int pos);

void startSize();
void endSize();

byte[] finished();

void reset(bool clearBuffer);

void writeSerializable(object v);

void destroy();
```

```

    }
}

```

Member functions are provided for inserting all of the primitive types, as well as sequences of primitive types; these are self-explanatory. The remaining member functions have the following semantics:

- `void writeSize(int sz)`
The [Ice encoding](#) has a compact representation to indicate size. This function converts the given non-negative integer into the proper encoded representation.
- `void writeObject(Ice.Object v)`
Inserts an Ice object. The [Ice encoding for class instances](#) may cause the insertion of this object to be delayed, in which case the stream retains a reference to the given object and does not insert its state until `writePendingObjects` is invoked on the stream.
- `void writeProxy(Ice.ObjectPrx v)`
Inserts a proxy.
- `void writeEnum(int val, int maxValue)`
Writes the integer value of an enumerator. The `maxValue` argument represents the highest enumerator value in the [enumeration](#). Consider the following definitions:

Slice

```

enum Color { red, green, blue };
enum Fruit { Apple, Pear=3, Orange };

```

The maximum value for `Color` is 2, and the maximum value for `Fruit` is 4.

- `void writeException(UserException ex)`
Inserts a [user exception](#). The exception argument may be an instance of `UserExceptionWriter`, which allows you to [implement your own exception marshaling logic](#).
- `void startObject(SlicedData sd)`
`void endObject()`
When marshaling the slices of an object, the application must first call `startObject`, then marshal the slices, and finally call `endObject`. The caller can pass a `SlicedData` object containing the preserved slices of unknown more-derived types, or 0 if there are no preserved slices.
- `void startException(SlicedData sd)`
`void endException()`
When marshaling the slices of an exception, the application must first call `startException`, then marshal the slices, and finally call `endException`. The caller can pass a `SlicedData` object containing the preserved slices of unknown more-derived types, or 0 if there are no preserved slices.
- `void startSlice(string typeId, bool last)`
`void endSlice()`
Starts and ends a slice of [object](#) or [exception](#) member data. The call to `startSlice` must include the type ID for the current slice, and a boolean indicating whether this is the last slice of the object or exception.
- `void startEncapsulation(EncodingVersion encoding, FormatType format)`
`void startEncapsulation()`
`void endEncapsulation()`
Starts and ends an [encapsulation](#), respectively. The first overloading of `startEncapsulation` allows you to specify the encoding version as well as the format to use for any objects and exceptions marshaled within this encapsulation.
- `EncodingVersion getEncoding()`

Returns the encoding version currently being used by the stream.

- `void writePendingObjects()`
Encodes the state of Ice objects whose insertion was delayed during `writeObject`. This member function must only be called once. For backward compatibility with encoding version 1.0, this function must only be called when non-optional data members or parameters use class types.
- `bool writeOptional(int tag, OptionalFormat fmt)`
Prepares the stream to write an optional value with the given tag and format. Returns true if the value should be written, or false otherwise. A return value of false indicates that the encoding version in use by the stream does not support optional values. If this method returns true, the data associated with that optional value must be written next. Optional values must be written in order by tag from least to greatest. The `OptionalFormat` enumeration is defined as follows:

```

C#

namespace Ice {
    enum OptionalFormat {
        OptionalFormatF1, OptionalFormatF2, OptionalFormatF4,
        OptionalFormatF8,
        OptionalFormatSize, OptionalFormatVSize,
        OptionalFormatFSize,
        OptionalFormatEndMarker
    }
}

```

Refer to the [encoding](#) discussion for more information on the meaning of these values.

- `int pos()`
`void rewrite(int sz, int pos)`
The `pos` method returns the stream's current position, and `rewrite` allows you to overwrite a 32-bit integer value at the given position in the stream. Calling `rewrite` does not change the stream's current position.
- `byte[] finished()`
Indicates that marshaling is complete and returns the encoded byte sequence. This member function must only be called once.
- `void reset(bool clearBuffer)`
Resets the writing position of the stream to the beginning. The boolean argument `clearBuffer` determines whether the stream releases the internal buffer it allocated to hold the encoded data. If `clearBuffer` is true, the stream releases the buffer in order to make it eligible for garbage collection. If `clearBuffer` is false, the stream retains the buffer to avoid generating unnecessary garbage.
- `void writeSerializable(object v)`
Writes a [serializable .NET object](#) to the stream.
- `void destroy()`
Applications must call this function in order to reclaim resources.

Here is a simple example that demonstrates how to insert a boolean and a sequence of strings into a stream:

C#

```
string[] seq = { "Ice", "rocks!" };
Ice.OutputStream outputStream
    = Ice.Util.createOutputStream(communicator);
try {
    outputStream.writeBool(true);
    outputStream.writeStringSeq(seq);
    byte[] data = outputStream.finished();
} finally {
    outputStream.destroy();
}
```

See Also

- [Basic Data Encoding](#)
- [Data Encoding for Classes](#)
- [Data Encoding for Exceptions](#)
- [Serializable Objects in C-Sharp](#)

Stream Helper Functions in C-Sharp

The stream classes provide all of the low-level functions necessary for [encoding and decoding](#) Ice types. However, it would be tedious and error-prone to manually encode complex Ice types such as classes, structs, and dictionaries using these low-level functions. For this reason, the [Slice compiler](#) optionally generates helper functions for streaming complex Ice types.

We will use the following Slice definitions to demonstrate the language mapping:

Slice
<pre> module M { sequence<...> Seq; dictionary<...> Dict; struct S { ... }; enum E { ... }; class C { ... }; }; </pre>

The Slice compiler generates the corresponding helper functions shown below:

C#
<pre> namespace M { public sealed class SeqHelper { public static int[] read(Ice.InputStream _in); public static void write(Ice.OutputStream _out, int[] _v); public static Ice.OptionalFormat optionalFormat(); } public sealed class DictHelper { public static Dictionary<...> read(Ice.InputStream _in); public static void write(Ice.OutputStream _out, Dictionary<...> _v); public static Ice.OptionalFormat optionalFormat(); } public sealed class SHelper { public static S read(Ice.InputStream _in); public static void write(Ice.OutputStream _out, S _v); public static Ice.OptionalFormat optionalFormat(); } public sealed class EHelper </pre>

```
{
    public static M.E read(Ice.InputStream _in);
    public static void write(Ice.OutputStream _out, M.E _v);
    public static Ice.OptionalFormat optionalFormat();
}

public sealed class CHelper
{
    public CHelper(Ice.InputStream _in);
    public void read();
    public static void write(Ice.OutputStream _out, C _v);
    public M.C value
    {
        get;
    }
    public static Ice.OptionalFormat optionalFormat();
    // ...
}

public sealed class CPrxHelper : Ice.ObjectPrxHelperBase, CPrx
{
    public static CPrx read(Ice.InputStream _in);
    public static void write(Ice.OutputStream _out, CPrx _v);
    public static Ice.OptionalFormat optionalFormat();
}
```



```

    }
}

```

The `optionalFormat` method simplifies the task of writing [optional values](#).

The Slice compiler also generates the following member functions for `struct` types:

```

C#
public struct S {
    ...
    public void ice_read(Ice.InputStream in);
    public void ice_write(Ice.OutputStream out);
}

```

Be aware that a call to `CHelper.read` does not result in the immediate extraction of an Ice object. The `value` property of the given `CHelper` object is updated when `readPendingObjects` is invoked on the [input stream](#).

See Also

- [slice2cs Command-Line Options](#)
- [The InputStream Interface in C-Sharp](#)
- [Optional Values](#)

Intercepting Object Insertion and Extraction in C-Sharp

In some situations it may be necessary for an application to intercept the insertion and extraction of Ice objects. For example, the [Ice extension for PHP](#) is implemented using Ice for C++ but represents Ice objects as native PHP objects. The PHP extension accomplishes this by manually encoding and decoding Ice objects as directed by the [data encoding](#) rules. However, the extension obviously cannot pass a native PHP object to the C++ stream function `writeObject`. To bridge this gap between object systems, Ice supplies the helper classes described below.

On this page:

- [Inserting Objects in C#](#)
- [Extracting Objects in C#](#)

Inserting Objects in C#

The `ObjectWriter` base class facilitates the insertion of objects to a stream:

```

C#
namespace Ice
{
    public abstract class ObjectWriter : ObjectImpl
    {
        public abstract void write(OutputStream outputStream);
        // ...
    }
}

```

A foreign Ice object is inserted into a stream using the following technique:

1. A C# "wrapper" class is derived from `ObjectWriter`. This class wraps the foreign object and implements the `write` member function.
2. An instance of the wrapper class is passed to `writeObject`. (This is possible because `ObjectWriter` derives from `Ice.Object`.) Eventually, the `write` member function is invoked on the wrapper instance.
3. The implementation of `write` encodes the object's state as directed by the [data encoding rules for classes](#).

It is the application's responsibility to ensure that there is a one-to-one mapping between foreign Ice objects and wrapper objects. This is necessary in order to ensure the proper encoding of object graphs.

Extracting Objects in C#

The `ObjectReader` class facilitates the extraction of objects from a stream:

C#

```

namespace Ice
{
    public abstract class ObjectReader : ObjectImpl
    {
        public abstract void read(InputStream inStream);
        // ...
    }

    public delegate string CompactIdResolver(int id);
}

```

Extracting the state of a foreign Ice object is more complicated than insertion:

1. A C# "wrapper" class is derived from `ObjectReader`. An instance of this class represents a foreign Ice object.
2. An [object factory](#) is installed that returns instances of the wrapper class. Note that a single object factory can be used for all Slice types if it is registered with an empty Slice type ID.
3. A C# callback class implements the `ReadObjectCallback` interface. The implementation of `invoke` expects its argument to be either null or an instance of the wrapper class as returned by the object factory.
4. An instance of the callback class is passed to `readObject`.
5. When the stream is ready to extract the state of an object, it invokes `read` on the wrapper class. The implementation of `read` decodes the object's state as directed by the [data encoding rules for classes](#).
6. The callback object passed to `readObject` is invoked, passing the instance of the wrapper object. All other callback objects representing the same instance in the stream (in case of object graphs) are invoked with the same wrapper object.

If your class definitions use [compact type IDs](#), you must also supply an implementation of `CompactIdResolver` when [initializing the communicator](#). This object is responsible for translating numeric type IDs into their string equivalents.

See Also

- [Client-Side Slice-to-PHP Mapping](#)
- [Data Encoding](#)
- [Data Encoding for Classes](#)
- [Class Factories in C#](#)
- [Communicator Initialization](#)

Intercepting User Exception Insertion and Extraction in C-Sharp

Inserting a User Exception in C#

As in the case of [Ice objects](#), a Dynamic Ice application may represent user exceptions in a native format that is not directly compatible with the Ice API. If the application needs to raise such a user exception to the Ice run time, the exception must be wrapped in a subclass of `Ice.UserException`. The Dynamic Ice API provides a class to simplify this process:

```

C#

namespace Ice
{
    public abstract class UserExceptionWriter : UserException
    {
        public UserExceptionWriter(Communicator communicator);

        public abstract void write(OutputStream os);

        // ...
    }
}

```

A subclass of `UserExceptionWriter` is responsible for supplying a communicator to the constructor, and for implementing the following methods:

- `void write(OutputStream os)`
This method is invoked when the Ice run time is ready to marshal the exception. The subclass must marshal the exception using the [encoding rules for exceptions](#).

Extracting a User Exception in C#

An application extracts a user exception by calling one of two versions of the `throwException` method defined in the `InputStream` class:

```

C#

namespace Ice {
    public interface InputStream {
        void throwException();
        void throwException(UserExceptionReaderFactory factory);

        // ...
    }
}

```

The version without any arguments attempts to locate and throw a C# implementation of the encoded exception using classes generated by the Slice-to-C# compiler.

If your goal is to create an exception in another type system, such as a native PHP exception object, you must call the second version of `throwException` and pass an implementation of `UserExceptionReaderFactory`:

```

C#
namespace Ice {
    public interface UserExceptionReaderFactory {
        void createAndThrow(string typeId);
    }
}

```

As the stream iterates over slices of an exception from most-derived to least-derived, it invokes `createAndThrow` passing the `type ID` of each slice, giving the application an opportunity to raise an instance of `UserExceptionReader`:

```

C#
namespace Ice {
    public abstract class UserExceptionReader : UserException {
        protected UserExceptionReader(Communicator communicator);

        public abstract void read(InputStream is);

        public abstract string ice_name();

        protected Communicator _communicator;
    }
}

```

Subclasses of `UserExceptionReader` must implement the abstract functions. In particular, the implementation of `read` must call `InputStream.startException`, unmarshal the remaining slices, and then call `InputStream.endException`.

See Also

- [Intercepting Object Insertion and Extraction in C-Sharp](#)
- [Data Encoding for Exceptions](#)

Dynamic Invocation and Dispatch

Topics

- [Dynamic Invocation and Dispatch Overview](#)
- [Dynamic Invocation and Dispatch in C++](#)
- [Dynamic Invocation and Dispatch in Java](#)
- [Dynamic Invocation and Dispatch in C-Sharp](#)

Dynamic Invocation and Dispatch Overview

On this page:

- [Use Cases for Dynamic Invocation and Dispatch](#)
- [Dynamic Invocation using `ice_invoke`](#)
- [Dynamic Dispatch using `Blobject`](#)

Use Cases for Dynamic Invocation and Dispatch

Ice applications generally use the static invocation model, in which the application invokes a Slice operation by calling a member function on a generated proxy class. In the server, the static dispatch model behaves similarly: the request is dispatched to the servant as a statically-typed call to a member function. Underneath this statically-typed facade, the Ice run times in the client and server are exchanging sequences of bytes representing the encoded request arguments and results. These interactions are illustrated below:

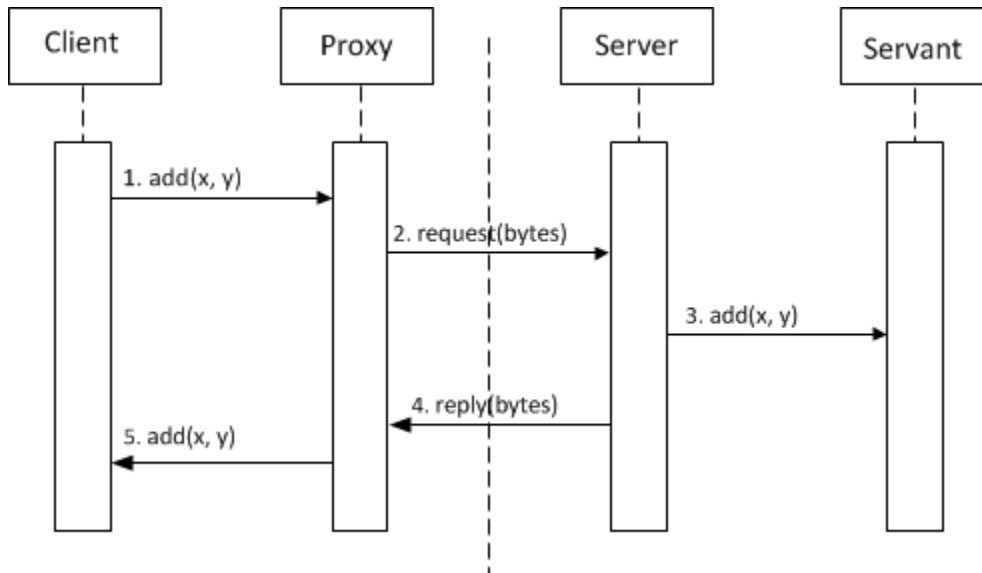

Interactions in a static invocation.

1. The client initiates a call to the Slice operation `add` by calling the member function `add` on a proxy.
2. The generated proxy class marshals the arguments into a sequence of bytes and transmits them to the server.
3. In the server, the generated servant class unmarshals the arguments and calls `add` on the subclass.
4. The servant marshals the results and returns them to the client.
5. Finally, the client's proxy unmarshals the results and returns them to the caller.

The application is blissfully unaware of this low-level machinery, and in the majority of cases that is a distinct advantage. In some situations, however, an application can leverage this machinery to accomplish tasks that are not possible in a statically-typed environment. Ice provides the dynamic invocation and dispatch models for these situations, allowing applications to send and receive requests as encoded sequences of bytes instead of statically-typed arguments.

The dynamic invocation and dispatch models offer several unique advantages to Ice services that forward requests from senders to receivers, such as [Glacier2](#) and [IceStorm](#). For these services, the request arguments are an opaque byte sequence that can be forwarded without the need to unmarshal and remarshal the arguments. Not only is this significantly more efficient than a statically-typed implementation, it also allows intermediaries such as [Glacier2](#) and [IceStorm](#) to be ignorant of the Slice types in use by senders and receivers.

Another use case for the dynamic invocation and dispatch models is scripting language integration. The Ice extensions for Python, PHP, and Ruby invoke Slice operations using the dynamic invocation model; the request arguments are encoded using the [streaming interfaces](#).

It may be difficult to resist the temptation of using a feature like dynamic invocation or dispatch, but we recommend that you carefully consider the risks and complexities of such a decision. For example, an application that uses the streaming interface to manually encode and decode request arguments has a high risk of failure if the argument signature of an operation changes. In contrast, this risk is greatly

reduced in the static invocation and dispatch models because errors in a strongly-typed language are found early, during compilation. Therefore, we caution you against using this capability except where its advantages significantly outweigh the risks.

Dynamic Invocation using `ice_invoke`

Dynamic invocation is performed using the proxy member function `ice_invoke`, defined in the proxy base class `ObjectPrx`. If we were to define the function in Slice, it would look like this:

```

Slice
sequence<byte> ByteSeq;

bool ice_invoke(
    string operation,
    Ice::OperationMode mode,
    ByteSeq inParams,
    out ByteSeq outParams
);

```

The first argument is the name of the Slice operation.

 This is the Slice name of the operation, not the name as it might be mapped to any particular language. For example, the string "while" is the name of the Slice operation `while`, and not `"_cpp_while"` (C++) or `"_while"` (Java).

The second argument is an enumerator from the Slice type `Ice::OperationMode`; the possible values are `Normal` and `Idempotent`. The third argument, `inParams`, represents an encapsulation of the encoded in-parameters of the operation.

A return value of `true` indicates a successful invocation, in which case an encapsulation of the marshaled form of the operation's results (if any) is provided in `outParams`. A return value of `false` signals the occurrence of a user exception whose encapsulated data is provided in `outParams`. The caller must also be prepared to catch local exceptions, which are thrown directly.

Note that the Ice run time currently does not support the use of collocation optimization in dynamic invocations. Attempting to call `ice_invoke` on a proxy that is configured to use collocation optimization raises `CollocationOptimizationException`. See [Location Transparency](#) for more information on this optimization and instructions for disabling it.

Dynamic Dispatch using `Blobject`

A server enables dynamic dispatch by creating a subclass of `Blobject` (the name is derived from *blob*, meaning a blob of bytes). The Slice equivalent of `Blobject` is shown below:

```

Slice
sequence<byte> ByteSeq;

interface Blobject {
    bool ice_invoke(ByteSeq inParams, out ByteSeq outParams);
};

```

The `inParams` argument supplies an encapsulation of the encoded in-parameters. The contents of the `outParams` argument depends on the outcome of the invocation: if the operation succeeded, `ice_invoke` must return `true` and place an encapsulation of the encoded

results in `outParams`; if a user exception occurred, `ice_invoke` must return `false`, in which case `outParams` contains an encapsulation of the encoded exception. The operation may also raise local exceptions such as `OperationNotExistException`.

The language mappings add a trailing argument of type `Ice::Current` to `ice_invoke`, and this provides the implementation with the name of the operation being dispatched.

Because `Blobject` derives from `Object`, an instance is a regular Ice servant just like instances of the classes generated for user-defined Slice interfaces. The primary difference is that all operation invocations on a `Blobject` instance are dispatched through the `ice_invoke` member function.

If a `Blobject` subclass intends to decode the in-parameters (and not simply forward the request to another object), then the implementation obviously must know the signatures of all operations it supports. How a `Blobject` subclass determines its type information is an implementation detail that is beyond the scope of this manual.

Note that a `Blobject` servant is also useful if you want to create a message forwarding service, such as [Glacier2](#). In this case, there is no need to decode any parameters; instead, the implementation simply forwards each request unchanged to a new destination. You can register a `Blobject` servant as a [default servant](#) to easily achieve this.

See Also

- [Location Transparency](#)
- [The Current Object](#)
- [Default Servants](#)
- [Streaming Interfaces](#)
- [Glacier2](#)
- [IceStorm](#)

Dynamic Invocation and Dispatch in C++

This page describes the C++ mapping for the `ice_invoke` proxy function and the `Blobject` class.

On this page:

- [ice_invoke in C++](#)
- [Using Streams with ice_invoke in C++](#)
- [Subclassing Blobject in C++](#)
- [Using the Array Mapping for ice_invoke and Blobject in C++](#)

ice_invoke in C++

The mapping for `ice_invoke` is shown below:

C++
<pre>bool ice_invoke(const std::string& operation, Ice::OperationMode mode, const std::vector< Ice::Byte >& inParams, std::vector< Ice::Byte >& outParams);</pre>

Another overloading of `ice_invoke` (not shown) adds a trailing argument of type `Ice::Context`.

As an example, the code below demonstrates how to invoke the operation `op`, which takes no `in` parameters:

C++
<pre>Ice::ObjectPrx proxy = ... try { std::vector<Ice::Byte> inParams, outParams; if (proxy->ice_invoke("op", Ice::Normal, inParams, outParams)) { // Handle success } else { // Handle user exception } } catch (const Ice::LocalException& ex) { // Handle exception }</pre>

As a convenience, the Ice run time accepts an empty byte sequence when there are no input parameters and internally translates it into an empty encapsulation. In all other cases, the value for `inParams` must be an encapsulation of the encoded parameters.

Using Streams with ice_invoke in C++

The [streaming interfaces](#) provide the tools an application needs to dynamically invoke operations with arguments of any Slice type. Consider the following Slice definition:

Slice

```

module Calc {
    exception Overflow {
        int x;
        int y;
    };
    interface Compute {
        idempotent int add(int x, int y)
            throws Overflow;
    };
};

```

Now let's write a client that dynamically invokes the add operation:

C++

```

Ice::ObjectPrx proxy = ...
try {
    std::vector< Ice::Byte > inParams, outParams;

    Ice::OutputStreamPtr out = Ice::createOutputStream(communicator);
    out->startEncapsulation();
    out->writeInt(100); // x
    out->writeInt(-1); // y
    out->endEncapsulation();
    out->finished(inParams);

    if (proxy->ice_invoke("add", Ice::Idempotent, inParams,
outParams)) {
        // Handle success
        Ice::InputStreamPtr in =
Ice::createInputStream(communicator, outParams);
        in->startEncapsulation();
        int result = in->readInt();
        in->endEncapsulation();
        assert(result == 99);
    } else {
        // Handle user exception
    }
} catch (const Ice::LocalException& ex) {
    // Handle exception
}

```

You can see here that the input and output parameters are enclosed in encapsulations.

We neglected to handle the case of a user exception in this example, so let's implement that now. We assume that we have compiled our program with the Slice-generated code, therefore we can call `throwException` on the input stream and catch `Overflow` directly:

C++

```

    if (proxy->ice_invoke("add", Ice::Idempotent, inParams,
outParams)) {
        // Handle success
        // ...
    } else {
        // Handle user exception
        Ice::InputStreamPtr in =
Ice::createInputStream(communicator, outParams);
        try {
            in->startEncapsulation();
            in->throwException();
        } catch (const Calc::Overflow& ex) {
            cout << "overflow while adding " << ex.x
<< " and " << ex.y << endl;
        } catch (const Ice::UserException& ex) {
            // Handle unexpected user exception
        }
    }
}

```



This is obviously a contrived example: if the Slice-generated code is available, why bother using dynamic dispatch? In the absence of Slice-generated code, the caller would need to manually unmarshal the user exception, which is outside the scope of this manual.

As a defensive measure, the code traps `Ice::UserException`. This could be raised if the Slice definition of `add` is modified to include another user exception but this segment of code did not get updated accordingly.

Subclassing `BObject` in C++

Implementing the dynamic dispatch model requires writing a subclass of `Ice::BObject`. We continue using the `Compute` interface to demonstrate a `BObject` implementation:

C++

```

class ComputeI : public Ice::BObject {
public:
    virtual bool ice_invoke(
        const std::vector<Ice::Byte>& inParams,
        std::vector<Ice::Byte>& outParams,
        const Ice::Current& current);
};

```

An instance of `ComputeI` is an Ice object because `BObject` derives from `Object`, therefore an instance can be added to an object adapter like any other servant.

For the purposes of this discussion, the implementation of `ice_invoke` handles only the `add` operation and raises `OperationNotExistException` for all other operations. In a real implementation, the servant must also be prepared to receive invocations of the following `Object` operations:

- `string ice_id()`
Returns the Slice [type ID](#) of the servant's most-derived type.
- `StringSeq ice_ids()`
Returns a sequence of strings representing all of the Slice interfaces supported by the servant, including "`::Ice::Object`".
- `bool ice_isA(string id)`
Returns `true` if the servant supports the interface denoted by the given Slice [type ID](#), or `false` otherwise. This operation is invoked by the proxy function `checkedCast`.
- `void ice_ping()`
Verifies that the object denoted by the [identity](#) and [facet](#) contained in `Ice::Current` is reachable.

With that in mind, here is our simplified version of `ice_invoke`:

C++

```

bool ComputeI::ice_invoke(
    const std::vector<Ice::Byte>& inParams,
    std::vector<Ice::Byte>& outParams,
    const Ice::Current& current)
{
    if (current.operation == "add") {
        Ice::CommunicatorPtr communicator =
current.adapter->getCommunicator();
        Ice::InputStreamPtr in =
Ice::createInputStream(communicator, inParams);
        in->startEncapsulation();
        int x = in->readInt();
        int y = in->readInt();
        in->endEncapsulation();

        Ice::OutputStreamPtr out =
Ice::createOutputStream(communicator);
        if (checkOverflow(x, y)) {
            Calc::Overflow ex;
            ex.x = x;
            ex.y = y;
            out->startEncapsulation();
            out->writeException(ex);
            out->endEncapsulation();
            out->finished(outParams);
            return false;
        } else {
            out->startEncapsulation();
            out->writeInt(x + y);
            out->endEncapsulation();
            out->finished(outParams);
            return true;
        }
    } else {
        Ice::OperationNotExistException ex(__FILE__, __LINE__);
        ex.id = current.id;
        ex.facet = current.facet;
        ex.operation = current.operation;
        throw ex;
    }
}

```

If an overflow is detected, the code "raises" the `Calc::Overflow` user exception by calling `writeException` on the output stream and returning `false`, otherwise the return value is encoded and the function returns `true`.

Using the Array Mapping for `ice_invoke` and `Blobject` in C++

Ice for C++ supports an [alternative mapping](#) for sequence input parameters that avoids the overhead of extra copying. Since the `ice_invoke` functions treat the encoded input parameters as a value of type `sequence<byte>`, the dynamic invocation and dispatch facility includes interfaces that use the array mapping for the input parameter blob.

Ice provides two overloaded versions of the proxy function `ice_invoke` that use the array mapping. The version that omits the trailing `Ice::Context` argument is shown below:

```
C++
```

```
bool ice_invoke(
    const std::string& operation,
    Ice::OperationMode mode,
    const std::pair< const Ice::Byte*, const Ice::Byte* >& in,
    std::vector< Ice::Byte >& out
);
```

A `Blobject` servant uses the array mapping by deriving its implementation class from `Ice::BlobjectArray` and overriding its `ice_invoke` function:

```
C++
```

```
class BlobjectArray {
public:
    virtual bool ice_invoke(
        const std::pair<const Ice::Byte*, const Ice::Byte*>& in,
        std::vector<Ice::Byte>& out,
        const Ice::Current& current) = 0;
};
```

See Also

- [C++ Mapping for Sequences](#)
- [Object Adapters](#)
- [Request Contexts](#)
- [Streaming Interfaces](#)
- [Type IDs](#)
- [Object Identity](#)
- [Facets and Versioning](#)

Dynamic Invocation and Dispatch in Java

This page describes the Java mapping for the `ice_invoke` proxy function and the `Blobject` class.

On this page:

- [ice_invoke in Java](#)
- [Using Streams with ice_invoke in Java](#)
- [Subclassing Blobject in Java](#)

ice_invoke in Java

The mapping for `ice_invoke` is shown below:

Java
<pre>boolean ice_invoke(String operation, Ice.OperationMode mode, byte[] inParams, Ice.ByteSeqHolder outParams);</pre>

Another overloading of `ice_invoke` (not shown) adds a trailing argument of type `Ice.Context`.

As an example, the code below demonstrates how to invoke the operation `op`, which takes no `in` parameters:

Java
<pre>Ice.ObjectPrx proxy = ... try { Ice.ByteSeqHolder outParams = new Ice.ByteSeqHolder(); if (proxy.ice_invoke("op", Ice.OperationMode.Normal, null, outParams)) { // Handle success } else { // Handle user exception } } catch (Ice.LocalException ex) { // Handle exception }</pre>

As a convenience, the Ice run time accepts an empty or null byte sequence when there are no input parameters and internally translates it into an empty encapsulation. In all other cases, the value for `inParams` must be an encapsulation of the encoded parameters.

Using Streams with ice_invoke in Java

The [streaming interfaces](#) provide the tools an application needs to dynamically invoke operations with arguments of any Slice type. Consider the following Slice definition:

Slice

```

module Calc {
    exception Overflow {
        int x;
        int y;
    };
    interface Compute {
        idempotent int add(int x, int y)
            throws Overflow;
    };
};

```

Now let's write a client that dynamically invokes the add operation:

Java

```

Ice.ObjectPrx proxy = ...
try {
    Ice.OutputStream out = Ice.Util.createOutputStream(communicator);
    out.startEncapsulation();
    out.writeInt(100); // x
    out.writeInt(-1); // y
    out.endEncapsulation();
    byte[] inParams = out.finished();

    Ice.ByteSeqHolder outParams = new Ice.ByteSeqHolder();
    if (proxy.ice_invoke("add", Ice.OperationMode.Idempotent,
        inParams, outParams)) {
        // Handle success
        Ice.InputStream in = Ice.Util.createInputStream(communicator,
            outParams.value);
        in.startEncapsulation();
        int result = in.readInt();
        in.endEncapsulation();
        assert(result == 99);
    } else {
        // Handle user exception
    }
} catch (Ice.LocalException ex) {
    // Handle exception
}

```

You can see here that the input and output parameters are enclosed in encapsulations.

We neglected to handle the case of a user exception in this example, so let's implement that now. We assume that we have compiled our program with the Slice-generated code, therefore we can call `throwException` on the input stream and catch `Overflow` directly:

Java

```

    if (proxy.ice_invoke("add", Ice.OperationMode.Idempotent,
inParams, outParams)) {
        // Handle success
        // ...
    } else {
        // Handle user exception
        Ice.InputStream in = Ice.Util.createInputStream(communicator,
outParams.value);
        try {
            in.startEncapsulation();
            in.throwException();
        } catch (Calc.Overflow ex) {
            System.out.println("overflow while adding " + ex.x +
" and " + ex.y);
        } catch (Ice.UserException ex) {
            // Handle unexpected user exception
        }
    }
}

```

 This is obviously a contrived example: if the Slice-generated code is available, why bother using dynamic dispatch? In the absence of Slice-generated code, the caller would need to manually unmarshal the user exception, which is outside the scope of this manual.

As a defensive measure, the code traps `Ice.UserException`. This could be raised if the Slice definition of `add` is modified to include another user exception but this segment of code did not get updated accordingly.

Subclassing `Blobject` in Java

Implementing the dynamic dispatch model requires writing a subclass of `Ice.Blobject`. We continue using the `Compute` interface to demonstrate a `Blobject` implementation:

Java

```

public class ComputeI extends Ice.Blobject {
    public boolean ice_invoke(
        byte[] inParams,
        Ice.ByteSeqHolder outParams,
        Ice.Current current)
    {
        // ...
    }
}

```

An instance of `ComputeI` is an Ice object because `Blobject` derives from `Object`, therefore an instance can be added to an [object adapter](#) like any other servant.

For the purposes of this discussion, the implementation of `ice_invoke` handles only the `add` operation and raises `OperationNotExistE`

exception for all other operations. In a real implementation, the servant must also be prepared to receive invocations of the following `Object` operations:

- `string ice_id()`
Returns the Slice `type ID` of the servant's most-derived type.
- `StringSeq ice_ids()`
Returns a sequence of strings representing all of the Slice interfaces supported by the servant, including `"::Ice::Object"`.
- `bool ice_isA(string id)`
Returns `true` if the servant supports the interface denoted by the given Slice `type ID`, or `false` otherwise. This operation is invoked by the proxy function `checkedCast`.
- `void ice_ping()`
Verifies that the object denoted by the `identity` and `facet` contained in `Ice::Current` is reachable.

With that in mind, here is our simplified version of `ice_invoke`:

Java

```

public boolean ice_invoke(
    byte[] inParams,
    Ice.ByteSeqHolder outParams,
    Ice.Current current)
{
    if (current.operation.equals("add")) {
        Ice.Communicator communicator =
current.adapter.getCommunicator();
        Ice.InputStream in =
Ice.Util.createInputStream(communicator, inParams);
        in.startEncapsulation();
        int x = in.readInt();
        int y = in.readInt();
        in.endEncapsulation();

        Ice.OutputStream out =
Ice.Util.createOutputStream(communicator);
        try {
            if (checkOverflow(x, y)) {
                Calc.Overflow ex = new Calc.Overflow();
                ex.x = x;
                ex.y = y;
                out.startEncapsulation();
                out.writeException(ex);
                out.endEncapsulation();
                outParams.value = out.finished();
                return false;
            } else {
                out.startEncapsulation();
                out.writeInt(x + y);
                out.endEncapsulation();
                outParams.value = out.finished();
                return true;
            }
        } finally {
            out.destroy();
        }
    } else {
        Ice.OperationNotExistException ex =
new Ice.OperationNotExistException();
        ex.id = current.id;
        ex.facet = current.facet;
        ex.operation = current.operation;
        throw ex;
    }
}

```

If an overflow is detected, the code "raises" the `Calc::Overflow` user exception by calling `writeException` on the output stream and returning `false`, otherwise the return value is encoded and the function returns `true`.

See Also

- [Object Adapters](#)
- [Request Contexts](#)
- [Streaming Interfaces](#)
- [Type IDs](#)
- [Object Identity](#)
- [Facets and Versioning](#)

Dynamic Invocation and Dispatch in C-Sharp

This page describes the C# mapping for the `ice_invoke` proxy function and the `Blobject` class.

On this page:

- [ice_invoke in C#](#)
- [Using Streams with ice_invoke in C#](#)
- [Subclassing Blobject in C#](#)

ice_invoke in C#

The mapping for `ice_invoke` is shown below:

C#
<pre>namespace Ice { public interface ObjectPrx { bool ice_invoke(string operation, OperationMode mode, byte[] inParams, out byte[] outParams); // ... } }</pre>

Another overloading of `ice_invoke` (not shown) adds a trailing argument of type `Ice.Context`.

As an example, the code below demonstrates how to invoke the operation `op`, which takes no `in` parameters:

C#
<pre>Ice.ObjectPrx proxy = ... try { byte[] outParams; if (proxy.ice_invoke("op", Ice.OperationMode.Normal, null, outParams)) { // Handle success } else { // Handle user exception } } catch (Ice.LocalException ex) { // Handle exception }</pre>

As a convenience, the Ice run time accepts a null or empty byte sequence when there are no input parameters and internally translates it into an empty encapsulation. In all other cases, the value for `inParams` must be an encapsulation of the encoded parameters.

Using Streams with ice_invoke in C#

The [streaming interfaces](#) provide the tools an application needs to dynamically invoke operations with arguments of any Slice type. Consider the following Slice definition:

```
Slice
```

```

module Calc {
    exception Overflow {
        int x;
        int y;
    };
    interface Compute {
        idempotent int add(int x, int y)
            throws Overflow;
    };
};

```

Now let's write a client that dynamically invokes the add operation:

```
C#
```

```

Ice.ObjectPrx proxy = ...
try {
    Ice.OutputStream outStream =
Ice.Util.createOutputStream(communicator);
    outStream.startEncapsulation();
    outStream.writeInt(100); // x
    outStream.writeInt(-1); // y
    outStream.endEncapsulation();
    byte[] inParams = outStream.finished();

    byte[] outParams;
    if (proxy.ice_invoke("add", Ice.OperationMode.Idempotent,
inParams, out outParams)) {
        // Handle success
        Ice.InputStream inStream =
Ice.Util.createInputStream(communicator, outParams);
        inStream.startEncapsulation();
        int result = inStream.readInt();
        inStream.endEncapsulation();
        System.Diagnostics.Debug.Assert(result == 99);
    } else {
        // Handle user exception
    }
} catch (Ice.LocalException ex) {
    // Handle exception
}

```

You can see here that the input and output parameters are enclosed in encapsulations.

We neglected to handle the case of a user exception in this example, so let's implement that now. We assume that we have compiled our program with the Slice-generated code, therefore we can call `throwException` on the input stream and catch `Overflow` directly:

```
C#
```

```

    if (proxy.ice_invoke("add", Ice.OperationMode.Idempotent,
inParams, out outParams)) {
        // Handle success
        ...
    } else {
        // Handle user exception
        Ice.InputStream inStream =
Ice.Util.createInputStream(communicator, outParams);
        try {
            inStream.startEncapsulation();
            inStream.throwException();
        } catch (Calc.Overflow ex) {
            System.Console.WriteLine("overflow while adding " +
                                     ex.x + " and " + ex.y);
        } catch (Ice.UserException) {
            // Handle unexpected user exception
        }
    }
}

```

 This is obviously a contrived example: if the Slice-generated code is available, why bother using dynamic dispatch? In the absence of Slice-generated code, the caller would need to manually unmarshal the user exception, which is outside the scope of this book.

As a defensive measure, the code traps `Ice.UserException`. This could be raised if the Slice definition of `add` is modified to include another user exception but this segment of code did not get updated accordingly.

Subclassing `Blobject` in C#

Implementing the dynamic dispatch model requires writing a subclass of `Ice.Blobject`. We continue using the `Compute` interface to demonstrate a `Blobject` implementation:

```
C#
```

```

public class ComputeI : Ice.Blobject {
    public bool ice_invoke(byte[] inParams, out byte[] outParams,
Ice.Current current);
    {
        ...
    }
}

```

An instance of `ComputeI` is an Ice object because `Blobject` derives from `Object`, therefore an instance can be added to an `object adapter` like any other servant.

For the purposes of this discussion, the implementation of `ice_invoke` handles only the `add` operation and raises `OperationNotExistException` for all other operations. In a real implementation, the servant must also be prepared to receive invocations of the following `Object` operations:

- `string ice_id()`
Returns the Slice `type ID` of the servant's most-derived type.
- `StringSeq ice_ids()`
Returns a sequence of strings representing all of the Slice interfaces supported by the servant, including `"::Ice::Object"`.
- `bool ice_isA(string id)`
Returns `true` if the servant supports the interface denoted by the given Slice `type ID`, or `false` otherwise. This operation is invoked by the proxy function `checkedCast`.
- `void ice_ping()`
Verifies that the object denoted by the `identity` and `facet` contained in `Ice::Current` is reachable.

With that in mind, here is our simplified version of `ice_invoke`:

C#

```

public bool ice_invoke(byte[] inParams, out byte[] outParams,
Ice.Current current);
{
    if (current.operation.Equals("add")) {
        Ice.Communicator communicator =
current.adapter.getCommunicator();
        Ice.InputStream inStream =
Ice.Util.createInputStream(communicator, inParams);
        inStream.startEncapsulation();
        int x = inStream.readInt();
        int y = inStream.readInt();
        inStream.endEncapsulation();

        Ice.OutputStream outStream =
Ice.Util.createOutputStream(communicator);
        try {
            if (checkOverflow(x, y)) {
                Calc.Overflow ex = new Calc.Overflow();
                ex.x = x;
                ex.y = y;
                outStream.startEncapsulation();
                outStream.writeException(ex);
                outStream.endEncapsulation();
                outParams = outStream.finished();
                return false;
            } else {
                outStream.startEncapsulation();
                outStream.writeInt(x + y);
                outStream.endEncapsulation();
                outParams = outStream.finished();
                return true;
            }
        } finally {
            outStream.destroy();
        }
    } else {
        Ice.OperationNotExistException ex =
new Ice.OperationNotExistException();
        ex.id = current.id;
        ex.facet = current.facet;
        ex.operation = current.operation;
        throw ex;
    }
}

```

If an overflow is detected, the code "raises" the `Calc::Overflow` user exception by calling `writeException` on the output stream and returning `false`, otherwise the return value is encoded and the function returns `true`.

See Also

- [Object Adapters](#)
- [Request Contexts](#)
- [Streaming Interfaces](#)
- [Type IDs](#)
- [Object Identity](#)
- [Facets and Versioning](#)

Asynchronous Dynamic Invocation and Dispatch

Ice also provides asynchronous support for the [dynamic invocation and dispatch models](#). The mappings for the `ice_invoke` proxy function and the `Blobject` class adhere to the normal asynchronous mapping rules.

Topics

- [Asynchronous Dynamic Invocation and Dispatch in C++](#)
- [Asynchronous Dynamic Invocation and Dispatch in Java](#)
- [Asynchronous Dynamic Invocation and Dispatch in C-Sharp](#)

See Also

- [Dynamic Invocation and Dispatch](#)

Asynchronous Dynamic Invocation and Dispatch in C++

This page describes the asynchronous C++ mapping for the `ice_invoke` proxy function and the `Blobject` class.

On this page:

- [Calling `ice_invoke` Asynchronously in C++](#)
 - [Basic Asynchronous Mapping for `ice_invoke` in C++](#)
 - [Generic Asynchronous Callback Mapping for `ice_invoke` in C++](#)
 - [Type-Safe Asynchronous Callback Mapping for `ice_invoke` in C++](#)
- [Subclassing `BlobjectAsync` in C++](#)
- [Subclassing `BlobjectArrayAsync` in C++](#)

Calling `ice_invoke` Asynchronously in C++

The asynchronous mapping for `ice_invoke` resembles that of the [static AMI mapping](#). Multiple overloads are provided to support the use of callbacks, request contexts, and zero-copy semantics. The return value and the parameters `operation`, `mode`, and `inParams` have the same semantics as for the [synchronous version](#) of `ice_invoke`.

Basic Asynchronous Mapping for `ice_invoke` in C++

The basic mapping is shown below:

C++
<pre>Ice::AsyncResultPtr begin_ice_invoke(const std::string& operation, Ice::OperationMode mode, const std::vector<Ice::Byte>& inParams); Ice::AsyncResultPtr begin_ice_invoke(const std::string& operation, Ice::OperationMode mode, const std::vector<Ice::Byte>& inParams, const Ice::Context& __ctx); Ice::AsyncResultPtr begin_ice_invoke(const std::string& operation, Ice::OperationMode mode, const std::pair<const Ice::Byte*, const Ice::Byte*>& inParams); Ice::AsyncResultPtr begin_ice_invoke(const std::string& operation, Ice::OperationMode mode, const std::pair<const Ice::Byte*, const Ice::Byte*>& inParams, const Ice::Context& __ctx, const Ice::LocalObjectPtr& __cookie = 0); bool end_ice_invoke(std::vector<Ice::Byte>&, const Ice::AsyncResultPtr&);</pre>

User exceptions are handled differently than for static asynchronous invocations. Calling `end_ice_invoke` can raise system exceptions but

never raises user exceptions. Instead, the boolean return value of `end_ice_invoke` indicates whether the operation completed successfully (true) or raised a user exception (false). If the return value is true, the byte sequence contains an encapsulation of the results; otherwise, the byte sequence contains an encapsulation of the user exception.

Generic Asynchronous Callback Mapping for `ice_invoke` in C++

The generic callback API is also available:

C++
<pre>Ice::AsyncResultPtr begin_ice_invoke(const std::string& operation, Ice::OperationMode mode, const std::vector<Ice::Byte>& inParams, const Ice::CallbackPtr& __del, const Ice::LocalObjectPtr& __cookie = 0); Ice::AsyncResultPtr begin_ice_invoke(const std::string& operation, Ice::OperationMode mode, const std::vector<Ice::Byte>& inParams, const Ice::Context& __ctx, const Ice::CallbackPtr& __del, const Ice::LocalObjectPtr& __cookie = 0); Ice::AsyncResultPtr begin_ice_invoke(const std::string& operation, Ice::OperationMode mode, const std::pair<const Ice::Byte*, const Ice::Byte*>& inParams, const Ice::CallbackPtr& __del, const Ice::LocalObjectPtr& __cookie = 0); Ice::AsyncResultPtr begin_ice_invoke(const std::string& operation, Ice::OperationMode mode, const std::pair<const Ice::Byte*, const Ice::Byte*>& inParams, const Ice::Context& __ctx, const Ice::CallbackPtr& __del, const Ice::LocalObjectPtr& __cookie = 0);</pre>

Use the `Ice::newCallback` function to create callback objects, as shown in the [static AMI mapping](#).

Type-Safe Asynchronous Callback Mapping for `ice_invoke` in C++

The type-safe callback API looks as follows:

C++

```

Ice::AsyncResultPtr begin_ice_invoke(
    const std::string& operation,
    Ice::OperationMode mode,
    const std::vector<Ice::Byte>& inParams,
    const Ice::Callback_Object_ice_invokePtr& __del,
    const Ice::LocalObjectPtr& __cookie = 0);

Ice::AsyncResultPtr begin_ice_invoke(
    const std::string& operation,
    Ice::OperationMode mode,
    const std::vector<Ice::Byte>& inParams,
    const Ice::Context& __ctx,
    const Ice::Callback_Object_ice_invokePtr& __del,
    const Ice::LocalObjectPtr& __cookie = 0);

Ice::AsyncResultPtr begin_ice_invoke(
    const std::string& operation,
    Ice::OperationMode mode,
    const std::pair<const Ice::Byte*, const Ice::Byte*>& inParams,
    const Ice::Callback_Object_ice_invokePtr& __del,
    const Ice::LocalObjectPtr& __cookie = 0);

Ice::AsyncResultPtr begin_ice_invoke(
    const std::string& operation,
    Ice::OperationMode mode,
    const std::pair<const Ice::Byte*, const Ice::Byte*>& inParams,
    const Ice::Context& __ctx,
    const Ice::Callback_Object_ice_invokePtr& __del,
    const Ice::LocalObjectPtr& __cookie = 0);

```

Several overloads of `Ice::newCallback_Object_ice_invoke` allow you to create callback objects. Versions are provided to support zero-copy semantics for the byte sequence containing the operation's results, as well as a cookie value whose type is inferred and represented here by the `CT` symbol:

C++

```

template<class T> Callback_Object_ice_invokePtr
newCallback_Object_ice_invoke(const IceUtil::Handle<T>& instance,
                             void (T::*cb)(bool, const
std::vector<Ice::Byte>&),
                             void (T::*excb)(const ::Ice::Exception&),
                             void (T::*sentcb)(bool) = 0);

template<class T> Callback_Object_ice_invokePtr
newCallback_Object_ice_invoke(const IceUtil::Handle<T>& instance,
                             void (T::*cb)(bool, const std::pair<const
Byte*, const Byte*>&),
                             void (T::*excb)(const ::Ice::Exception&),
                             void (T::*sentcb)(bool) = 0);

template<class T, typename CT> Callback_Object_ice_invokePtr
newCallback_Object_ice_invoke(const IceUtil::Handle<T>& instance,
                             void (T::*cb)(bool, const
std::vector<Ice::Byte>&, const CT&),
                             void (T::*excb)(const ::Ice::Exception&,
const CT&),
                             void (T::*sentcb)(bool, const CT&) = 0);

template<class T, typename CT> Callback_Object_ice_invokePtr
newCallback_Object_ice_invoke(const IceUtil::Handle<T>& instance,
                             void (T::*cb)(bool, const std::pair<const
Byte*, const Byte*>&,
                             const CT&),
                             void (T::*excb)(const ::Ice::Exception&,
const CT&),
                             void (T::*sentcb)(bool, const CT&) = 0);

template<class T> Callback_Object_ice_invokePtr
newCallback_Object_ice_invoke(const IceUtil::Handle<T>& instance,
                             void (T::*excb)(const ::Ice::Exception&),
                             void (T::*sentcb)(bool) = 0);

template<class T, typename CT> Callback_Object_ice_invokePtr
newCallback_Object_ice_invoke(const IceUtil::Handle<T>& instance,
                             void (T::*excb)(const ::Ice::Exception&,
const CT&),
                             void (T::*sentcb)(bool, const CT&) = 0);

```

Subclassing BObjectAsync in C++

BObjectAsync is the name of the asynchronous counterpart to BObject:

C++

```

namespace Ice {
    class BlobjectAsync : virtual public Ice::Object {
    public:
        virtual void ice_invoke_async(
            const AMD_Object_ice_invokePtr& cb,
            const std::vector<Ice::Byte>& inParams,
            const Ice::Current& current) = 0;
    };
}

```

To implement asynchronous dynamic dispatch, a server must subclass `BlobjectAsync` and override `ice_invoke_async`.

The first argument to the servant's member function is a callback object of type `Ice::AMD_Object_ice_invoke`, shown here:

C++

```

namespace Ice {
    class AMD_Object_ice_invoke : ... {
    public:
        virtual void ice_response(
            bool result,
            const std::vector<Ice::Byte>& outParams) = 0;

        virtual void ice_response(
            bool result,
            const std::pair<const Ice::Byte*,
const Ice::Byte*>& outParams) = 0;

        virtual void ice_exception(const std::exception&) = 0;
        virtual void ice_exception() = 0;
    };
}

```

Upon a successful invocation, the servant must invoke one of the `ice_response` methods on the callback object, passing `true` as the first argument and encoding the encapsulated operation results into `outParams`. To report a user exception, the servant invokes `ice_response` with `false` as the first argument and the encapsulated form of the exception in `outParams`. Note that the second overloading of `ice_response` uses the array mapping (see the next section below).

`ice_exception` has several overloadings. Note however that in the dynamic dispatch model, the `ice_exception` function must not be used to report user exceptions; doing so results in the caller receiving `UnknownUserException`.

Subclassing `BlobjectArrayAsync` in C++

To implement an asynchronous `Blobject` servant that uses the array mapping, derive your implementation class from `Ice::BlobjectArrayAsync` and override the `ice_invoke_async` function:

C++

```
class BlobjectArrayAsync : virtual public Ice::Object {
public:
    virtual void ice_invoke_async(
        const AMD_Object_ice_invokePtr& cb,
        const std::pair<const Ice::Byte*, const Ice::Byte*>& in,
        const Ice::Current& current) = 0;
};
```

As shown in the previous section, the AMD callback class provides an overloaded `ice_response` method that supports the array mapping for the encoded `out` parameter blob.

The discussion of [sequences](#) provides more information on the array mapping.

See Also

- [Asynchronous Method Invocation \(AMI\) in C++](#)
- [Request Contexts](#)
- [C++ Mapping for Sequences](#)
- [Dynamic Invocation and Dispatch in C++](#)

Asynchronous Dynamic Invocation and Dispatch in Java

This page describes the asynchronous Java mapping for the `ice_invoke` proxy function and the `Blobject` class.

On this page:

- [Calling `ice_invoke` Asynchronously in Java](#)
 - [Basic Asynchronous Mapping for `ice_invoke` in Java](#)
 - [Generic Asynchronous Callback Mapping for `ice_invoke` in Java](#)
 - [Type-Safe Asynchronous Callback Mapping for `ice_invoke` in Java](#)
- [Subclassing `BlobjectAsync` in Java](#)

Calling `ice_invoke` Asynchronously in Java

The asynchronous mapping for `ice_invoke` resembles that of the [static AMI mapping](#). Multiple overloads are provided to support the use of callbacks and [request contexts](#). The return value and the parameters `operation`, `mode`, and `inParams` have the same semantics as for the [synchronous version](#) of `ice_invoke`.

Basic Asynchronous Mapping for `ice_invoke` in Java

The basic mapping is shown below:

Java
<pre>Ice.AsyncResult begin_ice_invoke(String operation, Ice.OperationMode mode, byte[] inParams); Ice.AsyncResult begin_ice_invoke(String operation, Ice.OperationMode mode, byte[] inParams, java.util.Map<String, String> __context); boolean end_ice_invoke(Ice.ByteSeqHolder outParams, Ice.AsyncResult __result);</pre>

User exceptions are handled differently than for static asynchronous invocations. Calling `end_ice_invoke` can raise system exceptions but never raises user exceptions. Instead, the boolean return value of `end_ice_invoke` indicates whether the operation completed successfully (true) or raised a user exception (false). If the return value is true, the byte sequence contains an encapsulation of the results; otherwise, the byte sequence contains an encapsulation of the user exception.

Generic Asynchronous Callback Mapping for `ice_invoke` in Java

The generic callback API is also available:

Java

```
Ice.AsyncResult begin_ice_invoke(
    String operation,
    Ice.OperationMode mode,
    byte[] inParams,
    Ice.Callback __cb);

Ice.AsyncResult begin_ice_invoke(
    String operation,
    Ice.OperationMode mode,
    byte[] inParams,
    java.util.Map<String, String> __context,
    Ice.Callback __cb);
```

Refer to the [static AMI mapping](#) for an example of subclassing `Ice.Callback`.

Type-Safe Asynchronous Callback Mapping for `ice_invoke` in Java

The type-safe callback API looks as follows:

Java

```
Ice.AsyncResult begin_ice_invoke(
    String operation,
    Ice.OperationMode mode,
    byte[] inParams,
    Ice.Callback_Object_ice_invoke __cb);

Ice.AsyncResult begin_ice_invoke(
    String operation,
    Ice.OperationMode mode,
    byte[] inParams,
    java.util.Map<String, String> __context,
    Ice.Callback_Object_ice_invoke __cb);
```

Callers must supply a subclass of `Ice.Callback_Object_ice_invoke`:

Java

```
package Ice;

public abstract class Callback_Object_ice_invoke extends ...
{
    public abstract void response(boolean __ret, byte[] outParams);

    public abstract void exception(LocalException __ex);
}
```

The boolean argument to `response` indicates whether the operation completed successfully (true) or raised a user exception (false). If the return value is true, the byte sequence contains an encapsulation of the results; otherwise, the byte sequence contains an encapsulation of the user exception.

Subclassing `BlobjectAsync` in Java

`BlobjectAsync` is the name of the asynchronous counterpart to `Blobject`:

Java

```
package Ice;

public abstract class BlobjectAsync extends Ice.ObjectImpl {
    public abstract void ice_invoke_async(
        Ice.AMD_Object_ice_invoke cb,
        byte[] inParams,
        Ice.Current current);

    // ...
}
```

To implement asynchronous dynamic dispatch, a server must subclass `BlobjectAsync` and override `ice_invoke_async`.

As with any other asynchronous operation, the first argument to the servant's member function is always a callback object. In this case, the callback object is of type `Ice.AMD_Object_ice_invoke`, shown here:

Java

```
package Ice;

public interface AMD_Object_ice_invoke {
    void ice_response(boolean result, byte[] outParams);
    void ice_exception(java.lang.Exception ex);
}
```

Upon a successful invocation, the servant must invoke `ice_response` on the callback object, passing `true` as the first argument and encoding the encapsulated operation results into `outParams`. To report a user exception, the servant invokes `ice_response` with `false` a

s the first argument and the encapsulated form of the exception in `outParams`.

In the dynamic dispatch model, the `ice_exception` function must not be used to report user exceptions; doing so results in the caller receiving `UnknownUserException`.

See Also

- [Asynchronous Method Invocation \(AMI\) in Java](#)
- [Request Contexts](#)
- [Dynamic Invocation and Dispatch Overview](#)

Asynchronous Dynamic Invocation and Dispatch in C-Sharp

This page describes the asynchronous C# mapping for the `ice_invoke` proxy function and the `BlobObject` class.

On this page:

- [Calling `ice_invoke` Asynchronously in C#](#)
 - [Basic Asynchronous Mapping for `ice_invoke` in C#](#)
 - [Generic Asynchronous Callback Mapping for `ice_invoke` in C#](#)
 - [Type-Safe Asynchronous Callback Mapping for `ice_invoke` in C#](#)
- [Subclassing `BlobObjectAsync` in C#](#)

Calling `ice_invoke` Asynchronously in C#

The asynchronous mapping for `ice_invoke` resembles that of the [static AMI mapping](#). Multiple overloads are provided to support the use of callbacks and [request contexts](#). The return value and the parameters `operation`, `mode`, and `inParams` have the same semantics as for the [synchronous version](#) of `ice_invoke`.

Basic Asynchronous Mapping for `ice_invoke` in C#

The basic mapping is shown below:

C#
<pre>Ice.AsyncResult<Ice.Callback_Object_ice_invoke> begin_ice_invoke(string operation, Ice.OperationMode mode, byte[] inParams); Ice.AsyncResult<Callback_Object_ice_invoke> begin_ice_invoke(string operation, Ice.OperationMode mode, byte[] inParams, Dictionary<string, string> context__); bool end_ice_invoke(out byte[] outParams, AsyncResult r__);</pre>

User exceptions are handled differently than for static asynchronous invocations. Calling `end_ice_invoke` can raise system exceptions but never raises user exceptions. Instead, the boolean return value of `end_ice_invoke` indicates whether the operation completed successfully (true) or raised a user exception (false). If the return value is true, the byte sequence contains an encapsulation of the results; otherwise, the byte sequence contains an encapsulation of the user exception.

Generic Asynchronous Callback Mapping for `ice_invoke` in C#

The generic callback API is also available:

C#

```

Ice.AsyncResult begin_ice_invoke(
    string operation,
    Ice.OperationMode mode,
    byte[] inParams,
    Ice.AsyncCallback cb__,
    object cookie__);

Ice.AsyncResult begin_ice_invoke(
    string operation,
    Ice.OperationMode mode,
    byte[] inParams,
    Dictionary<string, string> context__,
    Ice.AsyncCallback cb__,
    object cookie__);

```

Refer to the [static AMI mapping](#) for a callback example.

Type-Safe Asynchronous Callback Mapping for ice_invoke in C#

For the type-safe callback API, you register callbacks on the `AsyncResult` object just as in the [static AMI mapping](#):

C#

```

public class MyCallback
{
    public void responseCB(bool ret, byte[] results)
    {
        if(ret)
            System.Console.Out.WriteLine("Success");
        else
            System.Console.Out.WriteLine("User exception");
    }

    public void failureCB(Ice.Exception ex)
    {
        System.Console.Err.WriteLine("Exception is: " + ex);
    }
}

...

Ice.AsyncResult<Ice.Callback_Object_ice_invoke> r =
proxy.begin_ice_invoke(...);
MyCallback cb = new MyCallback();
r.whenCompleted(cb.responseCB, cb.failureCB);

```

The caller invokes `whenCompleted` on the `AsyncResult` object and supplies delegates to handle response and failure. The response delegate must match the signature of `Ice.Callback_Object_ice_invoke`:

```

C#
public delegate void Callback_Object_ice_invoke(bool ret__, byte[]
outParams);
```

Subclassing `BlobjectAsync` in C#

`BlobjectAsync` is the name of the asynchronous counterpart to `Blobject`:

```

C#
public abstract class BlobjectAsync : Ice.ObjectImpl
{
    public abstract void ice_invoke_async(
        AMD_Object_ice_invoke cb,
        byte[] inParams,
        Current current);
}
```

To implement asynchronous dynamic dispatch, a server must subclass `BlobjectAsync` and override `ice_invoke_async`.

The first argument to the servant's member function is a callback object of type `Ice.AMD_Object_ice_invoke`, shown here:

```

C#
namespace Ice
{
    public interface AMD_Object_ice_invoke
    {
        void ice_response(bool ok, byte[] outParams);
        void ice_exception(System.Exception ex);
    }
}
```

Upon a successful invocation, the servant must invoke `ice_response` on the callback object, passing `true` as the first argument and encoding the encapsulated operation results into `outParams`. To report a user exception, the servant invokes `ice_response` with `false` as the first argument and the encapsulated form of the exception in `outParams`.

In the dynamic dispatch model, the `ice_exception` function must not be used to report user exceptions; doing so results in the caller receiving `UnknownUserException`.

See Also

- [Asynchronous Method Invocation \(AMI\) in C-Sharp](#)
- [Request Contexts](#)
- [Dynamic Invocation and Dispatch Overview](#)

Connection Management

The Ice run time establishes connections automatically and transparently as a side effect of using proxies. There are well-defined rules that determine when a [new connection is established](#). If necessary, you can influence [connection management activities](#).

Connection management becomes increasingly important as network environments grow more complex. In particular, if you need to make callbacks from a server to a client through a firewall, you must use a [bidirectional connection](#). In most cases, you can use a [Glacier2 router](#) to automatically take advantage of bidirectional connections. However, the Ice run time also provides direct access to connections, allowing you to explicitly control establishment and closure of both unidirectional and bidirectional connections.

Most Ice applications benefit from [active connection management](#) and transparent connection establishment and thus need not concern themselves with the details of connections. Not all Ice applications can be so fortunate, and for those applications Ice provides convenient [access to connections](#) that enables developers to address the realities of today's deployment environments.



The discussion that follows assumes that you are familiar with [proxies](#) and [endpoints](#).

Topics

- [Connection Establishment](#)
- [Active Connection Management](#)
- [Using Connections](#)
- [Connection Closure](#)
- [Bidirectional Connections](#)

Connection Establishment

Connections are established as a side effect of using proxies. The first invocation on a proxy causes the Ice run time to search for an existing connection to one of the proxy's endpoints; only if no suitable connection exists does the Ice run time establish a new connection to one of the proxy's endpoints.

This page describes how and when Ice establishes a new connection.

On this page:

- [Endpoint Selection for New Connections](#)
- [Error Semantics for Failed Connections](#)
- [Reusing an Existing Connection](#)
 - [Connection Reuse for Proxies with Multiple Endpoints](#)
 - [Protocol Compression and Connection Reuse](#)
 - [Influencing Connection Reuse](#)
- [Connection Caching](#)
- [Timeouts and Connection Establishment](#)

Endpoint Selection for New Connections

A proxy performs a number of operations on its endpoints before it asks the Ice run time to supply a connection. These operations produce a list of zero or more endpoints that satisfy the proxy's configuration. If the resulting list is empty, the application receives `NoEndpointException` to indicate that no suitable endpoints could be found. For example, this situation can arise when a twoway proxy contains only a UDP endpoint; the UDP endpoint is eliminated from consideration because it cannot be used for twoway invocations.

The proxy performs the following steps to derive its endpoint list:

1. Remove the endpoints of unknown transports. For instance, SSL endpoints are removed if the SSL plug-in is not installed.
2. Remove endpoints that are not suitable for the proxy's invocation mode. For example, datagram endpoints are removed for twoway, oneway and batch oneway proxies. Similarly, non-datagram endpoints are removed for datagram and batch datagram proxies.
3. Perform DNS queries to convert host names into IP addresses, if necessary. For a multi-homed host name, the proxy adds a new endpoint for each address returned by the DNS query.
4. Sort the endpoints according to the configured selection type, which is established using the `ice_endpointSelection` proxy method. The default value is `Random`, meaning the endpoints are randomly shuffled. Alternatively, the value `Ordered` maintains the existing order of the endpoints.
5. Satisfy the proxy's security requirements:
 - If `Ice.Override.Secure` is defined, remove all non-secure endpoints.
 - Otherwise, if the proxy is configured to prefer secure endpoints (e.g., by calling the `ice_preferSecure` proxy method), move all secure endpoints to the beginning of the list. Note that this setting still allows non-secure endpoints to be included.
 - Otherwise, move all non-secure endpoints to the beginning of the list.

If [connection caching](#) is enabled and the Ice run time [already has a compatible connection](#), it reuses the cached connection. Otherwise, the run time attempts to connect to each endpoint in the list until it succeeds or exhausts the list; the order in which endpoints are selected for connection attempts depends on the endpoint selection policy. This policy can be set using a default property (`Ice.Default.EndpointSelection`), using a proxy property (`name.EndpointSelection`), and using the `ice_endpointSelection` proxy method.

Error Semantics for Failed Connections

If a failure occurs during a connection attempt, the Ice run time tries to connect to all of the proxy's remaining endpoints until either a connection is successfully established or all attempts have failed. At that point, the Ice run time may attempt [automatic retries](#) depending on the value of the `Ice.RetryIntervals` configuration property. The default value of this property is 0, which causes the Ice run time to try connecting to all of the endpoints one more time.



Tip

Define the property `Ice.Trace.Retry=2` to monitor these attempts.

If no connection can be established on this second attempt, the Ice run time raises an exception that indicates the reason for the final failed attempt (typically `ConnectFailedException`). Similarly, if a connection was lost during a request and could not be reestablished (assuming the request can be retried), the Ice run time raises an exception that indicates the reason for the final failed attempt.

Reusing an Existing Connection

When establishing a connection for a proxy, the Ice run time reuses an existing connection under the following conditions:

- The remote endpoint matches one of the proxy's endpoints.
- The connection was established by the communicator that created the proxy.
- The connection matches the proxy's configuration. `Timeout values` play an important role here, as an existing connection is only reused if its timeout value (i.e., the timeout used when the connection was established) matches the new proxy's timeout. Similarly, a proxy configured with a `connection ID` only reuses a connection if it was established by a proxy with the same connection ID.

Connection Reuse for Proxies with Multiple Endpoints

Applications must exercise caution when using proxies containing multiple endpoints, especially endpoints using different transports. For example, suppose a proxy has multiple endpoints, such as one each for TCP, SSL, and UDP. When establishing a connection for this proxy, the Ice run time will open a new connection only if it cannot reuse an existing connection to any of the endpoints (that is, if `connection caching` is enabled). Furthermore, the proxy in its default (that is, non-secure) configuration gives higher priority to non-secure endpoints. If you want to ensure that a particular transport is used by a proxy, you must configure the proxy appropriately, such as by calling the `proxy methods` `ice_secure` or `ice_datagram` as necessary.

Protocol Compression and Connection Reuse

The Ice run time does not consider `compression` settings when searching for existing connections to reuse; proxies whose compression settings differ can share the same connection (assuming all other selection criteria are satisfied).

Influencing Connection Reuse

The default behavior of the Ice run time, which reuses connections whenever possible, is appropriate for many applications because it conserves resources and typically has little or no impact on performance. However, when a server implementation attaches semantics to a connection, the client often must be designed to cooperate, despite the tighter coupling it causes. For example, a server might use a serialized `thread pool` to preserve the order of requests received over each connection. If the client wants to execute several requests simultaneously, it must be able to force the Ice run time to establish new connections at will.

For those situations that require more control over connection reuse, the Ice run time allows you to form arbitrary groups of proxies that share a connection by configuring them with the same connection identifier. The `proxy method` `ice_connectionId` returns a new proxy configured with the given connection ID. Once configured, the Ice run time ensures that the proxy only reuses a connection that was established by a proxy with the same connection ID (assuming all other criteria for connection reuse are also satisfied). A new connection is created if none with a matching ID is found, which means each proxy could conceivably have its own connection if each were assigned a unique connection ID.

As an example, consider the following code fragment:

C++

```
Ice::ObjectPrx prx = comm->stringToProxy("ident:tcp -p 10000");
Ice::ObjectPrx g1 = prx->ice_connectionId("group1");
Ice::ObjectPrx g2 = prx->ice_connectionId("group2");
prx->ice_ping(); // Opens a new connection
g1->ice_ping(); // Opens a new connection
g2->ice_ping(); // Opens a new connection
MyInterfacePrx i1 = MyInterfacePrx::checkedCast(g1);
i1->ice_ping(); // Reuses g1's connection
MyInterfacePrx i2 =
MyInterfacePrx::checkedCast(prx->ice_connectionId("group2"));
i2->ice_ping(); // Reuses g2's connection
```

A total of three connections are established by this example:

1. The proxy `prx` establishes a new connection. This proxy has the default connection ID (an empty string).
2. The proxy `g1` establishes a new connection because the only existing connection, the one established by `prx`, has a different connection ID.
3. Similarly, the proxy `g2` establishes a new connection because none of the existing connections have a matching connection ID.

The proxy `i1` inherits its connection ID from `g1`, and therefore shares the connection for `group1`; `i2` explicitly configured its connection ID and shares the `group2` connection with proxy `g2`.

Connection Caching

When we refer to a proxy's connection, we actually mean the connection that the proxy is *currently* using. This connection can change over time, such that a proxy might use several connections during its lifetime. For example, an idle connection may be [closed automatically](#) and then transparently replaced by a new connection when activity resumes.

After establishing a connection in response to proxy activities, the Ice run time adds the connection to an internal pool for subsequent [reuse](#) by other proxies. The Ice run time manages the lifetime of the connection and eventually [closes](#) it. The connection is not affected by the life cycle of the proxies that use it, except that the lack of activity may prompt the Ice run time to close the connection after a while.

Once a proxy has been associated with a connection, the proxy's default behavior is to continue using that connection for all subsequent requests. In effect, the proxy caches the connection and attempts to use it for as long as possible in order to minimize the overhead of creating new connections. If the connection is later closed and the proxy is used again, the proxy repeats the connection-establishment procedure described [earlier](#).

There are situations in which this default caching behavior is undesirable, such as when a client has a proxy with multiple endpoints and wishes to balance the load among the servers at those endpoints. The client can disable connection caching by passing an argument of `false` to the proxy method `ice_connectionCached`. The new proxy returned by this method repeats the connection-establishment procedure before each request, thereby achieving request load balancing at the expense of potentially higher latency.

This type of load balancing is performed solely by the client using whatever endpoints are contained in the proxy. More sophisticated forms of load balancing are also possible, such as when using [IceGrid](#).

Timeouts and Connection Establishment

A proxy's default configuration has a timeout value of `-1`, meaning that network activity initiated by this proxy does not time out. The timeout value affects both connection establishment and remote invocations. If a different timeout value is specified and the connection cannot be established within the allotted time, a `ConnectTimeoutException` is raised.

You can set a timeout on a proxy using the `ice_timeout` [proxy method](#). To use the same timeout period for all proxies, you can define the `Ice.Override.Timeout` property; in this case, any timeout established using the `ice_timeout` proxy method is ignored. Finally, if you want to specify a [separate timeout](#) value that affects only connection establishment and takes precedence over a proxy's configured timeout value, you can define the `Ice.Override.ConnectTimeout` property.

The timeout in effect when a connection is established is bound to that connection and affects all requests on that connection. If a request times out, all other outstanding requests on the same connection also time out, and the connection is [closed forcefully](#). The Ice run time automatically retries these requests on a new connection, assuming that [automatic retries](#) are enabled and would not violate at-most-once semantics.

See Also

- [Proxy Methods](#)
- [Proxy Endpoints](#)
- [The Ice Threading Model](#)
- [Automatic Retries](#)
- [Active Connection Management](#)
- [IceGrid](#)
- [Ice Default and Override Properties](#)
- [Ice Proxy Properties](#)
- [Ice Miscellaneous Properties](#)

Active Connection Management

Active Connection Management (ACM) is enabled by default and helps to improve scalability and conserve application resources by closing idle connections.

On this page:

- [Configuring Active Connection Management](#)
- [Disabling Active Connection Management](#)

Configuring Active Connection Management

ACM is configured separately for client (outgoing) and server (incoming) connections using the properties `Ice.ACM.Client` and `Ice.ACM.Server`, respectively. The default value of `Ice.ACM.Client` is 60, meaning an outgoing connection is closed if it has not been used for sixty seconds. The default value of `Ice.ACM.Server` is zero, which disables ACM for incoming connections. Ice disables server ACM by default because it can cause incoming [oneway requests](#) to be silently discarded.

You can also selectively enable or disable ACM for individual [object adapters](#) by setting the property `<adapter>.ACM`.

The decision to close a connection is not based only on a lack of network activity. For example, a request may take longer to complete than the configured idle time. Therefore, ACM does not close a connection if there are outgoing or incoming requests pending on that connection, or if a [batch request](#) is being accumulated for that connection.

When it is safe to [close the connection](#), the closure is usually transparent to the client and server applications because the connection is automatically reestablished if necessary. We say connection closure is *usually transparent* because it is possible that the Ice run time will be unable to reestablish a connection for a variety of reasons. In such a situation, the application receives a local exception for new requests (usually a `ConnectFailedException`).

It is important that you choose an idle time that does not result in excessive connection closure and reestablishment. The default value of sixty seconds is a reasonable default, but your requirements may determine a more appropriate value.

The run time periodically scans through all open connections to close those that have exceeded their idle time. By default, the scanning interval is 10% of the smallest configured ACM timeout, with a minimum of 5 seconds and a maximum of 5 minutes. You can choose a different scanning interval by setting the property `Ice.MonitorConnections` to the desired interval in seconds. Once a connection exceeds its idle time, it is closed during the next scan. This means that, if you set a scanning interval of 120 seconds, and have an ACM timeout of 60 seconds, idle connections will be closed once they have been idle for between one and three minutes. For servers with many (thousands) of incoming connections, you should set the scanning interval to the longest amount of time you can afford connections to remain open past their idle limit; this reduces the overhead of the scans and makes it more likely that each scan will actually find and close idle connections.

Disabling Active Connection Management

Since server ACM is disabled by default, you only need to set `Ice.ACM.Client` to 0 to disable ACM for all connections. In this configuration a connection is not closed until its communicator is destroyed or it is [closed explicitly](#) by the application. It is important to note that disabling ACM in a process does not prevent a remote peer from closing a connection; all peers must be properly configured in order to truly disable ACM.

There are certain situations in which it is necessary to disable ACM. For example, [oneway requests](#) can be silently discarded when a connection is closed. As another example, ACM must be disabled when using [bidirectional connections](#). A bidirectional connection is enabled by using a router such as [Glacier2](#) or by configuring a connection explicitly for bidirectional use. If you do not disable ACM in such cases, ACM can prematurely close a bidirectional connection and thereby cause callbacks to fail unexpectedly.

See Also

- [Oneway Invocations](#)
- [Object Adapters](#)
- [Batched Invocations](#)
- [Using Connections](#)
- [Connection Closure](#)
- [Bidirectional Connections](#)

- [Glacier2](#)

Using Connections

Applications can gain access to an Ice object representing an established connection.

On this page:

- [The Connection Interface](#)
 - [Flushing Batch Requests for a Connection](#)
- [The Endpoint Interface](#)
 - [Opaque Endpoints](#)
- [Client-Side Connection Usage](#)
- [Server-Side Connection Usage](#)
- [Closing a Connection](#)
 - [Graceful Closure](#)
 - [Forceful Closure](#)

The Connection Interface

The Slice definition of the `Connection` interface is shown below:

Slice

```

module Ice {
    local class ConnectionInfo {
        bool incoming;
        string adapterName;
    };

    local interface Connection {
        void close(bool force);
        Object* createProxy(Identity id);
        void setAdapter(ObjectAdapter adapter);
        ObjectAdapter getAdapter();
        Endpoint getEndpoint();
        void flushBatchRequests();
        string type();
        int timeout();
        string toString();
        ConnectionInfo getInfo();
    };

    local class IPConnectionInfo extends ConnectionInfo {
        string localAddress;
        int localPort;
        string remoteAddress;
        int remotePort;
    };

    local class TCPConnectionInfo extends IPConnectionInfo {};

    local class UDPConnectionInfo extends IPConnectionInfo {
        string mcastAddress;
        int mcastPort;
    };
};

module IceSSL {
    local class ConnectionInfo extends Ice::IPConnectionInfo {
        string cipher;
        Ice::StringSeq certs;
    };
};

```

As indicated in the Slice definition, a connection is a [local interface](#), similar to a communicator or an object adapter. A connection therefore is only usable within the process and cannot be accessed remotely.

The `Connection` interface supports the following operations:

- `void close(bool force)`
Explicitly [closes the connection](#). The connection is closed gracefully if `force` is false, otherwise the connection is closed forcefully.

- `Object* createProxy(Identity id)`
Creates a special proxy that only uses this connection. This operation is primarily used for [bidirectional connections](#).
- `void setAdapter(ObjectAdapter adapter)`
Associates this connection with an object adapter to enable a [bidirectional connection](#).
- `ObjectAdapter getAdapter()`
Returns the object adapter associated with this connection, or nil if no association has been made.
- `Endpoint getEndpoint()`
Returns an [Endpoint object](#).
- `void flushBatchRequests()`
Flushes any pending [batch requests](#) for this connection.
- `string type()`
Returns the connection type as a string, such as "tcp".
- `int timeout()`
Returns the [timeout](#) value used when the connection was established.
- `string toString()`
Returns a readable description of the connection.
- `ConnectionInfo getInfo()`
This operation returns a `ConnectionInfo` class defined as follows:

Slice
<pre>local class ConnectionInfo { bool incoming; string adapterName; };</pre>

The `incoming` member is true if the connection is an incoming connection and false, otherwise. If `incoming` is true, `adapterName` provides the name of the object adapter that accepted the connection. Note that the object returned by `getInfo` implements a more derived interface, depending on the connection type. You can down-cast the returned class instance and access the connection-specific information according to the type of the connection.

Flushing Batch Requests for a Connection

The `flushBatchRequests` operation blocks the calling thread until any batch requests that are queued for a connection have been successfully written to the local transport. To avoid the risk of blocking, you can also invoke this operation asynchronously using the `begin_flushBatchRequests` method (in those language mappings that support it).

Since batch requests are inherently oneway invocations, the `begin_flushBatchRequests` method does not support a request callback. However, you can use the exception callback to handle any errors that might occur while flushing, and the sent callback to receive notification that the batch request has been flushed successfully.

For example, the code below demonstrates how to flush batch requests asynchronously in C++:

C++

```

class FlushCallback : public IceUtil::Shared
{
public:

    void exception(const Ice::Exception& ex)
    {
        cout << "Flush failed: " << ex << endl;
    }

    void sent(bool sentSynchronously)
    {
        cout << "Batch sent!" << endl;
    }
};
typedef IceUtil::Handle<FlushCallback> FlushCallbackPtr;

void flushConnection(const Ice::ConnectionPtr& conn)
{
    FlushCallbackPtr f = new FlushCallback;
    Ice::Callback_Connection_flushBatchRequestsPtr cb =
        Ice::newCallback_Connection_flushBatchRequests(
            f, &FlushCallback::exception, &FlushCallback::sent);
    conn->begin_flushBatchRequests(cb);
}

```

For more information on asynchronous invocations, please see the relevant language mapping chapter.

The Endpoint Interface

The `Connection::getEndpoint` operation returns an interface of type `Endpoint`:

Slice

```

module Ice {
    const short TCPEndpointType = 1;
    const short UDPEndpointType = 3;

    local class EndpointInfo {
        int timeout;
        bool compress;
        short type();
        bool datagram();
        bool secure();
    };

    local interface Endpoint {
        EndpointInfo getInfo();
        string toString();
    };

    local class IPEndpointInfo extends EndpointInfo {
        string host;
        int port;
    };

    local class TCPEndpointInfo extends IPEndpointInfo {};

    local class UDPEndpointInfo extends IPEndpointInfo {
        byte protocolMajor;
        byte protocolMinor;
        byte encodingMajor;
        byte encodingMinor;
        string mcastInterface;
        int mcastTtl;
    };

    local class OpaqueEndpointInfo extends EndpointInfo {
        Ice::ByteSeq rawBytes;
    };
};

module IceSSL {
    const short EndpointType = 2;

    local class EndpointInfo extends Ice::IPEndpointInfo {};
};

```

The `getInfo` operation returns an `EndpointInfo` instance. Note that the object returned by `getInfo` implements a more derived interface, depending on the endpoint type. You can down-cast the returned class instance and access the endpoint-specific information according to the type of the endpoint, as returned by the `type` operation.

The `timeout` member provides the timeout in milliseconds. The `compress` member is true if the endpoint uses [compression](#) (if available). The `datagram` operation returns true if the endpoint is for a [datagram](#) transport, and the `secure` operation returns true if the endpoint uses [SSL](#).

The derived classes provide further detail about the endpoint according to its type.

Opaque Endpoints

An application may receive a proxy that contains an endpoint whose type is unrecognized by the Ice run time. In this situation, Ice preserves the endpoint in its encoded (*opaque*) form so that the proxy remains intact, but Ice ignores the endpoint for all connection-related activities. Preserving the endpoint allows an application to later forward that proxy with all of its original endpoints to a different program that might support the endpoint type in question.

Although a connection will never return an opaque endpoint, it is possible for a program to encounter an opaque endpoint when iterating over the endpoints returned by the [proxy method](#) `ice_getEndpoints`.

As a practical example, consider a program for which the `IceSSL` plug-in is not configured. If this program receives a proxy containing an SSL endpoint, Ice treats it as an opaque endpoint such that calling `getInfo` on the endpoint object returns an instance of `OpaqueEndpointInfo`.

Note that the `type` operation of the `OpaqueEndpointInfo` object returns the *actual* type of the endpoint. For example, the operation returns the value 2 if the object encodes an SSL endpoint. As a result, your program cannot assume that an `EndpointInfo` object whose type is 2 can be safely down-cast to `IceSSL::EndpointInfo`; if the `IceSSL` plug-in is not configured, such a down-cast will fail because the object is actually an instance of `OpaqueEndpointInfo`.

Client-Side Connection Usage

Clients obtain a connection by using one of the [proxy methods](#) `ice_getConnection` or `ice_getCachedConnection`. If the proxy does not yet have a connection, the `ice_getConnection` method immediately attempts to establish one. As a result, the caller must be prepared to handle [connection failure](#) exceptions. Furthermore, if the proxy denotes a [collocated object](#) and collocation optimization is enabled, calling `ice_getConnection` results in a `CollocationOptimizationException`.

If you wish to obtain the proxy's connection without the potential for triggering connection establishment, call `ice_getCachedConnection`; this method returns null if the proxy is not currently associated with a connection or if connection caching is disabled for the proxy.

As an example, the C++ code below illustrates how to obtain a connection from a proxy and print its type:

C++

```

Ice::ObjectPrx proxy = ...
try
{
    Ice::ConnectionPtr conn = proxy->ice_getConnection();
    cout << conn->type() << endl;
}
catch(const Ice::CollocationOptimizationException&)
{
    cout << "collocated" << endl;
}

```

Server-Side Connection Usage

Servers can access a connection via the `con` member of the `Ice::Current` parameter passed to every operation. For collocated invocations, `con` has a nil value.

For example, this Java code shows how to invoke `toString` on the connection:

```

Java

public int add(int a, int b, Ice.Current curr)
{
    if (curr.con != null)
    {
        System.out.println("Request received on connection:\n" +
curr.con.toString());
    }
    else
    {
        System.out.println("collocated invocation");
    }
    return a + b;
}

```

Although the mapping for the Slice operation `toString` results in a Java method named `_toString`, the Ice run time implements `toString` to return the same value.

Closing a Connection

Applications should rarely need to close a connection explicitly, but those that do must be aware of its implications. Since there are two ways to close a connection, we discuss them separately.

Graceful Closure

Passing an argument of `false` to the `close` operation initiates graceful connection closure, as discussed in [Connection Closure](#). The operation blocks until all pending outgoing requests on the connection have completed.

Forceful Closure

A forceful closure is initiated by passing an argument of `true` to the `close` operation, causing the peer to receive a `ConnectionLostException`.

A client must use caution when forcefully closing a connection. Any outgoing requests that are pending on the connection when `close` is invoked will fail with a `ForcedCloseConnectionException`. Furthermore, requests that fail with this exception are not automatically retried.

In a server context, forceful closure can be useful as a defense against hostile clients.

The Ice run time interprets a `CloseConnectionException` to mean that it is safe to [retry](#) the request without violating at-most-once semantics. If automatic retries are enabled, a client must only initiate a graceful close when it knows that there are no outgoing requests in progress on that connection, or that any pending requests can be safely retried.

See Also

- [The Current Object](#)
- [Automatic Retries](#)
- [Connection Establishment](#)
- [Connection Closure](#)
- [Bidirectional Connections](#)
- [IceSSL](#)

Connection Closure

The Ice run time may close a connection for many reasons, including the situations listed below:

- When deactivating an object adapter or shutting down a communicator
- As required by [active connection management](#)
- When initiated by [an application](#)
- After a [request times out](#)
- In response to an exception, such as a socket failure or protocol error

In most cases, the Ice run time closes a connection gracefully as required by the [Ice protocol](#). The Ice run time only closes a connection forcefully when a [timeout](#) occurs or when the application explicitly requests it.

On this page:

- [Graceful Connection Closure](#)
- [Connection Closure and Oneway Invocations](#)

Graceful Connection Closure

Gracefully closing a connection occurs in stages:

- In the process that initiates closure, incoming and outgoing requests that are in progress are allowed to complete, and then a close connection message is sent to the peer. Any incoming requests received after closure is initiated are silently discarded (but may be retried, as discussed in the next bullet). An attempt to make a new outgoing request on the connection results in a `CloseConnectionException` and an automatic retry (if enabled).
- Upon receipt of a close connection message, the Ice run time in the peer closes its end of the connection. Any outgoing requests still pending on that connection fail with a `CloseConnectionException`. This exception indicates to the Ice run time that it is safe to retry those requests without violating at-most-once semantics, assuming [automatic retries](#) have not been disabled.
- After detecting that the peer has closed the connection, the initiating Ice run time closes the connection.

Connection Closure and Oneway Invocations

[Oneway invocations](#) are generally considered reliable because they are sent over a stream-oriented transport. However, it is quite possible for oneway requests to be silently discarded if a server has initiated [graceful connection closure](#). Whereas graceful closure causes a discarded twoway request to receive a `CloseConnectionException` and eventually be retried, the sender receives no notice about a discarded oneway request.

If an application makes assumptions about the reliability of oneway requests, it may be necessary to control the events surrounding connection closure as much as possible, for example by [disabling active connection management](#) and avoiding explicit connection closures.

See Also

- [Active Connection Management](#)
- [Using Connections](#)
- [Protocol Messages](#)
- [Connection Establishment](#)
- [Oneway Invocations](#)
- [Automatic Retries](#)

Bidirectional Connections

On this page:

- [Use Cases for Bidirectional Connections](#)
- [Configuring a Client for Bidirectional Connections](#)
 - [Disabling Active Connection Management](#)
- [Configuring a Server for Bidirectional Connections](#)
- [Fixed Proxies](#)
- [Limitations of Bidirectional Connections](#)
- [Threading Considerations for Bidirectional Connections](#)

Use Cases for Bidirectional Connections

An Ice connection normally allows requests to flow in only one direction. If an application's design requires the server to make callbacks to a client, the server usually establishes a new connection to that client in order to send callback requests, as shown below:

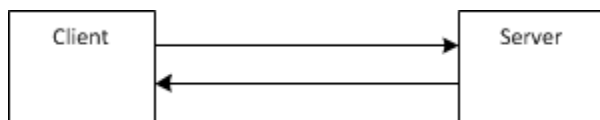

Callbacks in an open network.

Unfortunately, network restrictions often prevent a server from being able to create a separate connection to the client, such as when the client resides behind a firewall as shown here:

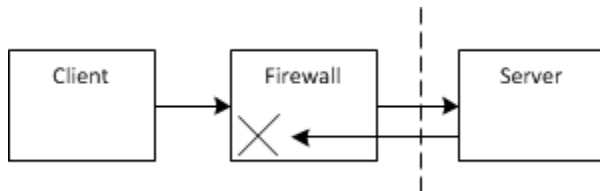

Callbacks with a firewall.

In this scenario, the firewall blocks any attempt to establish a connection directly to the client.

For situations such as these, a bidirectional connection offers a solution. Requests may flow in both directions over a bidirectional connection, enabling a server to send callback requests to a client over the client's existing connection to the server.

There are two ways to make use of a bidirectional connection. First, you can use a [Glacier2 router](#), in which case bidirectional connections are used automatically. If you do not require the functionality offered by Glacier2 or you do not want an intermediary service between clients and servers, you can configure bidirectional connections manually.

The remainder of this section discusses manual configuration of bidirectional connections. An example that demonstrates how to configure a bidirectional connection is provided in the directory `demo/Ice/bidir` of your Ice distribution.

Configuring a Client for Bidirectional Connections

A client needs to perform the following steps in order to configure a bidirectional connection:

1. [Create an object adapter](#) to receive callback requests. This adapter does not require a name or endpoints if its only purpose is to receive callbacks over bidirectional connections.
2. [Register the callback object](#) with the object adapter.
3. Activate the object adapter.
4. [Obtain a connection](#) object by calling `ice_getConnection` on the proxy.
5. Invoke `setAdapter` on the connection, passing the callback object adapter. This associates an object adapter with the connection and enables callback requests to be dispatched.
6. Pass the `identity` of the callback object to the server.

The C++ code below illustrates these steps:

```
C++
```

```
Ice::ObjectAdapterPtr adapter = communicator->createObjectAdapter( "" );
Ice::Identity ident;
ident.name = IceUtil::generateUUID();
ident.category = "";
CallbackPtr cb = new CallbackI;
adapter->add( cb, ident );
adapter->activate();
proxy->ice_getConnection()->setAdapter( adapter );
proxy->addClient( ident );
```

The last step may seem unusual because a client would typically pass a proxy to the server, not just an identity. For example, you might be tempted to give the proxy returned by the adapter operation `add` to the server, but this would not have the desired effect: if the callback object adapter is configured with endpoints, the server would attempt to establish a separate connection to one of those endpoints, which defeats the purpose of a bidirectional connection. It is just as likely that the callback object adapter has no endpoints, in which case the proxy is of no use to the server.

Similarly, you might try invoking `createProxy` on the connection to obtain a proxy that the server can use for callbacks. This too would fail, because the proxy returned by the connection is for local use only and cannot be used by another process.

As you will see below, the server must create its own callback proxy.

Disabling Active Connection Management

Active Connection Management (ACM) automatically and transparently closes idle connections. By default, ACM is enabled for client (outgoing) connections and disabled for server (incoming) connections. As far as the client-side Ice run time is concerned, a bidirectional connection is a client connection, therefore the client-side property `Ice.ACM.Client` governs ACM behavior for bidirectional connections.

In general, it is necessary to disable client-side ACM for bidirectional connections: since the outgoing connection is the only channel on which the server can send callback invocations to the client, allowing ACM to prematurely close the connection introduces the risk that the client might unknowingly fail to receive callbacks. To disable client-side ACM, set the property to zero:

```
Ice.ACM.Client=0
```

It is not necessary to disable client-side ACM if your client sends invocations at regular intervals, in which case Ice will never consider the connection to be idle and therefore ACM will not close it. The default value for `Ice.ACM.Client` is 60, meaning a connection that has been idle for 60 seconds is eligible to be closed.

Configuring a Server for Bidirectional Connections

A server needs to take the following steps in order to make callbacks over a bidirectional connection:

1. Obtain the identity of the callback object, which is typically supplied by the client.
2. **Create a proxy** for the callback object by calling `createProxy` on the connection. The connection object is accessible as a member of the `Ice::Current` parameter to an operation implementation.

These steps are illustrated in the C++ code below:

C++

```

void addClient(const Ice::Identity& ident, const Ice::Current& curr)
{
    CallbackPrx client =
    CallbackPrx::uncheckedCast(curr.con->createProxy(ident));
    client->notify();
}

```

Fixed Proxies

The proxy returned by a connection's `createProxy` operation is called a *fixed proxy*. It can only be used in the server process and cannot be marshaled or stringified by `proxyToString`; attempts to do so raise `FixedProxyException`.

A fixed proxy is bound to the connection that created it, and ceases to work once that connection is closed. If the connection is closed prematurely, either by [active connection management](#) (ACM) or by explicit action on the part of the application, the server can no longer make callback requests using that proxy. Any attempt to use the proxy again usually results in a `CloseConnectionException`.

Many aspects of a fixed proxy cannot be changed. For example, it is not possible to change the proxy's endpoints or timeout. Attempting to invoke a method such as `ice_timeout` on a fixed proxy raises `FixedProxyException`.

Limitations of Bidirectional Connections

Bidirectional connections have certain limitations:

- They can only be configured for connection-oriented transports such as TCP and SSL.
- Most proxy [factory methods](#) are not relevant for a proxy created by a connection's `createProxy` operation. The proxy is bound to an existing connection, therefore the proxy reflects the connection's configuration. Attempting to change settings such as the proxy's timeout value causes the Ice run time to raise `FixedProxyException`. Note however that it is legal to configure a fixed proxy for using oneway or twoway invocations. You may also invoke `ice_secure` on a fixed proxy if its security configuration is important; a fixed proxy configured for secure communication raises `NoEndpointException` on the first invocation if the connection is not secure.
- A connection established from a Glacier2 router to a server is not configured for bidirectional use. Only the connection from a client to the router is bidirectional. However, the client must not attempt to manually configure a bidirectional connection to a router, as this is handled internally by the Ice run time.
- Bidirectional connections are not compatible with [ACM](#).

Threading Considerations for Bidirectional Connections

The Ice run time normally creates two [thread pools](#) for processing network traffic on connections: the client thread pool manages outgoing connections and the server thread pool manages incoming connections. All of the object adapters in a server share the same thread pool by default, but an object adapter can also be configured to have [its own thread pool](#). The default size of the client and server thread pools is one.

The client thread pool processes replies to pending requests. When a client configures an outgoing connection for bidirectional requests, the client thread pool also becomes responsible for dispatching callback requests received over that connection.

Similarly, the server thread pool normally dispatches requests from clients. If a server uses a bidirectional connection to send callback requests, then the server thread pool must also process the replies to those requests.

You must increase the size of the appropriate thread pool if you need the ability to dispatch multiple requests in parallel, or if you need to make [nested twoway invocations](#). For example, a client that receives a callback request over a bidirectional connection and makes nested invocations must increase the size of the *client* thread pool.

See Also

- [Glacier2](#)
- [Creating an Object Adapter](#)
- [Servant Activation and Deactivation](#)
- [Using Connections](#)
- [Object Identity](#)
- [Active Connection Management](#)
- [Proxy Methods](#)
- [Nested Invocations](#)
- [The Ice Threading Model](#)
- [Object Adapter Thread Pools](#)

The Ice Protocol

The Ice protocol definition consists of three major parts:

- a set of data encoding rules that determine how the various data types are serialized
- a number of message types that are interchanged between client and server, together with rules as to what message is to be sent under what circumstances
- a set of rules that determine how client and server agree on a particular protocol and encoding version

Topics

- [Data Encoding](#)
- [Protocol Messages](#)
- [Protocol Compression](#)
- [Protocol and Encoding Versions](#)

Data Encoding

The key goals of the Ice data encoding are simplicity and efficiency. In keeping with these principles, the encoding does not align primitive types on word boundaries and therefore eliminates the wasted space and additional complexity that alignment requires. The Ice data encoding simply produces a stream of contiguous bytes; data contains no padding bytes and need not be aligned on word boundaries.

Data is always encoded using little-endian byte order for numeric types. (Most machines use a little-endian byte order, so the Ice data encoding is "right" more often than not.) Ice does not use a "receiver makes it right" scheme because of the additional complexity this would introduce. Consider, for example, a chain of receivers that merely forward data along the chain until that data arrives at an ultimate receiver. (Such topologies are common for event distribution services.) The Ice protocol permits all the intermediates to forward the data without requiring it to be unmarshaled: the intermediates can forward requests by simply copying blocks of binary data. With a "receiver makes it right" scheme, the intermediates would have to unmarshal and remarshal the data whenever the byte order of the next receiver in the chain differs from the byte order of the sender, which is inefficient.

Ice requires clients and servers that run on big-endian machines to incur the extra cost of byte swapping data into little-endian layout, but that cost is insignificant compared to the overall cost of sending or receiving a request.

Topics

- [Basic Data Encoding](#)
- [Data Encoding for Exceptions](#)
- [Data Encoding for Classes](#)
- [Data Encoding for Interfaces](#)
- [Data Encoding for Proxies](#)
- [Data Encoding for Optional Values](#)

See Also

- [Protocol Messages](#)

Basic Data Encoding

On this page:

- [Encoding for Sizes](#)
- [Encoding for Encapsulations](#)
- [Encoding for Slices](#)
- [Encoding for Basic Types](#)
- [Encoding for Strings](#)
- [Encoding for Sequences](#)
- [Encoding for Dictionaries](#)
- [Encoding for Enumerators](#)
- [Encoding for Structures](#)

Encoding for Sizes

Many of the types involved in the data encoding, as well as several [protocol message](#) components, have an associated size or count. A size is a non-negative number. Sizes and counts are encoded in one of two ways:

1. If the number of elements is less than 255, the size is encoded as a `byte` indicating the number of elements.
2. If the number of elements is greater than or equal to 255, the size is encoded as a `byte` with value 255, followed by an `int` indicating the number of elements.

Using this encoding to indicate sizes is significantly cheaper than always using an `int` to store the size, especially when marshaling sequences of short strings: counts of up to 254 require only a single byte instead of four. This comes at the expense of counts greater than 254, which require five bytes instead of four. However, for sequences or strings of length greater than 254, the extra byte is insignificant.

Encoding for Encapsulations

An encapsulation is used to contain variable-length data that an intermediate receiver may not be able to decode, but that the receiver can forward to another recipient for eventual decoding. An encapsulation is encoded as if it were the following structure:

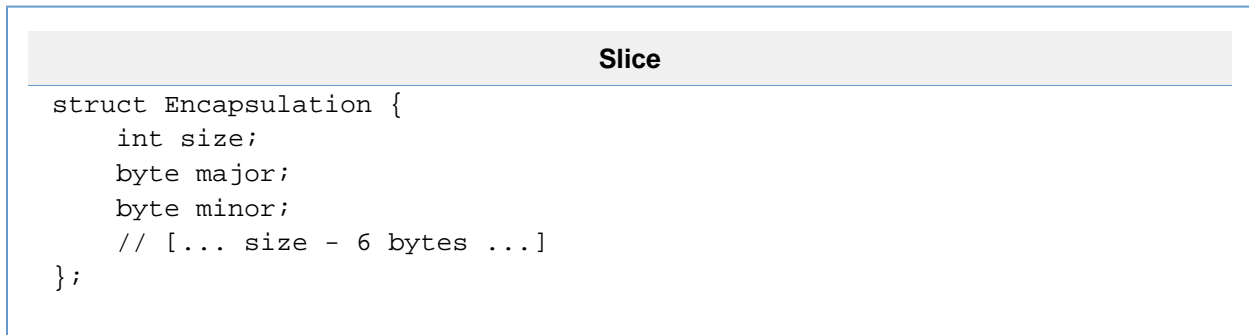

The `size` member specifies the size of the encapsulation in bytes (including the `size`, `major`, and `minor` fields). The `major` and `minor` fields specify the [encoding version](#) of the data contained in the encapsulation. The version information is followed by `size-6` bytes of encoded data.

All the data in an encapsulation is context-free, that is, nothing inside an encapsulation can refer to anything outside the encapsulation. This property allows encapsulations to be forwarded among address spaces as a blob of data.

Encapsulations can be nested, that is, contain other encapsulations.

An encapsulation can be empty, in which case the value of `size` is 6.

Encoding for Slices

The encoding format of slices changed in version 1.1.

Slice Encoding version 1.0

[Exceptions](#) and [classes](#) may be subject to *slicing* if the receiver of a value only partially understands the received value (that is, only has knowledge of a base type, but not of the actual run-time derived type). To allow the receiver of an exception or class to ignore those parts of a value that it does not understand, exception and class values are marshaled as a sequence of [slices](#) (one slice for each level of the inheritance hierarchy). A slice is a byte count encoded as a fixed-length four-byte integer, followed by the data for the slice. (The byte count includes the four bytes occupied by the count itself, so an empty slice has a byte count of four and no data.) The receiver of a value can skip over a slice by reading the byte count b , and then discarding the next $b-4$ bytes in the input stream.

Slice Encoding version 1.1

Version 1.1 of the encoding still marshals [exceptions](#) and [classes](#) as [slices](#) in conceptually the same manner as for version 1.0, but bit flags in the leading byte of each slice determine its format and content.

Type ID

The initial slice of a class or exception, representing the instance's most-derived type, always includes a type ID. For an exception, the type ID in the initial slice is encoded as a string. For a class, the type ID in the initial slice can either be encoded as a string, an index (if the same type ID has already been encoded in the current encapsulation), or a compact ID.

Whether any subsequent slices include some form of type ID depends on the [format](#) with which the value was encoded: to facilitate slicing an instance to a less-derived type, the sliced format includes a type ID in every slice, whereas the compact format excludes type IDs in subsequent slices to conserve space while sacrificing the slicing feature.

Optional Data Members

This flag is true if the slice includes any [optional data members](#), which are encoded after all required members. If a slice encodes its size, the size includes the optional data members.

Object Indirection Table

This flag can only be true when using the [sliced format](#). In this case, data members that refer to class instances are encoded as indices into an [indirection table](#) that immediately follows the slice. The slice's size does *not* include the indirection table. This flag should only be set to true when there is at least one non-nil object reference in the slice, that is, when the indirection table is not empty.

Slice Size

If this flag is true, a byte count encoded as a fixed-length four-byte integer immediately follows the type ID. (The byte count includes the four bytes occupied by the count itself, so an empty slice has a byte count of four and no data.) The byte count indicates the number of bytes occupied by the encoding for the required and optional data members, but does not include the size of an object indirection table, if present.

A receiver can skip over a slice by reading the byte count b , and then discarding the next $b-4$ bytes in the input stream. If an object indirection table is present, the receiver must then decode the table.

If this flag is false, it implies that the sender used the [compact format](#) and therefore skipping slices is not possible. The receiver must know the most-derived type in this situation otherwise decoding will fail.

Last Slice

This flag indicates whether the current slice is the last slice of the instance.

Slice Flags

The table below shows how to interpret the bit flags in the leading byte of a slice:

Bit number	Description
0-1	0 = no type ID is encoded for the slice
	1 = type ID is encoded as a string
	2 = type ID is an index encoded as a size
	3 = type ID is a compact ID encoded as a size
2	Whether or not the slice contains optional data members

3	Whether or not the slice contains an indirection table
4	Whether or not the slice size follows the type ID
5	If 0, more slices will follow, if 1, this is the last slice
6	Reserved for future use
7	Reserved for future use

Bit flags for a slice.

Encoding for Basic Types

The basic types are encoded as shown in the table. Integer types (`short`, `int`, `long`) are represented as two's complement numbers, and floating point types (`float`, `double`) use the IEEE standard formats [1]. All numeric types use a little-endian byte order.

Type	Encoding
<code>bool</code>	A single byte with value 1 for <code>true</code> , 0 for <code>false</code>
<code>byte</code>	An uninterpreted byte
<code>short</code>	Two bytes (LSB, MSB)
<code>int</code>	Four bytes (LSB .. MSB)
<code>long</code>	Eight bytes (LSB .. MSB)
<code>float</code>	Four bytes (23-bit fractional mantissa, 8-bit exponent, sign bit)
<code>double</code>	Eight bytes (52-bit fractional mantissa, 11-bit exponent, sign bit)

Encoding for basic types.

Encoding for Strings

Strings are encoded as a `size`, followed by the string contents in UTF-8 format [2]. Strings are not NUL-terminated. An empty string is encoded with a size of zero.

Encoding for Sequences

Sequences are encoded as a `size` representing the number of elements in the sequence, followed by the elements encoded as specified for their type.

Encoding for Dictionaries

Dictionaries are encoded as a `size` representing the number of key-value pairs in the dictionary, followed by the pairs. Each key-value pair is encoded as if it were a `struct` containing the key and value as members, in that order.

Encoding for Enumerators

The encoding format of enumerators changed in version 1.1.

Enumerator Encoding version 1.0

The number of bytes required to encode an enumerator in version 1.0 is determined by the largest value in the enumeration. In

enumerations with no [custom enumerator values](#), the largest value is the number of enumerators less one; the value encoded for an enumerator is its ordinal value in the definition, with the first enumerator having the value zero. For example, the largest value in the following enumeration is 2:

```
Slice
```

```
enum Fruit { Apple, Pear, Orange }; // Encoded values: Apple = 0, Pear = 1, Orange = 2
```

When an enumeration includes custom values, the encoding uses the enumerator's assigned value, which is not necessarily the same as its ordinal value. Consider this example:

```
Slice
```

```
enum Fruit { Apple = 1, Pear = 3, Orange }; // Encoded values: Apple = 1, Pear = 3, Orange = 4
```

The largest value in this case is 4.

An enumerator is encoded as follows:

- If the largest value is in the range 0..126, the enumerator's value is marshaled as a `byte`.
- If the largest value is in the range 127..32766, the enumerator's value is marshaled as a `short`.
- If the largest value is greater than 32766, the enumerator's value is marshaled as an `int`.



Changing the definition of an enumeration can break compatibility with existing applications. For example, if enumerators are added, removed, or changed such that the largest value crosses one of the thresholds shown above, the encoded form of the enumerators will change and cause marshaling errors unless you rebuild all applications that use this definition.

Enumerator Encoding version 1.1

An enumerator is encoded as a [size](#), meaning the encoding of an enumerator requires one byte if its value is less than 255, or five bytes if its value is 255 or greater. The encoding uses the Slice value of the enumerator, which is not necessarily the same as its ordinal value.

Repeating the previous example:

```
Slice
```

```
enum Fruit { Apple = 1, Pear = 3, Orange }; // Encoded values: Apple = 1, Pear = 3, Orange = 4
```

Although enumerator `Pear` may have ordinal value 1 in some language mappings (notably, Java), the encoding uses its Slice value of 3.

Encoding for Structures

The members of a structure are encoded in the order they appear in the `struct` declaration, as specified for their types.

See Also

- [Protocol Messages](#)
- [Protocol and Encoding Versions](#)
- [Data Encoding for Exceptions](#)

- [Data Encoding for Classes](#)

References

1. Institute of Electrical and Electronics Engineers. 1985. *IEEE 754-1985 Standard for Binary Floating-Point Arithmetic*. Piscataway, NJ: Institute of Electrical and Electronic Engineers.
2. Unicode Consortium, ed. 2000. *The Unicode Standard, Version 3.0*. Reading, MA: Addison-Wesley.

Data Encoding for Exceptions

Exception Encoding version 1.0

An exception is marshaled as shown below:

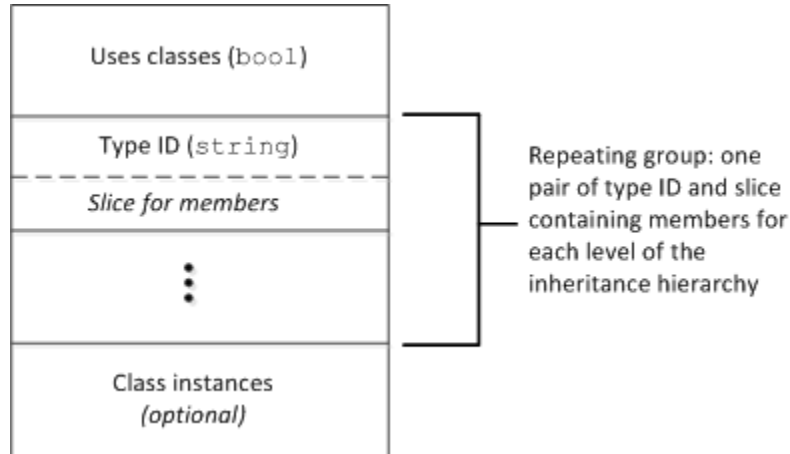

Marshaling format for exceptions.

Every exception instance is preceded by a single byte that indicates whether the exception uses class members: the byte value is 1 if any of the exception members are classes (or if any of the exception members, recursively, contain class members) and 0, otherwise.

Following the header byte, the exception is marshaled as a sequence of pairs: the first member of each pair is the [type ID](#) for an exception slice, and the second member of the pair is a [slice](#) containing the marshaled members of that slice. The sequence of pairs is marshaled in derived-to-base order, with the most-derived slice first, and ending with the least-derived slice. Within each slice, data members are marshaled as for [structures](#): in the order in which they are defined in the Slice definition.

Following the sequence of pairs, any [class instances](#) that are used by the members of the exception are marshaled. This final part is optional: it is present only if the header byte is 1.

To illustrate the marshaling, consider the following exception hierarchy:

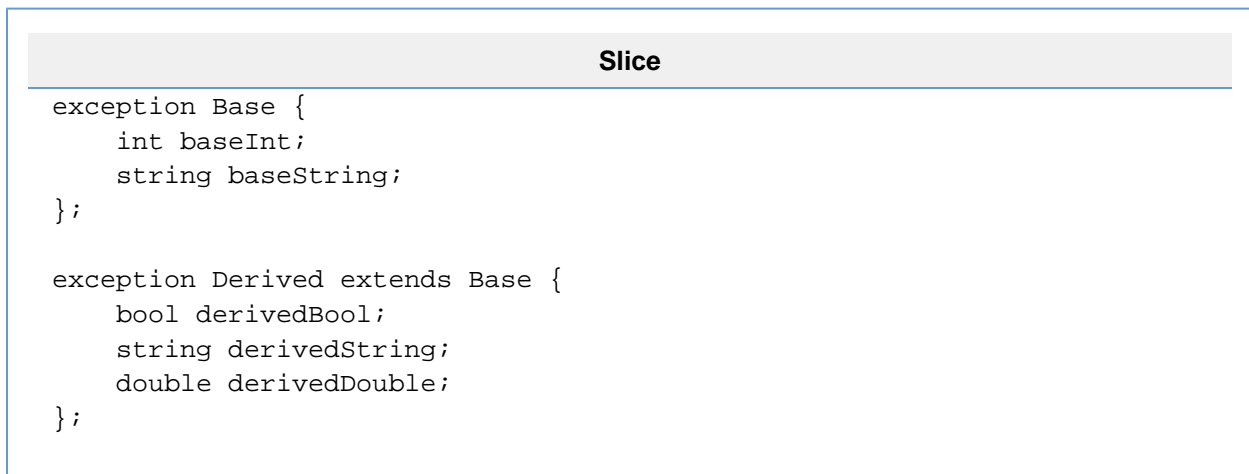

Assume that the exception members are initialized to the values shown below:

Member	Type	Value	Marshaled size (in bytes)
baseInt	int	99	4

baseString	string	"Hello"	6
derivedBool	bool	true	1
derivedString	string	"World!"	7
derivedDouble	double	3.14	8

Member values of an exception of type `Derived`.

From the above table, we can see that the total size of the members of `Base` is 10 bytes, and the total size of the members of `Derived` is 16 bytes. None of the exception members are classes. An instance of this exception has the on-the-wire representation shown in the next table. (The size, type, and byte offset of the marshaled representation is indicated for each component.)

Marshaled value	Size in bytes	Type	Byte offset
0 (<i>no class members</i>)	1	bool	0
"::Derived" (<i>type ID</i>)	10	string	1
20 (<i>byte count for slice</i>)	4	int	11
1 (<i>derivedBool</i>)	1	bool	15
"World!" (<i>derivedString</i>)	7	string	16
3.14 (<i>derivedDouble</i>)	8	double	23
"::Base" (<i>type ID</i>)	7	string	31
14 (<i>byte count for slice</i>)	4	int	38
99 (<i>baseInt</i>)	4	int	42
"Hello" (<i>baseString</i>)	6	string	46

Marshaled representation of the exception.

Note that the size of each string is one larger than the actual string length. This is because each string is preceded by a count of its number of bytes, as directed by the [encoding for strings](#).

The receiver of this sequence of values uses the header byte to decide whether it eventually must unmarshal any class instances contained in the exception (none in this example) and then examines the first type ID (`::Derived`). If the receiver recognizes that type ID, it can unmarshal the contents of the first slice, followed by the remaining slices; otherwise, the receiver reads the byte count that follows the unknown type (20) and then skips 20-4 bytes in the input stream, which is the start of the type ID for the second slice (`::Base`). If the receiver does not recognize that type ID either, it again reads the byte count following the type ID (14), skips 14-4 bytes, and attempts to read another type ID. (This can happen only if client and server have been compiled with mismatched Slice definitions that disagree in the exception specification of an operation.) In this case, the receiver will eventually encounter an unmarshaling error, which it can report with a `MarshalException`.

If an exception contains class members, these members are marshaled following the exception slices as described in the [class encoding](#).

Exception Encoding version 1.1

An exception is marshaled as a collection of [slices](#) whose order matches the inheritance hierarchy, with the most-derived type appearing first. The selected encoding [format](#) affects the content of each slice. The final slice, representing the least-derived type, has its *last slice* bit set to true.

An exception in the compact format is marshaled as follows:

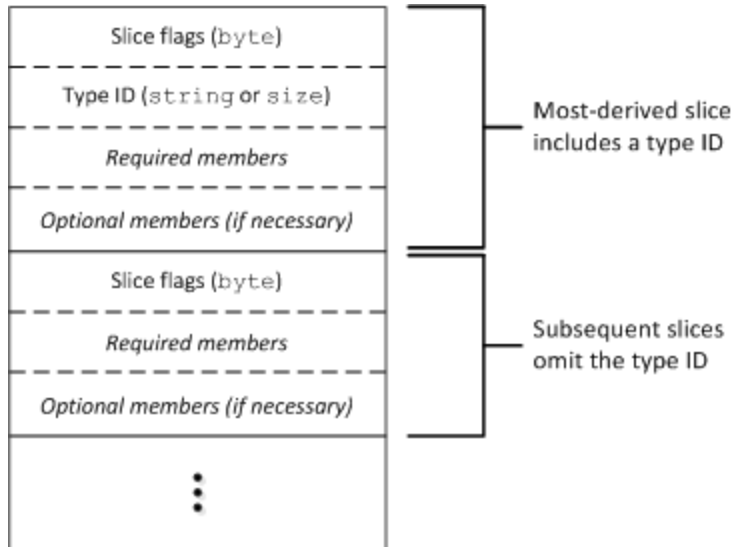

Compact format for exceptions.

The leading byte of each slice is a set of bit flags that specifies the features of the slice. The compact format includes a type ID in the initial (most-derived) slice but omits the type ID from all subsequent slices.

The sliced format includes a type ID in every slice, along with a slice size and an optional [indirection table](#):

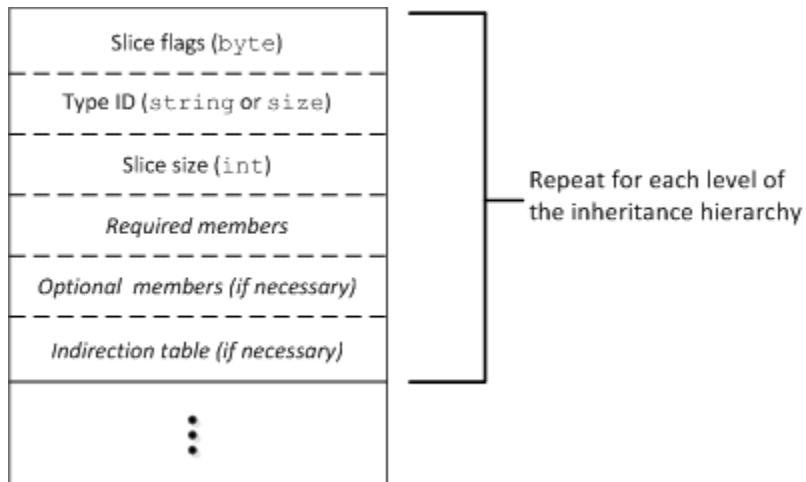

Sliced format for exceptions.

To illustrate the marshaling, consider the following exception hierarchy:

Slice

```

exception Base {
    int baseInt;
    string baseString;
};

exception Derived extends Base {
    bool derivedBool;
    string derivedString;
    double derivedDouble;
};

```

Assume that the exception members are initialized to the values shown below:

Member	Type	Value	Marshaled size (in bytes)
baseInt	int	99	4
baseString	string	"Hello"	6
derivedBool	bool	true	1
derivedString	string	"World!"	7
derivedDouble	double	3.14	8

Member values of an exception of type Derived.

From the above table, we can see that the total size of the members of Base is 10 bytes, and the total size of the members of Derived is 16 bytes. None of the exception members are classes. An instance of this exception using the sliced format has the on-the-wire representation shown in the next table. (The size, type, and byte offset of the marshaled representation is indicated for each component.)

Marshaled value	Size in bytes	Type	Byte offset
18 (<i>flags: type ID is a string, slice size is present</i>)	1	byte	0
"::Derived" (<i>type ID</i>)	10	string	1
20 (<i>byte count for slice</i>)	4	int	11
1 (<i>derivedBool</i>)	1	bool	15
"World!" (<i>derivedString</i>)	7	string	16
3.14 (<i>derivedDouble</i>)	8	double	23
50 (<i>flags: type ID is a string, slice size is present, last slice</i>)	1	byte	31
"::Base" (<i>type ID</i>)	7	string	32
14 (<i>byte count for slice</i>)	4	int	39
99 (<i>baseInt</i>)	4	int	43

"Hello" (<i>baseString</i>)	6	string	47
-------------------------------	---	--------	----

Marshaled representation of the exception using the sliced format.

Note that the size of each string is one larger than the actual string length. This is because each string is preceded by a count of its number of bytes, as directed by the [encoding for strings](#).

Repeating this exercise using the compact format produces the following encoding:

Marshaled value	Size in bytes	Type	Byte offset
2 (<i>flags: type ID is a string</i>)	1	byte	0
"::Derived" (<i>type ID</i>)	10	string	1
1 (<i>derivedBool</i>)	1	bool	11
"World!" (<i>derivedString</i>)	7	string	12
3.14 (<i>derivedDouble</i>)	8	double	19
32 (<i>flags: last slice</i>)	1	byte	27
99 (<i>baseInt</i>)	4	int	28
"Hello" (<i>baseString</i>)	6	string	32

Marshaled representation of the exception using the compact format.

When using the compact format, the receiver *must* know the most-derived type: the only type ID included in the encoding is that of the most-derived type. Furthermore, the lack of slice sizes means the receiver cannot skip a slice without knowing how to decode its contents.

See Also

- [Type IDs](#)
- [Basic Data Encoding](#)
- [Data Encoding for Classes](#)

Data Encoding for Classes

The marshaling for [classes](#) is complex, due to the need to deal with the pointer semantics for graphs of classes, as well as the need for the receiver to slice or preserve classes of unknown derived type. In addition, the marshaling for classes uses a [type ID](#) compression scheme to avoid repeatedly marshaling the same type IDs for large graphs of class instances.

Encoding for Class References

Consider the following Slice definitions:

Slice
<pre>class Node { int value; Node next; }; struct S { Node obj; };</pre>

We call the `obj` member a *reference* to a class instance. References can appear as data members, as in the case of `obj` above, or nested inside of other types, such as a sequence element or dictionary value. There are significant differences in the encoding for references between versions 1.0 and 1.1.

Class Reference Encoding version 1.0

Ice encodes a nil reference as a 32-bit integer with value zero. For non-nil references, the encoder maintains a table per [encapsulation](#) that associates a unique non-zero positive integer with each class instance. We refer to this integer as an *instance ID*. The first time the encoder encounters a reference to a particular instance, it assigns the instance an unused ID, inserts it into the table, and encodes the reference as a 32-bit integer whose value is the *negative* of the ID. If the encoder has already encountered that instance, it simply encodes the instance's previously-assigned ID as a negative 32-bit integer.

All [class instances](#) are encoded at the end of the encapsulation.

Class Reference Encoding version 1.1

As in version 1.0 of the encoding, each instance is assigned a unique ID per encapsulation. However, to conserve space, version 1.1 encodes a reference as a *size* value, with a nil reference encoded as a size value of zero and a non-nil reference encoded as a positive size value. The encoding reserves ID value zero to denote a nil reference, and ID value 1 to denote an *inline* instance in which an instance's state is marshaled at the point of its first reference. Consequently, instance IDs must start at 2. The encoding assigns instance IDs sequentially in order of appearance, with the first instance assigned an ID of 2, the next instance has ID 3, and so on.

The encoding for a reference depends on the [format](#) being used, and may also depend on the context in which the reference occurs:

- **Compact format**

In this format, the encoding always uses the inline scheme. Suppose we are encoding a value of the structure type `S` shown earlier. If its `obj` member refers to a class instance that the encoder has not yet encountered in the current encapsulation, the encoding assigns it the next available sequential ID, marshals a size with value 1 signifying that an instance is about to be written, and then immediately marshals the instance itself. Any subsequent reference to the same instance is encoded as a size whose value is the instance's corresponding ID.

- **Sliced format**

When a reference occurs *outside* the context of a class instance, Ice uses the same inline scheme as in the compact format. For example, suppose a Slice operation declared a parameter of structure type `S` shown above. When marshaling this parameter, its `obj` member is encoded as a size with value 1, followed by the encoding of the `Node` instance itself. Now consider the marshaling of

the `Node` instance, where we encounter a class reference in member `next` that occurs *inside* the context of a class instance. To assist the Ice run time in unmarshaling and remarshaling instances, such a reference is encoded as a size whose value is an index into an [indirection table](#).

Encoding for Class Instances

It is important to understand the distinction between marshaling a reference and marshaling an instance. In C++ terms, this is equivalent to the difference between a pointer and the heap data containing an object's state at which the pointer is pointing. Marshaling an instance means we are encoding the data members of a class instance.

Class Instance Encoding version 1.0

Classes are marshaled as a number of pairs containing a type ID and a [slice](#) (one pair for each level of the inheritance hierarchy) and marshaled in derived-to-base order. Only data members are marshaled — no information is sent that would relate to operations. Each marshaled class instance is preceded by a (non-zero) positive integer that provides an identity for the instance. The sender assigns this identity during marshaling such that each marshaled instance has a different identity. The receiver uses that identity to correctly reconstruct graphs of classes. The overall marshaling format for classes is shown below:

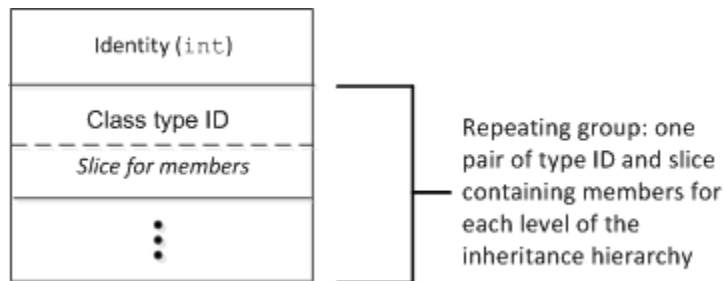

Marshaling format for classes.

Prior to ending an encapsulation, the sender must encode all instances referenced within that encapsulation in an object table. The encoding may require multiple passes: as the sender processes an instance in the current pass, it may encounter additional instances to be processed in a subsequent pass. For each pass, the sender encodes a [size](#) denoting the number of objects in the pass. To signify that all instances have been encoded, the sender must marshal a size value of zero.

This object table must be written if any operation parameter or data member has a class type, even if all references are nil.

Class Instance Encoding version 1.1

The leading byte of a class instance is a [size](#) value of 1. Following this byte is a collection of [slices](#) arranged in derived-to-base order. Only data members are marshaled — no information is sent that would relate to operations. The initial (most-derived) slice always includes a [type ID](#) that may be encoded as a string or as a numeric value, as specified by the flags that begin each slice. Depending on the [format](#) being used, subsequent slices may or may not include a type ID.

Each slice consists of a leading byte representing the slice flags, an optional type ID, an optional slice size, the required members for that slice in order of declaration, and the [optional members](#) of that slice. The sender must set the appropriate slice flags to indicate whether the slice includes a type ID, size, and optional data members, and whether this is the last slice of the instance. The compact format only includes a type ID in the initial (most-derived) slice and omits the slice size, as shown in the following diagram:

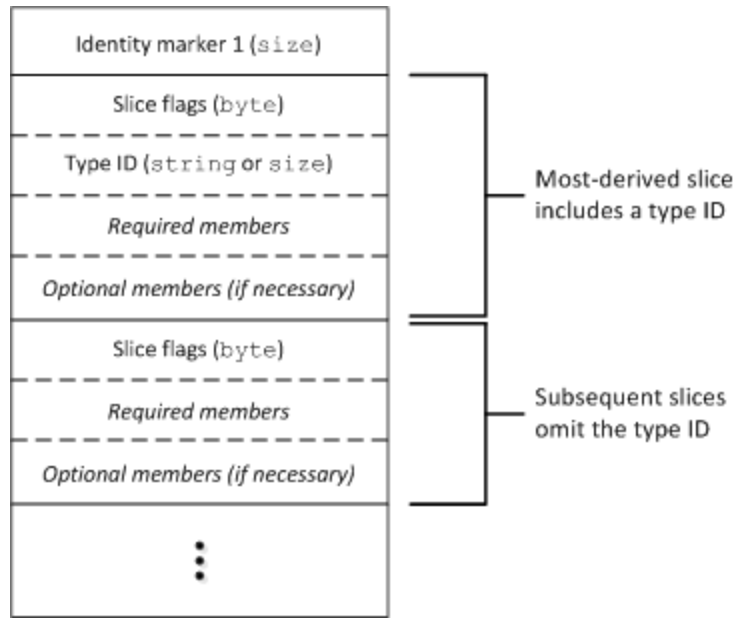

Compact format for classes.

When using the sliced format, a type ID is included in every slice, along with a slice size:

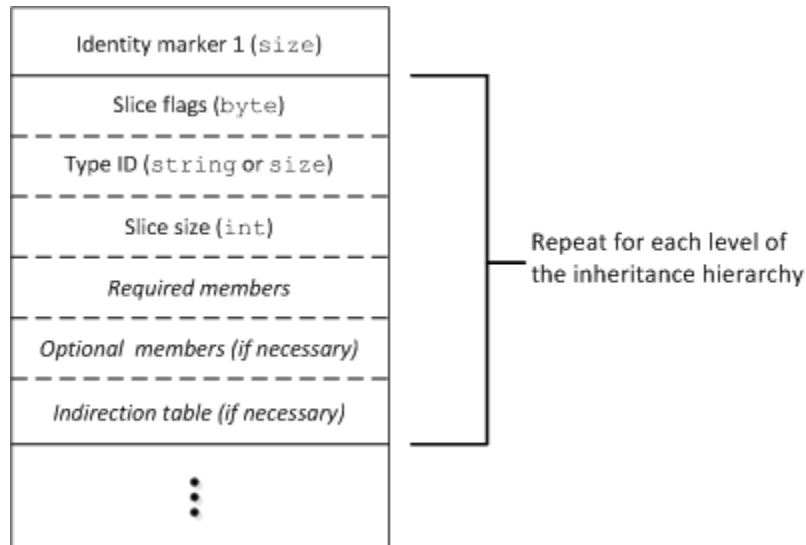

Sliced format for classes.

A slice that contains at least one non-nil class reference must use an [indirection table](#) for all references in that slice. The table is an array of instances encoded using the inline scheme. A leading size value indicates the number of elements in the table; each element is either an instance ID (if the instance has already been encoded within the current encapsulation), or the instance itself denoted by a leading size of 1. The indirection table appears in the encoding immediately following the required and optional data members, *but is not included in the byte count denoted by the slice size*. To skip a slice for an unknown type, the receiver can advance the input stream by the number of bytes specified in the slice size, but then must process all references or instances in the indirection table, if one is present.

To support [slice preservation](#) for an instance, the receiver must temporarily retain the slices of any unknown derived types, and also be able to reconstruct the indirection table in its original order for each of these slices in case the instance is later remarshaled.

See Also

- [Classes](#)

- [Type IDs](#)
- [Data Encoding for Exceptions](#)
- [Basic Data Encoding](#)
- [Understanding Objects and Exceptions](#)

Data Encoding for Class Type IDs

Type ID Encoding version 1.0

Unlike for exception [type IDs](#), class type IDs are not simple strings. Instead, a class type ID is marshaled as a boolean followed by either a string or a [size](#), to conserve bandwidth. To illustrate this, consider the following class hierarchy:

Slice

```

class Base {
    // ...
};

class Derived extends Base {
    // ...
};

```

The type IDs for the class `slices` are `::Derived` and `::Base`. Suppose the sender marshals three instances of `::Derived` as part of a single request. (For example, two instances could be out-parameters and one instance could be the return value.)

The first instance that is sent on the wire contains the type IDs `::Derived` and `::Base` preceding their respective slices. Because marshaling proceeds in derived-to-base order, the first type ID that is sent is `::Derived`. Every time the sender sends a type ID that it has not sent previously in the same request, it sends the boolean value `false`, followed by the type ID. Internally, the sender also assigns a unique positive number to each type ID. These numbers start at 1 and increment by one for each type ID that has not been marshaled previously. This means that the first type ID is encoded as the boolean value `false`, followed by `::Derived`, and the second type ID is encoded as the boolean value `false`, followed by `::Base`.

When the sender marshals the remaining two instances, it consults a lookup table of previously-marshaled type IDs. Because both type IDs were sent previously in the same request (or reply), the sender encodes all further occurrences of `::Derived` as the value `true` followed by the number 1 encoded as a size, and it encodes all further occurrences of `::Base` as the value `true` followed by the number 2 encoded as a size.

When the receiver reads a type ID, it first reads its boolean marker:

- If the boolean is `false`, the receiver reads a string and enters that string into a lookup table that maps integers to strings. The first new class type ID received in a request is numbered 1, the second new class type ID is numbered 2, and so on.
- If the boolean value is `true`, the receiver reads a number encoded as a size and uses it to retrieve the corresponding class type ID from the lookup table.

Note that this numbering scheme is re-established for each new [encapsulation](#). (As we will see in our discussion of [protocol messages](#), parameters, return values, and exceptions are always marshaled inside an enclosing encapsulation.) For subsequent or nested encapsulation, the numbering scheme restarts, with the first new type ID being assigned the value 1. In other words, each encapsulation uses its own independent numbering scheme for class type IDs to satisfy the constraint that encapsulations must not depend on their surrounding context.

Encoding class type IDs in this way provides significant savings in bandwidth: whenever an ID is marshaled a second and subsequent time, it is marshaled as a two-byte value (assuming no more than 254 distinct type IDs per request) instead of as a string. Because type IDs can be long, especially if you are using nested modules, the savings are considerable.

Type ID Encoding version 1.1

Each [slice](#) of a class instance has a leading byte containing flags that describe various aspects of the slice, including whether the slice includes a type ID and how that type ID is encoded. There are four possibilities:

1. No type ID included
2. Type ID is encoded as a string
3. Type ID is encoded as an index

4. Type ID is encoded as a compact ID

The initial slice of an instance, representing the most-derived type, always contains some form of type ID so that the receiver knows what Slice type is present. Depending on the [format](#) used by the sender, subsequent slices may or may not include a type ID: the compact format omits type IDs in subsequent slices, whereas the sliced format includes a type ID in every slice. A receiver need only examine the slice flags to discover how to decode the type ID.

String Type IDs

The encoding for string type IDs uses a "compression" scheme similar to that of version 1.0: within an [encapsulation](#), a given type ID is never encoded as a string more than once. The first time a sender encounters a type ID, the sender assigns an integer index to the ID and encodes the ID as a string. For all subsequent occurrences of the same type ID within the encapsulation, the sender encodes the index associated with that type ID as a [size](#). Index values start at 1 and increase sequentially with each new type ID. The sender is responsible for setting the relevant bits in the [flags](#) of each slice to specify how the type ID is encoded.

The slice flags in version 1.1 of the encoding serve the same purpose as the boolean value that precedes each type ID in version 1.0, without consuming an entire byte.

Compact Type IDs

As a way of further reducing the overhead associated with class instances, version 1.1 adds the ability to substitute numeric values for strings when encoding type IDs. Consider the following Slice definitions:

Slice
<pre>class Base(3) { // ... }; class Derived(4) extends Base { // ... }; class MoreDerived extends Derived { // ... };</pre>

The value in parentheses after the class name represents the *compact* type ID for the class. The sender's [format](#) determines whether each slice includes a type ID. If a given slice includes a type ID, the encoding always uses a compact type ID (if defined) in preference to its string equivalent. Suppose a sender is encoding an instance of `MoreDerived` in the sliced format. The initial slice uses the string type ID for `MoreDerived`, the next slice uses the compact type ID for `Derived`, and the last slice uses the compact type ID for `Base`.

A compact type ID is encoded as a [size](#), with the relevant bits set in the [slice flags](#).



The developer is responsible for ensuring compact type IDs are sufficiently unique. Using values less than 255 produces the most efficient encoding.

See Also

- [Type IDs](#)
- [Basic Data Encoding](#)
- [Protocol Messages](#)

Simple Example of Class Encoding

On this page:

- [Sample Class Definitions](#)
- [Class Encoding version 1.0](#)
- [Class Encoding version 1.1](#)
 - [Class Encoding in the Sliced Format](#)
 - [Class Encoding in the Compact Format](#)
 - [Class Encoding in the Compact Format with Compact Type IDs](#)

Sample Class Definitions

We have separately discussed the primary components of the class encoding: [slices](#), [references](#), and [type IDs](#). To make the preceding discussions more concrete, consider the following class definitions:

Slice
<pre> interface SomeInterface { void op1(); }; class Base { int baseInt; void op2(); string baseString; }; class Derived extends Base implements SomeInterface { bool derivedBool; string derivedString; void op3(); double derivedDouble; }; </pre>

Note that `Base` and `Derived` have operations, and that `Derived` also implements the interface `SomeInterface`. Because marshaling of classes is concerned with state, not behavior, the operations `op1`, `op2`, and `op3` are simply ignored during marshaling and the on-the-wire representation is as if the classes had been defined as follows:

Slice
<pre> class Base { int baseInt; string baseString; }; class Derived extends Base { bool derivedBool; string derivedString; double derivedDouble; }; </pre>

Suppose the sender marshals two instances of `Derived` (for example, as two in-parameters in the same request) with these member values:

First instance:

Member	Type	Value	Marshaled size (in bytes)
<code>baseInt</code>	<code>int</code>	99	4
<code>baseString</code>	<code>string</code>	"Hello"	6
<code>derivedBool</code>	<code>bool</code>	true	1
<code>derivedString</code>	<code>string</code>	"World!"	7
<code>derivedDouble</code>	<code>double</code>	3.14	8

Second instance:

Member	Type	Value	Marshaled size (in bytes)
<code>baseInt</code>	<code>int</code>	115	4
<code>baseString</code>	<code>string</code>	"Cave"	5
<code>derivedBool</code>	<code>bool</code>	false	1
<code>derivedString</code>	<code>string</code>	"Canem"	6
<code>derivedDouble</code>	<code>double</code>	6.32	8

We describe how to marshal these instances using versions 1.0 and 1.1 of the encoding in separate sections below.

Class Encoding version 1.0

The sender arbitrarily assigns a non-zero `identity` to each instance. Typically, the sender will simply consecutively number the instances starting at 1. For this example, assume that the two instances have the identities 1 and 2. The marshaled representation for the two instances (assuming that they are marshaled immediately following each other) is shown below:

Marshaled value	Size in bytes	Type	Byte offset
1 (<i>identity</i>)	4	<code>int</code>	0
0 (<i>marker for class type ID</i>)	1	<code>bool</code>	4
"::Derived" (<i>class type ID</i>)	10	<code>string</code>	5
20 (<i>byte count for slice</i>)	4	<code>int</code>	15
1 (<i>derivedBool</i>)	1	<code>bool</code>	19
"World!" (<i>derivedString</i>)	7	<code>string</code>	20
3.14 (<i>derivedDouble</i>)	8	<code>double</code>	27
0 (<i>marker for class type ID</i>)	1	<code>bool</code>	35
"::Base" (<i>type ID</i>)	7	<code>string</code>	36
14 (<i>byte count for slice</i>)	4	<code>int</code>	43
99 (<i>baseInt</i>)	4	<code>int</code>	47

"Hello" (<i>baseString</i>)	6	string	51
0 (<i>marker for class type ID</i>)	1	bool	57
"::Ice::Object" (<i>class type ID</i>)	14	string	58
5 (<i>byte count for slice</i>)	4	int	72
0 (<i>number of dictionary entries</i>)	1	size	76
2 (<i>identity</i>)	4	int	77
1 (<i>marker for class type ID</i>)	1	bool	81
1 (<i>class type ID</i>)	1	size	82
19 (<i>byte count for slice</i>)	4	int	83
0 (<i>derivedBool</i>)	1	bool	87
"Canem" (<i>derivedString</i>)	6	string	88
6.32 (<i>derivedDouble</i>)	8	double	94
1 (<i>marker for class type ID</i>)	1	bool	102
2 (<i>class type ID</i>)	1	size	103
13 (<i>byte count for slice</i>)	4	int	104
115 (<i>baseInt</i>)	4	int	108
"Cave" (<i>baseString</i>)	5	string	112
1 (<i>marker for class type ID</i>)	1	bool	117
3 (<i>class type ID</i>)	1	size	118
5 (<i>byte count for slice</i>)	4	int	119
0 (<i>number of dictionary entries</i>)	1	size	123

Note that, because classes (like [exceptions](#)) are sent as a sequence of [slices](#), the receiver of a class can slice off any derived parts of a class it does not understand. Also note that (as shown in the above table) each class instance contains three slices. The third slice is for the type `::Ice::Object`, which is the base type of all classes. The class [type ID](#) `::Ice::Object` has the number 3 in this example because it is the third distinct type ID that is marshaled by the sender. (See entries at byte offsets 58 and 118 in the above table.) All class instances have this final slice of type `::Ice::Object`.

Marshaling a separate slice for `::Ice::Object` dates back to Ice versions 1.3 and earlier. In those versions, classes carried a facet map that was marshaled as if it were defined as follows:

Slice

```

module Ice {
  class Object;

  dictionary<string, Object> FacetMap;

  class Object {
    FacetMap facets; // No longer exists
  };
};

```

As of Ice version 1.4, this facet map is always empty, that is, the count of entries for the dictionary that is marshaled in the `::Ice::Object` slice is always zero. If a receiver receives a class instance with a non-empty facet map, it must throw a `MarshalException`.

Note that if a class has no data members, a type ID and slice for that class is still marshaled. The byte count of the slice will be 4 in this case, indicating that the slice contains no data.

Class Encoding version 1.1

A leading `size` value of 1 marks the beginning of an instance, followed by one or more `slices`.

Class Encoding in the Sliced Format

The marshaled representation for the two instances (assuming that they are marshaled immediately following each other) in the `sliced format` is shown below:

Marshaled value	Size in bytes	Type	Byte offset
1 (<i>instance marker</i>)	1	size	0
17 (<i>slice flags: string type ID, size is present</i>)	1	byte	1
"::Derived" (<i>type ID - assigned index 1</i>)	10	string	2
20 (<i>byte count for slice</i>)	4	int	12
1 (<i>derivedBool</i>)	1	bool	16
"World!" (<i>derivedString</i>)	7	string	17
3.14 (<i>derivedDouble</i>)	8	double	24
49 (<i>slice flags: string type ID, size is present, last slice</i>)	1	byte	32
"::Base" (<i>type ID - assigned index 2</i>)	7	string	33
14 (<i>byte count for slice</i>)	4	int	40
99 (<i>baseInt</i>)	4	int	44
"Hello" (<i>baseString</i>)	6	string	48

1 (<i>instance marker</i>)	1	size	54
18 (<i>slice flags: index type ID, size is present</i>)	1	byte	55
1 (<i>type ID index for Derived</i>)	1	size	56
19 (<i>byte count for slice</i>)	4	int	57
0 (<i>derivedBool</i>)	1	bool	61
"Canem" (<i>derivedString</i>)	6	string	62
6.32 (<i>derivedDouble</i>)	8	double	68
50 (<i>slice flags: index type ID, size is present, last slice</i>)	1	byte	76
2 (<i>type ID index for Base</i>)	1	size	77
13 (<i>byte count for slice</i>)	4	int	78
115 (<i>baseInt</i>)	4	int	82
"Cave" (<i>baseString</i>)	5	string	86

The sliced format allows the receiver of a class to slice off any derived parts of a class it does not understand, as in version 1.0 of the encoding. Although the sliced format provides equivalent functionality to that of version 1.0, it is significantly more efficient, requiring only 91 bytes to encode our example compared to the 124 bytes required by version 1.0. We could reduce the encoded size even further, while still retaining the ability to slice off unknown types, by using [compact type IDs](#).

Note that if a class has no data members, a type ID and slice for that class is still marshaled. The byte count of the slice will be 4 in this case, indicating that the slice contains no data.

Class Encoding in the Compact Format

The marshaled representation for the two instances (assuming that they are marshaled immediately following each other) in the [compact format](#) is shown below:

Marshaled value	Size in bytes	Type	Byte offset
1 (<i>instance marker</i>)	1	size	0
1 (<i>slice flags: string type ID</i>)	1	byte	1
"::Derived" (<i>type ID - assigned index 1</i>)	10	string	2
1 (<i>derivedBool</i>)	1	bool	12
"World!" (<i>derivedString</i>)	7	string	13
3.14 (<i>derivedDouble</i>)	8	double	20
32 (<i>slice flags: last slice</i>)	1	byte	28
99 (<i>baseInt</i>)	4	int	29
"Hello" (<i>baseString</i>)	6	string	33
1 (<i>instance marker</i>)	1	size	39

2 (<i>slice flags: index type ID</i>)	1	byte	40
1 (<i>type ID index for Derived</i>)	1	size	41
0 (<i>derivedBool</i>)	1	bool	42
"Canem" (<i>derivedString</i>)	6	string	43
6.32 (<i>derivedDouble</i>)	8	double	49
32 (<i>slice flags: last slice</i>)	1	byte	57
115 (<i>baseInt</i>)	4	int	58
"Cave" (<i>baseString</i>)	5	string	62

In an effort to conserve bandwidth, the compact format omits certain details that would allow a receiver to slice off derived parts of a class, such as the slice size and the type IDs for base classes. The result is an encoding that requires only 67 bytes for the two sample instances.

Note that if a class has no data members, a type ID and slice for that class is still marshaled. The byte count of the slice will be 4 in this case, indicating that the slice contains no data.

Class Encoding in the Compact Format with Compact Type IDs

[Compact type IDs](#) can be used regardless of the sender's chosen [format](#). For the sake of example, we will use compact type IDs together with the compact format to produce the smallest encoding possible. The Slice definitions below reflect the addition of the compact type IDs:

Slice

```

interface SomeInterface {
    void op1();
};

class Base(10) {
    int baseInt;
    void op2();
    string baseString;
};

class Derived(11) extends Base implements SomeInterface {
    bool derivedBool;
    string derivedString;
    void op3();
    double derivedDouble;
};

```

We assign the compact type ID 10 to `Base` and 11 to `Derived`. Note however that assigning a compact type ID to `Base` does not affect the size of the encoded data in our example because the compact format omits type IDs altogether for base types.

The marshaled representation for the two instances (assuming that they are marshaled immediately following each other) in the compact format is shown below:

Marshaled value	Size in bytes	Type	Byte offset
1 (<i>instance marker</i>)	1	size	0

3 (<i>slice flags: compact type ID</i>)	1	byte	1
11 (<i>compact type ID for Derived</i>)	1	size	2
1 (<i>derivedBool</i>)	1	bool	3
"World!" (<i>derivedString</i>)	7	string	4
3.14 (<i>derivedDouble</i>)	8	double	11
32 (<i>slice flags: last slice</i>)	1	byte	19
99 (<i>baseInt</i>)	4	int	20
"Hello" (<i>baseString</i>)	6	string	24
1 (<i>instance marker</i>)	1	size	30
3 (<i>slice flags: compact type ID</i>)	1	byte	31
11 (<i>compact type ID for Derived</i>)	1	size	32
0 (<i>derivedBool</i>)	1	bool	33
"Canem" (<i>derivedString</i>)	6	string	34
6.32 (<i>derivedDouble</i>)	8	double	40
32 (<i>slice flags: last slice</i>)	1	byte	48
115 (<i>baseInt</i>)	4	int	49
"Cave" (<i>baseString</i>)	5	string	53

Substituting a compact type ID for its string equivalent reduces the encoded size for the two instances by another nine bytes to 58, less than half the size of version 1.0.

See Also

- [Data Encoding for Classes](#)
- [Data Encoding for Exceptions](#)
- [Basic Data Encoding](#)
- [Type IDs](#)

Data Encoding for Class Graphs

Classes support pointer semantics, that is, you can construct graphs of classes. It follows that classes can arbitrarily point at each other, and therefore the encoding must provide a scheme for serializing and deserializing a class graph. Note that the marshaling format for `class references` and `instances` differs significantly between versions 1.0 and 1.1 of the encoding.

On this page:

- [Encoding a Class Graph version 1.0](#)
- [Encoding a Class Graph version 1.1](#)
 - [Class Graph in the Compact Format](#)
 - [Class Graph in the Sliced Format](#)
 - [Importance of the Indirection Table](#)
- [Impact of Slicing on Class Graph Decoding](#)

Encoding a Class Graph version 1.0

In version 1.0 of the encoding, an `instance ID` is used to distinguish instances and pointers as follows:

- An instance ID of 0 denotes a null pointer.
- An instance ID > 0 precedes the marshaled contents of an instance.
- An instance ID < 0 denotes a pointer to an instance.

Instance ID values less than zero are pointers. For example, if the receiver receives the instance ID -57 , this means that the corresponding class member that is currently being unmarshaled will eventually point at the instance with ID 57 .

For structures, classes, exceptions, sequences, and dictionary members that do not contain class members, the Ice encoding uses a simple depth-first traversal algorithm to marshal the members. For example, structure members are marshaled in the order of their Slice definition; if a structure member itself is of complex type, such as a sequence, the sequence is marshaled in toto where it appears inside its enclosing structure. For complex types that contain class members, this depth-first marshaling is suspended: instead of marshaling the actual class instance at this point, a negative instance ID is marshaled that indicates which class instance that member must eventually denote. For example, consider the following definitions:

Slice
<pre>class C { // ... }; struct S { int i; C firstC; C secondC; C thirdC; int j; };</pre>

Suppose we initialize a structure of type `S` as follows:

C++

```

S myS;
myS.i = 99;
myS.firstC = new C;           // New instance
myS.secondC = 0;             // null
myS.thirdC = myS.firstC;     // Same instance as previously
myS.j = 100;

```

When this structure is marshaled, the contents of the three class members are not marshaled in-line. Instead, the sender marshals the negative instance IDs of the corresponding instances. Assuming that the sender has assigned the instance ID 78 to the instance assigned to `myS.firstC`, `myS` is marshaled as shown in the table.

Marshaled Value	Size in Bytes	Type	Byte offset
99 (<i>myS.i</i>)	4	int	0
-78 (<i>myS.firstC</i>)	4	int	4
0 (<i>myS.secondC</i>)	4	int	8
-78 (<i>myS.thirdC</i>)	4	int	12
100 (<i>myS.j</i>)	4	int	16

Note that `myS.firstC` and `myS.thirdC` both use the instance ID -78. This allows the receiver to recognize that `firstC` and `thirdC` point at the same class instance (rather than at two different instances that happen to have the same contents).

Marshaling the negative instance IDs instead of the contents of an instance allows the receiver to accurately reconstruct the class graph that was sent by the sender. However, this begs the question of *when* the actual instances are to be marshaled as described at the beginning of this section. In Ice [protocol messages](#), parameters and return values are marshaled as if they were members of a structure. For example, if an operation invocation has five input parameters, the client marshals the five parameters end-to-end as if they were members of a single structure. If any of the five parameters are class instances, or are of complex type (recursively) containing class instances, the sender marshals the parameters in multiple passes: the first pass marshals the parameters end-to-end, using the usual depth-first algorithm:

- If the sender encounters a class member during marshaling, it checks whether it has marshaled the same instance previously for the current request or reply:
 - If the instance has not been marshaled before, the sender assigns a new instance ID to the instance and marshals the negative ID.
 - Otherwise, if the instance was marshaled previously, the sender sends the same negative ID that it previously sent for that instance.

In effect, during marshaling, the sender builds a table that is indexed by the address of each instance; the lookup value for the instance is its ID.

Once the first pass ends, the sender has marshaled all the parameters, but has not yet marshaled any of the class instances that may be pointed at by various parameters or members. The instance table at this point contains all those instances for which negative IDs (pointers) were marshaled, so whatever is in the table at this point are the classes that the receiver still needs. The sender now marshals those instances in the table, but with positive IDs and followed by their contents, as described in [our earlier example](#). The outstanding instances are marshaled as a sequence, that is, the sender marshals the number of instances as a [size](#), followed by the actual instances.

In turn, the instances just sent may themselves contain class members; when those class members are marshaled, the sender assigns IDs to new instances or uses a negative ID for previously marshaled instances as usual. This means that, by the end of the second pass, the table may have grown, necessitating a third pass. That third pass again marshals the outstanding class instances as a size followed by the actual instances. The third pass contains all those instances that were not marshaled in the second pass. Of course, the third pass may trigger yet more passes until, finally, the sender has sent all outstanding instances, that is, marshaling is complete. At this point, the sender terminates the sequence of passes by marshaling an empty sequence (the value 0 encoded as a size).

To illustrate this with an example, consider the definitions shown in [Classes with Operations](#) once more:

```

Slice

enum UnaryOp { UnaryPlus, UnaryMinus, Not };
enum BinaryOp { Plus, Minus, Multiply, Divide, And, Or };

class Node {
    idempotent long eval();
};

class UnaryOperator extends Node {
    UnaryOp operator;
    Node operand;
};

class BinaryOperator extends Node {
    BinaryOp op;
    Node operand1;
    Node operand2;
};

class Operand {
    long val;
};

```

These definitions allow us to construct expression trees. Suppose the client initializes a tree to the shape shown in the illustration below, representing the expression $(1 + 6 / 2) * (9 - 3)$. The values outside the nodes are the identities assigned by the client.

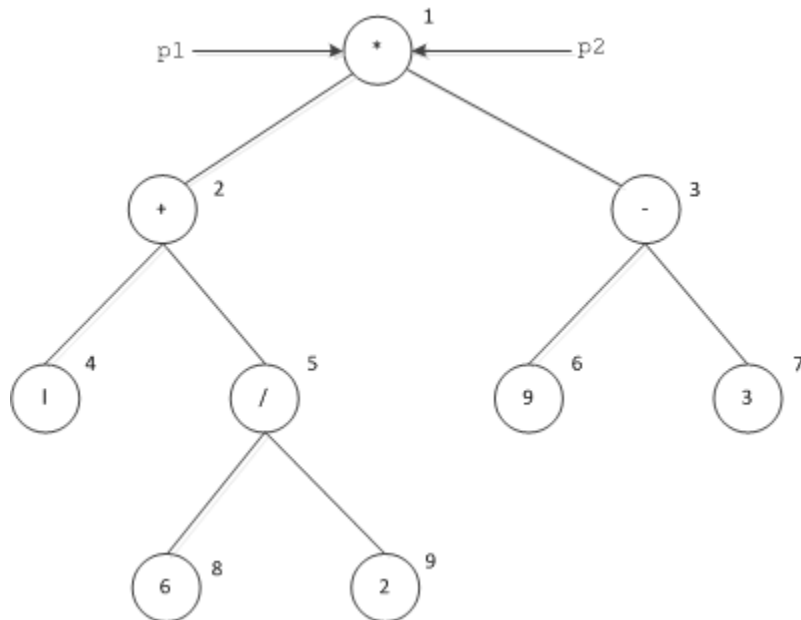

Expression tree for the expression $(1 + 6 / 2) * (9 - 3)$. Both $p1$ and $p2$ denote the root node.

The client passes the root of the tree to the following operation in the parameters $p1$ and $p2$, as shown in the illustration above. (Even

though it does not make sense to pass the same parameter value twice, we do it here for illustration purposes):

```

Slice
interface Tree {
    void sendTree(Node p1, Node p2);
};

```

The client now marshals the two parameters `p1` and `p2` to the server, resulting in the value `-1` being sent twice in succession. (The client arbitrarily assigns an instance ID to each node. The value of the ID does not matter, as long as each node has a unique ID. For simplicity, the Ice implementation numbers instances with a counter that starts counting at 1 and increments by one for each unique instance.) This completes the marshaling of the parameters and results in a single instance with ID 1 in the instance table. The client now marshals a sequence containing a single element, node 1, as described in [the example](#). In turn, node 1 results in nodes 2 and 3 being added to the table, so the next sequence of nodes contains two elements, nodes 2 and 3. The next sequence of nodes contains nodes 4, 5, 6, and 7, followed by another sequence containing nodes 8 and 9. At this point, no more class instances are outstanding, and the client marshals an empty sequence to indicate to the receiver that the final sequence has been marshaled.

Within each sequence, the order in which class instances are marshaled is irrelevant. For example, the third sequence could equally contain nodes 7, 6, 4, and 5, in that order. What is important here is that each sequence contains nodes that are an equal number of "hops" away from the initial node: the first sequence contains the initial node(s), the second sequence contains all nodes that can be reached by traversing a single link from the initial node(s), the third sequence contains all nodes that can be reached by traversing two links from the initial node(s), and so on.

Now consider the same example once more, but with different parameter values for `sendTree`: `p1` denotes the root of the tree, and `p2` denotes the `-` operator of the right-hand sub-tree, as shown below:

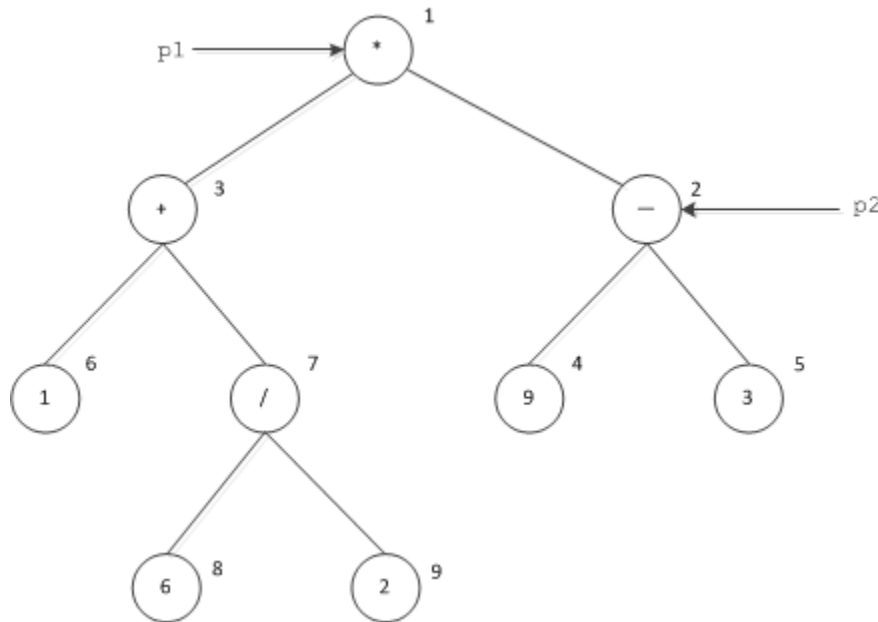

The expression tree of with `p1` and `p2` denoting different nodes.

The graph that is marshaled is exactly the same, but instances are marshaled in a different order and with different IDs:

- During the first pass, the client sends the IDs `-1` and `-2` for the parameter values.
- The second pass marshals a sequence containing nodes 1 and 2.
- The third pass marshals a sequence containing nodes 3, 4, and 5.
- The fourth pass marshals a sequence containing nodes 6 and 7.
- The fifth pass marshals a sequence containing nodes 8 and 9.
- The final pass marshals an empty sequence.

In this way, any graph of nodes can be transmitted (including graphs that contain cycles). The receiver reconstructs the graph by filling in a patch table during unmarshaling:

- Whenever the receiver unmarshals a negative ID, it adds that ID to a patch table; the lookup value is the memory address of the parameter or member that eventually will point at the corresponding instance.
- Whenever the receiver unmarshals an actual instance, it adds the instance to an unmarshaled table; the lookup value is the memory address of the instantiated class. The receiver then uses the address of the instance to patch any parameters or members with the actual memory address.

Note that the receiver may receive negative IDs that denote class instances that have been unmarshaled already (that is, point "backward" in the unmarshaling stream), as well as instances that are yet to be unmarshaled (that is, point "forward" in the unmarshaling stream). Both scenarios are possible, depending on the order in which instances are marshaled, as well as their in-degree.

To provide another example, consider the following definition:

Slice

```

class C {
    // ...
};

sequence<C> CSeq;

```

Suppose the client marshals a sequence of 100 `C` instances to the server, with each instance being distinct. (That is, the sequence contains 100 pointers to 100 different instances, not 100 pointers to the same single instance.) In that case, the sequence is marshaled as a size of 100, followed by 100 negative IDs, `-1` to `-100`. Following that, the client marshals a single sequence containing the 100 instances, each instance with its positive ID in the range 1 to 100, and completes by marshaling an empty sequence.

On the other hand, if the client sends a sequence of 100 elements that all point to the same single class instance, the client marshals the sequence as a size of 100, followed by 100 negative IDs, all with the value `-1`. The client then marshals a sequence containing a single element, namely instance 1, and completes by marshaling an empty sequence.

Encoding a Class Graph version 1.1

The most significant difference in the class encoding between version 1.0 and 1.1 is the location of class instances in the output stream. In version 1.0, instances are always marshaled at the end of the encapsulation, whereas in version 1.1 it is possible for instances to be marshaled *inline* at the point of first reference. Our previous discussion of [class references](#) describes the factors that determine whether a given class reference is marshaled as a reference or as an inline instance. The encoding rules can be summarized as follows:

- When using the compact [format](#), always marshal an instance inline at the point of its first reference, and marshal all subsequent occurrences of the same instance as a reference.
- When using the sliced format, the encoding depends on the context in which a reference occurs: if the reference occurs while encoding a slice of an object or exception, encode it as an index into an indirection table that appears at the end of the slice, otherwise encode it as an inline instance or reference.

We can use the Slice definitions below to explore these situations:

Slice

```
class Node {
    int value;
    Node next;
};

struct S {
    Node obj;
};
```

Suppose we create an instance of structure `S` and assign it to the variable `s`, then construct the following class graph:

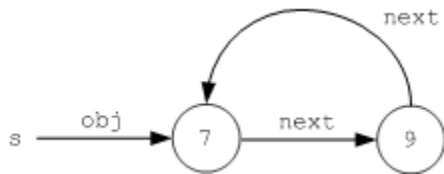

Class graph with circular reference.

We discuss the encoding for these values in separate sections below.

Class Graph in the Compact Format

As we marshal the structure's `obj` member, the compact format produces the following encoding:

Marshaled value	Size in bytes	Type	Byte offset
1 (<i>obj</i> - inline instance marker - assigned ID 2)	1	size	0
33 (<i>slice flags: string type ID, last slice</i>)	1	byte	1
"::Node" (<i>type ID - assigned index 1</i>)	7	string	2
7 (<i>value</i>)	4	int	9
1 (<i>next</i> - inline instance marker - assigned ID 3)	1	size	13
34 (<i>slice flags: type ID index, last slice</i>)	1	byte	14
1 (<i>type ID index</i>)	1	size	15
9 (<i>value</i>)	4	int	16
2 (<i>next</i> - reference to ID 2)	1	size	20

This example shows that inline instances are marshaled immediately upon discovery. As we encode the `obj` member, we encounter a new `Node` instance, assign it the ID 2, and begin to encode it inline using the reserved instance marker value 1. Next, we encode the instance's `v`

`value` member and then examine its `next` member. Since we have not encountered this instance yet, we assign it the ID 3 and begin to encode this new instance inline. Its `next` member is a circular reference to the object with ID 2, so we simply encode a reference to this instance to complete the structure.

Class Graph in the Sliced Format

The need to support both slicing and slice preservation makes the sliced format more complex than the compact format. The encoding for our example values shows how class instances are handled differently depending on their context:

Marshaled value	Size in bytes	Type	Byte offset
1 (<i>obj</i> - inline instance marker - assigned ID 2)	1	size	0
57 (<i>slice flags: string type ID, size is present, indirection table is present, last slice</i>)	1	byte	1
"::Node" (<i>type ID - assigned index 1</i>)	7	string	2
9 (<i>byte count for slice</i>)	4	int	9
7 (<i>value</i>)	4	int	13
1 (<i>next - indirection table index</i>)	1	size	17
1 (<i>size of indirection table</i>)	1	size	18
1 (<i>indirection table entry - inline instance marker - assigned ID 3</i>)	1	size	19
58 (<i>slice flags: type ID index, size is present, indirection table is present, last slice</i>)	1	byte	20
1 (<i>type ID index</i>)	1	size	21
9 (<i>byte count for slice</i>)	4	int	22
9 (<i>value</i>)	4	int	26
1 (<i>next - indirection table index - ID 2</i>)	1	size	30
1 (<i>size of indirection table</i>)	1	size	31
2 (<i>indirection table entry - reference to ID 2</i>)	1	size	32

For this example, let us assume that the structure value is an operation parameter, and therefore the structure member `obj` occurs *outside* the context of a class or exception slice. As a result, we encode the instance with ID 2 as an inline instance. However, when we process the instance's `next` member, we are now *inside* the context of a class slice, so we must use an indirection table. The sender adds an entry to

the indirection table for each unique class reference in the slice; instead of encoding a reference or inline instance, the sender encodes the index of the corresponding entry in the table. As shown above, the value encoded for the `next` member is 1, representing the first entry in the table (0 is still reserved for nil references).

The indirection table follows immediately after the last data member in the slice, but the table is *not* included in the byte count for the slice. A leading size denotes the number of entries in the table. The one and only entry in this table, the instance with ID 3, has not yet been encoded, therefore it is marshaled immediately as an inline instance. This instance also uses an indirection table, although in this case the table entry is simply a reference to instance ID 2, which has already been encoded.

Importance of the Indirection Table

The indirection table is necessary for implementing the [slice preservation](#) feature. Normally, when a receiver does not recognize the type ID in a slice, it has the option of ignoring that slice by skipping ahead in the stream by the number of bytes in the slice. However, when slice preservation is enabled, the receiver must keep a copy of the slice data in case the instance is later remmarshaled. The need for the indirection table becomes apparent when you consider that an opaque blob of slice data may contain class references, and those class references can change during remmarshaling. For example, without an indirection table, the sender might encode the instance ID 3 as the value of member `next`, but what happens if the receiver assigns that instance a different ID, such as 12, when it remmarshals the preserved slice? The receiver preserved the slice because it did not understand the type ID, which means it does not know the contents of the slice data and therefore it cannot "patch" any class references the slice might contain. The indirection table serves as an external "patch table" to solve this problem, essentially making the opaque slice data *relocatable* with respect to class references.

The byte count for a slice does not include the indirection table because the receiver must process the table regardless of whether it recognizes that slice's type ID. Consequently, to "skip" a slice, the receiver can skip (or preserve) the number of bytes specified by the slice's byte count, but still must decode the indirection table if the slice flags indicate that a table is present. If the receiver preserves the slice, it must also associate an indirection table with that slice; during remmarshaling, the sender copies the opaque slice data into the stream, and then reconstructs the indirection table using (potentially) new instance IDs for the instances referenced in the table.

It is possible that the *only* reference to an instance is in an indirection table. To properly implement slice preservation, a receiver must therefore retain *every* instance that is referenced by a preserved indirection table. This is true even if the receiver does not recognize any of the type IDs in an instance; in effect, the receiver must construct a temporary "unknown object" placeholder for the instance, whose only purpose is to encapsulate the data comprising its slices in case the instance is later remmarshaled.

Impact of Slicing on Class Graph Decoding

It is important to note that when a graph of class instances is sent, it always forms a connected graph. However, when the receiver rebuilds the graph, it may end up with a disconnected graph, due to slicing. Consider:

Slice
<pre> class Base { // ... }; class Derived extends Base { // ... Base b; }; interface Example { void op(Base p); }; </pre>

Suppose the client has complete type knowledge, that is, understands both types `Base` and `Derived`, but the server only understands type `Base`, so the derived part of a `Derived` instance is sliced. The client can instantiate classes to be sent as parameter `p` as follows:

C++

```
DerivedPtr p = new Derived;
p->b = new Derived;
ExamplePrx e = ...;
e->op(p);
```

As far as the client is concerned, the graph looks like the one shown below:



Sender-side view of a graph containing derived instances.

However, the server does not understand the derived part of the instances and slices them. Yet, the server unmarshals all the class instances, leading to the situation where the class graph has become disconnected, as shown here:



Receiver-side view of the graph.

Of course, more complex situations are possible, such that the receiver ends up with multiple disconnected graphs, each containing many instances.



The [slice preservation](#) feature in version 1.1 of the encoding allows a receiver to remarshal the original graph intact, despite the fact that the receiver's in-memory object graph may appear to be disconnected.

See Also

- [Classes with Operations](#)
- [Basic Data Encoding](#)
- [Data Encoding for Classes](#)
- [Simple Example of Class Encoding](#)
- [Protocol Messages](#)
- [Understanding Objects and Exceptions](#)

Data Encoding for Interfaces

Interfaces can be [marshaled by value](#). For an interface marshaled by value (as opposed to a class instance derived from that interface), only the [type ID](#) of the most-derived interface is encoded. We use the following Slice definitions in our discussion:

Slice
<pre>interface Base { /* ... */ }; interface Derived extends Base { /* ... */ }; interface Example { void doSomething(Base b); };</pre>

We assume that the client passes a class instance to `doSomething` that does not have a Slice definition (but implements `Derived`).

Interface Encoding version 1.0

The on-the-wire representation of the interface parameter using encoding version 1.0 is as follows:

Marshaled Value	Size in Bytes	Type	Byte offset
1 (<i>identity</i>)	4	int	0
0 (<i>marker for class type ID</i>)	1	bool	4
"::Derived" (<i>class type ID</i>)	10	string	5
4 (<i>byte count for slice</i>)	4	int	15
0 (<i>marker for class type ID</i>)	1	bool	19
"::Ice::Object" (<i>class type ID</i>)	14	string	20
5 (<i>byte count for slice</i>)	4	int	34
0 (<i>number of dictionary entries</i>)	1	size	38

Interface Encoding version 1.1

With encoding version 1.1, the interface parameter is encoded as if it was a class with no data members. Here is the on-the-wire representation using the [sliced format](#):

Marshaled value	Size in bytes	Type	Byte offset
1 (<i>instance marker</i>)	1	size	0
17 (<i>slice flags: string type ID, size is present</i>)	1	byte	1
"::Derived" (<i>type ID - assigned index 1</i>)	10	string	2
4 (<i>byte count for slice</i>)	4	int	12

The compact format omits the byte count for the slice:

Marshaled value	Size in bytes	Type	Byte offset
1 (<i>instance marker</i>)	1	size	0
1 (<i>slice flags: string type ID</i>)	1	byte	1
"::Derived" (<i>type ID - assigned index 1</i>)	10	string	2

See Also

- [Passing Interfaces by Value](#)
- [Type IDs](#)
- [Data Encoding for Classes](#)

Data Encoding for Proxies

On this page:

- [Encoding for General Proxy Parameters](#)
- [Encoding for Endpoint Parameters](#)
- [Encoding for TCP Endpoint Parameters](#)
- [Encoding for UDP Endpoint Parameters](#)
- [Encoding for SSL Endpoint Parameters](#)

Encoding for General Proxy Parameters

The encoding format of proxies changed in version 1.1.

Proxy Parameter Encoding version 1.0

The first component of an encoded proxy is a value of type `Ice::Identity`. If the proxy is a nil value, the `category` and `name` members are empty strings, and no additional data is encoded. The encoding for a non-null proxy consists of general parameters followed by endpoint parameters.

The general proxy parameters are encoded as if they were members of the following structure:

Slice

```

struct ProxyData {
    Ice::Identity id;
    Ice::StringSeq facet;
    byte mode;
    bool secure;
};

```

The general proxy parameters are described in the following table.

Parameter	Description
<code>id</code>	The object identity
<code>facet</code>	The facet name (zero- or one-element sequence)
<code>mode</code>	The proxy mode (0=twoway, 1=oneway, 2=batch oneway, 3=datagram, 4=batch datagram)
<code>secure</code>	true if secure endpoints are required, otherwise false

The `facet` field has either zero elements or one element. An empty sequence denotes the default facet, and a one-element sequence provides the facet name in its first member. If a receiver receives a proxy with a `facet` field with more than one element, it must throw a `ProxyUnmarshalException`.

Proxy Parameter Encoding version 1.1

Version 1.1 of the encoding appends two attributes to the existing proxy parameters in version 1.0: [protocol](#) and [encoding versions](#). The general proxy parameters are encoded as if they were members of the following structure:

Slice
<pre> struct ProtocolVersion { byte major; byte minor; }; struct EncodingVersion { byte major; byte minor; }; struct ProxyData { Ice::Identity id; Ice::StringSeq facet; byte mode; bool secure; ProtocolVersion protocol; EncodingVersion encoding; }; </pre>

The additional parameters are described in the following table.

Parameter	Description
protocol	The maximum protocol version supported by the server. Currently this value is always 1.0.
encoding	The maximum encoding version supported by the server.

The encoding for [UDP endpoints](#) also changed in version 1.1.

Encoding for Endpoint Parameters

A proxy optionally contains an [endpoint list](#) or an [adapter identifier](#), but not both.

- If a proxy contains endpoints, they are encoded immediately following the general parameters. A [size](#) specifying the number of endpoints is encoded first, followed by the endpoints. Each endpoint is encoded as a `short` specifying the endpoint type (1=TCP, 2=SSL, 3=UDP), followed by an [encapsulation](#) of type-specific parameters. The type-specific parameters for TCP, UDP, and SSL are presented in the sections that follow.
- If a proxy does not have endpoints, a single byte with value 0 immediately follows the general parameters and a string representing the object adapter identifier is encoded immediately following the zero byte.

Type-specific endpoint parameters are encapsulated because a receiver may not be capable of decoding them. For example, a receiver can only decode SSL endpoint parameters if it is configured with the `IceSSL` plug-in. However, the receiver must be able to re-encode the proxy with all of its original endpoints, in the order they were received, even if the receiver does not understand the type-specific parameters for an endpoint. Encapsulation of the parameters into an [opaque endpoint](#) allows the receiver to do this.

Encoding for TCP Endpoint Parameters

A TCP endpoint is encoded as an encapsulation containing the following structure:

Slice
<pre> struct TCPEndpointData { string host; int port; int timeout; bool compress; }; </pre>

The endpoint parameters are described in the following table.

Parameter	Description
host	The server host (a host name or IP address)
port	The server port (1-65535)
timeout	The timeout in milliseconds for socket operations
compress	true if compression should be used (if possible), otherwise false

Encoding for UDP Endpoint Parameters

The encoding format of UDP endpoints changed in version 1.1.

UDP Endpoint Encoding version 1.0

A UDP endpoint is encoded as an encapsulation containing the following structure:

Slice
<pre> struct UDPEndpointData { string host; int port; byte protocolMajor; byte protocolMinor; byte encodingMajor; byte encodingMinor; bool compress; }; </pre>

The endpoint parameters are described in the following table.

Parameter	Description
host	The server host (a host name or IP address)
port	The server port (1-65535)
protocolMajor	The major protocol version supported by the endpoint

protocolMinor	The highest minor protocol version supported by the endpoint
encodingMajor	The major encoding version supported by the endpoint
encodingMinor	The highest minor encoding version supported by the endpoint
compress	true if compression should be used (if possible), otherwise false

UDP Endpoint Encoding version 1.1

Version 1.1 of the encoding omits the protocol and encoding versions because these attributes are handled as general proxy parameters instead:

Slice
<pre>struct UDPEndpointData { string host; int port; bool compress; };</pre>

The endpoint parameters are described in the following table.

Parameter	Description
host	The server host (a host name or IP address)
port	The server port (1-65535)
compress	true if compression should be used (if possible), otherwise false

Encoding for SSL Endpoint Parameters

An SSL endpoint is encoded as an encapsulation containing the following structure:

Slice
<pre>struct SSLEndpointData { string host; int port; int timeout; bool compress; };</pre>

The endpoint parameters are described in the following table.

Parameter	Description
host	The server host (a host name or IP address)

port	The server port (1-65535)
timeout	The timeout in milliseconds for socket operations
compress	true if compression should be used (if possible), otherwise false

See Also

- [Object Identity](#)
- [Facets and Versioning](#)
- [Basic Data Encoding](#)
- [IceSSL](#)
- [Using Connections](#)
- [Protocol Compression](#)

Data Encoding for Optional Values

Slice definitions can use [optional values](#) as parameters and as data members. To make optional values truly useful, the receiver needs the ability to gracefully ignore an optional value that it does not recognize. Although the Ice encoding omits type information and therefore is not self-describing, the encoding for optional values must include enough information for a receiver to determine how many bytes an optional value occupies so that it can skip to the next value in the stream. Despite this requirement, the encoding rules minimize the overhead associated with optional values, as you will see below.

On this page:

- [Overview of the Optional Value Encoding](#)
- [Encoding for Optional Types and Tags](#)
- [Examples of Optional Value Encoding](#)
 - [Optional Parameters Example](#)
 - [Optional Data Members Example](#)

Overview of the Optional Value Encoding

The encoding for optional parameters and data members follows these general rules:

- Each optional value has a corresponding integer tag that uniquely identifies it.
- Optional values always appear *after* any required values.
- Optional values must be sorted by their tags. (Unlike required values, order of declaration does not affect optional values.)
- An optional value is encoded only if the sender has supplied a value.

Optional data members of a class or exception appear in the [slice](#) after any required data members and before the indirection table, if present. The slice flags must indicate the presence of optional data members, which are included in the byte count for the slice. If a slice contains optional data members, the byte value 255 must be written after the last optional data member; this marker denotes the end of the optional data members and is also included in the byte count for the slice.

The encoding does not use an explicit end marker for optional parameters; the end of the encapsulation also marks the end of any optional parameters.

An optional value is encoded as the tuple $\langle type, tag, value \rangle$, where *type* is the *optional type* that tells the receiver how to determine the number of bytes occupied by the value. The value itself is marshaled using the standard Ice encoding rules for its Slice type.

 Optional values require encoding version 1.1.

Encoding for Optional Types and Tags

The first byte of an encoded optional value includes the optional type, and may also include the tag. The optional type occupies the first three bits of this byte, as described in the table below:

Name	Value	Description	Used for Slice type
F1	0	The value is encoded in one byte.	bool, byte
F2	1	The value is encoded in two bytes.	short
F4	2	The value is encoded in four bytes.	int, float
F8	3	The value is encoded in eight bytes.	double, long
Size	4	The value is encoded as a size .	enum

VSize	5	A leading size value indicates the number of bytes occupied by the value.	string, fixed-size structure, container of fixed-size elements
FSize	6	A leading 32-bit integer indicates the number of bytes occupied by the value.	variable-size structure, container of variable-size elements
Class	7	A class reference or inline instance.	class

The next five bits of the leading byte contain the tag, but only if the tag value is less than 30. Otherwise, the next five bits contain the value 30 as a marker to indicate that the tag value is encoded as a [size](#) starting with the next byte. As you can see, using tag values in the range 0 to 29 produces the most compact encoding.

Variable-size types whose encoded size cannot be determined in advance use the FSize optional type, where "FSize" denotes a leading fixed-length (32-bit) size. For these types, the sender reserves four bytes to hold the size, encodes the value as usual, then replaces the four bytes with the actual encoded size. This strategy avoids the need to shift the encoded data in the buffer, at the expense of potentially consuming more bytes than necessary to encode the size.

Fixed-size types use the VSize optional type, where "VSize" denotes a leading variable-length [size](#). The sender can determine the encoded size of these types in advance, and therefore encodes it as a size followed by the value as usual.

Strings also use the VSize optional type but do not require an additional [size](#) because the string encoding already includes a leading size. The same is true for sequences of `bool` and `byte`.

The optional type Class represents a class reference or inline instance. Note that a receiver must decode an inline instance even if it does not recognize the tag value because the instance may be referenced by other parameters.

The following table describes the encoding of Slice types:

Slice type	Optional type	Data encoding	Notes
<code>bool</code> , <code>byte</code>	F1	value	
<code>short</code>	F2	value	
<code>int</code> , <code>float</code>	F4	value	
<code>long</code> , <code>double</code>	F8	value	
Proxy	FSize	int + data	32-bit integer holds the size of the encoded proxy
<code>class</code>	Class	reference or instance	
<code>enum</code>	Size	size	Enumerator encoded as a size
<code>string</code>	VSize	value	The encoded data for the string already contains a leading size
<code>sequence<bool></code> , <code>sequence<byte></code>	VSize	value	The encoded data for the sequence already contains a leading size
<code>sequence<fixed-size type></code> , <code>dictionary<fixed-size key, fixed-size value></code>	VSize	size + value	Size can be computed before encoding the container

sequence< <i>variable size type</i> >, dictionary< <i>variable-size key</i> , <i>variable-size value</i> >	FSize	int + value	32-bit integer holds the size of the container
--	-------	-------------	--

Examples of Optional Value Encoding

The examples presented below demonstrate the encoding for optional values with typical use cases.

Optional Parameters Example

The following Slice operation makes use of optional input and output parameters:

Slice

```
bool op1(byte b,
        optional(2) string name,
        short sh,
        optional(1) long count,
        out double d,
        out optional(300) Object* p);
```

Suppose the parameters have the values shown in the table below:

Member	Type	Value	Marshaled size (in bytes)
b	byte	77	1
name	string	"joe"	4
sh	short	99	2
count	long	88	8
d	double	3.14	8
p	proxy	nil	2
<i>return value</i>	bool	true	1

The parameters of the outgoing request are encoded in an [encapsulation](#) with all required parameters first, in order of declaration, followed by the optional parameters sorted by tag:

Marshaled value	Size in bytes	Type	Byte offset
77 (<i>b</i>)	1	byte	0
99 (<i>sh</i>)	2	short	1
11 (<i>optional type F8 + tag 1</i>)	1	byte	3
88 (<i>count</i>)	8	long	4
21 (<i>optional type VSize + tag 2</i>)	1	byte	12
"joe" (<i>name</i>)	4	long	13

Using tag values less than 30 allows the encoding to combine the optional type and the tag into the same byte using the expression $(\text{Tag} \ll 3) + \text{Type}$.

Now consider the contents of the reply message:

Marshaled value	Size in bytes	Type	Byte offset
3.14 (<i>d</i>)	8	double	0
true (<i>return value</i>)	1	bool	8
246 (<i>optional type FSize + marker 30</i>)	1	byte	9
300 (<i>tag</i>)	5	size	10
2 (<i>32-bit FSize</i>)	4	int	15
nil (<i>p</i>)	2	Object*	19

The body of the reply message contains the out parameter *d*, the return value, and the optional parameter *p*. The tag value 300 is too large to combine with the optional type, therefore it appears immediately following the optional type encoded as a size. A proxy value uses the FSize optional type, meaning a 32-bit integer precedes the encoded value to specify its size.



Although the return value is required in this example, an optional return value is treated as if it were an optional out parameter.

The server here supplies a nil value for the optional proxy parameter. The client must not interpret this to mean that the optional parameter is unset; rather, the parameter is set, it just happens to be set to a nil value. If the server had supplied no value for the parameter, it would not appear in the encoding at all.

As an example, if the client does not recognize the optional proxy parameter, it can skip the parameter as follows:

1. Extract the byte containing the optional type
2. Examine the first three bits to determine the type
3. Examine the five remaining bits to determine the tag's status
4. A value of 30 means the tag is encoded separately
5. Extract the tag as a size
6. The optional type FSize means a 32-bit integer holds the value's size; extract the integer
7. Skip ahead the specified number of bytes
8. If we have reached the end of the encapsulation, there are no more optional parameters remaining

Optional Data Members Example

The only difference between the encoding for optional parameters and the encoding for optional data members is the latter uses a marker byte to signify the end of optional parameters in a slice. Consider the following definitions:

Slice
<pre> struct Color { short red; short green; short blue; }; class Shape { optional(1) string label; }; class Rectangle extends Shape { int width; int height; optional(10) Color fill; optional(9) Color border; optional(11) float scale; }; </pre>

Suppose we are encoding an instance of `Rectangle` with the member values shown in the table below:

Member	Type	Value	Marshaled size (in bytes)
label	string	"r1"	3
width	int	41	4
height	int	16	4
fill	Color	0,0,0	6
border	Color	255,255,255	6
scale	float	2.0	4

Using the sliced format, the instance data looks as follows:

Marshaled value	Size in bytes	Type	Byte offset
1 (<i>instance marker</i>)	1	byte	0
21 (<i>slice flags: string type ID, size is present, optional members are present</i>)	1	byte	1
"::Rectangle" (<i>type ID</i>)	12	string	2
34 (<i>byte count for slice</i>)	4	int	14
41 (<i>width</i>)	4	int	18

16 (<i>height</i>)	4	int	22
77 (<i>optional type VSize + tag 9</i>)	1	byte	26
6 (<i>VSize</i>)	1	size	27
{0,0,0} (<i>border</i>)	6	Color	28
85 (<i>optional type VSize + tag 10</i>)	1	byte	34
6 (<i>VSize</i>)	1	size	35
{255,255,255} (<i>fill</i>)	6	Color	36
90 (<i>optional type F4 + tag 11</i>)	1	byte	42
2.0 (<i>scale</i>)	4	float	43
255 (<i>end marker</i>)	1	byte	47
53 (<i>slice flags: string type ID, size is present, optional members are present, last slice</i>)	1	byte	48
"::Shape" (<i>type ID</i>)	8	string	49
9 (<i>byte count for slice</i>)	4	int	57
13 (<i>optional type VSize + tag 1</i>)	1	byte	61
"r1" (<i>label</i>)	3	string	62
255 (<i>end marker</i>)	1	byte	65

Notice the use of an end marker (byte value 255) denoting the end of the optional data members in each slice.

See Also

- [Optional Values](#)
- [Basic Data Encoding](#)
- [Data Encoding for Classes](#)

Protocol Messages

The Ice protocol uses five messages:

- Request (from client to server)
- Batch request (from client to server)
- Reply (from server to client)
- Validate connection (from server to client)
- Close connection (client to server or server to client)

Of these messages, validate and close connection only apply to connection-oriented transports.

As with the [data encoding](#), protocol messages have no alignment restrictions. Each message consists of a message header and (except for validate and close connection) a message body that immediately follows the header.

On this page:

- [Message Header](#)
- [Request Message Body](#)
- [Batch Request Message Body](#)
- [Reply Message Body](#)
- [Validate Connection Message](#)
- [Close Connection Message](#)
- [Protocol State Machine](#)
- [Disorderly Connection Closure](#)

Message Header

Each protocol message has a 14-byte header that is encoded as if it were the following structure:

Slice

```

struct HeaderData {
    int    magic;
    byte  protocolMajor;
    byte  protocolMinor;
    byte  encodingMajor;
    byte  encodingMinor;
    byte  messageType;
    byte  compressionStatus;
    int   messageSize;
};

```

The message header members are described in the following table.

Member	Description
magic	A four-byte magic number consisting of the ASCII-encoded values of 'I', 'c', 'e', 'P' (0x49, 0x63, 0x65, 0x50)
protocolMajor	The protocol major version number
protocolMinor	The protocol minor version number
encodingMajor	The encoding major version number

encodingMinor	The encoding minor version number
messageType	The message type
compressionStatus	The compression status of the message
messageSize	The size of the message in bytes, including the header

Currently, both the protocol and the encoding are at version 1.0. The valid message types are shown in the following table.

Message Type	Encoding
Request	0
Batch request	1
Reply	2
Validate connection	3
Close connection	4

The encoding for the message bodies of each of these message types is described in the sections that follow.

Request Message Body

A request message contains the data necessary to perform an invocation on an object, including the identity of the object, the operation name, and input parameters. A request message is encoded as if it were the following structure:

Slice
<pre> struct RequestData { int requestId; Ice::Identity id; Ice::StringSeq facet; string operation; byte mode; Ice::Context context; Encapsulation params; }; </pre>

The request members are described in the following table.

Member	Description
requestId	The request identifier
id	The object identity
facet	The facet name (zero- or one-element sequence)
operation	The operation name
mode	A byte representation of <code>Ice::OperationMode</code> (0=normal, 2=idempotent)
context	The invocation context

params	The encapsulated input parameters, in order of declaration
--------	--

The request identifier zero (0) is reserved for use in [oneway](#) requests and indicates that the server must not send a reply to the client. A non-zero request identifier must uniquely identify the request on a connection, and must not be reused while a reply for the identifier is outstanding.

The `facet` field has either zero elements or one element. An empty sequence denotes the default facet, and a one-element sequence provides the facet name in its first member. If a receiver receives a request with a `facet` field with more than one element, it must throw a `MarshalException`.

Batch Request Message Body

A [batch](#) request message contains one or more oneway requests, bundled together for the sake of efficiency. A batch request message is encoded as integer (not a size) that specifies the number of requests in the batch, followed by the corresponding number of requests, encoded as if each request were the following structure:

Slice
<pre> struct BatchRequestData { Ice::Identity id; Ice::StringSeq facet; string operation; byte mode; Ice::Context context; Encapsulation params; }; </pre>

The batch request members are described in the following table.

Member	Description
id	The object identity
facet	The facet name (zero- or one-element sequence)
operation	The operation name
mode	A byte representation of <code>Ice::OperationMode</code>
context	The invocation context
params	The encapsulated input parameters, in order of declaration

Note that no request ID is necessary for batch requests because only oneway invocations can be batched.

The `facet` field has either zero elements or one element. An empty sequence denotes the default facet, and a one-element sequence provides the facet name in its first member. If a receiver receives a batch request with a `facet` field with more than one element, it must throw a `MarshalException`.

Reply Message Body

A reply message body contains the results of a twoway invocation, including any return value, out-parameters, or exception. A reply message body is encoded as if it were the following structure:

```

struct ReplyData {
    int requestId;
    byte replyStatus;
    Encapsulation body; // messageSize - 19 bytes
};

```

The first four bytes of a reply message body contain a request ID. The request ID matches an outgoing request and allows the requester to associate the reply with the [original request](#).

The byte following the request ID indicates the status of the request; the remainder of the reply message body following the status byte is an [encapsulation](#) whose contents depend on the status value. The possible reply status values are shown in the table below (most of these values correspond to [common exceptions](#)).

Reply status	Success	Description
Success	0	A successful reply message is encoded as an encapsulation containing out-parameters (in the order of declaration), followed by the return value for the invocation, encoded according to their types as specified in Data Encoding . If an operation declares a <code>void</code> return type and no out-parameters, an empty encapsulation is encoded.
User exception	1	A user exception reply message contains an encapsulation containing the encoded user exception .
Object does not exist	2	If the target object does not exist, the reply message is encoded as if it were the following structure inside an encapsulation : <div data-bbox="1110 1232 1440 1736" style="border: 1px solid black; padding: 10px; margin: 10px 0;"> <div style="text-align: center; background-color: #f0f0f0; padding: 2px 5px;">Slice</div> <pre> struct ReplyData { Ice::Identity id; Ice::StringSeq facet; string operation; }; </pre> </div> <p>The invalid object reply members are described below:</p>

This page contains macros or features from a plugin which requires a valid license.

You will need to:

1. Install the [Plugin Licensing Manager](#).
2. Visit the Plugin Licensing Manager and acquire the necessary licenses.

[Licensing Help?](#)

The Adaptavist Content Formatting Macros plugin requires a license.

This page contains macros or features from a plugin which requires a valid license.
You will need to:

1. I
n
s
t
a
l
l
t
h
e
P
l
u
g
i
n
L
i
c
e
n
s
i
n
g
M
a
n
a
g
e
r
.
2. V
i
s
i
t
t
h
e
P
l
u
g
i
n
L
i
c
e
n
s
i
n
g
M
a
n

a
g
e
r
a
n
d
a
c
q
u
i
r
e
t
h
e
n
e
c
e
s
s
a
r
y
l
i
c
e
n
s

e
s
.
[Licensing Help?](#)

The Adaptavist Content Formatting Macros plugin requires a license.

This page contains macros or features from a plugin which requires a valid license. You will need to:

1. I
n
s
t
a
l
l
t
h
e
P
l
u
g
i
n
L
i
c
e
n
s
i
n
g
M
a
n
a
g
e
r
.
2. V
i
s
i
t
t
h
e
P
l
u
g
i
n
L
i
c
e
n
s
i
n
g
M
a
n

a
g
e
r
a
n
d
a
c
q
u
i
r
e
t
h
e
n
e
c
e
s
s
a
r
y
l
i
c
e
n
s

e s . Licensing Help?	The Adaptavist Content Formatting Macros plugin requires a license.	Member
This page contains macros or features from a plugin which requires a valid license. You will need to:	Description	This page contains macros or features from a plugin which requires a valid license. You will need to:

1. I
n
s
t
a
l
l
t
h
e
P
l
u
g
i
n
L
i
c
e
n
s
i
n
g
M
a
n
a
g
e
r
.
2. V
i
s
i
t
t
h
e
P
l
u
g
i
n
L
i
c
e
n
s
i
n
g
M
a

1. I
n
s
t
a
l
l
t
h
e
P
l
u
g
i
n
L
i
c
e
n
s
i
n
g
M
a
n
a
g
e
r
.
2. V
i
s
i
t
t
h
e
P
l
u
g
i
n
L
i
c
e
n
s
i
n
g
M
a
n

n
a
g
e
r
a
n
d
a
c
q
u
i
r
e
t
h
e
n
e
c
e
s
s
a
r
y
l
i
c
e
n
s

a
g
e
r
a
n
d
a
c
q
u
i
r
e
t
h
e
n
e
c
e
s
s
a
r
y
l
i
c
e
n
s

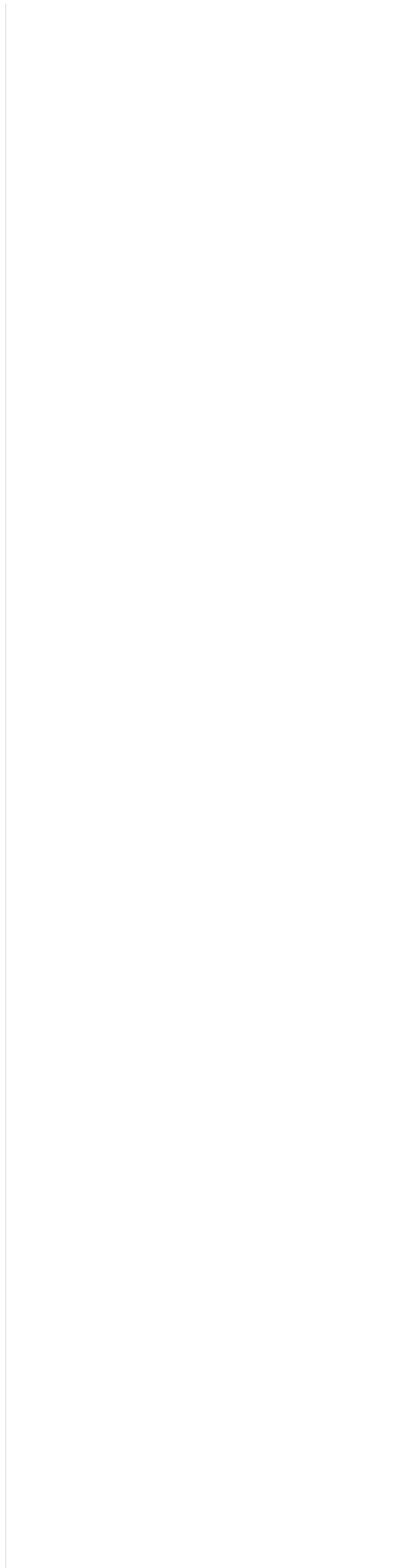

	e s .		e s .
	Licensing Help?		Licensing Help?
	The Adap tivist Cont ent Form atting Macr os pl ugin requi res a licen se.		The Adap tivist Cont ent Form atting Macr os pl ugin requi res a licen se.
This page cont ains macr os or featu res from a plugi n whic h requi res a valid licen se. You will need to:	id	This page cont ains macr os or featu res from a plugi n whic h requi res a valid licen se. You will need to:	The obj ect identity

1. Install the P L u g i n L i c e n s i n g M a n a g e r .
2. Visit the P L u g i n L i c e n s i n g M a n

1. Install the P L u g i n L i c e n s i n g M a n a g e r .
2. Visit the P L u g i n L i c e n s i n g M a

a
g
e
r
a
n
d
a
c
q
u
i
r
e
t
h
e
n
e
c
e
s
s
a
r
y
l
i
c
e
n
s

n
a
g
e
r
a
n
d
a
c
q
u
i
r
e
t
h
e
n
e
c
e
s
s
a
r
y
l
i
c
e
n
s

<p>e s .</p> <p>Licensing Help?</p>		<p>e s .</p> <p>Licensing Help?</p>	
<p>The Adap tivist Cont ent Form att ing Macr os pl ugin requir es a licens e.</p>		<p>The Adap tivist Cont ent Form att ing Macr os pl ugin requir es a licens e.</p>	
<p>This page contains macros or features from a plugin which requires a valid license. You will need to:</p>			

1. I
n
s
t
a
l
l
t
h
e
P
l
u
g
i
n
L
i
c
e
n
s
i
n
g
M
a
n
a
g
e
r
.
2. V
i
s
i
t
t
h
e
P
l
u
g
i
n
L
i
c
e
n
s
i
n
g
M
a
n

a
g
e
r
a
n
d
a
c
q
u
i
r
e
t
h
e
n
e
c
e
s
s
a
r
y
l
i
c
e
n
s

es.

[Licensing Help?](#)

The Adaptivist Content Formatting Macros plugin requires a license.

This page contains macros or features from a plugin which requires a valid license. You will need to:

facet

This page contains macros or features from a plugin which requires a valid license. You will need to:

The facet name (zero- or one-element sequence)

1. Install the P L u g i n L i c e n s i n g M a n a g e r .
2. Visit the P L u g i n L i c e n s i n g M a n

1. Install the P L u g i n L i c e n s i n g M a n a g e r .
2. Visit the P L u g i n L i c e n s i n g M a

a
g
e
r
a
n
d
a
c
q
u
i
r
e
t
h
e
n
e
c
e
s
s
a
r
y
l
i
c
e
n
s

n
a
g
e
r
a
n
d
a
c
q
u
i
r
e
t
h
e
n
e
c
e
s
s
a
r
y
l
i
c
e
n
s

<p>e s .</p> <p>Licensing Help?</p>		<p>e s .</p> <p>Licensing Help?</p>	
<p>The Adap tivist Cont ent Form atting Macr os pl ugin requir es a licens e.</p>		<p>The Adap tivist Cont ent Form atting Macr os pl ugin requir es a licens e.</p>	
<p>This page contains macros or features from a plugin which requires a valid license. You will need to:</p>			

1. I
n
s
t
a
l
l
t
h
e
P
l
u
g
i
n
L
i
c
e
n
s
i
n
g
M
a
n
a
g
e
r
.
2. V
i
s
i
t
t
h
e
P
l
u
g
i
n
L
i
c
e
n
s
i
n
g
M
a
n

a
g
e
r
a
n
d
a
c
q
u
i
r
e
t
h
e
n
e
c
e
s
s
a
r
y
l
i
c
e
n
s

e s . Licensing Help?	The Adaptavist Content Formatting Macros plugin requires a license.	This page contains macros or features from a plugin which requires a valid license. You will need to:
operation	This page contains macros or features from a plugin which requires a valid license. You will need to:	The operation name

1. Install the P L u g i n L i c e n s i n g M a n a g e r .

2. Visit the P L u g i n L i c e n s i n g M a n

1. Install the P L u g i n L i c e n s i n g M a n a g e r .

2. Visit the P L u g i n L i c e n s i n g M a

a
g
e
r
a
n
d
a
c
q
u
i
r
e
t
h
e
n
e
c
e
s
s
a
r
y
l
i
c
e
n
s

n
a
g
e
r
a
n
d
a
c
q
u
i
r
e
t
h
e
n
e
c
e
s
s
a
r
y
l
i
c
e
n
s

		<p>The <code>facet</code> field has either zero elements or one element. An empty sequence denotes the default facet, and a one-element sequence provides the facet name in its first member. If a receiver receives a reply with a <code>facet</code> field with more than one element, it must throw a <code>MarshalException</code>.</p>
Facet does not exist	3	If the target object does not support the facet encoded in the request message, the reply message is encoded as for reply status 2.
Operation does not exist	4	If the target object does not support the operation encoded in the request message, the reply message is encoded as for reply status 2.
Unknown Ice local exception	5	The reply message for an unknown Ice local exception is encoded as an encapsulation containing a single string that describes the exception.
Unknown Ice user exception	6	The reply message for an unknown Ice user exception is encoded as an encapsulation containing a single string that describes the exception.
Unknown exception	7	The reply message for an unknown exception is encoded as an encapsulation containing a single string that describes the exception.

Validate Connection Message

A server sends a validate connection message when it receives a new connection.

 Validate connection messages are only used for connection-oriented transports.

The message indicates that the server is ready to receive requests; the client must not send any messages on the connection until it has received the validate connection message from the server. No reply to the message is expected by the server.

The purpose of the validate connection message is two-fold:

- It confirms to the client that the server is indeed an Ice server and not another type of server reached by accident.
- It prevents the client from writing a request message to its local transport buffers until after the server has acknowledged that it can actually process the request. This avoids a race condition caused by the server's TCP/IP stack accepting connections in its backlog while the server is in the process of shutting down: if the client were to send a request in this situation, the request would be lost but the client could not safely re-issue the request because that might violate at-most-once semantics. The validate connection message guarantees that a server is not in the middle of shutting down when the server's TCP/IP stack accepts an incoming connection and so avoids the race condition.

The [message header](#) comprises the entire validate connection message. The [compression](#) status of a validate connection message is always 0.

Close Connection Message

A close connection message is sent when a peer is about to gracefully shutdown a [connection](#).

 Close connection messages are only used for connection-oriented transports.

The [message header](#) comprises the entire close connection message. The [compression](#) status of a close connection message is always 0.

Either client or server can initiate connection closure. On the client side, connection closure is triggered by [Active Connection Management \(ACM\)](#), which automatically reclaims connections that have been idle for some time.

This means that connection closure can be initiated at will by either end of a connection; most importantly, no state is associated with a connection as far as the object model or application semantics are concerned.

The client side can close a connection whenever no reply for a request is outstanding on the connection. The sequence of events is:

1. The client sends a close connection message.
2. The client closes the writing end of the connection.
3. The server responds to the client's close connection message by closing the connection.

The server side can close a connection whenever no operation invocation is in progress that was invoked via that connection. This guarantees that the server will not violate [at-most-once semantics](#): an operation, once invoked in a servant, is allowed to complete and its results are returned to the client. Note that the server can close a connection even after it has received a request from the client, provided that the request has not yet been passed to a servant. In other words, if the server decides that it wants to close a connection, the sequence of events is:

1. The server discards all incoming requests on the connection.
2. The server waits until all still executing requests have completed and their results have been returned to the client.
3. The server sends a close connection message to the client.
4. The server closes its writing end of the connection.
5. The client responds to the server's close connection message by closing both its reading and writing ends of the connection.
6. If the client has outstanding requests at the time it receives the close connection message, it re-issues these requests on a new connection. Doing so is guaranteed not to violate at-most-once semantics because the server guarantees not to close a connection while requests are still in progress on the server side.

Protocol State Machine

From a client's perspective, the Ice protocol behaves according to the state machine shown below:

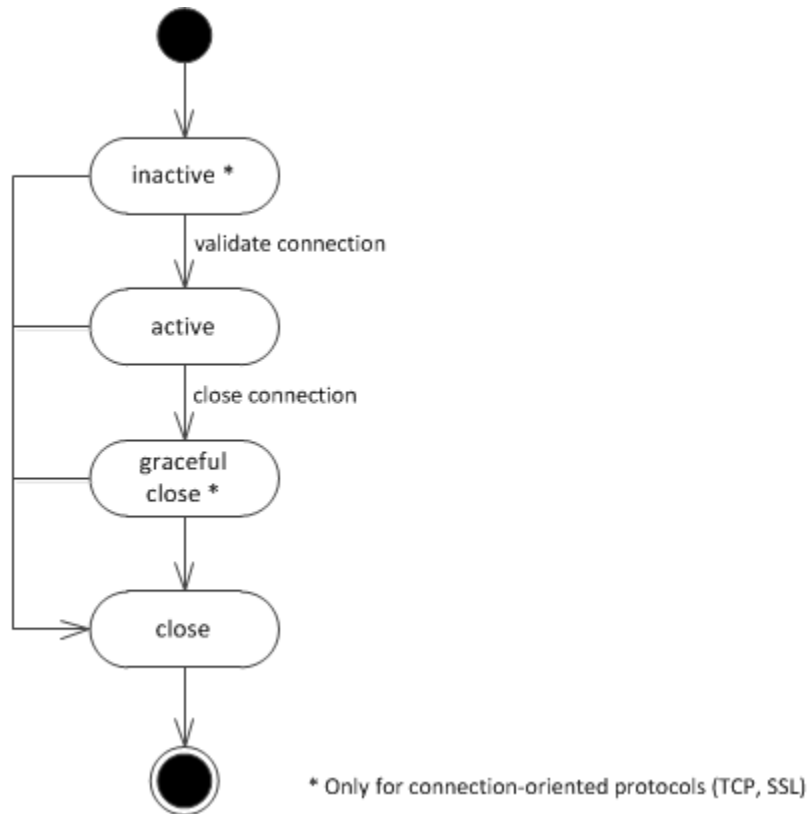

Protocol state machine.

To summarize, a new connection is inactive until a [validate connection](#) message has been received by the client, at which point the active state is entered. The connection remains in the active state until it is shut down, which can occur when there are no more proxies using the connection, or after the connection has been idle for a while. At this point, the connection is [gracefully closed](#), meaning that a [close connection](#) message is sent, and the connection is closed.

Disorderly Connection Closure

Any violation of the protocol or encoding rules results in a disorderly connection closure: the side of the connection that detects a violation unceremoniously closes it (without sending a [close connection](#) message or similar). There are many potential error conditions that can lead to disorderly connection closure; for example, the receiver might detect that a message has a bad magic number or incompatible version, receive a reply with an ID that does not match that of an outstanding request, receive a [validate connection](#) message when it should not, or find illegal data in a request (such as a negative size, or a size that disagrees with the actual data that was unmarshaled).

See Also

- [Data Encoding](#)
- [Protocol Compression](#)
- [Object Identity](#)
- [Facets and Versioning](#)
- [Request Contexts](#)
- [Oneway Invocations](#)
- [Batched Invocations](#)
- [Protocol and Encoding Versions](#)
- [Active Connection Management](#)
- [Automatic Retries](#)
- [Connection Closure](#)

Protocol Compression

Compression is an optional feature of the Ice protocol; whether it is used for a particular message is determined by several factors:

1. Compression may not be supported on all platforms or in all language mappings.
2. Compression can be used in a request or batch request only if the endpoint [advertises](#) the ability to accept compressed messages.
3. For efficiency reasons, the Ice protocol engine does not compress messages smaller than 100 bytes.



A compliant implementation of the protocol is free to compress messages that are smaller than 100 bytes — the choice is up to the protocol implementation.

If compression is used, the entire message excluding the [header](#) is compressed using the bzip2 algorithm [1]. The `messageSize` member of the message header therefore reflects the size of the compressed message, including the uncompressed header, plus an additional four bytes.

The `compressionStatus` field of the message header indicates whether a message is compressed and whether the sender can accept a compressed reply, as shown in the table below.

Reply status	Encoding	Applies to	Description
Message is uncompressed, sender cannot accept a compressed reply.	0	Request, Batch Request, Reply, Validate Connection, Close Connection	A client that does not support compression always uses this value. A client that supports compression sets the value to 0 if the endpoint via which the request is dispatched indicates that it does not support compression. A server uses this value for uncompressed replies.
Message is uncompressed, sender can accept a compressed reply.	1	Request, Batch Request	A client uses this value if the endpoint via which the request is dispatched indicates that it supports compression, but the client has decided not to use compression for this particular request (presumably because the request is too small, so compression does not provide any saving).
Message is compressed and sender can accept a compressed reply.	2	Request, Batch Request, Reply	A client that supports compression sets this value only if the endpoint via which the request is dispatched indicates that it supports compression. A server uses this value for compressed replies.

The message body of a compressed request, batch request, or reply message is encoded by first writing the size of the uncompressed message (including its header) as a four-byte integer, followed by the compressed message body (excluding the header). It follows that the size of a compressed message is 4 bytes for the header, plus four bytes to record the size of the uncompressed message, plus the number of bytes occupied by the compressed message body. Writing the uncompressed message size prior to the body enables the receiver to allocate a buffer that is large enough to accommodate the uncompressed message body.

Note that compression is likely to improve performance only over lower-speed links, for which bandwidth is the overall limiting factor. Over

high-speed LAN links, the CPU time spent on compressing and uncompressing messages is longer than the time it takes to just send the uncompressed data.

See Also

- [Data Encoding for Proxies](#)
- [Protocol Messages](#)

References

1. Red Hat, Inc. 2003. *The bzip2 and libbzip2 Home Page*. Raleigh, NC: Red Hat, Inc.

Protocol and Encoding Versions

On this page:

- [Version Flexibility](#)
- [Version Ground Rules](#)

Version Flexibility

As we saw in the preceding sections, both the Ice protocol and encoding have separate major and minor version numbers. Separate versioning of protocol and encoding has the advantage that neither depends on the other: any version of the Ice protocol can be used with any version of the encoding, so they can evolve independently. For example, you could send a request with Ice protocol version 1.1, and encode the parameters with encoding version 2.3.

The Ice versioning mechanism provides the maximum possible amount of interoperability between clients and servers that use different versions of the Ice run time. In particular, older deployed clients can communicate with newer deployed servers and vice versa, provided that the message contents use types that are understandable to both sides. Intermediary servers, such as a Glacier2 router, do not and should not check the contents of the requests and responses they forward; this way, an older intermediary server can forward messages encoded with a newer encoding that it does not understand.



Due to a bug, a Glacier2 router prior to version 3.5 can only forward messages encoded using the 1.0 encoding.

Ice 3.5 introduced a new encoding, encoding version 1.1, in support of several new features such as the ability to define optional parameters in operations. In order to send a request with an optional parameter, you need to use encoding 1.1 or greater.

Ice 3.5 is capable of marshaling and unmarshaling messages with both the 1.0 and 1.1 encodings (it uses the 1.1 encoding by default). This allows interoperability to the maximum extent possible:

Client Ice Version	Server Ice Version	Encoding Version	Operation without Optional Parameter	Operation with Optional Parameter
3.4 or earlier	3.4 or earlier	1.0	Yes	No
3.4 or earlier	3.5	1.0	Yes	No
3.5	3.4 or earlier	1.0	Yes	No
3.5	3.5	1.1	Yes	Yes

When an Ice 3.5 client sends a request to an Ice 3.4 server, it must naturally use the 1.0 encoding. This is achieved by setting correctly (and often automatically) the encoding version on the proxy used. If this proxy is received by the client through a response using the 1.0 encoding, the decoded proxy will automatically have the desired 1.0 encoding (all proxies in a 1.0-encoded message implicitly have 1.0 as their encoding version and 1.0 as their protocol version). If this proxy is created with `stringToProxy` or `propertyToProxy`, the client will need to set this proxy's encoding version to 1.0 through one of the following methods:

- with `-e 1.0` in the source stringified proxy
- by creating a new proxy with the desired encoding version, by calling `ice_encodingVersion("1.0")` on the proxy
- by setting `Ice.Default.EncodingVersion` to 1.0.

Version Ground Rules

For versioning of the protocol and encoding to be possible, all versions (present and future) of the Ice run time adhere to a few ground rules:

1. [Encapsulations](#) always have a six-byte header; the first four bytes are the size of the encapsulation (including the size of the header), followed by two bytes that indicate the major and minor version. How to interpret the remainder of the encapsulation depends on the major and minor version.
2. The first eight bytes of a [message header](#) always contain the magic number 'I', 'c', 'e', 'P', followed by four bytes of version information (two bytes for the protocol major and minor number, and two bytes for the encoding major and minor number). How to

interpret the remainder of the header and the message body depends on the major and minor version.

These ground rules ensure that all current and future versions of the Ice run time can at least identify the version and size of an encapsulation and a message. This is particularly important for message switches such as [IceStorm](#); by keeping the version and size information in a fixed format, it is possible to forward messages that are, for example, at version 2.0, even though the message switch itself may still be at version 1.0.

See Also

- [Basic Data Encoding](#)
- [Protocol Messages](#)
- [IceStorm](#)
- [IceGrid](#)

IceGrid

IceGrid is the location and activation service for Ice applications. For the purposes of this discussion, we can loosely define *grid computing* as the use of a network of relatively inexpensive computers to perform the computational tasks that once required costly "big iron." Developers familiar with distributed computing technologies may not consider the notion of grid computing to be particularly revolutionary; after all, distributed applications have been running on networks for years, and the definition of grid computing is sufficiently vague that practically any server environment could be considered a "grid."

One possible grid configuration is a homogeneous collection of computers running identical programs. Each computer in the grid is essentially a clone of the others, and all are equally capable of handling a task. As a developer, you need to write the code that runs on the grid computers, and Ice is ideally suited as the infrastructure that enables the components of a grid application to communicate with one another. However, writing the application code is just the first piece of the puzzle. Many other challenges remain:

- How do I install and update this application on all of the computers in the grid?
- How do I keep track of the servers running on the grid?
- How do I distribute the load across all the computers?
- How do I migrate a server from one computer to another one?
- How can I quickly add a new computer to the grid?

Of course, these are issues faced by most distributed applications. As you learn more about IceGrid's capabilities, you will discover that it offers solutions to these challenges. To get you started, we have summarized IceGrid's feature set below:

- **Location service**
As an implementation of an Ice [location service](#), IceGrid enables clients to bind indirectly to their servers, making applications more flexible and resilient to changing requirements.
- **On-demand server activation**
Starting an Ice server process is called *server activation*. IceGrid can be given responsibility for activating a server on demand, that is, when a client attempts to access an object hosted by the server. Activation usually occurs as a side effect of indirect binding, and is completely transparent to the client.
- **Application distribution**
IceGrid provides a convenient way to distribute your application to a set of computers, without the need for a shared file system or complicated scripts. Simply configure an [IcePatch2](#) server and let IceGrid download the necessary files and keep them synchronized.
- **Replication and load balancing**
IceGrid supports replication by grouping the object adapters of several servers into a single virtual object adapter. During indirect binding, a client can be bound to an endpoint of any of these adapters. Furthermore, IceGrid monitors the load on each computer and can use that information to decide which of the endpoints to return to a client.
- **Sessions and resource allocation**
An IceGrid client establishes a session in order to allocate a resource such as an object or a server. IceGrid prevents other clients from using the resource until the client releases it or the session expires. Sessions enhance security through the use of an authentication mechanism that can be integrated with a [Glacier2 router](#).
- **Automatic failover**
Ice supports automatic retry and failover in any proxy that contains multiple endpoints. When combined with IceGrid's support for replication and load balancing, automatic failover means that a failed request results in a client transparently retrying the request on the next endpoint with the lowest load.
- **Dynamic queries**
In addition to transparent binding, applications can interact directly with IceGrid to locate objects in a variety of ways.
- **Status monitoring**
IceGrid supports Slice interfaces that allow applications to monitor its activities and receive notifications about significant events, enabling the development of custom tools or the integration of IceGrid status events into an existing management framework.
- **Administration**
IceGrid includes command-line and graphical administration tools. They are available on all supported platforms and allow you to start, stop, monitor, and reconfigure any server managed by IceGrid.

- **Deployment**
Using XML files, you can describe the servers to be deployed on each computer. Templates simplify the description of identical servers.

As grid computing enters the mainstream and compute servers become commodities, users expect more value from their applications. IceGrid, in cooperation with the Ice run time, relieves you of these low-level tasks to accelerate the construction and simplify the administration of your distributed applications.

Topics

- [IceGrid Architecture](#)
- [Getting Started with IceGrid](#)
- [Using IceGrid Deployment](#)
- [Well-Known Objects](#)
- [IceGrid Templates](#)
- [IceBox Integration with IceGrid](#)
- [Object Adapter Replication](#)
- [Load Balancing](#)
- [Resource Allocation using IceGrid Sessions](#)
- [Registry Replication](#)
- [Application Distribution](#)
- [IceGrid Administrative Sessions](#)
- [Glacier2 Integration with IceGrid](#)
- [IceGrid XML Reference](#)
- [Using Descriptor Variables and Parameters](#)
- [IceGrid Property Set Semantics](#)
- [IceGrid XML Features](#)
- [IceGrid Server Reference](#)
- [IceGrid and the Administrative Facility](#)
- [Securing IceGrid](#)
- [icegridadmin Command Line Tool](#)
- [IceGrid Admin Graphical Tool](#)
- [IceGrid Server Activation](#)
- [IceGrid Troubleshooting](#)

IceGrid Architecture

An IceGrid domain consists of a *registry* and any number of *nodes*. Together, the registry and nodes cooperate to manage the information and server processes that comprise *applications*. Each application assigns servers to particular nodes. The registry maintains a persistent record of this information, while the nodes are responsible for starting and monitoring their assigned server processes. In a typical configuration, one node runs on each computer that hosts Ice servers. The registry does not consume much processor time, so it commonly runs on the same computer as a node; in fact, the registry and a node can run in the same process if desired. If fault tolerance is desired, the registry supports replication using a master-slave design.

On this page:

- [Architecture of a Simple IceGrid Application](#)
- [Server Replication with IceGrid](#)
- [Deploying an IceGrid Application](#)

Architecture of a Simple IceGrid Application

As an example, this illustration shows a very simple IceGrid application running on a network of three computers. The IceGrid registry is the only process of interest on host PC1, while IceGrid nodes are running on the hosts PC2 and PC3. In this sample application, one server has been assigned to each node.

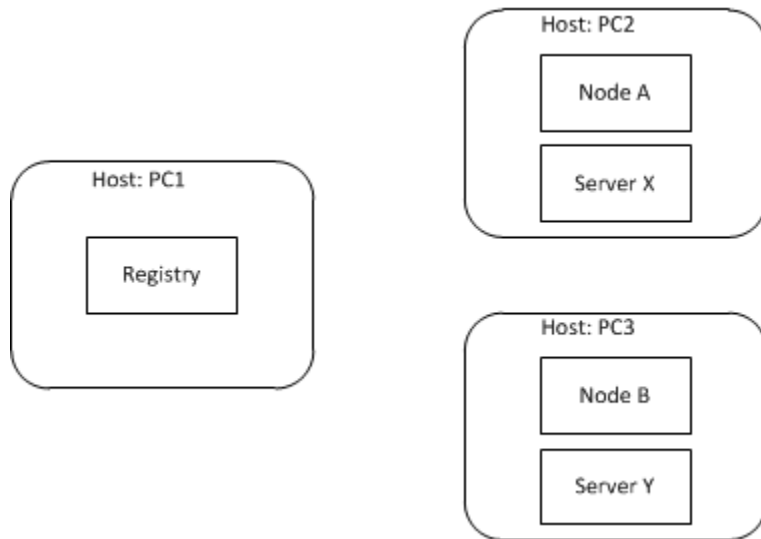

Simple IceGrid application.

From a client application's perspective, the primary responsibility of the registry is to resolve indirect proxies as an Ice [location service](#). As such, this contribution is largely transparent: when a client first attempts to use an indirect proxy, the Ice run time in the client contacts the registry to convert the proxy's symbolic information into endpoints that allow the client to [establish a connection](#).

Although the registry might sound like nothing more than a simple lookup table, reality is quite different. For example, behind the scenes, a locate request might prompt a node to start the target server automatically, or the registry might select appropriate endpoints based on load statistics from each computer.

This also illustrates the benefits of indirect proxies: the location service can provide a great deal of functionality without any special action by the client and, unlike with direct proxies, the client does not need advance knowledge of the address and port of a server. The extra level of indirection adds some latency to the client's first use of a proxy; however, all subsequent interactions occur directly between client and server, so the cost is negligible. Furthermore, indirection allows servers to migrate to different computers without the need to update proxies held by clients.

Server Replication with IceGrid

IceGrid's flexibility allows an endless variety of configurations. For example, suppose we have a grid network and want to replicate a server on each blade, as shown below:

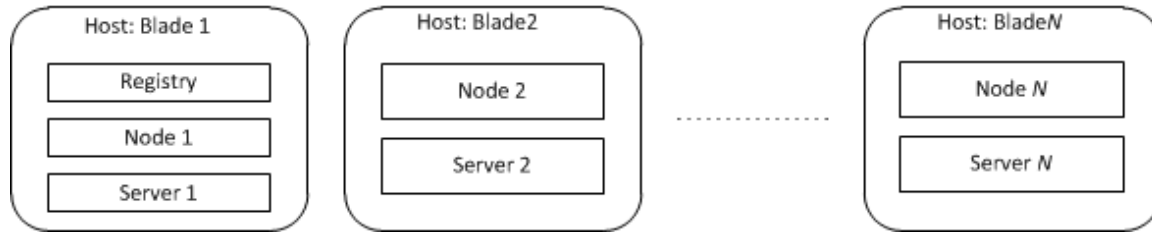

Replicated server on grid network.

Replication in Ice is based on [object adapters](#), not servers. Any object adapter in any server could participate in replication, but it is far more likely that all of the [replicated object adapters](#) are created by instances of the same server executable that is running on each computer. We are using this configuration in the example shown above, but IceGrid requires each server to have a unique name. `Server 1` and `Server 2` are our unique names for the same executable.

The binding process works somewhat differently when replication is involved, since the registry now has multiple object adapters to choose from. The description of the IceGrid application drives the registry's decision about which object adapter (or object adapters) to use. For example, the registry could consider the system load of each computer (as periodically reported by the nodes) and return the endpoints of the object adapter on the computer with the lowest load. It is also possible for the registry to combine the endpoints of several object adapters, in which case the Ice run time in the client would select the endpoint for the initial connection attempt.

Deploying an IceGrid Application

In IceGrid, *deployment* is the process of describing an application to the registry. This description includes the following information:

- **Replica groups**
A *replica group* is the term for a collection of [replicated object adapters](#). An application can create any number of replica groups. Each group requires a unique identifier.
- **Nodes**
An application must assign its servers to one or more nodes.
- **Servers**
A server's description includes a unique name and the path to its executable. It also lists the object adapters it creates.
- **Object adapters**
Information about an object adapter includes its endpoints and any well-known objects it advertises. If the object adapter is a member of a replica group, it must also supply that group's identifier.
- **Objects**
A *well-known object* is one that is known solely by its identity. The registry maintains a global list of such objects for use during locate requests.

IceGrid uses the term *descriptor* to refer to the description of an application and its components; deploying an application involves creating its descriptors in the registry. There are several ways to accomplish this:

- You can use a command-line tool that reads a file containing an XML representation of the descriptors.
- You can create descriptors interactively with the graphical administration tool.
- You can create descriptors programmatically via IceGrid's administrative interface.

The registry server must be running in order to deploy an application, but it is not necessary for nodes to be active. Nodes that are started after deployment automatically retrieve the information they need from the registry. Once deployed, you can update the application at any time.

See Also

- [Locators](#)
- [Connection Establishment](#)
- [Object Adapters](#)
- [Object Adapter Replication](#)
- [Well-Known Objects](#)

Getting Started with IceGrid

This page introduces a sample application that will help us demonstrate IceGrid's capabilities.

On this page:

- [The Ripper Application](#)
- [Initial Ripper Architecture](#)
- [Ripper Registry Configuration](#)
- [Ripper Client Configuration](#)
- [Ripper Server Configuration](#)
- [Starting the Registry for the Ripper Application](#)
- [Starting the Ripper Server](#)
- [Ripper Progress Review](#)

The Ripper Application

Our application "rips" music tracks from a compact disc (CD) and encodes them as MP3 files, as shown below:

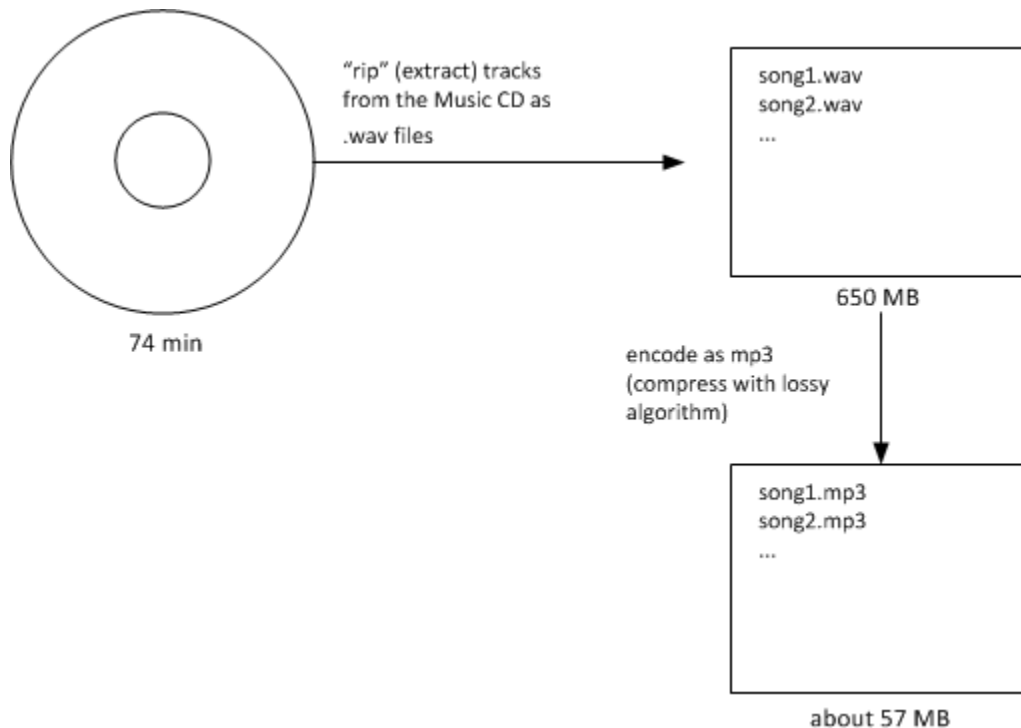

Overview of sample application.

Ripping an entire CD usually takes several minutes because the MP3 encoding requires lots of CPU cycles. Our distributed ripper application accelerates this process by taking advantage of powerful CPUs on remote Ice servers, enabling us to process many songs in parallel.

The Slice interface for the MP3 encoder is straightforward:

Slice

```

#include <Ice/BuiltInSequences.ice>
module Ripper {
exception EncodingFailedException {
    string reason;
};

sequence<short> Samples;

interface Mp3Encoder {
    // Input: PCM samples for left and right channels
    // Output: MP3 frame(s).
    Ice::ByteSeq encode(Samples leftSamples, Samples rightSamples)
        throws EncodingFailedException;

    // You must flush to get the last frame(s). Flush also
    // destroys the encoder object.
    Ice::ByteSeq flush()
        throws EncodingFailedException;
};

interface Mp3EncoderFactory
{
    Mp3Encoder* createEncoder();
};
};

```

The implementation of the encoding algorithm is not relevant for the purposes of this discussion. Instead, we will focus on incrementally improving the application as we discuss IceGrid features.

Initial Ripper Architecture

The initial architecture for our application is intentionally simple, consisting of an IceGrid registry and a server that we start manually. This illustration shows how the client's invocation on its `EncoderFactory` proxy causes an implicit locate request:

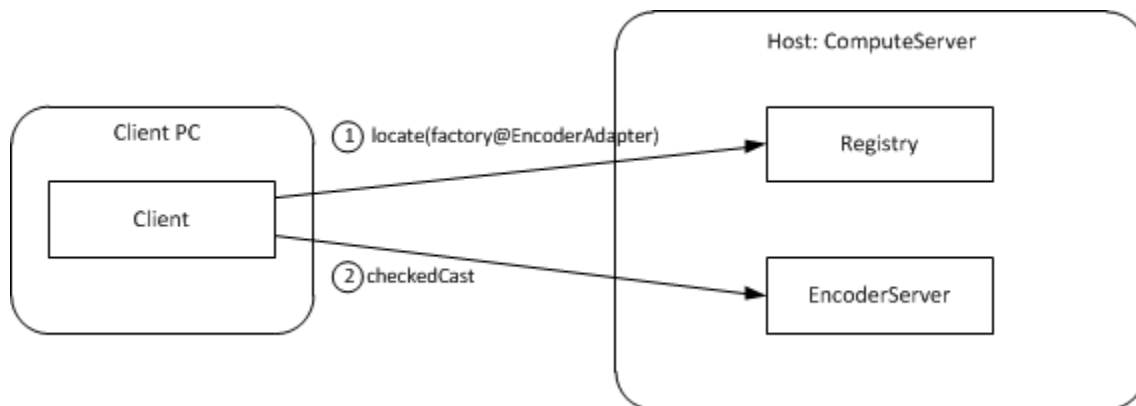

Initial architecture for the ripper application.

The corresponding C++ code for the client is presented below:

```
C++
```

```
Ice::ObjectPrx proxy =
communicator->stringToProxy( "factory@EncoderAdapter" );
Ripper::MP3EncoderFactoryPrx factory =
Ripper::MP3EncoderFactoryPrx::checkedCast(proxy);
Ripper::MP3EncoderPrx encoder = factory->createEncoder();
```

Notice that the client uses an indirect proxy for the `MP3EncoderFactory` object. This stringified proxy can be read literally as "the object with identity `factory` in the object adapter identified as `EncoderAdapter`." The encoding server creates this object adapter and ensures that the object adapter uses this identifier. Since each object adapter must be uniquely identified, the registry can easily determine the server that created the adapter and return an appropriate endpoint to the client.

The client's call to `checkedCast` is the first remote invocation on the factory object, and therefore the locate request is performed during the completion of this invocation. The subsequent call to `createEncoder` is sent directly to the server without further involvement by IceGrid.

Ripper Registry Configuration

The registry needs a subdirectory in which to create its databases, and we will use `/opt/ripper/registry` for this purpose (the directory must exist before starting the registry). We also need to create an Ice configuration file to hold [properties](#) required by the registry. The file `/opt/ripper/registry.cfg` contains the following properties:

```
IceGrid.Registry.Client.Endpoints=tcp -p 4061
IceGrid.Registry.Server.Endpoints=tcp
IceGrid.Registry.Internal.Endpoints=tcp
IceGrid.Registry.AdminPermissionsVerifier=IceGrid/NullPermissionsVerifi
er
IceGrid.Registry.Data=/opt/ripper/registry
IceGrid.Registry.DynamicRegistration=1
```

Several of the properties define endpoints, but only the value of `IceGrid.Registry.Client.Endpoints` needs a fixed port. This property specifies the endpoints of the IceGrid locator service; IceGrid clients must include these endpoints in their definition of `Ice.Default.Locator`, as discussed in the next section. The TCP port number (4061) used in this example has been reserved by the [Internet Assigned Numbers Authority](#) (IANA) for the IceGrid registry, along with SSL port number 4062.

Several other properties are worth mentioning:

- `IceGrid.Registry.AdminPermissionsVerifier`
Controls access to the registry's [administrative functionality](#).
- `IceGrid.Registry.Data`
Specifies the registry's database directory.
- `IceGrid.Registry.DynamicRegistration`
If set to a non-zero value, allows servers to register their object adapters. Dynamic registration is explained in more detail below.

By default, IceGrid will not permit a server to register its object adapters without using IceGrid's [deployment facility](#). In some situations, such as in this sample application, you may want a client to be able to bind indirectly to a server without having to first deploy the server. That is, simply starting the server should be sufficient to make the server register itself with IceGrid and be reachable from clients.

You can achieve this by running the registry with the property `IceGrid.Registry.DynamicRegistration` set to a non-zero value. With this setting, IceGrid permits an adapter to register itself upon activation even if it has not been previously deployed. To force the server to

register its adapters, you must define `Ice.Default.Locator` (so the server can find the registry) and, for each adapter that you wish to register, you must set `<adapter-name>.AdapterId` to an identifier that is unique within the registry. Setting the `<adapter-name>.AdapterId` property also causes the adapter to no longer create direct proxies but rather to create indirect proxies that clients must resolve via the registry.

Ripper Client Configuration

The client requires only minimal configuration, namely a value for the property `Ice.Default.Locator`. This property supplies the Ice run time with the proxy for the locator service. In IceGrid, the locator service is implemented by the registry, and the locator object is available on the registry's client endpoints. The property `IceGrid.Registry.Client.Endpoints` defined above provides most of the information we need to construct the proxy. The missing piece is the identity of the locator object, which defaults to `IceGrid/Locator`:

```
Ice.Default.Locator=IceGrid/Locator:tcp -h registryhost -p 4061
```

The use of a locator service allows the client to take advantage of indirect binding and avoid static dependencies on server endpoints. However, the locator proxy must have a fixed port, otherwise the client has a bootstrapping problem: it cannot resolve indirect proxies without knowing the endpoints of the locator service.

Note that the identity of the locator object may change based on the [registry's configuration](#).

Ripper Server Configuration

We use `/opt/ripper/server.cfg` as the server's configuration file. It contains the following properties:

```
EncoderAdapter.AdapterId=EncoderAdapter
EncoderAdapter.Endpoints=tcp
Ice.Default.Locator=IceGrid/Locator:tcp -h registryhost -p 4061
```

The properties are described below:

- `EncoderAdapter.AdapterId`
This property supplies the object adapter identifier that the client uses in its indirect proxy (e.g., `factory@EncoderAdapter`).
- `EncoderAdapter.Endpoints`
This property defines the [object adapter's endpoint](#). Notice that the value does not contain any port information, meaning that the adapter uses a system-assigned port. Without IceGrid, the use of a system-assigned port would pose a significant problem: how would a client create a direct proxy if the adapter's port could change every time the server is restarted? IceGrid solves this problem nicely because clients can use indirect proxies that contain no endpoint dependencies. The registry resolves indirect proxies using the endpoint information supplied by object adapters each time they are activated.
- `Ice.Default.Locator`
The server requires a value for this property in order to register its object adapter.

Starting the Registry for the Ripper Application

Now that the configuration file is written and the directory structure is prepared, we are ready to start the IceGrid registry:

```
$ icegridregistry --Ice.Config=/opt/ripper/registry.cfg
```

Additional [command line options](#) are supported, including those that allow the registry to run as a Windows service or Unix daemon.

Starting the Ripper Server

With the registry up and running, we can now start the server. At a command prompt, we run the program and pass an `--Ice.Config` option indicating the location of the configuration file:

```
$ /opt/ripper/bin/server --Ice.Config=/opt/ripper/server.cfg
```

Ripper Progress Review

This example demonstrated how to use IceGrid's location service, which is a core component of IceGrid's feature set. By incorporating IceGrid into our application, the client is now able to locate the `MP3EncoderFactory` object using only an indirect proxy and a value for `Ice.Default.Locator`. Furthermore, we can reconfigure the application in any number of ways without modifying the client's code or configuration.

For some applications, the functionality we have already achieved using IceGrid may be entirely sufficient. However, we have only just begun to explore IceGrid's capabilities, and there is much we can still do to improve our application. The next section shows how we can avoid the need to start our server manually by deploying our application onto an IceGrid node.

See Also

- [Locator Configuration for a Client](#)
- [Resource Allocation using IceGrid Sessions](#)
- [Well-Known Registry Objects](#)
- [Using IceGrid Deployment](#)
- [Object Adapter Endpoints](#)
- [icegridregistry](#)
- [IceGrid Properties](#)

Using IceGrid Deployment

Here we extend the capabilities of our [sample application](#) using IceGrid's deployment facility.

On this page:

- [Ripper Architecture using Deployment](#)
- [Ripper Deployment Descriptors](#)
- [Ripper Registry and Node Configuration](#)
- [Ripper Server Configuration using Deployment](#)
- [Starting the Node for the Ripper Application](#)
- [Deploying the Ripper Application](#)
- [Ripper Progress Review](#)
- [Adding Nodes to the Ripper Application](#)
 - [Descriptor Changes](#)
 - [Configuration Changes](#)
 - [Redeploying the Application](#)
 - [Client Changes](#)

Ripper Architecture using Deployment

The revised architecture for our application consists of a single IceGrid node responsible for our encoding server that runs on the computer named `ComputeServer`. The illustration below shows the client's initial invocation on its indirect proxy and the actions that IceGrid takes to make this invocation possible:

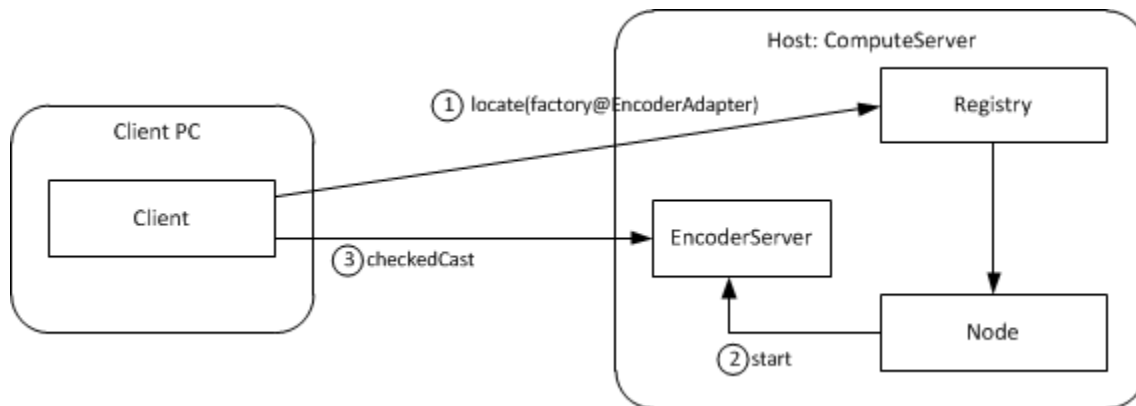

Architecture for deployed ripper application.

In contrast to the [initial architecture](#), we no longer need to manually start our server. In this revised application, the client's locate request prompts the registry to query the node about the server's state and start it if necessary. Once the server starts successfully, the locate request completes and subsequent client communication occurs directly with the server.

Ripper Deployment Descriptors

We can deploy our application using the [icegridadmin command line utility](#), but first we must define our descriptors in XML. The descriptors are quite brief:

XML

```

<icegrid>
  <application name="Ripper">
    <node name="Node1">
      <server id="EncoderServer" exe="/opt/ripper/bin/server"
activation="on-demand">
        <adapter name="EncoderAdapter" id="EncoderAdapter"
endpoints="tcp"/>
      </server>
    </node>
  </application>
</icegrid>

```

For IceGrid's purposes, we have named our application `Ripper`. It consists of a single server, `EncoderServer`, assigned to the node `Node1`.

 Since a computer typically runs only one node process, you might be tempted to give the node a name that identifies its host (such as `ComputeServerNode`). However, this naming convention becomes problematic as soon as you need to migrate the node to another host.

The server's `exe` attribute supplies the pathname of its executable, and the `activation` attribute indicates that the server should be activated on demand when necessary.

The object adapter's descriptor is the most interesting. As you can see, the `name` and `id` attributes both specify the value `EncoderAdapter`. The value of `name` reflects the adapter's name in the server process (i.e., the argument passed to `createObjectAdapter`) that is used for configuration purposes, whereas the value of `id` uniquely identifies the adapter within the registry and is used in indirect proxies. These attributes are not required to have the same value. Had we omitted the `id` attribute, IceGrid would have composed a unique value by combining the server name and adapter name to produce the following identifier:

```
EncoderServer.EncoderAdapter
```

The `endpoints` attribute defines one or more `endpoints` for the adapter. As explained earlier, these endpoints do not require a fixed port.

Refer to the [XML reference](#) for detailed information on using XML to define descriptors.

Ripper Registry and Node Configuration

In our [initial registry configuration](#), we created the directory `/opt/ripper/registry` for use by the registry. The node also needs a subdirectory for its own purposes, so we will use `/opt/ripper/node`. Again, these directories must exist before starting the registry and node.

We also need to create an Ice configuration file to hold [properties](#) required by the registry and node. The file `/opt/ripper/config` contains the following properties:

```

# Registry properties
IceGrid.Registry.Client.Endpoints=tcp -p 4061
IceGrid.Registry.Server.Endpoints=tcp
IceGrid.Registry.Internal.Endpoints=tcp
IceGrid.Registry.AdminPermissionsVerifier=IceGrid/NullPermissionsVerifi
er
IceGrid.Registry.Data=/opt/ripper/registry

# Node properties
IceGrid.Node.Endpoints=tcp
IceGrid.Node.Name=Node1
IceGrid.Node.Data=/opt/ripper/node
IceGrid.Node.CollocateRegistry=1
Ice.Default.Locator=IceGrid/Locator:tcp -p 4061

```

The registry and node can share this configuration file. In fact, by enabling `IceGrid.Node.CollocateRegistry`, we have indicated that the registry and node should run in the same process.

One difference from our [initial configuration](#) is that we no longer define `IceGrid.Registry.DynamicRegistration`. By omitting this property, we force the registry to reject the registration of object adapters that have not been deployed.

The node properties are explained below:

- `IceGrid.Node.Endpoints`
This property specifies the node's endpoints. A fixed port is not required.
- `IceGrid.Node.Name`
This property defines the unique name for this node. Its value must match the descriptor we wrote above.
- `IceGrid.Node.Data`
This property specifies the node's data directory.
- `Ice.Default.Locator`
This property is defined for use by the `icegridadmin` tool. The node would also require this property if the registry is not collocated. Refer to our discussion of the [ripper client configuration](#) for more information on this setting.

Ripper Server Configuration using Deployment

Server configuration is accomplished using descriptors. During deployment, the node creates a subdirectory tree for each server. Inside this tree the node creates a configuration file containing properties derived from the server's descriptors. For instance, the adapter's [descriptor](#) generates the following properties in the server's configuration file:

```

# Server configuration
Ice.Admin.ServerId=EncoderServer
Ice.Admin.Endpoints=tcp -h 127.0.0.1
Ice.ProgramName=EncoderServer
# Object adapter EncoderAdapter
EncoderAdapter.Endpoints=tcp
EncoderAdapter.AdapterId=EncoderAdapter
Ice.Default.Locator=IceGrid/Locator:default -p 4061

```

As you can see, the configuration file that IceGrid generates from the descriptor resembles the [initial configuration](#), with two additional properties:

- `Ice.Admin.ServerId`
- `Ice.Admin.Endpoints`

These properties enable the [administrative facility](#) that, among other features, allows an IceGrid node to gracefully deactivate the server.

Using the directory structure we established for our ripper application, the configuration file for `EncoderServer` has the file name shown below:

```
/opt/ripper/node/servers/EncoderServer/config/config
```

Note that this file should not be edited directly because any changes you make are lost the next time the node regenerates the file. The correct way to add properties to the file is to include property definitions in the server's descriptor. For example, we can add the property `Ice.Trace.Network=1` by modifying the server descriptor as follows:

```
<icegrid>
  <application name="Ripper">
    <node name="Node1">
      <server id="EncoderServer" exe="/opt/ripper/bin/server"
activation="on-demand">
        <adapter name="EncoderAdapter" id="EncoderAdapter"
endpoints="tcp"/>
        <property name="Ice.Trace.Network" value="1"/>
      </server>
    </node>
  </application>
</icegrid>
```

When a node activates a server, it passes the location of the server's configuration file using the `--Ice.Config` command-line argument. If you start a server manually from a command prompt, you must supply this argument yourself.

Starting the Node for the Ripper Application

Now that the configuration file is written and the directory structure is prepared, we are ready to start the IceGrid registry and node. Using a collocated registry and node, we only need to use one command:

```
$ icegridnode --Ice.Config=/opt/ripper/config
```

Additional [command line options](#) are supported, including those that allow the node to run as a Windows service or Unix daemon.

Deploying the Ripper Application

With the registry up and running, it is now time to deploy our application. Like our client, the `icegridadmin` utility also requires a definition for the `Ice.Default.Locator` property. We can start the utility with the following command:

```
$ icegridadmin --Ice.Config=/opt/ripper/config
```

After confirming that it can contact the registry, `icegridadmin` provides a command prompt at which we deploy our application. Assuming our descriptor is stored in `/opt/ripper/app.xml`, the deployment command is shown below:

```
>>> application add "/opt/ripper/app.xml"
```

Next, confirm that the application has been deployed:

```
>>> application list
Ripper
```

You can start the server using this command:

```
>>> server start EncoderServer
```

Finally, you can retrieve the current endpoints of the object adapter:

```
>>> adapter endpoints EncoderAdapter
```

If you want to experiment further using `icegridadmin`, issue the `help` command and review the [available commands](#).

Ripper Progress Review

We have deployed our first IceGrid application, but you might be questioning whether it was worth the effort. Even at this early stage, we have already gained several benefits:

- We no longer need to manually start the encoder server before starting the client, because the IceGrid node automatically starts it if it is not active at the time a client needs it. If the server happens to terminate for any reason, such as an IceGrid administrative action or a server programming error, the node restarts it without intervention on our part.
- We can manage the application remotely using one of the IceGrid administration tools. The ability to remotely modify applications, start and stop servers, and inspect every aspect of your configuration is a significant advantage.

Admittedly, we have not made much progress yet in our stated goal of improving the performance of the ripper over alternative solutions that are restricted to running on a single computer. Our client now has the ability to easily delegate the encoding task to a server running on another computer, but we have not achieved the parallelism that we really need. For example, if the client created a number of encoders and used them simultaneously from multiple threads, the encoding performance might actually be *worse* than simply encoding the data directly in the client, as the remote computer would likely slow to a crawl while attempting to task-switch among a number of processor-intensive tasks.

Adding Nodes to the Ripper Application

Adding more nodes to our environment would allow us to distribute the encoding load to more compute servers. Using the techniques we have learned so far, let us investigate the impact that adding a node would have on our descriptors, configuration, and client application.

Descriptor Changes

The addition of a node is mainly an exercise in cut and paste:

XML

```

<icegrid>
  <application name="Ripper">
    <node name="Node1">
      <server id="EncoderServer1" exe="/opt/ripper/bin/server"
activation="on-demand">
        <adapter name="EncoderAdapter" endpoints="tcp"/>
      </server>
    </node>
    <node name="Node2">
      <server id="EncoderServer2" exe="/opt/ripper/bin/server"
activation="on-demand">
        <adapter name="EncoderAdapter" endpoints="tcp"/>
      </server>
    </node>
  </application>
</icegrid>

```

Note that we now have two `node` elements instead of a single one. You might be tempted to simply use the host name as the node name. However, in general, that is not a good idea. For example, you may want to run several IceGrid nodes on a single machine (for example, for testing). Similarly, you may have to rename a host at some point, or need to migrate a node to a different host. But, unless you also rename the node, that leads to the situation where you have a node with the name of a (possibly obsolete) host when the node in fact is not running on that host. Obviously, this makes for a confusing configuration — it is better to use abstract node names, such as `Node1`.

Aside from the new `node` element, notice that the server identifiers must be unique. The adapter name, however, can remain as `EncoderAdapter` because this name is used only for local purposes within the server process. In fact, using a different name for each adapter would actually complicate the server implementation, since it would somehow need to discover the name it should use when creating the adapter.

We have also removed the `id` attribute from our adapter descriptors; the [default values](#) supplied by IceGrid are sufficient for our purposes.

Configuration Changes

We can continue to use the configuration file we created [earlier](#) for our combined registry-node process. We need a separate configuration file for `Node2`, primarily to define a different value for the property `IceGrid.Node.Name`. However, we also cannot have two nodes configured with `IceGrid.Node.CollocateRegistry` because only one master registry is allowed, so we must remove this property:

```

IceGrid.Node.Endpoints=tcp
IceGrid.Node.Name=Node2
IceGrid.Node.Data=/opt/ripper/node

Ice.Default.Locator=IceGrid/Locator:tcp -h registryhost -p 4061

```

We assume that `/opt/ripper/node` refers to a local file system directory on the computer hosting `Node2`, and not a shared volume, because two nodes must not share the same data directory.

We have also modified the locator proxy to include the address of the host on which the registry is running.

Redeploying the Application

After saving the new descriptors, you need to redeploy the application. Using `icegridadmin`, issue the following command:

```
$ icegridadmin --Ice.Config=/opt/ripper/config
>>> application update "/opt/ripper/app.xml"
```

If an update affects any of the application's servers that are currently running, IceGrid automatically stops those servers prior to performing the update and restarts them again after the update is complete. We can determine whether an update would require any restarts using the `application diff` command:

```
$ icegridadmin --Ice.Config=/opt/ripper/config
>>> application diff --servers "/opt/ripper/app.xml"
```

To ensure that our update does not impact any active servers, we can use the `--no-restart` option:

```
$ icegridadmin --Ice.Config=/opt/ripper/config
>>> application update --no-restart "/opt/ripper/app.xml"
```

With this option, the update would fail if any servers required a restart.

Client Changes

We have added a new node, but we still need to modify our client to take advantage of it. As it stands now, our client can delegate an encoding task to one of the two `MP3EncoderFactory` objects. The client selects a factory by using the appropriate indirect proxy:

- `factory@EncoderServer1.EncoderAdapter`
- `factory@EncoderServer2.EncoderAdapter`

In order to distribute the tasks among both factories, the client could use a random number generator to decide which factory receives the next task:

C++

```
string adapter;
if ((rand() % 2) == 0)
    adapter = "EncoderServer1.EncoderAdapter";
else
    adapter = "EncoderServer2.EncoderAdapter";
Ice::ObjectPrx proxy =
communicator->stringToProxy("factory@" + adapter);
Ripper::MP3EncoderFactoryPrx factory =
Ripper::MP3EncoderFactoryPrx::checkedCast(proxy);
Ripper::MP3EncoderPrx encoder = factory->createEncoder();
```

There are a few disadvantages in this design:

- The client application must be modified each time a new compute server is added or removed because it knows all of the adapter identifiers.
- The client cannot distribute the load intelligently; it is just as likely to assign a task to a heavily-loaded computer as it is an idle one.

We describe better solutions in the sections that follow.

See Also

- [IceGrid Server Activation](#)
- [Creating an Object Adapter](#)
- [Object Adapter Endpoints](#)
- [Getting Started with IceGrid](#)
- [icegridadmin Command Line Tool](#)
- [IceGrid and the Administrative Facility](#)
- [icegridnode](#)
- [Adapter Descriptor Element](#)
- [IceGrid Properties](#)

Well-Known Objects

On this page:

- [Overview of Well-Known Objects](#)
- [Well-Known Object Types](#)
- [Deploying Well-Known Objects](#)
- [Adding Well-Known Objects Programmatically](#)
- [Adding Well-Known Objects with `icegridadmin`](#)
- [Querying Well-Known Objects](#)
- [Using Well-Known Objects in the Ripper Application](#)
 - [Adding Well-Known Objects to the Ripper Deployment](#)
 - [Querying Ripper Objects with `findAllObjectsByType`](#)
 - [Querying Ripper Objects with `findObjectByType`](#)
 - [Querying Ripper Objects with `findObjectByTypeOnLeastLoadedNode`](#)
 - [Ripper Progress Review](#)

Overview of Well-Known Objects

There are two types of [indirect proxies](#): one specifies an identity and an object adapter identifier, while the other contains only an identity. The latter type of indirect proxy is known as a *well-known proxy*. A well-known proxy refers to a well-known object, that is, its identity alone is sufficient to allow the client to locate it. Ice requires all object identities in an application to be unique, but typically only a select few objects are able to be located only by their identities.

In earlier sections we showed the relationship between indirect proxies containing an object adapter identifier and the IceGrid configuration. Briefly, in order for a client to use a proxy such as `factory@EncoderAdapter`, an object adapter must be given the identifier `EncoderAdapter`.

A similar requirement exists for well-known objects. The registry maintains a table of these objects, which can be populated in a number of ways:

- statically in descriptors,
- programmatically using IceGrid's administrative interface,
- dynamically using an IceGrid administration tool.

The registry's database maps an object identity to a proxy. A locate request containing only an identity prompts the registry to consult this database. If a match is found, the registry examines the associated proxy to determine if additional work is necessary. For example, consider the well-known objects in the following table.

Identity	Proxy
Object1	Object1:tcp -p 10001
Object2	Object2@TheAdapter
Object3	Object3

The proxy associated with `Object1` already contains endpoints, so the registry can simply return this proxy to the client.

For `Object2`, the registry notices the adapter ID and checks to see whether it knows about an adapter identified as `TheAdapter`. If it does, it attempts to obtain the endpoints of that adapter, which may cause its server to be started. If the registry is successfully able to determine the adapter's endpoints, it returns a direct proxy containing those endpoints to the client. If the registry does not recognize `TheAdapter` or cannot obtain its endpoints, it returns the indirect proxy `Object2@TheAdapter` to the client. Upon receipt of another indirect proxy, the Ice run time in the client will try once more to resolve the proxy, but generally this will not succeed and the Ice run time in the client will raise a `NoEndpointException` as a result.

Finally, `Object3` represents a hopeless situation: how can the registry resolve `Object3` when its associated proxy refers to itself? In this case, the registry returns the proxy `Object3` to the client, which causes the client to raise `NoEndpointException`. Clearly, you should avoid this situation.

Well-Known Object Types

The registry's database not only associates an identity with a proxy, but also a type. Technically, the "type" is an arbitrary string but, by convention, that string represents the most-derived Slice type of the object. For example, the Slice [type ID](#) of the encoder factory in our ripper application is `::Ripper::MP3EncoderFactory`.

Object types are useful when performing [queries](#).

Deploying Well-Known Objects

The [object descriptor](#) adds a well-known object to the registry. It must appear within the context of an adapter descriptor, as shown in the XML example below:

XML
<pre> <icegrid> <application name="Ripper"> <node name="Node1"> <server id="EncoderServer" exe="/opt/ripper/bin/server" activation="on-demand"> <adapter name="EncoderAdapter" id="EncoderAdapter" endpoints="tcp"> <object identity="EncoderFactory" type="::Ripper::MP3EncoderFactory"/> </adapter> </server> </node> </application> </icegrid> </pre>

During deployment, the registry associates the identity `EncoderFactory` with the indirect proxy `EncoderFactory@EncoderAdapter`. If the adapter descriptor had omitted the adapter ID, the registry would have generated a unique identifier by combining the server ID and the adapter name.

In this example, the object's [type](#) is specified explicitly.

Adding Well-Known Objects Programmatically

The `IceGrid::Admin` interface defines several operations that manipulate the registry's database of well-known objects:

Slice

```

module IceGrid {
interface Admin {
    ...
    void addObject(Object* obj)
        throws ObjectExistsException,
            DeploymentException;
    void updateObject(Object* obj)
        throws ObjectNotRegisteredException,
            DeploymentException;
    void addObjectWithType(Object* obj, string type)
        throws ObjectExistsException,
            DeploymentException;
    void removeObject(Ice::Identity id)
        throws ObjectNotRegisteredException,
            DeploymentException;
    ...
};
};

```

- **addObject**
The `addObject` operation adds a new object to the database. The proxy argument supplies the identity of the well-known object. If an object with the same identity has already been registered, the operation raises `ObjectExistsException`. Since this operation does not accept an argument supplying the object's type, the registry invokes `ice_id` on the given proxy to determine its most-derived type. The implication here is that the object must be available in order for the registry to obtain its type. If the object is not available, `addObject` raises `DeploymentException`.
- **updateObject**
The `updateObject` operation supplies a new proxy for the well-known object whose identity is encapsulated by the proxy. If no object with the given identity is registered, the operation raises `ObjectNotRegisteredException`. The object's type is not modified by this operation.
- **addObjectWithType**
The `addObjectWithType` operation behaves like `addObject`, except the object's type is specified explicitly and therefore the registry does not attempt to invoke `ice_id` on the given proxy (even if the type is an empty string).
- **removeObject**
The `removeObject` operation removes the well-known object with the given identity from the database. If no object with the given identity is registered, the operation raises `ObjectNotRegisteredException`.

The following C++ example produces the same result as the [descriptor](#) we deployed earlier:

C++

```

Ice::ObjectAdapterPtr adapter =
communicator->createObjectAdapter("EncoderAdapter");
Ice::Identity ident = communicator->stringToIdentity("EncoderFactory");
FactoryPtr f= new FactoryI;
Ice::ObjectPrx factory = adapter->add(f, ident);
IceGrid::AdminPrx admin = // ...
try {
    admin->addObject(factory); // OOPS!
} catch (const IceGrid::ObjectExistsException &) {
    admin->updateObject(factory);
}

```

After obtaining a proxy for the `IceGrid::Admin` interface, the code invokes `addObject`. Notice that the code traps `ObjectExistsException` and calls `updateObject` instead when the object is already registered.

There is one subtle problem in this code: calling `addObject` causes the registry to invoke `ice_id` on our factory object, but we have not yet activated the object adapter. As a result, our program will hang indefinitely at the call to `addObject`. One solution is to activate the adapter prior to the invocation of `addObject`; another solution is to use `addObjectWithType` as shown below:

C++

```

Ice::ObjectAdapterPtr adapter =
communicator->createObjectAdapter("EncoderAdapter");
Ice::Identity ident = communicator->stringToIdentity("EncoderFactory");
FactoryPtr f = new FactoryI;
Ice::ObjectPrx factory = adapter->add(f, ident);
IceGrid::AdminPrx admin = // ...
try {
    admin->addObjectWithType(factory, factory->ice_id());
} catch (const IceGrid::ObjectExistsException &) {
    admin->updateObject(factory);
}

```

Adding Well-Known Objects with `icegridadmin`

The `icegridadmin` utility provides commands that are the functional equivalents of the Slice operations for managing well-known objects. We can use the utility to manually register the `EncoderFactory` object from our `descriptors`:

```

$ icegridadmin --Ice.Config=/opt/ripper/config
>>> object add "EncoderFactory@EncoderAdapter"

```

Use the `object list` command to verify that the object was registered successfully:

```
>>> object list
EncoderFactory
IceGrid/Query
IceGrid/Locator
IceGrid/Registry
IceGrid/InternalRegistry-Master
```

To specify the object's type explicitly, append it to the `object add` command:

```
>>> object add "EncoderFactory@EncoderAdapter"
":Ripper::MP3EncoderFactory"
```

Finally, the object is removed from the registry like this:

```
>>> object remove "EncoderFactory"
```

Querying Well-Known Objects

The registry's database of well-known objects is not used solely for resolving indirect proxies. The database can also be queried interactively to find objects in a variety of ways. The `IceGrid::Query` interface supplies this functionality:

Slice
<pre>module IceGrid { enum LoadSample { LoadSample1, LoadSample5, LoadSample15 }; interface Query { idempotent Object* findObjectById(Ice::Identity id); idempotent Object* findObjectByType(string type); idempotent Object* findObjectByTypeOnLeastLoadedNode(string type, LoadSample sample); idempotent Ice::ObjectProxySeq findAllObjectsByType(string type); idempotent Ice::ObjectProxySeq findAllReplicas(Object* proxy); }; };</pre>

- `findObjectById`
The `findObjectById` operation returns the proxy associated with the given identity of a well-known object. It returns a null proxy if no match was found.
- `findObjectByType`

The `findObjectByType` operation returns a proxy for an object registered with the given type. If more than one object has the same type, the registry selects one at random. The operation returns a null proxy if no match was found.

- `findObjectByTypeOnLeastLoadedNode`

The `findObjectByTypeOnLeastLoadedNode` operation considers the system load when selecting one of the objects with the given type. If the registry is unable to determine which node hosts an object (for example, because the object was registered with a direct proxy and not an adapter ID), the object is considered to have a load value of 1 for the purposes of this operation. The `sample` argument determines the interval over which the loads are averaged (one, five, or fifteen minutes). The operation returns a null proxy if no match was found.

- `findAllObjectsByType`

The `findAllObjectsByType` operation returns a sequence of proxies representing the well-known objects having the given type. The operation returns an empty sequence if no match was found.

- `findAllReplicas`

Given an indirect proxy for a replicated object, the `findAllReplicas` operation returns a sequence of proxies representing the individual replicas. An application can use this operation when it is necessary to communicate directly with one or more replicas.

Be aware that the operations accepting a `type` parameter are not equivalent to invoking `ice_isA` on each object to determine whether it supports the given type, a technique that would not scale well for a large number of registered objects. Rather, the operations simply compare the given type to the object's `registered type` or, if the object was registered without a type, to the object's most-derived Slice type as determined by the registry.

Using Well-Known Objects in the Ripper Application

Well-known objects are another IceGrid feature we can incorporate into our ripper application.

Adding Well-Known Objects to the Ripper Deployment

First we'll modify the `descriptors` to add two well-known objects:

XML

```

<icegrid>
  <application name="Ripper">
    <node name="Node1">
      <server id="EncoderServer1" exe="/opt/ripper/bin/server"
activation="on-demand">
        <adapter name="EncoderAdapter" endpoints="tcp">
          <object identity="EncoderFactory1"
type="::Ripper::MP3EncoderFactory"/>
        </adapter>
      </server>
    </node>
    <node name="Node2">
      <server id="EncoderServer2" exe="/opt/ripper/bin/server"
activation="on-demand">
        <adapter name="EncoderAdapter" endpoints="tcp">
          <object identity="EncoderFactory2"
type="::Ripper::MP3EncoderFactory"/>
        </adapter>
      </server>
    </node>
  </application>
</icegrid>

```

At first glance, the addition of the well-known objects does not appear to simplify our client very much. Rather than selecting which of the two adapters receives the next task, we now need to select one of the well-known objects.

Querying Ripper Objects with `findAllObjectsByType`

The `IceGrid::Query` interface provides a way to eliminate the client's dependency on object adapter identifiers and object identities. Since our factories are registered with the same type, we can search for all objects of that type:

C++

```

Ice::ObjectPrx proxy = communicator->stringToProxy("IceGrid/Query");
IceGrid::QueryPrx query = IceGrid::QueryPrx::checkedCast(proxy);
Ice::ObjectProxySeq seq;
string type = Ripper::MP3EncoderFactory::ice_staticId();
seq = query->findAllObjectsByType(type);
if (seq.empty()) {
  // no match
}
Ice::ObjectProxySeq::size_type index = ... // random number
Ripper::MP3EncoderFactoryPrx factory =
Ripper::MP3EncoderFactoryPrx::checkedCast(seq[index]);
Ripper::MP3EncoderPrx encoder = factory->createEncoder();

```

This example invokes `findAllObjectsByType` and then randomly selects an element of the sequence.

Querying Ripper Objects with `findObjectByType`

We can simplify the client further using `findObjectByType` instead, which performs the randomization for us:

```

C++
Ice::ObjectPrx proxy = communicator->stringToProxy("IceGrid/Query");
IceGrid::QueryPrx query = IceGrid::QueryPrx::checkedCast(proxy);
Ice::ObjectPrx obj;
string type = Ripper::MP3EncoderFactory::ice_staticId();
obj = query->findObjectByType(type);
if (!obj) {
    // no match
}
Ripper::MP3EncoderFactoryPrx factory =
Ripper::MP3EncoderFactoryPrx::checkedCast(obj);
Ripper::MP3EncoderPrx encoder = factory->createEncoder();
```

Querying Ripper Objects with `findObjectByTypeOnLeastLoadedNode`

So far the use of `IceGrid::Query` has allowed us to simplify our client, but we have not gained any functionality. If we replace the call to `findObjectByType` with `findObjectByTypeOnLeastLoadedNode`, we can improve the client by distributing the encoding tasks more intelligently. The change to the client's code is trivial:

```

C++
Ice::ObjectPrx proxy = communicator->stringToProxy("IceGrid/Query");
IceGrid::QueryPrx query = IceGrid::QueryPrx::checkedCast(proxy);
Ice::ObjectPrx obj;
string type = Ripper::MP3EncoderFactory::ice_staticId();
obj = query->findObjectByTypeOnLeastLoadedNode(type,
    IceGrid::LoadSample1);
if (!obj) {
    // no match
}
Ripper::MP3EncoderFactoryPrx factory =
Ripper::MP3EncoderFactoryPrx::checkedCast(obj);
Ripper::MP3EncoderPrx encoder = factory->createEncoder();
```

Ripper Progress Review

Incorporating intelligent load distribution is a worthwhile enhancement and is a capability that would be time consuming to implement ourselves. However, our current design uses only well-known objects in order to make queries possible. We do not really need the encoder factory object on each compute server to be individually addressable as a well-known object, a fact that seems clear when we examine the identities we assigned to them: `EncoderFactory1`, `EncoderFactory2`, and so on. IceGrid's [replication features](#) give us the tools we need to improve our design.

See Also

- Terminology
- Type IDs
- Object Descriptor Element
- IceGrid Administrative Sessions
- icegridadmin Command Line Tool
- Object Adapter Replication

IceGrid Templates

IceGrid templates simplify the task of creating the descriptors for an application. A template is a parameterized descriptor that you can instantiate as often as necessary, and they are descriptors in their own right. Templates are components of an IceGrid application and therefore they are stored in the registry's database. As such, their use is not restricted to XML files; templates can also be created and instantiated interactively using the [graphical administration tool](#).

You can define templates for server and service descriptors. The focus of this section is server templates; we discuss service descriptors and templates in the context of [IceBox integration](#).

On this page:

- [Server Templates](#)
- [Template Parameters](#)
- [Adding Properties to a Server Instance](#)
- [Default Templates](#)
- [Using Templates with `icegridadmin`](#)

Server Templates

You may recall from a [previous example](#) that the XML description of our sample application defined two nearly identical servers:

XML
<pre> <icegrid> <application name="Ripper"> <node name="Node1"> <server id="EncoderServer1" exe="/opt/ripper/bin/server" activation="on-demand"> <adapter name="EncoderAdapter" endpoints="tcp"/> </server> </node> <node name="Node2"> <server id="EncoderServer2" exe="/opt/ripper/bin/server" activation="on-demand"> <adapter name="EncoderAdapter" endpoints="tcp"/> </server> </node> </application> </icegrid> </pre>

This example is an excellent candidate for a server template. Equivalent definitions that incorporate a template are shown below:

XML

```

<icegrid>
  <application name="Ripper">
    <server-template id="EncoderServerTemplate">
      <parameter name="index"/>
      <server id="EncoderServer${index}"
exe="/opt/ripper/bin/server" activation="on-demand">
        <adapter name="EncoderAdapter" endpoints="tcp"/>
      </server>
    </server-template>
    <node name="Node1">
      <server-instance template="EncoderServerTemplate"
index="1"/>
    </node>
    <node name="Node2">
      <server-instance template="EncoderServerTemplate"
index="2"/>
    </node>
  </application>
</icegrid>

```

We have defined a [server template](#) named `EncoderServerTemplate`. Nested within the `server-template` element is a [server descriptor](#) that defines an encoder server. The only difference between this `server` element and our previous example is that it is now parameterized: the template parameter `index` is used to form unique identifiers for the server and its adapter. The symbol `${index}` is replaced with the value of the `index` parameter wherever it occurs.

The template is instantiated by a `server-instance` element, which may be used anywhere that a `server` element is used. The [server instance descriptor](#) identifies the template to be instantiated, and supplies a value for the `index` parameter.

Although we have not significantly reduced the length of our XML file, we have made it more readable. And more importantly, deploying this server on additional nodes has become much easier.

Template Parameters

Parameters enable you to customize each instance of a template as necessary. The example [above](#) defined the `index` parameter with a different value for each instance to ensure that identifiers are unique. A parameter may also declare a default value that is used in the template if no value is specified for it. In our sample application the `index` parameter is considered mandatory and therefore should not have a default value, but we can illustrate this feature in another way. For example, suppose that the path name of the server's executable may change on each node. We can supply a default value for this attribute and override it when necessary:

XML

```

<icegrid>
  <application name="Ripper">
    <server-template id="EncoderServerTemplate">
      <parameter name="index"/>
      <parameter name="exepath" default="/opt/ripper/bin/server"/>
      <server id="EncoderServer${index}" exe="${exepath}"
activation="on-demand">
        <adapter name="EncoderAdapter" endpoints="tcp"/>
      </server>
    </server-template>
    <node name="Node1">
      <server-instance template="EncoderServerTemplate"
index="1"/>
    </node>
    <node name="Node2">
      <server-instance template="EncoderServerTemplate" index="2"
exepath="/opt/ripper-test/bin/server"/>
    </node>
  </application>
</icegrid>

```

As you can see, the instance on `Node1` uses the default value for the new parameter `exepath`, but the instance on `Node2` defines a different location for the server's executable.

Understanding the semantics of [descriptor variables and parameters](#) will help you add flexibility to your own IceGrid applications.

Adding Properties to a Server Instance

As we saw in the preceding section, template parameters allow you to customize each instance of a server template, and template parameters with default values allow you to define commonly used configuration options. However, you might want to have additional configuration properties for a given instance without having to add a parameter. For example, to debug a server instance on a specific node, you might want to start the server with the `Ice.Trace.Network` property set; it would be inconvenient to have to add a parameter to the template just to set that property.

To cater for such scenarios, it is possible to specify additional properties for a server instance without modifying the template. You can define such properties in the `server-instance` element, for example:

XML

```

<icegrid>
  <application>
    ...
    <node name="Node2">
      <server-instance template="EncoderServerTemplate"
index="2">
        <properties>
          <property name="Ice.Trace.Network" value="2"/>
        </properties>
      </server-instance>
    </node>
  </application>
</icegrid>

```

This sets the `Ice.Trace.Network` property for a specific server.

Default Templates

The IceGrid registry can be configured to supply any number of default template descriptors for use in your applications. The configuration property `IceGrid.Registry.DefaultTemplates` specifies the path name of an XML file containing template definitions. One such template file is provided in the Ice distribution as `config/templates.xml`, which contains helpful templates for deploying Ice services such as `IcePatch2` and `Glacier2`.

The template file must use the structure shown below:

XML

```

<icegrid>
  <application name="DefaultTemplates">
    <server-template id="EncoderServerTemplate">
      ...
    </server-template>
  </application>
</icegrid>

```

The name you give to the application is not important, and you may only define `server` and `service` templates within it. After configuring the registry to use this file, your default templates become available to every application that imports them.

The descriptor for each application indicates whether the default templates should be imported. (By default they are not imported.) If the templates are imported, they are essentially copied into the application descriptor and treated no differently than templates defined by the application itself. As a result, changes to the file containing default templates have no effect on existing application descriptors. In XML, the attribute `import-default-templates` determines whether the default templates are imported, as shown in the following example:

XML

```
<icegrid>
  <application name="Ripper" import-default-templates="true">
    ...
  </application>
</icegrid>
```

Using Templates with `icegridadmin`

The `IceGrid` administration tools allow you to inspect templates and instantiate new servers dynamically. First, let us ask `icegridadmin` to describe the server template we created earlier:

```
$ icegridadmin --Ice.Config=/opt/ripper/config
>>> server template describe Ripper EncoderServerTemplate
```

This command generates the following output:

```
server template `EncoderServerTemplate`
{
  parameters = `index exepath`
  server `EncoderServer${index}`
  {
    exe = `${exepath}`
    activation = `on-demand`
    properties
    {
      EncoderAdapter.Endpoints = `tcp`
    }
    adapter `EncoderAdapter`
    {
      id = `EncoderAdapter${index}`
      replica group id =
      endpoints = `tcp`
      register process = `false`
      server lifetime = `true`
    }
  }
}
```

Notice that the server ID is a parameterized value; it cannot be evaluated until the template is instantiated with values for its parameters.

Next, we can use `icegridadmin` to create an instance of the encoder server template on a new node:

```
>>> server template instantiate Ripper Node3 EncoderServerTemplate  
index=3
```

The command requires that we identify the application, node and template, as well as supply any parameters needed by the template. The new server instance is permanently added to the registry's database, but if we intend to keep this configuration it is a good idea to update the XML description of our application to reflect these changes and avoid potential synchronization issues.

See Also

- [Server Descriptor Element](#)
- [Server-Template Descriptor Element](#)
- [Server-Instance Descriptor Element](#)
- [icegridadmin Command Line Tool](#)

IceBox Integration with IceGrid

IceGrid makes it easy to configure an [IceBox](#) server with one or more services.

On this page:

- [Deploying an IceBox Server](#)
- [Service Templates](#)
- [Advanced Service Templates](#)

Deploying an IceBox Server

An IceBox server shares many of the same characteristics as other servers, but its special requirements necessitate a new [descriptor](#). Unlike other servers, an IceBox server generally hosts multiple independent services, each requiring its own communicator instance and configuration file.

As an example, the following application deploys an IceBox server containing one service:

XML
<pre> <icegrid> <application name="IceBoxDemo"> <node name="Node"> <icebox id="IceBoxServer" exe="/opt/Ice/bin/icebox" activation="on-demand"> <service name="ServiceA" entry="servicea:create"> <adapter name="{service}" endpoints="tcp"/> </service> </icebox> </node> </application> </icegrid> </pre>

It looks very similar to a server descriptor. The most significant difference is the [service descriptor](#), which is constructed much like a server in that you can declare its attributes such as object adapters and configuration properties. The order in which services are defined determines the order in which they are loaded by the IceBox server.

The value of the adapter's `name` attribute needs additional explanation. The symbol `service` is one of the names [reserved by IceGrid](#). In the context of a service descriptor, `{service}` is replaced with the service's name, and so the object adapter is also named `ServiceA`.

Service Templates

If you are familiar with [templates](#) in general, an IceBox [service template](#) is readily understandable:

XML

```

<icegrid>
  <application name="IceBoxApp">
    <service-template id="ServiceTemplate">
      <parameter name="name"/>
      <service name="${name}" entry="DemoService:create">
        <adapter name="${service}" endpoints="default"/>
        <property name="${service}.Identity"
value="${server}-${service}"/>
      </service>
    </service-template>
    <node name="Node1">
      <icebox id="IceBoxServer" endpoints="default"
exe="/opt/Ice/bin/icebox" activation="on-demand">
        <service-instance template="ServiceTemplate"
name="Service1"/>
      </icebox>
    </node>
  </application>
</icegrid>

```

In this application, an IceBox server is deployed on a node and has one service instantiated from the service template. Of particular interest is the `property` descriptor, which uses another `reserved name` `server` to form the property value. When the template is instantiated by the `service instance descriptor`, the symbol `${server}` is replaced with the name of the enclosing server, so the property definition expands as follows:

```
Service1.Identity=IceBoxServer-Service1
```

As with server instances, you can specify additional properties for the service instance without modifying the template. These properties can be defined in the `service-instance` element, as shown below:

XML

```
<icegrid>
  <application name="IceBoxApp">
    ...
    <node name="Node1">
      <icebox id="IceBoxServer" endpoints="default"
        exe="/opt/Ice/bin/icebox" activation="on-demand">
        <service-instance template="ServiceTemplate"
name="Service1">
          <properties>
            <property name="Ice.Trace.Network" value="1"/>
          </properties>
        </service-instance>
      </icebox>
    </node>
  </application>
</icegrid>
```

Advanced Service Templates

A more sophisticated use of templates involves instantiating a service template in a [server template](#):

XML

```

<icegrid>
  <application name="IceBoxApp">
    <service-template id="ServiceTemplate">
      <parameter name="name"/>
      <service name="{name}" entry="DemoService:create">
        <adapter name="{service}" endpoints="default"/>
        <property name="{name}.Identity"
value="{server}-{name}"/>
      </service>
    </service-template>
    <server-template id="ServerTemplate">
      <parameter name="id"/>
      <icebox id="{id}" endpoints="default"
exe="/opt/Ice/bin/icebox" activation="on-demand">
        <service-instance template="ServiceTemplate"
name="Service1"/>
      </icebox>
    </server-template>
    <node name="Node1">
      <server-instance template="ServerTemplate"
id="IceBoxServer"/>
    </node>
  </application>
</icegrid>

```

This application is equivalent to our first example of [service templates](#). Now, however, the process of deploying an identical server on several nodes has become much simpler.

If you need the ability to customize the configuration of a particular service instance, your server instance can define a [property set](#) that applies only to the desired service:

XML

```

<icegrid>
  <application name="IceBoxApp">
    <node name="Node1">
      <server-instance template="ServerTemplate"
id="IceBoxServer">
        <properties service="Service1">
          <property name="Ice.Trace.Network" value="1"/>
        </properties>
      </server-instance>
    </node>
  </application>
</icegrid>

```

As this example demonstrates, the `service` attribute of the property set denotes the name of the target service.

See Also

- [IceBox](#)
- [IceBox Descriptor Element](#)
- [Service Descriptor Element](#)
- [Service-Template Descriptor Element](#)
- [Server-Template Descriptor Element](#)
- [Properties Descriptor Element](#)
- [Using Descriptor Variables and Parameters](#)

Object Adapter Replication

As an implementation of an Ice location service, IceGrid supports [object adapter replication](#). An application defines its replica groups and their participating object adapters using descriptors, and IceGrid generates the server configurations automatically.

On this page:

- [Deploying a Replica Group](#)
- [Replica Group Membership](#)
- [Using Replica Groups in the Ripper Application](#)
 - [Adding a Replica Group to the Ripper Deployment](#)
 - [Using a Replica Group in the Ripper Client](#)

Deploying a Replica Group

The [descriptor](#) that defines a [replica group](#) can optionally declare [well-known objects](#) as well as configure the group to determine its behavior during locate requests. Consider this example:

XML
<pre> <icegrid> <application name="ReplicaApp"> <replica-group id="ReplicatedAdapter"> <object identity="TheObject" type="::Demo::ObjectType"/> </replica-group> <node name="Node"> <server id="ReplicaServer" activation="on-demand" exe="/opt/replica/bin/server"> <adapter name="TheAdapter" endpoints="default" replica-group="ReplicatedAdapter"/> </server> </node> </application> </icegrid> </pre>

The adapter's descriptor declares itself to be a member of the replica group `ReplicatedAdapter`, which must have been previously created by a replica group descriptor.

The replica group `ReplicatedAdapter` declares a well-known object so that an indirect proxy of the form `TheObject` is equivalent to the indirect proxy `TheObject@ReplicatedAdapter`. Since this trivial example defines only one adapter in the replica group, the proxy `TheObject` is also equivalent to `TheObject@TheAdapter`.

Replica Group Membership

An object adapter participates in a replica group by specifying the group's ID in the adapter's `ReplicaGroupId` configuration property. Identifying the replica group in the IceGrid descriptor for an object adapter causes the node to include the equivalent `ReplicaGroupId` property in the configuration file it generates for the server.

By default, the IceGrid registry requires the membership of a replica group to be statically defined. When you create a descriptor for an object adapter that identifies a replica group, the registry adds that adapter to the group's list of valid members. During an adapter's activation, when it describes its endpoints to the registry, an adapter that also claims membership in a replica group is validated against the registry's internal list.

In a properly configured IceGrid application, this activity occurs without incident, but there are situations in which validation can fail. For

example, adapter activation fails if an adapter's ID is changed without notifying the registry, such as by manually modifying the server configuration file that was generated by a node.

It is also possible for activation to fail when the IceGrid registry is being used solely as a location service, in which case descriptors have not been created and therefore the registry has no advance knowledge of the replica groups or their members. In this situation, adapter activation causes the server to receive `NotRegisteredException` unless the registry is configured to allow dynamic registration, which you can do by defining the following property:

```
IceGrid.Registry.DynamicRegistration=1
```

With this configuration, a replica group is created implicitly as soon as an adapter declares membership in it, and any adapter is allowed to participate.

The use of dynamic registration often leads to the accumulation of obsolete replica groups and adapters in the registry. The [IceGrid administration tools](#) allow you to inspect and clean up the registry's state.

Using Replica Groups in the Ripper Application

Replication is a perfect fit for the ripper application. The collection of encoder factory objects should be treated as a single logical object, and replication makes that possible.

Adding a Replica Group to the Ripper Deployment

Adding a replica group descriptor to our application is very straightforward:

XML

```

<icegrid>
  <application name="Ripper">
    <replica-group id="EncoderAdapters">
      <object identity="EncoderFactory"
type="::Ripper::MP3EncoderFactory"/>
    </replica-group>
    <server-template id="EncoderServerTemplate">
      <parameter name="index"/>
      <parameter name="exepath" default="/opt/ripper/bin/server"/>
      <server id="EncoderServer${index}" exe="${exepath}"
activation="on-demand">
        <adapter name="EncoderAdapter"
replica-group="EncoderAdapters"
        endpoints="tcp"/>
      </server>
    </server-template>
    <node name="Node1">
      <server-instance template="EncoderServerTemplate"
index="1"/>
    </node>
    <node name="Node2">
      <server-instance template="EncoderServerTemplate"
index="2"/>
    </node>
  </application>
</icegrid>

```

The new descriptor adds the replica group called `EncoderAdapters` and registers a well-known object with the identity `EncoderFactory`. The adapter descriptor in the server template has been changed to declare its membership in the replica group.

Using a Replica Group in the Ripper Client

In comparison to the examples that demonstrated [querying for well-known objects](#), the new version of our client has become much simpler:

```

Ice::ObjectPrx obj = communicator->stringToProxy("EncoderFactory");
Ripper::MP3EncoderFactoryPrx factory =
Ripper::MP3EncoderFactoryPrx::checkedCast(obj);
Ripper::MP3EncoderPrx encoder = factory->createEncoder();

```

The client no longer needs to use the `IceGrid::Query` interface, but simply creates a proxy for a well-known object and lets the Ice run time transparently interact with the location service. In response to a locate request for `EncoderFactory`, the registry returns a proxy containing the endpoints of both object adapters. The Ice run time in the client selects one of the endpoints at random, meaning we have now lost some functionality compared to the prior example in which system load was considered when selecting an endpoint. We will learn how to rectify this situation in our discussion of [load balancing](#).

See Also

- Terminology
- Replica-Group Descriptor Element
- Object Descriptor Element
- Well-Known Objects
- Load Balancing

Load Balancing

[Replication](#) is an important IceGrid feature but, when combined with load balancing, replication becomes even more useful.

IceGrid nodes regularly report the system load of their hosts to the registry. The replica group's configuration determines whether the registry actually considers system load information while processing a locate request. Its configuration also specifies how many replicas to include in the registry's response.

IceGrid's load balancing capability assists the client in obtaining an initial set of endpoints for the purpose of [establishing a connection](#). Once a client has established a connection, all subsequent requests on the proxy that initiated the connection are normally sent to the same server without further consultation with the registry. As a result, the registry's response to a locate request can only be viewed as a snapshot of the replicas at a particular moment. If system loads are important to the client, it must take steps to periodically contact the registry and [update its endpoints](#).

On this page:

- [Replica Group Load Balancing](#)
- [Load Balancing Types](#)
- [Using Load Balancing in the Ripper Application](#)
- [Interacting with Object Replicas](#)

Replica Group Load Balancing

A [replica group descriptor](#) optionally contains a [load balancing descriptor](#) that determines how system loads are used in locate requests. The load balancing descriptor specifies the following information:

- **Type**
Several [load balancing types](#) are supported.
- **Sampling interval**
One of the load balancing types considers system load statistics, which are reported by each node at regular intervals. The replica group can specify a sampling interval of one, five, or fifteen minutes. Choosing a sampling interval requires balancing the need for up-to-date load information against the desire to minimize transient spikes. On Unix platforms, the node reports the system's load average for the selected interval, while on Windows the node reports the CPU utilization averaged over the interval.
- **Number of replicas**
The replica group can instruct the registry to return the endpoints of one (the default) or more object adapters. If the specified number N is larger than one, the proxy returned in response to a locate request contains the endpoints of at most N object adapters. If N is 0, the proxy contains the endpoints of all the object adapters. The Ice run time in the client selects one of these endpoints at random when [establishing a connection](#).

For example, the descriptor shown below uses adaptive load balancing to return the endpoints of the two least-loaded object adapters sampled with five-minute intervals:

XML

```
<replica-group id="ReplicatedAdapter">
  <load-balancing type="adaptive" load-sample="5" n-replicas="2"/>
</replica-group>
```

The type must be specified, but the remaining attributes are optional.

 As of Ice 3.5, IceGrid ignores the object adapters of a [disabled server](#) when executing a locate request, meaning the client that initiated the locate request will not receive the endpoints for any of these object adapters.

Load Balancing Types

A replica group can select one of the following load balancing types:

- **Random**
Random load balancing selects the requested number of object adapters at random. The registry does not consider system load for a replica group with this type.
- **Adaptive**
Adaptive load balancing uses system load information to choose the least-loaded object adapters over the requested sampling interval. This is the only load balancing type that uses sampling intervals.
- **Round Robin**
Round robin load balancing returns the least recently used object adapters. The registry does not consider system load for a replica group with this type. Note that the round-robin information is not shared between registry replicas; each replica maintains its own notion of the "least recently used" object adapters.
- **Ordered**
Ordered load balancing selects the requested number of object adapters by priority. A priority can be set for each object adapter member of the replica group. If you define several object adapters with the same priority, IceGrid will order these object adapters according to their order of appearance in the descriptor.

Choosing the proper type of load balancing is highly dependent on the needs of client applications. Achieving the desired load balancing and fail-over behavior may also require the cooperation of your clients. To that end, it is very important that you understand how and when the Ice run time uses a [locator](#) to [resolve indirect proxies](#).

Using Load Balancing in the Ripper Application

The only change we need to make to the ripper application is the addition of a load balancing descriptor:

XML

```

<icegrid>
  <application name="Ripper">
    <replica-group id="EncoderAdapters">
      <load-balancing type="adaptive"/>
      <object identity="EncoderFactory"
type="::Ripper::MP3EncoderFactory"/>
    </replica-group>
    <server-template id="EncoderServerTemplate">
      <parameter name="index"/>
      <parameter name="exepath" default="/opt/ripper/bin/server"/>
      <server id="EncoderServer${index}" exe="${exepath}"
activation="on-demand">
        <adapter name="EncoderAdapter"
replica-group="EncoderAdapters"
        endpoints="tcp"/>
      </server>
    </server-template>
    <node name="Node1">
      <server-instance template="EncoderServerTemplate"
index="1"/>
    </node>
    <node name="Node2">
      <server-instance template="EncoderServerTemplate"
index="2"/>
    </node>
  </application>
</icegrid>

```

Using adaptive load balancing, we have regained the functionality we forfeited when we [introduced replica groups](#). Namely, we now select the object adapter on the least-loaded node, and no changes are necessary in the client.

Interacting with Object Replicas

In some applications you may have a need for interacting directly with the replicas of an object. For example, the application may want to implement a custom load-balancing strategy. In this situation you might be tempted to call `ice_getEndpoints` on the proxy of a replicated object in an effort to obtain the endpoints of all replicas, but that is not the correct solution because the proxy is indirect and therefore contains no endpoints. The proper approach is to [query well-known objects](#) using the `findAllReplicas` operation.

See Also

- [Object Adapter Replication](#)
- [Connection Establishment](#)
- [Replica-Group Descriptor Element](#)
- [Load-Balancing Descriptor Element](#)
- [Well-Known Objects](#)
- [IceGrid Troubleshooting](#)

Resource Allocation using IceGrid Sessions

IceGrid provides a resource allocation facility that coordinates access to the objects and servers of an IceGrid application. To allocate a resource for exclusive use, a client must first establish a session by authenticating itself with the IceGrid registry or a Glacier2 router, after which the client may reserve objects and servers that the application indicates are allocatable. The client should release the resource when it is no longer needed, otherwise IceGrid reclaims it when the client's session terminates or expires due to inactivity.

An allocatable server offers at least one allocatable object. The server is considered to be allocated when its first allocatable object is claimed, and is not released until all of its allocated objects are released. While the server is allocated by a client, no other clients can allocate its objects.

On this page:

- [Creating an IceGrid Session](#)
- [Controlling Access to IceGrid Sessions](#)
- [Allocating Objects with an IceGrid Session](#)
- [Allocating Servers with an IceGrid Session](#)
- [Security Considerations for Allocated Resources](#)
- [Deploying Allocatable Resources](#)
- [Using Resource Allocation in the Ripper Application](#)

Creating an IceGrid Session

A client must create an IceGrid session before it can allocate objects. If you have configured a Glacier2 router to use [IceGrid's session managers](#), the client's [router session](#) satisfies this requirement.

In the absence of Glacier2, an IceGrid client invokes `createSession` or `createSessionFromSecureConnection` on IceGrid's `Registry` interface to create a session:

Slice
<pre> module IceGrid { exception PermissionDeniedException { string reason; }; interface Registry { Session* createSession(string userId, string password) throws PermissionDeniedException; Session* createSessionFromSecureConnection() throws PermissionDeniedException; idempotent int getSessionTimeout(); }; }; </pre>

The `createSession` operation expects a username and password and returns a session proxy if the client is allowed to create a session. By default, IceGrid does not allow the creation of sessions. You must define the registry property `IceGrid.Registry.PermissionsVerifier` with the proxy of a permissions verifier object to [enable session creation](#) with `createSession`.

The `createSessionFromSecureConnection` operation does not require a username and password because it uses the credentials supplied by an SSL connection to authenticate the client. As with `createSession`, you must [enable session creation](#) by configuring the

proxy of a permissions verifier object so that clients can use `createSessionFromSecureConnection` to create a session. In this case, the property is `IceGrid.Registry.SSLPermissionsVerifier`.

To create a session, the client obtains the registry proxy by converting the well-known proxy string `"IceGrid/Registry"` to a proxy object with the communicator, downcasts the proxy to the `IceGrid::Registry` interface, and invokes on one of the operations. The sample code below demonstrates how to do it in C++; the code will look very similar in other language mappings.

C++

```
Ice::ObjectPrx base = communicator->stringToProxy("IceGrid/Registry");
IceGrid::RegistryPrx registry =
IceGrid::RegistryPrx::checkedCast(base);
string username = ...;
string password = ...;
IceGrid::SessionPrx session;
try {
    session = registry->createSession(username, password);
} catch (const IceGrid::PermissionDeniedException & ex) {
    cout << "permission denied:\n" << ex.reason << endl;
}
```



The identity of the registry object may change based on its configuration settings.

After creating the session, the client must keep it alive by periodically invoking its `keepAlive` operation. The session expires if the client does not invoke `keepAlive` within the configured timeout period, which can be obtained by calling the `getSessionTimeout` operation on the `Registry` interface.

If a session times out, or if the client explicitly terminates the session by invoking its `destroy` operation, IceGrid automatically releases all objects allocated using that session.

Controlling Access to IceGrid Sessions

As described above, you must configure the IceGrid registry with the proxy of at least one permissions verifier object to enable session creation:

- `IceGrid.Registry.PermissionsVerifier`
This property supplies the proxy of an object that implements the interface `Glacier2::PermissionsVerifier`. Defining this property allows clients to create sessions using `createSession`.
- `IceGrid.Registry.SSLPermissionsVerifier`
This property supplies the proxy of an object that implements the interface `Glacier2::SSLPermissionsVerifier`. Defining this property allows clients to create sessions using `createSessionFromSecureConnection`.

IceGrid supplies built-in permissions verifier objects:

- A null permissions verifier for TCP/IP. This object accepts any username and password and should only be used in a secure environment where no access control is necessary. You select this verifier object by defining the following configuration property:

```
IceGrid.Registry.PermissionsVerifier=<instance-name>/NullPermissionsVerifier
```

Note that you have to substitute the correct `instance name` for the object identity category.

- A null permissions verifier for SSL, analogous to the one for TCP/IP. You select this verifier object by defining the following configuration property:

```
IceGrid.Registry.SSLPermissionsVerifier=<instance-name>/NullSSLPer  
missionsVerifier
```

- A file-based permissions verifier. This object uses an access control list in a file that contains username-password pairs. The format of the password file is the same as the format of [Glacier2 password files](#). You enable this verifier implementation by defining the configuration property `IceGrid.Registry.CryptPasswords` with the pathname of the password file. Note that this property is ignored if you specify the proxy of a permissions verifier object using `IceGrid.Registry.PermissionsVerifier`.

You can also [implement your own permissions verifier object](#).

Allocating Objects with an IceGrid Session

A client allocates objects using the session proxy returned from `createSession` or `createSessionFromSecureConnection`. The proxy supports the `Session` interface shown below:

Slice

```

module IceGrid {
    exception ObjectNotRegisteredException {
        Ice::Identity id;
    };

    exception AllocationException {
        string reason;
    };

    exception AllocationTimeoutException
        extends AllocationException {
    };

    interface Session extends Glacier2::Session {

        idempotent void keepAlive();

        Object* allocateObjectById(Ice::Identity id)
            throws ObjectNotRegisteredException,
                AllocationException;

        Object* allocateObjectByType(string type)
            throws AllocationException;

        void releaseObject(Ice::Identity id)
            throws ObjectNotRegisteredException,
                AllocationException;

        idempotent void setAllocationTimeout(int timeout);
    };
};

```

The client is responsible for keeping the session alive by periodically invoking `keepAlive`, as discussed [earlier](#).

The `allocateObjectById` operation allocates and returns the proxy for the allocatable object with the given identity. If no allocatable object with the given identity is registered, the client receives `ObjectNotRegisteredException`. If the object cannot be allocated, the client receives `AllocationException`. An allocation attempt can fail for the following reasons:

- the object is already allocated by the session
- the object is allocated by another session and did not become available during the configured allocation timeout period
- the session was destroyed.

The `allocateObjectByType` operation allocates and returns a proxy for an allocatable object registered with the given type. If more than one allocatable object is registered with the given type, the registry selects one at random. The client receives `AllocationException` if no objects with the given type could be allocated. An allocation attempt can fail for the following reasons:

- no objects are registered with the given type
- all objects with the given type are already allocated (either by this session or other sessions) and none became available during the configured allocation timeout period
- the session was destroyed.

The `releaseObject` operation releases an object allocated by the session. The client receives `ObjectNotRegisteredException` if no allocatable object is registered with the given identity and `AllocationException` if the object is not allocated by the session. Upon session destruction, IceGrid automatically releases all allocated objects.

The `setAllocationTimeout` operation configures the timeout used by the allocation operations. If no allocatable objects are available when the client invokes `allocateObjectById` or `allocateObjectByType`, IceGrid waits for the specified timeout period for an allocatable object to become available. If the timeout expires, the client receives `AllocationTimeoutException`.

Allocating Servers with an IceGrid Session

A client does not need to explicitly allocate a server. If a server is allocatable, IceGrid implicitly allocates it to the first client that claims one of the server's allocatable objects. Likewise, IceGrid releases the server when all of its allocatable objects are released.

Server allocation is useful in two situations:

- Only allocatable servers can use the `session` activation mode, in which the server is activated on demand when allocated by a client and deactivated upon release.
- An allocatable server can be secured with IceSSL or Glacier2 so that its objects can only be invoked by the client that allocated it.

Security Considerations for Allocated Resources

IceGrid's resource allocation facility allows clients to coordinate access to objects and servers but does not place any restrictions on client invocations to allocated objects; any client that has a proxy for an allocated object could conceivably invoke an operation on it. IceGrid assumes that clients are cooperating with each other and respecting allocation semantics.

To prevent unauthorized clients from invoking operations on an allocated object or server, you can use [IceSSL](#) or [Glacier2](#):

- Using IceSSL, you can secure access to a server or a particular object adapter with the properties `IceSSL.TrustOnly.Server` or `IceSSL.TrustOnly.Server.AdapterName`. For example, if you configure a server with the session activation mode, you can set one of the `IceSSL.TrustOnly` properties to the `${session.id}` variable, which is substituted with the session ID when the server is activated for the session. If the IceGrid session was created from a secure connection, the session ID will be the distinguished name associated with the secure connection, which effectively restricts access to the server or one of its adapters to the client that established the session with IceGrid.
- With Glacier2, you can secure access to an allocated object or the object adapters of an allocated server with the Glacier2 [filtering mechanism](#). By default, IceGrid sessions created with a Glacier2 router are [automatically](#) given access to allocated objects, allocatable objects, certain well-known objects, and the object adapters of allocated servers.

Deploying Allocatable Resources

Allocatable objects are registered using a descriptor that is similar to [well-known object descriptors](#). Allocatable objects cannot be replicated and therefore can only be specified within an object adapter descriptor.

Servers can be specified as allocatable by setting the server descriptor's `allocatable` attribute.

As an example, the following application defines an allocatable server and an [allocatable object](#):

XML

```

<icegrid>
  <application name="Ripper">
    <node name="Node1">
      <server id="EncoderServer"
        exe="/opt/ripper/bin/server"
        activation="on-demand"
        allocatable="true">
        <adapter name="EncoderAdapter" id="EncoderAdapter" endpoints="tcp">
          <allocatable identity="EncoderFactory" type="::Ripper::MP3EncoderFactory"/>
        </adapter>
      </server>
    </node>
  </application>
</icegrid>

```

Using Resource Allocation in the Ripper Application

We can use the allocation facility in our MP3 encoder factory to coordinate access to the MP3 encoder factories. First we need to modify the descriptors to define an allocatable object:

XML

```

<icegrid>
  <application name="Ripper">
    <server-template id="EncoderServerTemplate">
      <parameter name="index"/>
      <server id="EncoderServer${index}"
        exe="/opt/ripper/bin/server"
        activation="on-demand">
        <adapter name="EncoderAdapter" endpoints="tcp">
          <allocatable identity="EncoderFactory${index}"
            type="::Ripper::MP3EncoderFactory"/>
        </adapter>
      </server>
    </server-template>
    <node name="Node1">
      <server-instance template="EncoderServerTemplate" index="1"
    />
    </node>
    <node name="Node2">
      <server-instance template="EncoderServerTemplate" index="2"
    />
    </node>
  </application>
</icegrid>

```

Next, the client needs to create a session and allocate a factory:

C++

```

Ice::ObjectPrx obj = session->allocateObjectByType(Ripper::MP3EncoderFactory::ice_staticId());
try {
  Ripper::MP3EncoderPrx encoder = factory->createEncoder();
  // Use the encoder to encode a file ...
}
catch (const Ice::LocalException & ex) {
  // There was a problem with the encoding, we catch the
  // exception to make sure we release the factory.
}
session->releaseObject(obj->ice_getIdentity());

```

It is important to release an allocated object when it is no longer needed so that other clients may use it. If you forget to release an object, it remains allocated until the session is destroyed.

See Also

- [Getting Started with Glacier2](#)
- [IceSSL](#)

- [Well-Known Registry Objects](#)
- [Securing a Glacier2 Router](#)
- [Object Descriptor Element](#)
- [Allocatable Descriptor Element](#)
- [IceGrid Properties](#)
- [IceSSL Properties](#)

Registry Replication

The failure of an IceGrid registry or registry host can have serious consequences. A client can continue to use an existing connection to a server without interruption, but any activity that requires interaction with the registry is vulnerable to a single point of failure. As a result, the IceGrid registry supports replication using a master-slave configuration to provide high availability for applications that require it.

On this page:

- [Registry Replication Architecture](#)
- [Capabilities of a Registry Replica](#)
 - [Locate Requests](#)
 - [Server Activation](#)
 - [Queries](#)
 - [Allocation](#)
 - [Administration](#)
 - [Glacier2 Support](#)
- [Configuring Registry Replication](#)
 - [Replicas](#)
 - [Clients](#)
 - [Nodes](#)
 - [Diagnostics](#)
- [Using Registry Replication with External Load Balancing](#)

Registry Replication Architecture

In IceGrid's registry replication architecture, there is one master replica and any number of slave replicas. The master synchronizes its deployment information with the slaves so that any replica is capable of responding to locate requests, managing nodes, and starting servers on demand. Should the master registry or its host fail, properly configured clients transparently fail over to one of the slaves.

Each replica has a unique name. The name `Master` is reserved for the master replica, while replicas can use any name that can legally appear in an object identity.

The figure below illustrates the underlying concepts of registry replication:

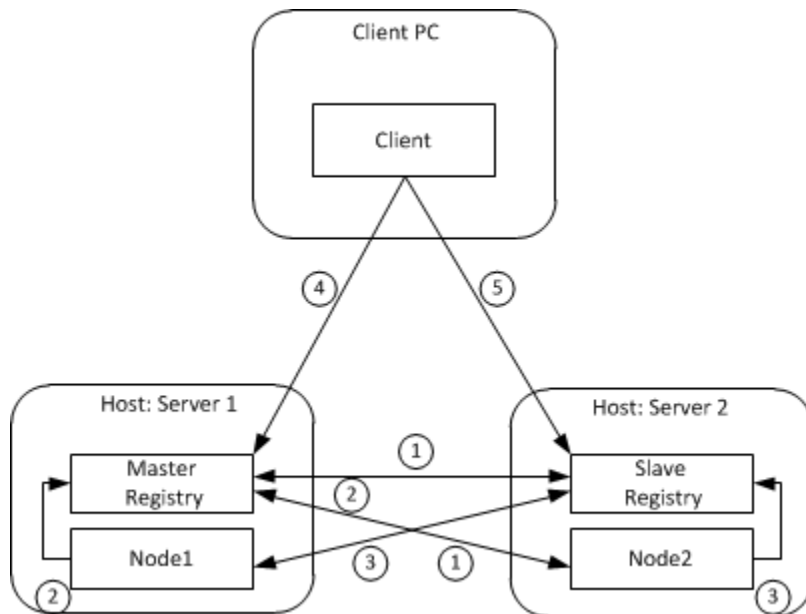

Overview of registry replication.

1. The slave replica contacts the master replica at startup and synchronizes its databases. Any subsequent modifications to the deployed applications are made via the master replica, which distributes them to all active slaves.

2. The nodes contact the master replica at startup to notify it about their availability.
3. The master replica provides a list of slave replicas to the nodes so that the nodes can also notify the slaves.
4. The client's configuration determines which replica it contacts initially. In this example, it contacts the master replica.
5. In the case of a failure, the client automatically fails over to the slave. If the master registry's host has failed, then `Node1` and any servers that were active on this host also become unavailable. The use of [object adapter replication](#) allows the client to transparently reestablish communication with a server on `Node2`.

Capabilities of a Registry Replica

A master registry replica has a number of responsibilities, only some of which are supported by slaves. The master replica knows all of its slaves, but the slaves are not in contact with one another. If the master replica fails, the slaves can perform several vital functions that should keep most applications running without interruption. Eventually, however, a new master replica must be started to restore full registry functionality. For a slave replica to become the master, the slave must be restarted.

Locate Requests

One of the most important functions of a registry replica is responding to locate requests from clients, and every replica has the capability to service these requests. Slaves synchronize their databases with the master so that they have all of the information necessary to transform object identities, object adapter identifiers, and replica group identifiers into an appropriate set of endpoints.

Server Activation

Nodes establish sessions with each active registry replica so that any of the replicas are capable of activating a server on behalf of a client.

Queries

Replicating the registry also replicates the object that supports the `IceGrid::Query` interface used to [query well-known objects](#). A client that resolves the `IceGrid/Query` object identity receives the endpoints of all active replicas, any of which can execute the client's requests.

Allocation

A client that needs to allocate a resource must establish a session with the master replica.

Administration

The state of an IceGrid registry is accessible via the `IceGrid::Admin` interface or (more commonly) using an [administrative tool](#) that encapsulates this interface. Modifications to the registry's state, such as deploying or updating an application, can only be done using the master replica. Administrative access to slave replicas is allowed but restricted to read-only operations. The administrative utilities provide mechanisms for you to select a particular replica to contact.

For programmatic access to a replica's administrative interface, the `IceGrid/Registry` identity corresponds to the master replica and the identity `IceGrid/Registry-name` corresponds to the slave with the given name.

Glacier2 Support

The registry implements the session manager interfaces required for [integration with a Glacier2 router](#). The master replica supports the object identities `IceGrid/SessionManager` and `IceGrid/AdminSessionManager`. The slave replicas offer support for read-only administrative sessions using the object identity `IceGrid/AdminSessionManager-name`.

Configuring Registry Replication

Incorporating registry replication into an application is primarily accomplished by modifying your IceGrid configuration settings.

Replicas

Each replica must specify a unique name in its configuration property `IceGrid.Registry.ReplicaName`. The default value of this property is `Master`, therefore the master replica can omit this property if desired.

At startup, a slave replica attempts to register itself with its master in order to synchronize its databases and obtain the list of active nodes. The slave uses the proxy supplied by the `Ice.Default.Locator` property to find the master. Therefore this proxy must be defined and at least contain the endpoint of a replica that is connected to the master.

For better reliability if a failure occurs, we recommend that you also include the endpoints of all slave replicas in the `Ice.Default.Locator` property. There is no harm in adding the slave's own endpoints to the proxy in `Ice.Default.Locator`; in fact, it makes configuration simpler because all of the slaves can share the same property definition. Although slaves do not communicate with each other, it is possible for one of the slaves to be promoted to the master, therefore supplying the endpoints of all slaves minimizes the chance of a communication failure.

Shown below is an example of the configuration properties for a master replica:

```
IceGrid.InstanceName=DemoIceGrid
IceGrid.Registry.Client.Endpoints=default -p 12000
IceGrid.Registry.Server.Endpoints=default
IceGrid.Registry.Internal.Endpoints=default
IceGrid.Registry.Data=db/master
...
```

You can configure a slave replica to use this master with the following settings:

```
Ice.Default.Locator=DemoIceGrid/Locator:default -p 12000
IceGrid.Registry.Client.Endpoints=default -p 12001
IceGrid.Registry.Server.Endpoints=default
IceGrid.Registry.Internal.Endpoints=default
IceGrid.Registry.Data=db/replica1
IceGrid.Registry.ReplicaName=Replica1
...
```

Clients

The endpoints contained in the `Ice.Default.Locator` property determine which registry replicas the client can use when issuing locate requests. If high availability is important, this property should include the endpoints of at least two (and preferably all) replicas. Not only does this increase the reliability of the client, it also distributes the work load of responding to locate requests among all of the replicas.

Continuing the example from the previous section, you can configure a client with the `Ice.Default.Locator` property as shown below:

```
Ice.Default.Locator=DemoIceGrid/Locator:default -p 12000:default -p 12001
```

Nodes

As with slave replicas and clients, an IceGrid node should be configured with an `Ice.Default.Locator` property that contains the endpoint of at least one replica and preferably all the replicas. A node needs to notify each of the registry replicas about its presence, thereby enabling the replicas to activate its servers and obtain the endpoints of its object adapters. Only the master replica knows the list of active replica slaves so it's important that the node connects to the master on startup to retrieve the list of all the active replicas. If the master is down when the node starts, the node will try to obtain the list of the registry replicas from the replicas specified in its `Ice.Default.Locator` proxy.

The following properties demonstrate how to configure a node with a replicated registry:

```
Ice.Default.Locator=DemoIceGrid/Locator:default -p 12000:default -p 12001
IceGrid.Node.Name=node1
IceGrid.Node.Endpoints=default
IceGrid.Node.Data=db/node1
```

Diagnostics

You can use several configuration properties to enable trace messages that may help in diagnosing registry replication issues:

- `IceGrid.Registry.Trace.Replica`
Displays information about the sessions established between master and slave replicas.
- `IceGrid.Registry.Trace.Node`
`IceGrid.Node.Trace.Replica`
Displays information about the sessions established between replicas and nodes.

Using Registry Replication with External Load Balancing

As explained earlier, we recommend including the endpoints of all replicas in the `Ice.Default.Locator` property. However, doing so might not always be convenient in large deployments, as it can require modifying many configuration files whenever you add or remove a registry replica. There are two ways to simplify your configuration:

- **Use a DNS name bound to multiple address (A) records**
Configure the DNS name to point to the IP addresses of each of the registry replicas. You can then define the `Ice.Default.Locator` property with a single endpoint that embeds the DNS name. The Ice run time in the client randomly picks one of these IP addresses when it resolves the DNS name. All replicas must use the same port.
- **Use a TCP load balancer**
Configure the load balancer to redirect traffic to the registry replicas and define the `Ice.Default.Locator` property with an endpoint that embeds the IP address and port of the TCP load balancer. The Ice run time in the client connects to the load balancer and the load balancer forwards the traffic to an active registry replica.

For maximum reliability, the DNS server or TCP load balancer should also be replicated.

When using such a configuration for the `Ice.Default.Locator` property of registry slaves, special care needs to be taken when initially starting the IceGrid registry replicas. Since the `Ice.Default.Locator` property no longer includes the endpoint of the master replica, a slave replica won't be able to contact the master if it's started when no master is running. You must first start the master and then the slaves to prevent this from happening. Once a replica slave connects successfully to the master, it saves the endpoint of the master and the other slaves in its database, so this is really only an issue when starting a slave with an empty database.

See Also

- [Well-Known Objects](#)
- [icegridadmin Command Line Tool](#)
- [Glacier2 Integration with IceGrid](#)
- [IceGrid Properties](#)

Application Distribution

On this page:

- [Using IcePatch2 to Distribute Applications](#)
- [Deploying an IcePatch2 Server](#)
 - [Patching Considerations](#)
 - [IcePatch2 Server Template](#)
- [Adding Distribution to a Deployment](#)
- [Distributing Applications and Servers](#)
- [Server Integrity during Distribution](#)
- [Distribution Descriptor Variables](#)
- [Using Distribution in the Ripper Application](#)

Using IcePatch2 to Distribute Applications

In the section so far, "deployment" has meant the creation of descriptors in the registry. A broader definition involves a number of other tasks:

- Writing IceGrid configuration files and preparing data directories on each computer
- Installing the IceGrid binaries and dependent libraries on each computer
- Starting the registry and/or node on each computer, and possibly configuring the systems to launch them automatically
- Distributing your server executables, dependent libraries and supporting files to the appropriate nodes.

The first three tasks are the responsibility of the system administrator, but IceGrid can help with the fourth. Using an [IcePatch2](#) server, you can configure the nodes to download servers automatically and patch them at any time. The illustration below shows the interactions of the components:

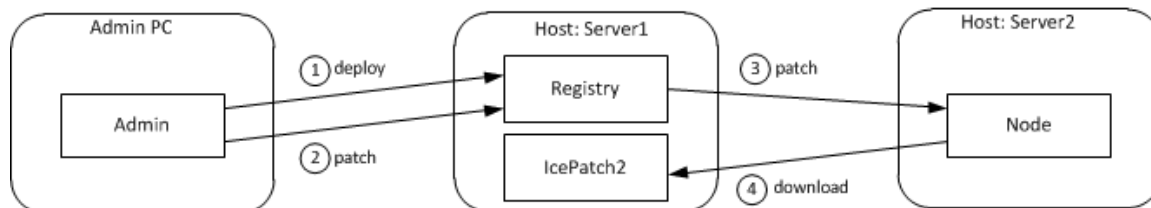

Overview of application distribution.

As you can see, deploying an IceGrid application has greater significance when IcePatch2 is also involved. After deployment, the [administrative tool](#) initiates a patch, causing the registry to notify all active nodes that are configured for application distribution to begin the patching process. Since each IceGrid node is an IcePatch2 client, the node performs the patch just like any IcePatch2 client: it downloads everything if no local copy of the distribution exists, otherwise it does an incremental patch in which it downloads only new files and those whose signatures have changed.

The benefits of this feature are clear:

- The distribution files are maintained in a central location
- Updating a distribution on all of the nodes is a simple matter of preparing the master distribution and letting IceGrid do the rest
- Manually transferring executables and supporting files to each computer is avoided, along with the mistakes that manual intervention sometimes introduces.

Deploying an IcePatch2 Server

If you plan to use IceGrid's distribution capabilities, we generally recommend deploying an IcePatch2 server along with your application. Doing so gives you the same benefits as any other IceGrid server, including on-demand activation and remote administration. We will only use one server in our sample application, but you might consider replicating a number of IcePatch2 servers in order to balance the patching load for large distributions.

Patching Considerations

Deploying an IcePatch2 server with your application presents a chicken-and-egg dilemma: how do the nodes download their distributions if the IcePatch2 server is included in the deployment? To answer this question, we need to learn more about IceGrid's behavior.

Deploying and patching are treated as two separate steps: first you deploy the application, then you initiate the patching process. The `icegridadmin` utility combines these steps into one command (`application add`), but also provides an option to disable the patching step if so desired.

Let's consider the state of the application after deployment but before patching: we have described the servers that run on each node, including file system-dependent attributes such as the pathnames of their executables and default working directories. If these pathnames refer to directories in the distribution, and the distribution has not yet been downloaded to that node, then clearly we cannot attempt to use those servers until patching has completed. Similarly, we cannot deploy an IcePatch2 server whose executable resides in the distribution to be downloaded.



We are ignoring the case where a temporary IcePatch2 server is used to bootstrap other IcePatch2 servers.

For these reasons, we assume that the IcePatch2 server and supporting libraries are distributed by the system administrator along with the IceGrid registry and nodes to the appropriate computers. The server should be configured for on-demand activation so that its node starts it automatically when patching begins. If the server is configured for manual activation, you must start it prior to patching.

IcePatch2 Server Template

The Ice distribution includes an IcePatch2 [server template](#) that simplifies the inclusion of IcePatch2 in your application. The relevant portion from the file `config/templates.xml` is shown below:

XML

```
<server-template id="IcePatch2">
  <parameter name="instance-name" default="{application}.IcePatch2"/>
  <parameter name="endpoints" default="default"/>
  <parameter name="directory"/>

  <server id="{instance-name}" exe="icepatch2server"
    application-distrib="false" activation="on-demand">
    <adapter name="IcePatch2" endpoints="{endpoints}">
      <object identity="{instance-name}/server"
type="::IcePatch2::FileServer"/>
    </adapter>
    <adapter name="IcePatch2.Admin" id=" "
endpoints="tcp -h 127.0.0.1"/>
    <property name="IcePatch2.InstanceName"
value="{instance-name}"/>
    <property name="IcePatch2.Directory" value="{directory}"/>
  </server>
</server-template>
```

Notice that the server's pathname is `icepatch2server`, meaning the program must be present in the node's executable search path. The only mandatory parameter is `directory`, which specifies the server's data directory and becomes the value of the `IcePatch2.Directory` property. The value of the `instance-name` parameter is used as the server's identifier when the template is instantiated; its default value includes the name of the application in which the template is used. This identifier also affects the identities of the two well-known objects declared by the server.

Consider the following sample application:

XML

```

<icegrid>
  <application name="PatchDemo">
    <node name="Node">
      <server-instance template="IcePatch2"
directory="/opt/icepatch2/data"/>
      ...
    </node>
  </application>
</icegrid>

```

Instantiating the `IcePatch2` template creates a server identified as `PatchDemo.IcePatch2` (as determined by the default value for the `instance-name` parameter). The well-known objects use this value as the category in their identities, such as `PatchDemo.IcePatch2/server`.

In order to refer to the `IcePatch2` template in your application, you must have already configured the registry to use the `config/templates.xml` file as your [default templates](#), or copied the template into the XML file describing your application.

Adding Distribution to a Deployment

A [distribution descriptor](#) provides the details that a node requires in order to download the necessary files. Specifically, the descriptor supplies the proxy of the `IcePatch2` server and the names of the subdirectories comprising the distribution, all of which are optional. If the descriptor does not define the proxy, the following default value is used instead:

```

${application}.IcePatch2/server

```

You may recall that this value matches the default identity configured by the `IcePatch2` server template described [above](#). Also notice that this is an indirect proxy, implying that the `IcePatch2` server was deployed with the application and can be started on-demand if necessary.

If the descriptor does not select any subdirectories, the node downloads the entire contents of the `IcePatch2` data directory.

In XML, a descriptor having the default behavior as described above can be written as shown below:

XML

```

<istrib/>

```

To specify a proxy, use the `icepatch` attribute:

XML

```

<istrib icepatch="PatchDemo.IcePatch2/server"/>

```

Finally, select subdirectories using a nested element:

XML

```
<distrib>
  <directory>dir1</directory>
  <directory>dir2/subdir</directory>
</distrib>
```

By including only certain subdirectories in a distribution, you are minimizing the time and effort required to download and patch each node. For example, each node in a heterogeneous network might download a platform-specific subdirectory and another subdirectory containing files common to all platforms.

Distributing Applications and Servers

A [distribution descriptor](#) can be used in two contexts: within an application, and within a server. When the descriptor appears at the application level, it means every node in the application downloads that distribution. This is useful for distributing files required by all of the nodes on which servers are deployed, especially in a grid of homogeneous computers where it would be tedious to repeat the same distribution information in each server descriptor. Here is a simple XML example:

XML

```
<icegrid>
  <application name="PatchDemo">
    <distrib>
      <directory>Common</directory>
    </distrib>
    ...
  </application>
</icegrid>
```

At the server level, a distribution descriptor downloads the specified directories for the private use of the server:

XML

```
<icegrid>
  <application name="PatchDemo">
    <distrib>
      <directory>Common</directory>
    </distrib>
    <node name="Node">
      <server id="SimpleServer" ...>
        <distrib>
          <directory>ServerFiles</directory>
        </distrib>
      </server>
    </node>
  </application>
</icegrid>
```

When a distribution descriptor is defined at both the application and server levels, as shown in the previous example, IceGrid assumes that a dependency relationship exists between the two unless the server is configured otherwise. IceGrid checks this dependency before patching a server; if the server is dependent on the application's distribution, IceGrid patches the application's distribution first, and then proceeds to patch the server's. You can disable this dependency by modifying the server's descriptor:

XML

```

<icegrid>
  <application name="PatchDemo">
    <distrib>
      <directory>Common</directory>
    </distrib>
    <node name="Node">
      <server id="SimpleServer" application-distrib="false" ...>
        <distrib>
          <directory>ServerFiles</directory>
        </distrib>
      </server>
    </node>
  </application>
</icegrid>

```

Setting the `application-distrib` attribute to `false` informs IceGrid to consider the two distributions independent of one another.

Server Integrity during Distribution

Before an IceGrid node begins patching a distribution, it ensures that all relevant servers are shut down and prevents them from reactivating until patching completes. For example, the node disables all of the servers whose descriptors declare a dependency on the [application distribution](#).

Distribution Descriptor Variables

The node stores application and server distributions in its data directory. The path names of the distributions are represented by [reserved variables](#) that you can use in your descriptors:

- `application.distrib`
This variable can be used within server descriptors to refer to the top-level directory of the application distribution.
- `server.distrib`
The value of this variable is the top-level directory of a server distribution. It can be used only within a server descriptor that has a distribution.

The XML example shown below illustrates the use of these variables:

XML

```

<icegrid>
  <application name="PatchDemo">
    <distrib>
      <directory>Common</directory>
    </distrib>
    <node name="Node">
      <server id="Server1"
exe="${application.distrib}/Common/Bin/Server1" ...>
      </server>
      <server id="Server2"
exe="${server.distrib}/Server2Files/Bin/Server2" ...>
        <option>-d</option>
        <option>${server.distrib}/Server2Files</option>
        <distrib>
          <directory>Server2Files</directory>
        </distrib>
      </server>
    </node>
  </application>
</icegrid>

```

Notice that the descriptor for `Server2` supplies the server's distribution directory as command-line options.

Using Distribution in the Ripper Application

Adding an application distribution to our [ripper example](#) requires two minor changes to our descriptors:

XML

```

<icegrid>
  <application name="Ripper">
    <replica-group id="EncoderAdapters">
      <load-balancing type="adaptive"/>
      <object identity="EncoderFactory"
type="::Ripper::MP3EncoderFactory"/>
    </replica-group>
    <server-template id="EncoderServerTemplate">
      <parameter name="index"/>
      <parameter name="exepath" default="/opt/ripper/bin/server"/>
      <server id="EncoderServer${index}" exe="${exepath}"
activation="on-demand">
        <adapter name="EncoderAdapter"
replica-group="EncoderAdapters"
        endpoints="tcp"/>
      </server>
    </server-template>
    <distrib/>
    <node name="Node1">
      <server-instance template="EncoderServerTemplate"
index="1"/>
      <server-instance template="IcePatch2"
directory="/opt/ripper/icepatch"/>
    </node>
    <node name="Node2">
      <server-instance template="EncoderServerTemplate"
index="2"/>
    </node>
  </application>
</icegrid>

```

An application distribution is sufficient for this example because we are deploying the same server on each node. We have also deployed an `IcePatch2` server on `Node1` using the template.

See Also

- [IcePatch2](#)
- [icegridadmin Command Line Tool](#)
- [IceGrid Templates](#)
- [Distrib Descriptor Element](#)
- [Using Descriptor Variables and Parameters](#)
- [Object Adapter Replication](#)
- [IcePatch2 Object Identities](#)

IceGrid Administrative Sessions

To access IceGrid's administrative facilities from a program, you must first establish an administrative session. Once done, a wide range of services are at your disposal, including the manipulation of IceGrid registries, nodes, and servers; deployment of new components such as well-known objects; and dynamic monitoring of IceGrid events.

Note that, for [replicated registries](#), an administrative session can be established with either the master or a slave registry replica, but a session with a slave replica is restricted to read-only operations.

On this page:

- [Creating an Administrative Session](#)
- [Accessing Log Files Remotely](#)
- [Dynamic Monitoring in IceGrid](#)
 - [Observer Interfaces](#)
 - [Registering Observers](#)

Creating an Administrative Session

The `Registry` interface provides two operations for creating an administrative session:

Slice

```

module IceGrid {
    exception PermissionDeniedException {
        string reason;
    };

    interface Registry {
        AdminSession* createAdminSession(string userId, string password)
            throws PermissionDeniedException;

        AdminSession* createAdminSessionFromSecureConnection()
            throws PermissionDeniedException;

        idempotent int getSessionTimeout();

        // ...
    };
};

```

The `createAdminSession` operation expects a username and password and returns a session proxy if the client is allowed to create a session. By default, IceGrid does not allow the creation of administrative sessions. You must define the property `IceGrid.Registry.AdminPermissionsVerifier` with the proxy of a permissions verifier object to enable session creation with `createAdminSession`. The verifier object must implement the interface `Glacier2::PermissionsVerifier`.

The `createAdminSessionFromSecureConnection` operation does not require a username and password because it uses the credentials supplied by an [SSL](#) connection to authenticate the client. As with `createAdminSession`, you must configure the proxy of a permissions verifier object before clients can use `createAdminSessionFromSecureConnection` to create a session. In this case, the `IceGrid.Registry.AdminSSLPermissionsVerifier` property specifies the proxy of a verifier object that implements the interface `Glacier2::SSLPermissionsVerifier`.

As an example, the following code demonstrates how to obtain a proxy for the registry and invoke `createAdminSession`:

C++

```
Ice::ObjectPrx base = communicator->stringToProxy("IceGrid/Registry");
IceGrid::RegistryPrx registry =
IceGrid::RegistryPrx::checkedCast(base);
string username = ...;
string password = ...;
IceGrid::AdminSessionPrx session;
try {
    session = registry->createAdminSession(username, password);
} catch (const IceGrid::PermissionDeniedException & ex) {
    cout << "permission denied:\n" << ex.reason << endl;
}
}
```

The `AdminSession` interface provides operations for [accessing log files](#) and [establishing observers](#). Furthermore, two additional operations are worthy of your attention:

Slice

```
module IceGrid {
    interface AdminSession extends Glacier2::Session {
        idempotent void keepAlive();
        idempotent Admin* getAdmin();
        // ...
    };
};
```

If your program uses an administrative session indefinitely, you must prevent the session from expiring by invoking `keepAlive` periodically. You can [determine the timeout period](#) by calling `getSessionTimeout` on the `Registry` interface. Typically a program uses a dedicated thread for this purpose.

The `getAdmin` operation returns a proxy for the `IceGrid::Admin` interface, which provides complete access to the registry's settings. For this reason, you must use extreme caution when enabling administrative sessions.

Accessing Log Files Remotely

IceGrid's `AdminSession` interface provides operations for remotely accessing the log files of a registry, node, or server:

Slice

```

module IceGrid {
interface AdminSession extends Glacier2::Session {
    // ...

    FileIterator* openServerLog(string id, string path, int count)
        throws FileNotAvailableException, ServerNotExistException,
            NodeUnreachableException, DeploymentException;
    FileIterator* openServerStdErr(string id, int count)
        throws FileNotAvailableException, ServerNotExistException,
            NodeUnreachableException, DeploymentException;
    FileIterator* openServerStdOut(string id, int count)
        throws FileNotAvailableException, ServerNotExistException,
            NodeUnreachableException, DeploymentException;

    FileIterator* openNodeStdErr(string name, int count)
        throws FileNotAvailableException, NodeNotExistException,
            NodeUnreachableException;
    FileIterator* openNodeStdOut(string name, int count)
        throws FileNotAvailableException, NodeNotExistException,
            NodeUnreachableException;

    FileIterator* openRegistryStdErr(string name, int count)
        throws FileNotAvailableException,
            RegistryNotExistException,
            RegistryUnreachableException;
    FileIterator * openRegistryStdOut(string name, int count)
        throws FileNotAvailableException,
            RegistryNotExistException,
            RegistryUnreachableException;

};
};

```

In order to access the text of a program's standard output or standard error log, you must configure it using the `Ice.StdOut` and `Ice.StdErr` properties, respectively. For registries and nodes, you must define these properties explicitly but, for servers, the node defines these properties automatically if the property `IceGrid.Node.Output` is defined, causing the server's output to be logged in individual files.

If `IceGrid.Node.Output` is *not* defined, the following rules apply:

- If the node is started from a console or shell, servers share the node's `stdout` and `stderr`. If `Ice.StdOut` and/or `Ice.StdErr` properties are defined for the node, the servers' output is redirected to the specified files as well.
- If the node is started as a Unix daemon and `--noclose` is not used, the servers' output is lost, except if `Ice.StdOut` and/or `Ice.StdErr` properties are set for the node, in which case the servers' output is redirected to the specified files.
- If the node is started as a Windows service, the servers' output is lost even if `Ice.StdOut` and/or `Ice.StdErr` are set.

Log messages from the node itself are sent to `stderr` unless you set `Ice.UseSyslog` (for Unix). If the node is started as a Windows service, its log messages always are sent to the Windows event log.

In the case of `openServerLog`, the value of the `path` argument must resolve to the same file as one of the server's log descriptors. This security measure prevents a client from opening an arbitrary file on the server's host.

All of the operations accept a `count` argument and return a proxy to a `FileIterator` object. The `count` argument determines where to start reading the log file: if the value is negative, the iterator is positioned at the beginning of the file, otherwise the iterator is positioned to return the last `count` lines of text.

The `FileIterator` interface is quite simple:

Slice
<pre> module IceGrid { interface FileIterator { bool read(int size, out Ice::StringSeq lines) throws FileNotAvailableException; void destroy(); }; }; </pre>

A client may invoke the `read` operation as many times as necessary. The `size` argument specifies the maximum number of bytes that `read` can return; the client must not use a size that would cause the reply to exceed the client's configured [maximum message size](#).

If this is the client's first call to `read`, the `lines` argument holds whatever text was available from the iterator's initial position, and the iterator is repositioned in preparation for the next call to `read`. The operation returns false to indicate that more text is available and true if all available text has been read.

Line termination characters are removed from the contents of `lines`. When displaying the text, you must be aware that the first and last elements of the sequence can be partial lines. For example, the last line of the sequence might be incomplete if the limit specified by `size` is reached. The next call to `read` returns the remainder of that line as the first element in the sequence.

As an example, the C++ code below displays the contents of a log file and waits for new text to become available:

C++
<pre> IceGrid::FileIteratorPrx iter = ...; while(true) { Ice::StringSeq lines; bool end = iter->read(10000, lines); if (!lines.empty()) { // The first line might be a continuation from // the previous call to read. cout << lines[0]; for (Ice::StringSeq::const_iterator p = ++lines.begin(); p != lines.end(); ++p) cout << endl << *p << flush; } if (end) sleep(1); } </pre>

Notice that the loop includes a delay in case `read` returns true, which prevents the client from entering a busy loop when no data is currently available.

The client should call `destroy` when the iterator object is no longer required. At the time the client's session terminates, IceGrid reclaims any iterators that were not explicitly destroyed.

If the client waits for new data, it must invoke `keepAlive` on the [administrative session](#) to prevent it from expiring.

Dynamic Monitoring in IceGrid

IceGrid allows an application to monitor relevant state changes by registering callback objects. (The [IceGrid GUI tool](#) uses these callback interfaces for its implementation.) The callback interfaces are useful to, for example, automatically generate an email notification when a node goes down or some other state change of interest occurs.

Observer Interfaces

IceGrid offers a callback interface for each major component of the IceGrid architecture:

Slice
<pre> module IceGrid { interface NodeObserver { void nodeInit(NodeDynamicInfoSeq nodes); void nodeUp(NodeDynamicInfo node); void nodeDown(string name); void updateServer(string node, ServerDynamicInfo updatedInfo); void updateAdapter(string node, AdapterDynamicInfo updatedInfo); }; interface ApplicationObserver { void applicationInit(int serial, ApplicationInfoSeq applications); void applicationAdded(int serial, ApplicationInfo desc); void applicationRemoved(int serial, string name); void applicationUpdated(int serial, ApplicationUpdateInfo desc); }; interface AdapterObserver { void adapterInit(AdapterInfoSeq adpts); void adapterAdded(AdapterInfo info); void adapterUpdated(AdapterInfo info); void adapterRemoved(string id); }; interface ObjectObserver { void objectInit(ObjectInfoSeq objects); void objectAdded(ObjectInfo info); void objectUpdated(ObjectInfo info); void objectRemoved(Ice::Identity id); }; interface RegistryObserver { void registryInit(RegistryInfoSeq registries); void registryUp(RegistryInfo node); void registryDown(string name); }; }; </pre>

The next section describes how to install an observer.

Registering Observers

The `AdminSession` interface provides two operations for registering your observers:

Slice
<pre> module IceGrid { interface AdminSession extends Glacier2::Session { idempotent void keepAlive(); idempotent void setObservers(RegistryObserver* registryObs, NodeObserver* nodeObs, ApplicationObserver* appObs, AdapterObserver* adptObs, ObjectObserver* objObs) throws ObserverAlreadyRegisteredException; idempotent void setObserversByIdentity(Ice::Identity registryObs, Ice::Identity nodeObs, Ice::Identity appObs, Ice::Identity adptObs, Ice::Identity objObs) throws ObserverAlreadyRegisteredException; // ... }; }; </pre>

You should invoke `setObservers` and supply proxies when it is possible for the registry to establish a separate connection to the client to deliver its callbacks. If network restrictions such as firewalls prevent such a connection, you should use the `setObserversByIdentity` operation, which creates a [bidirectional connection](#) instead.

You can pass a null proxy for any parameter to `setObservers`, or an empty identity for any parameter to `setObserversByIdentity`, if you want to use only some of the observers. In addition, passing a null proxy or an empty identity for an observer cancels a previous registration of that observer. The operations raise `ObserverAlreadyRegisteredException` if you pass a proxy or identity that was registered in a previous call.

Once the observers are registered, operations corresponding to state changes will be invoked on the observers. (See the [Slice API Reference](#) for details on the data passed to the observers. You can also look at the source code for the IceGrid GUI implementation in the Ice for Java distribution to see how observers are used by the GUI.)

Finally, remember to invoke `keepAlive` periodically on the [administrative session](#) to prevent it from expiring.

See Also

- [Registry Replication](#)
- [Securing a Glacier2 Router](#)
- [Resource Allocation using IceGrid Sessions](#)
- [Log Descriptor Element](#)
- [icegridadmin Command Line Tool](#)

- [Bidirectional Connections](#)
- [IceGrid Properties](#)

Glacier2 Integration with IceGrid

This section provides information on integrating a [Glacier2 router](#) into your IceGrid environment.

On this page:

- [Configuration Changes for using Glacier2 with IceGrid](#)
- [Remote IceGrid Administration via Glacier2](#)
- [Resource Allocation using Glacier2 and IceGrid](#)
- [Session Considerations for Glacier2 and IceGrid](#)
- [Deploying Glacier2 with IceGrid](#)

Configuration Changes for using Glacier2 with IceGrid

A typical IceGrid client must be configured with a [locator proxy](#), but the configuration requirements change when the client accesses the location service indirectly via a Glacier2 router as shown below:

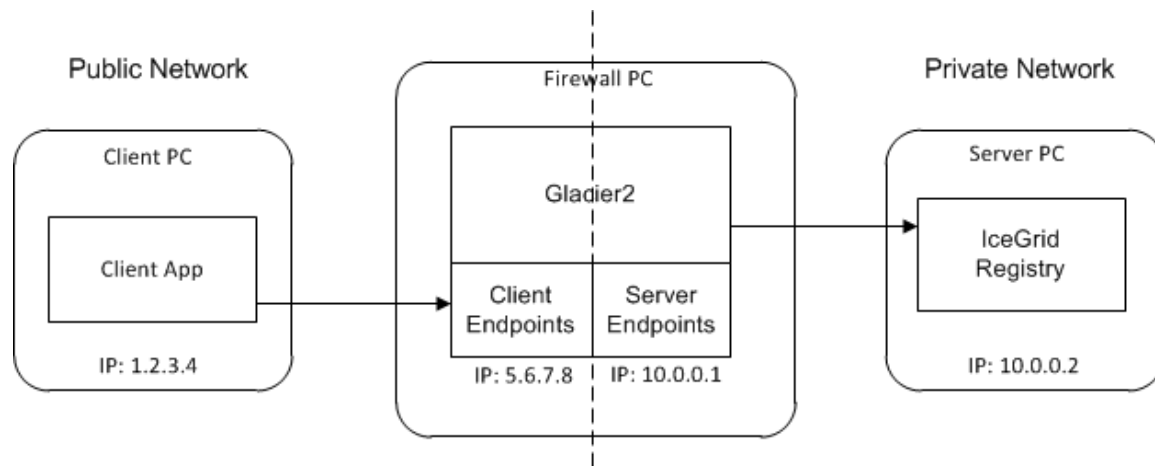

Using IceGrid via a Glacier2 router.

In this situation, it is the router that must be configured with a locator proxy.

Assuming the registry's client endpoint in the illustration uses port 8000, the router requires the following setting for the `Ice.Default.Locator` property:

```
Ice.Default.Locator=IceGrid/Locator:tcp -h 10.0.0.2 -p 8000
```

Fortunately, the node supplies this property when it starts the router, so there is no need to configure it explicitly. Note that all of the router's clients use the same locator.

Remote IceGrid Administration via Glacier2

If you intend to administer IceGrid remotely via a Glacier2 router, you must define one of the following properties (or both), depending on whether you use user name and password authentication or a secure connection:

```
Glacier2.SessionManager=IceGrid/AdminSessionManager
Glacier2.SSLSessionManager=IceGrid/AdminSSLSessionManager
```

These session managers are accessible via the registry's administrative session manager endpoints, so the Glacier2 router must be authorized to establish a connection to these endpoints. Note that you must secure these endpoints, otherwise arbitrary clients can

manipulate the session managers. An administrative session is allowed to access any object by default. To restrict access to the `IceGrid::AdminSession` object and the `IceGrid::Admin` object that is returned by the session's `getAdmin` operation, you must set the property `IceGrid.Registry.AdminSessionFilters` to one.

Resource Allocation using Glacier2 and IceGrid

To allocate servers and objects, a program can establish a client session via Glacier2. Depending on the authentication method, one or both of the following properties must be set in the Glacier2 configuration:

```
Glacier2.SessionManager=IceGrid/SessionManager
Glacier2.SSLSessionManager=IceGrid/SSLSessionManager
```

These session managers are accessible via the registry's session manager endpoints, so the Glacier2 router must be authorized to establish a connection to these endpoints.

A client session is allowed to access any object by default. To restrict access to the `IceGrid::Session` and `IceGrid::Query` objects, you must set the property `IceGrid.Registry.SessionFilters` to one. However, you can use the allocation mechanism to access additional objects and adapters. IceGrid adds an identity filter when a client allocates an object and removes that filter again when the object is released. When a client allocates a server, IceGrid adds an adapter identity filter for the server's indirect adapters and removes that filter again when the server is released.

Session Considerations for Glacier2 and IceGrid

Providing access to [administrative sessions](#) and [client sessions](#) both require that you define at least one of the properties `Glacier2.SessionManager` and `Glacier2.SSLSessionManager`, which presents a potential problem if you intend to access both types of sessions via the same Glacier2 router.

The simplest solution is to dedicate a router instance to each type of session. However, if you need to access both types of sessions from a single router, you can accomplish it only if you use a different authentication mechanism for each type of session. For example, you can configure the router as follows:

```
Glacier2.SessionManager=IceGrid/SessionManager
Glacier2.SSLSessionManager=IceGrid/AdminSSLSessionManager
```

This configuration uses user name and password authentication for client sessions, and SSL authentication for administrative sessions. If this restriction is too limiting, you must use two router instances.

Deploying Glacier2 with IceGrid

The Ice distribution includes [default server templates](#) for Ice services such as IcePatch2 and Glacier2 that simplify the task of deploying these servers in an IceGrid domain.

The relevant portion from the file `config/template.xml` is shown below:

XML

```

<server-template id="Glacier2">
  <parameter name="instance-name" default="{application}.Glacier2"/>
  <parameter name="client-endpoints"/>
  <parameter name="server-endpoints"/>
  <parameter name="session-timeout" default="0"/>

  <server id="{instance-name}" exe="glacier2router">
    <properties>
      <property name="Glacier2.Client.Endpoints"
value="{client-endpoints}"/>
      <property name="Glacier2.Server.Endpoints"
value="{server-endpoints}"/>
      <property name="Glacier2.InstanceName"
value="{instance-name}"/>
      <property name="Glacier2.SessionTimeout"
value="{session-timeout}"/>
    </properties>
  </server-template>

```

Notice that the server's pathname is `glacier2router`, meaning the program must be present in the node's executable search path. Another important point is the server's activation mode: it uses manual activation (the default), meaning the router must be started manually. This requirement becomes clear when you consider that the router is the point of contact for remote clients; if the router is not running, there is no way for a client to contact the locator and cause the router to be started on-demand.

The template defines only a few properties; if you want to set additional properties, you can define them in the server instance property set.

Of interest is the `instance-name` parameter, which allows you to configure the `Glacier2.InstanceName` property. The parameter's default value includes the name of the application in which the template is used. This parameter also affects the `identities` of the objects implemented by the router.

Consider the following sample application:

```

<icegrid>
  <application name="Glacier2Demo">
    <node name="Node">
      <server-instance template="Glacier2"
client-endpoints="tcp -h 5.6.7.8 -p 8000"
session-timeout="300"
server-endpoints="tcp -h 10.0.0.1"/>
      ...
    </node>
  </application>
</icegrid>

```

Instantiating the `Glacier2` template creates a server identified as `Glacier2Demo.Glacier2` (as determined by the default value for the `instance-name` parameter). The router's objects use this value as the category in their identities, such as `Glacier2Demo.Glacier2/router`. The router proxy used by clients must contain a matching identity.

In order to refer to the `Glacier2` template in your application, you must have already configured the registry to use the `config/templates.xml` file as your [default templates](#), or copied the template into the XML file describing your application.

Note that IceGrid cannot start a Glacier2 router if the router's security configuration requires that a passphrase be entered. In this situation, you have no choice but to start the router yourself so that you can provide the passphrase when prompted.

See Also

- [Glacier2](#)
- [IceGrid Templates](#)
- [Getting Started with Glacier2](#)
- [Glacier2 Properties](#)
- [IceGrid Properties](#)

IceGrid XML Reference

This section provides a reference for the XML elements that define IceGrid descriptors, in alphabetical order.

IceGrid XML files must use UTF-8 encoding.

Topics

- [Adapter Descriptor Element](#)
- [Allocatable Descriptor Element](#)
- [Application Descriptor Element](#)
- [DbEnv Descriptor Element](#)
- [DbProperty Descriptor Element](#)
- [Description Descriptor Element](#)
- [Directory Descriptor Element](#)
- [Distrib Descriptor Element](#)
- [IceBox Descriptor Element](#)
- [IceGrid Descriptor Element](#)
- [Load-Balancing Descriptor Element](#)
- [Log Descriptor Element](#)
- [Node Descriptor Element](#)
- [Object Descriptor Element](#)
- [Parameter Descriptor Element](#)
- [Properties Descriptor Element](#)
- [Property Descriptor Element](#)
- [Replica-Group Descriptor Element](#)
- [Server Descriptor Element](#)
- [Server-Instance Descriptor Element](#)
- [Server-Template Descriptor Element](#)
- [Service Descriptor Element](#)
- [Service-Instance Descriptor Element](#)
- [Service-Template Descriptor Element](#)
- [Variable Descriptor Element](#)
- [Using Command Line Options in Descriptors](#)
- [Setting Environment Variables in Descriptors](#)

See Also

- [Using IceGrid Deployment](#)

Adapter Descriptor Element

An adapter element defines an indirect [object adapter](#).

This element may only appear as a child of a [server](#) or [service](#) element.

The following attributes are supported:

Attribute	Description	Required
<code>endpoints</code>	Specifies one or more endpoints for this object adapter. These endpoints typically do not specify a port. This attribute is translated into a definition of the adapter's Endpoints configuration property	No
<code>id</code>	Specifies an object adapter identifier. The identifier must be unique among all adapters and replica groups in the registry. This attribute is translated into a definition of the adapter's AdapterId configuration property. If not defined, a default value is constructed from the adapter name and server ID (and service name for an IceBox service).	Yes
<code>name</code>	The name of the object adapter as used in the server that creates it.	Yes
<code>priority</code>	Specifies the priority of the object adapter as an integer value. The object adapter priority is used by the Ordered replica group load balancing policy to determine the order of the endpoints returned by a locate request. Endpoints are ordered from the smallest priority value to the highest. If not defined, the value is 0.	No
<code>proxy-options</code>	The proxy options to use when generating the adapter well-known or allocatable object proxies. This attribute is also translated into a definition of the adapter's ProxyOptions configuration property.	No
<code>register-process</code>	This attribute is only valid if the enclosing server uses an Ice version prior to 3.3. In Ice 3.3 or later, this functionality is replaced by the administrative facility . If the value is <code>true</code> , this object adapter registers an object in the IceGrid registry that facilitates graceful shutdown of the server. Only one object adapter in a server should set this attribute to <code>true</code> . If not defined, the default value is <code>false</code> .	No

replica-group	Specifies a replica group identifier . A non-empty value signals that this object adapter is a member of the indicated replica group. This attribute is translated into a definition of the adapter's RepliaGroupId configuration property. If not defined, the default value is an empty string.	No
server-lifetime	A value of <code>true</code> indicates that the lifetime of this object adapter is the same as the lifetime of its server. This information is used by the IceGrid node to determine the state of the server. Specifically, the server is considered activated when all the object adapters with the <code>server-lifetime</code> attribute set to <code>true</code> are registered with the registry (the object adapter registers itself during activation). Furthermore, server deactivation is considered to begin as soon as one object adapter with the <code>server-lifetime</code> attribute set to <code>true</code> is unregistered with the registry (the object adapter unregisters itself during deactivation).	No

An optional nested [description](#) element provides free-form descriptive text.

Here is an example to demonstrate the use of this element.

XML

```

<adapter name="MyAdapter"
  endpoints="default"
  id="MyAdapterId"
  proxy-options="-t -e 1.0"
  replica-group="MyReplicaGroup">
  <description>A description of the adapter.</description>
  ...
</adapter>

```

See Also

- [Object Adapters](#)
- [Server Descriptor Element](#)
- [Service Descriptor Element](#)
- [Object Adapter Endpoints](#)
- [Object Adapter Replication](#)
- [Creating an Object Adapter](#)
- [Load Balancing](#)
- [IceGrid Server Activation](#)
- [Ice Object Adapter Properties](#)

Allocatable Descriptor Element

An allocatable element defines an [allocatable object](#) in the IceGrid registry. Clients can allocate this object using only its identity, or they can allocate objects of a specific type.

This element may only appear as a child of an [adapter](#) element.

The following attributes are supported:

Attribute	Description	Required
<code>identity</code>	Specifies the identity by which this allocatable object is known.	Yes
<code>property</code>	Specifies the name of a property to generate that contains the stringified identity of this allocatable.	No
<code>type</code>	An arbitrary string used to group allocatable objects. By convention, the string represents the most-derived Slice type ID of the object, but an application is free to use another convention.	No
<code>proxy-options</code>	The proxy options to use for the proxy of the allocatable object returned by IceGrid.	No

See Also

- [Resource Allocation using IceGrid Sessions](#)
- [Adapter Descriptor Element](#)
- [Type IDs](#)

Application Descriptor Element

An `application` element defines an [IceGrid application](#). An application typically contains at least one `node` element, but it may also be used for other purposes such as defining [server](#) and [service](#) templates, [default templates](#), [replica groups](#) and [property sets](#).

This element must be a child of an `icegrid` element. Only one `application` element is permitted per file.

The following attributes are supported.

Attribute	Description	Required
<code>import-default-templates</code>	If <code>true</code> , the default templates configured for the IceGrid registry are imported and available for use within this application. If not specified, the default value is <code>false</code> .	No
<code>name</code>	The name of the application. This name must be unique among all applications in the registry. Within the application, child elements can refer to its name using the reserved variable <code>\${application}</code> .	Yes

An optional nested `description` element provides free-form descriptive text.

Here is an example to demonstrate the use of this element:

XML

```
<icegrid>
  <application name="MyApplication" import-default-templates="true">
    <description>A description of the application.</description>
    ...
  </application>
</icegrid>
```

See Also

- [IceGrid Architecture](#)
- [Node Descriptor Element](#)
- [Server-Template Descriptor Element](#)
- [Service-Template Descriptor Element](#)
- [Replica-Group Descriptor Element](#)
- [Properties Descriptor Element](#)
- [IceGrid Descriptor Element](#)
- [Description Descriptor Element](#)
- [IceGrid Templates](#)
- [Using Descriptor Variables and Parameters](#)

DbEnv Descriptor Element

A `dbenv` element causes an IceGrid node to generate [Freeze](#) configuration properties for the server or service in which it is defined, and may cause the node to create a database environment directory if necessary. This element may contain [dbproperty](#) elements.

This element may only appear as a child of a [server](#) or [service](#) element.

The following attributes are supported:

Attribute	Description	Required
home	Specifies the directory to use as the database environment. If not defined, a subdirectory within the node's data directory is used.	No
name	The name of the database environment.	Yes

The values of the `name` and `home` attributes are used to define the `Freeze.DbEnv.env-name.DbHome` property as shown below:

```
Freeze.DbEnv.name.DbHome=home
```

An optional nested [description](#) element provides free-form descriptive text.

Here is an example to demonstrate the use of this element:

XML
<pre><dbenv name="MyEnv" home="/opt/data/db"> <description>A description of the database environment.</description> ... </dbenv></pre>

See Also

- [Freeze](#)
- [DbProperty Descriptor Element](#)
- [Server Descriptor Element](#)
- [Service Descriptor Element](#)
- [Description Descriptor Element](#)
- [Freeze Properties](#)

DbProperty Descriptor Element

A `dbproperty` element defines a BerkeleyDB configuration property for a [Freeze](#) database environment.

This element may only appear as a child of a `dbenv` element.

The following attributes are supported:

Attribute	Description	Required
name	The name of the configuration property.	Yes
value	The value of the configuration property. If not defined, the value is an empty string.	No

Here is an example to demonstrate the use of this element:

XML

```
<dbenv name="MyEnv" home="/opt/data/db">
  <description>A description of the
database environment.</description>
  <dbproperty name="set_cachesize" value="0 52428800 1"/>
</dbenv>
```

See Also

- [Freeze](#)
- [DbEnv Descriptor Element](#)

Description Descriptor Element

A `description` element specifies a description of its parent element.

This element may only appear as a child of the `application`, `replica-group`, `node`, `server`, `service`, `icebox`, `adapter`, and `dbenv` elements.

Here is an example to demonstrate the use of this element:

```

XML



```
<node name="localnode">
 <description>Free form descriptive text for localnode</description>
</node>
```

```

See Also

- [Application Descriptor Element](#)
- [Replica-Group Descriptor Element](#)
- [Node Descriptor Element](#)
- [Server Descriptor Element](#)
- [Service Descriptor Element](#)
- [IceBox Descriptor Element](#)
- [Adapter Descriptor Element](#)
- [DbEnv Descriptor Element](#)

Directory Descriptor Element

A `directory` element specifies a directory in a `distribution`.

This element may only appear as a child of the `distrib` element.

This element supports no attributes.

See Also

- [Application Distribution](#)
- [Distrib Descriptor Element](#)

Distrib Descriptor Element

A `distrib` element specifies the `distribution` files to download from an `IcePatch2` server as well as the server's proxy.

This element may only appear as a child of an `application` element or a `server` element.

The following attributes are supported:

| Attribute | Description | Required |
|-----------------------|--|----------|
| <code>icepatch</code> | Proxy for the IcePatch2 server. If not defined, the default value is <code>\${application}.IcePatch2/server</code> . | No |

Here is an example to demonstrate the use of this element:

XML

```
<distrib icepatch="DemoIcePatch2/server:tcp -p 12345">
  <directory>dir1</directory>
  <directory>dir2/subdir</directory>
</distrib>
```

See Also

- [Application Distribution](#)
- [IcePatch2](#)
- [Application Descriptor Element](#)
- [Server Descriptor Element](#)

IceBox Descriptor Element

An `icebox` element defines an `IceBox` server to be deployed on a node. It typically contains at least one `service` element, and may supply additional information such as `command-line options`, `environment variables`, `configuration properties` and a `server distribution`.

The IceBox service manager's object adapter, `IceBox.ServiceManager`, can only be configured as a direct object adapter, using properties. This object adapter is enabled only if the property `IceBox.ServiceManager.Endpoints` is set. Note however that the service manager's functionality remains available as an `administrative facet` even when its object adapter is disabled.

This element may only appear as a child of a `node` element or a `server-template` element.

This element supports the same attributes as the `server` element.

The IceGrid node on which this server is deployed generates the following configuration property for the server:

```
IceBox.InstanceName=${server}
```

An optional nested `description` element provides free-form descriptive text.

Here is an example to demonstrate the use of this element:

XML

```
<icebox id="MyIceBox"
  activation="on-demand"
  activation-timeout="60"
  application-distrib="false"
  deactivation-timeout="60"
  exe="/opt/Ice/bin/icebox"
  pwd="/ ">
  <option>--Ice.Trace.Network=1</option>
  <env>PATH=/opt/Ice/bin:$PATH</env>
  <property name="IceBox.UseSharedCommunicator.Service1" value="1"/>
  <service name="Service1" .../>
  <service-instance template="ServiceTemplate" name="Service2"/>
</icebox>
```

See Also

- [IceBox](#)
- [Service Descriptor Element](#)
- [Adapter Descriptor Element](#)
- [Properties Descriptor Element](#)
- [Node Descriptor Element](#)
- [Server-Template Descriptor Element](#)
- [Server Descriptor Element](#)
- [Description Descriptor Element](#)
- [Using Command Line Options in Descriptors](#)
- [Setting Environment Variables in Descriptors](#)
- [Application Distribution](#)
- [Administrative Facility](#)

IceGrid Descriptor Element

The `icegrid` element is the top-level element for IceGrid descriptors in XML files. This element supports no attributes.

See Also

- [Using IceGrid Deployment](#)

Load-Balancing Descriptor Element

A `load-balancing` element determines the `load balancing` policy used by a `replica group`.

This element may only appear as a child of a `replica-group` element.

The following attributes are supported:

Attribute	Description	Required
<code>load-sample</code>	Specifies the load sample to use for the adaptive load balancing policy. It can only be defined if <code>type</code> is set to <code>adaptive</code> . Legal values are 1, 5 and 15. If not specified, the load sample default value is 1.	No
<code>n-replicas</code>	Specifies the maximum number of replicas used to compute the endpoints of the replica group. If not specified, the default value is 1.	No
<code>type</code>	Specifies the type of load balancing. Legal values are <code>adaptive</code> , <code>ordered</code> , <code>round-robin</code> and <code>random</code> .	Yes

Here is an example to demonstrate the use of this element:

XML
<pre> <application name="MyApp"> <replica-group id="ReplicatedAdapter"> <load-balancing type="adaptive" load-sample="15" n-replicas="3"/> <description>A description of this replica group.</description> <object identity="WellKnownObject" .../> </replica-group> ... </application> </pre>

See Also

- [Load Balancing](#)
- [Object Adapter Replication](#)
- [Replica-Group Descriptor Element](#)

Log Descriptor Element

A `log` element specifies the name of a log file for a server or service. A `log` element must be defined for each log file that can be [accessed remotely](#) by an administrative tool. Note that it is not necessary to define a `log` element for the values of the `Ice.StdErr` and `Ice.StdOut` properties.

This element may only appear as a child of a `server` element or a `service` element.

The following attributes are supported:

Attribute	Description	Required
<code>path</code>	The path name of the log file. If a relative path is specified, it is relative to the current working directory of the node. The node must have sufficient access privileges to read the file.	Yes
<code>property</code>	Specifies the name of a property in which to store the path name of the log file as given in the <code>path</code> attribute.	No

Here is an example to demonstrate the use of this element:

XML
<pre><server id="MyServer" ...> <log path="{server}.log" property="LogFile"/> </server></pre>

See Also

- [IceGrid Administrative Sessions](#)
- [Server Descriptor Element](#)
- [Service Descriptor Element](#)

Node Descriptor Element

A `node` element defines an IceGrid node. The servers that the node is responsible for managing are described in child elements.

This element may only appear as a child of an `application` element. Multiple `node` elements having the same name may appear in an application. Their contents are merged and the last definition of `load-factor` has precedence.

The following attributes are supported:

Attribute	Description	Required
<code>load-factor</code>	A floating point value defining the factor that is multiplied with the node's load average. The load average is used by the adaptive load balancing policy to figure out which node is the least loaded. The default is 1.0 on Unix platforms and 1/NCPUS on Windows (where NCPUS is the number of CPUs in the node's computer). Note that, if Unix and Windows machines are part of a replica group , the Unix and Windows figures are not directly comparable, but the registry still makes an attempt to pick the least-loaded node.	No
<code>name</code>	The name must be unique among all nodes in the registry. Within the node, child elements can refer to its name using the reserved variable <code>\${node}</code> . An <code>icegridnode</code> process representing this node must be started on the desired computer and its configuration property <code>IceGrid.Node.Name</code> must match this attribute.	Yes

Here is an example to demonstrate the use of this element:

XML

```
<node name="Node1" load-factor="2.0">
  <description>A description of this node.</description>
  <server id="Server1" ...>
    <property name="NodeName" value="${node}" />
    ...
  </server>
</node>
```

See Also

- [Application Descriptor Element](#)
- [Load Balancing](#)
- [Object Adapter Replication](#)
- `icegridnode`

Object Descriptor Element

An `object` element defines a [well-known object](#) in the IceGrid registry. Clients can refer to this object using only its identity, or they can search for well-known objects of a specific type.

This element may only appear as a child of an `adapter` element or a `replica-group` element.

The following attributes are supported:

Attribute	Description	Required
<code>identity</code>	Specifies the identity by which this object is known.	Yes
<code>property</code>	Specifies the name of a property to generate that contains the stringified identity of the object. This attribute is only allowed if this <code>object</code> element is a child of an <code>adapter</code> element.	No
<code>type</code>	An arbitrary string used to group objects. By convention, the string represents the most-derived Slice <code>type ID</code> of the object, but an application is free to use another convention.	No
<code>proxy-options</code>	The proxy options to use for the proxy of the well-known object return by IceGrid.	No

Here is an example to demonstrate the use of this element:

XML

```

<adapter name="MyAdapter" id="WellKnownAdapter" ...>
  <object identity="WellKnownObject"
type="::Module::WellKnownInterface" proxy-options="-o"/>
</adapter>

```

In the configuration above, the object can be located via the equivalent proxies `WellKnownObject` and `WellKnownObject@WellKnownAdapter`.

See Also

- [Well-Known Objects](#)
- [Adapter Descriptor Element](#)
- [Replica-Group Descriptor Element](#)
- [Type IDs](#)

Parameter Descriptor Element

A `parameter` element defines a [template](#) parameter. Template parameters must be declared with this element to be used in template instantiation.

This element may only appear as a child of a `server-template` element or a `service-template` element.

The following attributes are supported:

Attribute	Description	Required
<code>name</code>	The name of the parameter. For example, if <code>index</code> is used as the name of a parameter, it can be referenced using <code>\${index}</code> in the server or service template.	Yes
<code>default</code>	An optional default value for the parameter. This value is used if the parameter is not defined when a server or service is instantiated.	No

Here is an example to demonstrate the use of this element:

XML

```
<server-template id="MyServerTemplate">
  <parameter name="index"/>
  <parameter name="exepath" default="/opt/myapp/bin/server"/>
  ...
</server-template>
```

See Also

- [IceGrid Templates](#)
- [Server-Template Descriptor Element](#)
- [Service-Template Descriptor Element](#)
- [Using Descriptor Variables and Parameters](#)

Properties Descriptor Element

The `properties` element is used in three situations:

- as a named property set if the `id` attribute is specified
- as a reference to a named property set if the `refid` attribute is specified
- as an unnamed property set if the `id` or `refid` attributes are not specified.

A property set is useful for defining a set of [properties](#) (a named property set) in application or node descriptors. Named property sets can be included in named or unnamed property sets with property set references.

A named property set element may only be a child of an [application](#) element or a [node](#) element. An unnamed property set element may only be a child of a [server](#), [icebox](#), [service](#), [server-instance](#) or [service-instance](#) element. An unnamed property set element with the `service` attribute defined may only be a child of a [server-instance](#) element. A reference to a named property set can only be a child of a named or unnamed property set element.

The following attributes are supported:

Attribute	Description	Required
<code>id</code>	Defines a new named property set with the given identifier. The identifier must be unique among all named property sets defined in the same scope. If not specified, the <code>properties</code> element refers to an unnamed property set or a property set reference.	No
<code>refid</code>	Defines a reference to the named property set with the given identifier. If not specified, the element refers to an unnamed or named property set.	No
<code>service</code>	Specifies the name of an IceBox service that is defined in the enclosing <code>server-instance</code> descriptor. The server instance must be an IceBox server that includes a service with the given name. An unnamed property set with this attribute defined extends the properties of the service. If not specified, the unnamed property set extends the properties of the server instance.	No

Here is an example to demonstrate the use of this element:

XML

```
<application name="Simple">
  <properties id="Debug">
    <property name="Ice.Trace.Network" value="1"/>
  </properties>

  <server id="MyServer" exe="./server">
    <properties>
      <properties refid="Debug"/>
      <property name="AppProperty" value="1"/>
    </properties>
  </server>
</application>
```

See Also

- [Properties and Configuration](#)
- [Application Descriptor Element](#)
- [Node Descriptor Element](#)
- [Server Descriptor Element](#)
- [IceBox Descriptor Element](#)
- [Service Descriptor Element](#)
- [Server-Instance Descriptor Element](#)
- [Service-Instance Descriptor Element](#)

Property Descriptor Element

An IceGrid node generates a [configuration file](#) for each of its servers and services. This file generally should not be edited manually because any changes are lost the next time the node generates the file. The `property` element is the correct way to define additional properties in a configuration file.

Note that IceGrid [administrative utilities](#) can retrieve the configuration properties of a server or service via the [administrative facility](#).

This element may only appear as a child of a `server` element, a `service` element, an `icebox` element or a `properties` element.

The following attributes are supported:

Attribute	Description	Required
name	Specifies the property name.	Yes
value	Specifies the property value. If not defined, the value is an empty string.	No

Here is an example to demonstrate the use of this element:

XML

```
<server id="MyServer" ...>
  <property name="Ice.ThreadPool.Server.SizeMax" value="10"/>
  ...
</server>
```

This `property` element adds the following definition to the server's configuration file:

```
Ice.ThreadPool.Server.SizeMax=10
```

See Also

- [Properties and Configuration](#)
- [icegridadmin Command Line Tool](#)
- [IceGrid and the Administrative Facility](#)
- [Server Descriptor Element](#)
- [Service Descriptor Element](#)
- [IceBox Descriptor Element](#)
- [Properties Descriptor Element](#)

Replica-Group Descriptor Element

A `replica-group` element creates a virtual object adapter in order to provide [replication](#) and [load balancing](#) for a collection of object adapters. An `adapter` element declares its membership in a group by identifying the desired replica group. The element may declare [well-known objects](#) that are available in all of the participating object adapters. A `replica-group` element may contain a `load-balancing` child element that specifies the load-balancing algorithm the registry should use when resolving locate requests. If not specified, the registry uses a random load balancing policy with the number of replicas set to 0.

This element may only appear as a child of an `application` element.

The following attributes are supported:

Attribute	Description	Required
<code>id</code>	Specifies the identifier of the replica group, which must be unique among all adapters and replica groups in the registry. This identifier can be used in indirect proxies in place of an adapter identifier.	Yes
<code>proxy-options</code>	The proxy options to use for well-known object proxies declared with this replica group.	No

An optional nested `description` element provides free-form descriptive text.

Here is an example to demonstrate the use of this element:

XML

```
<application name="MyApp">
  <replica-group id="ReplicatedAdapter" proxy-options="-e 1.0">
    <load-balancing type="adaptive" load-sample="15"
n-replicas="3"/>
    <description>A description of this replica group.</description>
    <object identity="WellKnownObject" .../>
  </replica-group>
  ...
</application>
```

In this example, the proxy `WellKnownObject` is equivalent to the proxy `WellKnownObject@ReplicatedAdapter`.

See Also

- [Object Adapter Replication](#)
- [Load Balancing](#)
- [Adapter Descriptor Element](#)
- [Application Descriptor Element](#)
- [Description Descriptor Element](#)
- [Well-Known Objects](#)

Server Descriptor Element

A `server` element defines a server to be deployed on a node. It typically contains at least one `adapter` element, and may supply additional information such as `command-line options`, `environment variables`, `configuration properties`, and a `server distribution`.

This element may only appear as a child of a `node` element or a `server-template` element.

The following attributes are supported:

Attribute	Description	Required
<code>activation</code>	Specifies whether the server's <code>activation mode</code> . Legal values are <code>manual</code> , <code>on-demand</code> , <code>always</code> and <code>session</code> . If not specified, <code>manual</code> activation is used by default.	No
<code>activation-timeout</code>	Defines the number of seconds a node will wait for the server to <code>activate</code> . If the timeout expires, a client waiting to receive the endpoints of an object adapter in this server will receive an empty set of endpoints. If not defined, the default timeout is the value of the <code>IceGrid.Node.WaitTime</code> property configured for the server's node.	No
<code>allocatable</code>	Specifies whether the server can be <code>allocated</code> . A server is allocated implicitly when one of its allocatable objects is allocated. The value of this attribute is ignored if the server activation mode is <code>session</code> ; a server with this activation mode is always allocatable. Otherwise, if not specified and the server activation mode is not <code>session</code> , the server is not allocatable.	No
<code>application-distrib</code>	Specifies whether this server's <code>distribution</code> is dependent on the application's distribution. If the value is <code>true</code> , the server cannot be patched until the application has been patched. If not defined, the default value is <code>true</code> .	No
<code>deactivation-timeout</code>	Defines the number of seconds a node will wait for the server to <code>deactivate</code> . If the timeout expires, the node terminates the server process. If not defined, the default timeout is the value of the node's configuration property <code>IceGrid.Node.WaitTime</code> .	No
<code>exe</code>	The pathname of the server executable.	Yes

ice-version	Specifies the Ice version in use by this server. If not defined, IceGrid assumes the server uses the same version that IceGrid itself uses. A server that uses an Ice version prior to 3.3 must define this attribute if its adapters use the <code>register-process</code> attribute. For example, a server using Ice 3.2.x should use 3.2 as the value of this attribute.	No
id	Specifies the identifier for this server. The identifier must be unique among all servers in the registry. Within the server, child elements can refer to its identifier using the <code>reserved variable</code> <code>#{server}</code> .	Yes
pwd	The default working directory for the server. If not defined, the server is started in the node's current working directory.	No
user	Specifies the name of the user account under which the server is activated and run. If a user account mapper is configured for the node, the value of this attribute is used to find the corresponding account in the map. On Unix, the node must be running as root to be able to run servers under a different user account. On Windows, or if the node is not running as root on Unix, the only permissible value for this attribute is an empty string or the name of the user account under which the node is running. On Unix, if the node is running as root and this attribute is not specified, the server is run under the user <code>#{session.id}</code> if the server activation mode is <code>session</code> or under the user <code>nobody</code> if the activation mode is <code>manual</code> , <code>on-demand</code> or <code>always</code> .	No

An optional nested `description` element provides free-form descriptive text.

Here is an example to demonstrate the use of this element:

XML

```
<server id="MyServer"
  activation="on-demand"
  activation-timeout="60"
  application-distrib="false"
  deactivation-timeout="60"
  exe="/opt/app/bin/myserver"
  pwd="/">
  <option>--Ice.Trace.Network=1</option>
  <env>PATH=/opt/Ice/bin:$PATH</env>
  <property name="ServerId" value="{server}"/>
  <adapter name="Adapter1" .../>
</server>
```

See Also

- [Adapter Descriptor Element](#)
- [Properties Descriptor Element](#)
- [Node Descriptor Element](#)
- [Server-Template Descriptor Element](#)
- [Description Descriptor Element](#)
- [Using Command Line Options in Descriptors](#)
- [Setting Environment Variables in Descriptors](#)
- [Application Distribution](#)
- [IceGrid Server Activation](#)
- [Using Descriptor Variables and Parameters](#)

Server-Instance Descriptor Element

A `server-instance` element deploys an instance of a `server-template` element on a node.

This element may only appear as a child of a `node` element.

The following attributes are supported:

Attribute	Description	Required
template	Identifies the server <code>template</code> .	Yes

All other attributes of the element must correspond to `parameters` declared by the template. The `server-instance` element must provide a value for each parameter that does not have a default value supplied by the template.

Here is an example to demonstrate the use of this element:

XML

```

<icegrid>
  <application name="SampleApp">
    <server-template id="ServerTemplate">
      <parameter name="id"/>
      <server id="${id}" activation="manual" .../>
    </server-template>
    <node name="Node1">
      <server-instance template="ServerTemplate" id="TheServer"/>
    </node>
  </application>
</icegrid>

```

See Also

- [Server-Template Descriptor Element](#)
- [Node Descriptor Element](#)
- [IceGrid Templates](#)
- [Using Descriptor Variables and Parameters](#)

Server-Template Descriptor Element

A `server-template` element defines a [template](#) for a `server` element, simplifying the task of deploying multiple instances of the same server definition. The template should contain a parameterized `server` element that is instantiated using a `server-instance` element.

This element may only appear as a child of an `application` element.

The following attributes are supported:

Attribute	Description	Required
id	Specifies the identifier for the server template. This identifier must be unique among all server templates in the application.	Yes

A template may declare [parameters](#) that are used to instantiate the `server` element. You can define a default value for each parameter. Parameters without a default value are considered mandatory and values for them must be supplied by the `server-instance` element.

Here is an example to demonstrate the use of this element:

XML

```

<icegrid>
  <application name="SampleApp">
    <server-template id="ServerTemplate">
      <parameter name="id"/>
      <server id="${id}" activation="manual" .../>
    </server-template>
    <node name="Node1">
      <server-instance template="ServerTemplate" id="TheServer"/>
    </node>
  </application>
</icegrid>

```

See Also

- [IceGrid Templates](#)
- [Server Descriptor Element](#)
- [Server-Instance Descriptor Element](#)
- [Application Descriptor Element](#)
- [Using Descriptor Variables and Parameters](#)

Service Descriptor Element

A `service` element defines an `IceBox` service. It typically contains at least one `adapter` element, and may supply additional information such as [configuration properties](#).

This element may only appear as a child of an `icebox` element or a `service-template` element.

The following attributes are supported:

Attribute	Description	Required
<code>entry</code>	Specifies the entry point of this service.	Yes
<code>name</code>	Specifies the name of this service. Within the service, child elements can refer to its name using the reserved variable <code>\${service}</code> .	Yes

An optional nested `description` element provides free-form descriptive text.

Here is an example to demonstrate the use of this element:

XML

```
<icebox id="MyIceBox" ...>
  <service name="Service1" entry="service1:Create">
    <description>A description of this service.</description>
    <property name="ServiceName" value="${service}"/>
    <adapter name="MyAdapter" id="${service}Adapter" .../>
  </service>
  <service name="Service2" entry="service2:Create"/>
</icebox>
```

See Also

- [IceBox](#)
- [Adapter Descriptor Element](#)
- [Properties Descriptor Element](#)
- [IceBox Descriptor Element](#)
- [Service-Template Descriptor Element](#)
- [IceBox Integration with IceGrid](#)

Service-Instance Descriptor Element

A `service-instance` element creates an instance of a `service-template` element in an `IceBox` server.

This element may only appear as a child of an `icebox` element.

The following attributes are supported:

Attribute	Description	Required
<code>template</code>	Identifies the service <code>template</code> .	Yes

All other attributes of the element must correspond to `parameters` declared by the template. The `service-instance` element must provide a value for each parameter that does not have a default value supplied by the template.

Here is an example to demonstrate the use of this element:

XML
<pre><icebox id="IceBoxServer" ...> <service-instance template="ServiceTemplate" name="Service1"/> </icebox></pre>

See Also

- [Service-Template Descriptor Element](#)
- [IceBox Descriptor Element](#)
- [IceGrid Templates](#)
- [IceBox Integration with IceGrid](#)

Service-Template Descriptor Element

A `service-template` element defines a [template](#) for a `service` element, simplifying the task of deploying multiple instances of the same service definition. The template should contain a parameterized `service` element that is instantiated using a `service-instance` element.

This element may only appear as a child of an `application` element.

The following attributes are supported:

Attribute	Description	Required
id	Specifies the identifier for the service template. This identifier must be unique among all service templates in the application.	Yes

A template may declare [parameters](#) that are used to instantiate the `service` element. You can define a default value for each parameter. Parameters without a default value are considered mandatory and values for them must be supplied by the `service-instance` element.

Here is an example to demonstrate the use of this element:

XML

```

<icegrid>
  <application name="IceBoxApp">
    <service-template id="ServiceTemplate">
      <parameter name="name"/>
      <service name="{name}" entry="DemoService:create">
        <adapter name="{service}" .../>
      </service>
    </service-template>
    <node name="Node1">
      <icebox id="IceBoxServer" ...>
        <service-instance template="ServiceTemplate"
name="Service1"/>
      </icebox>
    </node>
  </application>
</icegrid>

```

See Also

- [IceGrid Templates](#)
- [Service Descriptor Element](#)
- [Service-Instance Descriptor Element](#)
- [IceBox Integration with IceGrid](#)
- [Using Descriptor Variables and Parameters](#)

Variable Descriptor Element

A `variable` element defines a [variable](#).

This element may only appear as a child of an [application](#) element or [node](#) element.

The following attributes are supported:

Attribute	Description	Required
name	Specifies the variable name. The value of this variable is substituted whenever its name is used in variable syntax, as in <code>\${name}</code> .	Yes
value	Specifies the variable value. If not defined, the default value is an empty string.	No

Here is an example to demonstrate the use of this element:

XML

```

<icegrid>
  <application name="SampleApp">
    <variable name="Var1" value="foo"/>
    <variable name="Var2" value="${Var1}bar"/>
    ...
  </application>
</icegrid>

```

See Also

- [Using Descriptor Variables and Parameters](#)
- [Application Descriptor Element](#)
- [Node Descriptor Element](#)

Using Command Line Options in Descriptors

[Server descriptors](#) and [IceBox descriptors](#) may specify command-line options that the node will pass to the program at startup. As the node prepares to execute the server, it assembles the command by appending options to the server executable's pathname.

In XML, you define a command-line option using the `option` element:

```

XML

<server id="Server1" ...>
  <option>--Ice.Trace.Protocol</option>
  ...
</server>
```

The node preserves the order of options, which is especially important for Java servers. For example, JVM options must appear before the class name, as shown below:

```

XML

<server id="JavaServer" exe="java" ...>
  <option>-Xnoclassgc</option>
  <option>ServerClassName</option>
  <option>--Ice.Trace.Protocol</option>
  ...
</server>
```

The node translates these options into the following command:

```

java -Xnoclassgc ServerClassName --Ice.Trace.Protocol
```

See Also

- [Server Descriptor Element](#)
- [IceBox Descriptor Element](#)

Setting Environment Variables in Descriptors

Server descriptors and IceBox descriptors may specify environment variables that the node will define when starting a server. An environment variable definition uses the familiar *name=value* syntax, and you can also refer to other environment variables within the value. The exact syntax for variable references depends on the platform on which the server's descriptor is deployed.

On a Unix platform, the Bourne shell syntax is required:

```
LD_LIBRARY_PATH=/opt/Ice/lib:$LD_LIBRARY_PATH
```

On a Windows platform, the syntax uses the conventional style:

```
PATH=C:\Ice\lib;%PATH%
```

In XML, the `env` element supplies a definition for an environment variable:

XML

```
<node name="UnixBox">
  <server id="UnixServer" exe="/opt/app/bin/server" ...>
    <env>LD_LIBRARY_PATH=/opt/Ice/lib:$LD_LIBRARY_PATH</env>
    ...
  </server>
</node>
<node name="WindowsBox">
  <server id="WindowsServer" exe="C:/app/bin/server.exe" ...>
    <env>PATH=C:\Ice\lib;%PATH%</env>
    ...
  </server>
</node>
```

If a value refers to an environment variable that is not defined, the reference is substituted with an empty string.

Environment variable definitions may also refer to [descriptor variables and template parameters](#):

XML

```
<node name="UnixBox">
  <server id="UnixServer" exe="/opt/app/bin/server" ...>
    <env>PATH=${server.distrib}/bin:$PATH</env>
    ...
  </server>
</node>
```

On Unix, an environment variable `VAR` can be referenced as `$VAR` or `${VAR}`. You must be careful when using the latter syntax because IceGrid assumes `${VAR}` refers to a descriptor variable or parameter and will report an error if no match is found. If you prefer to use this style to refer to environment variables, you must escape these occurrences as shown in the example below:

```
<node name="UnixBox">
  <server id="UnixServer" exe="/opt/app/bin/server" ...>
    <env>PATH=${server.distrib}/bin:${PATH}</env>
    ...
  </server>
</node>
```

IceGrid does not attempt to perform [substitution](#) on `$$ {PATH}`, but rather removes the leading `$` character and then performs environment variable substitution on `$$ {PATH}`.

See Also

- [Server Descriptor Element](#)
- [IceBox Descriptor Element](#)
- [Using Descriptor Variables and Parameters](#)

Using Descriptor Variables and Parameters

Variable descriptors allow you to define commonly-used information once and refer to them symbolically throughout your application descriptors.

On this page:

- [Descriptor Substitution Syntax](#)
 - [Limitations](#)
 - [Escaping a Variable](#)
- [Special Descriptor Variables](#)
- [Descriptor Variable Scoping Rules](#)
 - [Resolving a Reference](#)
 - [Template Parameters](#)
 - [Modifying a Variable](#)

Descriptor Substitution Syntax

Substitution for a variable or parameter VP is attempted whenever the symbol $\${VP}$ is encountered, subject to the limitations and rules described below. Substitution is case-sensitive, and a fatal error occurs if VP is not defined.

Limitations

Substitution is only performed in string values, and excludes the following cases:

- Identifier of a template descriptor definition

```
<server-template id="\${invalid}" ...>
```

- Name of a variable definition

```
<variable name="\${invalid}" ...>
```

- Name of a template parameter definition

```
<parameter name="\${invalid}" ...>
```

- Name of a template parameter assignment

```
<server-instance template="T" \${invalid}="val" ...>
```

- Name of a node definition

```
<node name="\${invalid}" ...>
```

- Name of an application definition

```
<application name="\${invalid}" ...>
```

Substitution is not supported for values of other types. The example below demonstrates an invalid use of substitution:

```
<variable name="register" value="true"/>
<node name="Node">
  <server id="Server1" ...>
    <adapter name="Adapter1" register-process="\${register}" .../>
```

In this case, a variable cannot supply the value of `register-process` because that attribute expects a boolean value, not a string.

Most values are strings, however, so this limitation is rarely a problem.

Escaping a Variable

You can prevent substitution by escaping a variable reference with an additional leading `$` character. For example, in order to assign the literal string `\${abc}` to a variable, you must escape it as shown below:

```
<variable name="x" value="\$\${abc}" />
```

The extra `$` symbol is only meaningful when immediately preceding a variable reference, therefore text such as `US$$55` is not modified. Each occurrence of the characters `$$` preceding a variable reference is replaced with a single `$` character, and that character does not initiate a variable reference. Consider these examples:

```
<variable name="a" value="hi" />
<variable name="b" value="\$\${a}" />
<variable name="c" value="\$\$\${a}" />
<variable name="d" value="\$\$\$\${a}" />
```

After substitution, `b` has the value `\${a}`, `c` has the value `\$hi`, and `d` has the value `\$\${a}`.

Special Descriptor Variables

IceGrid defines a set of read-only variables to hold information that may be of use to descriptors. The names of these variables are reserved and cannot be used as variable or parameter names. The table describes the purpose of each variable and defines the context in which it is valid.

Reserved Name	Description
<code>application</code>	The name of the enclosing application.
<code>application.distrib</code>	The pathname of the enclosing application's <code>distribution</code> directory, and an alias for <code>\\${node.datadir}/distrib/\\${application}</code> .
<code>node</code>	The name of the enclosing node.

<code>node.os</code>	The name of the enclosing node's operating system. On Unix, this value is provided by <code>uname</code> . On Windows, the value is <code>Windows</code> .
<code>node.hostname</code>	The host name of the enclosing node.
<code>node.release</code>	The operating system release of the enclosing node. On Unix, this value is provided by <code>uname</code> . On Windows, the value is obtained from the <code>OSVERSIONINFO</code> data structure.
<code>node.version</code>	The operating system version of the enclosing node. On Unix, this value is provided by <code>uname</code> . On Windows, the value represents the current service pack level.
<code>node.machine</code>	The machine hardware name of the enclosing node. On Unix, this value is provided by <code>uname</code> . On Windows, the value can be <code>x86</code> , <code>x64</code> , or <code>IA64</code> , depending on the machine architecture.
<code>node.datadir</code>	The absolute pathname of the enclosing node's data directory.
<code>server</code>	The ID of the enclosing server.
<code>server.distrib</code>	The pathname of the enclosing server's <code>distribution</code> directory, and an alias for <code>\${node.datadir}/servers/\${server}/distribution</code> .
<code>service</code>	The name of the enclosing service.
<code>session.id</code>	The client session identifier. For sessions created with a user name and password, the value is the user ID; for sessions created from a secure connection, the value is the distinguished name associated with the connection.

The availability of a variable is easily determined in some cases, but may not be readily apparent in others. For example, the following example represents a valid use of the `${node}` variable:

XML

```

<icegrid>
  <application name="App">
    <server-template id="T" ...>
      <parameter name="id"/>
      <server id="${id}" ...>
        <property name="NodeName" value="${node}"/>
        ...
      </server>
    </server-template>
    <node name="TheNode">
      <server-instance template="T" id="TheServer"/>
    </node>
  </application>
</icegrid>

```

Although the server template descriptor is defined as a child of an application descriptor, its variables are not evaluated until it is instantiated. Since a template *instance* is always enclosed within a node, it is able to use the `${node}` variable.

Descriptor Variable Scoping Rules

Descriptors may only define variables at the application and node levels. Each node introduces a new scope, such that defining a variable at the node level overrides (but does not modify) the value of an application variable with the same name. Similarly, a template parameter overrides the value of a variable with the same name in an enclosing scope. A descriptor may refer to a variable defined in any enclosing scope, but its value is determined by the nearest scope. The following figure illustrates these concepts:

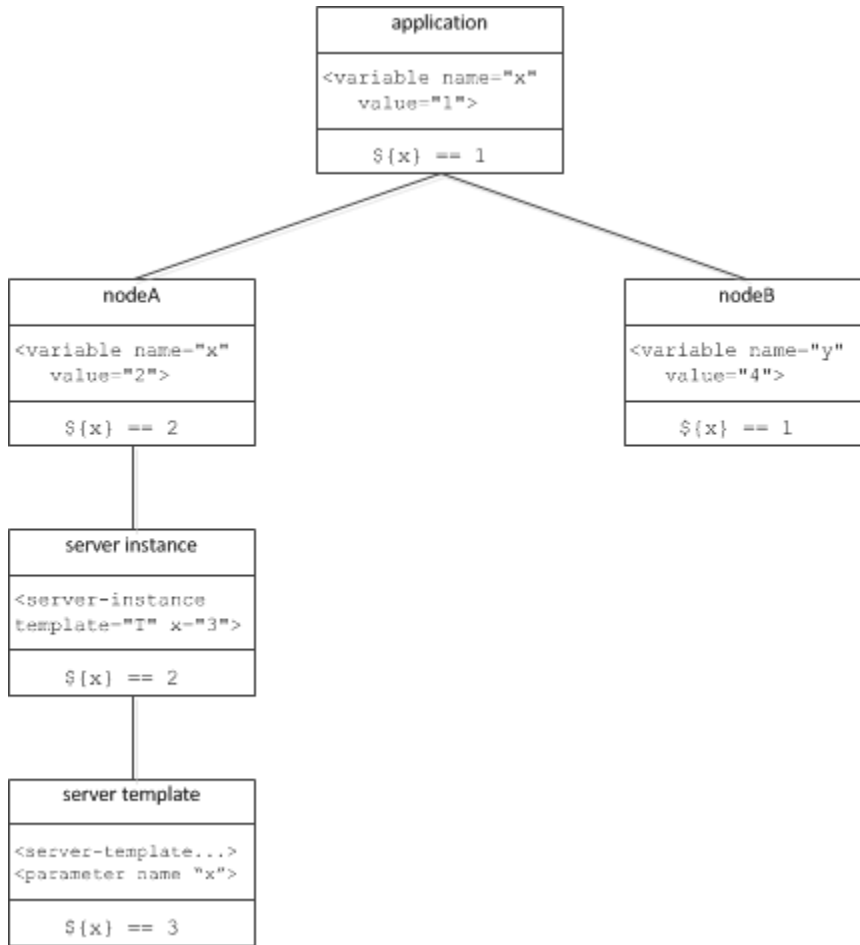

Variable scoping semantics.

In this diagram, the variable `x` is defined at the application level with the value 1. In `nodeA`, `x` is overridden with the value 2, whereas `x` remains unchanged in `nodeB`. Within the context of `nodeA`, `x` continues to have the value 2 in a server instance definition. However, when `x` is used as the name of a template parameter, the node's definition of `x` is overridden and `x` has the value 3 in the template's scope.

Resolving a Reference

To resolve a variable reference `${var}`, IceGrid searches for a definition of `var` using the following order of precedence:

1. Pre-defined variables
2. Template parameters, if applicable
3. Node variables, if applicable
4. Application variables

After the initial substitution, any remaining references are resolved recursively using the following order of precedence:

1. Pre-defined variables
2. Node variables, if applicable
3. Application variables

Template Parameters

Template parameters are not visible in nested template instances. This situation can only occur when an IceBox server template instantiates a service template, as shown in the following example:

XML
<pre> <icegrid> <application name="IceBoxApp"> <service-template id="ServiceTemplate"> <parameter name="name"/> <service name="{name}" entry="DemoService:create"> ... <property name="{name}.Identity" value="{id}-{name}"/> <!-- WRONG! --> </service> </service-template> <server-template id="ServerTemplate"> <parameter name="id"/> <icebox id="{id}" endpoints="default" ...> <service-instance template="ServiceTemplate" name="Service1"/> </icebox> </server-template> <node name="Node1"> <server-instance template="ServerTemplate" id="IceBoxServer"/> </node> </application> </icegrid> </pre>

The service template incorrectly refers to `id`, which is a parameter of the server template.

Template parameters can be referenced only in the body of a template; they cannot be used to define other parameters. For example, the following is illegal:

XML
<pre> <server-template id="ServerTemplate"> <parameter name="par1"/> <parameter name="par2" default="{par1}"/> ... </server-template> </pre>

Modifying a Variable

A variable definition can be overridden in an inner scope, but the inner definition does not modify the outer variable. If a variable is defined multiple times in the same scope (which is only relevant in XML definitions), the most recent definition is used for all references to that variable. Consider the following example:

XML

```
<application name="MyApp">
  <variable name="x" value="1"/>
  <variable name="y" value="{x}"/>
  <variable name="x" value="2"/>
  ...
</application>
```

When descriptors such as these are created, IceGrid validates their variable references but does not perform substitution until the descriptor is acted upon (such as when a node is generating a configuration file for a server). As a result, the value of *y* in the above example is 2 because that is the most recent definition of *x*.

See Also

- [Variable Descriptor Element](#)
- [IceGrid Templates](#)
- [Application Distribution](#)
- [Variables in IceGrid Descriptors](#)

IceGrid Property Set Semantics

Ice servers and clients are configured with [properties](#). For servers [deployed](#) with IceGrid, these properties are automatically generated into a configuration file from the information contained in the application descriptor. The settings in that configuration file are passed to server via the `--Ice.Config` command-line option.

[Property descriptors](#) allow you to define property sets to efficiently manage and specify properties. Here are some of the benefits of using property sets:

- You can define sets of properties at the [application](#) or [node](#) element level and reference these properties in other property sets.
- You can specify properties for a specific [server](#) or [service](#) instance.

There are two kinds of property sets:

- **Named property sets**
Named property sets are defined at the application or node level. They are useful only as the target of references from other property sets. Specifically, a named property set has no effect unless you reference it from a [server](#) descriptor.
- **Unnamed property sets**
Unnamed property sets can be defined in [server](#), [service](#), [icebox](#), [server-instance](#) or [service-instance](#) elements and define the properties for a server or service. Unnamed property sets can reference named property sets.

Named and unnamed property sets are defined with the same [properties](#) descriptor. The context and the attributes of a [properties](#) element distinguish named property sets from unnamed property sets. Here is an example that defines a named and an unnamed property set:

XML

```

<application name="App">
  <properties id="Debug">
    <property name="UseDebug" value="1"/>
  </properties>

  <node name="TheNode">
    <server id="TheServer" exe="./server">
      <properties>
        <property name="Identity" value="hello"/>
      </properties>
    </server>
  </node>
</application>

```

In this example, we define the named property set `Debug` and the unnamed property set of the server `TheServer`. The server configuration will contain only the `Identity` property because the server property set does not reference the `Debug` named property set.

The `properties` element is used to reference a named property set: if a `properties` element appears inside another `properties` element, it is a reference to another property set and it must specify the `refid` attribute. With the previous example, to reference the `Debug` property set, we would write the following:

XML

```

<application name="App">
  <properties id="Debug">
    <property name="UseDebug" value="1"/>
  </properties>

  <node name="TheNode">
    <server id="TheServer" exe="./server">
      <properties>
        <properties refid="Debug"/>
        <property name="Identity" value="hello"/>
      </properties>
    </server>
  </node>
</application>

```

Property sets, whether named or unnamed, are evaluated as follows:

1. Within a `properties` element, IceGrid locates all references to named property sets and evaluates all property settings in the referenced property sets.
2. Explicit property definitions following any named references are then evaluated and added to the property set formed in the preceding step. This means that explicit property settings override corresponding settings in any referenced property sets.

It is illegal to define a reference to a property set after setting a property value, so references to property sets must precede property definitions. For example, the following is illegal:

XML

```

<properties>
  <property name="Prop1" value="Value1"/>
  <properties refid="Ref1"/>
</properties>

```

Just as the order of the property definitions is important, the order of property set references is also important. For example, the following two property sets are not equivalent:

XML

```

<properties>
  <properties refid="Ref1"/>
  <properties refid="Ref2"/>
</properties>

<properties>
  <properties refid="Ref2"/>
  <properties refid="Ref1"/>
</properties>

```

Named property sets are evaluated at the point of definition. If you reference other property sets or use variables in a named property set definition, you must make sure that the referenced property sets or variables are defined in the same scope. For example, the following is correct:

XML
<pre> <application name="App"> <variable name="level" value="1"/> <properties id="DebugApp"> <property name="DebugLevel value="{level}"> </properties> </application> </pre>

However, the following example is wrong because the `{level}` variable is not defined at the application scope:

XML
<pre> <application name="App"> <properties id="DebugApp"> <property name="DebugLevel value="{level}"> </properties> <node name="TheNode"> <variable name="level" value="1"/> </node> </application> </pre>

If both the application and the node define the `{level}` variable, the value of the `{level}` variable in the `DebugApp` property set will be the value of the variable defined in the application descriptor.

So far, we have seen the definition of an unnamed property set only in a server descriptor. However, it is also possible to define an unnamed property set for server or service instances. This is a good way to specify or override properties specific to a server or service instance. For example:

XML

```

<application name="TheApp">
  <server-template id="Template">

    <parameter name="instance-name"/>

    <server id="{instance-name}" exe="./server">
      <properties>
        <property name="Timeout" value="30"/>
      </properties>
    </server>
  </server-template>

  <node name="TheNode">
    <server-instance template="Template" instance-name="MyInst">
      <properties>
        <property name="Debug" value="1"/>
        <property name="Timeout" value="-1"/>
      </properties>
    </server-instance>
  </node>
</application>

```

Here, the server instance overrides the `Timeout` property and defines an additional `Debug` property.

The server or service instance properties are evaluated as follows:

1. The unnamed property set from the template server or service descriptor is evaluated.
2. The unnamed property set from the server or service instance descriptor is evaluated and the resulting properties are added to the property set formed in the preceding step. This means that property settings in a server or service instance descriptor override corresponding settings in a template server or service descriptor.

The server or service instance unnamed property set and its parameters provide two different ways to customize the properties of a server or service template instance. It might not always be obvious which method to use: is it better to use a parameter to parameterize a given property or is it better to just specify it in the server or service instance property set?

For example, in the previous descriptor, we could have used a parameter with a default value for the `Timeout` property:

XML

```

<application name="TheApp">
  <server-template id="Template">

    <parameter name="instance-name"/>
    <parameter name="timeout" default="30"/>

    <server id="{instance-name}" exe="./server">
      <properties>
        <property name="Timeout" value="{timeout}"/>
      </properties>
    </server>
  </server-template>

  <node name="TheNode">
    <server-instance template="Template"
instance-name="MyInst" timeout="-1">
      <properties>
        <property name="Debug" value="1"/>
      </properties>
    </server-instance>
  </node>
</application>

```

Here are some guidelines to help you decide whether to use a parameter or a property:

- Use a parameter for a property that should always be set.
- Use a parameter if you want to make the property obvious to the reader and user of the template.
- Do not use a parameter for optional properties if you want to rely on a default value for the server.
- Do not use parameters for properties that are rarely used.

See Also

- [Properties and Configuration](#)
- [Using IceGrid Deployment](#)
- [Properties Descriptor Element](#)
- [Application Descriptor Element](#)
- [Node Descriptor Element](#)
- [Server-Instance Descriptor Element](#)
- [Service-Instance Descriptor Element](#)

IceGrid XML Features

IceGrid provides some convenient features to simplify the task of defining descriptors in XML.

On this page:

- [Adding Flexibility with Targets](#)
- [Including Descriptor Files](#)

Adding Flexibility with Targets

An IceGrid XML file may contain optional definitions that are [deployed](#) only when specifically requested. These definitions are called targets and must be defined within a `target` element. The elements that may legally appear within a `target` element are determined by its enclosing element. For example, a `node` element is legal inside a `target` element of an `application` element, but not inside a `target` element of a `server` element. Each `target` element must define a value for the `name` attribute, but names are not required to be unique. Rather, targets should be considered as optional components or features of an application that are deployed in certain circumstances.

The example below defines targets named `debug` that, if requested during deployment, configure their servers with an additional property:

XML
<pre> <icegrid> <application name="MyApp"> <node name="Node"> <server id="Server1" ...> <target name="debug"> <property name="Ice.Trace.Network" value="2"/> </target> ... </server> <server id="Server2" ...> <target name="debug"> <property name="Ice.Trace.Network" value="2"/> </target> ... </server> </node> </application> </icegrid> </pre>

Target names specified in an `icegridadmin` command can be unqualified names like `debug`, in which case every target with that name is deployed, regardless of the target's nesting level. If you want to deploy targets more selectively, you can specify a fully-qualified name instead. A fully-qualified target name consists of its unqualified name prefaced by the names or identifiers of each enclosing element. For instance, a fully-qualified target name from the example above is `MyApp.Node.Server1.debug`.

Including Descriptor Files

You can include the contents of another XML file into the current file using the `include` element, which is replaced with the contents of the included file. The elements in the included file must be enclosed in an `icegrid` element, as shown in the following example:

XML

```

<!-- File: A.xml -->
<icegrid>
  <server-template id="ServerTemplate">
    <parameter name="id"/>
    ...
  </server-template>
</icegrid>

<!-- File: B.xml -->
<icegrid>
  <application name="MyApp">
    <include file="A.xml"/>
    <node name="Node">
      <server-instance template="ServerTemplate" .../>
    </node>
  </application>
</icegrid>

```

In `B.xml`, the `include` element identifies the name of the file to include using the `file` attribute. The top-level `icegrid` element is discarded from `A.xml` and its contents are inserted at the position of the `include` element in `B.xml`.

Note that the file name of an included file is relative to the application descriptor, not relative to the working directory.

You can include [specific targets](#) from a file by specifying their names in the optional `targets` attribute. If multiple targets are included, their names must be separated by whitespace. The example below illustrates the use of a target:

XML

```
<!-- File: A.xml -->
<icegrid>
  <server-template id="ServerTemplate">
    <parameter name="id"/>
    ...
  </server-template>
  <target name="targetA">
    <server-template id="AnotherTemplate">
      ...
    </server-template>
  </target>
</icegrid>

<!-- File: B.xml -->
<icegrid>
  <application name="MyApp">
    <include file="A.xml" targets="targetA"/>
    <node name="Node">
      <server-instance template="ServerTemplate" .../>
      <server-instance template="AnotherTemplate" .../>
    </node>
  </application>
</icegrid>
```

See Also

- [Using IceGrid Deployment](#)
- [icegridadmin Command Line Tool](#)

IceGrid Server Reference

Topics

- [icegridregistry](#)
- [icegridnode](#)
- [Well-Known Registry Objects](#)
- [IceGrid Persistent Data](#)
- [Promoting a Registry Slave](#)

icegridregistry

The IceGrid registry is a centralized repository of information, including [deployed applications](#) and [well-known objects](#). A registry can optionally be collocated with an IceGrid node, which conserves resources and can be convenient during development and testing. The registry server is implemented by the `icegridregistry` executable.

On this page:

- [Command Line Options for icegridregistry](#)
- [Configuring Registry Endpoints](#)
- [Registry Security Considerations](#)
- [Configuring a Data Directory for the Registry](#)
- [Registry Configuration Example](#)

Command Line Options for icegridregistry

The registry supports the following command-line options:

```
$ icegridregistry -h
Usage: icegridregistry [options]
Options:
-h, --help           Show this message.
-v, --version        Display the Ice version.
--nowarn            Don't print any security warnings.
--readonly          Start the master registry in read-only mode.
--initdb-from-replica=<replica>
                    Initialize the database from the given replica.
```

The `--readonly` option prevents any updates to the registry's database; it also prevents slaves from synchronizing their databases with this master. This option is useful when you need to verify that the master registry's database is correct after [promoting a slave](#) to become the new master. The `--initdb-from-replica` option, added in Ice 3.5.1, allows you to initialize the database from another registry replica. This option is useful when you need to start a new master with the contents of a slave database.

Additional command line options are supported, including those that allow the registry to run as a [Windows service](#) or [Unix daemon](#), and Ice includes a [utility](#) to help you install an IceGrid registry as a Windows service.

Configuring Registry Endpoints

The IceGrid registry creates up to five sets of endpoints, configured with the following properties:

- [IceGrid.Registry.Client.Endpoints](#)
Client-side endpoints supporting the following interfaces:
 - `Ice::Locator`
 - `IceGrid::Query`
 - `IceGrid::Registry`
 - `IceGrid::Session`
 - `IceGrid::AdminSession`
 - `IceGrid::Admin`



There are security implications in allowing access to administrative sessions, as explained in the next section.

- [IceGrid.Registry.Server.Endpoints](#)
Server-side endpoints for object adapter registration.

- `IceGrid.Registry.SessionManager.Endpoints`
Optional endpoints for delegating [session authentication](#) to a [Glacier2 router](#).
- `IceGrid.Registry.AdminSessionManager.Endpoints`
Optional endpoints for delegating [administrative session authentication](#) to a [Glacier2 router](#).
- `IceGrid.Registry.Internal.Endpoints`
Internal endpoints used by IceGrid nodes and registry replicas. This property must be defined even if no nodes or replicas are being used.

Registry Security Considerations

A client that successfully establishes an [administrative session](#) with the registry has the ability to compromise the security of the registry host. As a result, it is imperative that you configure the registry carefully if you intend to allow the use of administrative sessions.

Administrative sessions are disabled unless you explicitly configure the registry to use an authentication mechanism. To allow authentication with a user name and password, you can specify a password file using the property `IceGrid.Registry.AdminCryptPasswords` or use your own [permissions verifier](#) object by supplying its proxy in the property `IceGrid.Registry.AdminPermissionsVerifier`. Your verifier object must implement the `Glacier2::PermissionsVerifier` interface.

To authenticate administrative clients using their SSL connections, define `IceGrid.Registry.AdminSSLPermissionsVerifier` with the proxy of a verifier object that implements the `Glacier2::SSLPermissionsVerifier` interface.

Configuring a Data Directory for the Registry

You must provide an empty directory in which the registry can initialize its [databases](#). The path name of this directory is supplied by the configuration property `IceGrid.Registry.Data`.

The files in this directory must not be edited manually, but rather indirectly using one of the [administrative tools](#). To clear a registry's databases, first ensure the server is not currently running, then remove all of the files in its data directory and restart the server.

Registry Configuration Example

The registry requires values for the three mandatory endpoint properties, as well as the data directory property, as shown in the following example:

```
IceGrid.Registry.Client.Endpoints=tcp -p 4061
IceGrid.Registry.Server.Endpoints=tcp
IceGrid.Registry.Internal.Endpoints=tcp
IceGrid.Registry.Data=/opt/ripper/registry
```

In addition, we also recommend defining `IceGrid.InstanceName`, whose value affects the identities of the registry's [well-known objects](#).

The remaining configuration properties are discussed in [IceGrid Properties](#).

See Also

- [Using IceGrid Deployment](#)
- [Well-Known Objects](#)
- [Promoting a Registry Slave](#)
- [Windows Services](#)
- [Resource Allocation using IceGrid Sessions](#)
- [IceGrid Administrative Sessions](#)
- [Glacier2 Integration with IceGrid](#)
- [icegridadmin Command Line Tool](#)
- [Securing a Glacier2 Router](#)
- [IceGrid Persistent Data](#)

- [Well-Known Registry Objects](#)
- [IceGrid Properties](#)

icegridnode

An IceGrid node is a process that [activates](#), [monitors](#), and [deactivates](#) registered server processes. You can run any number of nodes in a domain, but typically there is one node per host. A node must be running on each host on which servers are activated automatically, and nodes cannot run without an IceGrid registry.

The IceGrid node server is implemented by the `icegridnode` executable. If you wish to run a registry and node in one process, `icegridnode` is the executable you must use.

On this page:

- [Command Line Options for icegridnode](#)
- [Configuring Node Endpoints](#)
- [Node Security Considerations](#)
- [Configuring a Data Directory for the Node](#)
- [Node Configuration Example](#)

Command Line Options for icegridnode

The node supports the following command-line options:

```
Usage: icegridnode [options]
Options:
-h, --help           Show this message.
-v, --version        Display the Ice version.
--nowarn             Don't print any security warnings.
--readonly           Start the collocated master registry in
                    read-only mode.
--initdb-from-replica=<replica>
                    Initialize the collocated registry database from
the
                    given replica.
--deploy DESCRIPTOR [TARGET1 [TARGET2 ...]]
                    Add or update descriptor in file DESCRIPTOR,
                    with optional targets.
```

If you are running the node with a collocated registry, the `--readonly` option prevents any updates to the registry's database; it also prevents slaves from synchronizing their databases with this master. This option is useful when you need to verify that the master registry's database is correct after [promoting a slave](#) to become the new master. The `--initdb-from-replica` option, added in Ice 3.5.1, allows you to initialize the database from another registry replica. This option is useful when you need to start a new master with the contents of a slave database.

The `--deploy` option allows an application to be [deployed](#) automatically as the node process starts, which can be especially useful during testing. The command expects the name of the XML deployment file, and optionally allows the names of the individual [targets](#) within the file to be specified.

Additional command line options are supported, including those that allow the node to run as a [Windows service](#) or [Unix daemon](#), and Ice includes a [utility](#) to help you install an IceGrid node as a Windows service.

Configuring Node Endpoints

The IceGrid node's endpoints are defined by the `IceGrid.Node.Endpoints` property and must be accessible to the registry. It is not necessary to use a fixed port because each node contacts the registry at startup to provide its current endpoint information.

Node Security Considerations

It is important that you give careful consideration to the permissions of the account under which the node runs. If the servers that the node will activate have no special [access requirements](#), and all of the servers can use the same account, it is recommended that you do not run the node under an account with system privileges, such as the root account on Unix or the Administrator account on Windows.

Configuring a Data Directory for the Node

The node requires an empty directory that it can use to store server files. The pathname of this directory is supplied by the configuration property `IceGrid.Node.Data`. To clear a node's state, first ensure the server is not currently running, then remove all of the files in its data directory and restart the server.

 The node's [data directory](#) may also contain files and subdirectories used by your application's servers, such as configuration files and Freeze database environments. Before destroying the contents of the node's data directory, make sure that all servers are stopped and any important files are backed up.

When running a collocated node and registry server, we recommend using separate directories for the registry and node data directories.

Node Configuration Example

A minimal node configuration is shown in the following example:

```
IceGrid.Node.Endpoints=tcp
IceGrid.Node.Name=Node1
IceGrid.Node.Data=/opt/ripper/node

Ice.Default.Locator=IceGrid/Locator:tcp -p 4061
```

The value of the `IceGrid.Node.Name` property must match that of a deployed node known by the registry.

The `Ice.Default.Locator` property is used by the node to contact the registry. The value is a proxy that contains the [registry's client endpoints](#).

If you wish to run a collocated registry and node server, enable the property `IceGrid.Node.CollocateRegistry` and include the [registry's configuration properties](#).

The remaining configuration properties are discussed in [IceGrid Properties](#).

See Also

- [IceGrid Server Activation](#)
- [Promoting a Registry Slave](#)
- [IceGrid Persistent Data](#)
- [Getting Started with IceGrid](#)
- [Using IceGrid Deployment](#)
- [Windows Services](#)
- [IceGrid Properties](#)

Well-Known Registry Objects

The IceGrid registry hosts several [well-known objects](#). The following table shows the default identities of these objects and their corresponding Slice interfaces:

Default Identity	Interface
IceGrid/AdminSessionManager	Glacier2::SessionManager
IceGrid/AdminSessionManager-replica	Glacier2::SessionManager
IceGrid/AdminSSLSessionManager	Glacier2::SSLSessionManager
IceGrid/AdminSSLSessionManager-replica	Glacier2::SSLSessionManager
IceGrid/Locator	Ice::Locator
IceGrid/Query	IceGrid::Query
IceGrid/Registry	IceGrid::Registry
IceGrid/Registry-replica	IceGrid::Registry
IceGrid/RegistryUserAccountMapper	IceGrid::UserAccountMapper
IceGrid/RegistryUserAccountMapper-replica	IceGrid::UserAccountMapper
IceGrid/SessionManager	Glacier2::SessionManager
IceGrid/SSLSessionManager	Glacier2::SSLSessionManager

It is a good idea to assign unique identities to these objects by configuring them with different values for the `IceGrid.InstanceName` property, as shown in the following example:

```
IceGrid.InstanceName=MP3Grid
```

This property changes the identities of the well-known objects to use MP3Grid instead of IceGrid as the identity category. For example, the identity of the locator becomes MP3Grid/Locator.

The client's configuration must also be changed to reflect the new identity:

```
Ice.Default.Locator=MP3Grid/Locator:tcp -h registryhost -p 4061
```

Furthermore, any uses of these identities in application code must be updated as well.

See Also

- [Well-Known Objects](#)

IceGrid Persistent Data

The IceGrid registry and node both store information in the data directories specified by the `IceGrid.Registry.Data` and `IceGrid.Node.Data` properties, respectively. This section describes what the registry and node are storing and discusses backup and recovery techniques.

On this page:

- [Registry Persistent Data](#)
- [Node Persistent Data](#)

Registry Persistent Data

The registry's data directory is a [Freeze](#) database environment that stores the following information:

- Applications [deployed](#) using the `addApplication` operation on the `IceGrid::Admin` interface (which includes the IceGrid GUI and command-line [administrative clients](#)). Applications specify servers, well-known objects, object adapters, replica groups, and allocatable objects. Applications can be removed with the `removeApplication` operation.
- [Well-known objects](#) registered using the `addObject` and `addObjectWithType` operations on the `IceGrid::Admin` interface. Well-known objects added by these operations can be removed using the `removeObject` operation.
- [Adapter endpoints](#) registered dynamically by servers using the `Ice::LocatorRegistry` interface. The property `IceGrid.Registry.DynamicRegistration` must be set to a value larger than zero to allow the dynamic registration of object adapters. These adapters can be removed using the `removeAdapter` operation.
- Some internal proxies used by the registry to contact nodes and other registry replicas during startup. The proxies enable the registry to notify these entities about the registry's availability.

[Client session](#) and [administrative sessions](#) established with the IceGrid registry are not persistent. If the registry is restarted, these sessions must be recreated. For client sessions in particular, this implies that objects allocated using the allocation mechanism will no longer be allocated once the IceGrid registry restarts.

If the registry's database is corrupted or lost, you must recover the deployed applications, the well-known objects, and the adapter endpoints. You do not need to worry about the internal proxies stored by the registry, as the nodes and registry replicas will eventually contact the registry again.

Depending on your deployed applications and your use of the registry, you should consider backing up the registry's database, especially if you cannot easily recover the persistent information.

For example, if you rely on dynamically-registered adapters, or on well-known objects registered programmatically via the `IceGrid::Admin` interface, you should back up the registry database because recovering this information may be difficult. On the other hand, if you only deploy a few applications from XML files, you can easily recover the applications by redeploying their XML files, and therefore backing up the database may be unnecessary.

Be aware that restarting the registry with an empty database may cause the server information stored by the nodes to be deleted. This can be an issue if the deployed servers have databases stored in the node data directory. The next section provides more information on this subject.

Node Persistent Data

The IceGrid node stores information for servers deployed by IceGrid applications. This information is stored in the `servers` subdirectory of the node's data directory. There is one subdirectory per server; the name of the subdirectory is the server's ID. Each server directory contains configuration files, and may also contain [database environments](#) and the [distribution data](#) of the server. The node's data directory also contains a `distrib` directory to store per-application distribution data. This directory contains a subdirectory for each application that specifies a distribution and has a server deployed on the node.

If a server directory is deleted, the node recreates it at startup. The node will also recreate the server configuration files and the database environment directories. However, the node cannot restore the prior contents of a server's database environment. It is your responsibility to back up these database environments and restore them when necessary. If the server or application distribution data is deleted from the node's data directory, you can easily recover the deleted information by patching these distributions again using the IceGrid administrative tools.

If you store your server database environments outside the node's data directory (such as in a directory that is regularly backed up), or if you do not have any database environments inside the node's data directory, you do not need to back up the contents of the node's data directory.

See Also

- [Freeze](#)
- [Using IceGrid Deployment](#)
- [icegridadmin Command Line Tool](#)
- [Well-Known Objects](#)
- [Object Adapter Endpoints](#)
- [Resource Allocation using IceGrid Sessions](#)
- [IceGrid Administrative Sessions](#)
- [DbEnv Descriptor Element](#)
- [Application Distribution](#)
- [IceGrid Properties](#)

Promoting a Registry Slave

In a [replicated IceGrid deployment](#), you may need to promote a slave to be the new master if the current master becomes unavailable. For example, this situation can occur when the original master cannot be restarted immediately due to a hardware problem, or when your application requires a feature that is only accessible via the master, such as the [resource allocation](#) facility or the ability to modify the [deployment data](#).

To promote a slave to become the new master, you must shut down the slave and change its `IceGrid.Registry.ReplicaName` property to `Master` (or remove the property altogether). On restart, the new master notifies the nodes and registries that were active before it was shut down. An inactive registry or node will eventually connect to the new master if its default locator proxy contains the endpoint of the new master registry or the endpoint of a slave that is connected to the new master. If you cannot afford any down-time of the registry and want to minimize the down-time of the master, you should run at least two slaves. That way, if the master becomes unavailable, there will always be one registry available while you promote one of the slaves.

With Ice versions 3.5.0 and prior, a slave synchronizes its database upon connecting to the new master, therefore it is imperative that you promote a slave whose database is valid and up-to-date. To verify that the promoted master database is up-to-date, you can start the new master with the `--readonly` command-line option. While this option is in force, the new master does not update its database, and slaves do not synchronize their databases. You can review the master database with the IceGrid [administrative tools](#) and, if the deployment looks correct, you can restart the master without the `--readonly` option to permit updates and slave synchronization.

Starting with Ice 3.5.1, a check has been added to ensure that an out-of-date master database cannot overwrite a newer slave database. In such a scenario, an error message is printed out on the consoles of the IceGrid master and slave, and the slave connection to the master is aborted. You can still connect to the slave and master with the IceGrid [administrative tools](#) to verify their databases. Once you determine which database to keep, you can restart either the slave or the master with the `--initdb-from-replica=<name>` option to initialize the out-of-date database with the correct version. This check only works when both the master and slave use Ice 3.5.1 or later.

Note that there is nothing to prevent you from running two masters. If you start two masters and they contain different versions of the deployment information, some slaves and nodes might get updated with out-of-date deployment information (causing some of your servers to be deactivated). You can correct the problem by shutting down the faulty master, but it is important to keep this issue in mind when you restart a master since it might disrupt your applications.

See Also

- [Registry Replication](#)
- [Resource Allocation using IceGrid Sessions](#)
- [Using IceGrid Deployment](#)
- [icegridadmin Command Line Tool](#)

IceGrid and the Administrative Facility

The Ice [administrative facility](#) provides a general purpose solution for administering individual Ice programs. IceGrid extends this functionality in several convenient ways:

- IceGrid automatically enables the facility in deployed servers.
- IceGrid uses the [Process facet](#) to terminate an active server, giving it an opportunity to perform an orderly shutdown.
- IceGrid provides a secure mechanism for invoking administrative operations on deployed servers.
- IceGrid administrative tools use the facility to display the [properties](#) of servers and services, and manipulate and monitor [IceBox](#) services.

We discuss each of these items in separate sections below.

On this page:

- [Enabling the Administrative Facility for a Deployed Server](#)
 - [Endpoints](#)
- [Deactivating a Deployed Server](#)
- [Routing Administrative Requests](#)
 - [Obtaining a Proxy](#)
 - [Callbacks without Glacier2](#)
 - [Callbacks with Glacier2](#)
- [Using the Administrative Facility in IceGrid Utilities](#)
 - [Properties](#)
 - [Administering IceBox Services](#)

Enabling the Administrative Facility for a Deployed Server

As we saw in our [deployment example](#), the configuration properties for a deployed server include definitions for the following properties:

- `Ice.Admin.Endpoints`
- `Ice.Admin.ServerId`

In conjunction with the `Ice.Default.Locator` property, these definitions satisfy the requirements for enabling the [administrative object adapter](#).

Endpoints

If a server's descriptor does not supply a value for `Ice.Admin.Endpoints`, IceGrid supplies the default value shown below:

```
Ice.Admin.Endpoints=tcp -h 127.0.0.1
```

For [security reasons](#), IceGrid specifies the local host interface (127.0.0.1) so that administrative access is limited to clients running on the same host. This configuration permits the IceGrid node to invoke operations on the server's [admin object](#), but prevents remote access unless the client establishes an [IceGrid administrative session](#).

Specifying a fixed port is unnecessary because the server registers its endpoints with IceGrid upon each new activation.

Deactivating a Deployed Server

An IceGrid node uses the `Ice::Process` interface to gracefully deactivate a server. In programs using Ice 3.3 or later, this interface is implemented by the administrative facet named `Process`. In earlier versions of Ice, an object adapter implemented this interface in a special servant if the adapter's `RegisterProcess` property was enabled.

Regardless of version, the Ice run time registers an `Ice::Process` proxy with the IceGrid registry when properly configured. Registration normally occurs during communicator initialization, but it can be delayed when a server needs to install its [own administrative facets](#).

When the node is ready to deactivate a server, it invokes the `shutdown` operation on the server's `Ice::Process` proxy. If the server does not terminate in a timely manner, the node asks the operating system to terminate the process. Each server can be configured with its own `deactivation timeout`. If no timeout is configured, the node uses the value of the property `IceGrid.Node.WaitTime`, which defaults to 60 seconds.

If a server does not register an `Ice::Process` proxy, the IceGrid node cannot request a graceful termination and must resort instead to a more drastic, and potentially harmful, alternative by asking the operating system to terminate the server's process. On Unix, the node sends the `SIGTERM` signal to the process and, if the server does not terminate within the deactivation timeout period, sends the `SIGKILL` signal.

On Windows, the node first sends a `Ctrl+Break` event to the server and, if the server does not stop within the deactivation timeout period, terminates the process immediately.

Servers that disable the `Process` facet can install a signal handler in order to intercept the node's notification about pending deactivation. For example, portable C++ programs could use the `IceUtil::CtrlCHandler` class for this purpose. However, we recommend that servers be allowed to use the `Process` facet when possible.

Routing Administrative Requests

IceGrid defaults to using the local host interface when defining the endpoints of a deployed server's `administrative object adapter`. This configuration allows local clients such as the IceGrid node to access the server's `admin object` while preventing direct invocations from remote clients. A server's `admin object` may still be accessed remotely, but only by clients that establish an `IceGrid administrative session`. To facilitate these requests, IceGrid uses an intermediary object that relays requests to the server via its node. For example, the following figure illustrates the path of a `getProperty` invocation:

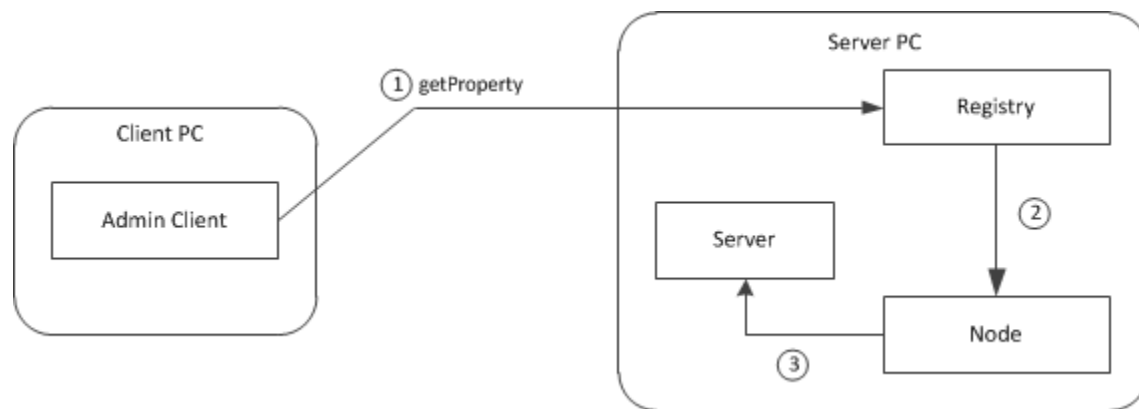

Routing for administrative requests on a server.

Obtaining a Proxy

During an `administrative session`, a client has two ways of obtaining the intermediary proxy for a server's `admin object`:

Slice

```

module IceGrid {
    interface Admin {
        idempotent string getServerAdminCategory();
        idempotent Object* getServerAdmin(string id)
            throws ServerNotExistException,
                NodeUnreachableException,
                DeploymentException;

        // ...
    };
};

```

If the client wishes to construct the proxy itself and already knows the server's ID, the client need only modify the proxy of the `IceGrid::Admin` object with a new identity. The identity's category must be the return value of `getServerAdminCategory`, while its name is the ID of the desired server. The example below demonstrates how to create the proxy and access the [Properties facet](#) of a server:

C++

```

IceGrid::AdminSessionPrx session = ...;
IceGrid::AdminPrx admin = session->getAdmin();
Ice::Identity serverAdminId;
serverAdminId.category = admin->getServerAdminCategory();
serverAdminId.name = "MyServerId";
Ice::PropertiesAdminPrx props =
    Ice::PropertiesAdminPrx::checkedCast(
        admin->ice_identity(serverAdminId), "Properties");

```

Alternatively, the `getServerAdmin` operation returns a proxy that refers to the `admin` object of the given server. This operation performs additional validation and therefore may raise one of the exceptions shown in its signature above.

Callbacks without Glacier2

IceGrid also supports the relaying of callback requests from a back-end server to an administrative client over the client's existing connection to the registry, which is especially important for a client using a network port that is forwarded by a firewall or protected by a secure tunnel.

For this mechanism to work properly, a client that established its [administrative session](#) directly with IceGrid and not via a [Glacier2 router](#) must take additional steps to ensure that the proxies for its callback objects contain the proper identities and endpoints. The `IceGrid::AdminSession` interface provides an operation to help with the client's preparations:

Slice

```

module IceGrid {
    interface AdminSession ... {
        idempotent Object* getAdminCallbackTemplate();
        // ...
    };
};

```

As its name implies, the `getAdminCallbackTemplate` operation returns a *template proxy* that supplies the identity and endpoints a client needs to configure its callback objects. The information contained in the template proxy is valid for the lifetime of the administrative session. This operation returns a null proxy if the client's administrative session was established via a Glacier2 router, in which case the client should use the callback strategy described in the next section instead.

The endpoints contained in the template proxy are those of an object adapter in the IceGrid registry. The client must transfer these endpoints to the proxies for its callback objects so that callback requests from a server are sent first to IceGrid and then relayed over a [bidirectional connection](#) to the client, as shown below:

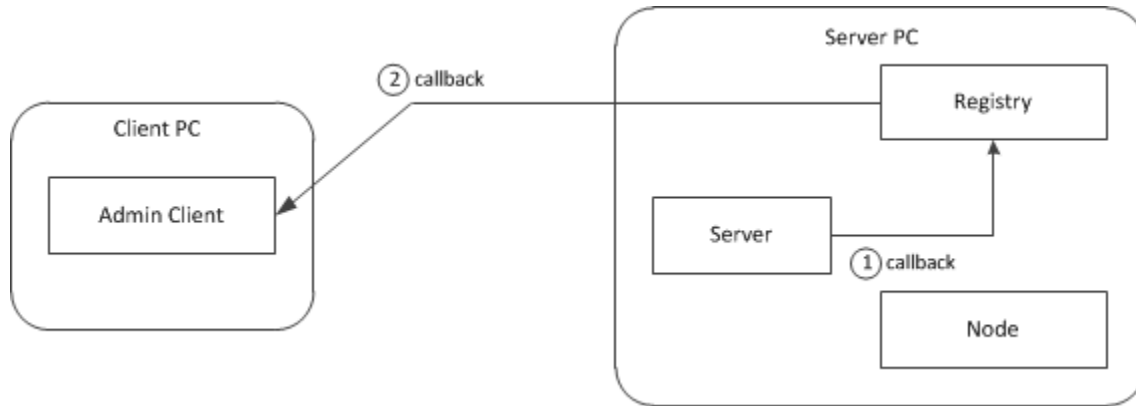

Routing for callback requests from a server.

Here is the complete list of steps:

1. Invoke `getAdminCallbackTemplate` to obtain the template proxy.
2. Extract the category from the template proxy's identity and use it in all callback objects.
3. Extract the endpoints from the template proxy and use them to establish the published endpoints of the callback object adapter.
4. Create the callback object adapter and associate it with the administrative session's connection, thereby establishing a bidirectional connection with IceGrid.
5. Add servants to the callback object adapter.

As an example, let us assume that we have deployed an IceBox server with the server id `icebox1` and our objective is to register a `ServiceObserver` callback that monitors the state of the IceBox services. The first step is to obtain a proxy for the administrative facet named `IceBox.ServiceManager`:

```

C++

IceGrid::AdminSessionPrx session = ...;
IceGrid::AdminPrx admin = session->getAdmin();
Ice::ObjectPrx obj = admin->getServerAdmin("icebox1");
IceBox::ServiceManagerPrx svcmgr =
    IceBox::ServiceManagerPrx::checkedCast(
        obj, "IceBox.ServiceManager");
  
```

Next, we retrieve the template proxy and compose the published endpoints for our callback object adapter:

C++

```

Ice::ObjectPrx tmp1 = admin->getAdminCallbackTemplate();
Ice::EndpointSeq endpts = tmp1->ice_getEndpoints();
string publishedEndpoints;
for (Ice::EndpointSeq::const_iterator p = endpts.begin();
     p != endpts.end(); ++p) {
    if (p == endpts.begin())
        publishedEndpoints = (*p)->toString();
    else
        publishedEndpoints += ":" + (*p)->toString();
}
communicator->getProperties()->setProperty(
    "CallbackAdapter.PublishedEndpoints", publishedEndpoints);

```

The final steps involve creating the callback object adapter, adding a servant, establishing the bidirectional connection and registering our callback with the service manager:

C++

```

Ice::ObjectAdapterPtr callbackAdapter =
communicator->createObjectAdapter("CallbackAdapter");
Ice::Identity cbid;
cbid.category = tmp1->ice_getIdentity().category;
cbid.name = "observer";
IceBox::ServiceObserverPtr obs = new ObserverI;
Ice::ObjectPrx cbobj = callbackAdapter->add(obs, cbid);
IceBox::ServiceObserverPrx cb =
IceBox::ServiceObserverPrx::uncheckedCast(cbobj);
callbackAdapter->activate();
session->ice_getConnection()->setAdapter(callbackAdapter);
svcmgr->addObserver(cb);

```

At this point the client is ready to receive callbacks from the IceBox server whenever one of its services changes state.

Callbacks with Glacier2

A client that creates an [administrative session](#) via a [Glacier2 router](#) already has a bidirectional connection over which callbacks from administrative facets are relayed. The flow of requests is shown in the illustration below, which presents a simplified view with the router and IceGrid services all running on the same host.

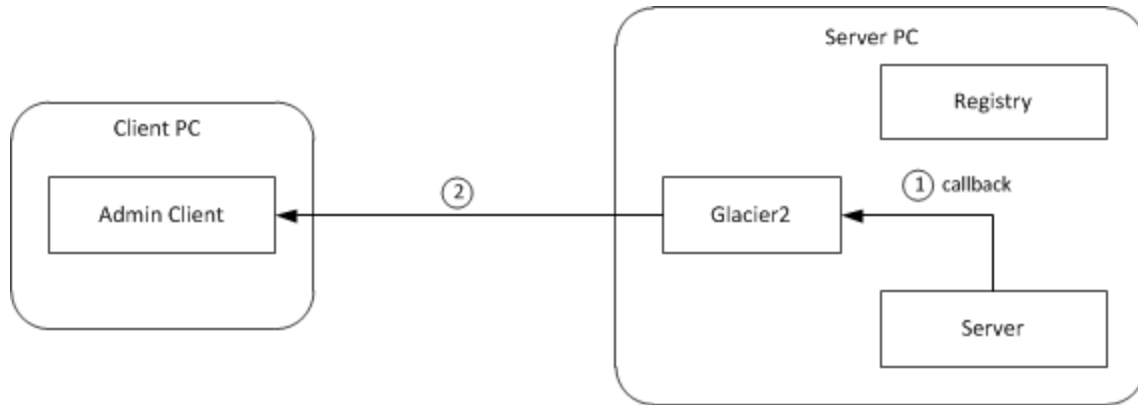

Routing for callback requests from a server.

To prepare for **receiving callbacks**, the client must perform the same steps as for any router client:

1. Obtain a proxy for the router.
2. Retrieve the category to be used in callback objects.
3. Create the callback object adapter and associate it with the router, thereby establishing a bidirectional connection.
4. Add servants to the callback object adapter.

Repeating the example from the previous section, we assume that we have deployed an IceBox server with the server ID `icebox1` and our objective is to register a `ServiceObserver` callback that monitors the state of the IceBox services. The first step is to obtain a proxy for the administrative facet named `IceBox.ServiceManager`:

C++

```

IceGrid::AdminSessionPrx session = ...;
IceGrid::AdminPrx admin = session->getAdmin();
Ice::ObjectPrx obj = admin->getServerAdmin("icebox1");
IceBox::ServiceManagerPrx svcmgr =
    IceBox::ServiceManagerPrx::checkedCast(obj, "IceBox.ServiceManager"
);
  
```

Now we are ready to create the object adapter and register the observer:

C++

```

Ice::RouterPrx router = communicator->getDefaultRouter();
Ice::ObjectAdapterPtr callbackAdapter =
    communicator->createObjectAdapterWithRouter("CallbackAdapter", rout
er);
Ice::Identity cbid;
cbid.category = router->getCategoryForClient();
cbid.name = "observer";
IceBox::ServiceObserverPtr obs = new ObserverI;
Ice::ObjectPrx cbobj = callbackAdapter->add(obs, cbid);
IceBox::ServiceObserverPrx cb =
IceBox::ServiceObserverPrx::uncheckedCast(cbobj);
callbackAdapter->activate();
svcmgr->addObserver(cb);
  
```

At this point the client is ready to receive callbacks from the IceBox server whenever one of its services changes state.

Using the Administrative Facility in IceGrid Utilities

This section discusses the ways in which the IceGrid utilities make use of the administrative facility.

Properties

The command line and graphical utilities allow you to explore the configuration properties of a server or service.

One property in particular, `BuildId`, is given special consideration by the graphical utility. Although it is not used by the Ice run time, the `BuildId` property gives you the ability to describe the build configuration of your application. The property's value is shown by the graphical utility in its own field in the attributes of a server or service, as well as in the list of properties. You can also retrieve the value of this property using the command-line utility with the following statement:

```
> server property MyServerId BuildId
```

Or, for an IceBox service, with this command:

```
> service property MyServerId MyService BuildId
```

The utilities use the `Properties` facet to access these properties, via a proxy obtained as described [above](#).

Administering IceBox Services

IceBox provides an administrative facet that implements the `IceBox::ServiceManager` interface, which supports operations for stopping an active service, and for starting a service that is currently inactive. These operations are available in both the command line and graphical utilities.

IceBox also defines a `ServiceObserver` interface for receiving callbacks when services are stopped or started. The graphical utility implements this interface so that it can present an updated view of the state of an IceBox server. We presented [examples](#) that demonstrate how to register an observer with the IceBox administrative facet.

See Also

- [Administrative Facility](#)
- [The Process Facet](#)
- [The Properties Facet](#)
- [The Administrative Object Adapter](#)
- [The admin Object](#)
- [Custom Administrative Facets](#)
- [Security Considerations for Administrative Facets](#)
- [Portable Signal Handling in C++](#)
- [Bidirectional Connections](#)
- [Using IceGrid Deployment](#)
- [Glacier2 Integration with IceGrid](#)
- [IceGrid Administrative Sessions](#)
- [icegridadmin Command Line Tool](#)
- [Callbacks through Glacier2](#)
- [IceBox](#)
- [IceBox Administration](#)
- [IceGrid Properties](#)

Securing IceGrid

IceGrid's registry and node services expose multiple network endpoints that a malicious client could use to gain access to IceGrid functionality and interfere with deployed applications. This presents a significant security risk in network environments that are exposed to untrusted clients. For example, a malicious client could connect to a node and use IceGrid's internal interfaces to deploy and run its own server executable.

This page describes the steps you can take to secure your IceGrid application.

On this page:

- [IceGrid Security Overview](#)
- [Understanding the Registry Endpoints](#)
 - [Client Endpoint](#)
 - [Server Endpoint](#)
 - [Internal Endpoint](#)
 - [Session Manager Endpoint](#)
 - [Administrative Session Manager Endpoint](#)
 - [Outgoing Connections](#)
- [Understanding the Node Endpoints](#)
- [Understanding the Administrative Endpoints with IceGrid](#)

IceGrid Security Overview

Using a firewall is one way to prevent unauthorized use of IceGrid's facilities. Another solution is to use [IceSSL](#): you can generate SSL certificates for each component and configure them to trust and accept connections only from other authorized components. The remainder of this section discusses the IceSSL solution but also provides useful information for those interested in securing IceGrid with a firewall.

To restrict access using IceSSL, we need to establish trust relationships between IceGrid registry replicas, nodes, and deployed servers. IceSSL allows us to do this using [configuration properties](#). The trust relationships are based on the information contained in SSL certificates.

There are several possible strategies for generating certificates. At a minimum you will need the following:

- one certificate for all of the registries
- one certificate for all of the nodes
- one certificate for all of the servers managed by IceGrid

The certificates that you generate for registries and nodes should be protected with a password to ensure that only privileged users can start these services. However, we do not recommend using a password to protect the certificate for deployed servers because it would need to be specified in clear text in each server's configuration (servers that are activated by IceGrid must not prompt for a password). Furthermore, this password might appear in multiple places, such as an XML descriptor file, the IceGrid registry database, and property files generated by IceGrid nodes. The complexity involved in protecting access to every file that contains a clear text password could be overwhelming. Instead, we recommend that you protect access to the server certificate using file system permissions.

Depending on your organization and the roles of each person that uses IceGrid, you may decide to create additional certificates. For example, you might create a unique certificate for each IceGrid node instance if you deploy nodes on end-user machines and wish to configure the IceGrid registry to authorize connections only from the nodes of trusted users.

You can use the `iceca` script to establish a [certificate authority](#) and generate certificates. The sections that follow describe the interactions between the registry, node, and servers, and show how to configure IceSSL to restrict access to trusted peers. For the purposes of this discussion, we assume that the SSL certificates use the common names shown below:

- `IceGrid Registry`
- `IceGrid Node`
- `Server`

The Ice distribution includes a C++ example that demonstrates how to configure a secure IceGrid deployment in the `demo/IceGrid/secure` subdirectory. This example includes a script to generate certificates for a registry, a node, a Glacier2 router, and a server. For more information, see the `README` file provided with the example.

Understanding the Registry Endpoints

The IceGrid registry has three mandatory endpoints representing the client, server, and internal endpoints. The registry also has two optional endpoints (the session manager and administrative session manager endpoints) that are only useful when [accessing IceGrid via Glacier2](#).

Client Endpoint

The registry client endpoint is used by Ice applications that create client sessions in order to use the [resource allocation](#) facility. It is also used by [administrative clients](#) that create sessions for managing the registry. Finally, the client endpoint is used by Ice applications that use the `IceGrid::Query` interface or resolve indirect proxies via the IceGrid locator.

Two distinct permission verifiers authorize the creation of [client sessions](#) and [administrative sessions](#). The remaining functionality available via the client endpoint, such as resolving objects and object adapters using the `IceGrid::Query` interface or the Ice locator mechanism, is accessible to any client that is able to connect to the client endpoint.

It is safe to use an insecure transport for the client endpoint if it is only being used for locator queries. However, you should use a secure transport if you have enabled client and administrative sessions (by configuring the appropriate permission verifiers). Creating a session over an insecure transport poses a security risk because the user name and password are sent in clear text over the network.

If you include secure and insecure transports in the registry's client endpoints, you should ensure that applications that need to authenticate with IceGrid permission verifiers use a [secure transport](#).

It is not necessary to restrict SSL access to the client endpoints (using the property `IceSSL.TrustOnly.Server.IceGrid.Registry.Client`) as long as you use client and administrative permission verifiers for authentication. This property is only useful for restricting access to client and administrative sessions when using null permission verifiers. Note however that if both client and administrative sessions are enabled, you will only be able to restrict access to one set of clients since you cannot distinguish clients that create client sessions from clients that create administrative sessions.

Server Endpoint

Ice servers use the registry's server endpoint to register their object adapter endpoints and send information to [administrative clients](#) connected via the registry.

Securing this endpoint with IceSSL is necessary to prevent a malicious program from potentially hijacking a server by registering its endpoints first. The property definition shown below demonstrates how to limit access to this endpoint to trusted Ice servers:

```
IceSSL.TrustOnly.Server.IceGrid.Registry.Server=CN="Server"
```

Internal Endpoint

IceGrid nodes and registry replicas use the internal endpoint to communicate with the registry. For example, nodes connect to the internal endpoint of each active registry, and [registry slaves](#) establish a session with their master via this endpoint.

The internal endpoint must be secured with IceSSL to prevent malicious Ice applications from gaining access to sensitive functionality that is intended to be used only by nodes and registry replicas. You can restrict access to this endpoint with the following property:

```
IceSSL.TrustOnly.Server.IceGrid.Registry.Internal=CN="IceGrid
Node";CN="IceGrid Registry"
```

Session Manager Endpoint

The session manager endpoint is used by Glacier2 to create IceGrid [client sessions](#). The functionality exposed by this endpoint is unrestricted so you must either secure it or disable it (this endpoint is disabled by default). The property shown below demonstrates how to configure IceSSL so that only Glacier2 routers are accepted by this endpoint:

```
IceSSL.TrustOnly.Server.IceGrid.Registry.SessionManager=CN="Glacier2
Router Client"
```

In this example, `Glacier2 Router Client` is the common name of the Glacier2 router used by clients to create IceGrid client sessions.

Administrative Session Manager Endpoint

Glacier2 routers use the registry's administrative session manager endpoint to create IceGrid [administrative sessions](#). The functionality exposed by this endpoint is unrestricted, so you must either secure it or disable it (this endpoint is disabled by default). The property shown below demonstrates how to configure IceSSL so that only Glacier2 routers are accepted by this endpoint:

```
IceSSL.TrustOnly.Server.IceGrid.Registry.AdminSessionManager=CN="Glacie
r2 Router Admin"
```

In this example, `Glacier2 Router Admin` is the common name of the Glacier2 router used by clients to create IceGrid administrative sessions. Note that if you use a single Glacier2 router instance for [both client and administrative sessions](#), you will need to use the same common name to restrict access to both session manager endpoints:

```
IceSSL.TrustOnly.Server.IceGrid.Registry.SessionManager=CN="Glacier2
Router Client"
IceSSL.TrustOnly.Server.IceGrid.Registry.AdminSessionManager=CN="Glacie
r2 Router Client"
```

Outgoing Connections

The registry establishes outgoing connections to other registries and nodes. You should configure the `IceSSL.TrustOnly.Client` property to restrict connections to these trusted peers:

```
IceSSL.TrustOnly.Client=CN="IceGrid Registry";CN="IceGrid Node"
```

The registry can also connect to Glacier2 routers and permission verifier objects. To allow connections to these services, you must include in this property the common names of Glacier2 routers that create client or administrative sessions, as well as the common names of servers that host the permission verifier objects.

Understanding the Node Endpoints

An IceGrid node has only one endpoint, which is used for internal communications with the registry. As a result, it should be configured to accept connections only from IceGrid registries:

```
IceSSL.TrustOnly.Server=CN="IceGrid Registry"
```

A node also establishes outgoing connections to the registry's internal endpoint, as well as the `Ice.Admin` endpoint of deployed servers. You should configure the `IceSSL.TrustOnly.Client` property as shown below to verify the identity of these peers:

```
IceSSL.TrustOnly.Client=CN="Server";CN="IceGrid Registry"
```

Understanding the Administrative Endpoints with IceGrid

By default, IceGrid sets the endpoints of a deployed server's `Ice.Admin` adapter to `tcp -h 127.0.0.1`. This setting is already quite secure because it only accepts connections from processes running on the same host. However, since you already need to configure IceSSL so that a server can authenticate with the IceGrid registry (servers connect to the registry to register their endpoints), you might as well use a secure endpoint for the `Ice.Admin` adapter and configure it to accept connections only from IceGrid nodes:

```
IceSSL.TrustOnly.Server.Ice.Admin=CN="IceGrid Node"
```

This is only necessary if the `Ice.Admin` endpoint is enabled (which it is by default).

You can also set the `IceSSL.TrustOnly.Client` property so that the server is only permitted to connect to the IceGrid registry:

```
IceSSL.TrustOnly.Client=CN="IceGrid Registry"
```

If your server invokes on other servers, you will need to modify this setting to allow secure connections to them.

See Also

- [IceSSL](#)
- [Configuring IceSSL](#)
- [Setting up a Certificate Authority](#)
- [Glacier2 Integration with IceGrid](#)
- [Resource Allocation using IceGrid Sessions](#)
- [IceGrid Administrative Sessions](#)
- [Well-Known Objects](#)
- [IceGrid and the Administrative Facility](#)
- [Registry Replication](#)
- [IceSSL Properties](#)

icegridadmin Command Line Tool

The `icegridadmin` utility is a command-line tool for administering an IceGrid domain. Deploying an application with this utility requires an XML file that defines the descriptors.

On this page:

- [Usage](#)
- [Application Commands](#)
- [Node Commands](#)
- [Registry Commands](#)
- [Server Commands](#)
- [Service Commands](#)
- [Adapter Commands](#)
- [Object Commands](#)
- [Server Template](#)
- [Service Template](#)
- [Configuration](#)

Usage

The IceGrid administration tool supports the following command-line options:

```
Usage: icegridadmin [options]
Options:
-h, --help           Show this message.
-v, --version        Display the Ice version.
-e COMMANDS          Execute COMMANDS.
-d, --debug          Print debug messages.
-s, --server         Start icegridadmin as a server (to parse XML
files).
-u, --username       Login with the given username.
-p, --password       Login with the given password.
-S, --ssl            Authenticate through SSL.
-r, --replica NAME   Connect to the replica NAME.
```

The `-e` option causes the tool to execute the given commands and then exit without entering an interactive mode. The `-s` option starts `icegridadmin` in a server mode that supports the `IceGrid::FileParser` interface; a proxy for the object is printed to standard output. If neither `-e` nor `-s` is specified, the tool enters an interactive mode in which you issue commands at a prompt.

To communicate with the IceGrid registry, `icegridadmin` establishes an [administrative session](#). The tool uses SSL authentication if you specify the `-s` option or define its equivalent property `IceGridAdmin.AuthenticateUsingSSL`. Otherwise, `icegridadmin` uses password authentication and prompts you for the username and password if you do not specify them via command-line options or properties. If you want `icegridadmin` to establish its session using a [Glacier2 router](#), define `Ice.Default.Router` appropriately. See [IceGrid Administrative Client Properties](#) for more information on the tool's configuration properties.

Once the session is successfully established, `icegridadmin` displays its command prompt. The `help` command displays the following usage information:

- `help`
Print this message.
- `exit, quit`
Exit this program.

- `CATEGORY help`
Print the help section of the given `CATEGORY`
- `COMMAND help`
Print the help of the given `COMMAND`.

The tool's commands are organized by category. The supported command categories are shown below:

- `application`
- `node`
- `registry`
- `server`
- `service`
- `adapter`
- `object`
- `server template`
- `service template`

You can obtain more information about each category using the `help` command:

```
>>> application help
```

Application Commands

- `application add [-n | --no-patch] DESC [TARGET ...] [NAME=VALUE ...]`
Add applications described in the XML descriptor file `DESC`. If specified the optional `targets` are deployed. `Variables` are defined using the `NAME=VALUE` syntax. The application is automatically `patched` unless the `-n` or `--no-patch` option is used to disable it.
- `application remove NAME`
Remove the application named `NAME`.
- `application describe NAME`
Describe the application named `NAME`.
- `application diff [-s | --servers] DESC [TARGET ...] [NAME=VALUE ...]`
Print the differences between the application in the XML descriptor file `DESC` and the current deployment. If `-s` or `--servers` is specified, print the the list of servers affected by the differences. `Variables` are defined using the `NAME=VALUE` syntax.
- `application update [-n | --no-restart] DESC [TARGET ...] [NAME=VALUE ...]`
Update the application in the XML descriptor file `DESC`. If `-n` or `--no-restart` is specified, the update will fail if it would require restarting one or more servers. `Variables` are defined using the `NAME=VALUE` syntax. Use the `diff --servers` command to discover which servers would be affected by an update, including those that would require a restart.
- `application patch [-f | --force] NAME`
`Patch` the application named `NAME`. If `-f` or `--force` is specified, IceGrid will first shut down any servers that depend on the data to be patched.
- `application list`
List all deployed applications.

Node Commands

- `node list`
List all registered nodes.
- `node describe NAME`
Show information about node `NAME`.

- `node ping NAME`
Ping node `NAME`.
- `node load NAME`
Print the load of the node `NAME`.
- `node sockets [NAME]`
Print the number of processor sockets for node `NAME`. If `NAME` is omitted, print the number of processor sockets for each node. (The `IceGrid.Node.ProcessorSocketCount` property allows you to explicitly set this value for systems where the number of sockets cannot be obtained programmatically.)
- `node show [OPTIONS] NAME [stderr | stdout]`
Print the text from the node's standard error or standard output. The supported options are shown below:
 - `-f, --follow`
Wait for new text to be available.
 - `-t, --tail N`
Print the last `N` lines of text.
 - `-h, --head N`
Print the first `N` lines of text
- `node shutdown NAME`
Shutdown node `NAME`.

Registry Commands

- `registry list`
List all registered registries.
- `registry describe NAME`
Show information about registry `NAME`.
- `registry ping NAME`
Ping registry `NAME`.
- `registry show [OPTIONS] NAME [stderr | stdout]`
Print the text from the registry's standard error or standard output. The supported options are shown below:
 - `-f, --follow`
Wait for new text to be available.
 - `-t, --tail N`
Print the last `N` lines of text.
 - `-h, --head N`
Print the first `N` lines of text.
- `registry shutdown NAME`
Shutdown registry `NAME`.

Server Commands

- `server list`
List all registered servers.
- `server remove ID`
Remove server `ID`.
- `server describe ID`
Describe server `ID`.
- `server properties ID`

Get the run-time properties of server ID.

- `server property ID NAME`
Get the run-time property NAME of server ID.
- `server state ID`
Get the state of server ID.
- `server pid ID`
Get the process ID of server ID.
- `server start ID`
Start server ID.
- `server stop ID`
Stop server ID.
- `server patch ID`
Patch server ID.
- `server signal ID SIGNAL`
Send SIGNAL (such as SIGTERM or 15) to server ID.
- `server stdout ID MESSAGE`
Write MESSAGE on server ID's standard output.
- `server stderr ID MESSAGE`
Write MESSAGE on server ID's standard error.
- `server show [OPTIONS] ID [stderr | stdout | LOGFILE]`
Print the text from the server's standard error, standard output, or the log file LOGFILE. The supported options are shown below:
 - `-f, --follow`
Wait for new text to be available.
 - `-t, --tail N`
Print the last N lines of text.
 - `-h, --head N`
Print the first N lines of text.
- `server enable ID`
Enable server ID.
- `server disable ID`
Disable server ID. A [disabled server](#) cannot be started on demand.

Service Commands

- `service start ID NAME`
Starts service NAME in IceBox server ID.
- `service stop ID NAME`
Stops service NAME in IceBox server ID.
- `service describe ID NAME`
Describes service NAME in IceBox server ID.
- `service properties ID NAME`
Get the run-time properties of service NAME from IceBox server ID.
- `service property ID NAME PROPERTY`
Get the run-time property PROPERTY of service NAME from IceBox server ID.

- `service list ID`
List the services in IceBox server ID.

Adapter Commands

- `adapter list`
List all registered adapters.
- `adapter endpoints ID`
Show the endpoints of adapter or replica group ID.
- `adapter remove ID`
Remove adapter or replica group ID.

Object Commands

The `object` command operates on [well-known objects](#).

- `object add PROXY [TYPE]`
Add a well-known object to the registry, optionally specifying its type.
- `object remove IDENTITY`
Remove a well-known object from the registry.
- `object find TYPE`
Find all well-known objects with the type TYPE.
- `object describe EXPR`
Describe all well-known objects whose stringified identities match the expression EXPR. A trailing wildcard is supported in EXPR, for example "object describe Ice*".
- `object list EXPR`
List all well-known objects whose stringified identities match the expression EXPR. A trailing wildcard is supported in EXPR, for example "object list Ice*".

Server Template

- `server template instantiate APPLICATION NODE TEMPLATE [NAME=VALUE ...]`
Instantiate the requested [server template](#) defined in the given application on a node. [Variables](#) are defined using the NAME=VALUE syntax.
- `server template describe APPLICATION TEMPLATE`
Describe a [server template](#) TEMPLATE from the given application.

Service Template

- `service template describe APPLICATION TEMPLATE`
Describe a [service template](#) TEMPLATE from the given application.

Configuration

`icegridadmin` requires that the locator proxy be defined in the configuration property `Ice.Default.Locator`. If a configuration file already exists that defines this property, you can start `icegridadmin` using the configuration file as shown below:

```
$ icegridadmin --Ice.Config=<file>
```

Otherwise, you can define the property on the command line:

```
$ icegridadmin --Ice.Default.Locator=<proxy>
```

Refer to the discussion of our [ripper client](#) for more information on configuring the `Ice.Default.Locator` property for an IceGrid client.

See Also

- [IceGrid Administrative Sessions](#)
- [Glacier2 Integration with IceGrid](#)
- [IceGrid XML Features](#)
- [Using Descriptor Variables and Parameters](#)
- [Application Distribution](#)
- [Getting Started with IceGrid](#)
- [IceGrid Administrative Client Properties](#)

IceGrid Admin Graphical Tool

IceGrid Admin is a graphical client for IceGrid. IceGrid Admin allows you to monitor servers deployed by IceGrid, create new IceGrid applications, deploy these applications, and more.

Topics

- [Getting Started with IceGrid Admin](#)
- [Live Deployment Tab](#)
 - [Connection to an IceGrid Registry](#)
 - [Log File Dialog](#)
 - [Run Time Components](#)
 - [Registry Run Time Component](#)
 - [Slave Registry Run Time Component](#)
 - [Node Run Time Component](#)
 - [Server Run Time Component](#)
 - [Adapter Run Time Component](#)
 - [Database Environment Run Time Component](#)
 - [Service Run Time Component](#)
 - [Metrics View Run Time Component](#)
 - [Application Component](#)
 - [Metrics Graph](#)
- [Application Tabs](#)
 - [Editing and Saving IceGrid Descriptors](#)
 - [Navigation within an Application Tab](#)
 - [IceGrid Descriptors](#)
 - [Variables in IceGrid Descriptors](#)
 - [Application Descriptor](#)
 - [Node Descriptor](#)
 - [Server Descriptor](#)
 - [Service Descriptor](#)
 - [Adapter Descriptor](#)
 - [Database Environment Descriptor](#)
 - [Property Set Descriptor](#)
 - [Replica Group Descriptor](#)
 - [Server Template Descriptor](#)
 - [Service Template Descriptor](#)

Getting Started with IceGrid Admin

This page describes how to launch the IceGrid Admin tool.

On this page:

- [System Requirements](#)
- [Starting IceGrid Admin](#)
- [Command Line Arguments](#)
- [Main IceGrid Admin Window](#)
 - [Tabs](#)
 - [Status Bar](#)

System Requirements

IceGrid Admin is a Java™ application supported on a wide range of platforms, including Windows, Linux and OS X.

The minimum requirements for running IceGrid Admin are listed below:

- `IceGridGUI.jar`, usually installed in the `bin` or `lib` directory of your Ice installation. If you are using a Linux binary distribution, `IceGridGUI.jar` is installed in `/usr/share/java`.
- Java SE Runtime Environment 6 or later

In order to use IceGrid Admin's [metrics graphs](#) feature, you will need the following:

- Java SE Runtime Environment 7 or later
- JavaFX Runtime Environment, bundled with recent updates of the Java SE Runtime Environment 7 on Windows, Linux and OS X

You can download Java SE 7 for most platforms from [Oracle](#).

If you want to read IceGrid XML files from IceGrid Admin, you also need to have the `icegridadmin` command-line utility (version 3.5) in your `PATH`.

Starting IceGrid Admin

On Windows IceGrid Admin can be started by clicking the IceGrid Admin icon in the Start menu:

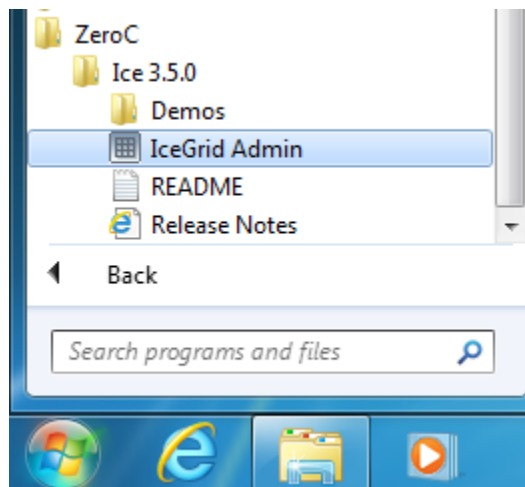

On OS X IceGrid Admin can be started by clicking the IceGrid Admin icon in Finder Applications folder:



On Linux with a RPM installation, you can use the `icegridgui` script installed in `/usr/bin`:

```
$ icegridgui
```

On all platforms, you can also start IceGrid Admin from a terminal by typing:

```
java -jar path-to-IceGridGUI.jar
```

Command Line Arguments

IceGrid Admin can be configured using Ice properties, and like with most Ice applications, these properties can be set using command-line arguments or a configuration file (or both).

Since IceGrid Admin is an Ice application (a client to the IceGrid registry), setting regular Ice properties can be useful as well. For example, you can set the `Ice.Trace.Network` property to get detailed information about network communications sent to `stderr`.

```
$ icegridgui --Ice.Trace.Network=2
```

There are also a number of properties specific to IceGrid Admin itself, describe in [IceGrid Administrative Client Properties](#).

If you need to set many properties, it is a good idea to write a configuration file and use the `--Ice.Config` command-line argument to specify the location of this file. For example:

```
> java -jar "C:\Program Files (x86)\ZeroC\Ice-3.5.1\bin\IceGridGUI.jar"
--Ice.Config=icegridadmin.conf
```



Main IceGrid Admin Window

The main IceGrid Admin window allows to navigate between your live deployment and the definitions of several applications.

Tabs

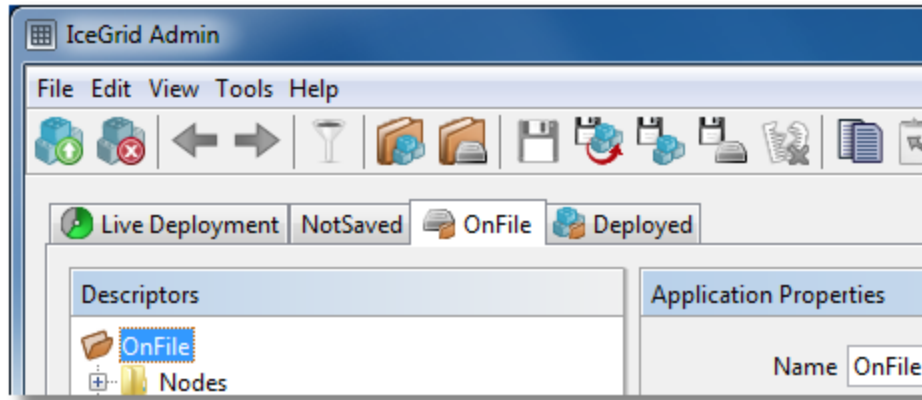
The main IceGrid Admin window shows one or more tabs:



- The Live Deployment tab () displays information about an IceGrid deployment you have logged into. There is always one and only one Live Deployment tab. When you are not connected to an IceGrid deployment, the corresponding pane is empty.
- A Live Application tab () displays application definitions retrieved from the IceGrid registry you are connected to. As long as you do not change anything in the associated pane, IceGrid Admin will keep the information up-to-date. For example if another administrator adds a new server definition in this application definition, it will appear automatically and immediately in this pane.
- A File-Based Application tab () displays application definitions retrieved from an IceGrid XML file.
- An icon-less tab displays the definitions of an application that is not bound to an IceGrid registry or to a file, such as a brand new application. A live application with unsaved modifications also becomes icon-less if the connection to its IceGrid registry is lost.

IceGrid Admin may show any number of application tabs, including none at all.

Status Bar

The status bar at the bottom of the main window shows information about operations performed by IceGrid Admin, or messages received from the IceGrid registry.

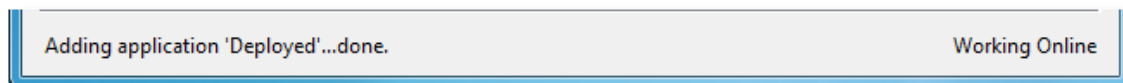

See Also

- IceGrid Administrative Client Properties
- icegridadmin Command Line Tool

Live Deployment Tab

The Live Deployment tab shows the run-time status and configuration of an existing IceGrid deployment, and allows you to perform various administrative tasks on this deployment, such as:

- start or stop a server
- retrieve metrics associated with a server
- display metrics from one or more servers on a graph
- enable or disable a server
- send signal to a server
- retrieve the log files of a server
- patch an entire application
- register a new "well-known" object with the IceGrid registry
- undeploy a deployed application

Topics

- Connection to an IceGrid Registry
- Log File Dialog
- Run Time Components
 - Registry Run Time Component
 - Slave Registry Run Time Component
 - Node Run Time Component
 - Server Run Time Component
 - Adapter Run Time Component
 - Database Environment Run Time Component
 - Service Run Time Component
 - Metrics View Run Time Component
- Application Component
- Metrics Graph

Connection to an IceGrid Registry

In order to administer or monitor an IceGrid deployment, you need to connect to the IceGrid registry of this deployment. If your IceGrid registry is replicated, you can connect to any replica for monitoring purposes; if you intend to change definitions, for example describe a new server, you need to connect to the master IceGrid registry. This page describes how to connect to an IceGrid registry.

On this page:

- [Connecting using a Saved Connection](#)
- [Creating a new Connection](#)
 - [TCP Connection to a local IceGrid registry](#)
 - [SSL Connection to local IceGrid using X.509 Credentials](#)
 - [SSL Connection through Glacier2 router](#)
- [SSL Connections and Certificates](#)
- [Editing a Saved Connection](#)
- [Closing a Connection](#)

Connecting using a Saved Connection

Use `File > Login...` or press the  button to open the Saved Connections dialog:

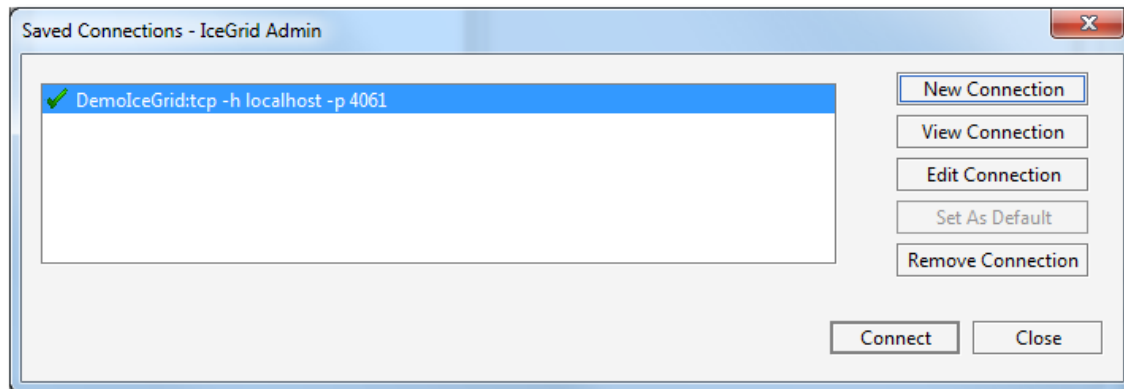

Then double-click on the IceGrid registry you want to connect to, or select the IceGrid registry and click on the `Connect` button.

If the connection contains saved credentials, IceGrid Admin will immediately attempt to connect to the selected IceGrid registry with these credentials. Otherwise, it will open a new dialog to request the missing password (two passwords in some cases), such as:

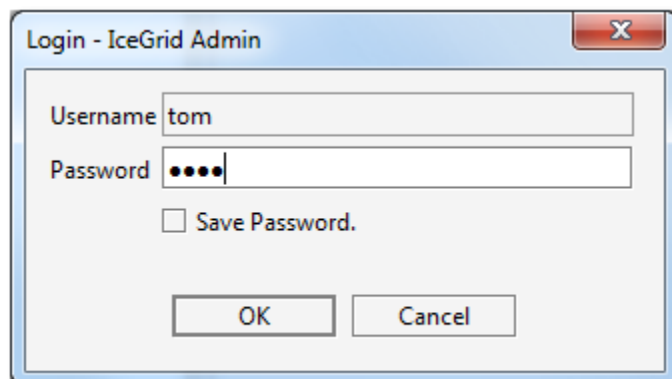

Creating a new Connection

In the `Saved Connections` dialog, click on `New Connection` to open the `New Connection` wizard.

Below are 3 typical connections to illustrate the wizard steps:

TCP Connection to a local IceGrid registry

We create a TCP connection to the IceGrid registry running on localhost:

Step 1: we select `Direct Connection`

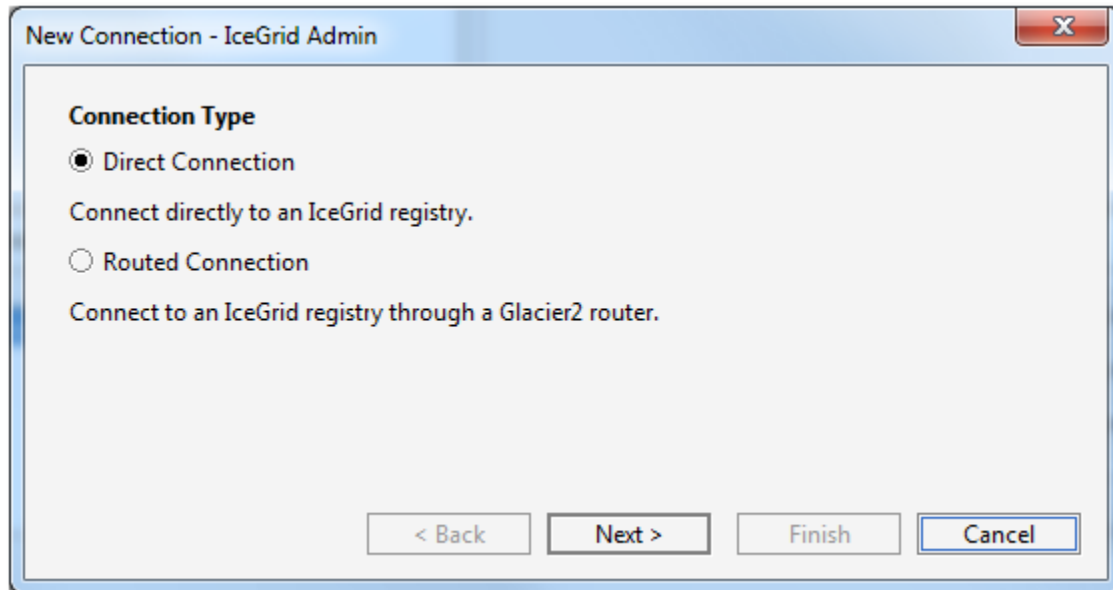

Step 2: we enter the name of your IceGrid instance. This corresponds to the `IceGrid.InstanceName` property in the target IceGrid registry configuration.

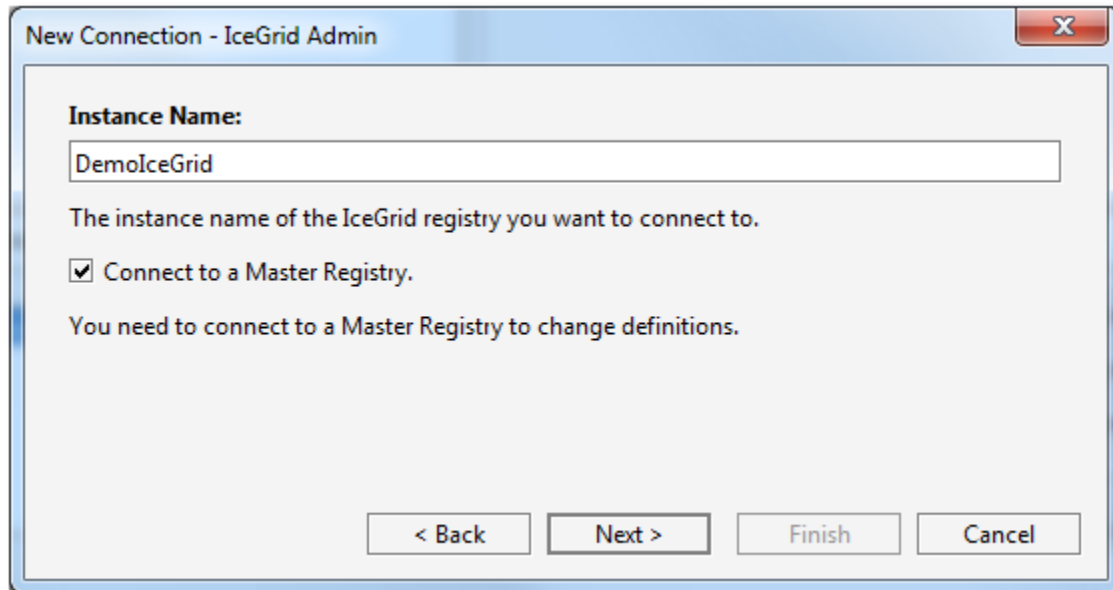

Step 3: we enter the addressing information as a hostname and port number

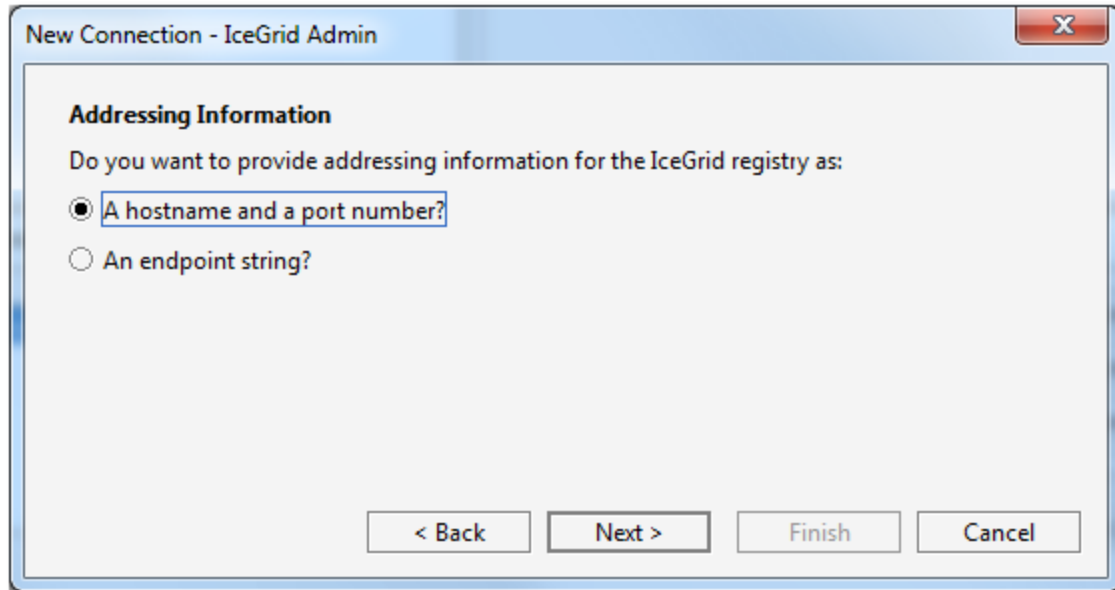

Step 4: we enter localhost for the Hostname, leave port number blank and keep TCP as the protocol

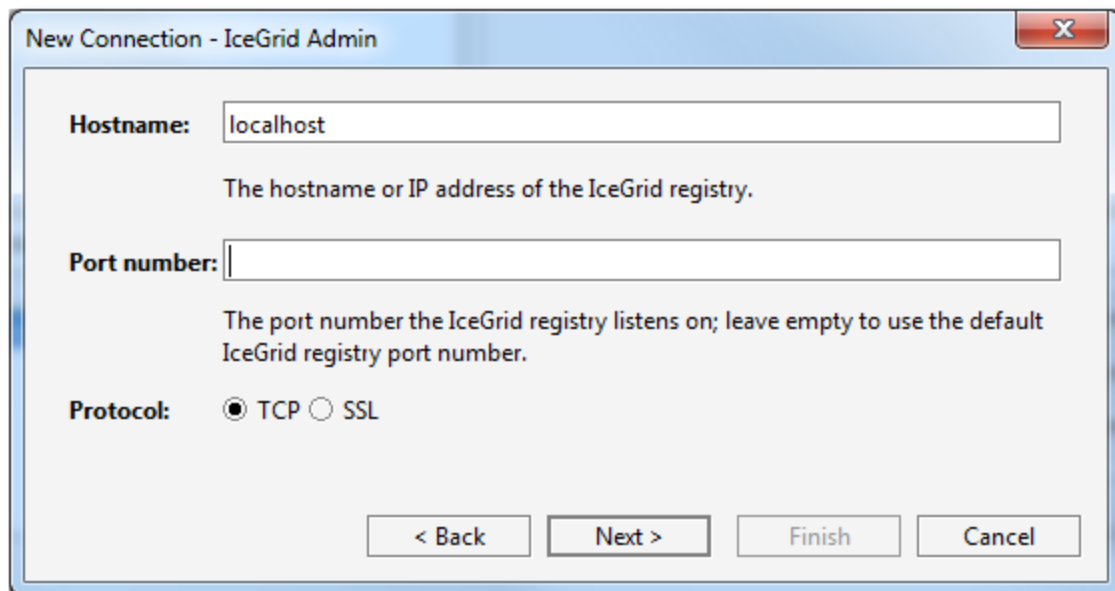

Step 5: we enter a username and password for this connection

New Connection - IceGrid Admin

Username: tom

Password: ●●●●●●●

Enter your password above to save it with this connection; otherwise you will need to enter your password each time you connect.

< Back Next > **Finish** Cancel

Step 6: we click on the `Finish` button to save the connection; IceGrid Admin then attempts to connect to the IceGrid registry

SSL Connection to local IceGrid using X.509 Credentials

We create a SSL connection to a directly-reachable IceGrid registry, and authenticate with this IceGrid registry using our X.509 key (also used for SSL authentication). The target IceGrid registry must be configured to accept SSL connections and authentication using SSL credentials; see `IceGrid.Registry.AdminSSLPermissionsVerifier`.

Steps 1 to 3 are identical to the simple TCP connection described above.

Step 4: we enter the hostname of the IceGrid registry, we leave the port number empty to use the default IceGrid port number (4061 for TCP and 4062 for SSL), and we select SSL for Protocol

New Connection - IceGrid Admin

Hostname: registry.acme.com
The hostname or IP address of the IceGrid registry.

Port number:
The port number the IceGrid registry listens on; leave empty to use the default IceGrid registry port number.

Protocol: TCP **SSL**

< Back Next > Finish Cancel

Step 5: yes, we want to provide a X.509 certificate for SSL authentication

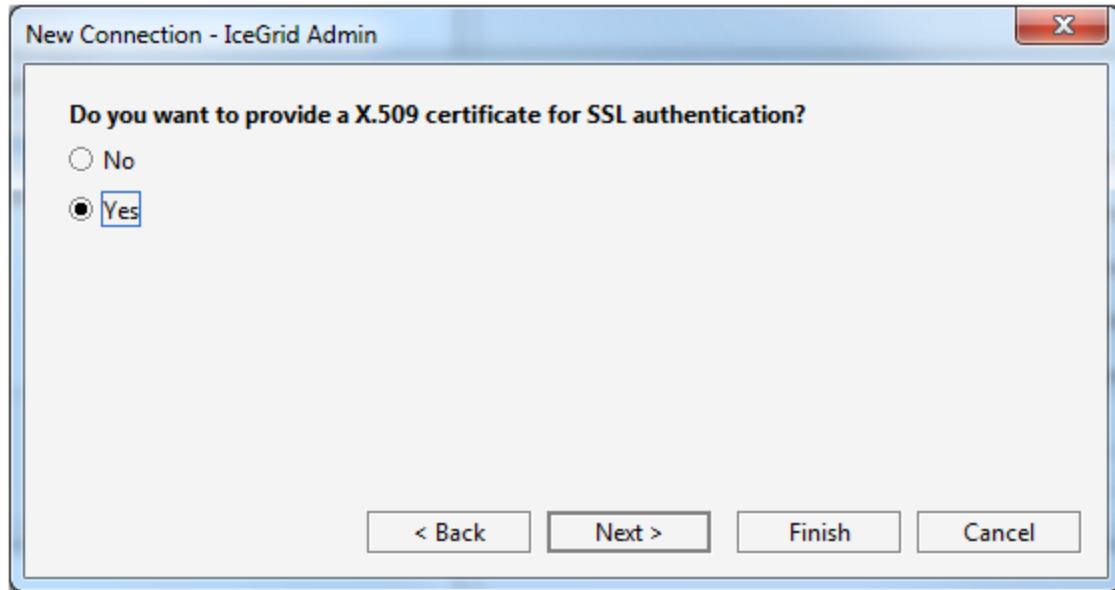

Step 6: we select the X.509 key used for SSL authentication from the Alias drop-down list; list this corresponds to the My Certificates set in the Certificate Manager described in the next section. Click on the `Import...` button to open the Certificate Manager dialog.

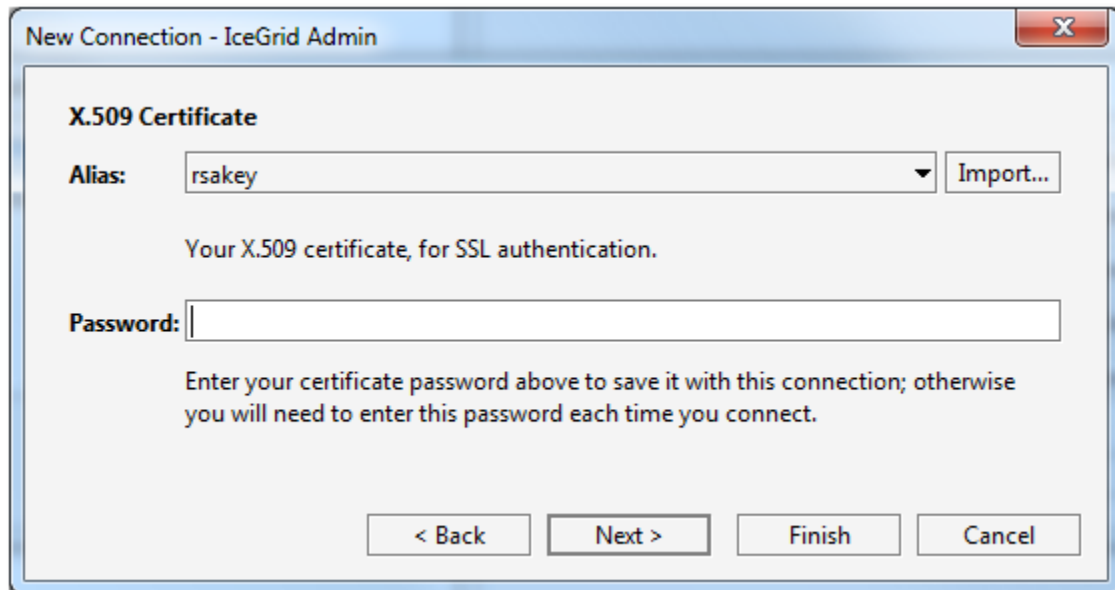

Step 7: we choose to use this X.509 certificate (carried through the SSL connection) to authenticate ourselves with the IceGrid registry.

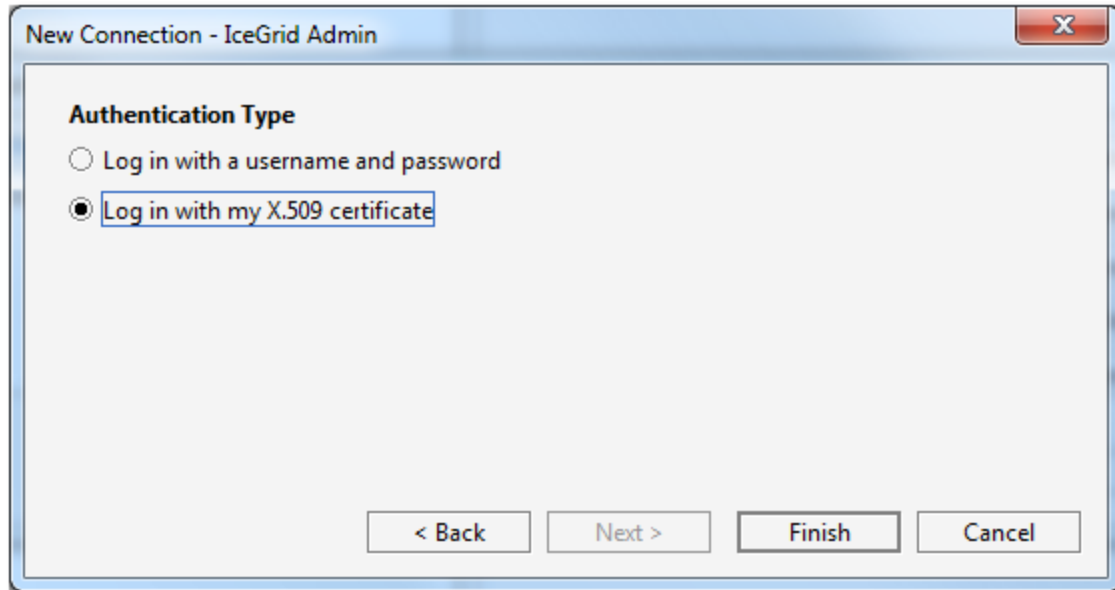

Step 8: we click on the `Finish` button to save the connection and connect to the IceGrid registry. Unless we entered (and therefore saved) the X.509 key password with the connection, we are prompted for this password:

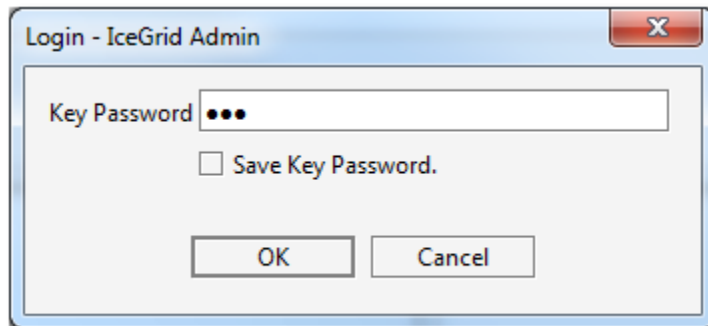

SSL Connection through Glacier2 router

We connect to an IceGrid registry "behind" a Glacier2 router. In this case, we need to connect to the Glacier2 router and authenticate ourselves with this Glacier2 router. We do not provide any information about the IceGrid registry itself: we will connect to the IceGrid registry identified by the target Glacier2 router configuration. See [Glacier2 Integration with IceGrid](#).

Step 1: we select Routed Connection

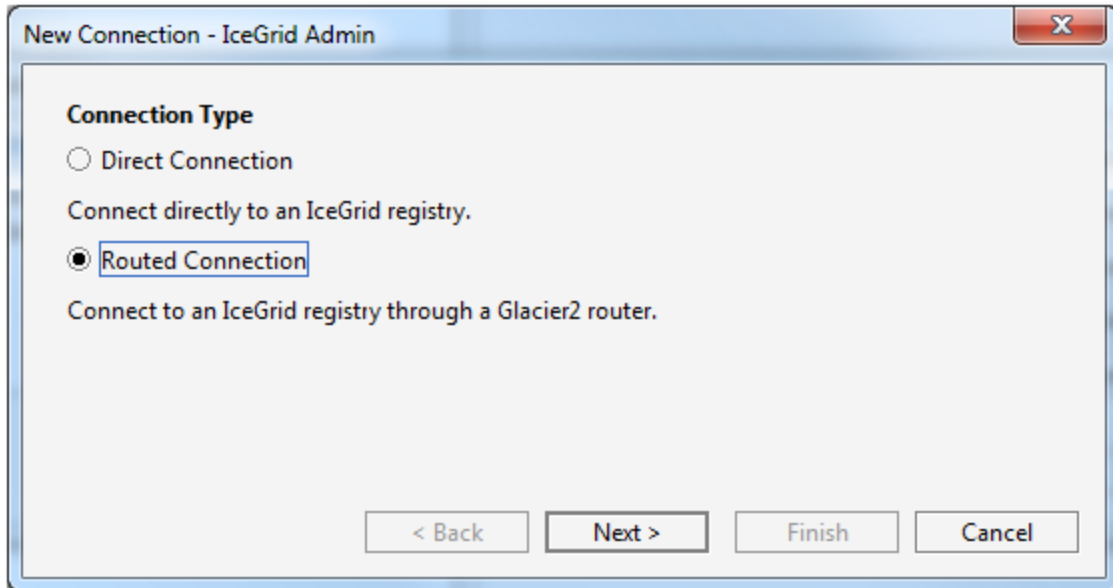

Step 2: we enter the instance name of our Glacier2 router. This corresponds to the `Glacier2.InstanceName` property in the target Glacier2 router configuration.

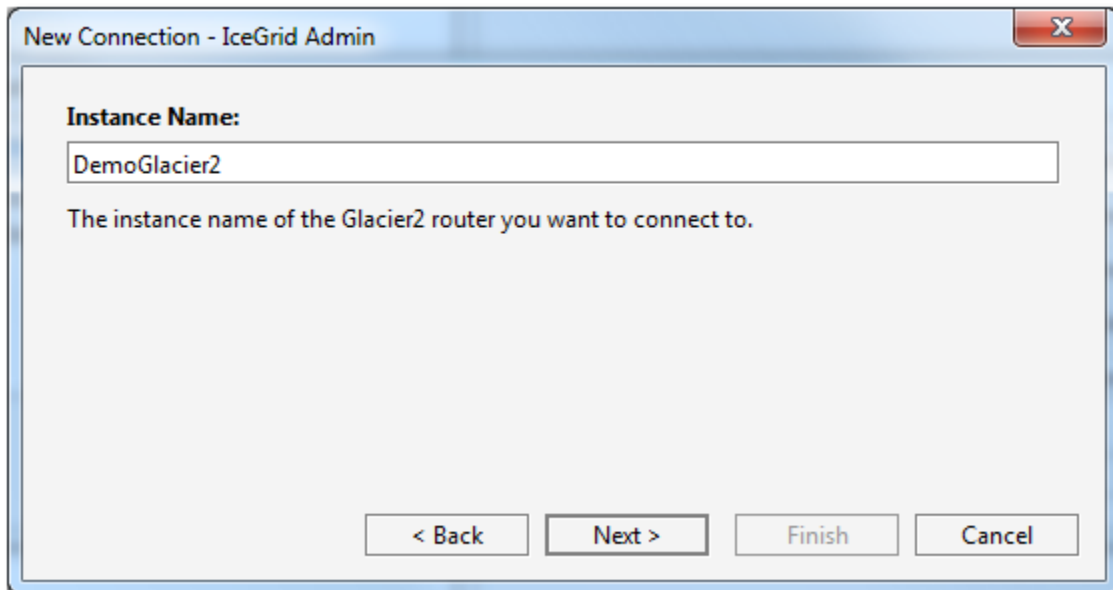

Step 3: we enter the addressing information for the target Glacier2 router as a hostname and port number

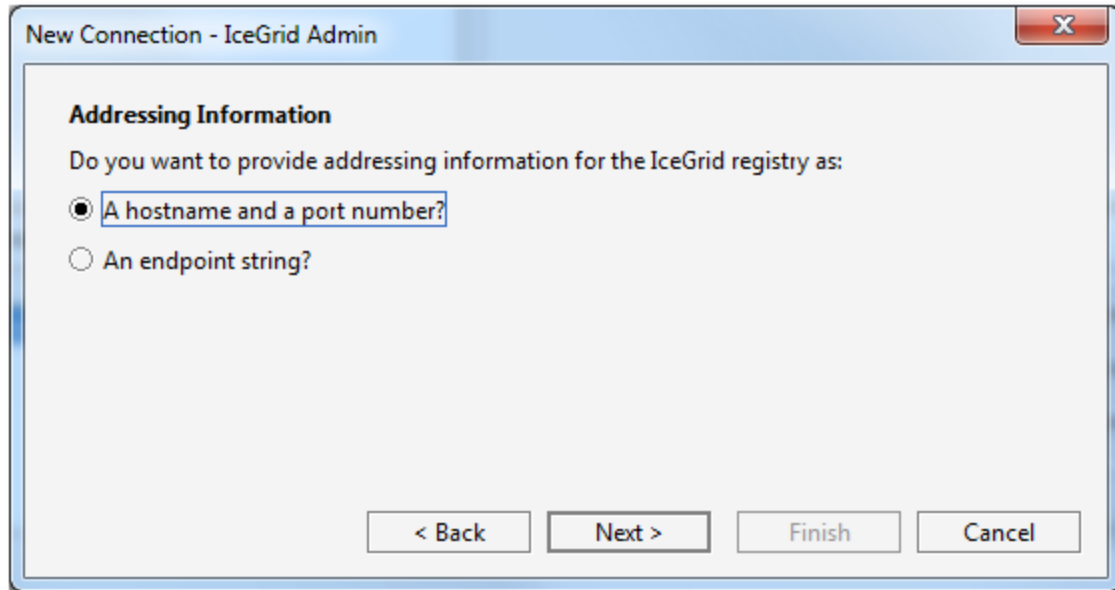

Step 4: we choose not to authenticate ourselves for SSL, so we do not provide a X.509 certificate.

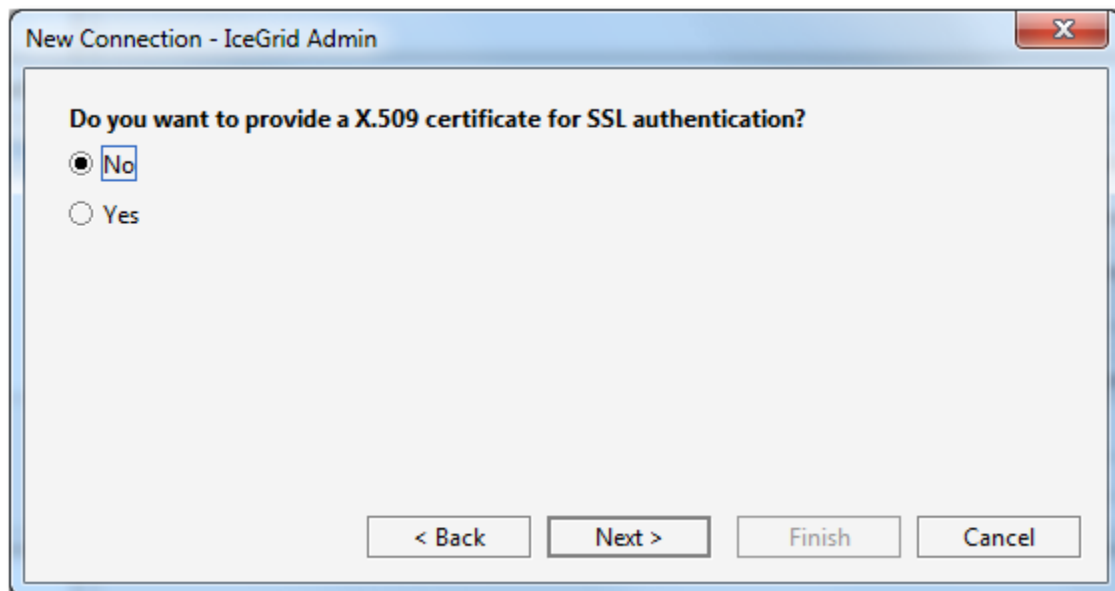

Step 5: we provide a username and password for the connection to the Glacier2 router

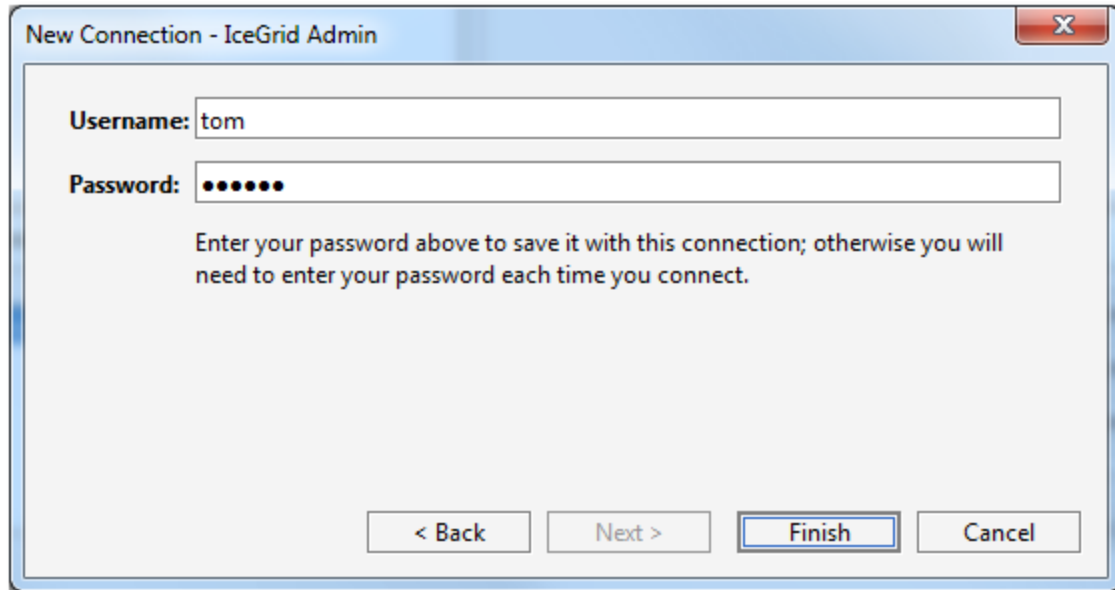

Step 6: we click on the `Finish` to save the connection; IceGrid Admin then attempts to connect to the IceGrid registry through the Glacier2 router.

SSL Connections and Certificates

IceGrid Admin maintains a persistent store of X.509 certificates for SSL connections with IceGrid registries. You can import, view and remove these certificates with the Certificate Manager. Use `File > Certificate Manager...` or click on the `Import...` button in the Connection wizard to open the Certificate Manager:

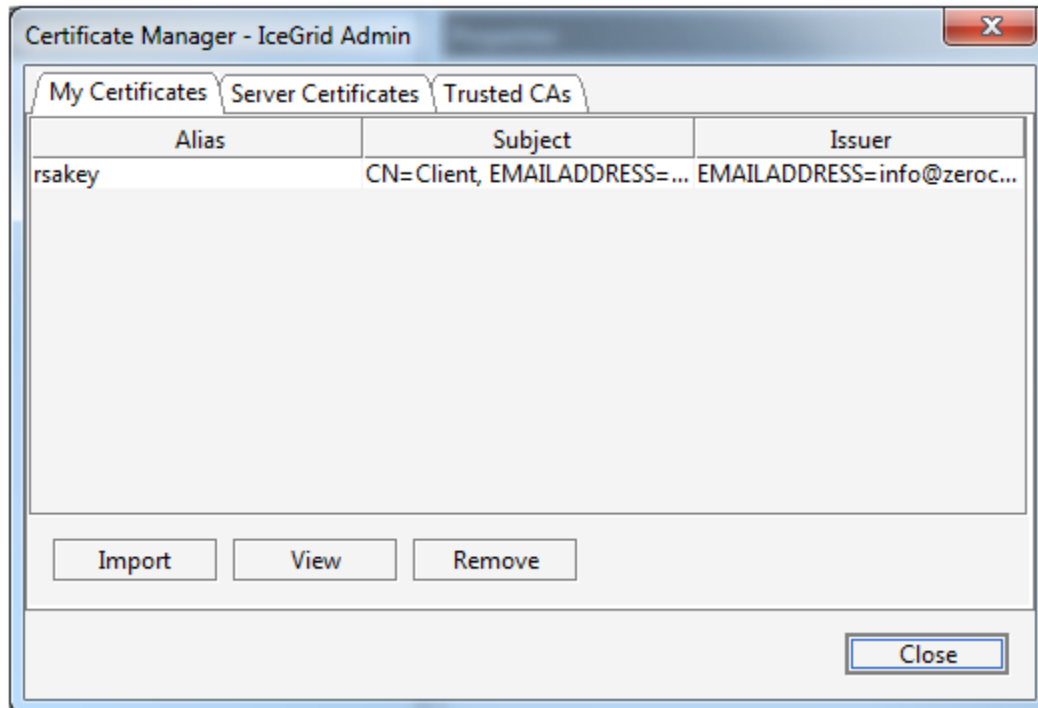

The Certificate Manager maintains 3 sets of certificates:

- **My Certificates**

These certificates are used to authenticate IceGrid Admin when establishing a SSL connection with an IceGrid registry or Glacier2 router (this first authentication is at the SSL level); once the SSL connection is established, this certificate can also be used to authenticate with the target IceGrid registry or Glacier router (at the application level).

- **Server Certificates**

The certificates of IceGrid registries and Glacier2 routers that IceGrid Admin trusts when establishing a SSL connection. All certificates signed by a Trusted CA (see below) are automatically trusted and usually do not need to be imported in this set.

- **Trusted CAs**

The certificates of Certificate Authorities.

You do not need to import server certificates or CA certificates prior to establishing a SSL connection with an IceGrid registry or Glacier2 router. IceGrid Admin performs the following checks when establishing a SSL connection:

- If the X.509 certificate presented by the IceGrid registry or Glacier2 router matches a Server Certificate, proceed
- Otherwise, if this certificate is signed by a trusted CA, is valid (*now* is within the certificates validity period) and its alternate name is a match for the SSL connection remote address, proceed
- Otherwise, display a Connection Security Warning dialog similar to the dialog below to let you decide whether or not to proceed with this certificate:

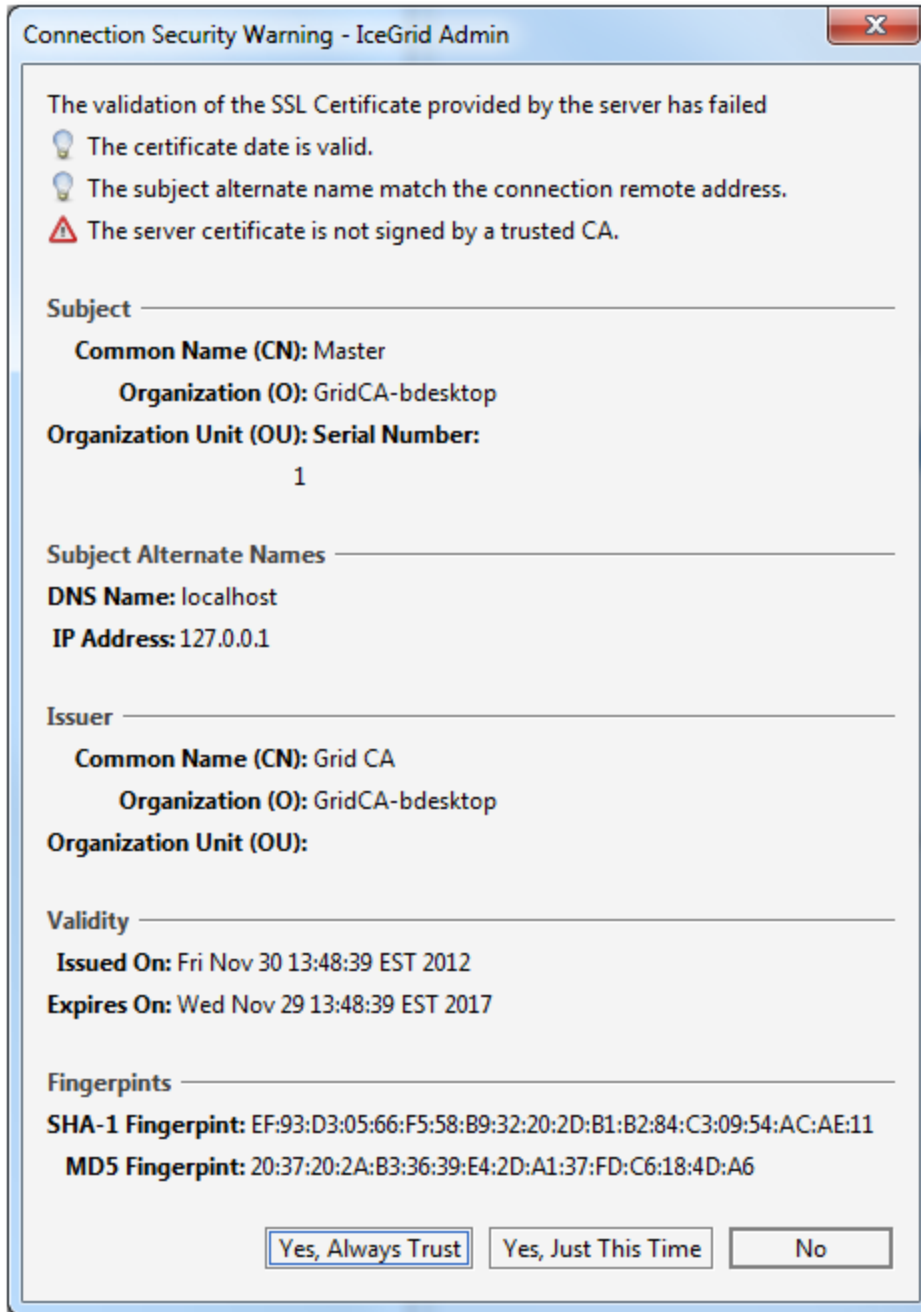

If you select `Yes, Always Trust`, the certificate is added in the persistent Server Certificates set.

A "client" X.509 certificate (saved in My Certificates) is only necessary when the target IceGrid registry or Glacier2 router requires one. This depends on the setting of the `IceSSL.VerifyPeer` property in those servers: when `IceSSL.VerifyPeer` is 2, IceGrid Admin must provide a valid certificate. If you forget to provide a certificate, or provide an invalid certificate, the connection establishment will fail with an IceSSL error comparable to the following:

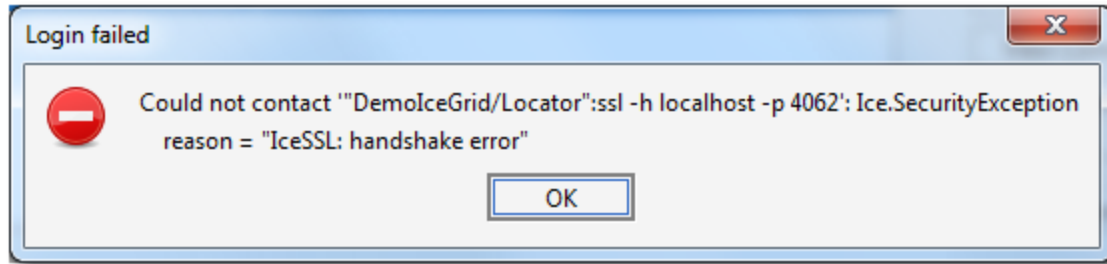

Editing a Saved Connection

In the `Saved Connections` dialog, click on `Edit Connection` to edit a connection. This opens the `Connection wizard` for your saved connection. With this wizard, `IceGrid Admin` does not attempt to connect to the target `IceGrid` registry when you click on the `Finish` button.

Closing a Connection

Use `File > Logout` or press the  button to disconnect from an `IceGrid` registry. This clears all information in the `Live Deployment` pane.

Log File Dialog

The Log File dialog shows a log file (text file) retrieved through IceGrid. Often, a process will be writing to this log file and the dialog will periodically check for new lines to display.

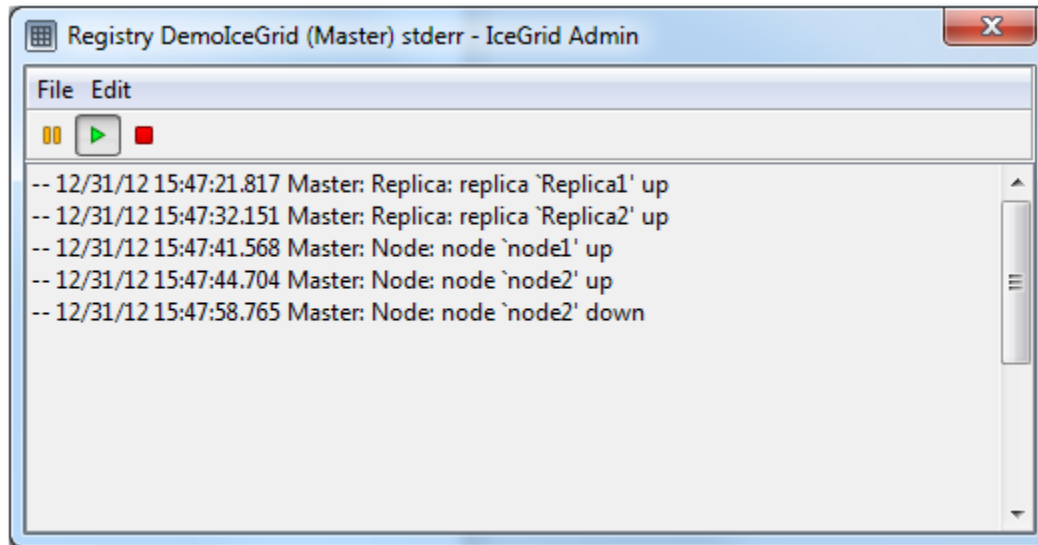

On this page:

- [States](#)
- [Preferences](#)

States

A log file dialog is always in one of the following states:

- **Running**
The dialog is periodically checking for new lines.
- **Paused**
The dialog is "connected" to a remote log file but does not currently retrieve new lines.
- **Stopped**
The dialog is not retrieving new lines from the remote log file.

Preferences

Use the `Edit > Preferences...` menu to open the Preferences dialog. These preferences apply to the current dialog and to any Log File dialog opened later on.

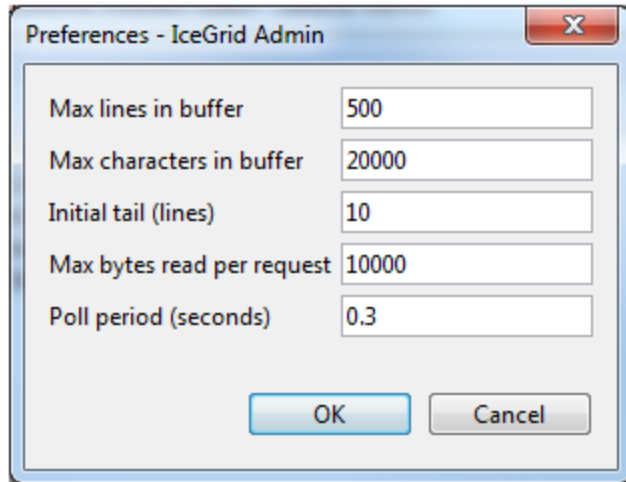









This dialog allows you the view and update the following settings:

- **Max lines in buffer**
The maximum number of lines displayed in the log dialog.
- **Max characters in buffer**
The maximum number of characters displayed in the log dialog.
- **Initial tail**
When a new dialog is opened, or when restarting a stopped dialog, the dialog retrieves and displays Initial tail lines.
- **Max bytes read per request**
The maximum number of bytes retrieve by each request. Pick a value that is low enough to make the dialog appear responsive and big enough to avoid many round-trips when lots of data are logged. IceGrid Admin requires a value between 100 and Ice.MessageS
izeMax - 512.
- **Poll period**
When in the running state, the dialog attempts to retrieve new lines from the log file (through IceGrid) every Poll period seconds.

Run Time Components

IceGrid Admin shows the following run time components:

- **Registry** ()
Represents the IceGrid registry process with which IceGrid Admin communicates
- **Slave Registry** ()
Represents a slave registry process, when you have several replicated IceGrid registries
- **Node** ()
Represents an IceGrid node process
- **Regular Server** ()
Represents a regular server process, started and monitored by an IceGrid node
- **IceBox Server** ()
Represents an IceBox server process, started and monitored by an IceGrid node
- **Adapter** ()
Represents an Ice indirect object adapter, deployed within a server or a service
- **Database Environment** ()
Represents a Freeze/Berkeley DB Database Environment, deployed within a server or a service
- **IceBox Service** ()
Represents an IceBox service, deployed on an IceBox server
- **Metrics View** ()
Represents a Metrics view associated with an Ice server or service.

All actions on these components (through menus, buttons and keyboard short-cuts) affect directly and immediately the running IceGrid deployment.

Registry Run Time Component

The registry is the root node of the Run Time Components tree, and represents the IceGrid registry process administered by IceGrid Admin.

On this page:

- [Actions](#)
- [Properties](#)
- [Children](#)

Actions

A registry provides the following actions, from its contextual menu and from the `Tools > Registry` menu:

- **Add Well-Known Object**
Create a new dynamic well-known object in the IceGrid registry.
- **Retrieve stdout**
Retrieve the stdout log file of the IceGrid registry into a [Log File Dialog](#) . This retrieval succeeds only when the registry stdout output has been redirected to a file using the `Ice.Stdout` property.
- **Retrieve stderr**
Retrieve the stderr log file of the IceGrid registry into a [Log File Dialog](#) . This retrieval succeeds only when the registry stderr output has been redirected to a file using the `Ice.StdErr` property.
- **Shutdown**
Shutdown the registry process.



You cannot restart an IceGrid registry from IceGrid Admin.

Properties

The Registry Properties panel shows:

- **Hostname**
The name of the host on which the IceGrid registry process is running.
- **Deployed Applications**

Deployed Applications	
Name	Last Update
OnFile	Dec 31, 2012 4:11:59 PM
Simple	Dec 31, 2012 4:12:53 PM

This table shows all the applications deployed on this IceGrid registry, along with the date and time of the last update of each application. A contextual menu allows you to:

- open the corresponding application descriptor
 - patch the application, that is, instruct the IceGrid nodes to download the latest version of this application's files
 - show additional details on this application in this registry
 - remove (undeploy) the application from the registry
- **Dynamic Well-Known Objects**

Proxy	Type
DemoIceGrid/InternalRegistry-Master -t -e 1.1:tcp -h localhost -p 5...	::IceGrid::InternalRegistry
DemoIceGrid/InternalRegistry-Replica1 -t -e 1.1:tcp -h localhost -p ...	::IceGrid::InternalRegistry
DemoIceGrid/InternalRegistry-Replica2 -t -e 1.1:tcp -h localhost -p ...	::IceGrid::InternalRegistry
DemoIceGrid/Locator -t -e 1.1:tcp -h localhost -p 12000 -t 10000:tc...	::Ice::Locator
DemoIceGrid/Query -t -e 1.1:tcp -h localhost -p 12000 -t 10000:tcp ...	::IceGrid::Query
DemoIceGrid/Registry -t -e 1.1:tcp -h localhost -p 12000 -t 10000	::IceGrid::Registry
DemoIceGrid/Registry-Replica1 -t -e 1.1:tcp -h localhost -p 12001 -...	::IceGrid::Registry
DemoIceGrid/Registry-Replica2 -t -e 1.1:tcp -h localhost -p 12002 -...	::IceGrid::Registry

This table shows the well-known objects registry dynamically with the IceGrid registry: well-known objects defined using adapter and replica-group definitions are not included. A contextual menu allows you to add or remove entries from this table, and to show a given entry in its own dialog.

- **Dynamic Object Adapters**

This table shows the object adapters registered dynamically with the registry. It is typically empty. A registry allows dynamically registered adapters only when its `IceGrid.Registry.DynamicRegistration` property is set to a value greater than 0. A contextual menu allows you to remove entries from this table.

Note that application filtering does not affect this panel: all applications, well-known objects and dynamic object adapters are always displayed.

Children

A registry node can have two types of children:

- Slave Registry
- Node

Slave Registry Run Time Component

An IceGrid deployment may use several IceGrid registry replicas, with one Master registry and a number of read-only Slave registries.

Actions

A slave registry provides the following actions, from its contextual menu and from the `Tools > Registry` menu

- **Retrieve stdout**
Retrieve the stdout log file of the IceGrid registry into a [Log File Dialog](#) . This retrieval succeeds only when the registry stdout output has been redirected to a file using the `Ice.Stdout` property.
- **Retrieve stderr**
Retrieve the stderr log file of the IceGrid registry into a [Log File Dialog](#) . This retrieval succeeds only when the registry stderr output has been redirected to a file using the `Ice.Stderr` property.
- **Shutdown**
Shutdown the registry process.



You cannot restart an IceGrid registry from IceGrid Admin.

Properties

The Registry Properties panel shows:

- **Hostname**
The name of the host on which the IceGrid registry process is running.



Node Run Time Component

A node represents an IceGrid node process registered with the IceGrid registry.

On this page:

- [States](#)
- [Actions](#)
- [Properties](#)
- [Children](#)

States

A node can be either up () or down (). A "down" node is shown only when it is described by an application deployed on this IceGrid registry.

Actions

A node provides the following actions, from its contextual menu and from the `Tools > Node` menu:

- **Retrieve stdout**
Retrieve the stdout log file of the IceGrid node into a [Log File Dialog](#). This retrieval succeeds only when the node stdout output has been redirected to a file using the `Ice.Stdout` property.
- **Retrieve stderr**
Retrieve the stderr log file of the IceGrid node into a [Log File Dialog](#). This retrieval succeeds only when the node stderr output has been redirected to a file using the `Ice.StdErr` property.
- **Shutdown**
Shutdown the IceGrid node process.



You cannot restart an IceGrid node from IceGrid Admin.

Properties

The screenshot shows a 'Node Properties' window with two main sections: 'System Information' and 'Configuration'.

System Information:

- Hostname: BDESKTOP
- Operating System: Windows 6.1 Service Pack 1
- Machine Type: x64 with 4 CPU threads
- CPU Usage: 2.8% 3.4% 3.0% (with a Refresh button)

Configuration:

Load Factor	Application	Value
	Simple	Default

The Node Properties panel shows:

- **Hostname**
The name of the host on which the IceGrid node process is running.
- **Operating System**
The operating system name and version of the host on which the IceGrid node process is running.
- **Machine Type**
The type of CPUs and the number of CPU threads of the host on which the IceGrid node process is running. For example, a computer with a dual-core CPU and 2 "hyper threads" per core will show 4 CPU threads.
- **CPU Usage (Windows) or Load Average (Linux/Unix)**
On Windows, shows the percentage of CPU utilization in the past 1, 5, and 15 minutes. On Linux/Unix, shows the load-average in the past 1, 5 and 15 minutes. These values are retrieved when the Node Properties panel is displayed. Click on the Refresh button to retrieve the latest values.
- **Load Factor**
Shows the load factor defined by each application using this node.

Children

A registry node can only have two types of children:

- Regular Server
- IceBox Server

Server Run Time Component







A server represents an Ice server process. It can be either regular server (with typically a single Ice communicator) or an IceBox server hosting a number of IceBox services.

On this page:

- [States](#)
- [Actions](#)
- [Properties](#)
- [Children](#)

States

A server is always in one of the following states (the first icon is for regular servers, the second for IceBox servers):

- Unknown (): this state is shown when the parent IceGrid node is down.
- Inactive (): the server is not running.
- Activating (): the server is starting up. The IceGrid registry is waiting for the server to register all its object adapters with server lifetime.
- Active (): the server is running, and has registered all its object adapters with server lifetime with the IceGrid registry.
- Deactivating (): the server is shutting down. The IceGrid registry is waiting for the server process to exit.
- Destroyed (): the server being removed of the IceGrid registry. This is a very transient state.

A server can also be either enabled or disabled; when disabled, the icons above are grayed-out. A disabled server cannot be started until it is re-enabled.

Actions

A server provides the following actions, from its contextual menu, from the `Tools > Server` menu, and from buttons on the Server Properties panel:

- **Start**
Instruct the IceGrid node to start the server.
- **Stop**
Instruct the IceGrid node to shutdown the server.
- **Enable**
Mark the server as "enabled".
- **Disable**
Mark the server as "disabled". A [disabled server](#) cannot be started; however an already running server can be marked "disabled".
- **Patch Distribution**
Patch the server's distribution, that is, instruct the IceGrid node to download the latest files from the server's distribution.
- **Write Message**
Open a dialog that allows you to write a message to the server's stdout or stderr.
- **Retrieve stdout**
Retrieve the stdout log file of this server into a [Log File Dialog](#). This retrieval succeeds only when the server's stdout output has been redirected to a file using the `Ice.Stdout` property. This is usually achieved by setting the `IceGrid.Node.Output` property in the IceGrid node configuration file.
- **Retrieve stderr**
Retrieve the stderr log file of this server into a [Log File Dialog](#). This retrieval succeeds only when the server's stderr output has been

redirected to a file using the `Ice.StdErr` property. This is usually achieved by setting the `IceGrid.Node.Output` property in the IceGrid node configuration file.

- **Retrieve Log**
Retrieve a log file of this server into a [Log File Dialog](#).
- **Send Signal**
Send a signal to a server, for example SIGQUIT. Available only for non-Windows servers.

Properties

The Server Properties panel shows first the Runtime Status of the server, i.e. "live" values retrieved from the server:

- **State**
The state of the server (Active, Deactivating, Inactive etc., see above)
- **Enabled**
A checkbox that is checked when the server is enabled.
- **Process Id**
The process ID of the server.
- **Build Id**
The build Id of this server: this corresponds to the Ice property `BuildId`.
- **Properties**
A table showing all the Ice properties currently set in this server. These properties are retrieved each time you select a new server in IceGrid Admin, and each time you click on the Refresh button next to the Build Id field.

The remaining Server Properties under Configuration come from the IceGrid descriptors associated with this server:

- **Application**

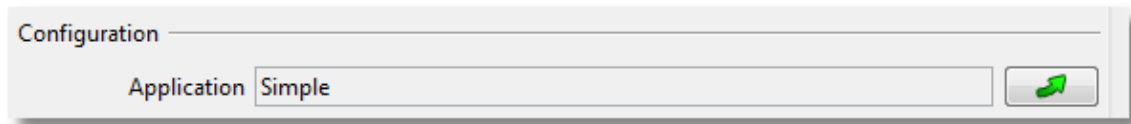

The name of the application containing this server's definition. The button on the right shows the server definition in an Application tab.

- **Description**
A free-text description of this server.
- **Properties**
A table showing all the Ice properties of this server. These properties may come from template definitions, property sets, server-instance properties etc. They are all combined in this table.
- **Path to Executable**
The path to the server's executable, used by the IceGrid node to start the server.
- **Ice Version**
The Ice version of this server.
- **Working Directory**
The path to the server's working directory used by the IceGrid node when starting the server.
- **Command Arguments**

The command-line arguments given to the server when started by IceGrid.

- **Run as**

On Linux/Unix, a server may be started as a specific user when IceGrid node runs as root. Run as shows this username. When blank, the server runs as the IceGrid node user except if IceGrid node runs as root (on Linux/Unix); in this case, the server runs as nobody.

- **Environment Variables**

A server started by IceGrid node gets these environment variables in addition to the environment variables inherited from the IceGrid node.

- **Activation Mode**

The server's activation mode.

- **Activation Timeout**

The server's activation timeout.

- **Deactivation Timeout**

The server's deactivation timeout.

- **Allocatable**

This checkbox Shows whether this server is allocatable or not.

- **Depends on the application distribution**

If this checkbox is checked, this server depends on the enclosing application's distribution: each time this distribution is patched, the server is automatically shut down before the patch.

- **IcePatch2 Proxy**

A stringified or well-known proxy for the IcePatch2 server than contains this server's distribution. When blank, this server does not have its own distribution.

- **Directories**

List of directories included in the server distribution. When blank, the entire IcePatch2 server repository is used as the server distribution.

Children

A regular server node can have two types of children:

- [Adapter](#)
- [Database Environment](#)

An IceBox server node can have only one type of children:

- [Service](#)



Adapter Run Time Component

An adapter represents an Ice object adapter described in the IceGrid registry that resides in a server or an IceBox service. Note that direct object adapters are not displayed since IceGrid knows nothing about them.

On this page:

- [States](#)
- [Properties](#)

States

An adapter can be either active () or inactive () .

Properties

The Adapter Properties panel shows first the Runtime Status of the object adapter, i.e. "live" values retrieved from the enclosing server or service:

- **Status**
The status of this object adapter: Active or Inactive.
- **Published Endpoints**
The endpoints that this object adapter has registered with the IceGrid registry. Blank when the adapter's status is Inactive.

The remaining Server Properties under Configuration come from the IceGrid descriptor that defined this object adapter:

- **Description**
A free-text description of this adapter.
- **Adapter ID**
This object adapter's ID. Adapter IDs are unique within an IceGrid deployment.
- **Replica Group**
When this adapter belongs to a replica group, shows the replica group ID. Blank otherwise.
- **Priority**
The adapter's priority. Used only when the adapter belongs to a replica group with the "Ordered" load balancing policy.
- **Endpoints**
The Endpoints configuration property of this object adapter.
- **Published Endpoints**
The PublishedEndpoints configuration property of this object adapter.
- **Register Process**
When the Register Process checkbox is checked, this object adapter will register an `Ice::Process` object with IceGrid upon activation. This setting is meaningful only for servers with an Ice version less than 3.3.
- **Server Lifetime**
When the Server Lifetime checkbox is checked, IceGrid considers that this object adapter is activated when the server starts up and deactivated when the server shuts down. This allows IceGrid to detect when a server is fully activated (all its object adapters with a server-lifetime have registered) and when a server is shutting down (at least one object adapter with server-lifetime has unregistered).
- **Well-known Objects**
The well-known objects defined by this object adapter.
- **Allocatable Objects**

The allocatable objects defined by this object adapter.

Database Environment Run Time Component

A Database Environment () represents a Berkeley DB database environment, used by the Freeze persistence service.

Properties

The Database Environment Properties panel shows:

- **Description**
A free-text description of this Berkeley DB database environment.
- **DB Home**
The path to the home directory of this database environment, which corresponds to the Ice property `Freeze.DbEnv.env-name.DbHome`. It is often created by the IceGrid node in the server's private directory.
- **Properties**
Berkeley DB configuration properties for this database environment. IceGrid generates a `DB_CONFIG` file in the DB Home directory with these properties.



Service Run Time Component

A service represents an IceBox service loaded (or potentially loaded) within an IceBox server.

On this page:

- [States](#)
- [Actions](#)
- [Properties](#)
- [Children](#)

States

A service can be either started () or stopped () within an IceBox server.

Actions

An IceBox service provides the following actions, from its contextual menu, from the `Tools > Service` menu, and from buttons on the Service Properties panel:

- **Start**
Instruct the IceBox server to start the service.
- **Stop**
Instruct the IceBox server to stop this service.
- **Retrieve Log**
Retrieve the log file of this service into a [Log File Dialog](#).

Properties

The Service Properties panel shows first the Runtime Status of the service, i.e. "live" values retrieved directly from the service:

- **State**
A checkbox that is checked when the service is started.
- **Build Id**
The build Id of this service: this corresponds to the Ice property `BuildId`.
- **Properties**
A table showing all the Ice properties currently set in this service. These properties are retrieved each time you select a new service in IceGrid Admin, and each time you click on the Refresh button next to the Build Id field.

The remaining Server Properties come from the IceGrid descriptors associated with this service:

- **Description**
A free-text description of this service.
- **Properties**
A table showing all the Ice properties of this service. These properties may come from template definitions, property sets, service-instance properties etc. They are all combined in this table.
- **Entry Point**
The entry point for this service. This corresponds to the value of the `IceBox.Service.name` property.

Children

An IceBox service can have two types of children:

- [Adapter](#)
- [Database Environment](#)



Metrics View Run Time Component

A Metrics View displays the Metrics maps associated with a Server or Service.

On this page:

- [States](#)
- [Actions](#)
- [Metrics Report](#)

States

A metrics view can be either enabled () or disabled (). Once enabled, a Metrics View may degrade the performance of the instrumented server or service.

Actions

An Metrics View provides the following actions, from its contextual menu and from the `Tools > Metrics View` menu:

- **Enable**
Enable this Metrics View.
- **Disable**
Disable this Metrics View.

Metrics Report

The Metrics Report panel shows the maps included in the Metrics View. The columns of the maps include the metrics themselves (for example, the total number of operations dispatched by the server since the Metrics view was enabled) and computed values (for example, the average lifetime of an operation dispatch, since the Metrics view was enabled).



Tool tips on each column describe the metrics or computed value displayed by the column.

IceGrid Admin retrieves the latest metrics every 5 seconds and automatically refreshes the current Metrics Report.

Note that IceGrid Admin displays only non-empty metrics maps; for example, if a server does not make any remote invocation, its Invocation map is empty and will not be displayed.

Application Component

An application is primarily a way to group definitions and does not actually exist in a live deployment.

Nevertheless, IceGrid Admin offers a number of application-related actions in the live deployment view through the Filter live deployment button and the Tools > Application menu:

- **Patch Distribution**
Instruct the IceGrid nodes to download the latest version of the files associated with the selected application.
- **Show details**
Show various information about the selected application.
- **Filter live deployment**
Shows only the selected application in the live deployment view; servers and other components associated with other applications are "filtered out".

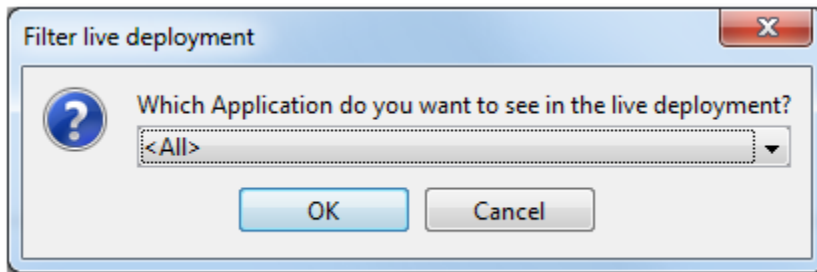

When filtering is enabled, the name of the selected application appears to the right of the registry name. In the picture below, the live deployment view shows only the application named 'Simple'.

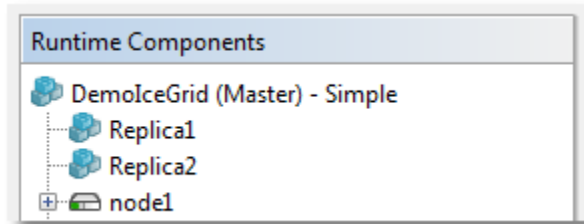

- **Remove from registry**
Remove the selected application from the registry.

Metrics Graph

A Metrics Graph displays metrics retrieved from one or more Ice servers or IceBox services.

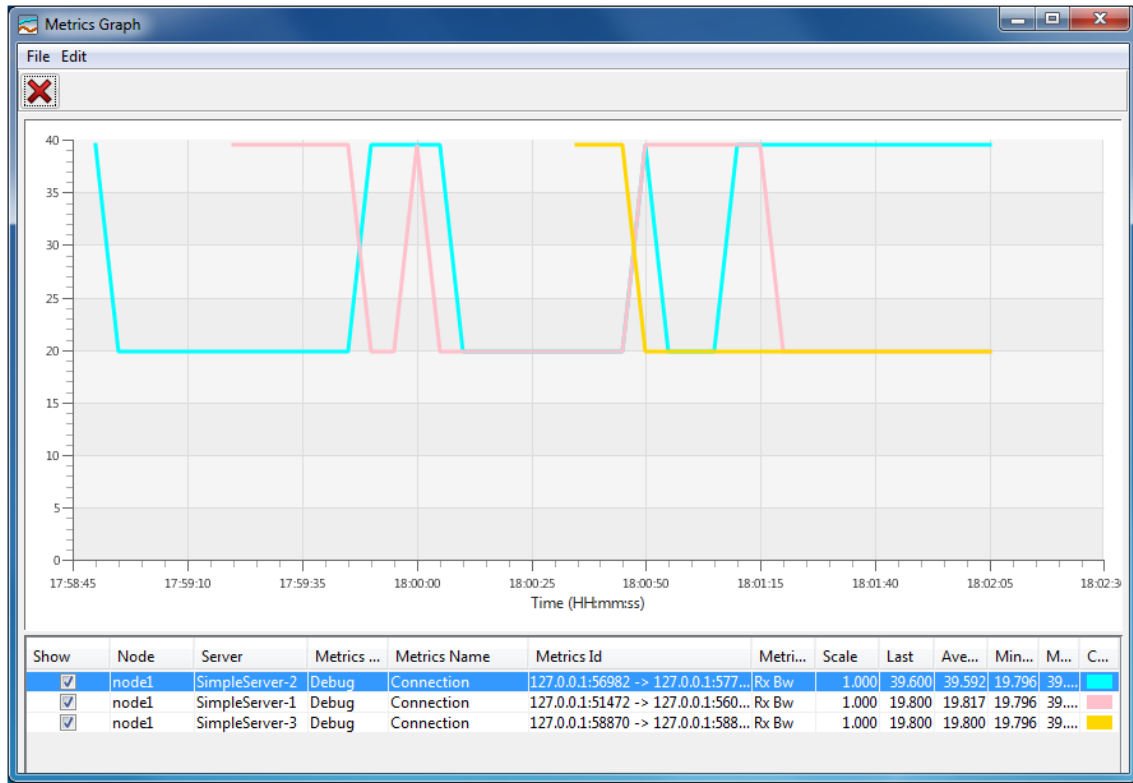

The horizontal axis corresponds to the time, while the vertical axis plots the corresponding metrics values.

 The Metrics Graph feature requires Java 7 and JavaFX.

On this page:

- [Creating a New Metrics Graph](#)
- [Adding and Removing Metrics](#)
- [Adjusting Scale and Color](#)
- [Metrics Graph Preferences](#)

Creating a New Metrics Graph

You can create a new Metrics Graph window with the `File > New > Metrics Graph` menu, or with a contextual menu over a metric in a Metrics View, for example:

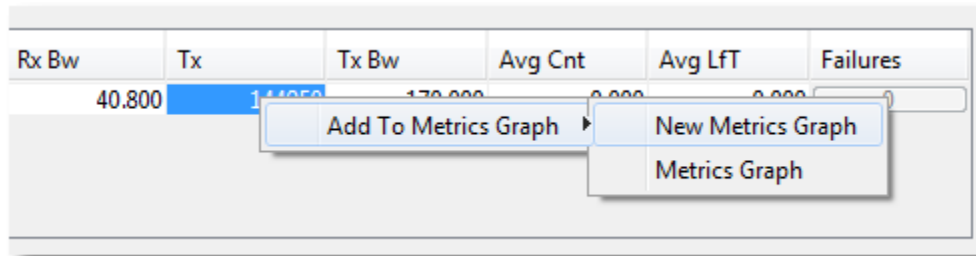

Adding and Removing Metrics

A metric is added to a Metrics Graph with drag & drop, or through a contextual menu over this metric.

To remove a metric from a Metrics Graph, select this metric and press Delete or the  button.

Adjusting Scale and Color

You can display metrics with different scales on the same graph by adjusting the scale factor of each metric. The values plotted are the metric's values times the scale factor; the default scale factor is 1.0.

Metrics Field	Scale	Last	Average	Minimum	Maximum	Color
Tx	0.0001	286475.000	285200.156	269900.000	286475.000	

0.00001	▲
0.0001	
0.001	
0.01	■
0.1	
1.0	
10.0	
100.0	▼

You can also change the color used to display a metric's line by clicking on the Color cell of the metric.

Metrics Graph Preferences

The File > Preferences menu of a Metrics Graph window opens a dialog that allows you to configure several properties of your Metrics Graph:

Metrics Graph Preferences ✕

Title:

Sample interval: ▲ ▼
Sample interval in seconds; must be between 1 and 3600 seconds.

Samples displayed: ▲ ▼
The number of samples displayed on a graph; must be between 2 and 300.

Time format: ▼

For each metric plotted in a Metrics Graph, IceGrid Admin retrieves the corresponding value every `Sample interval` seconds (by default every 5 seconds), and displays `n` values (`n = 120` by default). `Sample interval` times `Samples displayed` correspond to the time period represented on a graph; by default, it is $5s * 120 = 10$ minutes.

Application Tabs

IceGrid definitions are organized in "applications", with typically one or a few applications deployed on a given IceGrid instance.

An Application tab allows you to:

- create a new application: describe servers, IceBox services, the nodes you want to run them, specify load-balancing policies, etc.
- browse and edit the definition of an existing, live application deployed in an IceGrid instance
- browse and edit the definition of an application stored in an IceGrid XML file.

Topics

- [Editing and Saving IceGrid Descriptors](#)
- [Navigation within an Application Tab](#)
- [IceGrid Descriptors](#)
 - [Variables in IceGrid Descriptors](#)
 - [Application Descriptor](#)
 - [Node Descriptor](#)
 - [Server Descriptor](#)
 - [Service Descriptor](#)
 - [Adapter Descriptor](#)
 - [Database Environment Descriptor](#)
 - [Property Set Descriptor](#)
 - [Replica Group Descriptor](#)
 - [Server Template Descriptor](#)
 - [Service Template Descriptor](#)

Editing and Saving IceGrid Descriptors

On this page:

- Editing
- Copy & Paste
- Error Checking
- Saving
- Discarding Updates
- Concurrent Updates to the same IceGrid Registry

Editing

As soon as you make any update in a form, IceGrid Admin enables two buttons at the bottom of this form: Apply and Discard.

If you navigate to another node without pressing Apply or Discard, the default is Apply: your changes are applied to the in-memory representation of the application definition. However these changes are not stored to the IceGrid registry or XML file until you save the application definition (see below).

Editing a live application (🔗) also disconnects this application from the IceGrid registry: updates made by other users are no longer propagated to the Application tab.

Copy & Paste

Most descriptor sub-trees can be copied and later pasted. Copies are always deep-copies: for example if you copy a node, all the servers on this code are copied, including all the the sub-elements of these servers (object adapters, database environment, services, etc.).

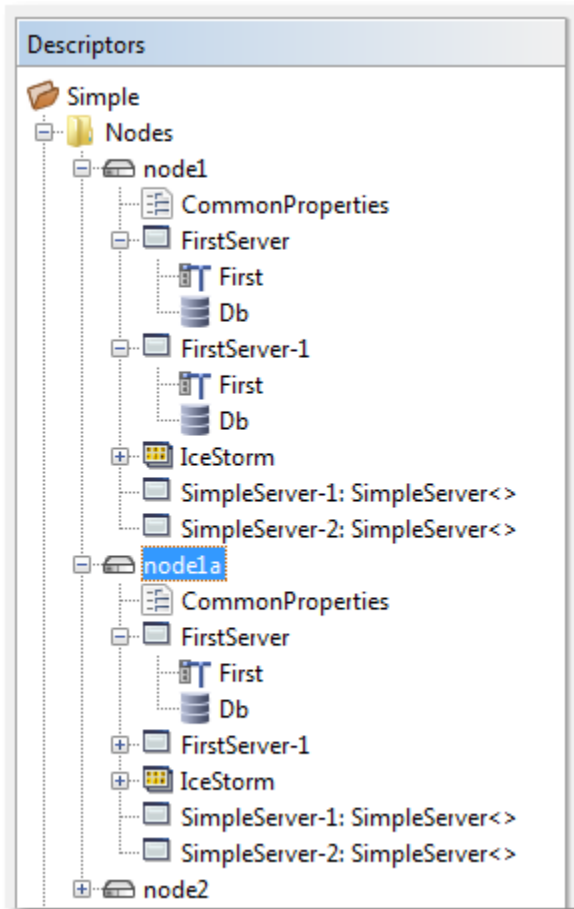

After pasting a sub-tree, you typically need to check and edit the new elements to avoid any duplicate server IDs, adapter IDs etc.

Error Checking

IceGrid Admin performs very little error checking while you are working on an application definition. For example, you may temporarily keep several servers with the same ID, leave some parameters of a template instance unset, or use an undefined variable. All such errors are only detected when you save your application to an IceGrid registry.

There are nonetheless two types of constraints enforced by IceGrid Admin at all times:

- two descriptor nodes in an application tab display cannot have the same name.
- some fields (such as Path to Executable for a server) cannot be empty.

If you violate such a constraint, IceGrid Admin prevents you from applying your change.

Saving

You save an application definition to an IceGrid registry or an XML file with the menu item `File > Save`, `File > Save to File`, `File > Save to Registry (Servers may restart)`, `File > Save to Registry (No Server restart)` or with the corresponding toolbar buttons.

`Save` is equivalent to `Save to Registry (Servers may restart)` for a live application, and to `Save to File` for a file-bound application.

Saving an application to the IceGrid registry causes the registry to distribute any relevant changes to the affected nodes. In turn, each node applies those changes to its servers. If a server is running at the time of an update, the node may need to stop and restart it, depending on the changes that you make. Consequently, saving to the registry could cause a disruption in service to any clients that are actively using the affected servers.

The following application changes do *not* require a restart:

- Adding, modifying, or removing a server's configuration properties
- Adding new servers

All other changes will require a restart. IceGrid Admin provides two versions of the `Save to Registry` command, one that allows restarts and one that does not. To avoid accidentally causing any disruption in service, we recommend using the `No server restart` option first; this command will fail if any of your updates require a restart. At that point, you can decide whether to force the servers to restart using the other `Save` command.

 If you change a server's configuration properties with `Save to Registry (No Server restart)`, IceGrid updates the stored properties of this server, and also the properties of your running server instance through its [Properties Facet](#). If these properties are only read by the server at start-up, this may not have the desired effect. If you want to trigger a server restart even when only properties have changed, use `Save to Registry (Servers may restart)`.

Discarding Updates

You may discard all your updates by selecting `File > Discard Updates` or pressing the corresponding toolbar button. `Discard Updates` simply reloads the application from the IceGrid registry or its associated XML file.

Concurrent Updates to the same IceGrid Registry

If several administrators update the same application definition concurrently, the last save will silently overwrite previous (concurrent) updates.

To avoid this situation, you can acquire an exclusive write access to the IceGrid registry with `File > Acquire Exclusive Write Access`. After this exclusive write access is granted, any attempt by another session to save to the IceGrid registry will result in an error:

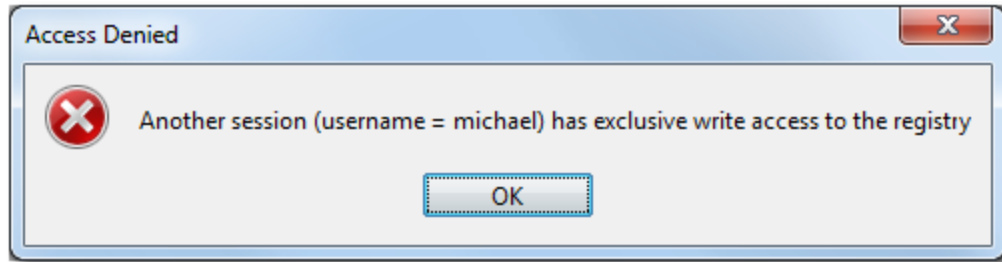

Navigation within an Application Tab

Each Application tab maintains a history of the nodes you have visited in this tab. You can navigate these nodes using the `View > Go Back to the Previous Node` and `View > Go to the Next Node` menu items, or with the equivalent toolbar buttons:



Also on some forms a green arrow button provides a link to another node (typically a template) in the same Application pane:

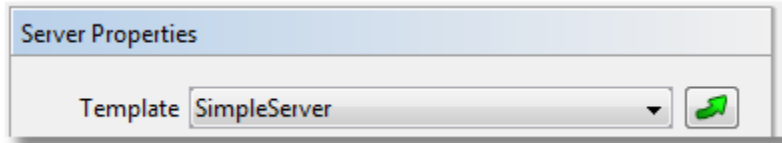

IceGrid Descriptors

An application definition is described using one application descriptor with a number of nested sub-descriptors (and sub-sub descriptors). The descriptors correspond to Slice types in the IceGrid registry interfaces, and to XML element in an IceGrid XML representation.

IceGrid Admin maps these descriptors to nodes on a tree representation:

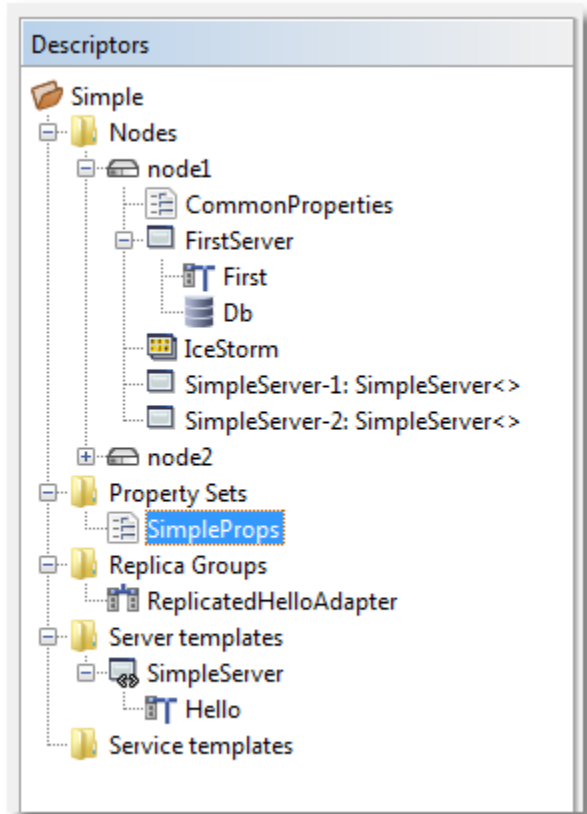

Topics

- [Variables in IceGrid Descriptors](#)
- [Application Descriptor](#)
- [Node Descriptor](#)
- [Server Descriptor](#)
- [Service Descriptor](#)
- [Adapter Descriptor](#)
- [Database Environment Descriptor](#)
- [Property Set Descriptor](#)
- [Replica Group Descriptor](#)
- [Server Template Descriptor](#)
- [Service Template Descriptor](#)

Variables in IceGrid Descriptors

Variables allow you to define commonly-used information once and refer to them symbolically throughout your application descriptors.

On this page:

- [Syntax](#)
- [Where are Variables Allowed?](#)
- [Escaping a Variable](#)
- [Pre-Defined Variables](#)
- [Variable Substitution in IceGrid Admin](#)
- [Scoping Rules](#)
- [Resolving a Reference](#)
- [Modifying a Variable](#)

Syntax

Substitution for a variable or parameter VP is attempted whenever the symbol `${VP}` is encountered, subject to the limitations and rules described below. Substitution is case-sensitive, and a fatal error occurs if VP is not defined when the application is saved to an IceGrid registry.

Where are Variables Allowed?

Substitution is performed in all string fields except the following:

- server and service template IDs (when defining a template or when referring to a template)
- variable names
- template parameter names
- node names
- application names

Escaping a Variable

You can prevent substitution by escaping a variable reference with an additional leading `$` character. For example, in order to assign the literal string `$(abc)` to a variable, you would use `$$$(abc)` as this variable's value.

The extra `$` symbol is only meaningful when immediately preceding a variable reference, therefore text such as `US$$55` is not modified. Each occurrence of the characters `$$` preceding a variable reference is replaced with a single `$` character, and that character does not initiate a variable reference.

Pre-Defined Variables

IceGrid defines a set of read-only variables to hold information that may be of use to descriptors. The names of these variables are reserved and cannot be used as variable or parameter names. The table below describes the purpose of each variable and defines the context in which it is valid.

Name	Description
application	The name of the enclosing application.
application.distrib	The pathname of the enclosing application distribution directory, and an alias for <code>\$(node.datadir)/distrib/\$(application)</code> .
node	The name of the enclosing node.
node.os	The name of the enclosing node operating system. On Unix, this value is provided by <code>uname</code> . On Windows, the value is <code>Windows</code> .
node.hostname	The host name of the enclosing node.

node.release	The operation system release of the enclosing node. On Unix, this value is provided by <code>uname</code> . On Windows, the value is obtained from the <code>OSVERSIONINFO</code> data structure.
node.version	The operation system version of the enclosing node. On Unix, this value is provided by <code>uname</code> . On Windows, the value represents the current service pack level.
node.machine	The machine hardware name of the enclosing node. On Unix, this value is provided by <code>uname</code> . On Windows, the value is <code>x86</code> or <code>x64</code> .
node.datadir	The absolute pathname of the enclosing node data directory.
server	The ID of the enclosing server.
server.distrib	The pathname of the enclosing server distribution directory, and an alias for <code>\${node.datadir}/servers/\${server}/distrib</code> .
service	The name of the enclosing service.
session.id	The client session identifier. For sessions created with a user name and password, the value is the user ID; for sessions created from a secure connection, the value is the distinguished name associated with the connection.

The availability of a variable is easily determined in some cases, but may not be readily apparent in others. For example, you can use the `${node}` variable in a property value within a server template definition, because variables in the body of a server template are evaluated when the server template is instantiated on a specific node.

Variable Substitution in IceGrid Admin

In a number of panes, you can substitute variables and template parameters by their respective value. Use `View > Show Variables` and `View > Substitute Variables` or the corresponding toolbar toggle buttons:



When variable-substitution is enabled, the descriptors are displayed read-only.

Scoping Rules

Descriptors may only define variables at the application and node levels. Each node introduces a new scope, such that defining a variable at the node level overrides (but does not modify) the value of an application variable with the same name. Similarly, a template parameter overrides the value of a variable with the same name in an enclosing scope. A descriptor may refer to a variable defined in any enclosing scope, but its value is determined by the nearest scope. The diagram below illustrates these concepts:

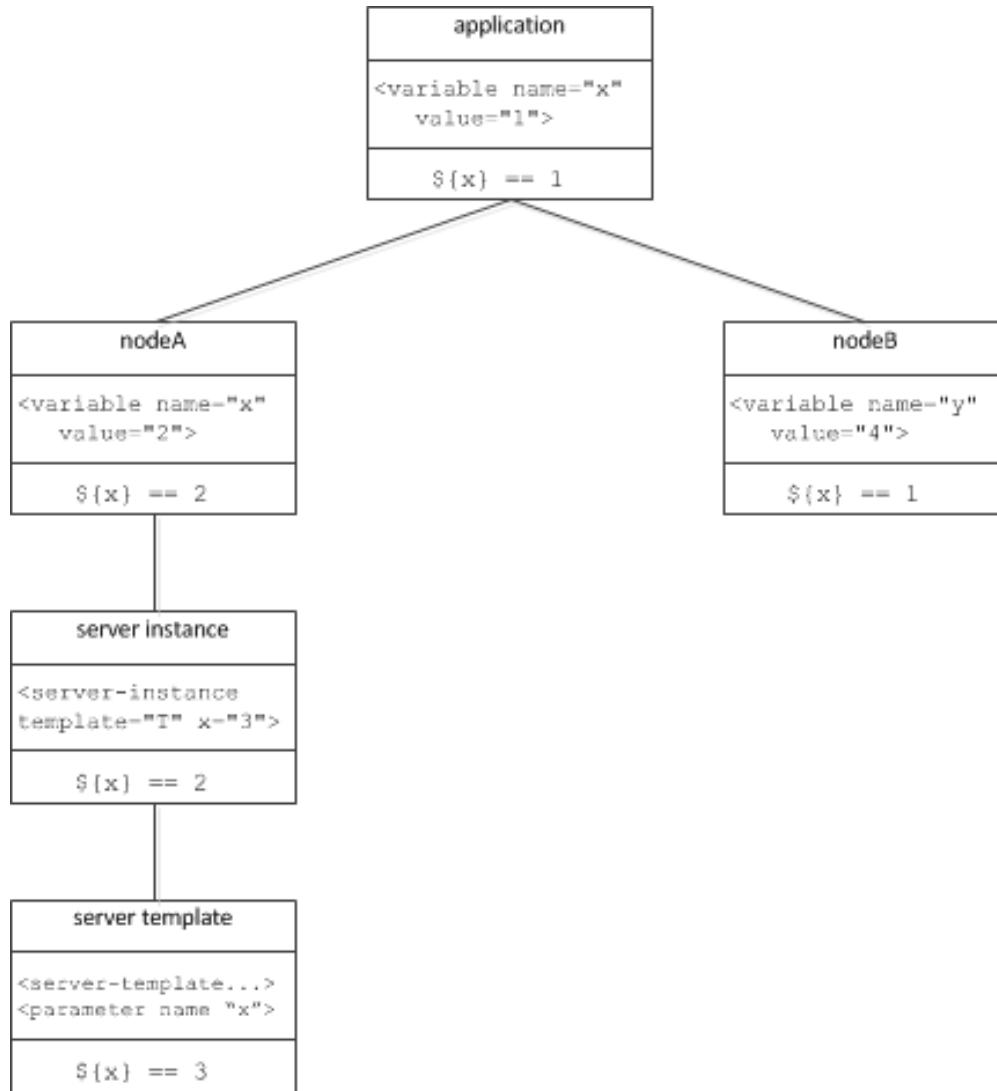

In this diagram, the variable `x` is defined at the application level with the value 1. In node A, `x` is overridden with the value 2, whereas `x` remains unchanged in node B. Within the context of node A, `x` continues to have the value 2 in a server instance definition. However, when `x` is used as the name of a template parameter, the node's definition of `x` is overridden and `x` has the value 3 in the template's scope.

Resolving a Reference

To resolve a variable reference `${var}`, IceGrid searches for a definition of `var` using the following order of precedence:

- Pre-defined variables
- Template parameters, if applicable
- Node variables, if applicable
- Application variables

After the initial substitution, any remaining references are resolved recursively using the following order of precedence:

- Pre-defined variables
- Node variables, if applicable
- Application variables
- Template Parameters

Template parameters are not visible in nested template instances. This situation can only occur when an IceBox server template instantiates a service template.

Modifying a Variable

A variable definition can be overridden in an inner scope, but the inner definition does not modify the outer variable.
See Also

- [Using Descriptor Variables and Parameters](#)

Application Descriptor

On this page:

- [Creating a new Application](#)
- [Properties](#)
- [Children](#)

Creating a new Application

You can create a new application using `File > New Application`: this opens a new Application tab, with an empty application definition.

When you are connected to an IceGrid registry, you can also use `File > New Application with Default Templates from Registry`. This also opens new Application tab with a brand new application definition. This new application contains a copy of all the templates definitions contained in the IceGrid registry default template file. See [IceGrid.Registry.DefaultTemplates](#).

Properties

The Application Properties panel offers the following fields:

- **Name**
The name of the application. This field is not editable for live applications.
- **Description**
A free-text description of this application.
- **Variables**
This table shows application-level [IceGrid variables](#).
- **IcePatch2 Proxy**
A stringified or well-known proxy for the IcePatch2 server than contains this application's distribution. Possible values:

Value	Description
"None selected" (default) or blank	no distribution defined
<code>\${application}.IcePatch2/server</code>	the well-known proxy of an IcePatch2 server deployed in this application using the IcePatch2 default server-template (with a default instance-name parameter value).
<i>stringified proxy</i>	your own stringified or well-known proxy

- **Directories**
List of directories included in the application distribution. When blank, the entire IcePatch2 server repository is used as the distribution.

Children

An application node can have five types of children:

- [Node](#)
- [Property Set](#)
- [Replica Group](#)
- [Server Template](#)
- [Service Template](#)

Node Descriptor

A node represents an IceGrid node that starts and monitors your servers. Several applications can be deployed on the same node; however a node descriptor describes only the servers defined by the enclosing application.

On this page:

- [Properties](#)
- [Children](#)

Properties

The Node Properties panel offers the following fields:

- **Name**
The name of the node. This name must match the `IceGrid.Node.Name` configuration property of the node process.
- **Description**
A free-text description of this node.
- **Variables**
This table shows node-level [IceGrid variables](#).
- **Load Factor**
A floating point value used to compare different nodes when making a [load-balancing](#) decision based on load-average (for Linux and Unix) or CPU utilization (for Windows). Leaving this value blank is equivalent to the default: 1.0 on Linux and Unix, and 1.0 divided by the number of CPUs on Windows.

Children

A node can have two types of children:

- [Server](#)
- [Property Set](#)

Server Descriptor

A server represents an Ice server deployed on a node as part of an application. IceGrid supports three kinds of servers:

- **Plain Server**
A normal Ice server, with typically a single Ice communicator. IceGrid generates a single Ice configuration file for this server.
- **IceBox Server**
An IceBox server, with usually a number of IceBox services deployed in it. IceGrid generates an Ice configuration file for the IceBox server itself, and also a separate Ice configuration for each IceBox service.
- **Server Instance**
A server (either plain server or IceBox server) defined using a server template.

On this page:

- [Plain Server](#)
 - [Properties](#)
 - [Children](#)
- [IceBox Server](#)
 - [Properties](#)
 - [Children](#)
- [Server Instance](#)
 - [Properties](#)
 - [Children](#)

Plain Server

Properties

The Server Properties panel offers the following fields:

- **Server ID**
The ID of the server; corresponds to the `Ice.Admin.ServerId` property. Each server must have a unique ID within an IceGrid deployment.
- **Description**
A free-text description of this server.
- **Property Sets**
List of property-set IDs; you refer to a [property set](#) to "include" all its properties in the server.
- **Properties**
Ice properties private to this server.
- **Log Files**
This table can be used to declare a number of log files used by this server. Path is the path to the log file (a relative path is relative to the IceGrid node working directory); when Property is set, IceGrid generates a property with this name and the log file path as value.
You declare log files to be able to conveniently retrieve them using IceGrid Admin (in the [Live Deployment](#) tab) or with the `icegrid admin` command-line utility.
- **Path to Executable**
Path to the server's executable; cannot be blank. A relative path is relative to the IceGrid node working directory.
- **Ice Version**
The Ice version of this server. If you don't provide a value, IceGrid assumes it's the same version as the IceGrid registry.
- **Working Directory**

The working directory for the server when started by the IceGrid node.

- **Command Arguments**

The command-line arguments given to the server when started by the IceGrid node.

- **Run as**

On Linux and Unix, when IceGrid node is running as root, it is possible to run the server under any username. Enter the desired username in this field.

When not set (the default), the server runs as the same user as the IceGrid node, except when IceGrid node runs as root. In this case, the server runs as nobody.

- **Environment Variables**

The environment variables for the server when started by the IceGrid node. These variables are in addition to variables defined in the IceGrid node own environment.

- **Activation Mode**

The server's activation mode. Must be one of:

Activation Mode	Description
always	IceGrid keeps this server running all the time
manual	This server is started "manually", using IceGrid Admin or the <code>icegridadmin</code> command-line utility
on-demand	IceGrid starts this server when it resolves the object-adapter ID of an object adapter defined in this server
session	IceGrid starts a separate instance of this server for each IceGrid session that allocates this server

The Activation Mode can also be a variable or a combination of variables that resolves to one of the values above.

- **Activation Timeout**

When activating a server, IceGrid gives timeout seconds to object adapters with server lifetime to register their endpoints with the IceGrid registry. During this time, lookup for the corresponding adapter IDs are delayed.

If not set or set to 0, the IceGrid node uses the value of its `IceGrid.Node.WaitTime` property.

- **Deactivation Timeout**

When deactivating a server, IceGrid gives timeout seconds to the server to exit gracefully. After this timeout, the server process is killed.

If not set or set to 0, the IceGrid node uses the value of its `IceGrid.Node.WaitTime` property.

- **Allocatable**

Specifies whether the server can be allocated. A server is allocated implicitly when one of its allocatable objects is allocated. This checkbox is ignored if the server activation mode is session; a server with this activation mode is always allocatable. Default: false.

- **Depends on the application distribution**

A server that depends on the application distribution is stopped and disabled before any application distribution update, and re-enabled after such update. Default: true.

- **IcePatch2 Proxy**

A stringified (or well-known) proxy for the IcePatch2 server than contains this server's private distribution. Possible values:

Value	Description
"None selected" (default) or blank	no private distribution defined

<code>\${application}.IcePatch2/server</code>	the well-known proxy of an IcePatch2 server deployed in this application using the IcePatch2 default server-template (with a default instance-name parameter value).
<i>stringified proxy</i>	your own stringified or well-known proxy

- **Directories**

List of directories included in the application distribution. When blank, the entire IcePatch2 server repository is used as the distribution.

Children

A plain server can have two types of children:

- [Adapter](#)
- [Database Environment](#)

IceBox Server

Properties

The Properties panel for an IceBox server is identical to the Properties panel for a [Plain Server](#).

When you create a new IceBox server, some properties are created automatically:

Property Name	Property Value
IceBox.InstanceName	<code>\${server}</code>
Ice.Admin.Endpoints	<code>tcp -h 127.0.0.1</code>

The `Ice.Admin.Endpoints` setting enables the Admin object in the main communicator of this IceBox server.

The Path to Executable is typically `icebox`, `iceboxd` (for a C++ IceBox), `java` (for a Java IceBox) or `iceboxcs` (for a .NET IceBox). In Java, the Command Arguments should include the IceBox container class name, `IceBox.Server`.

Children

An IceBox server can have only one type of children, [Service](#).

Server Instance

A server instance is a server created from a server template; it may be a plain server or an IceBox server.

Properties

The Server Instance Properties panel offers the following fields:

- **Template**
The name of the [Server Template](#).
- **Parameters**
Use this table to assign values to the template parameters defined in the server template.
- **Property Sets**
List of property-set IDs; you refer to a [property set](#) to "include" all its properties in this server-instance.
- **Properties**
Ice properties private to this server. Overall, the properties of the server instance are a combination of properties defined in the

server template (including its own property sets references) augmented and possibly overridden by properties defined in the server instance.

Children

An instance of an IceBox server template can have one type of children, [Property Set](#).

An instance of a plain server template cannot have any child.

Service Descriptor

A service represents an IceBox service deployed on an IceBox server. IceGrid supports two kinds of services:

- **Plain Service**
A service defined directly with a service descriptor
- **Service Instance**
A service defined using a service template

On this page:

- [Load Order](#)
- [Plain Service](#)
 - [Properties](#)
 - [Children](#)
- [Service Instance](#)
 - [Properties](#)

Load Order

The load-order of services within an IceBox server is determined by their display order in IceGrid Admin. You can reorder services using `Edit > Move Up` or `Edit > Move Down` (also available from each service's contextual menu).

Plain Service

Properties

The Service Properties panel offers the following fields:

- **Service Name**
The name of the service. Must be unique within the enclosing IceBox server.
- **Description**
A free-text description of this service.
- **Property Sets**
List of property-set IDs; you refer to a [property set](#) to "include" all its properties in the service.
- **Properties**
Ice properties private to this service.
- **Log Files**
This table can be used to declare a number of log files used by this service. Path is the path to the log file (a relative path is relative to the IceGrid node working directory); when Property is set, IceGrid generates a property with this name and the log file path as value.
You declare log files to be able to conveniently retrieve them using IceGrid Admin (in the [Live Deployment](#) pane) or with the `icegridadmin` command-line utility.
- **Entry Point**
The service's [entry point](#), for example `IceStormService,35:createIceStorm`.
IceGrid will append `--Ice.Config=path-to-service-config-file` to this entry point when it generates the `IceBox.Service.name` property in the enclosing IceBox server config file.

Children

A plain service can have two types of children:

- [Adapter](#)

- [Database Environment](#)

Service Instance

Properties

The Service Instance Properties panel offers the following fields:

- **Template**
The name of the [Service Template](#).
- **Parameters**
Use this table to give values to the template parameters defined in the service template.
- **Property Sets**
List of property-set IDs; you refer to a [property set](#) to "include" all its properties in the service.
- **Properties**
Ice properties private to this service.

Adapter Descriptor

Each indirect object adapter registered with IceGrid requires its own Adapter descriptor. If you need to specify a direct adapter, simply create a number of Ice properties in your server.

Properties

The Adapter Properties panel offers the following fields:

- **Adapter Name**
The name of the object adapter. This name must be unique within the enclosing Ice communicator, and is only used to lookup adapter properties.
- **Description**
A free-text description of this object adapter.
- **Adapter ID**
The ID of the object adapter. This ID must be unique within an IceGrid deployment. Default value: `$(server).adapter-name`.
- **Replica Group**
The ID of this adapter's [Replica Group](#). By default, an adapter does not belong to any replica group.
- **Priority**
The adapter priority in its [Replica Group](#). The default priority is 0.
- **Endpoints**
The configured endpoints for this object adapter. Corresponds to the `adapter-name.Endpoints` property. Default: default, which means listen using the default protocol (tcp by default) on an OS assigned port, on all interfaces.
- **Published Endpoints**
The configured published endpoints for this object adapter. Corresponds to the `adapter-name.PublishedEndpoints` property. Default: actual endpoints (computed at run time), derived by Ice from the Endpoints field above.
- **Proxy Options**
The default Proxy Options for well-known objects defined within this object adapter, and the Proxy Options for proxies created by this object adapter. Corresponds to the `adapter-name.ProxyEndpoints` property. Default: empty string.
- **Register Process**
This setting is ignored for servers running Ice version 3.3 or greater.
When checked, this adapter will create and register an `Ice::Process` object with IceGrid during activation. Such object is used to cleanly shutdown the server from IceGrid. Each server should register one, and only one such `Ice::Process` object.
- **Server Lifetime**
When checked, IceGrid expects this adapter to register its endpoints during server startup and unregister them during server shutdown. See also Activation Timeout in [Server Properties](#). Default: true (checked).
- **Well-known Objects**
A table of well-known objects defined by this adapter. When Property is set, IceGrid generates a property with this name and with Identity as value.
- **Allocatable Objects**
A table of allocatable objects defined by this adapter. When Property is set, IceGrid generates a property with this name and with Identity as value.

Database Environment Descriptor

You can describe the Freeze database environment(s) used by your server or service with Database Environment Descriptors. Each descriptor describes a single Freeze database environment.

Properties

The Database Environment Properties panel offers the following fields:

- **Name**
The name of the Freeze Database Environment. This name must be unique within the enclosing Ice communicator.
- **Description**
A free-text description of this database environment.
- **DB Home**
The path of the home directory of the Berkeley DB environment. The default is "Created by the IceGrid Node": when selected, IceGrid node creates automatically a directory in its local server tree. Otherwise, if you enter your own value, the path must exist: IceGrid node will not create this directory if it does not exist.
- **Properties**
This table shows a list of Berkeley DB properties for this database environment. These are *not* Ice properties. IceGrid generates a `DB_CONFIG` file in the DB Home directory with these settings.

Property Set Descriptor

A Property Set defines a set of Ice properties. IceGrid Admin supports two kinds of Property Sets:

- **Named Property Set**
A property set defined within an [application](#) or within a [node](#). Server and service definitions refer to such property sets to "include" the corresponding properties.
- **Service-Instance Property Set**
A property set defined as a child of an [IceBox server instance](#). Such a property set provides properties to a service instance within a concrete IceBox server.

Properties

The Property Set Properties panel offers the following fields:

- **ID** (Named Property Set only)
The ID of a named property set.
- **Service Name** (Service Instance property set)
The service name.
- **Property Sets**
List of Property Set IDs. The corresponding property sets are "included" in this property set.
- **Properties**
Ice properties private to this Property Set

Replica Group Descriptor

A replica group represents an abstract grouping of identical, or very similar, object adapters. An object adapter joins this group by setting this replica group ID in its Replica Group field.

Properties

The Replica Properties panel offers the following fields:

- Replica Group ID**
 The ID of this replica group. Must be unique within an IceGrid deployment.
- Description**
 A free-text description of this replica group.
- Proxy Options**
 The default Proxy Options for well-known objects defined within this replica group.
- Well-known Objects**
 A table of well-known objects defined by this replica group.
- Load Balancing Policy**
 The load-balancing policy used by IceGrid when resolving the Replica Group ID in proxies. Must be one of:

Policy	Description
Adaptive	Returns the endpoints of the object adapters whose nodes report the lowest load-average (on Linux/Unix) or CPU utilization (on Windows). The actual load-average or CPU utilization value of each node is multiplied by the node's load-factor for this comparison. See Load Sample below, and Node .
Ordered	Returns the endpoints of the object adapters with the highest priority. See Adapter .
Random	Returns the endpoints of object adapters selected at random. This is the default policy.
Round-robin	IceGrid puts all the object adapters in a list, and for each new resolution, it returns the endpoints from the next <i>How many Adapters</i> items on this list.

- How many Adapters**
 Specify the number of object adapters selected by IceGrid for each resolution. 1 is a common value. When set to 0 (the default), IceGrid returns the endpoints of all object adapters in this replica group.
- Load Sample**
 Available only with the Adaptive load-balancing policy. Specify the load-average or CPU utilization sample to use when comparing nodes: it can be 1 (default), 5 or 15 minutes.

Server Template Descriptor

A server template is used to capture the common definitions of several similar or identical servers.

On this page:

- [Properties](#)
- [Children](#)

Properties

The Server Template Properties panel offers the following fields:

- **Template ID**
The ID the template. Must be unique within the application.
- **Parameters**
The list of parameters for this template. Each parameter can have an optional default value.
- **Plain Server Properties**
The remaining fields are the [Plain Server](#) fields.

Children

A plain server template can have two types of children:

- [Adapter](#)
- [Database Environment](#)

An IceBox server template can have only one kind of children, [Service](#).

Service Template Descriptor

A service template is used to capture the common definitions of several similar or identical services.

On this page:

- [Properties](#)
- [Children](#)

Properties

The Service Template Properties panel offers the following fields:

- **Template ID**
The ID the template. Must be unique within the application.
- **Parameters**
The list of parameters for this template. Each parameter can have an optional default value.
- **Plain Service Properties**
The remaining fields are the [Plain Service](#) fields.

Children

A service template can have two types of children:

- [Adapter](#)
- [Database Environment](#)

IceGrid Server Activation

On this page:

- [Server Activation Modes](#)
- [Server Activation in Detail](#)
- [Requirements for Server Activation](#)
- [Efficiency Considerations for Server Activation](#)
- [Activating Servers with Specific User IDs](#)
- [Automating Endpoint Registration](#)

Server Activation Modes

You can choose among four activation modes for servers deployed and managed by an IceGrid node:

- **Manual**
You must start the server explicitly via the IceGrid GUI or `icegridadmin`, or programmatically via the `IceGrid::Admin` interface.
- **Always**
IceGrid activates the server when its node starts. If the server stops, IceGrid automatically reactivates it.
- **On demand**
IceGrid activates the server when a client invokes an operation on an object in the server.
- **Session**
This mode also provides on-demand activation but requires the server to be allocated by a session.

Server Activation in Detail

On-demand server activation is a valuable feature of distributed computing architectures for a number of reasons:

- It minimizes application startup times by avoiding the need to pre-start all servers.
- It allows administrators to use their computing resources more efficiently because only those servers that are actually needed are running.
- It provides more reliability in the case of some server failure scenarios, e.g., the server is reactivated after a failure and may still be capable of providing some services to clients until the failure is resolved.
- It allows remote activation and deactivation.

On-demand activation occurs when an Ice client [requests the endpoints](#) of one of the server's object adapters via a locate request. If the server is not active at the time the client issues the request, the node activates the server and waits for the target object adapter to register its endpoints. Once the object adapter endpoints are registered, the registry returns the endpoint information back to the client. This sequence ensures that the client receives the endpoint information *after* the server is ready to receive requests.

Requirements for Server Activation

In order to use on-demand activation for an object adapter, the adapter must have an identifier and be entered in the IceGrid registry.

When using session activation mode, IceGrid requires that the server be [allocated](#); on-demand activation fails for servers that have not been allocated.

The session activation mode recognizes an additional [reserved variable](#) in the server descriptor, `session.id`. The value of this variable is the user ID or, for SSL sessions, the distinguished name associated with the session.

Efficiency Considerations for Server Activation

Once a server is activated, it remains running indefinitely (unless it uses the session activation mode). A node [deactivates a server](#) only when explicitly requested to do so. As a result, server processes tend to accumulate on the node's host.

One of the advantages of on-demand activation is the ability to manage computing resources more efficiently. Of course there are many

aspects to this, but Ice makes one technique particularly simple: servers can be configured to terminate gracefully after they have been idle for a certain amount of time.

A typical scenario involves a server that is activated on demand, used for a while by one or more clients, and then terminated automatically when no requests have been made for a configurable number of seconds. All that is necessary is setting the server's configuration property `Ice.ServerIdleTime` to the desired idle time.

For a server activated in session activation mode, IceGrid deactivates the server when the session releases the server or when the session is destroyed.

Activating Servers with Specific User IDs

On Unix platforms you can activate server processes with specific effective user IDs, provided that the IceGrid node is running as root. If the IceGrid node does not run as root, servers are always activated with the effective user ID of the IceGrid node process. (The same is true for Windows — servers always run with the same user ID as the IceGrid node process.)

For the remainder of this section, we assume that the node runs as root on a Unix machine.

The `user` attribute of the `server descriptor` specifies the user ID for a server. If this attribute is not specified and the activation mode is not `session`, the default value is `nobody`. Otherwise, the default value is `${session.id}` if the activation mode is `session`.

Since individual users often have different account names and user IDs on different machines, IceGrid provides a mechanism to map the value of the `user` attribute in the server descriptor to a user account. To do this, you must configure the node to use a user account mapper object. This object must implement the `IceGrid::UserAccountMapper` interface:

```

Slice

exception UserAccountNotFoundException {};

interface UserAccountMapper {
    string getUserAccount(string user)
        throws UserAccountNotFoundException;
};
```

The IceGrid node invokes `getUserAccount` and passes the value of the server descriptor's `user` attribute. The return value is the name of the user account.

IceGrid provides a built-in file-based user account mapper that you can configure for the node and the registry. The file contains any number of user-account-ID pairs. Each pair appears on a separate line, with white space separating the user account from the identifier. For example, the file shown below contains two entries that map two distinguished names to the user account `lisa`:

```

lisa O=ZeroC\\, Inc., OU=Ice, CN=Lisa
lisa O=ZeroC\\, Inc., OU=Ice, CN=Lisa S.
```

The distinguished names must be unique. If the same distinguished name appears several times in a file, the last entry is used.

You can specify the path of the user account file with the `IceGrid.Registry.UserAccounts` property for the registry and the `IceGrid.Node.UserAccounts` property for a node.

To configure an IceGrid node to use the IceGrid registry file-based user account mapper, you need to set the `IceGrid.Node.UserAccountMapper` property to the well-known proxy `IceGrid/RegistryUserAccountMapper`. Alternatively, you can set this property to the proxy of your own user account mapper object. Note that if this property is set, the node ignores the setting of `IceGrid.Node.UserAccounts`.

Automating Endpoint Registration

Servers must be [properly configured](#) to enable automatic endpoint registration. It should be noted however that IceGrid simplifies the configuration process in two ways:

- The IceGrid [deployment facility](#) automates the creation of a [configuration file](#) for the server, including the definition of object adapter identifiers and endpoints.
- A server that is activated automatically by an IceGrid node does not need to explicitly configure a proxy for the locator because the IceGrid node defines it in the server's configuration file.

See Also

- [Getting Started with IceGrid](#)
- [IceGrid Architecture](#)
- [Resource Allocation using IceGrid Sessions](#)
- [Server Descriptor Element](#)
- [Locator Configuration for a Server](#)
- [Using IceGrid Deployment](#)
- [IceGrid Properties](#)

IceGrid Troubleshooting

On this page:

- [Troubleshooting Activation Failures](#)
- [Troubleshooting Proxy Failures](#)
- [Troubleshooting Server Failures](#)
- [Disabling Faulty Servers](#)

Troubleshooting Activation Failures

Server activation failure is usually indicated by the receipt of a `NoEndpointException`. This can happen for a number of reasons, but the most likely cause is an incorrect configuration. For example, an IceGrid node may fail to [activate a server](#) because the server's executable file, shared libraries, or classes could not be found. There are several steps you can take in this case:

1. Enable activation tracing in the node by setting the configuration property `IceGrid.Node.Trace.Activator=3`.
2. Examine the tracing output and verify the server's command line and working directory are correct.
3. Relative pathnames specified in a command line may not be correct relative to the node's current working directory. Either replace relative pathnames with absolute pathnames, or restart the node in the proper working directory.
4. Verify that the server is configured with the correct `PATH` or `LD_LIBRARY_PATH` settings for its shared libraries. For a Java server, its `CLASSPATH` may also require changes.

Another cause of activation failure is a server fault during startup. After you have confirmed that the node successfully spawns the server process using the steps above, you should then [check for signs of a server fault](#) (e.g., on Unix, look for a `core` file in the node's current working directory).

Troubleshooting Proxy Failures

A client may receive `Ice::NotRegisteredException` if [binding fails](#) for an indirect proxy. This exception indicates that the proxy's object identity or object adapter is not known by the IceGrid registry. The following steps may help you discover the cause of the exception:

1. Use `icegridadmin` to verify that the object identity or object adapter identifier is actually registered, and that it matches what is used by the proxy:

```
>>> adapter list
...
>>> object find ::Hello
...
```

2. If the problem persists, review your configuration to ensure that the locator proxy used by the client matches the registry's client endpoints, and that those endpoints are accessible to the client (i.e., are not blocked by a firewall).
3. Finally, enable locator tracing in the client by setting the configuration property `Ice.Trace.Locator=2`, then run the client again to see if any log messages are emitted that may indicate the problem.

Troubleshooting Server Failures

Diagnosing a server failure can be difficult, especially when servers are activated automatically on remote hosts. Here are a few suggestions:

1. If the server is running on a Unix host, check the current working directory of the IceGrid node process for signs of a server failure, such as a `core` file.
2. Judicious use of tracing can help to narrow the search. For example, if the failure occurs as a result of an operation invocation, enable protocol tracing in the Ice run time by setting the configuration property `Ice.Trace.Protocol=1` to discover the object identity and operation name of all requests.

Of course, the default log output channels (standard out and standard error) will probably be lost if the server is activated

automatically, so either start the server manually (see below) or [redirect the log output](#). You can also use the `Ice::Logger` interface to emit your own trace messages.

3. Run the server in a debugger; a server configured for automatic activation can also be started manually if necessary. However, since the IceGrid node did not activate the server, it cannot monitor the server process and therefore will not know when the server terminates. This will prevent subsequent activation unless you clean up the IceGrid state when you have finished debugging and terminated the server. You can do this by starting the server using `icegridadmin`:

```
>>> server start TheServer
```

This will cause the node to activate (and therefore monitor) the server process. If you do not want to leave the server running, you can stop it with the `server stop` command.

4. After the server is activated and is in a quiescent state, attach your debugger to the running server process. This avoids the issues associated with starting the server manually (as described in the previous step), but does not provide as much flexibility in customizing the server's startup environment.

Another cause for a server to fail to activate correctly is if there is a mismatch in the adapter identifiers used by the server for its adapters, and the adapter identifiers specified in the server's deployment descriptor. After starting a server process, the node waits for the server to activate all of its object adapters and report them as ready; if the server does not do this, the node reports a failure once a timeout expires. The timeout is controlled by the setting of the property `IceGrid.Node.WaitTime`. (The default value is 60 seconds.)

You can check the status of each of a server's adapters using `icegridadmin` or the GUI tool. While the node waits for an adapter to be activated by the server, it reports the status of the adapter as "activating". If you experience timeouts before each adapter's status changes to "active", the most likely cause is that the deployment descriptor for the server either mentions more object adapters than are actually created by the server, or that the server uses an identifier for one or more adapters that does not match the corresponding identifier in the deployment descriptor.

Disabling Faulty Servers

You may find it necessary to disable a server that terminates in an error condition. For example, on a Unix platform each server failure might result in the creation of a new (and potentially quite large) core file. This problem is exacerbated when the server is used frequently, in which case repeated cycles of activation and failure can consume a great deal of disk space and threaten the viability of the application as a whole.

As a defensive measure, you can configure an IceGrid node to disable these servers automatically using the `IceGrid.Node.DisableOnFailure` property. In the disabled state, a server cannot be activated on demand. The default value of the property is zero, meaning the node does not disable a server that terminates improperly. A positive value causes the node to temporarily disable a faulty server, with the value representing the number of seconds the server should remain disabled. If the property has a negative value, the server is disabled indefinitely, or until the server is explicitly enabled or started via an administrative action.

You can also manually disable a server at any time using an administrative tool. A manually disabled server remains disabled indefinitely until an administrator enables or starts it. Disabling an *active* server has no effect on the server process; the server is unaware of the change to its status and continues to service requests from connected clients as usual. However, as of Ice 3.5, disabling a server does prevent IceGrid from including the endpoints of the server's object adapters in any subsequent [locate requests](#), and it excludes those object adapters from any [replica groups](#) in which they might participate.

Typically, the ultimate goal of disabling a server is to gracefully migrate clients from the faulty server to ones that are behaving correctly. For a client that starts after the server is disabled, migration occurs immediately: the Ice run time in the client issues a locate request on the first proxy invocation, and the result returned by IceGrid excludes any endpoints from the disabled server. For a client that is active at the time the server is disabled, it does not migrate to a different server until its Ice run time issues a new locate request and obtains a new set of endpoints for the target object. The timing of this new locate request depends on several factors:

- If the client has an existing connection to the server, that connection will remain open and active as determined by the configuration settings of the client and server. For example, [active connection management](#) could eventually cause the connection to be closed automatically from either end due to inactivity. A subsequent proxy invocation may result in a new locate request.
- The client's use of [connection caching](#) also plays an important role. If the client's proxy is configured to cache connections, the client may continue to use the disabled server indefinitely. Connection caching should be disabled to ensure that migration eventually

takes place.

- The Ice run time in the client also [caches the results](#) of locate requests. Although by default these results do not expire, setting a [cache timeout](#) allows you to specify how frequently the Ice run time issues new locate requests. Consider this code:

C++

```
proxy =  
proxy->ice_connectionCached(false)->ice_locatorCacheTimeout(20);
```

By disabling connection caching and setting a locator cache timeout, we can ensure that migration occurs within twenty seconds for invocations on this proxy.

See Also

- [IceGrid Server Activation](#)
- [Locator Semantics for Clients](#)
- [icegridadmin Command Line Tool](#)

Freeze

Freeze is a collection of services that simplify the use of persistence in Ice applications, as shown below:

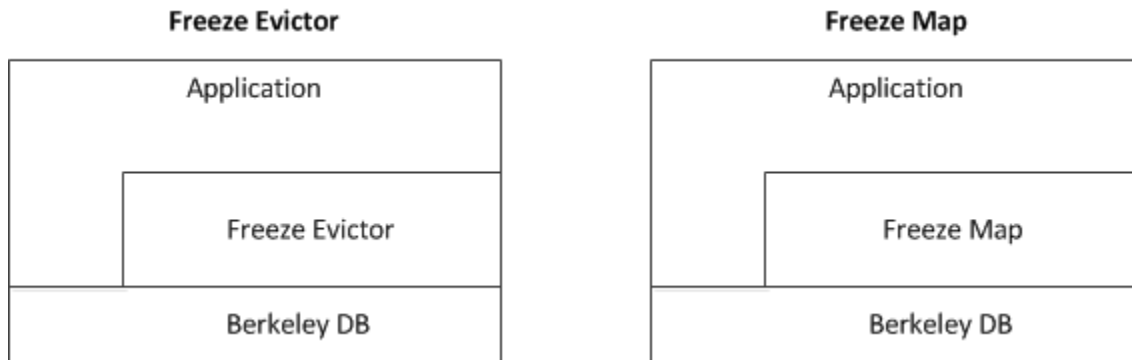

Layer diagram for Freeze persistence services.

The [Freeze map](#) is an associative container mapping any Slice key and value types, providing a convenient and familiar interface to a persistent map. [Freeze evictors](#) are an especially powerful facility for supporting persistent Ice objects in a highly-scalable implementation.

The Freeze persistence services comprise:

- [Freeze evictor](#)
A highly-scalable implementation of an Ice [servant locator](#) that provides automatic persistence and eviction of servants with only minimal application code.
- [Freeze map](#)
A generic associative container. Code generators are provided that produce type-specific maps for Slice key and value types. Applications interact with a Freeze map just like any other associative container, except the keys and values of a Freeze map are persistent.

As you will see from the examples in this discussion, integrating a Freeze map or evictor into your Ice application is quite straightforward: once you define your persistent data in Slice, Freeze manages the mundane details of persistence.

Freeze is implemented using Berkeley DB, a compact and high-performance embedded database. The Freeze map and evictor APIs insulate applications from the Berkeley DB API, but do not prevent applications from interacting directly with Berkeley DB if necessary.

Topics

- [Freeze Evictors](#)
- [Freeze Maps](#)
- [Freeze Catalogs](#)
- [Backing Up Freeze Databases](#)

Freeze Evictors

Freeze evictors combine persistence and scalability features into a single facility that is easily incorporated into Ice applications.

As an implementation of a [servant locator](#), a Freeze evictor takes advantage of the fundamental separation between Ice object and servant to activate servants on demand from persistent storage, and to deactivate them again using customized eviction constraints. Although an application may have thousands of Ice objects in its database, it is not practical to have servants for all of those Ice objects resident in memory simultaneously. The application can conserve resources and gain greater scalability by setting an upper limit on the number of active servants, and letting a Freeze evictor handle the details of servant activation, persistence, and deactivation.

Topics

- [Freeze Evictor Concepts](#)
- [Background Save Evictor](#)
- [Transactional Evictor](#)
- [Using a Freeze Evictor in the File System Server](#)

See Also

- [Servant Locators](#)

Freeze Evictor Concepts

This page introduces the Freeze evictor.

On this page:

- [Describing Persistent State for an Evictor](#)
- [Evictor Servant Semantics](#)
- [Evictor Types](#)
- [Eviction Strategy](#)
- [Detecting Updates to Persistent State](#)
- [Iterating an Evictor](#)
- [Indexing an Evictor Database](#)
- [Using a Servant Initializer](#)
- [Application Design Considerations for Evictors](#)

Describing Persistent State for an Evictor

The persistent state of servants managed by a Freeze evictor must be described in Slice. Specifically, every servant must implement a [Slice class](#), and a Freeze evictor automatically stores and retrieves all the (Slice-defined) data members of these Slice classes. Data members that are not specified in Slice are not persistent.

A Freeze evictor relies on the Ice object factory facility to load persistent servants from disk: the evictor creates a brand new servant using the registered factory and then restores the servant's data members. Therefore, for every persistent servant class you define, you need to register a corresponding object factory with the Ice communicator. (For more details on object factories, refer to the [C++ mapping](#) or the [Java mapping](#).)

Evictor Servant Semantics

With a Freeze evictor, each `<object identity, facet>` pair is associated with its own dedicated persistent object (servant). Such a persistent object cannot serve several identities or facets. Each servant is loaded and saved independently of other servants; in particular, there is no special grouping for the servants that serve the facets of a given Ice object.

Similar to the way you [activate servants with an object adapter](#), the Freeze evictor provides operations named `add`, `addFacet`, `remove`, and `removeFacet`. They have the same signature and semantics, except that with the Freeze evictor, the mapping and the state of the mapped servants is stored in a database.

Evictor Types

Freeze provides two types of evictors with different storage characteristics. The [background save evictor](#) records state changes to the database in a background thread, while the [transactional evictor](#) records all state changes immediately within the context of a transaction. You can choose the evictor that best fits the persistence requirements of your application.

Eviction Strategy

Both types of evictors associate a queue with their servant map and manage this queue using a "least recently used" eviction algorithm: if the queue is full, the least recently used servant is evicted to make room for a new servant.

Here is the sequence of events for activating a servant as shown in the figure below. Let us assume that we have configured the evictor with a size of five, that the queue is full, and that a request has arrived for a servant that is not currently active. (With a transactional evictor, we also assume this request does not change any persistent state.)

1. A client invokes an operation.
2. The object adapter invokes on the evictor to locate the servant.
3. The evictor first checks its servant map and fails to find the servant, so it instantiates the servant and restores its persistent state from the database.
4. The evictor adds an item for the servant (servant 1) at the head of the queue.
5. The queue's length now exceeds the configured maximum, so the evictor removes servant 6 from the queue as soon as it is eligible for eviction. With a background save evictor, this occurs once there are no outstanding requests pending on servant 6, and once the servant's state has been safely stored in the database. With a transactional save, the servant is removed from the queue

immediately.

6. The object adapter dispatches the request to the new servant.

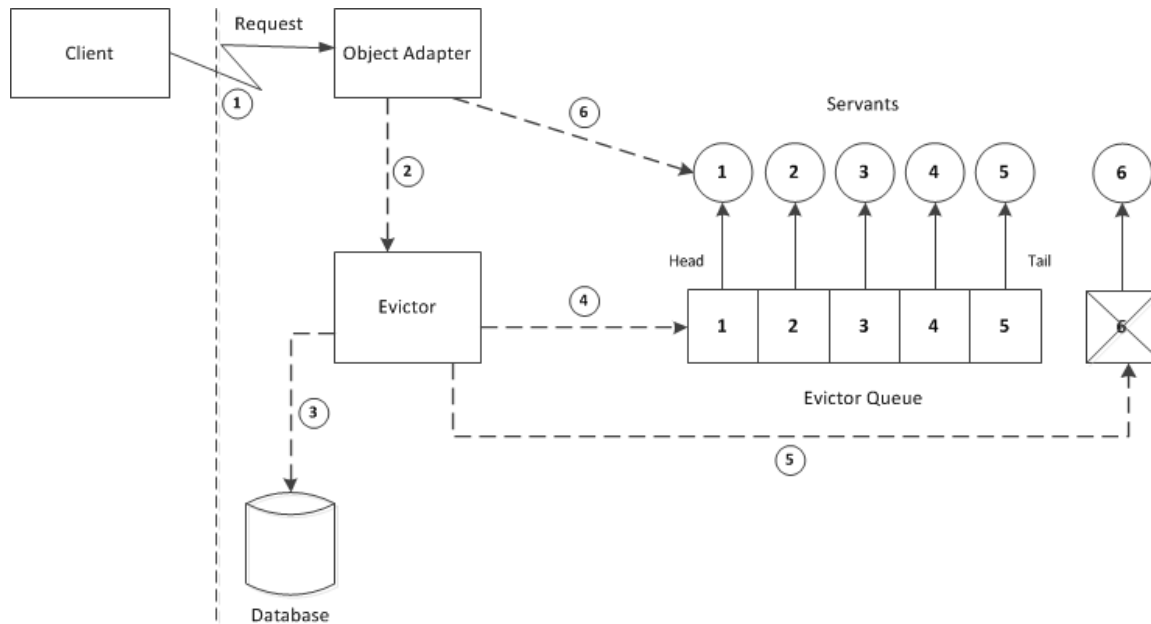

An evictor queue after restoring servant 1 and evicting servant 6.

Detecting Updates to Persistent State

A Freeze evictor considers that a servant's persistent state has been modified when a read-write operation on this servant completes. To indicate whether an operation is read-only or read-write, you add metadata directives to the Slice definitions of the objects:

- The ["freeze:write"] directive informs the evictor that an operation modifies the persistent state of the target servant.
- The ["freeze:read"] directive informs the evictor that an operation does not modify the persistent state of the target.

If no metadata directive is present, an operation is assumed to not modify its target.

Here is how you could mark the operations on an interface with these metadata directives:

```

Slice
interface Example {
    ["freeze:read"] string readonlyOp();
    ["freeze:write"] void writeOp();
};

```

This marks `readonlyOp` as an operation that does not modify its target, and marks `writeOp` as an operation that does modify its target. Because, without any directive, an operation is assumed to not modify its target, the preceding definition can also be written as follows:

```

Slice
interface Example {
    string readonlyOp(); // ["freeze:read"] implied
    ["freeze:write"] void writeOp();
};

```

The metadata directives can also be applied to an interface or a class to establish a default. This allows you to mark an interface as `["freeze:write"]` and to only add a `["freeze:read"]` directive to those operations that are read-only, for example:

```

Slice
["freeze:write"]
interface Example {
    ["freeze:read"] string readonlyOp();
    void writeOp1();
    void writeOp2();
    void writeOp3();
};

```

This marks `writeOp1`, `writeOp2`, and `writeOp3` as read-write operations, and `readonlyOp` as a read-only operation.

Note that it is important to correctly mark read-write operations with a `["freeze:write"]` metadata directive — without the directive, Freeze will not know when an object has been modified and may not store the updated persistent state to disk.

Also note that, if you make calls directly on servants (so the calls are not dispatched via the Freeze evictor), the evictor will have no idea when a servant's persistent state is modified; if any such direct call modifies the servant's data members, the update may be lost.

Iterating an Evictor

A Freeze evictor iterator provides the ability to iterate over the identities of the objects stored in an evictor. The operations are similar to Java iterator methods: `hasNext` returns true while there are more elements, and `next` returns the next identity:

```

Slice
local interface EvictorIterator {
    bool hasNext();
    Ice::Identity next();
};

```

You create an iterator by calling `getIterator` on your evictor:

```

Slice
EvictorIterator getIterator(string facet, int batchSize);

```

The new iterator is specific to a facet (specified by the `facet` parameter). Internally, this iterator will retrieve identities in batches of `batchSize` objects; we recommend using a fairly large batch size to get good performance.

Indexing an Evictor Database

A Freeze evictor supports the use of indexes to quickly find persistent servants using the value of a data member as the search criteria. The types allowed for these indexes are the same as those allowed for [Slice dictionary keys](#).

The `slice2freeze` and `slice2freezej` tools can generate an `Index` class when passed the `--index` option:

```
--index CLASS,TYPE,MEMBER[,case-sensitive|case-insensitive]
```

`CLASS` is the name of the class to be generated. `TYPE` denotes the type of class to be indexed (objects of different classes are not included

in this index). *MEMBER* is the name of the data member in *TYPE* to index. When *MEMBER* has type *string*, it is possible to specify whether the index is case-sensitive or not. The default is case-sensitive.

The generated `Index` class supplies three methods whose definitions are mapped from the following Slice operations:

- `sequence<Ice::Identity> findFirst(member-type index, int firstN)`
Returns up to *firstN* objects of *TYPE* whose *MEMBER* is equal to *index*. This is useful to avoid running out of memory if the potential number of objects matching the criteria can be very large.
- `sequence<Ice::Identity> find(member-type index)`
Returns all the objects of *TYPE* whose *MEMBER* is equal to *index*.
- `int count(member-type index)`
Returns the number of objects of *TYPE* having *MEMBER* equal to *index*.

Indexes are associated with a Freeze evictor during evictor creation. See the definition of the `createBackgroundSaveEvictor` and `createTransactionalEvictor` functions for details.

Indexed searches are easy to use and very efficient. However, be aware that an index adds significant write overhead: with Berkeley DB, every update triggers a read from the database to get the old index entry and, if necessary, replace it.

If you add an index to an existing database, by default existing facets are not indexed. If you need to populate a new or empty index using the facets stored in your Freeze evictor, set the property `Freeze.Evictor.env-name.filename.PopulateEmptyIndices` to a non-zero value, which instructs Freeze to iterate over the corresponding facets and create the missing index entries during the call to `createBackgroundSaveEvictor` or `createTransactionalEvictor`. When you use this feature, you must register the object factories for all of the facet types before you create your evictor.

Using a Servant Initializer

In some applications, it may be necessary to initialize a servant after the servant is instantiated by the evictor but before an operation is dispatched to the servant. The Freeze evictor allows an application to specify a servant initializer for this purpose.

To illustrate the sequence of events, let us assume that a request has arrived for a servant that is not currently active:

1. The evictor restores a servant for the target Ice object (and facet) from the database. This involves two steps:
 - The Ice run time locates and invokes the factory for the Ice facet's type, thereby obtaining a new instance with uninitialized data members.
 - The data members are populated from the persistent state.
2. The evictor invokes the application's servant initializer (if any) for the servant.
3. If the evictor is a background-save evictor, it adds the servant to its cache.
4. The evictor dispatches the operation.

With a background-save evictor, the servant initializer is called before the object is inserted into the evictor's internal cache, and *without* holding any internal lock, but in such a way that when the servant initializer is called, the servant is guaranteed to be inserted in the evictor cache.

There is only one restriction on what a servant initializer can do: it must not make a remote invocation on the object (facet) being initialized. Failing to follow this rule will result in deadlocks.

The [file system example](#) demonstrates the use of a servant initializer.

Application Design Considerations for Evictors

The Freeze evictor creates a snapshot of a servant's state for persistent storage by marshaling the servant, just as if the servant were being sent "over the wire" as a parameter to a remote invocation. Therefore, the Slice definitions for an object type must include the data members comprising the object's persistent state.

For example, we could define a Slice class as follows:

Slice

```
class Stateless {
    void calc();
};
```

However, without data members, there will not be any persistent state in the database for objects of this type, and hence there is little value in using the Freeze evictor for this type.

Obviously, Slice object types need to define data members, but there are other design considerations as well. For example, suppose we define a simple application as follows:

Slice

```
class Account {
    ["freeze:write"] void withdraw(int amount);
    ["freeze:write"] void deposit(int amount);

    int balance;
};

interface Bank {
    Account* createAccount();
};
```

In this application, we would use a Freeze evictor to manage `Account` objects that have a data member `balance` representing the persistent state of an account.

From an object-oriented design perspective, there is a glaring problem with these Slice definitions: implementation details (the persistent state) are exposed in the client-server contract. The client cannot directly manipulate the `balance` member because the `Bank` interface returns `Account` proxies, not `Account` instances. However, the presence of the data member may cause unnecessary confusion for client developers.

A better alternative is to clearly separate the persistent state as shown below:

Slice

```
interface Account {
    ["freeze:write"] void withdraw(int amount);
    ["freeze:write"] void deposit(int amount);
};

interface Bank {
    Account* createAccount();
};

class PersistentAccount implements Account {
    int balance;
};
```

Now the Freeze evictor can manage `PersistentAccount` objects, while clients interact with `Account` proxies. (Ideally, `PersistentAccount` would be defined in a different source file and inside a separate Slice module.)

See Also

- [Classes](#)
- [C++ Mapping for Classes](#)
- [Java Mapping for Classes](#)
- [Servant Activation and Deactivation](#)
- [Background Save Evictor](#)
- [Transactional Evictor](#)
- [Dictionaries](#)
- [Using a Freeze Evictor in the File System Server](#)

Background Save Evictor

Freeze provides two types of evictors. This page describes the background save evictor.



Freeze also provides a [transactional evictor](#), with different persistence semantics. The on-disk format of these two types of evictors is the same: you can switch from one type of evictor to the other without any data transformation.

On this page:

- [Overview of the Background Save Evictor](#)
- [Creating a Background Save Evictor](#)
- [The Background Saving Thread](#)
- [Synchronization Semantics for the Background Save Evictor](#)
- [Preventing Servant Eviction](#)
- [Handling Fatal Evictor Errors](#)

Overview of the Background Save Evictor

A background save evictor keeps all its servants in a map and writes the state of newly-created, modified, and deleted servants to disk asynchronously, in a background thread. You can configure how often servants are saved; for example you could decide to save every three minutes, or whenever ten or more servants have been modified. For applications with frequent updates, this allows you to group many updates together to improve performance.

The downside of the background save evictor is recovery from a crash. Because saves are asynchronous, there is no way to force an immediate save to preserve a critical update. Moreover, you cannot group several related updates together: for example, if you transfer funds between two accounts (servants) and a crash occurs shortly after this update, it is possible that, once your application comes back up, you will see the update on one account but not on the other. Your application needs to handle such inconsistencies when restarting after a crash.

Similarly, a background save evictor provides no ordering guarantees for saves. If you update servant 1, servant 2, and then servant 1 again, it is possible that, after recovering from a crash, you will see the latest state for servant 1, but no updates at all for servant 2.

The background save evictor implements the local interface `Freeze::BackgroundSaveEvictor`, which derives from `Freeze::Evictor`.

Creating a Background Save Evictor

You create a background save evictor in C++ with the global function `Freeze::createBackgroundSaveEvictor`, and in Java with the static method `Freeze.Util.createBackgroundSaveEvictor`.

For C++, the signatures are as follows:

C++

```

BackgroundSaveEvictorPtr
createBackgroundSaveEvictor(
    const ObjectAdapterPtr& adapter,
    const string& envName,
    const string& filename,
    const ServantInitializerPtr& initializer = 0,
    const vector<IndexPtr>& indexes = vector<IndexPtr>(),
    bool createDb = true);

BackgroundSaveEvictorPtr
createBackgroundSaveEvictor(
    const ObjectAdapterPtr& adapter,
    const string& envName,
    DbEnv& dbEnv,
    const string& filename,
    const ServantInitializerPtr& initializer = 0,
    const vector<IndexPtr>& indexes = vector<IndexPtr>(),
    bool createDb = true);

```

For Java, the method signatures are:

Java

```

public static BackgroundSaveEvictor
createBackgroundSaveEvictor(
    Ice.ObjectAdapter adapter,
    String envName,
    String filename,
    ServantInitializer initializer,
    Index[] indexes,
    boolean createDb);

public static BackgroundSaveEvictor
createBackgroundSaveEvictor(
    Ice.ObjectAdapter adapter,
    String envName,
    com.sleepycat.db.Environment dbEnv,
    String filename,
    ServantInitializer initializer,
    Index[] indexes,
    boolean createDb);

```

Both C++ and Java provide two overloaded functions: in one case, Freeze opens and manages the underlying Berkeley DB environment; in the other case, you provide a `DbEnv` object that represents a Berkeley DB environment you opened yourself. (Usually, it is easiest to let Freeze take care of all interactions with Berkeley DB.)

The `envName` parameter represents the name of the underlying Berkeley DB environment, and is also used as the default Berkeley DB

home directory. (See `Freeze.DbEnv.env-name.DbHome`.)

The `filename` parameter represents the name of the Berkeley DB database file associated with this evictor. The persistent state of all your servants is stored in this file.

The `initializer` parameter represents the [servant initializer](#). It is an optional parameter in C++; in Java, pass `null` if you do not need a servant initializer.

The `indexes` parameter is a vector or array of [evictor indexes](#). It is an optional parameter in C++; in Java, pass `null` if your evictor does not define an index.

Finally, the `createDb` parameter tells Freeze what to do when the corresponding Berkeley DB database does not exist. When true, Freeze creates a new database; when false, Freeze raises a `Freeze::DatabaseException`.

The Background Saving Thread

All persistence activity of a background save evictor is handled in a background thread created by the evictor. This thread wakes up periodically and saves the state of all newly-registered, modified, and destroyed servants in the evictor's queue.

For applications that experience bursts of activity that result in a large number of modified servants in a short period of time, you can also configure the evictor's thread to begin saving as soon as the number of modified servants reaches a certain threshold.

Synchronization Semantics for the Background Save Evictor

When the saving thread takes a snapshot of a servant it is about to save, it is necessary to prevent the application from modifying the servant's persistent data members at the same time.

The Freeze evictor and the application need to use a common synchronization to ensure correct behavior. In Java, this common synchronization is the servant itself: the Freeze evictor synchronizes the servant (a Java object) while taking the snapshot. In C++, the servant is required to inherit from the class `IceUtil::AbstractMutex`: the background save evictor locks the servant through this interface while taking a snapshot. On the application side, the servant's implementation is required to use the same mechanism to synchronize all operations that access the servant's Slice-defined data members.

Preventing Servant Eviction

Occasionally, automatically evicting and reloading all servants can be inefficient. You can remove a servant from the evictor's queue by locking this servant "in memory" using the `keep` or `keepFacet` operation on the evictor:

Slice
<pre> local interface BackgroundSaveEvictor extends Evictor { void keep(Ice::Identity id); void keepFacet(Ice::Identity id, string facet); void release(Ice::Identity id); void releaseFacet(Ice::Identity id, string facet); }; </pre>

`keep` and `keepFacet` are recursive: you need to call `release` or `releaseFacet` for this servant the same number of times to put it back in the evictor queue and make it eligible again for eviction.

Servants kept in memory (using `keep` or `keepFacet`) do not consume a slot in the evictor queue. As a result, the maximum number of servants in memory is approximately the number of kept servants plus the evictor size. (It can be larger while you have many evictable objects that are modified but not yet saved.)

Handling Fatal Evictor Errors

Freeze allows you to register a callback for handling fatal errors encountered by a background save evictor. If no callback is registered, the evictor aborts the application by default.

 The application should assume that an evictor will not continue to work properly after encountering a fatal error.

Use `Freeze.Util.registerFatalErrorCallback (Java)` or `Freeze::registerFatalErrorCallback (C++)` to register the callback.

For C++, `registerFatalErrorCallback` accepts a function pointer of type `FatalErrorCallback`:

C++

```
typedef void (*FatalErrorCallback)(const BackgroundSaveEvictorPtr&,
const Ice::CommunicatorPtr&);
```

In Java, `registerFatalErrorCallback` accepts a reference to an object that implements `Freeze.FatalErrorCallback`:

Java

```
package Freeze;

public interface FatalErrorCallback
{
    void handleError(Evictor evictor, Ice.Communicator communicator,
RuntimeException ex);
}
```

Note that the `RuntimeException` argument may be null.

See Also

- [Transactional Evictor](#)
- [Freeze Evictor Concepts](#)

Transactional Evictor

Freeze provides two types of evictors. This page describes the transactional evictor.



Freeze also provides a [background save evictor](#), with different persistence semantics. The on-disk format of these two types of evictors is the same: you can switch from one type of evictor to the other without any data transformation.

On this page:

- [Overview of the Transactional Evictor](#)
- [Creating a Transactional Evictor](#)
- [Read and Write Operations](#)
- [Synchronization Semantics for the Transactional Evictor](#)
- [Transaction Propagation](#)
- [Commit or Rollback on User Exception](#)
- [Database Deadlocks and Automatic Retries](#)
- [AMD and the Transactional Evictor](#)
- [Transactions and Freeze Maps](#)

Overview of the Transactional Evictor

A transactional evictor maintains a servant map, but only keeps read-only servants in this map. The state of these servants corresponds to the latest data on disk. Any servant creation, update, or deletion is performed within a database transaction. This transaction is committed (or rolled back) immediately, typically at the end of the dispatch of the current operation, and the associated servants are then discarded.

With such an evictor, you can ensure that several updates, often on different servants (possibly managed by different transactional evictors) are grouped together: either all or none of these updates occur. In addition, updates are written almost immediately, so crash recovery is a lot simpler: few (if any) updates will be lost, and you can maintain consistency between related persistent objects.

However, an application based on a transactional evictor is likely to write a lot more to disk than an application with a background save evictor, which may have an adverse impact on performance.

Creating a Transactional Evictor

You create a transactional evictor in C++ with the global function `Freeze::createTransactionalEvictor`, and in Java with the static method `Freeze.Util.createTransactionalEvictor`.

For C++, the signatures are as follows:

C++

```

typedef map<string, string> FacetTypeMap;

TransactionalEvictorPtr
createTransactionalEvictor(
    const ObjectAdapterPtr& adapter,
    const string& envName,
    const string& filename,
    const FacetTypeMap& facetTypes = FacetTypeMap(),
    const ServantInitializerPtr& initializer = 0,
    const vector<IndexPtr>& indexes = vector<IndexPtr>(),
    bool createDb = true);

TransactionalEvictorPtr
createTransactionalEvictor(
    const ObjectAdapterPtr& adapter,
    const string& envName,
    DbEnv& dbEnv,
    const string& filename,
    const FacetTypeMap& facetTypes = FacetTypeMap(),
    const ServantInitializerPtr& initializer = 0,
    const vector<IndexPtr>& indexes = vector<IndexPtr>(),
    bool createDb = true);

```

For Java, the method signatures are:

Java

```

public static TransactionalEvictor
createTransactionalEvictor(
    Ice.ObjectAdapter adapter,
    String envName,
    String filename,
    java.util.Map facetTypes,
    ServantInitializer initializer,
    Index[] indexes,
    boolean createDb);

public static TransactionalEvictor
createTransactionalEvictor(
    Ice.ObjectAdapter adapter,
    String envName,
    com.sleepycat.db.Environment dbEnv,
    String filename,
    java.util.Map facetTypes,
    ServantInitializer initializer,
    Index[] indexes,
    boolean createDb);

```

Both C++ and Java provide two overloaded functions: in one case, Freeze opens and manages the underlying Berkeley DB environment; in the other case, you provide a `DbEnv` object that represents a Berkeley DB environment you opened yourself. (Usually, it is easier to let Freeze take care of all interactions with Berkeley DB.)

The `envName` parameter represents the name of the underlying Berkeley DB environment, and is also used as the default Berkeley DB home directory. (See `Freeze.DbEnv.env-name.DbHome`.)

The `filename` parameter represents the name of the Berkeley DB database file associated with this evictor. The persistent state of all your servants is stored in this file.

The `facetTypes` parameter allows you to specify a single class type (Slice `type ID` string) for each facet in your new evictor (see below). Most applications use only the default facet, represented by an empty string. This parameter is optional in C++; in Java, pass `null` if you do not want to specify such a facet-to-type mapping.

The `initializer` parameter represents the `servant initializer`. It is an optional parameter in C++; in Java, pass `null` if you do not need a servant initializer.

The `indexes` parameter is a vector or array of `evictor indexes`. It is an optional parameter in C++; in Java, pass `null` if your evictor does not define an index.

Finally, the `createDb` parameter tells Freeze what to do when the corresponding Berkeley DB database does not exist. When true, Freeze creates a new database; when false, Freeze raises a `Freeze::DatabaseException`.

Read and Write Operations

When a transactional evictor processes an incoming request without an associated transaction, it first needs to find out whether the corresponding operation is `read-only` or `read-write` (as specified by the `"freeze:read"` and `"freeze:write"` operation metadata). This is straightforward if the evictor knows the target's type; in this case, it simply instantiates and keeps a "dummy" servant to look up the attributes of each operation.

However, if the target type can vary, the evictor needs to look up and sometimes load a read-only servant to find this information. For

read-write requests, it will then load the servant from disk a second time (within a new transaction). Once the transaction commits, the read-only servant — sometimes freshly loaded from disk — is discarded.

When you create a transactional evictor with `createTransactionalEvictor`, you can pass a facet name to type ID map to associate a single servant type with each facet and speed up the retrieval of these operation attributes.

Synchronization Semantics for the Transactional Evictor

With a transactional evictor, there is no need to perform any synchronization on the servants managed by the evictor:

- For read-only operations, the application must not modify any data member, and hence there is no need to synchronize. (Many threads can safely read the same data members concurrently.)
- For read-write operations, each operation dispatch gets its own private servant or servants (see transaction propagation below).

Not having to worry about synchronization can dramatically simplify your application code.

Transaction Propagation

Without a distributed transaction service, it is not possible to invoke several remote operations within the same transaction. Nevertheless, Freeze supports transaction propagation for collocated calls: when a request is dispatched within a transaction, the transaction is associated with the dispatch thread and will propagate to any other servant reached through a collocated call. If the target of a collocated call is managed by a transactional evictor associated with the same database environment, Freeze reuses the propagated transaction to load the servant and dispatch the request. This allows you to group updates to several servants within a single transaction.

You can also control how a transactional evictor handles an incoming transaction through optional metadata added after `"freeze:write"` and `"freeze:read"`. There are six valid directives:

- `freeze:read:never`
Verify that no transaction is propagated to this operation. If a transaction is present, the transactional evictor raises a `Freeze::DatabaseException`.
- `freeze:read:supports`
Accept requests with or without a transaction, and re-use the transaction if present. `"supports"` is the default for `"freeze:read"` operations.
- `freeze:read:mandatory` and `freeze:write:mandatory`
Verify that a transaction is propagated to this operation. If there is no transaction, the transactional evictor raises a `Freeze::DatabaseException`.
- `freeze:read:required` and `freeze:write:required`
Accept requests with or without a transaction, and re-use the transaction if present. If no transaction is propagated, the transactional evictor creates a new transaction before dispatching the request. `"required"` is the default for `"freeze:write"` operations.

Commit or Rollback on User Exception

When a transactional evictor processes an incoming read-write request, it starts a new database transaction, loads a servant within the transaction, dispatches the request, and then either commits or rolls back the transaction depending on the outcome of this dispatch. If the dispatch does not raise an exception, the transaction is committed just before the response is sent back to the client. If the dispatch raises a system exception, the transaction is rolled back. If the dispatch raises a user exception, by default, the transaction is committed. However, you can configure Freeze to rollback on user-exceptions by setting `Freeze.Evictor.env-name.fileName.RollbackOnUserException` to a non-zero value.

Database Deadlocks and Automatic Retries

When reading and writing in separate concurrent transactions, deadlocks are likely to occur. For example, one transaction may lock pages in a particular order while another transaction locks the same pages in a different order; the outcome is a deadlock. Berkeley DB automatically detects such deadlocks, and "kills" one of the transactions.

With a Freeze transactional evictor, the application does not need to catch any deadlock exceptions or retry when deadlock occurs because the transactional evictor automatically retries its transactions whenever it encounters a deadlock situation.

However, this can affect how you implement your operations: for any operation called within a transaction (mainly read-write operations), you must anticipate the possibility of several calls for the same request, all in the same dispatch thread.

AMD and the Transactional Evictor

When a transactional evictor dispatches a read-write operation implemented using AMD, it starts a transaction before dispatching the request, and commits or rolls back the transaction when the dispatch is done. Two threads are involved here: the *dispatch thread* and the *callback thread*. The dispatch thread is a thread from an Ice thread pool tasked with dispatching a request, and the callback thread is the thread that invokes the AMD callback to send the response to the client. These threads may be one and the same if the servant invokes the AMD callback from the dispatch thread.

It is important to understand the threading semantics of an AMD request with respect to the transaction:

- If a successful AMD response is sent from the dispatch thread, the transaction is committed *after* the response is sent. If a deadlock occurs during this commit, the request is not retried and the client receives no indication of the failure.
- If a successful AMD response is sent from another thread, the evictor commits its transaction when the dispatch thread completes, regardless of whether the servant has sent the AMD response. The callback thread waits until the transaction has been committed by the dispatch thread before sending the response.
- If a commit results in a deadlock and the AMD response has not yet been sent, the evictor cancels the original AMD callback and automatically retries the request again with a new AMD callback. Invocations on the original AMD callback are ignored (`ice_response` and `ice_exception` on this callback do nothing).
- Otherwise, if the servant sends an exception via the AMD callback, the response is sent directly to the client.

Transactions and Freeze Maps

A transactional evictor uses the same transaction objects as [Freeze maps](#), which allows you to update a Freeze map within a transaction managed by a transactional evictor.

You can get the current transaction created by a transactional evictor by calling `getCurrentTransaction`. Then, you would typically retrieve the associated Freeze connection (with `getConnection`) and construct a Freeze map using this connection:

```

Slice
local interface TransactionalEvictor extends Evictor {
    Transaction getCurrentTransaction();
    void setCurrentTransaction(Transaction tx);
};

```

A transactional evictor also gives you the ability to associate your own transaction with the current thread, using `setCurrentTransaction`. This is useful if you want to perform many updates within a single transaction, for example to add or remove many servants in the evictor. (A less convenient alternative is to implement all such updates within a read-write operation on some object.)

See Also

- [Background Save Evictor](#)
- [Type IDs](#)
- [Freeze Evictor Concepts](#)
- [Freeze Maps](#)

Using a Freeze Evictor in the File System Server

In this section, we present file system implementations that use a transactional evictor. The implementations are based on the ones discussed in [Object Life Cycle](#), and in this section we only discuss code that illustrates use of the Freeze evictor.

In general, incorporating a Freeze evictor into your application requires the following steps:

1. Evaluate your existing Slice definitions for a suitable persistent object type.
2. If no suitable type is found, you typically define a new derived class that captures your persistent state requirements. Consider placing these definitions in a separate file: they are only used by the server for persistence, and therefore do not need to appear in the "public" definitions required by clients. Also consider placing your persistent types in a separate module to avoid name clashes.
3. If you use [indexes with your evictor](#), generate code (using `slice2freeze` or `slice2freezej`) for your new definitions.
4. Create an evictor and register it as a servant locator with an object adapter.
5. Create instances of your persistent type and register them with the evictor.

Persistent Types for File System Evictor

Fortunately, it is unnecessary for us to change any of the existing file system Slice definitions to incorporate the Freeze evictor. However, we do need to add metadata definitions to inform the evictor which [operations modify object state](#):

Slice

```

module Filesystem {
    // ...

    interface Node {
        idempotent string name();

        ["freeze:write"]
        void destroy() throws PermissionDenied;
    };

    // ...

    interface File extends Node {
        idempotent Lines read();

        ["freeze:write"]
        idempotent void write(Lines text) throws GenericError;
    };

    // ...

    interface Directory extends Node {
        idempotent NodeDescSeq list();

        idempotent NodeDesc find(string name) throws NoSuchName;

        ["freeze:write"]
        File* createFile(string name) throws NameInUse;

        ["freeze:write"]
        Directory* createDirectory(string name) throws NameInUse;
    };
};

```

These definitions are identical to the original ones, with the exception of the added ["freeze:write"] directives.

The remaining definitions are in derived classes:

Slice

```
#include <Filesystem.ice>

module Filesystem {
    class PersistentDirectory;

    class PersistentNode implements Node {
        string nodeName;
        PersistentDirectory* parent;
    };

    class PersistentFile extends PersistentNode implements File {
        Lines text;
    };

    dictionary<string, NodeDesc> NodeDict;

    class PersistentDirectory extends PersistentNode implements
    Directory {
        ["freeze:write"]
        void removeNode(string name);

        NodeDict nodes;
    };
};
```

As you can see, we have sub-classed all of the file system interfaces. Let us examine each one in turn.

The `PersistentNode` class adds two data members: `nodeName` and `parent`.



We used `nodeName` instead of `name` because `name` is already used as an operation in the `Node` interface.

The file system implementation requires that a child node knows its parent node in order to properly implement the `destroy` operation. Previous implementations had a state member of type `DirectoryI`, but that is not workable here. It is no longer possible to pass the parent node to the child node's constructor because the evictor may be instantiating the child node (via a factory), and the parent node will not be known. Even if it were known, another factor to consider is that there is no guarantee that the parent node will be active when the child invokes on it, because the evictor may have evicted it. We solve these issues by storing a proxy to the parent node. If the child node invokes on the parent node via the proxy, the evictor automatically activates the parent node if necessary.

The `PersistentFile` class is very straightforward, simply adding a `text` member representing the contents of the file. Notice that the class extends `PersistentNode`, and therefore inherits the state members declared by the base class.

Finally, the `PersistentDirectory` class defines the `removeNode` operation, and adds the `nodes` state member representing the immediate children of the directory node. Since a child node contains only a proxy for its `PersistentDirectory` parent, and not a reference to an implementation class, there must be a Slice-defined operation that can be invoked when the child is destroyed.

If we had followed our earlier advice, we would have defined `Node`, `File`, and `Directory` classes in a separate `PersistentFilesystem` module, but in this example we use the existing `Filesystem` module for the sake of simplicity.

Topics

- [Adding an Evictor to the C++ File System Server](#)
- [Adding an Evictor to the Java File System Server](#)

See Also

- [Object Life Cycle](#)
- [Freeze Evictors](#)
- [Freeze Evictor Concepts](#)

Adding an Evictor to the C++ File System Server

On this page:

- [The Server main Program in C++](#)
- [The Persistent Servant Class Definitions in C++](#)
- [Implementing a Persistent FileI in C++](#)
- [Implementing a Persistent DirectoryI in C++](#)
- [Implementing NodeFactory in C++](#)

The Server main Program in C++

The server's `main` program is responsible for creating the evictor and initializing the root directory node. Many of the administrative duties, such as creating and destroying a communicator, are handled by the `Ice::Application` class. Our server `main` program has now become the following:

```

C++
#include <PersistentFilesystemI.h>

using namespace std;
using namespace Filesystem;

class FilesystemApp : virtual public Ice::Application
{
public:

    FilesystemApp(const string& envName) :
        _envName(envName)
    {
    }

    virtual int run(int, char*[])
    {
        Ice::ObjectFactoryPtr factory = new NodeFactory;
        communicator()->addObjectFactory(factory,
PersistentFile::ice_staticId());
        communicator()->addObjectFactory(factory,
PersistentDirectory::ice_staticId());

        Ice::ObjectAdapterPtr adapter =
communicator()->createObjectAdapter("EvictorFilesystem");

        Freeze::EvictorPtr evictor =
            Freeze::createTransactionalEvictor(adapter, _envName,
"evictorfs");
        FileI::_evictor = evictor;
        DirectoryI::_evictor = evictor;

        adapter->addServantLocator(evictor, "");

        Ice::Identity rootId;
        rootId.name = "RootDir";
    }
};

```

```
    if(!evictor->hasObject(rootId))
    {
        PersistentDirectoryPtr root = new DirectoryI;
        root->nodeName = "/";
        evictor->add(root, rootId);
    }

    adapter->activate();

    communicator()->waitForShutdown();
    if(interrupted())
    {
        cerr << appName() << ": received signal, shutting down" <<
endl;
    }

    return 0;
}

private:

    string _envName;
};

int
main(int argc, char* argv[])
{
    FilesystemApp app("db");
```

```

    return app.main(argc, argv, "config.server");
}

```

Let us examine the changes in detail. First, we are now including `PersistentFileSystemI.h`. This header file includes all of the other Freeze (and Ice) header files this source file requires.

Next, we define the class `FileSystemApp` as a subclass of `Ice::Application`, and provide a constructor taking a string argument:

```

C++
FileSystemApp(const string& envName) :
    _envName(envName) { }

```

The string argument represents the name of the database environment, and is saved for later use in `run`.

One of the first tasks `run` performs is installing the Ice [object factories](#) for `PersistentFile` and `PersistentDirectory`. Although these classes are not exchanged via Slice operations, they are marshalled and unmarshalled in exactly the same way when saved to and loaded from the database, therefore factories are required. A single instance of `NodeFactory` is installed for both types:

```

C++
Ice::ObjectFactoryPtr factory = new NodeFactory;
    communicator()->addObjectFactory(factory,
PersistentFile::ice_staticId());
    communicator()->addObjectFactory(factory,
PersistentDirectory::ice_staticId());

```

After creating the object adapter, the program initializes a [transactional evictor](#) by invoking `createTransactionalEvictor`. The third argument to `createTransactionalEvictor` is the name of the database file, which by default is created if it does not exist. The new evictor is then added to the object adapter as a servant locator for the default category:

```

C++
NodeI::_evictor = Freeze::createTransactionalEvictor(adapter, _envName,
"evictorfs");
    adapter->addServantLocator(NodeI::_evictor, "");

```

Next, the program creates the root directory node if it is not already being managed by the evictor:

C++

```
Ice::Identity rootId;
    rootId.name = "RootDir";
    if(!evictor->hasObject(rootId))
    {
        PersistentDirectoryPtr root = new DirectoryI;
        root->nodeName = "/";
        evictor->add(root, rootId);
    }
```

Finally, the `main` function instantiates the `FilesystemApp`, passing `db` as the name of the database environment:

C++

```
int
main(int argc, char* argv[])
{
    FilesystemApp app("db");
    return app.main(argc, argv, "config.server");
}
```

The Persistent Servant Class Definitions in C++

The servant classes must also be changed to incorporate the Freeze evictor. We no longer derive the servants from a common base class. Instead, `FileI` and `DirectoryI` each have their own `_destroyed` and `_mutex` members, as well as a static `_evictor` smart pointer that points at the transactional evictor:

C++

```

#include <PersistentFilesystem.h>
#include <IceUtil/IceUtil.h>
#include <Freeze/Freeze.h>

namespace Filesystem {

class FileI : virtual public PersistentFile {
public:

    FileI();

    // Slice operations...

    static Freeze::EvictorPtr _evictor;

private:

    bool _destroyed;
    IceUtil::Mutex _mutex;
};

class DirectoryI : virtual public PersistentDirectory {
public:

    DirectoryI();

    // Slice operations...

    virtual void removeNode(const std::string&, const Ice::Current&);

    static Freeze::EvictorPtr _evictor;

public:
    bool _destroyed;
    IceUtil::Mutex _mutex;
};

```

In addition to the node implementation classes, we have also declared an object factory:

C++

```

namespace Filesystem {
    class NodeFactory : virtual public Ice::ObjectFactory {
    public:
        virtual Ice::ObjectPtr create(const std::string&);
        virtual void destroy();
    };

```

Implementing a Persistent FileI in C++

The FileI methods are mostly trivial, because the Freeze evictor handles persistence for us:

C++

```

Filesystem::FileI::FileI() : _destroyed(false)
{
}

string
Filesystem::FileI::name(const Ice::Current& c)
{
    IceUtil::Mutex::Lock lock(_mutex);

    if (_destroyed) {
        throw Ice::ObjectNotExistException(__FILE__, __LINE__, c.id, c.
facet, c.operation);
    }

    return nodeName;
}

void
Filesystem::FileI::destroy(const Ice::Current& c)
{
    {
        IceUtil::Mutex::Lock lock(_mutex);

        if (_destroyed) {
            throw Ice::ObjectNotExistException(__FILE__, __LINE__, c.id
, c.facet, c.operation);
        }
        _destroyed = true;
    }

    //
    // Because we use a transactional evictor,
    // these updates are guaranteed to be atomic.
    //

```

```
parent?>removeNode(nodeName);
_evictor?>remove(c.id);
}

Filesystem::Lines
Filesystem::FileI::read(const Ice::Current& c)
{
    IceUtil::Mutex::Lock lock(_mutex);

    if (_destroyed) {
        throw Ice::ObjectNotExistException(__FILE__, __LINE__, c.id, c.
facet, c.operation);
    }

    return text;
}

void
Filesystem::FileI::write(const Filesystem::Lines& text,
                        const Ice::Current& c)
{
    IceUtil::Mutex::Lock lock(_mutex);

    if (_destroyed) {
        throw Ice::ObjectNotExistException(__FILE__, __LINE__, c.id, c.
facet, c.operation);
    }
}
```

```

        this?>text = text;
    }

```

The code checks that the node has not been destroyed before acting on the invocation by updating or returning state. Note that `destroy` must update two separate nodes: as well as removing itself from the evictor, the node must also update the parent's node map. Because we are using a transactional evictor, the two updates are guaranteed to be atomic, so it is impossible to leave the file system in an inconsistent state.

Implementing a Persistent `DirectoryI` in C++

The `DirectoryI` implementation requires more substantial changes. We begin our discussion with the `createDirectory` operation:

```

C++
Filesystem::DirectoryPrx
Filesystem::DirectoryI::createDirectory(const string& name,
const Ice::Current& c)
{
    IceUtil::Mutex::Lock lock(_mutex);

    if (_destroyed) {
        throw Ice::ObjectNotExistException(__FILE__, __LINE__, c.id, c.
facet, c.operation);
    }

    if (name.empty() || nodes.find(name) != nodes.end()) {
        throw NameInUse(name);
    }

    Ice::Identity id;
    id.name = IceUtil::generateUUID();
    PersistentDirectoryPtr dir = new DirectoryI;
    dir?>nodeName = name;
    dir?>parent = PersistentDirectoryPrx::uncheckedCast(c.adapter?>crea
teProxy(c.id));
    DirectoryPrx proxy = DirectoryPrx::uncheckedCast(_evictor?>add(dir,
id));

    NodeDesc nd;
    nd.name = name;
    nd.type = DirType;
    nd.proxy = proxy;
    nodes[name] = nd;

    return proxy;
}

```

After validating the node name, the operation obtains a unique identity for the child directory, instantiates the servant, and registers it with the Freeze evictor. Finally, the operation creates a proxy for the child and adds the child to its node table.

The implementation of the `createFile` operation has the same structure as `createDirectory`:

```

C++



```

Filesystem::FilePrx
Filesystem::DirectoryI::createFile(const string& name,
 const Ice::Current& c)
{
 IceUtil::Mutex::Lock lock(_mutex);

 if (_destroyed) {
 throw Ice::ObjectNotExistException(__FILE__, __LINE__, c.id, c.
facet, c.operation);
 }

 if (name.empty() || nodes.find(name) != nodes.end()) {
 throw NameInUse(name);
 }

 Ice::Identity id;
 id.name = IceUtil::generateUUID();
 PersistentFilePtr file = new FileI;
 file->nodeName = name;
 file->parent = PersistentDirectoryPrx::uncheckedCast(c.adapter->cre
ateProxy(c.id));
 FilePrx proxy = FilePrx::uncheckedCast(_evictor->add(file, id));

 NodeDesc nd;
 nd.name = name;
 nd.type = FileType;
 nd.proxy = proxy;
 nodes[name] = nd;

 return proxy;
}

```

```

Implementing NodeFactory in C++

We use a single factory implementation for creating two types of Ice objects: `PersistentFile` and `PersistentDirectory`. These are the only two types that the Freeze evictor will be restoring from its database.

C++

```
Ice::ObjectPtr
Filesystem::NodeFactory::create(const string& type)
{
    if (type == PersistentFile::ice_staticId())
        return new FileI;
    else if (type == PersistentDirectory::ice_staticId())
        return new DirectoryI;
    else {
        assert(false);
        return 0;
    }
}

void
Filesystem::NodeFactory::destroy()
{
}
```

The remaining Slice operations have trivial implementations, so we do not show them here.

See Also

- [The Server-Side main Function in C++](#)
- [C++ Mapping for Classes](#)
- [Transactional Evictor](#)

Adding an Evictor to the Java File System Server

On this page:

- [The Server Main Program in Java](#)
- [The Persistent Servant Class Definitions in Java](#)
- [Implementing a Persistent FileI in Java](#)
- [Implementing a Persistent DirectoryI in Java](#)
- [Implementing NodeFactory in Java](#)

The Server Main Program in Java

The server's `main` method is responsible for creating the evictor and initializing the root directory node. Many of the administrative duties, such as creating and destroying a communicator, are handled by the `Ice.Application` class. Our server `main` program has now become the following:

```

                                Java
import Filesystem.*;

public class Server extends Ice.Application
{
    public
    Server(String envName)
    {
        _envName = envName;
    }

    public int
    run(String[] args)
    {
        Ice.ObjectFactory factory = new NodeFactory();
        communicator().addObjectFactory(factory, PersistentFile.ice_sta
ticId());
        communicator().addObjectFactory(factory, PersistentDirectory.ic
e_staticId());

        Ice.ObjectAdapter adapter = communicator().createObjectAdapter(
"EvictorFilesystem");

        Freeze.Evictor evictor =
            Freeze.Util.createTransactionalEvictor(adapter, _envName, "
evictorfs",
null, null, null, true);
        DirectoryI._evictor = evictor;
        FileI._evictor = evictor;

        adapter.addServantLocator(evictor, "");

        Ice.Identity rootId = new Ice.Identity();
        rootId.name = "RootDir";
        if(!evictor.hasObject(rootId))

```

```
    {
        PersistentDirectory root = new DirectoryI();
        root.nodeName = "/";
        root.nodes =
new java.util.HashMap<java.lang.String, NodeDesc>();
        evictor.add(root, rootId);
    }

    adapter.activate();

    communicator().waitForShutdown();

    return 0;
}

public static void
main(String[] args)
{
    Server app = new Server("db");
    int status = app.main("Server", args, "config.server");
    System.exit(status);
}
```



```
private String _envName;
}
```

Let us examine the changes in detail. First, we define the class `Server` as a subclass of `Ice.Application`, and provide a constructor taking a string argument:

```
Java

public
Server(String envName)
{
    _envName = envName;
}
```

The string argument represents the name of the database environment, and is saved for later use in `run`.

One of the first tasks `run` performs is installing the Ice [object factories](#) for `PersistentFile` and `PersistentDirectory`. Although these classes are not exchanged via Slice operations, they are marshalled and unmarshalled in exactly the same way when saved to and loaded from the database, therefore factories are required. A single instance of `NodeFactory` is installed for both types:

```
Java

Ice.ObjectFactory factory = new NodeFactory();
communicator().addObjectFactory(factory, PersistentFile.ice_staticId());
communicator().addObjectFactory(factory, PersistentDirectory.ice_staticId());
```

After creating the object adapter, the program initializes a [transactional evictor](#) by invoking `createTransactionalEvictor`. The third argument to `createTransactionalEvictor` is the name of the database, the fourth is null to indicate that we do not use facets, the fifth is null to indicate that we do not use a servant initializer, the sixth argument (null) indicates no indexes are in use, and the `true` argument requests that the database be created if it does not exist. The evictor is then added to the object adapter as a servant locator for the default category:

```
Java

Freeze.Evictor evictor =
    Freeze.Util.createTransactionalEvictor(adapter, _envName, "
evictorfs",

null, null, null, true);
DirectoryI._evictor = evictor;
FileI._evictor = evictor;

adapter.addServantLocator(evictor, "");
```

Next, the program creates the root directory node if it is not already being managed by the evictor:

Java

```
Ice.Identity rootId = new Ice.Identity();
rootId.name = "RootDir";
if(!evictor.hasObject(rootId))
{
    PersistentDirectory root = new DirectoryI();
    root.nodeName = "/";
    root.nodes = new java.util.HashMap<String, NodeDesc>();
    evictor.add(root, rootId);
}
```

Finally, the `main` function instantiates the `Server` class, passing `db` as the name of the database environment:

Java

```
public static void
main(String[] args)
{
    Server app = new Server("db");
    int status = app.main("Server", args, "config.server");
    System.exit(status);
}
```

The Persistent Servant Class Definitions in Java

The servant classes must also be changed to incorporate the Freeze evictor. The `FileI` class now has a static state member `_evictor`:

Java

```
import Filesystem.*;

public final class FileI extends PersistentFile
{
    public
    FileI()
    {
        _destroyed = false;
    }

    // Slice operations...

    public static Freeze.Evictor _evictor;
    private boolean _destroyed;
}
```

The `DirectoryI` class has undergone a similar transformation:

Java

```
import Filesystem.*;

public final class DirectoryI extends PersistentDirectory
{
    public
    DirectoryI()
    {
        _destroyed = false;
        nodes = new java.util.HashMap<String, NodeDesc>();
    }

    // Slice operations...

    public static Freeze.Evictor _evictor;
    private boolean _destroyed;
}
```

Implementing a Persistent FileI in Java

The FileI methods are mostly trivial, because the Freeze evictor handles persistence for us.

Java

```
public synchronized String
name(Ice.Current current)
{
    if (_destroyed) {
        throw new Ice.ObjectNotExistException(current.id, current.f
acet, current.operation);
    }

    return nodeName;
}

public void
destroy(Ice.Current current)
    throws PermissionDenied
{
    synchronized(this) {
        if (_destroyed) {
            throw new Ice.ObjectNotExistException(current.id, curre
nt.facet, current.operation);
        }
        _destroyed = true;
    }

    //
```

```
        // Because we use a transactional evictor,  
        // these updates are guaranteed to be atomic.  
        //  
        parent.removeNode(nodeName);  
        _evictor.remove(current.id);  
    }  
  
    public synchronized String[]  
    read(Ice.Current current)  
    {  
        if (_destroyed) {  
            throw new Ice.ObjectNotExistException(current.id, current.f  
acet, current.operation);  
        }  
  
        return (String[])text.clone();  
    }  
  
    public synchronized void  
    write(String[] text, Ice.Current current)  
        throws GenericError  
    {  
        if (_destroyed) {  
            throw new Ice.ObjectNotExistException(current.id, current.f  
acet, current.operation);  
        }  
    }  
}
```

```

        this.text = text;
    }

```

The code checks that the node has not been destroyed before acting on the invocation by updating or returning state. Note that `destroy` must update two separate nodes: as well as removing itself from the evictor, the node must also update the parent's node map. Because we are using a transactional evictor, the two updates are guaranteed to be atomic, so it is impossible to leave the file system in an inconsistent state.

Implementing a Persistent `DirectoryI` in Java

The `DirectoryI` implementation requires more substantial changes. We begin our discussion with the `createDirectory` operation:

```

Java

public synchronized DirectoryPrx
createDirectory(String name, Ice.Current current)
    throws NameInUse
{
    if (!_destroyed) {
        throw new Ice.ObjectNotExistException(current.id, current.facet, current.operation);
    }

    if (name.length() == 0 || nodes.containsKey(name)) {
        throw new NameInUse(name);
    }

    Ice.Identity id = current.adapter.getCommunicator().stringToIdentity(
        java.util.UUID.randomUUID().toString());
    PersistentDirectory dir = new DirectoryI();
    dir.nodeName = name;
    dir.parent = PersistentDirectoryPrxHelper.uncheckedCast(
        current.adapter.createProxy(current.id));
    DirectoryPrx proxy = DirectoryPrxHelper.uncheckedCast(_evictor.add(dir, id));

    NodeDesc nd = new NodeDesc();
    nd.name = name;
    nd.type = NodeType.DirType;
    nd.proxy = proxy;
    nodes.put(name, nd);

    return proxy;
}

```

After validating the node name, the operation obtains a unique identity for the child directory, instantiates the servant, and registers it with the Freeze evictor. Finally, the operation creates a proxy for the child and adds the child to its node table.

The implementation of the `createFile` operation has the same structure as `createDirectory`:

Java

```

public synchronized FilePrx
createFile(String name, Ice.Current current)
    throws NameInUse
{
    if (!_destroyed) {
        throw new Ice.ObjectNotExistException(current.id, current.f
acet, current.operation);
    }

    if (name.length() == 0 || nodes.containsKey(name)) {
        throw new NameInUse(name);
    }

    Ice.Identity id = current.adapter.getCommunicator().stringToIde
ntity(
        java.util.UUID.randomUUID().toString());
    PersistentFile file = new FileI();
    file.nodeName = name;
    file.parent = PersistentDirectoryPrxHelper.uncheckedCast(
        current.adapter.createProxy(current.id));
    FilePrx proxy = FilePrxHelper.uncheckedCast(_evictor.add(file,
id));

    NodeDesc nd = new NodeDesc();
    nd.name = name;
    nd.type = NodeType.FileType;
    nd.proxy = proxy;
    nodes.put(name, nd);

    return proxy;
}

```

The remaining Slice operations have trivial implementations, so we do not show them here.

Implementing NodeFactory in Java

We use a single factory implementation for creating two types of Ice objects: `PersistentFile` and `PersistentDirectory`. These are the only two types that the Freeze evictor will be restoring from its database.

Java

```
package Filesystem;

public class NodeFactory implements Ice.ObjectFactory
{
    public Ice.Object
    create(String type)
    {
        if (type.equals(PersistentFile.ice_staticId()))
            return new FileI();
        else if (type.equals(PersistentDirectory.ice_staticId()))
            return new DirectoryI();
        else {
            assert(false);
            return null;
        }
    }

    public void
    destroy()
    {
    }
}
```

See Also

- [The Server-Side main Method in Java](#)
- [Java Mapping for Classes](#)
- [Transactional Evictor](#)

Freeze Maps

A Freeze map is a persistent, associative container in which the key and value types can be any primitive or user-defined Slice types. For each pair of key and value types, the developer uses a code-generation tool to produce a language-specific class that conforms to the standard conventions for maps in that language. For example, in C++, the generated class resembles a `std::map`, and in Java it implements the `java.util.SortedMap` interface. Most of the logic for storing and retrieving state to and from the database is implemented in a Freeze base class. The generated map classes derive from this base class, so they contain little code and therefore are efficient in terms of code size.

You can only store data types that are defined in Slice in a Freeze map. Types without a Slice definition (that is, arbitrary C++ or Java types) cannot be stored because a Freeze map reuses the Ice-generated marshaling code to create the persistent representation of the data in the database. This is especially important to remember when defining a [Slice class](#) whose instances will be stored in a Freeze map; only the "public" (Slice-defined) data members will be stored, not the private state members of any derived implementation class.

Topics

- [Freeze Map Concepts](#)
- [Using a Freeze Map in C++](#)
- [Using a Freeze Map in Java](#)
- [Using a Freeze Map in the File System Server](#)

See Also

- [Classes](#)

Freeze Map Concepts

On this page:

- [Freeze Connections](#)
- [Using Transactions with Freeze Maps](#)
 - [Using Transactions with C++](#)
 - [Using Transactions with Java](#)
- [Iterating a Freeze Map](#)
- [Recovering from Freeze Map Deadlocks](#)
- [Key Sorting for Freeze Maps](#)
 - [Key Sorting for Freeze Maps in C++](#)
 - [Key Sorting for Freeze Maps in Java](#)
- [Indexing a Freeze Map](#)

Freeze Connections

In order to create a Freeze map object, you first need to obtain a `Freeze Connection` object by connecting to a database environment.

As illustrated in the following figure, a Freeze map is associated with a single connection and a single database file. Connection and map objects are not thread-safe: if you want to use a connection or any of its associated maps from multiple threads, you must serialize access to them. If your application requires concurrent access to the same database file (persistent map), you must create several connections and associated maps.

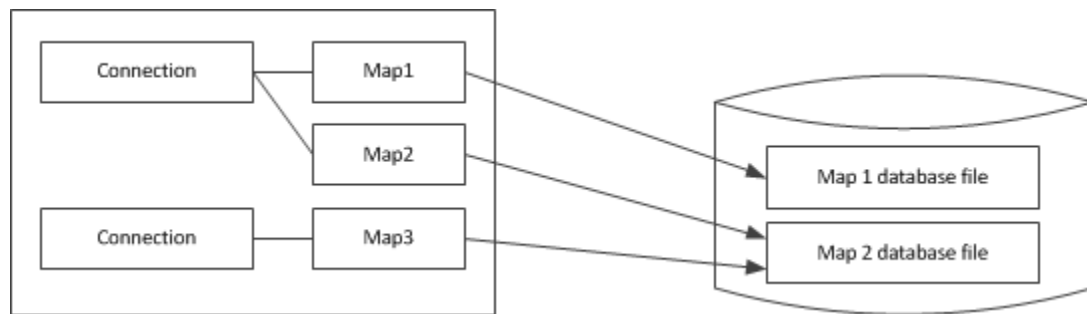

Freeze connections and maps.

Freeze connections provide operations that allow you to begin a transaction, access the current transaction, get the communicator associated with a connection, close a connection, and remove a map index. See the [Slice API reference](#) for more information on these operations.

Using Transactions with Freeze Maps

You may optionally use transactions with Freeze maps. Freeze transactions provide the usual ACID (atomicity, concurrency, isolation, durability) properties. For example, a transaction allows you to group several database updates in one atomic unit: either all or none of the updates within the transaction occur.

You start a transaction by calling `beginTransaction` on the `Connection` object. Once a connection has an associated transaction, all operations on the map objects associated with this connection use this transaction. Eventually, you end the transaction by calling `commit` or `rollback`: `commit` saves all your updates while `rollback` undoes them. The `currentTransaction` operation returns the transaction associated with a connection, if any; otherwise, it returns `nil`.

Slice

```

module Freeze {

    local interface Transaction {
        void commit();
        void rollback();
    };

    local interface Connection {
        Transaction beginTransaction();
        idempotent Transaction currentTransaction();
        // ...
    };
};

```

If you do not use transactions, every non-iterator update is enclosed in its own internal transaction, and every read-write iterator has an associated internal transaction that is committed when the iterator is closed.

Using Transactions with C++

You must ensure that you either commit or roll back each transaction that you begin (otherwise, locks will be held by the database until they time out):

C++

```

ConnectionPtr connection = ...;

TransactionPtr tx = connection->beginTransaction();
try {

    // DB updates that might throw here...

    tx->commit();

    // More code that might throw here...

} catch (...) {
    try {
        tx->rollback();
    } catch (...) {
    }
    throw;
}

```

The outer try-catch blocks are necessary because, if the code encounters an exception, we must roll back any updates that were made. In turn, the attempt to roll back might throw itself, namely, if the code following the commit throws an exception (in which case the transaction cannot be rolled back because it is already committed).

Code such as this is difficult to maintain: for example, an early return statement can cause the transaction to be neither committed nor rolled

back. The `TransactionHolder` class ensures that such errors cannot happen:

```
C++
```

```
namespace Freeze {
    class TransactionHolder {
    public:
        TransactionHolder(const ConnectionPtr&);
        ~TransactionHolder();

        void commit();
        void rollback();

    private:
        // Copy and assignment are forbidden.
        TransactionHolder(const TransactionHolder&);
        TransactionHolder& operator=(const TransactionHolder&);
    };
}
```

The constructor calls `beginTransaction` if the connection does not already have a transaction in progress, so instantiating the holder also starts a transaction. When the holder instance goes out of scope, its destructor calls `rollback` on the transaction and suppresses any exceptions that the rollback attempt might throw. This ensures that the transaction is rolled back if it was not previously committed or rolled back and ensures that an early return or an exception cannot cause the transaction to remain open:

```
C++
```

```
ConnectionPtr connection = ...;

{ // Open scope

    TransactionHolder tx(connection); // Begins transaction

    // DB updates that might throw here...

    tx.commit();

    // More code that might throw here...

} // Transaction rolled back here if not previously
  // committed or rolled back.
```

If you instantiate a `TransactionHolder` when a transaction is already in progress, it does nothing: the constructor notices that it could not begin a new transaction and turns `commit`, `rollback`, and the destructor into no-ops. For example, the nested `TransactionHolder` instance in the following code is benign and does nothing:

C++

```
ConnectionPtr connection = ...;

{ // Open scope

    TransactionHolder tx(connection); // Begins transaction

    // DB updates that might throw here...

    { // Open nested scope

        TransactionHolder tx2(connection); // Does nothing

        // DB updates that might throw here...

        tx2.commit(); // Does nothing

        // More code that might throw here...

    } // Destructor of tx2 does nothing

    tx.commit();

    // More code that might throw here...

} // Transaction rolled back here if not previously
// committed or rolled back.
```

Using Transactions with Java

You must ensure that you either commit or roll back each transaction that you begin (otherwise, locks will be held by the database until they time out):

Java

```
Connection connection = ...;

Transaction tx = connection.beginTransaction();
try {

    // DB updates that might throw here...

    tx.commit();

    // More code that might throw here...

} catch (java.lang.RuntimeException ex) {
    try {
        tx.rollback();
    } catch (DatabaseException e) {
    }
    throw ex;
}
```

The catch handler ensures that the transaction is rolled back before re-throwing the exception. Note that the nested try-catch blocks are necessary: if the transaction committed successfully but the code following the commit throws an exception, the rollback attempt will fail therefore we need to suppress the corresponding `DatabaseException` that is raised in that case.

Also use caution with early `return` statements:

Java

```
Connection connection = ...;

Transaction tx = connection.beginTransaction();
try {

    // DB updates that might throw here...

    if (error) {
        // ...
        return; // Oops, bad news!
    }

    // ...

    tx.commit();

    // More code that might throw here...

} catch (java.lang.RuntimeException ex) {
    try {
        tx.rollback();
    } catch (DatabaseException e) {
    }
    throw ex;
}
```

The early `return` statement in the preceding code causes the transaction to be neither committed nor rolled back. To deal with this situation, avoid early return statements or ensure that you either commit or roll back the transaction before returning. Alternatively, you can use a `finally` block to ensure that the transaction is rolled back:

Java

```

Connection connection = ...;

try {

    Transaction tx = connection.beginTransaction();

    // DB updates that might throw here...

    if (error) {
        // ...
        return; // No problem, see finally block.
    }

    // ...

    tx.commit();

    // More code that might throw here...

} finally {
    if (connection.currentTransaction() != null)
        connection.currentTransaction().rollback();
}

```

Iterating a Freeze Map

Iterators allow you to traverse the contents of a Freeze map. Iterators are implemented using Berkeley DB cursors and acquire locks on the underlying database page files. In C++, both read-only (`const_iterator`) and read-write iterators (`iterator`) are available. In Java, an iterator is read-write if it is obtained in the context of a transaction and read-only if it is obtained outside a transaction.

Locks held by an iterator are released when the iterator is closed (if you do not use transactions) or when the enclosing transaction ends. Releasing locks held by iterators is very important to let other threads access the database file through other connection and map objects. Occasionally, it is even necessary to release locks to avoid self-deadlock (waiting forever for a lock held by an iterator created by the same thread).

To improve ease of use and make self-deadlocks less likely, Freeze often closes iterators automatically. If you close a map or connection, associated iterators are closed. Similarly, when you start or end a transaction, Freeze closes all the iterators associated with the corresponding maps. If you do not use transactions, any write operation on a map (such as inserting a new element) automatically closes all iterators opened on the same map object, except for the current iterator when the write operation is performed through that iterator. In Java, Freeze also closes a read-only iterator when no more elements are available.

There is, however, one situation in C++ where an explicit iterator close is needed to avoid self-deadlock:

- you do not use transactions, and
- you have an open iterator that was used to update a map (it holds a write lock), and
- in the same thread, you read that map.

Read operations in C++ never close iterators automatically: you need to either use transactions or explicitly close the iterator that holds the write lock. This is not an issue in Java because you cannot use an iterator to update a map outside of a transaction.

Recovering from Freeze Map Deadlocks

If you use multiple threads to access a database file, Berkeley DB may acquire locks in conflicting orders (on behalf of different transactions or iterators). For example, an iterator could have a read-lock on page P1 and attempt to acquire a write-lock on page P2, while another iterator (on a different map object associated with the same database file) could have a read-lock on P2 and attempt to acquire a write-lock on P1.

When this occurs, Berkeley DB detects a deadlock and resolves it by returning a "deadlock" error to one or more threads. For all non-iterator operations performed outside any transaction, such as an insertion into a map, Freeze catches such errors and automatically retries the operation until it succeeds. (In that case, the most-recently acquired lock is released before retrying.) For other operations, Freeze reports this deadlock by raising `Freeze::DeadlockException`. In that case, the associated transaction or iterator is also automatically rolled back or closed. A properly written application must expect to catch deadlock exceptions and retry the transaction or iteration.

Key Sorting for Freeze Maps

Keys in Freeze maps and indexes are always sorted. By default, Freeze sorts keys according to their Ice-encoded binary representation; this is very efficient but the resulting order is rarely meaningful for the application. Starting with Ice 3.0, Freeze offers the ability to specify your own comparator objects so that you can customize the traversal order of your maps. Note however that the comparator of a Freeze map should remain the same throughout the life of the map. Berkeley DB stores records according to the key order provided by this comparator; switching to another comparator will cause undefined behavior.

Key Sorting for Freeze Maps in C++

In C++, you specify the name of your comparator objects during code generation. The generated map provides the standard features of `std::map`, so that iterators return entries according to the order you have defined for the main key with your comparator object. The `lower_bound`, `upper_bound`, and `equal_range` functions provide range-searches (see the definition of these functions on `std::map`).

Apart from these standard features, the [generated map](#) provides additional functions and methods to perform range searches using secondary keys. The additional functions are `lowerBoundForMember`, `upperBoundForMember`, and `equalRangeForMember`, where *Member* is the name of the secondary-key member. These functions return regular iterators on the Freeze map.

Key Sorting for Freeze Maps in Java

In Java, you supply comparator objects (instances of the standard Java interface `java.util.Comparator`) at run time when instantiating the generated map class. The [map constructor](#) accepts a comparator for the main key and optionally a collection of comparators for secondary keys. The map also provides a number of methods for performing range searches on the main key and on secondary keys.

Indexing a Freeze Map

Freeze maps support efficient reverse lookups: if you define an index when you generate your map (with `slice2freeze` or `slice2freezej`), the generated code provides additional methods for performing reverse lookups. If your value type is a structure or a class, you can also index on a member of the value, and several such indexes can be associated with the same Freeze map.

Indexed searches are easy to use and very efficient. However, be aware that an index adds significant write overhead: with Berkeley DB, every update triggers a read from the database to get the old index entry and, if necessary, replace it.

If you later add an index to an existing map, Freeze automatically populates the index the next time you open the map. Freeze populates the index by instantiating each map entry, so it is important that you register the object factories for any class types in your map before you open the map.

Note that the index key comparator of a Freeze map index should remain the same throughout the life of the index. Berkeley DB stores records according to the key order provided by this comparator; switching to another comparator will cause undefined behavior.

See Also

- [Using a Freeze Map in C++](#)
- [Using a Freeze Map in Java](#)

Using a Freeze Map in C++

This page describes the C++ code generator and demonstrates how to use a Freeze map in a C++ program.

On this page:

- [slice2freeze Command-Line Options](#)
- [Generating a Simple Map for C++](#)
- [The Freeze Map Class in C++](#)
- [Using Iterators with Freeze Maps in C++](#)
- [Sample Freeze Map Program in C++](#)

slice2freeze Command-Line Options

The Slice-to-Freeze compiler, `slice2freeze`, creates C++ classes for Freeze maps. The compiler offers the following command-line options in addition to the [standard options](#):

--header-ext *EXT*

Changes the file extension for the generated header files from the default `h` to the extension specified by *EXT*.

--source-ext *EXT*

Changes the file extension for the generated source files from the default `cpp` to the extension specified by *EXT*.

--add-header *HDR[,GUARD]*

This option adds an include directive for the specified header at the beginning of the generated source file (preceding any other include directives). If *GUARD* is specified, the include directive is protected by the specified guard.

For example:

```
--add-header precompiled.h, __PRECOMPILED_H__
```

results in the following directives at the beginning of the generated source file:

```
C++
```

```
#ifndef __PRECOMPILED_H__
#define __PRECOMPILED_H__
#include <precompiled.h>
#endif
```

As this example demonstrates, the `--add-header` option is useful mainly for integrating the generated code with a compiler's precompiled header mechanism.

This option can be repeated to create include directives for several files.

--include-dir *DIR*

Modifies `#include` directives in source files to prepend the path name of each header file with the directory *DIR*. The discussion of [slice2cpp](#) provides more information.

--dll-export *SYMBOL*

Use *SYMBOL* to control DLL exports or imports. See the [slice2cpp](#) description for details.

```
--dict NAME,KEY,VALUE[,sort[,COMPARE]]
```

Generate a Freeze map class named *NAME* using *KEY* as key and *VALUE* as value. This option may be specified multiple times to generate several Freeze maps. *NAME* may be a scoped C++ name, such as `Demo::Struct1ObjectMap`. *KEY* and *VALUE* represent Slice types and therefore must use Slice syntax, such as `bool` or `Ice::Identity`. By default, keys are sorted using their binary Ice-encoded representation. Include `sort` to sort with the *COMPARE* functor class. If *COMPARE* is not specified, the default value is `std::less<KEY>`.

```
--dict-index MAP[,MEMBER] [,case-sensitive|case-insensitive][,sort[,COMPARE]]
```

Add an index to the Freeze map named *MAP*. If *MEMBER* is specified, the map value type must be a structure or a class, and *MEMBER* must be a member of this structure or class. Otherwise, the entire value is indexed. When the indexed member (or entire value) is a string, the index can be case-sensitive (default) or case-insensitive. An index adds additional member functions to the generated C++ map:

- `iterator findByMEMBER(MEMBER_TYPE, bool = true);`
- `const_iterator findByMEMBER(MEMBER_TYPE, bool = true) const;`
- `iterator beginForMEMBER();`
- `const_iterator begin_ForMEMBER() const;`
- `iterator endForMEMBER();`
- `const_iterator endForMEMBER() const;`
- `iterator lowerBoundForMEMBER(MEMBER_TYPE);`
- `const_iterator lowerBoundForMEMBER(MEMBER_TYPE) const;`
- `iterator upperBoundForMEMBER(MEMBER_TYPE);`
- `const_iterator upperBoundForMEMBER(MEMBER_TYPE) const;`
- `std::pair<iterator, iterator> equalRangeForMEMBER(MEMBER_TYPE);`
- `std::pair<const_iterator, const_iterator> equalRangeForMEMBER(MEMBER_TYPE) const;`
- `int MEMBERCount(MEMBER_TYPE) const;`

When *MEMBER* is not specified, these functions are `findByValue` (const and non-const), `lowerBoundForValue` (const and non-const), `valueCount`, and so on. When *MEMBER* is specified, its first letter is capitalized in the `findBy` function name. *MEMBER_TYPE* corresponds to an in-parameter of the type of *MEMBER* (or the type of the value when *MEMBER* is not specified). For example, if *MEMBER* is a string, *MEMBER_TYPE* is a `const std::string&`.

By default, keys are sorted using their binary Ice-encoded representation. Include `sort` to sort with the *COMPARE* functor class. If *COMPARE* is not specified, the default value is `std::less<MEMBER_TYPE>`.

`findByMEMBER` returns an iterator to the first element in the Freeze map that matches the given index value. It returns `end()` if there is no match. When the second parameter is true (the default), the returned iterator provides only the elements with an exact match (and then skips to `end()`). Otherwise, the returned iterator sets a starting position and then provides all elements until the end of the map, sorted according to the index comparator.

`lowerBoundForMEMBER` returns an iterator to the first element in the Freeze map whose index value is not less than the given index value. It returns `end()` if there is no such element. The returned iterator provides all elements until the end of the map, sorted according to the index comparator.

`upperBoundForMEMBER` returns an iterator to the first element in the Freeze map whose index value is greater than the given index value. It returns `end()` if there is no such element. The returned iterator provides all elements until the end of the map, sorted according to the index comparator.

`beginForMEMBER` returns an iterator to the first element in the map.

`endForMEMBER` returns an iterator to the last element in the map.

`equalRangeForMEMBER` returns a range (pair of iterators) of all the elements whose index value matches the given index value. This function is similar to `findByMEMBER` (see above).

`MEMBERCount` returns the number of elements in the Freeze map whose index value matches the given index value.

Please note that index-derived iterators do not allow you to set new values in the underlying map.

```
--index CLASS,TYPE,MEMBER [,case-sensitive|case-insensitive]
```

Generate an [index class for a Freeze evictor](#). *CLASS* is the name of the class to be generated. *TYPE* denotes the type of class to be indexed (objects of different classes are not included in this index). *MEMBER* is the name of the data member in *TYPE* to index. When *MEMBER* has type `string`, it is possible to specify whether the index is case-sensitive or not. The default is case-sensitive.

Generating a Simple Map for C++

As an example, the following command generates a simple map:

```
$ slice2freeze --dict StringIntMap,string,int StringIntMap
```

This command directs the compiler to create a map named `StringIntMap`, with the Slice key type `string` and the Slice value type `int`. The final argument is the base name for the output files, to which the compiler appends the `.h` and `.cpp` suffixes. As a result, this command produces two C++ source files, `StringIntMap.h` and `StringIntMap.cpp`.

The Freeze Map Class in C++

If you examine the contents of the header file created by the example in the previous section, you will discover that a Freeze map is an instance of the template class `Freeze::Map`:

```
C++
```

```
// StringIntMap.h
typedef Freeze::Map<std::string, Ice::Int, ...> StringIntMap;
```

The `Freeze::Map` template class closely resembles the STL container class `std::map`, as shown in the following class definition:

```
C++
```

```
namespace Freeze {
template<...> class Map {
public:
    typedef ... value_type;
    typedef ... iterator;
    typedef ... const_iterator;

    typedef size_t size_type;
    typedef ptrdiff_t difference_type;

    Map(const Freeze::ConnectionPtr& connection,
        const std::string& dbName,
        bool createDb = true,
        const Compare& compare = Compare());

    template<class _InputIterator>
    Map(const Freeze::ConnectionPtr& connection,
        const std::string& dbName,
        bool createDb,
        _InputIterator first, _InputIterator last,
        const Compare& compare = Compare());
```

```

static void recreate(const Freeze::ConnectionPtr& connection,
                    const std::string& dbName,
                    const Compare& compare = Compare());

bool operator==(const Map& rhs) const;
bool operator!=(const Map& rhs) const;

void swap(Map& rhs);

iterator begin();
const_iterator begin() const;

iterator end();
const_iterator end() const;

bool empty() const;
size_type size() const;
size_type max_size() const;

iterator insert(iterator /*position*/, const value_type& elem);

std::pair<iterator, bool> insert(const value_type& elem);

template <typename InputIterator>
void insert(InputIterator first, InputIterator last);

void put(const value_type& elem);

template <typename InputIterator>
void put(InputIterator first, InputIterator last);

void erase(iterator position);
size_type erase(const key_type& key);
void erase(iterator first, iterator last);

void clear();

void destroy(); // Non-standard.

iterator find(const key_type& key);
const_iterator find(const key_type& key) const;

size_type count(const key_type& key) const;

iterator lower_bound(const key_type& key);
const_iterator lower_bound(const key_type& key) const;
iterator upper_bound(const key_type& key);
const_iterator upper_bound(const key_type& key) const;

std::pair<iterator, iterator>

```

```
equal_range(const key_type& key);  
  
std::pair<const_iterator, const_iterator>  
equal_range(const key_type& key) const;  
  
const Ice::CommunicatorPtr&  
communicator() const;  
  
...
```

```
};
}
```

The semantics of the `Freeze::Map` methods are identical to those of `std::map` unless otherwise noted. In particular, the overloaded `insert` method shown below ignores the `position` argument:

```
C++
```

```
iterator insert(iterator /*position*/, const value_type& elem);
```

A `Freeze` map class supports only those methods shown above; other features of `std::map`, such as allocators and overloaded array operators, are not available.

Non-standard methods that are specific to `Freeze` maps are discussed below:

- Constructors

The following overloaded constructors are provided:

```
C++
```

```
Map(const Freeze::ConnectionPtr& connection,
    const std::string& dbName,
    bool createDb = true,
    const Compare& compare = Compare());

template<class _InputIterator>
Map(const Freeze::ConnectionPtr& connection,
    const std::string& dbName,
    bool createDb,
    _InputIterator first, _InputIterator last,
    const Compare& compare = Compare());
```

The first constructor accepts a connection, the database name, a flag indicating whether to create the database if it does not exist, and an object used to compare keys. The second constructor accepts all of the parameters of the first, with the addition of iterators from which elements are copied into the map.

Note that a database can only contain the persistent state of one map type. Any attempt to instantiate maps of different types on the same database results in undefined behavior.

- Map copy

The `recreate` function copies an existing database:

```
C++
```

```
static void recreate(const Freeze::ConnectionPtr& connection,
                   const std::string& dbName,
                   const Compare& compare = Compare())
```

The `dbName` parameter specifies an existing database name. The copy has the name `<dbName>.old-<uuid>`. For example, if the

database name is `MyDB`, the copy might be named

`MyDB.old-edefd55a-e66a-478d-a77b-f6d53292b873`. (Obviously, a different UUID is used each time you recreate a database).

- `destroy`
This method deletes the database from its environment and from the [Freeze catalog](#). If a transaction is not currently open, the method creates its own transaction in which to perform this task.
- `communicator`
This method returns the communicator with which the map's connection is associated.

Using Iterators with Freeze Maps in C++

A Freeze map's iterator works like its counterpart in `std::map`. The iterator class supports one convenient (but nonstandard) method:

```
C++  
void set(const mapped_type& value)
```

Using this method, a program can replace the value at the iterator's current position.

Sample Freeze Map Program in C++

The program below demonstrates how to use a `StringIntMap` to store `<string, int>` pairs in a database. You will notice that there are no explicit `read` or `write` operations called by the program; instead, simply using the map has the side effect of accessing the database.

```
C++  
#include <Freeze/Freeze.h>  
#include <StringIntMap.h>  
  
int  
main(int argc, char* argv[])  
{  
    // Initialize the Communicator.  
    //  
    Ice::CommunicatorPtr communicator = Ice::initialize(argc, argv);  
  
    // Create a Freeze database connection.  
    //  
    Freeze::ConnectionPtr connection =  
    Freeze::createConnection(communicator, "db");  
  
    // Instantiate the map.  
    //  
    StringIntMap map(connection, "simple");  
  
    // Clear the map.  
    //  
    map.clear();  
  
    Ice::Int i;
```

```
StringIntMap::iterator p;  
  
// Populate the map.  
//  
for (i = 0; i < 26; i++) {  
    std::string key(1, 'a' + i);  
    map.insert(make_pair(key, i));  
}  
  
// Iterate over the map and change the values.  
//  
for (p = map.begin(); p != map.end(); ++p)  
    p.set(p->second + 1);  
  
// Find and erase the last element.  
//  
p = map.find("z");  
assert(p != map.end());  
map.erase(p);  
  
// Clean up.  
//  
connection->close();  
communicator->destroy();
```



```

    return 0;
}

```

Prior to instantiating a Freeze map, the application must connect to a Berkeley DB database environment:

```

C++
Freeze::ConnectionPtr connection =
Freeze::createConnection(communicator, "db");

```

The second argument is the name of a Berkeley DB database environment; by default, this is also the file system directory in which Berkeley DB creates all database and administrative files. Note that `properties` with the prefix `Freeze.DbEnv` can modify a number of environment settings, including the file system directory. For the preceding example, you could change the directory to `FreezeDir` by setting the property `Freeze.DbEnv.db.DbHome` to `FreezeDir`.

Next, the code instantiates the `StringIntMap` on the connection. The constructor's second argument supplies the name of the database file, which by default is created if it does not exist:

```

C++
StringIntMap map(connection, "simple");

```

After instantiating the map, we clear it to make sure it is empty in case the program is run more than once:

```

C++
map.clear();

```

Next, we populate the map using a single-character string as the key:

```

C++
for (i = 0; i < 26; i++) {
    std::string key(1, 'a' + i);
    map.insert(make_pair(key, i));
}

```

Iterating over the map will look familiar to `std::map` users. However, to modify a value at the iterator's current position, we use the nonstandard `set` method:

```

C++
for (p = map.begin(); p != map.end(); ++p)
    p.set(p->second + 1);

```

Next, the program obtains an iterator positioned at the element with key `z`, and erases it:

C++

```
p = map.find("z");  
assert(p != map.end());  
map.erase(p);
```

Finally, the program closes the database connection:

C++

```
connection->close();
```

It is not necessary to explicitly close the database connection, but we demonstrate it here for the sake of completeness.

See Also

- [Using the Slice Compilers](#)
- [slice2cpp Command-Line Options](#)
- [Freeze Evictor Concepts](#)
- [Freeze Catalogs](#)
- [Freeze Properties](#)

Using a Freeze Map in Java

This section describes the Java code generator and demonstrates how to use a Freeze map in a Java program.

On this page:

- [slice2freezej Command Line Options](#)
- [Generating a Simple Map for Java](#)
- [slice2freezej Ant Task](#)
- [The Freeze Map Class in Java](#)
- [Why Comparators are Important](#)
- [Using Iterators with Freeze Maps in Java](#)
- [Generating Indices for Freeze Maps in Java](#)
- [Sample Freeze Map Program in Java](#)

slice2freezej Command Line Options

The Slice-to-Freeze compiler, `slice2freezej`, creates Java classes for Freeze maps. The compiler offers the following command-line options in addition to the [standard options](#):

--dict *NAME,KEY,VALUE*

Generate a Freeze map class named *NAME* using *KEY* as key and *VALUE* as value. This option may be specified multiple times to generate several Freeze maps. *NAME* may be a scoped Java name, such as `Demo.Struct1ObjectMap`. *KEY* and *VALUE* represent Slice types and therefore must use Slice syntax, such as `bool` or `Ice::Identity`.

--dict-index *MAP[,MEMBER][,case-sensitive|case-insensitive]*

Add an [index](#) to the Freeze map named *MAP*. If *MEMBER* is specified, the map value type must be a structure or a class, and *MEMBER* must be the name of a member of that type. If *MEMBER* is not specified, the entire value is indexed. When the indexed member (or entire value) is a string, the index can be case-sensitive (default) or case-insensitive.

--index *CLASS,TYPE,MEMBER[,case-sensitive|case-insensitive]*

Generate an [index class](#) for a Freeze evictor. *CLASS* is the name of the index class to be generated. *TYPE* denotes the type of class to be indexed (objects of different classes are not included in this index). *MEMBER* is the name of the data member in *TYPE* to index. When *MEMBER* has type `string`, it is possible to specify whether the index is case-sensitive or not. The default is case-sensitive.

--meta *META*

Define the global metadata directive *META*. Using this option is equivalent to defining the global metadata *META* in each named Slice file, as well as in any file included by a named Slice file.

Generating a Simple Map for Java

As an example, the following command generates a simple map:

```
$ slice2freezej --dict StringIntMap,string,int
```

This command directs the compiler to create a map named `StringIntMap`, with the Slice key type `string` and the Slice value type `int`. The compiler produces one Java source file: `StringIntMap.java`.

slice2freezej Ant Task

In addition to the [ant task for executing slice2java](#), Ice also includes an ant task for executing `slice2freezej`. The classes for `Slice2FreezeJTask` are stored in the same JAR file (`ant-ice.jar`) as `Slice2JavaTask`. Both tasks also share the same logic for locating a

compiler in your execution environment and for managing dependencies between Slice files.

The `Slice2FreezeJTask` supports the parameters listed below:

Attribute	Description	Required
<code>dependencyfile</code>	Specifies an alternate name for the dependency file. If you specify a relative filename, it is relative to ant's current working directory. If not specified, the task uses the name <code>.depend</code> by default. If you do not define this attribute and <code>outputdir</code> is defined, the task creates the <code>.depend</code> file in the designated output directory (see <code>outputdir</code>).	No
<code>ice</code>	Instructs the Slice compiler to permit symbols that have the reserved prefix <code>Ice</code> . This parameter is used in the Ice build system and is not normally required by applications.	No
<code>outputdir</code>	Specifies the directory in which the Slice compiler generates Java source files. If not specified, the task uses ant's current working directory.	No
<code>translator</code>	Specifies the path name of the Slice compiler. If not specified, the task locates the Slice compiler in its execution environment as described for <code>slice2java</code> .	No

Several Slice compiler options must be defined as nested elements of the task:

- `define`
Defines a preprocessor macro. The element supports the attributes `name` and (optionally) `value`, as shown below:

XML

```
<define name="FOO">
<define name="BAR" value="5">
```

These definitions are equivalent to the command-line options `-DFOO` and `-DBAR=5`, respectively.

- `dict`
Generates a Freeze map. This element is equivalent to the `--dict` [command line option](#) and supports three attributes: `name`, `key`, and `value`.
- `dictindex`
Generates an index for a Freeze map. This element is equivalent to the `--dict-index` [command line option](#) and supports three attributes: `name`, `member`, and `casesensitive`.
- `fileset`
Specifies the set of Slice files to be compiled. Refer to the ant documentation of its `FileSet` type for more information.
- `includepath`
Specifies the include file search path for Slice files. In ant terminology, `includepath` is a *path-like structure*. Refer to the ant

documentation of its `Path` type for more information.

- `index`
Generates an index for a Freeze evictor. This element is equivalent to the `--index` command line option and supports four attributes: `name`, `type`, `member`, and `casesensitive`.
- `meta`
Defines a global metadata directive in each Slice file as well as in each included Slice file. The element supports the attributes `name` and `value`.

To enable the `Slice2FreezeJTask` in your ant project, define the following `taskdef` element in your project's build file:

XML

```
<taskdef name="slice2freezej" classname="Slice2FreezeJTask" />
```

This configuration assumes that `ant-ice.jar` is already present in ant's class path. Alternatively, you can specify the JAR explicitly as follows:

XML

```
<taskdef name="slice2freezej" classpath="/opt/Ice/lib/ant-ice.jar"
classname="Slice2FreezeJTask" />
```

Once activated, you can invoke the task to translate your Slice files. The example shown below is a simplified version of the ant project for the `library` demo:

XML

```
<target name="generate" depends="init">
  <mkdir dir="generated" />
  <slice2java outputdir="generated">
    <fileset dir="." includes="Library.ice" />
  </slice2java>
  <slice2freezej ice="on" outputdir="generated">
    <fileset dir="/opt/Ice/slice/Ice"
includes="BuiltinSequences.ice" />
    <fileset dir="." includes="Library.ice" />
    <dict name="StringIsbnSeqDict" key="string"
value="Ice::StringSeq" />
  </slice2freezej>
</target>
```

This invocation of the `slice2freezej` task enables the `ice` option because the generated Freeze map relies on a type that is defined in an Ice namespace and therefore loads the Slice file `BuiltinSequences.ice` directly.

The Freeze Map Class in Java

The class generated by `slice2freezej` implements the `Freeze.Map` interface, as shown below:

Java

```

package Freeze;

public interface Map<K, V> extends NavigableMap<K, V>
{
    void fastPut(K key, V value);
    void close();
    int closeAllIterators();
    void destroy();

    public interface EntryIterator<T> extends java.util.Iterator<T>
    {
        void close();
        void destroy(); // an alias for close
    }
}

```

The `Map` interface implements standard Java interfaces and provides nonstandard methods that improve efficiency and support database-oriented features. `Map` defines the following methods:

- `fastPut`
Inserts a new key-value pair. This method is more efficient than the standard `put` method because it avoids the overhead of reading and decoding the previous value associated with the key (if any).
- `close`
Closes the database associated with this map along with all open iterators. A map must be closed when it is no longer needed, either by closing the map directly or by closing the `Freeze Connection` object with which this map is associated.
- `closeAllIterators`
Closes all open iterators and returns the number of iterators that were closed. We discuss iterators in more detail in the next section.
- `destroy`
Removes the database associated with this map along with any indices.

`Map` inherits much of its functionality from the `Freeze.NavigableMap` interface, which derives from the standard Java interface `java.util.SortedMap` and also supports a subset of the `java.util.NavigableMap` interface from Java6:

Java

```

package Freeze;

public interface NavigableMap<K, V> extends java.util.SortedMap<K, V>
{
    java.util.Map.Entry<K, V> firstEntry();
    java.util.Map.Entry<K, V> lastEntry();

    java.util.Map.Entry<K, V> ceilingEntry(K key);
    java.util.Map.Entry<K, V> floorEntry(K key);
    java.util.Map.Entry<K, V> higherEntry(K key);
    java.util.Map.Entry<K, V> lowerEntry(K key);

    K ceilingKey(K key);
    K floorKey(K key);
    K higherKey(K key);
    K lowerKey(K key);

    java.util.Set<K> descendingKeySet();
    NavigableMap<K, V> descendingMap();

    NavigableMap<K, V> headMap(K toKey, boolean inclusive);
    NavigableMap<K, V> tailMap(K fromKey, boolean inclusive);
    NavigableMap<K, V> subMap(K fromKey, boolean fromInclusive,
                             K toKey, boolean toInclusive);

    java.util.Map.Entry<K, V> pollFirstEntry();
    java.util.Map.Entry<K, V> pollLastEntry();

    boolean fastRemove(K key);
}

```



The generated class does not implement `java.util.NavigableMap` because Freeze maps must remain compatible with Java5.

The `NavigableMap` interface provides a number of useful methods:

- `firstEntry`
`lastEntry`
Returns the first and last key-value pair, respectively.
- `ceilingEntry`
Returns the key-value pair associated with the least key greater than or equal to the given key, or null if there is no such key.
- `floorEntry`
Returns the key-value pair associated with the greatest key less than or equal to the given key, or null if there is no such key.
- `higherEntry`
Returns the key-value pair associated with the least key greater than the given key, or null if there is no such key.

- `lowerEntry`
Returns the key-value pair associated with the greatest key less than the given key, or null if there is no such key.
- `ceilingKey`
`floorKey`
`higherKey`
`lowerKey`
These methods have the same semantics as those described above, except they return only the key portion of the matching key-value pair or null if there is no such key.
- `descendingKeySet`
Returns a set representing a reverse-order view of the keys in this map.
- `descendingMap`
Returns a reverse-order view of the entries in this map.
- `headMap`
Returns a view of the portion of this map whose keys are less than (or equal to, if inclusive is true) the given key.
- `tailMap`
Returns a view of the portion of this map whose keys are greater than (or equal to, if inclusive is true) the given key.
- `subMap`
Returns a view of the portion of this map whose keys are within the given range.
- `pollFirstEntry`
`pollLastEntry`
Removes and returns the first and last key-value pair, respectively.
- `fastRemove`
Removes an existing key-value pair. As for `fastPut`, this method is a more efficient alternative to the standard `remove` method that returns true if a key-value pair was removed, or false if no match was found.



You must supply a [comparator](#) object when constructing the map in order to use many of these methods.

Note that `NavigableMap` also inherits overloaded methods named `headMap`, `tailMap`, and `subMap` from the `SortedMap` interface. These methods have the same semantics as the ones defined in `NavigableMap` but they omit the boolean arguments (refer to the JDK documentation for complete details). Although these methods are declared as returning a `SortedMap`, the actual type of the returned object is a `NavigableMap` that you can downcast if necessary.

There are some limitations in the sub maps returned by the `headMap`, `tailMap` and `subMap` methods:

- A new entry in the Freeze map cannot be added via a sub map, therefore calling `put` raises `UnsupportedOperationException`.
- An existing entry in the Freeze map cannot be removed via a sub map or iterator for a [secondary key](#).

Now let us examine the contents of the source file created by the example in the previous section:

Java

```
public class StringIntMap extends ...
    // implements Freeze.Map<String, Integer>
{
    public StringIntMap(
        Freeze.Connection connection,
        String dbName,
        boolean createDb,
        java.util.Comparator<String> comparator);

    public StringIntMap(
        Freeze.Connection connection,
        String dbName,
        boolean createDb);

    public StringIntMap(
        Freeze.Connection connection,
        String dbName);
}
```

`StringIntMap` derives from an internal Freeze base class that implements the interface `Freeze.Map<String, Integer>`. The generated class defines several overloaded constructors whose arguments are described below:

- `connection`
The Freeze connection object.
- `dbName`
The name of the database in which to store this map's persistent state. Note that a database can only contain the persistent state of one map type. Any attempt to instantiate maps of different types on the same database results in undefined behavior.
- `createDb`
A flag indicating whether the map should create the database if it does not already exist. If this argument is not specified, the default value is `true`.
- `comparator`
An object used to [compare the map's keys](#). If this argument is not specified, the default behavior compares the encoded form of the keys.

Why Comparators are Important

The constructor of a Freeze map optionally accepts a comparator object for the primary key and, if any [indices](#) are generated, a second object that supplies comparators for each of the index keys. If you do not supply a comparator, Freeze simply compares the encoded form of the keys. This default behavior is acceptable when comparing keys for equality, but using the encoded form cannot work reliably when comparing keys for ordering purposes.

For example, many of the methods in `NavigableMap` perform greater-than or less-than comparisons on keys, including `ceilingEntry`, `headMap`, and `tailMapForMEMBER`. All of these methods raise `UnsupportedOperationException` if you failed to supply a corresponding comparator when constructing the map. (The same applies to `NavigableMap` objects created for secondary keys.) In fact, the only `NavigableMap` methods that do *not* require a comparator are `firstEntry`, `lastEntry`, `pollFirstEntry`, `pollLastEntry`, and `fastRemove`.

As you can see, the functionality of a Freeze map is quite limited if no comparators are configured, therefore we recommend using

comparators at all times.

Using Iterators with Freeze Maps in Java

You can iterate over a Freeze map just as you can with any container that implements the `java.util.Map` interface. For example, the code below displays the key and value of each element:

```

Java
StringIntMap m = new StringIntMap(...);
java.util.Iterator<java.util.Map.Entry<String, Integer>> i =
m.entrySet().iterator();
while (i.hasNext()) {
    java.util.Map.Entry<String, Integer> e = i.next();
    System.out.println("Key: " + e.getKey());
    System.out.println("Value: " + e.getValue());
}

```

Generally speaking, a program should **close an iterator when it is no longer necessary**. (An iterator that is garbage collected without being closed emits a warning message.) However, an explicit close was not necessary in the preceding example because Freeze automatically closes a read-only iterator when it reaches the last element (a read-only iterator is one that is opened outside of any transaction). If instead our program had stopped using the iterator prior to reaching the last element, an explicit close would have been necessary:

```

Java
StringIntMap m = new StringIntMap(...);
java.util.Iterator<java.util.Map.Entry<String, Integer>> i =
m.entrySet().iterator();
while (i.hasNext()) {
    java.util.Map.Entry<String, Integer> e = i.next();
    System.out.println("Key: " + e.getKey());
    System.out.println("Value: " + e.getValue());
    if (e.getValue().intValue() == 5)
        break;
}
((Freeze.Map.EntryIterator)i).close();

```

Closing the iterator requires downcasting it to a Freeze-specific interface named `Freeze.Map.EntryIterator`. The definition of this interface was shown in the previous section.

Freeze maps also support the enhanced `for` loop functionality in Java5. Here is a simpler way to write our original program:

```

Java
StringIntMap m = new StringIntMap(...);
for (java.util.Map.Entry<String, Integer> e : m.entrySet()) {
    System.out.println("Key: " + e.getKey());
    System.out.println("Value: " + e.getValue());
}

```

As in the first example, Freeze automatically closes the iterator when no more elements are available. Although the enhanced `for` loop is convenient, it is not appropriate for all situations because the loop hides its iterator and therefore prevents the program from accessing the iterator in order to close it. In this case, you can use the traditional `while` loop instead of the `for` loop, or you can invoke `closeAllIterators` on the map as shown below:

Java

```
StringIntMap m = new StringIntMap(...);
for (java.util.Map.Entry<String, Integer> e : m.entrySet()) {
    System.out.println("Key: " + e.getKey());
    System.out.println("Value: " + e.getValue());
    if (e.getValue().intValue() == 5)
        break;
}
int num = m.closeAllIterators();
assert(num <= 1); // The iterator may already be closed.
```

The `closeAllIterators` method returns an integer representing the number of iterators that were actually closed. This value can be useful for diagnostic purposes, such as to assert that a program is correctly closing its iterators.

Generating Indices for Freeze Maps in Java

Using the `--dict-index` option to define an index for a secondary key causes `slice2freezej` to generate the following additional code in a Freeze map:

- A static nested class named `IndexComparators`, which allows you to supply a custom comparator object for each index in the map.
- An overloading of the map constructor that accepts an instance of `IndexComparators`.
- An overloading of the `recreate` method that accepts an instance of `IndexComparators`.
- Searching, counting, and range-searching methods for finding key-value pairs using the secondary key.

We discuss each of these additions in more detail below. In this discussion, *MEMBER* refers to the optional argument of the `--dict-index` option, and *MEMBER_TYPE* refers to the type of that member. As explained earlier, if *MEMBER* is not specified, `slice2freezej` creates an index for the value type of the map. The sample code presented in this section assumes we have generated a Freeze map using the following command:

Java

```
$ slice2freezej --dict StringIntMap,string,int --dict-index StringIntMap
```

By default, index keys are sorted using their binary Ice-encoded representation. This is an efficient sorting scheme but does not necessarily provide a meaningful traversal order for applications. You can choose a different order by providing an instance of the `IndexComparators` class to the map constructor. This class has a public data member holding a comparator (an instance of `java.util.Comparator<MEMBER_TYPE>`) for each index in the map. The class also provides an empty constructor as well as a convenience constructor that allows you to instantiate and initialize the object all at once. The name of each data member is `MEMBERComparator`. If *MEMBER* is not specified, the `IndexComparators` class has a single data member named `valueComparator`.



Much of the functionality offered by a map index requires that you provide a [custom comparator](#).

Here is the definition of `IndexComparators` for `StringIntMap`:

Java

```
public class StringIntMap ... {
    public static class IndexComparators {
        public IndexComparators() {}

        public IndexComparators(java.util.Comparator<Integer> valueComparator);

        public java.util.Comparator<Integer> valueComparator;
    }
    ...
}
```

To instantiate a Freeze map using your custom comparators, you must use the overloaded constructor that accepts the `IndexComparators` object. For our `StringIntMap`, this constructor has the following definition:

Java

```
public class StringIntMap ... {
    public StringIntMap(
        Freeze.Connection connection,
        String dbName,
        boolean createDb,
        java.util.Comparator<String> comparator,
        IndexComparators indexComparators);
    ...
}
```

Now we can instantiate our `StringIntMap` as follows:

Java

```
java.util.Comparator<String> myMainKeyComparator = ...;
StringIntMap.IndexComparators indexComparators =
new StringIntMap.IndexComparators();
indexComparators.valueComparator = ...;
StringIntMap m = new StringIntMap(connection, "stringIntMap", true,
myMainKeyComparator, indexComparators);
```

If you later need to change the index configuration of a Freeze map, you can use one of the `recreate` methods to update the database. Here are the definitions from `StringIntMap`:

Java

```

public class StringIntMap ... {
    public static void recreate(
        Freeze.Connection connection,
        String dbName,
        java.util.Comparator<String> comparator);

    public static void recreate(
        Freeze.Connection connection,
        String dbName,
        java.util.Comparator<String> comparator,
        IndexComparators indexComparators);

    ...
}

```

The first overloading is generated for every map, whereas the second overloading is only generated when the map has at least one index. As its name implies, the `recreate` method creates a new copy of the database. More specifically, the method removes any existing indices, copies every key-value pair to a temporary database, and finally replaces the old database with the new one. As a side-effect, this process also populates any remaining indices. The first overloading of `recreate` is useful when you have regenerated the map to remove the last index and wish to clean up the map's database state.

`slice2freezej` also generates a number of index-specific methods. The names of these methods incorporate the member name (*MEMBER*), or use `value` if *MEMBER* is not specified. In each method name, the value of *MEMBER* is used unchanged if it appears at the beginning of the method's name. Otherwise, if *MEMBER* is used elsewhere in the method name, its first letter is capitalized. The index methods are described below:

- ```
public Freeze.Map.EntryIterator<Map.Entry<K, V>>
 findByMEMBER(MEMBER_TYPE index)
```

```
public Freeze.Map.EntryIterator<Map.Entry<K, V>>
 findByMEMBER(MEMBER_TYPE index, boolean onlyDups)
```

Returns an iterator over elements of the Freeze map starting with an element whose index value matches the given index value. If there is no such element, the returned iterator is empty (`hasNext` always returns false). When the second parameter is true (or is not provided), the returned iterator provides only "duplicate" elements, that is, elements with the very same index value. Otherwise, the iterator sets a starting position in the map, and then provides elements until the end of the map, sorted according to the index comparator. Any attempt to modify the map via this iterator results in an `UnsupportedOperationException`.
- ```
public int MEMBERCount(MEMBER_TYPE index)
```

Returns the number of elements in the Freeze map whose index value matches the given index value.
- ```
public NavigableMap<MEMBER_TYPE, Set<Map.Entry<K, V>>>
 headMapForMEMBER(MEMBER_TYPE to, boolean inclusive)
```

```
public NavigableMap<MEMBER_TYPE, Set<Map.Entry<K, V>>>
 headMapForMEMBER(MEMBER_TYPE to)
```

Returns a view of the portion of the Freeze map whose keys are less than (or equal to, if `inclusive` is true) the given key. If `inclusive` is not specified, the method behaves as if `inclusive` is false.
- ```
public NavigableMap<MEMBER_TYPE, Set<Map.Entry<K, V>>>
    tailMapForMEMBER(MEMBER_TYPE from, boolean inclusive)
```
- ```
public NavigableMap<MEMBER_TYPE, Set<Map.Entry<K, V>>>}
```

```
tailMapForMEMBER(MEMBER_TYPE from)
```

Returns a view of the portion of the Freeze map whose keys are greater than (or equal to, if `inclusive` is true) the given key. If `inclusive` is not specified, the method behaves as if `inclusive` is true.

- ```
public NavigableMap<MEMBER_TYPE, Set<Map.Entry<K, V>>>
  subMapForMEMBER(MEMBER_TYPE from, boolean fromInclusive,
                  MEMBER_TYPE to, boolean toInclusive)
```

```
public NavigableMap<MEMBER_TYPE, Set<Map.Entry<K, V>>>
  subMapForMEMBER(MEMBER_TYPE from, MEMBER_TYPE to)
```

Returns a view of the portion of the Freeze map whose keys are within the given range. If `fromInclusive` and `toInclusive` are not specified, the method behaves as if `fromInclusive` is true and `toInclusive` is false.

- ```
public NavigableMap<MEMBER_TYPE, Set<Map.Entry<K, V>>>
 mapForMEMBER()
```

Returns a view of the entire Freeze map ordered by the index key.

For the methods returning a `NavigableMap`, the key type is the secondary key type and the value is the set of matching key-value pairs from the Freeze map. (For the sake of readability, we have omitted the `java.util` prefix from `Set` and `Map.Entry`.) In other words, the returned map is a mapping of the secondary key to all of the entries whose value contains the same key. Any attempt to add, remove, or modify an element via a sub map view or an iterator of a sub map view results in an `UnsupportedOperationException`.

Note that iterators returned by the `findByMEMBER` methods, as well as those created for sub map views, [may need to be closed explicitly](#), just like iterators obtained for the main Freeze map.

Here are the definitions of the index methods for `StringIntMap`:

### Java

```

public Freeze.Map.EntryIterator<Map.Entry<String, Integer>>
findByValue(Integer index);

public Freeze.Map.EntryIterator<Map.Entry<String, Integer>>
findByValue(Integer index, boolean onlyDups);

public int valueCount(Integer index);

public NavigableMap<Integer, Set<Map.Entry<String, Integer>>>
headMapForValue(Integer to, boolean inclusive);
public NavigableMap<Integer, Set<Map.Entry<String, Integer>>>
headMapForValue(Integer to);

public NavigableMap<Integer, Set<Map.Entry<String, Integer>>>
tailMapForValue(Integer from, boolean inclusive);
public NavigableMap<Integer, Set<Map.Entry<String, Integer>>>
tailMapForValue(Integer from);

public NavigableMap<Integer, Set<Map.Entry<String, Integer>>>
subMapForValue(Integer from, boolean fromInclusive,
 Integer to, boolean toInclusive);
public NavigableMap<Integer, Set<Map.Entry<String, Integer>>>
subMapForValue(Integer from, Integer to);

public NavigableMap<Integer, Set<Map.Entry<String, Integer>>>
mapForValue();

```

### Sample Freeze Map Program in Java

The program below demonstrates how to use a `StringIntMap` to store `<string, int>` pairs in a database. You will notice that there are no explicit read or write operations called by the program; instead, simply using the map has the side effect of accessing the database.

### Java

```

public class Client
{
 public static void
 main(String[] args)
 {
 // Initialize the Communicator.
 //
 Ice.Communicator communicator = Ice.Util.initialize(args);

 // Create a Freeze database connection.
 //
 Freeze.Connection connection =
 Freeze.Util.createConnection(communicator, "db");
 }
}

```

```
// Instantiate the map.
//
StringIntMap map = new StringIntMap(connection, "simple", true);

// Clear the map.
//
map.clear();

int i;

// Populate the map.
//
for (i = 0; i < 26; i++) {
 final char[] ch = { (char)('a' + i) };
 map.put(new String(ch), i);
}

// Iterate over the map and change the values.
//
for (java.util.Map.Entry<String, Integer> e : map.entrySet()) {
 Integer in = e.getValue();
 e.setValue(in.intValue() + 1);
}

// Find and erase the last element.
//
boolean b;
b = map.containsKey("z");
assert(b);
b = map.fastRemove("z");
assert(b);

// Clean up.
//
map.close();
connection.close();
communicator.destroy();

System.exit(0);
```



```

 }
}

```

Prior to instantiating a Freeze map, the application must connect to a Berkeley DB database environment:

#### Java

```

Freeze.Connection connection =
Freeze.Util.createConnection(communicator, "db");

```

The second argument is the name of a Berkeley DB database environment; by default, this is also the file system directory in which Berkeley DB creates all database and administrative files.

Next, the code instantiates the `StringIntMap` on the connection. The constructor's second argument supplies the name of the database file, and the third argument indicates that the database should be created if it does not exist:

#### Java

```

StringIntMap map = new StringIntMap(connection, "simple", true);

```

After instantiating the map, we clear it to make sure it is empty in case the program is run more than once:

#### Java

```

map.clear();

```

We populate the map, using a single-character string as the key. As with `java.util.Map`, the key and value types must be Java objects but the compiler takes care of autoboxing the integer argument:

#### Java

```

for (i = 0; i < 26; i++) {
 final char[] ch = { (char)('a' + i) };
 map.put(new String(ch), i);
}

```

Iterating over the map is no different from iterating over any other map that implements the `java.util.Map` interface:

#### Java

```

for (java.util.Map.Entry<String, Integer> e : map.entrySet()) {
 Integer in = e.getValue();
 e.setValue(in.intValue() + 1);
}

```

Next, the program verifies that an element exists with key `z`, and then removes it using `fastRemove`:

**Java**

```
b = map.containsKey("z");
assert(b);
b = map.fastRemove("z");
assert(b);
```

Finally, the program closes the map and its connection.

**Java**

```
map.close();
connection.close();
```

**See Also**

- [Using the Slice Compilers](#)
- [Using the Slice Compiler for Java](#)
- [Freeze Map Concepts](#)

## Using a Freeze Map in the File System Server

We can use a Freeze map to add persistence to the file system server, and we'll present implementations in both C++ and Java. However, a [Freeze evictor](#) is often a better choice for applications (such as the file system server) in which the persistent value is an Ice object.

In general, incorporating a Freeze map into your application requires the following steps:

1. Evaluate your existing Slice definitions for suitable key and value types.
2. If no suitable key or value types are found, define new (possibly derived) types that capture your persistent state requirements. Consider placing these definitions in a separate file: these types are only used by the server for persistence, and therefore do not need to appear in the "public" definitions required by clients. Also consider placing your persistent types in a separate module to avoid name clashes.
3. Generate a Freeze map for your persistent types using the Freeze compiler.
4. Use the Freeze map in your operation implementations.

### Choosing Key and Value Types for the File System

Our goal is to implement the file system using Freeze maps for all persistent storage, including files and their contents. There are various options for how to implement the server. For this example, the server is stateless; whenever a client invokes an operation, the server accesses the database to satisfy the request. Implementing the server in this way has the advantage that it scales very well: we do not need a separate servant for each node; instead two [default servants](#), one for directories and one for files, are sufficient. This keeps the memory requirements of the server to a minimum and also allows us to rely on the database for transactions and locking. (This is a very common implementation technique for servers that act as a front end to a database: the server is a simple facade that implements each operation by accessing the database.)

Our first step is to select the Slice types we will use for the key and value types for our maps. For each file, we need to store the name of the file, its parent directory, and the contents of the file. For directories, we also store the name and parent directory, as well as a dictionary that keeps track of the subdirectories and files in that directory. This leads to Slice definitions (in file `FilesystemDB.ice`) as follows:

```

 Slice
#include <Filesystem.ice>
#include <Ice/Identity.ice>

module FilesystemDB {
 struct FileEntry {
 string name;
 Ice::Identity parent;
 Filesystem::Lines text;
 };

 dictionary<string, Filesystem::NodeDesc> StringNodeDescDict;

 struct DirectoryEntry {
 string name;
 Ice::Identity parent;
 StringNodeDescDict nodes;
 };
};

```

Note that the definitions are placed into a separate module, so they do not affect the existing definitions of the non-persistent version of the application. For reference, here is the definition of `NodeDesc` once more:

**Slice**

```
module Filesystem {
 // ...

 enum NodeType { DirType, FileType };

 struct NodeDesc {
 string name;
 NodeType type;
 Node* proxy;
 };

 // ...
};
```

To store the persistent state for the file system, we use two Freeze maps: one map for files and one map for directories. For files, we map the identity of the file to its corresponding `FileEntry` structure and, similarly, for directories, we map the identity of the directory to its corresponding `DirectoryEntry` structure.

When a request arrives from a client, the object identity is available in the server. The server uses the identity to retrieve the state of the target node for the request from the database and act on that state accordingly.

**Topics**

- [Adding a Freeze Map to the C++ File System Server](#)
- [Adding a Freeze Map to the Java File System Server](#)

**See Also**

- [Default Servants](#)
- [Freeze Evictors](#)

## Adding a Freeze Map to the C++ File System Server

Here we present a C++ implementation of the [file system server](#).

On this page:

- [Generating the File System Maps in C++](#)
- [The Server Main Program in C++](#)
- [The Servant Class Definitions in C++](#)
- [Implementing `FileI` with a Freeze Map in C++](#)
- [Implementing `DirectoryI` with a Freeze Map in C++](#)

### Generating the File System Maps in C++

Now that we have selected our key and value types, we can generate the maps as follows:

```
$ slice2freeze -I$(ICE_HOME)/slice -I. --ice --dict \
 FilesystemDB::IdentityFileEntryMap,Ice::Identity,\
 FilesystemDB::FileEntry \
 IdentityFileEntryMap FilesystemDB.ice \
 $(ICE_HOME)/slice/Ice/Identity.ice
$ slice2freeze -I$(ICE_HOME)/slice -I. --ice --dict \
 FilesystemDB::IdentityDirectoryEntryMap,Ice::Identity,\
 FilesystemDB::DirectoryEntry \
 IdentityDirectoryEntryMap FilesystemDB.ice \
 $(ICE_HOME)/slice/Ice/Identity.ice
```

The resulting map classes are named `IdentityFileEntryMap` and `IdentityDirectoryEntryMap`.

### The Server Main Program in C++

The server's main program is very simple:

```
C++
```

```
#include <FilesystemI.h>
#include <IdentityFileEntryMap.h>
#include <IdentityDirectoryEntryMap.h>
#include <Ice/Application.h>
#include <Freeze/Freeze.h>

using namespace std;
using namespace Filesystem;
using namespace FilesystemDB;

class FilesystemApp : public virtual Ice::Application
{
public:

 FilesystemApp(const string& envName)
 : _envName(envName)
 {
 }
}
```

```

virtual int run(int, char*[])
{
 shutdownOnInterrupt();

 Ice::ObjectAdapterPtr adapter =
 communicator()->createObjectAdapter("MapFilesystem");

 const Freeze::ConnectionPtr connection(
 Freeze::createConnection(communicator(), _envName));

 const IdentityFileEntryMap fileDB(connection, FileI::filesDB());
 const IdentityDirectoryEntryMap dirDB(
 connection,
 DirectoryI::directoriesDB());

 adapter->addDefaultServant(new FileI(communicator(), _envName),
"file");
 adapter->addDefaultServant(new DirectoryI(communicator(), _envName), "");

 adapter->activate();

 communicator()->waitForShutdown();

 if(interrupted())
 cerr << appName()
<< ": received signal, shutting down" << endl;

 return 0;
}

private:

 string _envName;
};

int
main(int argc, char* argv[])
{
 FilesystemApp app("db");

```

```

 return app.main(argc, argv, "config.server");
}

```

Let us examine the code in detail. First, we are now including `IdentityFileEntry.h` and `IdentityDirectoryEntry.h`. These header files includes all of the other Freeze (and Ice) header files we need.

Next, we define the class `FilesystemApp` as a subclass of `Ice::Application`, and provide a constructor taking a string argument:

```

C++
FilesystemApp(const string& envName)
 : _envName(envName) {}

```

The string argument represents the name of the database environment, and is saved for later use in `run`.

The interesting part of `run` are the few lines of code that create the database connection and the two maps that store files and directories, plus the code to add the two default servants:

```

C++
const Freeze::ConnectionPtr connection(
 Freeze::createConnection(communicator(), _envName));

const IdentityFileEntryMap fileDB(connection, FileI::filesDB());
const IdentityDirectoryEntryMap dirDB(
 connection,
 DirectoryI::directoriesDB());

adapter->addDefaultServant(new FileI(communicator(), _envName),
 "file");
adapter->addDefaultServant(new DirectoryI(communicator(), _envName), "");

```

`run` keeps the database connection open for the duration of the program for performance reasons. As we will see shortly, individual operation implementations will use their own connections; however, it is substantially cheaper to create second (and subsequent connections) than it is to create the first connection.

For the default servants, we use `file` as the category for files. For directories, we use the empty default category.

### The Servant Class Definitions in C++

The class definition for `FileI` is very simple:

**C++**

```

namespace Filesystem {
 class FileI : public File {
 public:
 FileI(const Ice::CommunicatorPtr& communicator,
 const std::string& envName);

 // Slice operations...

 static std::string filesDB();

 private:
 void halt(const Freeze::DatabaseException& ex) const;

 const Ice::CommunicatorPtr _communicator;
 const std::string _envName;
 };
}

```

The `FileI` class stores the communicator and the environment name. These members are initialized by the constructor. The `filesDB` static member function returns the name of the file map, and the `halt` member function is used to stop the server if it encounters a catastrophic error.

The `DirectoryI` class looks very much the same, also storing the communicator and environment name. The `directoriesDB` static member function returns the name of the directory map.

**C++**

```

namespace Filesystem {
 class DirectoryI : public Directory {
 public:
 DirectoryI(const Ice::CommunicatorPtr& communicator,
 const std::string& envName);

 // Slice operations...

 static std::string directoriesDB();

 private:
 void halt(const Freeze::DatabaseException& ex) const;

 const Ice::CommunicatorPtr _communicator;
 const std::string _envName;
 };
}

```

**Implementing `FileI` with a Freeze Map in C++**



The `FileI` constructor and the `filesDB` and `halt` member functions have trivial implementations:

```

C++

FileI::FileI(const Ice::CommunicatorPtr& communicator,
 const string& envName)
 : _communicator(communicator), _envName(envName)
{
}

string
FileI::filesDB()
{
 return "files";
}

void
FileI::halt(const Freeze::DatabaseException& ex) const
{
 Ice::Error error(_communicator->getLogger());
 error << "fatal exception: " << ex
 << "\n*** Aborting application ***";

 abort();
}

```

The Slice operations all follow the same implementation strategy: we create a database connection and the file map and place the body of the operation into an infinite loop:

**C++**

```

string
FileI::someOperation(/* ... */ const Ice::Current& c)
{
 const Freeze::ConnectionPtr connection(
 Freeze::createConnection(_communicator, _envName));
 IdentityFileEntryMap fileDB(connection, filesDB());

 for (;;) {
 try {

 // Operation implementation here...

 } catch (const Freeze::DeadlockException&) {
 continue;
 } catch (const Freeze::DatabaseException& ex) {
 halt(ex);
 }
 }
}

```

Each operation creates its own database connection and map for concurrency reasons: the database takes care of all the necessary locking, so there is no need for any other synchronization in the server. If the database detects a deadlock, the code handles the corresponding `DeadlockException` and simply tries again until the operation eventually succeeds; any other database exception indicates that something has gone seriously wrong and terminates the server.

Here is the implementation of the `name` method:

**C++**

```

string
FileI::name(const Ice::Current& c)
{
 const Freeze::ConnectionPtr connection(
 Freeze::createConnection(_communicator, _envName));
 IdentityFileEntryMap fileDB(connection, filesDB());

 for (;;) {
 try {
 IdentityFileEntryMap::iterator p = fileDB.find(c.id);
 if (p == fileDB.end()) {
 throw Ice::ObjectNotExistException(__FILE__, __LINE__);
 }
 return p->second.name;
 } catch (const Freeze::DeadlockException&) {
 continue;
 } catch (const Freeze::DatabaseException& ex) {
 halt(ex);
 }
 }
}

```

The implementation could hardly be simpler: the default servant uses the identity in the `Current` object to index into the file map. If a record with this identity exists, it returns the name of the file as stored in the `FileEntry` structure in the map. Otherwise, if no such entry exists, it throws `ObjectNotExistException`. This happens if the file existed at some time in the past but has since been destroyed.

The `read` implementation is almost identical. It returns the text that is stored by the `FileEntry`:

**C++**

```

Lines
FileI::read(const Ice::Current& c)
{
 const Freeze::ConnectionPtr connection(
 Freeze::createConnection(_communicator, _envName));
 IdentityFileEntryMap fileDB(connection, filesDB());

 for (;;) {
 try {
 IdentityFileEntryMap::iterator p = fileDB.find(c.id);
 if (p == fileDB.end()) {
 throw Ice::ObjectNotExistException(__FILE__, __LINE__);
 }
 return p->second.text;
 } catch (const Freeze::DeadlockException&) {
 continue;
 } catch (const Freeze::DatabaseException& ex) {
 halt(ex);
 }
 }
}

```

The `write` implementation updates the file contents and calls `set` on the iterator to update the map with the new contents:

**C++**

```

void
FileI::write(const Filesystem::Lines& text, const Ice::Current& c)
{
 const Freeze::ConnectionPtr connection(
 Freeze::createConnection(_communicator, _envName));
 IdentityFileEntryMap fileDB(connection, filesDB());

 for (;;) {
 try {
 IdentityFileEntryMap::iterator p = fileDB.find(c.id);
 if (p == fileDB.end()) {
 throw Ice::ObjectNotExistException(__FILE__, __LINE__);
 }
 FileEntry entry = p->second;
 entry.text = text;
 p.set(entry);
 break;
 } catch (const Freeze::DeadlockException&) {
 continue;
 } catch (const Freeze::DatabaseException& ex) {
 halt(ex);
 }
 }
}

```

Finally, the `destroy` implementation for files must update two maps: it needs to remove its own entry in the file map as well as update the `nodes` map in the parent to remove itself from the parent's map of children. This raises a potential problem: if one update succeeds but the other one fails, we end up with an inconsistent file system: either the parent still has an entry to a non-existent file, or the parent lacks an entry to a file that still exists.

To make sure that the two updates happen atomically, `destroy` performs them in a transaction:

**C++**

```

void
FileI::destroy(const Ice::Current& c)
{
 const Freeze::ConnectionPtr connection(
 Freeze::createConnection(_communicator, _envName));
 IdentityFileEntryMap fileDB(connection, filesDB());
 IdentityDirectoryEntryMap dirDB(connection,
DirectoryI::directoriesDB());

 for (;;) {
 try {
 Freeze::TransactionHolder txn(connection);

 IdentityFileEntryMap::iterator p = fileDB.find(c.id);
 if (p == fileDB.end()) {
 throw Ice::ObjectNotExistException(__FILE__, __LINE__);
 }
 FileEntry entry = p->second;

 IdentityDirectoryEntryMap::iterator pp =
dirDB.find(entry.parent);
 if (pp == dirDB.end()) {
 halt(Freeze::DatabaseException(
 __FILE__, __LINE__,
 "consistency error: file without parent"));
 }

 DirectoryEntry dirEntry = pp->second;
 dirEntry.nodes.erase(entry.name);
 pp.set(dirEntry);

 fileDB.erase(p);
 txn.commit();
 break;
 } catch (const Freeze::DeadlockException&) {
 continue;
 } catch (const Freeze::DatabaseException& ex) {
 halt(ex);
 }
 }
}

```

As you can see, the code first establishes a transaction and then locates the file in the parent directory's map of nodes. After removing the file from the parent, the code updates the parent's persistent state by calling `set` on the parent iterator and then removes the file from the file map before committing the transaction.

**Implementing DirectoryI with a Freeze Map in C++**

The `DirectoryI::directoriesDB` implementation returns the string `directories`, and the `halt` implementation is the same as for `FileI`, so we do not show them here.

Turning to the constructor, we must cater for two different scenarios:

- The server is started with a database that already contains a number of nodes.
- The server is started for the very first time with an empty database.

This means that the root directory (which must always exist) may or may not be present in the database. Accordingly, the constructor looks for the root directory (with the fixed identity `RootDir`); if the root directory does not exist in the database, it creates it:

```
C++
```

```
DirectoryI::DirectoryI(const Ice::CommunicatorPtr& communicator,
const string& envName)
 : _communicator(communicator), _envName(envName)
{
 const Freeze::ConnectionPtr connection =
 Freeze::createConnection(_communicator, _envName);
 IdentityDirectoryEntryMap dirDB(connection, directoriesDB());

 for (;;) {
 try {
 Ice::Identity rootId;
 rootId.name = "RootDir";
 IdentityDirectoryEntryMap::const_iterator p =
dirDB.find(rootId);
 if (p == dirDB.end()) {
 DirectoryEntry d;
 d.name = "/";
 dirDB.put(make_pair(rootId, d));
 }
 break;
 } catch (const Freeze::DeadlockException&) {
 continue;
 } catch (const Freeze::DatabaseException& ex) {
 halt(ex);
 }
 }
}
```

Next, let us examine the implementation of `createDirectory`. Similar to the `FileI::destroy` operation, `createDirectory` must update both the parent's nodes map and create a new entry in the directory map. These updates must happen atomically, so we perform them in a separate transaction:

```
C++
```

```
DirectoryPrx
DirectoryI::createDirectory(const string& name, const Ice::Current& c)
{
 const Freeze::ConnectionPtr connection(
 Freeze::createConnection(_communicator, _envName));
```

```

IdentityDirectoryEntryMap directoryDB(connection, directoriesDB());

for (;;) {
 try {
 Freeze::TransactionHolder txn(connection);

 IdentityDirectoryEntryMap::iterator p =
 directoryDB.find(c.id);
 if (p == directoryDB.end()) {
 throw Ice::ObjectNotExistException(__FILE__, __LINE__);
 }

 DirectoryEntry entry = p->second;
 if (name.empty()
|| entry.nodes.find(name) != entry.nodes.end()) {
 throw NameInUse(name);
 }

 DirectoryEntry d;
 d.name = name;
 d.parent = c.id;

 Ice::Identity id;
 id.name = IceUtil::generateUUID();
 DirectoryPrx proxy = DirectoryPrx::uncheckedCast(c.adapter-
>createProxy(id));

 NodeDesc nd;
 nd.name = name;
 nd.type = DirType;
 nd.proxy = proxy;
 entry.nodes.insert(make_pair(name, nd));

 p.set(entry);
 directoryDB.put(make_pair(id, d));

 txn.commit();

 return proxy;
 } catch (const Freeze::DeadlockException&) {
 continue;
 } catch (const Freeze::DatabaseException& ex) {
 halt(ex);
 }
}

```



```

 }
}

```

After establishing the transaction, the code ensures that the directory does not already contain an entry with the same name and then initializes a new `DirectoryEntry`, setting the name to the name of the new directory, and the parent to its own identity. The identity of the new directory is a UUID, which ensures that all directories have unique identities. In addition, the UUID prevents the [accidental rebirth](#) of a file or directory in the future.

The code then initializes a new `NodeDesc` structure with the details of the new directory and, finally, updates its own map of children as well as adding the new directory to the map of directories before committing the transaction.

The `createFile` implementation is almost identical, so we do not show it here. Similarly, the `name` and `destroy` implementations are almost identical to the ones for `FileI`, so let us move to `list`:

```

C++
NodeDescSeq
DirectoryI::list(const Ice::Current& c)
{
 const Freeze::ConnectionPtr connection(
 Freeze::createConnection(_communicator, _envName));
 IdentityDirectoryEntryMap directoryDB(connection, directoriesDB());

 for (;;) {
 try {
 IdentityDirectoryEntryMap::iterator p =
directoryDB.find(c.id);
 if (p == directoryDB.end()) {
 throw Ice::ObjectNotExistException(__FILE__, __LINE__);
 }
 NodeDescSeq result;
 for (StringNodeDescDict::const_iterator q =
p->second.nodes.begin();
 q != p->second.nodes.end(); ++q) {
 result.push_back(q->second);
 }
 return result;
 } catch (const Freeze::DeadlockException&) {
 continue;
 } catch (const Freeze::DatabaseException& ex) {
 halt(ex);
 }
 }
}

```

Again, the code is very simple: it iterates over the `nodes` map, adding each `NodeDesc` structure to the returned sequence.

The `find` implementation is even simpler, so we do not show it here.

See Also

- [Freeze Maps](#)

- [Object Identity and Uniqueness](#)
- [The Current Object](#)

## Adding a Freeze Map to the Java File System Server

Here we present a Java implementation of the [file system server](#).

On this page:

- [Generating the File System Maps in Java](#)
- [The Server Main Program in Java](#)
- [Implementing `FileI` with a Freeze Map in Java](#)
- [Implementing `DirectoryI` with a Freeze Map in Java](#)

### Generating the File System Maps in Java

Now that we have selected our key and value types, we can generate the maps as follows:

```
$ slice2freezej -I$(ICE_HOME)/slice -I. --ice --dict \
 FilesystemDB.IdentityFileEntryMap,Ice::Identity,\
 FilesystemDB::FileEntry \
 IdentityFileEntryMap FilesystemDB.ice \
 $(ICE_HOME)/slice/Ice/Identity.ice
$ slice2freezej -I$(ICE_HOME)/slice -I. --ice --dict \
 FilesystemDB.IdentityDirectoryEntryMap,Ice::Identity,\
 FilesystemDB::DirectoryEntry \
 IdentityDirectoryEntryMap FilesystemDB.ice \
 $(ICE_HOME)/slice/Ice/Identity.ice
```

The resulting map classes are named `IdentityFileEntryMap` and `IdentityDirectoryEntryMap`.

### The Server Main Program in Java

The server's main program is very simple:

```
Java
```

```
import Filesystem.*;
import FilesystemDB.*;

public class Server extends Ice.Application
{
 public
 Server(String envName)
 {
 _envName = envName;
 }

 public int
 run(String[] args)
 {
 Ice.ObjectAdapter adapter =
 communicator().createObjectAdapter("MapFilesystem");

 Freeze.Connection connection = null;
 try {
```

```

 connection = Freeze.Util.createConnection(communicator(),
 _envName);
 IdentityFileEntryMap fileDB =
new IdentityFileEntryMap(connection, FileI.filesDB(), true);
 IdentityDirectoryEntryMap dirDB =
 new IdentityDirectoryEntryMap(connection, DirectoryI.di
rectoriesDB(), true);

 adapter.addDefaultServant(new FileI(communicator(), _envNam
e), "file");
 adapter.addDefaultServant(new DirectoryI(communicator(), _e
nvName), "");

 adapter.activate();

 communicator().waitForShutdown();
 } finally {
 connection.close();
 }

 return 0;
}

public static void
main(String[] args)
{
 Server app = new Server("db");
 app.main("MapServer", args, "config.server");
 System.exit(0);
}

```

```
private String _envName;
}
```

First, we import the `Filesystem` and `FilesystemDB` packages.

Next, we define the class `FilesystemApp` as a subclass of `Ice.Application`, and provide a constructor taking a string argument:

```
Java
```

```
FilesystemApp(const string& envName)
 : _envName(envName) {}
```

The string argument represents the name of the database environment, and is saved for later use in `run`.

The interesting part of `run` are the few lines of code that create the database connection and the two maps that store files and directories, plus the code to add the two default servants:

```
Java
```

```
 connection = Freeze.Util.createConnection(communicator(),
 _envName);
 IdentityFileEntryMap fileDB =
 new IdentityFileEntryMap(connection, FileI.filesDB(), t
 rue);
 IdentityDirectoryEntryMap dirDB =
 new IdentityDirectoryEntryMap(connection, DirectoryI.di
 rectoriesDB(), true);

 adapter.addDefaultServant(new FileI(communicator(), _envNam
 e), "file");
 adapter.addDefaultServant(new DirectoryI(communicator(), _e
 nvName), "");
```

`run` keeps the database connection open for the duration of the program for performance reasons. As we will see shortly, individual operation implementations will use their own connections; however, it is substantially cheaper to create second (and subsequent connections) than it is to create the first connection.

For the default servants, we use `file` as the category for files. For directories, we use the empty default category.

### Implementing `FileI` with a Freeze Map in Java

The class definition for `FileI` is very simple:

## Java

```

public class FileI extends _FileDisp
{
 public
 FileI(Ice.Communicator communicator, String envName)
 {
 _communicator = communicator;
 _envName = envName;
 }

 // Slice operations...

 public static String
 filesDB()
 {
 return "files";
 }

 private void
 halt(Freeze.DatabaseException e)
 {
 java.io.StringWriter sw = new java.io.StringWriter();
 java.io.PrintWriter pw = new java.io.PrintWriter(sw);
 e.printStackTrace(pw);
 pw.flush();
 _communicator.getLogger().error(
 "fatal database error\n" + sw.toString() +
 "\n*** Halting JVM ***");
 Runtime.getRuntime().halt(1);
 }

 private Ice.Communicator _communicator;
 private String _envName;
}

```

The `FileI` class stores the communicator and the environment name. These members are initialized by the constructor. The `filesDB` static method returns the name of the file map, and the `halt` member function is used to stop the server if it encounters a catastrophic error.

The Slice operations all follow the same implementation strategy: we create a database connection and the file map and place the body of the operation into an infinite loop:

## Java

```

public String
someOperation(/* ... */ Ice.Current c)
{
 Freeze.Connection connection =
Freeze.Util.createConnection(_communicator, _envName);
 try {
 IdentityFileEntryMap fileDB =
new IdentityFileEntryMap(connection, filesDB());

 for (;;) {
 try {

 // Operation implementation here...

 } catch (Freeze.DeadlockException ex) {
 continue;
 } catch (Freeze.DatabaseException ex) {
 halt(ex);
 }
 }
 } finally {
 connection.close();
 }
}

```

Each operation creates its own database connection and map for concurrency reasons: the database takes care of all the necessary locking, so there is no need for any other synchronization in the server. If the database detects a deadlock, the code handles the corresponding `DeadlockException` and simply tries again until the operation eventually succeeds; any other database exception indicates that something has gone seriously wrong and terminates the server.

Here is the implementation of the `name` method:

## Java

```

public String
name(Ice.Current c)
{
 Freeze.Connection connection =
Freeze.Util.createConnection(_communicator, _envName);
 try
 {
 IdentityFileEntryMap fileDB =
new IdentityFileEntryMap(connection, filesDB());

 for (;;) {
 try {
 FileEntry entry = fileDB.get(c.id);
 if (entry == null) {
 throw new Ice.ObjectNotExistException();
 }
 return entry.name;
 } catch (Freeze.DeadlockException ex) {
 continue;
 } catch (Freeze.DatabaseException ex) {
 halt(ex);
 }
 }
 } finally {
 connection.close();
 }
}

```

The implementation could hardly be simpler: the default servant uses the identity in the `Current` object to index into the file map. If a record with this identity exists, it returns the name of the file as stored in the `FileEntry` structure in the map. Otherwise, if no such entry exists, it throws `ObjectNotExistException`. This happens if the file existed at some time in the past but has since been destroyed.

The `read` implementation is almost identical. It returns the text that is stored by the `FileEntry`:



## Java

```

public String[]
read(Ice.Current c)
{
 Freeze.Connection connection =
 Freeze.Util.createConnection(_communicator, _envName);
 try {
 IdentityFileEntryMap fileDB = new
IdentityFileEntryMap(connection, filesDB());

 for (;;) {
 try {
 FileEntry entry = fileDB.get(c.id);
 if (entry == null) {
 throw new Ice.ObjectNotExistException();
 }
 return entry.text;
 } catch (Freeze.DeadlockException ex) {
 continue;
 } catch (Freeze.DatabaseException ex) {
 halt(ex);
 }
 }
 } finally {
 connection.close();
 }
}

```

The `write` implementation updates the file contents and calls `put` on the iterator to update the map with the new contents:

## Java

```

public void
write(String[] text, Ice.Current c)
 throws GenericError
{
 Freeze.Connection connection =
Freeze.Util.createConnection(_communicator, _envName);
 try {
 IdentityFileEntryMap fileDB =
new IdentityFileEntryMap(connection, filesDB());

 for (;;) {
 try {
 FileEntry entry = fileDB.get(c.id);
 if (entry == null) {
 throw new Ice.ObjectNotExistException();
 }
 entry.text = text;
 fileDB.put(c.id, entry);
 break;
 } catch (Freeze.DeadlockException ex) {
 continue;
 } catch (Freeze.DatabaseException ex) {
 halt(ex);
 }
 }
 } finally {
 connection.close();
 }
}

```

Finally, the `destroy` implementation for files must update two maps: it needs to remove its own entry in the file map as well as update the `nodes` map in the parent to remove itself from the parent's map of children. This raises a potential problem: if one update succeeds but the other one fails, we end up with an inconsistent file system: either the parent still has an entry to a non-existent file, or the parent lacks an entry to a file that still exists.

To make sure that the two updates happen atomically, `destroy` performs them in a transaction:

## Java

```

public void
destroy(Ice.Current c)
 throws PermissionDenied
{
 Freeze.Connection connection =
Freeze.Util.createConnection(_communicator, _envName);
 try {
 IdentityFileEntryMap fileDB =

```

```

new IdentityFileEntryMap(connection, filesDB());
 IdentityDirectoryEntryMap dirDB =
 new IdentityDirectoryEntryMap(connection, DirectoryI.directoriesDB());

 for (;;) {
 Freeze.Transaction txn = null;
 try {
 txn = connection.beginTransaction();

 FileEntry entry = fileDB.get(c.id);
 if (entry == null) {
 throw new Ice.ObjectNotExistException();
 }

 DirectoryEntry dirEntry = (DirectoryEntry)dirDB.get
(
 entry.parent);

 if (dirEntry == null) {
 halt(new Freeze.DatabaseException(
"consistency error: file without parent"));
 }

 dirEntry.nodes.remove(entry.name);
 dirDB.put(entry.parent, dirEntry);

 fileDB.remove(c.id);

 txn.commit();
 txn = null;
 break;
 } catch (Freeze.DeadlockException ex) {
 continue;
 } catch (Freeze.DatabaseException ex) {
 halt(ex);
 } finally {
 if (txn != null) {
 txn.rollback();
 }
 }
 }
}
finally
{
 connection.close();
}

```

```
}
}
```

As you can see, the code first establishes a transaction and then locates the file in the parent directory's map of nodes. After removing the file from the parent, the code updates the parent's persistent state by calling `put` on the parent iterator and then removes the file from the file map before committing the transaction.

### Implementing `DirectoryI` with a Freeze Map in Java

The `DirectoryI.directoriesDB` implementation returns the string `directories`, and the `halt` implementation is the same as for `FileI`, so we do not show them here.

Turning to the constructor, we must cater for two different scenarios:

- The server is started with a database that already contains a number of nodes.
- The server is started for the very first time with an empty database.

This means that the root directory (which must always exist) may or may not be present in the database. Accordingly, the constructor looks for the root directory (with the fixed identity `RootDir`); if the root directory does not exist in the database, it creates it:

## Java

```

public
DirectoryI(Ice.Communicator communicator, String envName)
{
 _communicator = communicator;
 _envName = envName;

 Freeze.Connection connection =
Freeze.Util.createConnection(_communicator, _envName);
 try {
 IdentityDirectoryEntryMap dirDB =
 new IdentityDirectoryEntryMap(connection,
directoriesDB());

 for (;;) {
 try {
 Ice.Identity rootId =
new Ice.Identity("RootDir", "");
 DirectoryEntry entry = dirDB.get(rootId);
 if (entry == null) {
 dirDB.put(rootId, new DirectoryEntry("/",
new Ice.Identity("", ""), null));
 }
 break;
 } catch (Freeze.DeadlockException ex) {
 continue;
 } catch (Freeze.DatabaseException ex) {
 halt(ex);
 }
 }
 } finally {
 connection.close();
 }
}

```

Next, let us examine the implementation of `createDirectory`. Similar to the `FileI::destroy` operation, `createDirectory` must update both the parent's nodes map and create a new entry in the directory map. These updates must happen atomically, so we perform them in a separate transaction:

## Java

```

public DirectoryPrx
createDirectory(String name, Ice.Current c)
 throws NameInUse
{
 Freeze.Connection connection =
Freeze.Util.createConnection(_communicator, _envName);
 try {

```

```

 IdentityDirectoryEntryMap dirDB =
 new IdentityDirectoryEntryMap(connection,
directoriesDB());

 for (;;) {
 Freeze.Transaction txn = null;
 try {
 txn = connection.beginTransaction();

 DirectoryEntry entry = dirDB.get(c.id);
 if (entry == null) {
 throw new Ice.ObjectNotExistException();
 }
 if(name.length() == 0
|| entry.nodes.get(name) != null) {
 throw new NameInUse(name);
 }

 DirectoryEntry newEntry =
new DirectoryEntry(name, c.id, null);
 Ice.Identity id = new Ice.Identity(java.util.UUID.r
andomUUID().toString(), "");
 DirectoryPrx proxy =
DirectoryPrxHelper.uncheckedCast(c.adapter.createProxy(id));

 entry.nodes.put(name, new NodeDesc(name,
NodeType.DirType, proxy));
 dirDB.put(c.id, entry);
 dirDB.put(id, newEntry);

 txn.commit();
 txn = null;

 return proxy;
 } catch (Freeze.DeadlockException ex) {
 continue;
 } catch (Freeze.DatabaseException ex) {
 halt(ex);
 } finally {
 if(txn != null) {
 txn.rollback();
 }
 }
 }
 } finally {
 connection.close();
 }

```

```
}
}
```

After establishing the transaction, the code ensures that the directory does not already contain an entry with the same name and then initializes a new `DirectoryEntry`, setting the name to the name of the new directory, and the parent to its own identity. The identity of the new directory is a UUID, which ensures that all directories have unique identities. In addition, the UUID prevents the [accidental rebirth](#) of a file or directory in the future.

The code then initializes a new `NodeDesc` structure with the details of the new directory and, finally, updates its own map of children as well as adding the new directory to the map of directories before committing the transaction.

The `createFile` implementation is almost identical, so we do not show it here. Similarly, the `name` and `destroy` implementations are almost identical to the ones for `FileI`, so let us move to `list`:

## Java

```

public NodeDesc[]
list(Ice.Current c)
{
 Freeze.Connection connection =
 Freeze.Util.createConnection(_communicator, _envName);
 try {
 IdentityDirectoryEntryMap dirDB =
 new IdentityDirectoryEntryMap(connection,
directoriesDB());

 for (;;) {
 try {
 DirectoryEntry entry = dirDB.get(c.id);
 if (entry == null) {
 throw new Ice.ObjectNotExistException();
 }
 NodeDesc[] result =
new NodeDesc[entry.nodes.size()];
 java.util.Iterator<NodeDesc> p =
entry.nodes.values().iterator();
 for (int i = 0; i < entry.nodes.size(); ++i) {
 result[i] = p.next();
 }
 return result;
 } catch (Freeze.DeadlockException ex) {
 continue;
 } catch (Freeze.DatabaseException ex) {
 halt(ex);
 }
 }
 } finally {
 connection.close();
 }
}

```

Again, the code is very simple: it iterates over the `nodes` map, adding each `NodeDesc` structure to the returned sequence.

The `find` implementation is even simpler, so we do not show it here.

See Also

- [Freeze Maps](#)
- [The Current Object](#)
- [Object Identity and Uniqueness](#)



## Freeze Catalogs

In each database environment, Freeze maintains an internal table that contains type information describing all the databases in the environment. This table is an instance of a [Freeze map](#) in which the key is a string representing the database name and the value is an instance of `Freeze::CatalogData`:

| Slice                                                                                                                           |
|---------------------------------------------------------------------------------------------------------------------------------|
| <pre> module Freeze {     struct CatalogData {         bool evictor;         string key;         string value;     }; }; </pre> |

An entry describes an [evictor](#) database if the `evictor` member is true, in which case the `key` and `value` members are empty strings. An entry that describes a Freeze map sets `evictor` to false; the `key` and `value` members contain the Slice types used when the map was defined.

[FreezeScript](#) tools such as `transformdb` and `dumpdb` access the catalog to obtain type information when none is supplied by the user. You can also use `dumpdb` to display the catalog of a database environment.

Freeze applications may access the catalog in the same manner as any other Freeze map. For example, the following C++ code displays the contents of a catalog:

| C++                                                                                                                                                                                                                                                                                                                                                                                                                                                                                                                                                                                                          |
|--------------------------------------------------------------------------------------------------------------------------------------------------------------------------------------------------------------------------------------------------------------------------------------------------------------------------------------------------------------------------------------------------------------------------------------------------------------------------------------------------------------------------------------------------------------------------------------------------------------|
| <pre> #include &lt;Freeze/Catalog.h&gt; ... string envName = ...; Freeze::ConnectionPtr conn = Freeze::createConnection(communicator, envName); Freeze::Catalog catalog(conn, Freeze::catalogName()); for (Freeze::Catalog::const_iterator p = catalog.begin();     p != catalog.end(); ++p) {     if (p-&gt;second.evictor)         cout &lt;&lt; p-&gt;first &lt;&lt; ": evictor" &lt;&lt; endl;     else         cout &lt;&lt; p-&gt;first &lt;&lt; ": map&lt;" &lt;&lt; p-&gt;second.key             &lt;&lt; ", " &lt;&lt; p-&gt;second.value &lt;&lt; "&gt;" &lt;&lt; endl; } conn-&gt;close(); </pre> |

The equivalent Java code is shown below:

**Java**

```
String envName = ...;
Freeze.Connection conn =
Freeze.Util.createConnection(communicator, envName);
Freeze.Catalog catalog =
new Freeze.Catalog(conn, Freeze.Util.catalogName(), true);
for (java.util.Map.Entry<String, Freeze.CatalogData> e :
 catalog.entrySet()) {
 String name = e.getKey();
 Freeze.CatalogData data = e.getValue();
 if (data.evictor)
 System.out.println(name + ": evictor");
 else
 System.out.println(name + ": map<" + data.key + ", " +
data.value + ">");
}
conn.close();
```

**See Also**

- [Freeze Maps](#)
- [Freeze Evictors](#)
- [FreezeScript](#)

## Backing Up Freeze Databases

When you store important information in a Freeze database environment, you should consider regularly backing up the database environment.

There are two forms of backups: cold backups, where you just copy your database environment directory while no application is using these files (very straightforward), and hot backups, where you backup a database environment while an application is actively reading and writing data.

In order to perform a hot backup on a Freeze environment, you need to configure this Freeze environment with two non-default settings:

- `Freeze.DbEnv.envName.OldLogsAutoDelete=0`  
This instructs Freeze to keep old log files instead of periodically deleting them. This setting is necessary for proper hot backups; it implies that you will need to take care of deleting old files yourself (typically as part of your periodic backup procedure).
- `Freeze.DbEnv.envName.DbPrivate=0`  
By default, Freeze is configured with `DbPrivate` set to 1, which means only one process at a time can safely access the database environment. When performing hot backups, you need to access this database environment concurrently from various Berkeley DB utilities (such as `db_archive` or `db_hotbackup`), so you need to set this property to 0.

The `Freeze/backup` C++ demo in your Ice distribution shows one way to perform such backups and recovery. Please consult the Berkeley DB documentation for further details.

### See Also

- [Freeze](#)

# FreezeScript

[Freeze](#) supplies a valuable set of services for simplifying the use of persistence in Ice applications. However, while Freeze makes it easy for an application to manage its persistent state, there are additional administrative responsibilities that must also be addressed:

- **Migration**  
As an application evolves, it is not unusual for the types describing its persistent state to evolve as well. When these changes occur, a great deal of time can be saved if existing databases can be migrated to the new format while preserving as much information as possible.
- **Inspection**  
The ability to examine a database can be helpful during every stage of the application's lifecycle, from development to deployment.

FreezeScript provides tools for performing both of these activities on Freeze [map](#) and [evictor](#) databases. These databases have a well-defined structure because the key and value of each record consist of the marshaled bytes of their respective Slice types. This design allows the FreezeScript tools to operate on any Freeze database using only the Slice definitions for the database types.

## Topics

- [Migrating a Freeze Database](#)
- [Inspecting a Freeze Database](#)
- [FreezeScript Descriptor Expression Language](#)

## Migrating a Freeze Database

The FreezeScript tool `transformdb` migrates a database created by a Freeze [map](#) or [evictor](#). It accomplishes this by comparing the "old" Slice definitions (i.e., the ones that describe the current contents of the database) with the "new" Slice definitions, and making whatever modifications are necessary to ensure that the transformed database is compatible with the new definitions.

This would be difficult to achieve by writing a custom transformation program because that program would require static knowledge of the old and new types, which frequently define many of the same symbols and would therefore prevent the program from being loaded. The `transformdb` tool avoids this issue using an interpretive approach: the Slice definitions are parsed and used to drive the migration of the database records.

The tool supports two modes of operation:

1. [Automatic migration](#) – the database is migrated in a single step using only the default set of transformations.
2. [Custom migration](#) – you supply a script to augment or override the default transformations.

### Topics

- [Automatic Database Migration](#)
- [Custom Database Migration](#)
- [FreezeScript Transformation XML Reference](#)
- [Using transformdb](#)

### See Also

- [Freeze Maps](#)
- [Freeze Evictors](#)

## Automatic Database Migration

On this page:

- [Type Compatibility Rules for Automatic Migration](#)
- [Default Values for Automatic Migration](#)
- [Running an Automatic Migration](#)

The default transformations performed by `transformdb` preserve as much information as possible. However, there are practical limits to the tool's capabilities, since the only information it has is obtained by performing a comparison of the Slice definitions.

For example, suppose our old definition for a structure is the following:

| Slice                                     |
|-------------------------------------------|
| <pre>struct AStruct {     int i; };</pre> |

We want to migrate instances of this struct to the following revised definition:

| Slice                                     |
|-------------------------------------------|
| <pre>struct AStruct {     int j; };</pre> |

As the developers, we know that the `int` member has been renamed from `i` to `j`, but to `transformdb` it appears that member `i` was removed and member `j` was added. The default transformation results in exactly that behavior: the value of `i` is lost, and `j` is initialized to a default value. If we need to preserve the value of `i` and transfer it to `j`, then we need to use [custom migration](#).

The changes that occur as a type system evolves can be grouped into three categories:

- **Data members**  
The data members of class and structure types are added, removed, or renamed. As discussed above, the default transformations initialize new and renamed data members to [default values](#).
- **Type names**  
Types are added, removed, or renamed. New types do not pose a problem for database migration when used to define a new data member; the member is initialized with [default values](#) as usual. On the other hand, if the new type replaces the type of an existing data member, then type compatibility becomes a factor (see the following item).  
  
Removed types generally do not cause problems either, because any uses of that type must have been removed from the new Slice definitions (e.g., by removing data members of that type). There is one case, however, where removed types become an issue, and that is for [polymorphic classes](#).  
  
Renamed types are a concern, just like renamed data members, because of the potential for losing information during migration. This is another situation for which [custom migration](#) is recommended.
- **Type content**  
Examples of changes of type content include the key type of a dictionary, the element type of a sequence, or the type of a data member. If the old and new types are not [compatible](#), then the default transformation emits a warning, discards the current value, and reinitializes it with a [default value](#).

### Type Compatibility Rules for Automatic Migration

Changes in the type of a value are restricted to certain sets of compatible changes. This section describes the type changes supported by the default transformations. All incompatible type changes result in a warning indicating that the current value is being discarded and a default value for the new type assigned in its place. Additional flexibility is provided by [custom migration](#).

### **Boolean**

A value of type `bool` can be transformed to and from `string`. The legal string values for a `bool` value are `"true"` and `"false"`.

### **Integer**

The integer types `byte`, `short`, `int`, and `long` can be transformed into each other, but only if the current value is within range of the new type. These integer types can also be transformed into `string`.

### **Floating Point**

The floating-point types `float` and `double` can be transformed into each other, as well as to `string`. No attempt is made to detect a loss of precision during transformation.

### **String**

A `string` value can be transformed into any of the primitive types, as well as into enumeration and proxy types, but only if the value is a legal string representation of the new type. For example, the string value `"Pear"` can be transformed into the enumeration `Fruit`, but only if `Pear` is an enumerator of `Fruit`.

### **Enum**

An enumeration can be transformed into an enumeration with the same [type ID](#), or into a string. Transformation between enumerations is performed symbolically. For example, consider our old type below:

| Slice                                          |
|------------------------------------------------|
| <pre>enum Fruit { Apple, Orange, Pear };</pre> |

Suppose the enumerator `Pear` is being transformed into the following new type:

| Slice                                  |
|----------------------------------------|
| <pre>enum Fruit { Apple, Pear };</pre> |

The transformed value in the new enumeration is also `Pear`, despite the fact that `Pear` has changed positions in the new type. However, if the old value had been `Orange`, then the default transformation emits a warning because that enumerator no longer exists, and initializes the new value to `Apple` (the default value).

If an enumerator has been renamed, then [custom migration](#) is required to convert enumerators from the old name to the new one.

### **Sequence**

A sequence can be transformed into another sequence type, even if the new sequence type does not have the same type id as the old type, but only if the element types are compatible. For example, `sequence<short>` can be transformed into `sequence<int>`, regardless of the names given to the sequence types.

### **Dictionary**

A dictionary can be transformed into another dictionary type, even if the new dictionary type does not have the same [type ID](#) as the old type, but only if the key and value types are compatible. For example, `dictionary<int, string>` can be transformed into `dictionary<lon`

`g, string>`, regardless of the names given to the dictionary types.

Caution is required when changing the key type of a dictionary, because the default transformation of keys could result in duplication. For example, if the key type changes from `int` to `short`, any `int` value outside the range of `short` results in the key being initialized to a default value (namely zero). If zero is already used as a key in the dictionary, or another out-of-range key is encountered, then a duplication occurs. The transformation handles key duplication by removing the duplicate element from the transformed dictionary. (Custom migration can be useful in these situations if the default behavior is not acceptable.)

### Structure

A `struct` type can only be transformed into another `struct` type with the same [type ID](#). Data members are transformed as appropriate for their types.

### Proxy

A proxy value can be transformed into another proxy type, or into `string`. Transformation into another proxy type is done with the same semantics as in a language mapping: if the new type does not match the old type, then the new type must be a base type of the old type (that is, the proxy is widened).

### Class

A `class` type can only be transformed into another `class` type with the same [type ID](#). A data member of a `class` type is allowed to be widened to a base type. Data members are transformed as appropriate for their types. See [Transforming Objects](#) for more information on transforming classes.

## Default Values for Automatic Migration

Data types are initialized with default values, as shown.

| Type        | Default Value                            |
|-------------|------------------------------------------|
| Boolean     | <code>false</code>                       |
| Numeric     | Zero (0)                                 |
| String      | Empty string                             |
| Enumeration | The first enumerator                     |
| Sequence    | Empty sequence                           |
| Dictionary  | Empty dictionary                         |
| Struct      | Data members are initialized recursively |
| Proxy       | Nil                                      |
| Class       | Nil                                      |

## Running an Automatic Migration

In order to use automatic transformation, we need to supply the following information to `transformdb`:

- The old and new Slice definitions
- The old and new types for the database key and value
- The database environment directory, the database file name, and the name of a new database environment directory to hold the transformed database

Here is an example of a `transformdb` command:



```
$ transformdb --old old/MyApp.ice --new new/MyApp.ice \
--key int,string --value ::Employee db emp.db newdb
```

Briefly, the `--old` and `--new` options specify the old and new Slice definitions, respectively. These options can be specified as many times as necessary in order to load all of the relevant definitions. The `--key` option indicates that the database key is evolving from `int` to `string`. The `--value` option specifies that `::Employee` is used as the database value type in both old and new type definitions, and therefore only needs to be specified once. Finally, we provide the pathname of the database environment directory (`db`), the file name of the database (`emp.db`), and the pathname of the database environment directory for the transformed database (`newdb`).

**See Also**

- [Custom Database Migration](#)
- [Type IDs](#)
- [Using transformdb](#)

## Custom Database Migration

Custom migration is useful when your types have changed in ways that make [automatic migration](#) difficult or impossible. It is also convenient to use custom migration when you have complex initialization requirements for new types or new data members, because custom migration enables you to perform many of the same tasks that would otherwise require you to write a throwaway program.

Custom migration operates in conjunction with automatic migration, allowing you to inject your own transformation rules at well-defined intercept points in the automatic migration process. These rules are called *transformation descriptors*, and are written in XML.

On this page:

- [Simple Example of Custom Migration](#)
- [Overview of Transformation Descriptors](#)
- [Transformation Flow of Execution](#)
- [Transformation Descriptor Scopes](#)
- [Guidelines for Transformation Descriptors](#)

### Simple Example of Custom Migration

We can use a simple example to demonstrate the utility of custom migration. Suppose our application uses a [Freeze map](#) whose key type is `string` and whose value type is an enumeration, defined as follows:

```

Slice
enum BigThree { Ford, DaimlerChrysler, GeneralMotors };

```

We now wish to rename the enumerator `DaimlerChrysler`, as shown in our new definition:

```

Slice
enum BigThree { Ford, Daimler, GeneralMotors };

```

According to the [rules for default transformations](#), all occurrences of the `DaimlerChrysler` enumerator would be transformed into `Ford`, because `Chrysler` no longer exists in the new definition and therefore the default value `Ford` is used instead.

To remedy this situation, we use the following transformation descriptors:

```

XML
<transformdb>
 <database key="string" value="::BigThree">
 <record>
 <if test="oldvalue == ::Old::DaimlerChrysler">
 <set target="newvalue" value="::New::Daimler"/>
 </if>
 </record>
 </database>
</transformdb>

```

When executed, these descriptors convert occurrences of `DaimlerChrysler` in the old type system into `Daimler` in the transformed database's new type system.

### Overview of Transformation Descriptors

As we saw in the previous example, FreezeScript [transformation descriptors](#) are written in XML.

A transformation descriptor file has a well-defined structure. The top-level descriptor in the file is `<transformdb>`. A `<database>` descriptor must be present within `<transformdb>` to define the key and value types used by the database. Inside `<database>`, the `<record>` descriptor triggers the transformation process.

During transformation, type-specific actions are supported by the `<transform>` and `<init>` descriptors, both of which are children of `<transformdb>`. One `<transform>` descriptor and one `<init>` descriptor may be defined for each type in the new Slice definitions. Each time `transformdb` creates a new instance of a type, it executes the `<init>` descriptor for that type, if one is defined. Similarly, each time `transformdb` transforms an instance of an old type into a new type, the `<transform>` descriptor for the new type is executed.

The `<database>`, `<record>`, `<transform>`, and `<init>` descriptors may contain general-purpose action descriptors such as `<if>`, `<set>`, and `<echo>`. These actions resemble statements in programming languages like C++ and Java, in that they are executed in the order of definition and their effects are cumulative. Actions can make use of the [expression language](#) that should look familiar to C++ and Java programmers.

## Transformation Flow of Execution

The transformation descriptors are executed as follows:

- `<database>` is executed first. Each child descriptor of `<database>` is executed in the order of definition. If a `<record>` descriptor is present, database transformation occurs at that point. Any child descriptors of `<database>` that follow `<record>` are not executed until transformation completes.
- During transformation of each record, `transformdb` creates instances of the new key and value types, which includes the execution of the `<init>` descriptors for those types. Next, the old key and value are transformed into the new key and value, in the following manner:
  1. Locate the `<transform>` descriptor for the type.
  2. If no descriptor is found, or the descriptor exists and it does not preclude default transformation, then transform the data as in [automatic database migration](#).
  3. If the `<transform>` descriptor exists, execute it.
  4. Finally, execute the child descriptors of `<record>`.

## Transformation Descriptor Scopes

The `<database>` descriptor creates a global scope, allowing child descriptors of `<database>` to define symbols that are accessible in any descriptor.



In order for a global symbol to be available to a `<transform>` or `<init>` descriptor, the symbol must be defined before the `<record>` descriptor is executed.

Furthermore, certain other descriptors create local scopes that exist only for the duration of the descriptor's execution. For example, the `<transform>` descriptor creates a local scope and defines the symbols `old` and `new` to represent a value in its old and new forms. Child descriptors of `<transform>` can also define new symbols in the local scope, as long as those symbols do not clash with an existing symbol in that scope. It is legal to add a new symbol with the same name as a symbol in an outer scope, but the outer symbol will not be accessible during the descriptor's execution.

The global scope is useful in many situations. For example, suppose you want to track the number of times a certain value was encountered during transformation. This can be accomplished as shown below:

## XML

```

<transformdb>
 <database key="string" value="::Ice::Identity">
 <define name="categoryCount" type="int" value="0"/>
 <record/>
 <echo message="categoryCount = " value="categoryCount"/>
 </database>
 <transform type="::Ice::Identity">
 <if test="new.category == 'Accounting'">
 <set target="categoryCount" value="categoryCount + 1"/>
 </if>
 </transform>
</transformdb>

```

In this example, the `<define>` descriptor introduces the symbol `categoryCount` into the global scope, defining it as type `int` with an initial value of zero. Next, the `<record>` descriptor causes transformation to proceed. Each occurrence of the type `Ice::Identity` causes its `<transform>` descriptor to be executed, which examines the `category` member and increases `categoryCount` if necessary. Finally, after transformation completes, the `<echo>` descriptor displays the final value of `categoryCount`.

To reinforce the relationships between descriptors and scopes, consider the following diagram. Several descriptors are shown, including the symbols they define in their local scopes. In this example, the `<iterate>` descriptor has a dictionary target and therefore the default symbol for the element value, `value`, hides the symbol of the same name in the parent `<init>` descriptor's scope.



This situation can be avoided by assigning a different symbol name to the element value.

In addition to symbols in the `<iterate>` scope, child descriptors of `<iterate>` can also refer to symbols from the `<init>` and `<database>` scopes.

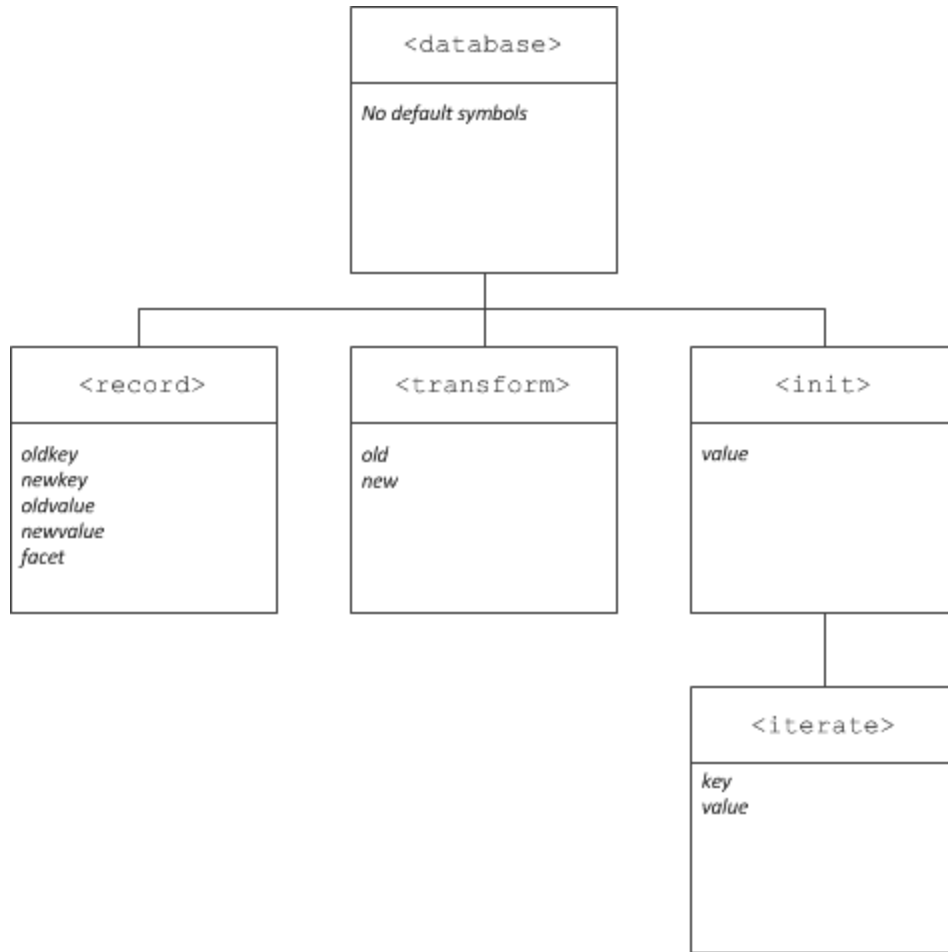

*Relationship between descriptors and scopes.*

## Guidelines for Transformation Descriptors

There are three points at which you can intercept the transformation process: when transforming a record (`<record>`), when transforming an instance of a type (`<transform>`), and when creating an instance of a type (`<init>`).

In general, `<record>` is used when your modifications require access to both the key and value of the record. For example, if the database key is needed as a factor in an equation, or to identify an element in a dictionary, then `<record>` is the only descriptor in which this type of modification is possible. The `<record>` descriptor is also convenient to use when the number of changes to be made is small, and does not warrant the effort of writing separate `<transform>` or `<init>` descriptors.

The `<transform>` descriptor has a more limited scope than `<record>`. It is used when changes must potentially be made to all instances of a type (regardless of the context in which that type is used) and access to the old value is necessary. The `<transform>` descriptor does not have access to the database key and value, therefore decisions can only be made based on the old and new instances of the type in question.

Finally, the `<init>` descriptor is useful when access to the old instance is not required in order to properly initialize a type. In most cases, this activity could also be performed by a `<transform>` descriptor that simply ignored the old instance, so `<init>` may seem redundant. However, there is one situation where `<init>` is required: when it is necessary to initialize an instance of a type that is introduced by the new Slice definitions. Since there are no instances of this type in the current database, a `<transform>` descriptor for that type would never be executed.

### See Also

- [Automatic Database Migration](#)
- [Freeze Maps](#)

- [FreezeScript Transformation XML Reference](#)
- [FreezeScript Descriptor Expression Language](#)

## FreezeScript Transformation XML Reference

This page describes the XML elements comprising the FreezeScript transformation descriptors.

On this page:

- [<transformdb> Descriptor Element](#)
- [<database> Descriptor Element](#)
- [<record> Descriptor Element](#)
- [<transform> Descriptor Element](#)
- [<init> Descriptor Element](#)
- [<iterate> Descriptor Element](#)
- [<if> Descriptor Element](#)
- [<set> Descriptor Element](#)
- [<add> Descriptor Element](#)
- [<define> Descriptor Element](#)
- [<remove> Descriptor Element](#)
- [<fail> Descriptor Element](#)
- [<delete> Descriptor Element](#)
- [<echo> Descriptor Element](#)

### <transformdb> Descriptor Element

The top-level descriptor in a descriptor file. It requires at least one `<database>` descriptor, and supports any number of `<transform>` and `<init>` child descriptors. This descriptor has no attributes.

### <database> Descriptor Element

The attributes of this descriptor define the old and new key and value types for the database to be transformed, and optionally the name of the database to which these types apply. It supports any number of child descriptors, but at most one `<record>` descriptor. The `<database>` descriptor also creates a [global scope](#) for user-defined symbols.

The attributes supported by the `<database>` descriptor are described in the following table:

| Name  | Description                                                                                                                                                    |
|-------|----------------------------------------------------------------------------------------------------------------------------------------------------------------|
| name  | Specifies the name of the database defined by this descriptor. (Optional)                                                                                      |
| key   | Specifies the Slice types of the old and new keys. If the types are the same, only one needs to be specified. Otherwise, the types are separated by a comma.   |
| value | Specifies the Slice types of the old and new values. If the types are the same, only one needs to be specified. Otherwise, the types are separated by a comma. |

As an example, consider the following `<database>` descriptor. In this case, the [Freeze map](#) to be transformed currently has key type `int` and value type `::Employee`, and is migrating to a key type of `string`:

**XML**

```
<database key="int,string" value="::Employee">
```

### <record> Descriptor Element

Commences the transformation. Child descriptors are executed for each record in the database, providing the user with an opportunity to

examine the record's old key and value, and optionally modify the new key and value. Default transformations, as well as `<transform>` and `<init>` descriptors, are executed before the child descriptors. The `<record>` descriptor introduces the following symbols into a local scope: `oldkey`, `newkey`, `oldvalue`, `newvalue`, `facet`. These symbols are accessible to child descriptors, but not to `<transform>` or `<init>` descriptors. The `oldkey` and `oldvalue` symbols are read-only. The `facet` symbol is a string indicating the facet name of the object in the current record, and is only relevant for [Freeze evictor](#) databases.

Use caution when modifying database keys to ensure that duplicate keys do not occur. If a duplicate database key is encountered, transformation fails immediately.

Note that database transformation only occurs if a `<record>` descriptor is present.

## `<transform>` Descriptor Element

Customizes the transformation for all instances of a type in the *new* Slice definitions. The children of this descriptor are executed after the optional [default transformation](#) has been performed. Only one `<transform>` descriptor can be specified for a type, but a `<transform>` descriptor is not required for every type. The symbols `old` and `new` are introduced into a local scope and represent the old and new values, respectively. The `old` symbol is read-only. The attributes supported by this descriptor are described in the following table:

Name	Description
<code>type</code>	Specifies the Slice <a href="#">type ID</a> for the type's new definition.
<code>default</code>	If <code>false</code> , no default transformation is performed on values of this type. If not specified, the default value is <code>true</code> .
<code>base</code>	This attribute determines whether <code>&lt;transform&gt;</code> descriptors of base class types are executed. If <code>true</code> , the <code>&lt;transform&gt;</code> descriptor of the immediate base class is invoked. If no descriptor is found for the immediate base class, the class hierarchy is searched until a descriptor is found. The execution of any base class descriptors occurs after execution of this descriptor's children. If not specified, the default value is <code>true</code> .
<code>rename</code>	Indicates that a type in the old Slice definitions has been renamed to the new type identified by the <code>type</code> attribute. The value of this attribute is the type ID of the old Slice definition. Specifying this attribute relaxes the <a href="#">strict compatibility rules</a> for <code>enum</code> , <code>struct</code> and <code>class</code> types.

Below is an example of a `<transform>` descriptor that initializes a new data member:

**XML**

```
<transform type="::Product">
 <set target="new.salePrice" value="old.listPrice * old.discount"/>
</transform>
```

For class types, `transformdb` first attempts to locate a `<transform>` descriptor for the object's most-derived type. If no descriptor is found, `transformdb` proceeds up the class hierarchy in an attempt to find a descriptor. The base object type, `Object`, is the root of every class hierarchy and is included in the search for descriptors. It is therefore possible to define a `<transform>` descriptor for type `Object`, which will be invoked for every class instance.

Note that `<transform>` descriptors are executed recursively. For example, consider the following Slice definitions:



### Slice

```
struct Inner {
 int sum;
};
struct Outer {
 Inner i;
};
```

When `transformdb` is performing the default transformation on a value of type `Outer`, it recursively performs the default transformation on the `Inner` member, then executes the `<transform>` descriptor for `Inner`, and finally executes the `<transform>` descriptor for `Outer`. However, if default transformation is disabled for `Outer`, then no transformation is performed on the `Inner` member and therefore the `<transform>` descriptor for `Inner` is not executed.

### `<init>` Descriptor Element

Defines custom initialization rules for all instances of a type in the new Slice definitions. Child descriptors are executed each time the type is instantiated. The typical use case for this descriptor is for types that have been introduced in the new Slice definitions and whose instances require default values different than what `transformdb` supplies. The symbol `value` is introduced into a local scope to represent the instance. The attributes supported by this descriptor are described in the following table:

Name	Description
<code>type</code>	Specifies the Slice <a href="#">type ID</a> of the type's new definition.

Here is a simple example of an `<init>` descriptor:

### XML

```
<init type="::Player">
 <set target="value.currency" value="100"/>
</init>
```

Note that, like `<transform>`, `<init>` descriptors are executed recursively. For example, if an `<init>` descriptor is defined for a `struct` type, the `<init>` descriptors of the `struct`'s members are executed before the `struct`'s descriptor.

### `<iterate>` Descriptor Element

Iterates over a dictionary or sequence, executing child descriptors for each element. The symbol names selected to represent the element information may conflict with existing symbols in the enclosing scope, in which case those outer symbols are not accessible to child descriptors. The attributes supported by this descriptor are described in the following table:

Name	Description
<code>target</code>	The sequence or dictionary.
<code>index</code>	The symbol name used for the sequence index. If not specified, the default symbol is <code>i</code> .
<code>element</code>	The symbol name used for the sequence element. If not specified, the default symbol is <code>elem</code> .

key	The symbol name used for the dictionary key. If not specified, the default symbol is <code>key</code> .
value	The symbol name used for the dictionary value. If not specified, the default symbol is <code>value</code> .

Shown below is an example of an `<iterate>` descriptor that sets the new data member `reviewSalary` to `true` if the employee's salary is greater than \$3000:

**XML**

```

<iterate target="new.employeeMap" key="id" value="emp">
 <if test="emp.salary > 3000">
 <set target="emp.reviewSalary" value="true"/>
 </if>
</iterate>

```

### `<if>` Descriptor Element

Conditionally executes child descriptors. The attributes supported by this descriptor are described in the following table:

Name	Description
test	A boolean <a href="#">expression</a> .

Child descriptors are executed if the expression in `test` evaluates to true.

### `<set>` Descriptor Element

Modifies a value. The `value` and `type` attributes are mutually exclusive. If `target` denotes a dictionary element, that element must already exist (i.e., `<set>` cannot be used to add an element to a dictionary). The attributes supported by this descriptor are described in the following table:

Name	Description
target	An <a href="#">expression</a> that must select a modifiable value.
value	An <a href="#">expression</a> that must evaluate to a value compatible with the target's type.
type	If specified, set the target to be an instance of the given Slice class. The value is a <a href="#">type ID</a> from the new Slice definitions. The class must be compatible with the target's type.
length	An integer expression representing the desired new length of a sequence. If the new length is less than the current size of the sequence, elements are removed from the end of the sequence. If the new length is greater than the current size, new elements are added to the end of the sequence. If <code>value</code> or <code>type</code> is also specified, it is used to initialize each new element.
convert	If <code>true</code> , additional type conversions are supported: between integer and floating point, and between integer and enumeration. Transformation fails immediately if a range error occurs. If not specified, the default value is <code>false</code> .

The `<set>` descriptor below modifies a member of a dictionary element:

```
XML
```

```
<set target="new.parts['P105J3'].cost"
value="new.parts['P105J3'].cost * 1.05"/>
```

This `<set>` descriptor adds an element to a sequence and initializes its value:

```
XML
```

```
<set target="new.partsList" length="new.partsList.length + 1"
value="'P105J3'"/>
```

As another example, the following `<set>` descriptor changes the value of an enumeration:

```
XML
```

```
<set target="new.ingredient" value="::New::Apple"/>
```

Notice in this example that the value refers to a [symbol](#) in the new Slice definitions.

### `<add>` Descriptor Element

Adds a new element to a sequence or dictionary. It is legal to add an element while traversing the sequence or dictionary using `<iterate>`, however the traversal order after the addition is undefined. The `key` and `index` attributes are mutually exclusive, as are the `value` and `type` attributes. If neither `value` nor `type` is specified, the new element is initialized with a default value. The attributes supported by this descriptor are described in the following table:

Name	Description
<code>target</code>	An <a href="#">expression</a> that must select a modifiable sequence or dictionary.
<code>key</code>	An <a href="#">expression</a> that must evaluate to a value compatible with the target dictionary's key type.
<code>index</code>	An <a href="#">expression</a> that must evaluate to an integer value representing the insertion position. The new element is inserted before <code>index</code> . The value must not exceed the length of the target sequence.
<code>value</code>	An <a href="#">expression</a> that must evaluate to a value compatible with the target dictionary's value type, or the target sequence's element type.
<code>type</code>	If specified, set the target value or element to be an instance of the given Slice class. The value is a <a href="#">type ID</a> from the new Slice definitions. The class must be compatible with the target dictionary's value type, or the target sequence's element type.

convert	If <code>true</code> , additional type conversions are supported: between integer and floating point, and between integer and enumeration. Transformation fails immediately if a range error occurs. If not specified, the default value is <code>false</code> .
---------	------------------------------------------------------------------------------------------------------------------------------------------------------------------------------------------------------------------------------------------------------------------

Below is an example of an `<add>` descriptor that adds a new dictionary element and then initializes its member:

```
XML
```

```
<add target="new.parts" key="'P105J4'"/>
<set target="new.parts['P105J4'].cost" value="3.15"/>
```

## `<define>` Descriptor Element

Defines a new symbol in the current scope. The attributes supported by this descriptor are described in the following table:

Name	Description
name	The name of the new symbol. An error occurs if the name matches an existing symbol in the current scope.
type	The name of the symbol's formal Slice type. For user-defined types, the name should be prefixed with <code>::Old</code> or <code>::New</code> to indicate the source of the type. The prefix can be omitted for primitive types.
value	An <a href="#">expression</a> that must evaluate to a value compatible with the symbol's type.
convert	If <code>true</code> , additional type conversions are supported: between integer and floating point, and between integer and enumeration. Execution fails immediately if a range error occurs. If not specified, the default value is <code>false</code> .

Below are two examples of the `<define>` descriptor. The first example defines the symbol `identity` to have type `Ice::Identity`, and proceeds to initialize its members using `<set>`:

```
XML
```

```
<define name="identity" type="::New::Ice::Identity"/>
<set target="identity.name" value="steve"/>
<set target="identity.category" value="Admin"/>
```

The second example uses the enumeration we first saw in our discussion of [custom database migration](#) to define the symbol `manufacturer` and assign it a default value:

```
XML
```

```
<define name="manufacturer" type="::New::BigThree"
value="::New::Daimler"/>
```

## <remove> Descriptor Element

Removes an element from a sequence or dictionary. It is legal to remove an element while traversing a sequence or dictionary using <iterate>, however the traversal order after removal is undefined. The attributes supported by this descriptor are described in the following table:

Name	Description
target	An <a href="#">expression</a> that must select a modifiable sequence or dictionary.
key	An <a href="#">expression</a> that must evaluate to a value compatible with the key type of the target dictionary.
index	An <a href="#">expression</a> that must evaluate to an integer value representing the index of the sequence element to be removed.

## <fail> Descriptor Element

Causes transformation to fail immediately. If `test` is specified, transformation fails only if the [expression](#) evaluates to `true`. The attributes supported by this descriptor are described in the following table:

Name	Description
message	A message to display upon transformation failure.
test	A boolean <a href="#">expression</a> .

The following <fail> descriptor terminates the transformation if a range error is detected:

**XML**

```
<fail message="range error occurred in ticket count!"
test="old.ticketCount > 32767"/>
```

## <delete> Descriptor Element

Causes transformation of the current database record to cease, and removes the record from the transformed database. This descriptor has no attributes.

## <echo> Descriptor Element

Displays values and informational messages. If no attributes are specified, only a newline is printed. The attributes supported by this descriptor are described in the following table:

Name	Description
message	A message to display.
value	An <a href="#">expression</a> . The value of the expression is displayed in a structured format.

Shown below is an <echo> descriptor that uses both `message` and `value` attributes:

**XML**

```
<if test="old.ticketCount > 32767">
 <echo message="deleting record with invalid ticket count: "
value="old.ticketCount"/>
 <delete/>
</if>
```

**See Also**

- [Custom Database Migration](#)
- [Freeze Maps](#)
- [Freeze Evictors](#)
- [Automatic Database Migration](#)
- [FreezeScript Descriptor Expression Language](#)

## Using transformdb

On this page:

- [Execution Modes for transformdb](#)
- [Using Database Catalogs during Transformation](#)
- [Slice Options for transformdb](#)
- [Type Options for transformdb](#)
- [General Options for transformdb](#)
- [Database Arguments for transformdb](#)
- [Performing an Automatic Migration](#)
  - [Migrating a Single Database](#)
  - [Migrating All Databases](#)
- [Performing a Migration Analysis](#)
  - [Generated File](#)
  - [Invocation Modes](#)
- [Performing a Custom Migration](#)
- [transformdb Usage Strategies](#)
- [Transforming Objects](#)
- [Using transformdb on an Open Environment](#)

### Execution Modes for transformdb

The tool operates in one of three modes:

- Automatic migration
- Custom migration
- Analysis

The only difference between [automatic](#) and [custom](#) migration modes is the source of the transformation descriptors: for automatic migration, `transformdb` internally generates and executes a default set of descriptors, whereas for custom migration the user specifies an external file containing the transformation descriptors to be executed.

In analysis mode, `transformdb` creates a file containing the default transformation descriptors it would have used during automatic migration. You would normally review this file and possibly customize it prior to executing the tool again in its custom migration mode.

### Using Database Catalogs during Transformation

Freeze maintains schema information in a [catalog](#) for each database environment. If necessary, `transformdb` will use the catalog to determine the names of the databases in the environment, and to determine the key and value types of a particular database. There are two advantages to the tool's use of the catalog:

- Allows `transformdb` to operate on all of the databases in a single invocation
- Eliminates the need for you to specify type information for a database.

For example, you can use automatic migration to transform all of the databases at one time, as shown below:

```
$ transformdb [options] old-env new-env
```

Since we omitted the name of a database to be migrated, `transformdb` uses the catalog in the environment `old-env` to discover all of the databases and their types, generates default transformations for each database, and performs the migration. However, we must still ensure that `transformdb` has loaded the old and new Slice types used by *all* of the databases in the environment.

### Slice Options for transformdb

The tool supports the [standard command-line options](#) common to all Slice processors, with the exception of the include directory (`-I`) option. The options specific to `transformdb` are described below:

- `--old SLICE`  
`--new SLICE`  
Loads the old or new Slice definitions contained in the file `SLICE`. These options may be specified multiple times if several files must be loaded. However, it is the user's responsibility to ensure that duplicate definitions do not occur (which is possible when two files are loaded that share a common include file). One strategy for avoiding duplicate definitions is to load a single Slice file that contains only `#include` statements for each of the Slice files to be loaded. No duplication is possible in this case if the included files use include guards correctly.
- `--include-old DIR`  
`--include-new DIR`  
Adds the directory `DIR` to the set of include paths for the old or new Slice definitions.

## Type Options for `transformdb`

In invocation modes for which `transformdb` requires that you define the types used by a database, you must specify one of the following options:

- `--key TYPE[,TYPE]`  
`--value TYPE[,TYPE]`  
Specifies the Slice type(s) of the database key and value. If the type does not change, then the type only needs to be specified once. Otherwise, the old type is specified first, followed by a comma and the new type. For example, the option `--key int,string` indicates that the database key is migrating from `int` to `string`. On the other hand, the option `--key int,int` indicates that the key type does not change, and could be given simply as `--key int`. Type changes are restricted to those allowed by the [compatibility rules](#), but custom migration provides additional flexibility.
- `-e`  
Indicates that a [Freeze evictor](#) database is being migrated. As a convenience, this option automatically sets the database key and value types to those appropriate for the Freeze evictor, and therefore the `--key` and `--value` options are not necessary. Specifically, the key type of a Freeze evictor database is `Ice::Identity`, and the value type is `Freeze::ObjectRecord`. The latter is defined in the Slice file `Freeze/EvictorStorage.ice`; however, this file does not need to be loaded into your old and new Slice definitions.

## General Options for `transformdb`

These options may be specified during analysis or migration, as indicated below:

- `-i`  
Requests that `transformdb` ignore type changes that violate the [compatibility rules](#). If this option is not specified, `transformdb` fails immediately if such a violation occurs. With this option, a warning is displayed but `transformdb` continues the requested action. The `-i` option can be specified in analysis or automatic migration modes.
- `-p`  
During migration, this option requests that `transformdb` [purge object instances](#) whose type is no longer found in the new Slice definitions.
- `-c`  
Use catastrophic recovery on the old Berkeley DB database environment prior to migration.
- `-w`  
Suppress duplicate warnings during migration. This option is especially useful to minimize diagnostic messages when `transformdb` would otherwise emit the same warning many times, such as when it detects the same issue in every record of a database.

## Database Arguments for `transformdb`

In addition to the options described above, `transformdb` accepts as many as three arguments that specify the names of databases and database environments:

- `dbenv`  
The pathname of the old database environment directory.



- `db`  
The name of an existing database file in `dbenv`. `transformdb` never modifies this database.
- `newdbenv`  
The pathname of the database environment directory to contain the transformed database(s). This directory must exist and must not contain an existing database whose name matches a database being migrated.

## Performing an Automatic Migration

You can use `transformdb` to automatically migrate one database or all databases in an environment.

### Migrating a Single Database

Use the following command line to migrate one database:

```
$ transformdb [slice-opts] [type-opts] [gen-opts] dbenv db newdbenv
```

If you omit `type-opts`, the tool obtains type information for database `db` from the `catalog`. For example, consider the following command, which uses automatic migration to transform a database with a key type of `int` and value type of `string` into a database with the same key type and a value type of `long`:

```
$ transformdb --key int --value string,long dbhome data.db newdbhome
```

Note that we did not need to specify the Slice options `--old` or `--new` because our key and value types are primitives. Upon successful completion, the file `newdbhome/data.db` contains our transformed database.

### Migrating All Databases

To migrate all databases in the environment, use a command like the one shown below:

```
$ transformdb [slice-opts] [gen-opts] dbenv newdbenv
```

In this invocation mode, you must ensure that `transformdb` has loaded the old and new Slice definitions for all of the types it will encounter among the databases in the environment.

## Performing a Migration Analysis

Custom migration is a two-step process: you first write the transformation descriptors, and then execute them to transform a database. To assist you in the process of creating a descriptor file, `transformdb` can generate a default set of transformation descriptors by comparing your old and new Slice definitions. This feature is enabled by specifying the following option:

- `-o FILE`  
Specifies the descriptor file `FILE` to be created during analysis. No migration occurs in this invocation mode.

### Generated File

The generated file contains a `<transform>` descriptor for each type that appears in both old and new Slice definitions, and an `<init>` descriptor for types that appear only in the new Slice definitions. In most cases, these descriptors are empty. However, they can contain XML comments describing changes detected by `transformdb` that may require action on your part.

For example, let us revisit the enumeration we defined in our discussion of [custom database migration](#):

**Slice**

```
enum BigThree { Ford, DaimlerChrysler, GeneralMotors };
```

This enumeration has evolved into the one shown below. In particular, the `DaimlerChrysler` enumerator has been renamed to reflect a corporate name change:

**Slice**

```
enum BigThree { Ford, Daimler, GeneralMotors };
```

Next we run `transformdb` in analysis mode:

```
$ transformdb --old old/BigThree.ice --new new/BigThree.ice --key string \
--value ::BigThree -o transform.xml
```

The generated file `transform.xml` contains the following descriptor for the enumeration `BigThree`:

**XML**

```
<transform type="::BigThree">
 <!-- NOTICE: enumerator `DaimlerChrysler' has been removed -->
</transform>
```

The comment indicates that enumerator `DaimlerChrysler` is no longer present in the new definition, reminding us that we need to add logic in this `<transform>` descriptor to change all occurrences of `DaimlerChrysler` to `Daimler`.

The descriptor file generated by `transformdb` is well-formed and does not require any manual intervention prior to being executed. However, executing an unmodified descriptor file is simply the equivalent of using automatic migration.

**Invocation Modes**

The sample command line shown in the previous section specified the key and value types of the database explicitly. This invocation mode has the following general form:

```
$ transformdb [slice-opts] [type-opts] [gen-opts] -o FILE
```

Upon successful completion, the generated file contains a `<database>` descriptor that records the type information supplied by `type-opts`, in addition to the `<transform>` and `<init>` descriptors described earlier.

For your convenience, you can omit `type-opts` and allow `transformdb` to obtain type information from the catalog instead:

```
$ transformdb [slice-opts] [gen-opts] -o FILE dbenv
```

In this case, the generated file contains a `<database>` descriptor for each database in the catalog. Note that in this invocation mode, `trans`

`formdb` must assume that the names of the database key and value types have not changed, since the only type information available is the catalog in the old database environment. If the tool is unable to locate a new Slice definition for a database's key or value type, it emits a warning message and generates a placeholder value in the output file that you must modify prior to migration.

## Performing a Custom Migration

After preparing a descriptor file, either by writing one completely yourself, or modifying one generated by the analysis mode described in the previous section, you are ready to migrate a database. One additional option is provided for migration:

- `-f FILE`  
Execute the transformation descriptors in the file `FILE`.

To transform one database, use the following command:

```
$ transformdb [slice-opts] [gen-opts] -f FILE dbenv db newdbenv
```

The tool searches the descriptor file for a `<database>` descriptor whose `name` attribute matches `db`. If no match is found, it searches for a `<database>` descriptor that does not have a `name` attribute.

If you want to transform all databases in the environment, you can omit the database name:

```
$ transformdb [slice-opts] [gen-opts] -f FILE dbenv newdbenv
```

In this case, the descriptor file must contain a `<database>` element for each database in the environment.

Continuing our enumeration example from the analysis discussion above, assume we have modified `transform.xml` to convert the `Chrysler` enumerator, and are now ready to execute the transformation:

```
$ transformdb --old old/BigThree.ice --new new/BigThree.ice -f
transform.xml \
dbhome bigthree.db newdbhome
```

## `transformdb` Usage Strategies

If it becomes necessary for you to transform a Freeze database, we generally recommend that you attempt to use automatic migration first, unless you already know that custom migration is necessary. Since transformation is a non-destructive process, there is no harm in attempting an automatic migration, and it is a good way to perform a sanity check on your `transformdb` arguments (for example, to ensure that all the necessary Slice files are being loaded), as well as on the database itself. If `transformdb` detects any incompatible type changes, it displays an error message for each incompatible change and terminates without doing any transformation. In this case, you may want to run `transformdb` again with the `-i` option, which ignores incompatible changes and causes transformation to proceed.

Pay careful attention to any warnings that `transformdb` emits, as these may indicate the need for using custom migration. For example, if we had attempted to transform the database containing the `BigThree` enumeration from previous sections using automatic migration, any occurrences of the `Chrysler` enumerator would display the following warning:

```
warning: unable to convert 'Chrysler' to ::BigThree
```

If custom migration appears to be necessary, use analysis to generate a default descriptor file, then review it for `NOTICE` comments and edit as necessary. Liberal use of the `<echo>` descriptor can be beneficial when testing your descriptor file, especially from within the `<record>` descriptor where you can display old and new keys and values.

## Transforming Objects

The polymorphic nature of Slice classes can cause problems for database migration. As an example, the Slice parser can ensure that a set of Slice definitions loaded into `transformdb` is complete for all types but classes (and exceptions, but we ignore those because they are not persistent). `transformdb` cannot know that a database may contain instances of a subclass that is derived from one of the loaded classes but whose definition is not loaded. Alternatively, the type of a class instance may have been renamed and cannot be found in the new Slice definitions.

By default, these situations result in immediate transformation failure. However, the `-p` option is a (potentially drastic) way to handle these situations: if a class instance has no equivalent in the new Slice definitions and this option is specified, `transformdb` removes the instance any way it can. If the instance appears in a sequence or dictionary element, that element is removed. Otherwise, the database record containing the instance is deleted.

Now, the case of a class type being renamed is handled easily enough using custom migration and the `rename` attribute of the `<transform>` descriptor. However, there are legitimate cases where the destructive nature of the `-p` option can be useful. For example, if a class type has been removed and it is simply easier to start with a database that is guaranteed not to contain any instances of that type, then the `-p` option may simplify the broader migration effort.

This is another situation in which running an automatic migration first can help point out the trouble spots in a potential migration. Using the `-p` option, `transformdb` emits a warning about the missing class type and continues, rather than halting at the first occurrence, enabling you to discover whether you have forgotten to load some Slice definitions, or need to rename a type.

## Using `transformdb` on an Open Environment

It is possible to use `transformdb` to migrate databases in an environment that is currently open by another process, but if you are not careful you can easily corrupt the environment and cause the other process to fail. To avoid such problems, you must configure both `transformdb` and the other process to set `Freeze.DbEnv.env-name.DbPrivate=0`. This property has a default value of one, therefore you must explicitly set it to zero. Note that `transformdb` makes no changes to the existing database environment, but it requires exclusive access to the new database environment until transformation is complete.

If you run `transformdb` on an open environment but neglect to set `Freeze.DbEnv.env-name.DbPrivate=0`, you can expect `transformdb` to terminate immediately with an error message stating that the database environment is locked. Before running `transformdb` on an open environment, we strongly recommend that you first verify that the other process was also configured with `Freeze.DbEnv.env-name.DbPrivate=0`.

### See Also

- [Automatic Database Migration](#)
- [Custom Database Migration](#)
- [Using the Slice Compilers](#)
- [Freeze Catalogs](#)
- [Freeze Evictors](#)
- [Freeze Properties](#)

## Inspecting a Freeze Database

The FreezeScript tool `dumpdb` is used to examine a Freeze database. Its simplest invocation displays every record of the database, but the tool also supports more selective activities. In fact, `dumpdb` supports a scripted mode that shares many of the same XML descriptors as `transformdb`, enabling sophisticated filtering and reporting.

### Topics

- [Using dumpdb](#)
- [FreezeScript Inspection XML Reference](#)

## Using dumpdb

This page describes `dumpdb` and provides advice on how to best use it.

On this page:

- [Overview of Inspection Descriptors](#)
- [Inspection Flow of Execution](#)
- [Inspection Descriptor Scopes](#)
- [Command Line Options for `dumpdb`](#)
- [Database Arguments for `dumpdb`](#)
- [dumpdb Use Cases](#)
  - [Dump an Entire Database](#)
  - [Dump Selected Records](#)
  - [Creating a Sample Descriptor File](#)
  - [Executing a Descriptor File](#)
  - [Examine the Catalog](#)
- [Using `dumpdb` on an Open Environment](#)

### Overview of Inspection Descriptors

`dumpdb` can read [descriptors](#) from an XML file. A `dumpdb` descriptor file has a well-defined structure. The top-level descriptor in the file is `<dumpdb>`. A `<database>` descriptor must be present within `<dumpdb>` to define the key and value types used by the database. Inside `<database>`, the `<record>` descriptor triggers database traversal. Shown below is an example that demonstrates the structure of a minimal descriptor file:

**XML**

```

<dumpdb>
 <database key="string" value="::Employee">
 <record>
 <echo message="Key: " value="key"/>
 <echo message="Value: " value="value"/>
 </record>
 </database>
</dumpdb>

```

During traversal, type-specific actions are supported by the `<dump>` descriptor, which is a child of `<dumpdb>`. One `<dump>` descriptor may be defined for each type in the Slice definitions. Each time `dumpdb` encounters an instance of a type, the `<dump>` descriptor for that type is executed.

The `<database>`, `<record>`, and `<dump>` descriptors may contain general-purpose action descriptors such as `<if>` and `<echo>`. These actions resemble statements in programming languages like C++ and Java, in that they are executed in the order of definition and their effects are cumulative. Actions can make use of the FreezeScript [expression language](#).

Although `dumpdb` descriptors are not allowed to modify the database, they can still define local symbols for scripting purposes. Once a symbol is defined by the `<define>` descriptor, other descriptors such as `<set>`, `<add>`, and `<remove>` can be used to manipulate the symbol's value.

### Inspection Flow of Execution

The descriptors are executed as follows:

- `<database>` is executed first. Each child descriptor of `<database>` is executed in the order of definition. If a `<record>` descriptor is present, database traversal occurs at that point. Any child descriptors of `<database>` that follow `<record>` are not executed until traversal completes.

- For each record, `dumpdb` interprets the key and value, invoking `<dump>` descriptors for each type it encounters. For example, if the value type of the database is a `struct`, then `dumpdb` first attempts to invoke a `<dump>` descriptor for the structure type, and then recursively interprets the structure's members in the same fashion.

## Inspection Descriptor Scopes

The `<database>` descriptor creates a global scope, allowing child descriptors of `<database>` to define symbols that are accessible in any descriptor.

**i** In order for a global symbol to be available to a `<dump>` descriptor, the symbol must be defined before the `<record>` descriptor is executed.

Furthermore, certain other descriptors create local scopes that exist only for the duration of the descriptor's execution. For example, the `<dump>` descriptor creates a local scope and defines the symbol `value` to represent a value of the specified type. Child descriptors of `<dump>` can also define new symbols in the local scope, as long as those symbols do not clash with an existing symbol in that scope. It is legal to add a new symbol with the same name as a symbol in an outer scope, but the outer symbol will not be accessible during the descriptor's execution.

The global scope is useful in many situations. For example, suppose you want to track the number of times a certain value was encountered during database traversal. This can be accomplished as shown below:

XML
<pre> &lt;dumpdb&gt;   &lt;database key="string" value="::Ice::Identity"&gt;     &lt;define name="categoryCount" type="int" value="0"/&gt;     &lt;record/&gt;     &lt;echo message="categoryCount = " value="categoryCount"/&gt;   &lt;/database&gt;   &lt;dump type="::Ice::Identity"&gt;     &lt;if test="value.category == `Accounting'"&gt;       &lt;set target="categoryCount" value="categoryCount + 1"/&gt;     &lt;/if&gt;   &lt;/dump&gt; &lt;/dumpdb&gt; </pre>

In this example, the `<define>` descriptor introduces the symbol `categoryCount` into the global scope, defining it as type `int` with an initial value of zero. Next, the `<record>` descriptor causes traversal to proceed. Each occurrence of the type `Ice::Identity` causes its `<dump>` descriptor to be executed, which examines the `category` member and increases `categoryCount` if necessary. Finally, after traversal completes, the `<echo>` descriptor displays the final value of `categoryCount`.

To reinforce the relationships between descriptors and scopes, consider the diagram in the figure below. Several descriptors are shown, including the symbols they define in their local scopes. In this example, the `<iterate>` descriptor has a dictionary target and therefore the default symbol for the element value, `value`, hides the symbol of the same name in the parent `<dump>` descriptor's scope.

**i** This situation can be avoided by assigning a different symbol name to the element value.

In addition to symbols in the `<iterate>` scope, child descriptors of `<iterate>` can also refer to symbols from the `<dump>` and `<database>` scopes.

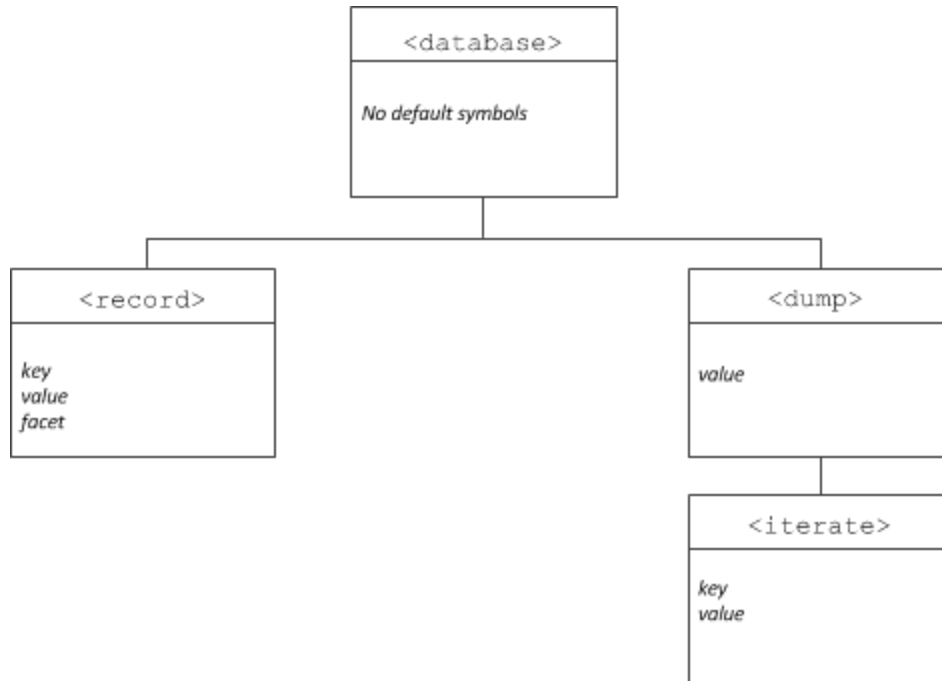

Relationship between descriptors and scopes.

## Command Line Options for `dumpdb`

The tool supports the [standard command-line options](#) common to all Slice processors listed. The options specific to `dumpdb` are described below:

- `--load SLICE`  
Loads the Slice definitions contained in the file `SLICE`. This option may be specified multiple times if several files must be loaded. However, it is the user's responsibility to ensure that duplicate definitions do not occur (which is possible when two files are loaded that share a common include file). One strategy for avoiding duplicate definitions is to load a single Slice file that contains only `#include` statements for each of the Slice files to be loaded. No duplication is possible in this case if the included files use include guards correctly.
- `--key TYPE`  
`--value TYPE`  
Specifies the Slice type of the database key and value. If these options are not specified, and the `-e` option is not used, `dumpdb` obtains type information from the [Freeze catalog](#).
- `-e`  
Indicates that a [Freeze evictor](#) database is being examined. As a convenience, this option automatically sets the database key and value types to those appropriate for the Freeze evictor, and therefore the `--key` and `--value` options are not necessary. Specifically, the key type of a Freeze evictor database is `Ice::Identity`, and the value type is `Freeze::ObjectRecord`. The latter is defined in the Slice file `Freeze/EvictorStorage.ice`, however this file does not need to be explicitly loaded. If this option is not specified, and the `--key` and `--value` options are not used, `dumpdb` obtains type information from the [Freeze catalog](#).
- `-o FILE`  
Create a file named `FILE` containing sample descriptors for the loaded Slice definitions. If type information is not specified, `dumpdb` obtains it from the [Freeze catalog](#). If the `--select` option is used, its expression is included in the sample descriptors. Database traversal does not occur when the `-o` option is used.
- `-f FILE`  
Execute the descriptors in the file named `FILE`. The file's `<database>` descriptor specifies the key and value types; therefore it is not necessary to supply type information.



- `--select EXPR`  
Only display those records for which the [expression](#) *EXPR* is true. The expression can refer to the symbols `key` and `value`.
- `-c, --catalog`  
Display information about the databases in an environment, or about a particular database. This option presents the type information contained in the [Freeze catalog](#).

## Database Arguments for `dumpdb`

If `dumpdb` is invoked to examine a database, it requires two arguments:

- `dbenv`  
The pathname of the database environment directory.
- `db`  
The name of the database file. `dumpdb` opens this database as read-only, and traversal occurs within a transaction.

To display [catalog](#) information using the `-c` option, the database environment directory `dbenv` is required. If the database file argument `db` is omitted, `dumpdb` displays information about every database in the catalog.

## `dumpdb` Use Cases

The [command line options](#) support several modes of operation:

- Dump an entire database.
- Dump selected records of a database.
- Emit a sample descriptor file.
- Execute a descriptor file.
- Examine the catalog.

These use cases are described in the following sections.

### Dump an Entire Database

The simplest way to examine a database with `dumpdb` is to dump its entire contents. You must specify the database key and value types, load the necessary Slice definitions, and supply the names of the database environment directory and database file. For example, this command dumps a Freeze map database whose key type is `string` and value type is `Employee`:

```
$ dumpdb --key string --value ::Employee --load Employee.ice db emp.db
```

As a convenience, you may omit the key and value types, in which case `dumpdb` obtains them from the [catalog](#):

```
$ dumpdb --load Employee.ice db emp.db
```

### Dump Selected Records

If only certain records are of interest to you, the `--select` option provides a convenient way to filter the output of `dumpdb` using an [expression](#). In the following example, we select employees from the accounting department:

```
$ dumpdb --load Employee.ice --select "value.dept == 'Accounting'" db
emp.db
```

In cases where the database records contain polymorphic class instances, you must be careful to specify an expression that can be

successfully evaluated against all records. For example, `dumpdb` fails immediately if the expression refers to a data member that does not exist in the class instance. The safest way to write an expression in this case is to check the type of the class instance before referring to any of its data members.

In the example below, we assume that a Freeze evictor database contains instances of various classes in a class hierarchy, and we are only interested in instances of `Manager` whose employee count is greater than 10:

```
$ dumpdb -e --load Employee.ice \
--select "value.servant.ice_id == '::Manager' and \
value.servant.group.length > 10" \
db emp.db
```

Alternatively, if `Manager` has derived classes, then the expression can be written in a different way so that instances of `Manager` and any of its derived classes are considered:

```
$ dumpdb -e --load Employee.ice \
--select "value.servant.ice_isA('::Manager') and \
value.servant.group.length > 10" \
db emp.db
```

### Creating a Sample Descriptor File

If you require more sophisticated filtering or scripting capabilities, then you must use a descriptor file. The easiest way to get started with a descriptor file is to generate a template using `dumpdb`:

```
$ dumpdb --key string --value ::Employee --load Employee.ice -o dump.xml
```

The output file `dump.xml` is complete and can be executed immediately if desired, but typically the file is used as a starting point for further customization. Again, you may omit the key and value types by specifying the database instead:

```
$ dumpdb --load Employee.ice -o dump.xml db emp.db
```

If the `--select` option is specified, its expression is included in the generated `<record>` descriptor as the value of the `test` attribute in an `<if>` descriptor.

`dumpdb` terminates immediately after generating the output file.

### Executing a Descriptor File

Use the `-f` option when you are ready to execute a descriptor file. For example, we can execute the descriptor we generated in the previous section using this command:

```
$ dumpdb -f dump.xml --load Employee.ice db emp.db
```

### Examine the Catalog

The `-c` option displays the contents of the database environment's `catalog`:

```
$ dumpdb -c db
```

The output indicates whether each database in the environment is associated with an evictor or a map. For maps, the output includes the key and value types.

If you specify the name of a database, `dumpdb` only displays the type information for that database:

```
$ dumpdb -c db emp.db
```

## Using `dumpdb` on an Open Environment

It is possible to use `dumpdb` to migrate databases in an environment that is currently open by another process, but if you are not careful you can easily corrupt the environment and cause the other process to fail. To avoid such problems, you must configure both `dumpdb` and the other process to set `Freeze.DbEnv.env-name.DbPrivate=0`. This property has a default value of one, therefore you must explicitly set it to zero.

If you run `dumpdb` on an open environment but neglect to set `Freeze.DbEnv.env-name.DbPrivate=0`, you can expect `dumpdb` to terminate immediately with an error message stating that the database environment is locked. Before running `dumpdb` on an open environment, we strongly recommend that you first verify that the other process was also configured with `Freeze.DbEnv.env-name.DbPrivate=0`.

### See Also

- [Using the Slice Compilers](#)
- [Freeze Catalogs](#)
- [Freeze Evictors](#)
- [FreezeScript Descriptor Expression Language](#)
- [Freeze Properties](#)

## FreezeScript Inspection XML Reference

This page describes the XML elements comprising the FreezeScript inspection descriptors.

On this page:

- [<dumpdb> Descriptor Element](#)
- [<database> Descriptor Element](#)
- [<record> Descriptor Element](#)
- [<dump> Descriptor Element](#)
- [<iterate> Descriptor Element](#)
- [<if> Descriptor Element](#)
- [<set> Descriptor Element](#)
- [<add> Descriptor Element](#)
- [<define> Descriptor Element](#)
- [<remove> Descriptor Element](#)
- [<fail> Descriptor Element](#)
- [<echo> Descriptor Element](#)

### <dumpdb> Descriptor Element

The top-level descriptor in a descriptor file. It requires one child descriptor, `<database>`, and supports any number of `<dump>` descriptors. This descriptor has no attributes.

### <database> Descriptor Element

The attributes of this descriptor define the key and value types of the database. It supports any number of child descriptors, but at most one `<record>` descriptor. The `<database>` descriptor also creates a [global scope](#) for user-defined symbols.

The attributes supported by the `<database>` descriptor are described in the following table:

Name	Description
key	Specifies the Slice type of the database key.
value	Specifies the Slice type of the database value.

As an example, consider the following `<database>` descriptor. In this case, the [Freeze map](#) to be examined has key type `int` and value type `::Employee`:

**XML**

```
<database key="int" value="::Employee">
```

### <record> Descriptor Element

Commences the database traversal. Child descriptors are executed for each record in the database, but after any `<dump>` descriptors are executed. The `<record>` descriptor introduces the read-only symbols `key`, `value` and `facet` into a local scope. These symbols are accessible to child descriptors, but not to `<dump>` descriptors. The `facet` symbol is a string indicating the [facet name](#) of the object in the current record, and is only relevant for [Freeze evictor](#) databases.

Note that database traversal only occurs if a `<record>` descriptor is present.

### <dump> Descriptor Element

Executed for all instances of a Slice type. Only one `<dump>` descriptor can be specified for a type, but a `<dump>` descriptor is not required for every type. The read-only symbol `value` is introduced into a local scope. The attributes supported by this descriptor are described in the

following table:

Name	Description
type	Specifies the Slice <code>type</code> ID.
base	If <code>type</code> denotes a Slice class, this attribute determines whether the <code>&lt;dump&gt;</code> descriptor of the base class is invoked. If <code>true</code> , the base class descriptor is invoked after executing the child descriptors. If not specified, the default value is <code>true</code> .
contents	For <code>class</code> and <code>struct</code> types, this attribute determines whether descriptors are executed for members of the value. For <code>sequence</code> and <code>dictionary</code> types, this attribute determines whether descriptors are executed for elements. If not specified, the default value is <code>true</code> .

Below is an example of a `<dump>` descriptor that searches for certain products:

XML
<pre>&lt;dump type="::Product"&gt;   &lt;if test="value.description.find('scanner') != -1"&gt;     &lt;echo message="Scanner SKU: " value="value.SKU"/&gt;   &lt;/if&gt; &lt;/dump&gt;</pre>

For class types, `dumpdb` first attempts to locate a `<dump>` descriptor for the object's most-derived type. If no descriptor is found, `dumpdb` proceeds up the class hierarchy in an attempt to find a descriptor. The base object type, `Object`, is the root of every class hierarchy and is included in the search for descriptors. It is therefore possible to define a `<dump>` descriptor for type `Object`, which will be invoked for every class instance.

Note that `<dump>` descriptors are executed recursively. For example, consider the following Slice definitions:

Slice
<pre>struct Inner {   int sum; }; struct Outer {   Inner i; };</pre>

When `dumpdb` is interpreting a value of type `Outer`, it executes the `<dump>` descriptor for `Outer`, then recursively executes the `<dump>` descriptor for the `Inner` member, but only if the `contents` attribute of the `Outer` descriptor has the value `true`.

### `<iterate>` Descriptor Element

Iterates over a dictionary or sequence, executing child descriptors for each element. The symbol names selected to represent the element information may conflict with existing symbols in the enclosing scope, in which case those outer symbols are not accessible to child descriptors. The attributes supported by this descriptor are described in the following table:

Name	Description
------	-------------

target	The sequence or dictionary.
index	The symbol name used for the sequence index. If not specified, the default symbol is <code>i</code> .
element	The symbol name used for the sequence element. If not specified, the default symbol is <code>elem</code> .
key	The symbol name used for the dictionary key. If not specified, the default symbol is <code>key</code> .
value	The symbol name used for the dictionary value. If not specified, the default symbol is <code>value</code> .

Shown below is an example of an `<iterate>` descriptor that displays the name of an employee if the employee's salary is greater than \$3000.

XML
<pre>&lt;iterate target="value.employeeMap" key="id" value="emp"&gt;   &lt;if test="emp.salary &gt; 3000"&gt;     &lt;echo message="Employee: " value="emp.name" /&gt;   &lt;/if&gt; &lt;/iterate&gt;</pre>

### `<if>` Descriptor Element

Conditionally executes child descriptors. The attributes supported by this descriptor are described in the following table:

Name	Description
test	A boolean expression.

Child descriptors are executed if the expression in `test` evaluates to true.

### `<set>` Descriptor Element

Modifies a value. The `value` and `type` attributes are mutually exclusive. If `target` denotes a dictionary element, that element must already exist (i.e., `<set>` cannot be used to add an element to a dictionary). The attributes supported by this descriptor are described in the following table:

Name	Description
target	An <a href="#">expression</a> that must select a modifiable value.
value	An <a href="#">expression</a> that must evaluate to a value compatible with the target's type.
type	The Slice <a href="#">type ID</a> of a class to be instantiated. The class must be compatible with the target's type.

length	An integer <a href="#">expression</a> representing the desired new length of a sequence. If the new length is less than the current size of the sequence, elements are removed from the end of the sequence. If the new length is greater than the current size, new elements are added to the end of the sequence. If <code>value</code> or <code>type</code> is also specified, it is used to initialize each new element.
convert	If <code>true</code> , additional type conversions are supported: between integer and floating point, and between integer and enumeration. Transformation fails immediately if a range error occurs. If not specified, the default value is <code>false</code> .

The `<set>` descriptor below modifies a member of a dictionary element:

XML
<pre>&lt;set target="new.parts['P105J3'].cost" value="new.parts['P105J3'].cost * 1.05"/&gt;</pre>

This `<set>` descriptor adds an element to a sequence and initializes its value:

XML
<pre>&lt;set target="new.partsList" length="new.partsList.length + 1" value="'P105J3'"/&gt;</pre>

### `<add>` Descriptor Element

Adds a new element to a sequence or dictionary. It is legal to add an element while traversing the sequence or dictionary using `<iterate>`, however the traversal order after the addition is undefined. The `key` and `index` attributes are mutually exclusive, as are the `value` and `type` attributes. If neither `value` nor `type` is specified, the new element is initialized with a default value. The attributes supported by this descriptor are described in the following table:

Name	Description
target	An <a href="#">expression</a> that must select a modifiable sequence or dictionary.
key	An <a href="#">expression</a> that must evaluate to a value compatible with the target dictionary's key type.
index	An <a href="#">expression</a> that must evaluate to an integer value representing the insertion position. The new element is inserted before <code>index</code> . The value must not exceed the length of the target sequence.
value	An <a href="#">expression</a> that must evaluate to a value compatible with the target dictionary's value type, or the target sequence's element type.
type	The Slice <a href="#">type ID</a> of a class to be instantiated. The class must be compatible with the target dictionary's value type, or the target sequence's element type.

convert	If <code>true</code> , additional type conversions are supported: between integer and floating point, and between integer and enumeration. Transformation fails immediately if a range error occurs. If not specified, the default value is <code>false</code> .
---------	------------------------------------------------------------------------------------------------------------------------------------------------------------------------------------------------------------------------------------------------------------------

Below is an example of an `<add>` descriptor that adds a new dictionary element and then initializes its member:

```
XML
```

```
<add target="new.parts" key="'P105J4'"/>
<set target="new.parts['P105J4'].cost" value="3.15"/>
```

### `<define>` Descriptor Element

Defines a new symbol in the current scope. The attributes supported by this descriptor are described in the following table:

Name	Description
name	The name of the new symbol. An error occurs if the name matches an existing symbol in the current scope.
type	The name of the symbol's formal Slice type.
value	An <a href="#">expression</a> that must evaluate to a value compatible with the symbol's type.
convert	If <code>true</code> , additional type conversions are supported: between integer and floating point, and between integer and enumeration. Execution fails immediately if a range error occurs. If not specified, the default value is <code>false</code> .

Below are two examples of the `<define>` descriptor. The first example defines the symbol `identity` to have type `Ice::Identity`, and proceeds to initialize its members using `<set>`:

```
XML
```

```
<define name="identity" type="::Ice::Identity"/>
<set target="identity.name" value="steve"/>
<set target="identity.category" value="Admin"/>
```

The second example uses the enumeration we first saw in our discussion of [custom database migration](#) to define the symbol `manufacturer` and assign it a default value:

```
XML
```

```
<define name="manufacturer" type="::BigThree"
value="::DaimlerChrysler"/>
```

### `<remove>` Descriptor Element

Removes an element from a sequence or dictionary. It is legal to remove an element while traversing a sequence or dictionary using `<itera`



`te`), however the traversal order after removal is undefined. The attributes supported by this descriptor are described in the following table:

Name	Description
<code>target</code>	An <a href="#">expression</a> that must select a modifiable sequence or dictionary.
<code>key</code>	An <a href="#">expression</a> that must evaluate to a value compatible with the key type of the target dictionary.
<code>index</code>	An <a href="#">expression</a> that must evaluate to an integer value representing the index of the sequence element to be removed.

### <fail> Descriptor Element

Causes transformation to fail immediately. If `test` is specified, transformation fails only if the expression evaluates to `true`. The attributes supported by this descriptor are described in the following table:

Name	Description
<code>message</code>	A message to display upon transformation failure.
<code>test</code>	A boolean <a href="#">expression</a> .

The following `<fail>` descriptor terminates the transformation if a range error is detected:

```

XML
<fail message="range error occurred in ticket count!"
test="value.ticketCount > 32767"/>
```

### <echo> Descriptor Element

Displays values and informational messages. If no attributes are specified, only a newline is printed. The attributes supported by this descriptor are described in the following table:

Name	Description
<code>message</code>	A message to display.
<code>value</code>	An <a href="#">expression</a> . The value of the expression is displayed in a structured format.

Shown below is an `<echo>` descriptor that uses both `message` and `value` attributes:

```

XML
<if test="value.ticketCount > 32767">
 <echo message="range error occurred in ticket count: "
value="value.ticketCount" />
</if>
```

**See Also**

- [Freeze Maps](#)
- [Freeze Evictors](#)
- [Facets and Versioning](#)
- [Custom Database Migration](#)
- [FreezeScript Descriptor Expression Language](#)

## FreezeScript Descriptor Expression Language

An expression language is provided for use in FreezeScript descriptors.

On this page:

- [Operators in FreezeScript](#)
- [Literals in FreezeScript](#)
- [Symbols in FreezeScript](#)
- [The `nil` Keyword in FreezeScript](#)
- [Accessing Elements in FreezeScript](#)
- [Reserved Keywords in FreezeScript](#)
- [Implicit Data Members in FreezeScript](#)
- [Calling Functions in FreezeScript](#)
  - [String Member Functions](#)
  - [Dictionary Member Functions](#)
  - [Object Member Functions](#)
  - [Global Functions](#)

### Operators in FreezeScript

The language supports the usual complement of operators: `and`, `or`, `not`, `{+}`, `-`, `/`, `*`, `%`, `<`, `>`, `==`, `!=`, `<=`, `>=`, `(`, `)`. Note that the `<` character must be escaped as `&lt;t;` in order to comply with XML syntax restrictions.

### Literals in FreezeScript

Literal values can be specified for integer, floating point, boolean, and string. The expression language supports the same [syntax for literal values](#) as that of Slice, with one exception: string literals must be enclosed in single quotes.

### Symbols in FreezeScript

Certain descriptors introduce symbols that can be used in expressions. These symbols must comply with the naming rules for Slice identifiers (i.e., a leading letter followed by zero or more alphanumeric characters). Data members are accessed using dotted notation, such as `value.memberA.memberB`.

Expressions can refer to Slice constants and enumerators using scoped names. In a `transformdb` descriptor, there are two sets of Slice definitions, therefore the expression must indicate which set of definitions it is accessing by prefixing the scoped name with `::Old` or `::New`. For example, the expression `old.fruitMember == ::Old::Pear` evaluates to `true` if the data member `fruitMember` has the enumerated value `Pear`. In `dumpdb`, only one set of Slice definitions is present and therefore the constant or enumerator can be identified without any special prefix.

### The `nil` Keyword in FreezeScript

The keyword `nil` represents a nil value of type `Object`. This keyword can be used in expressions to test for a nil object value, and can also be used to set an object value to nil.

### Accessing Elements in FreezeScript

Dictionary and sequence elements are accessed using array notation, such as `userMap['joe']` or `stringSeq[5]`. An error occurs if an expression attempts to access a dictionary or sequence element that does not exist. For dictionaries, the recommended practice is to check for the presence of a key before accessing it:

**XML**

```
<if test="userMap.containsKey('joe') and userMap['joe'].active">
```

(This example shows that you can also [call functions](#) in FreezeScript.)

Similarly, expressions involving sequences should check the length of the sequence:

**XML**

```
<if test="stringSeq.length > 5 and stringSeq[5] == 'fruit'">
```

The `length` member is an [implicit data member](#).

## Reserved Keywords in FreezeScript

The following keywords are reserved: `and`, `or`, `not`, `true`, `false`, `nil`.

## Implicit Data Members in FreezeScript

Certain Slice types support implicit data members:

- Dictionary and sequence instances have a member `length` representing the number of elements.
- Object instances have a member `ice_id` denoting the actual type of the object.

## Calling Functions in FreezeScript

The expression language supports two forms of function invocation: member functions and global functions. A member function is invoked on a particular data value, whereas global functions are not bound to a data value. For instance, here is an expression that invokes the `find` member function of a `string` value:

```
old.stringValue.find('theSubstring') != -1
```

And here is an example that invokes the global function `stringToIdentity`:

```
stringToIdentity(old.stringValue)
```

If a function takes multiple arguments, the arguments must be separated with commas.

## String Member Functions

The `string` data type supports the following member functions:

- `int find(string match[, int start])`  
Returns the index of the substring, or `-1` if not found. A starting position can optionally be supplied.
- `string replace(int start, int len, string str)`  
Replaces a given portion of the string with a new substring, and returns the modified string.
- `string substr(int start[, int len])`

Returns a substring beginning at the given start position. If the optional length argument is supplied, the substring contains at most `length` characters, otherwise the substring contains the remainder of the string.

## Dictionary Member Functions

The `dictionary` data type supports the following member function:

- `bool containsKey(key)`  
Returns `true` if the dictionary contains an element with the given key, or `false` otherwise. The `key` argument must have a value that is compatible with the dictionary's key type.

## Object Member Functions

Object instances support the following member function:

- `bool ice_isA(string id)`  
Returns `true` if the object implements the given interface type, or `false` otherwise. This function cannot be invoked on a `nil` object.

## Global Functions

The following global functions are provided:

- `string generateUUID()`  
Returns a new UUID.
- `string identityToString(Ice::Identity id)`  
Converts an identity into its string representation.
- `string lowercase(string str)`  
Returns a new string converted to lowercase.
- `string proxyToString(Ice::ObjectPrx prx)`  
Returns the string representation of the given proxy.
- `Ice::Identity stringToIdentity(string str)`  
Converts a string into an `Ice::Identity`.
- `Ice::ObjectPrx stringToProxy(string str)`  
Converts a string into a proxy.
- `string typeOf(val)`  
Returns the formal Slice type of the argument.

### See Also

- [Constants and Literals](#)

# IceSSL

Security is an important consideration for many distributed applications, both within corporate intranets as well as over untrusted networks, such as the Internet. The ability to protect sensitive information, ensure its integrity, and verify the identities of the communicating parties is essential for developing secure applications. With those goals in mind, Ice includes the IceSSL *plug-in* that provides these capabilities using the Secure Socket Layer (SSL) protocol.

Although security is an optional component of Ice, it is not an afterthought. The IceSSL plug-in integrates easily into existing Ice applications, in most cases requiring nothing more than configuration changes. Naturally, some additional effort is required to create the necessary security infrastructure for an application, but in many enterprises this work will have already been done.



IceSSL is available for C++, Java and .NET applications. Python, PHP and Ruby applications can use IceSSL for C++ via configuration.

On this page:

- [Overview of SSL](#)
- [Public Key Infrastructure](#)
- [Requirements](#)

## Overview of SSL

The Secure Socket Layer (SSL) protocol is the de facto standard for secure network communication. Its support for authentication, non-repudiation, data integrity, and strong encryption makes it the logical choice for securing Ice applications.

SSL is the protocol [1] that enables Web browsers to conduct secure transactions and therefore is one of the most commonly used protocols for secure network communication. You do not need to know the technical details of the SSL protocol in order to use IceSSL successfully (and those details are outside the scope of this text). However, it would be helpful to have a high-level understanding of how the protocol works and the infrastructure required to support it.

SSL provides a secure environment for communication (without sacrificing too much performance) by combining a number of cryptographic techniques:

- public key encryption
- symmetric (shared key) encryption
- message authentication codes
- digital certificates

When a client establishes an SSL connection to a server, a *handshake* is performed. During a typical handshake, digital certificates that identify the communicating parties are validated, and symmetric keys are exchanged for encrypting the session traffic. Public key encryption, which is too slow to be used for the bulk of a session's data transfer, is used heavily during the handshaking phase. Once the handshake is complete, SSL uses message authentication codes to ensure data integrity, allowing the client and server to communicate at will with reasonable assurance that their messages are secure.

## Public Key Infrastructure

Security requires trust, and public key cryptography by itself does nothing to establish trust. SSL addresses the issue of trust using Public Key Infrastructure (PKI) [2], which binds public keys to identities using certificates. A certificate *issuer* creates a certificate for an entity, called the *subject*. The subject is often a person, but it may also be a computer or a specific application. The subject's identity is represented by a *distinguished name*, which includes information such as the subject's name, organization and location. A certificate alone is not sufficient to establish the subject's identity, however, as anyone can create a certificate for a particular distinguished name.

In order to authenticate a certificate, we need a third-party to guarantee that the certificate belongs to the subject described by the distinguished name. This third party, called a Certificate Authority (CA), expresses this guarantee by using its own private key to sign the subject's certificate. Combining the CA's certificate with the subject's certificate forms a *certificate chain* that provides SSL with most of the information it needs to authenticate the remote peer. In many cases, the chain contains only the aforementioned two certificates, but it is also

possible for the chain to be longer when the *root CA* issues a certificate that the subject may use to sign other certificates. Regardless of the length of the chain, this scheme can only work if we trust that the root CA has sufficiently verified the identity of the subject before issuing the certificate.

An implementation of the SSL protocol also needs to know which root CAs we trust. An application supplies that information as a list of certificates representing the trusted root CAs. With that list in hand, the SSL implementation authenticates a peer by obtaining the peer's certificate chain and examining it carefully for validity. If we view the chain as a hierarchy with the root CA certificate at the top and the peer's certificate at the bottom, we can describe SSL's validation activities as follows:

- The root CA certificate must be self-signed and be present among the application's trusted CA certificates.
- All other certificates in the chain must be signed by the one immediately preceding it.
- The certificates must not be expired or revoked.

These tests certify that the chain is valid, but applications often require the chain to undergo more intensive scrutiny to determine whether the chain is [trustworthy](#).

Commercial CAs exist to supply organizations with a reliable source of certificates, but in many cases a private CA is completely sufficient. You can create and manage your CA using freely-available tools, and in fact Ice includes a [collection of utilities](#) that simplify this process.

Depending on your implementation language, it may also be possible to avoid the use of certificates altogether; encryption is still used to obscure the session traffic, but the benefits of authentication are sacrificed in favor of reduced complexity and administration.

## Requirements

Integrating IceSSL into your application often requires no changes to your source code, but does involve the following administrative tasks:

- creating a public key infrastructure (if necessary)
- configuring the IceSSL plug-in
- modifying your application's configuration to install the IceSSL plug-in and use secure connections

The remainder of this discussion concentrates on plug-in configuration and programming.

## Topics

- [Using IceSSL](#)
- [Configuring IceSSL](#)
- [Programming IceSSL](#)
- [Advanced IceSSL Topics](#)
- [Setting up a Certificate Authority](#)

## References

1. Viega, J., et al. 2002. *Network Security with OpenSSL*. Sebastopol, CA: O'Reilly.
2. Housley, R., and T. Polk. 2001. *Planning for PKI: Best Practices Guide for Deploying Public Key Infrastructure*. Hoboken, NJ: Wiley.

## Using IceSSL

Incorporating IceSSL into your application requires installing the plug-in, configuring it according to your security requirements, and creating SSL endpoints.

On this page:

- [Installing IceSSL](#)
  - [C++ Applications](#)
  - [Java Applications](#)
  - [.NET Applications](#)
  - [Ice Touch Applications](#)
- [Creating SSL Endpoints](#)
- [Endpoint Security Considerations](#)

## Installing IceSSL

Ice supports a generic [plug-in facility](#) that allows extensions (such as IceSSL) to be installed dynamically without changing the application source code. The `Ice.Plugin` property provides language-specific information that enables the Ice run time to install a plug-in.

### C++ Applications

The executable code for the IceSSL C++ plug-in resides in a shared library on Unix and a dynamic link library (DLL) on Windows. The format for the `Ice.Plugin` property is shown below:

```
Ice.Plugin.IceSSL=IceSSL:createIceSSL
```

The last component of the property name (`IceSSL`) becomes the plug-in's official identifier for configuration purposes, but the IceSSL plug-in requires its identifier to be `IceSSL`. The property value `IceSSL:createIceSSL` is sufficient to allow the Ice run time to locate the IceSSL library (on both Unix and Windows) and initialize the plug-in. The only requirement is that the library reside in a directory that appears in the shared library path (`LD_LIBRARY_PATH` on most Unix platforms, `PATH` on Windows).

Additional [configuration properties](#) are usually necessary as well.

### Java Applications

The format for the `Ice.Plugin` property is shown below:

```
Ice.Plugin.IceSSL=IceSSL.PluginFactory
```

The last component of the property name (`IceSSL`) becomes the plug-in's official identifier for configuration purposes, but the IceSSL plug-in requires its identifier to be `IceSSL`. The property value `IceSSL.PluginFactory` is the name of a class that allows the Ice run time to initialize the plug-in. The IceSSL classes are included in `Ice.jar`, therefore no other changes to your `CLASSPATH` are necessary.

Additional [configuration properties](#) are usually necessary as well.

### .NET Applications

The format for the `Ice.Plugin` property is shown below:

```
Ice.Plugin.IceSSL=C:/Ice/bin/IceSSL.dll:IceSSL.PluginFactory
```

The last component of the property name (`IceSSL`) becomes the plug-in's official identifier for configuration purposes, but the IceSSL plug-in



requires its identifier to be `IceSSL`. The property value contains the file name of the `IceSSL` assembly as well as the name of a class, `IceSSL.PluginFactory`, that allows the Ice run time to initialize the plug-in.

You may also specify a partially or fully qualified assembly name instead of the file name in an `Ice.Plugin` property. For example, you can use the following configuration to load the plug-in from the release version of the assembly provided in ZeroC's binary distribution:

#### Release Key

```
Ice.Plugin.IceSSL=IceSSL,Version=3.4.2.0,Culture=neutral,PublicKeyToken=cdd571ade22f2f16:IceSSL.PluginFactory
```

Alternatively, if you have built the Ice source code yourself, you can load the development version of the assembly as shown below:

#### Development Key

```
Ice.Plugin.IceSSL=IceSSL,Version=3.4.2.0,Culture=neutral,PublicKeyToken=1f998c50fec78381:IceSSL.PluginFactory
```



You *must* use a fully qualified assembly name to load the `IceSSL` plug-in from the Global Assembly Cache.

Additional [configuration properties](#) are usually necessary as well.

## Ice Touch Applications

The `IceSSL` plug-in is included in the Ice Touch run time and installed automatically, therefore it is not necessary to explicitly load it. However, [configuration properties](#) are usually necessary.

## Creating SSL Endpoints

Installing the `IceSSL` plug-in enables you to use a new protocol, `ssl`, in your endpoints. For example, the following [adapter endpoint](#) list creates a TCP endpoint, an SSL endpoint, and a UDP endpoint:

```
MyAdapter.Endpoints=tcp -p 4063:ssl -p 4064:udp -p 4063
```

As this example demonstrates, it is possible for a UDP endpoint to use the same port number as a TCP or SSL endpoint, because UDP is a different protocol and therefore has an independent set of ports. It is not possible for a TCP endpoint and an SSL endpoint to use the same port number, because SSL is essentially a layer over TCP.

Using SSL in [proxy endpoints](#) is equally straightforward:

```
MyProxy=MyObject:tcp -p 4063:ssl -p 4064:udp -p 4063
```

## Endpoint Security Considerations

Defining an object adapter's endpoints to use multiple protocols, [as shown above](#), has obvious security implications. If your intent is to use SSL to protect session traffic and/or restrict access to the server, then you should only define SSL endpoints.

There can be situations, however, in which insecure endpoint protocols are advantageous. The figure below illustrates an environment in which TCP endpoints are allowed behind the firewall, but external clients are required to use SSL:

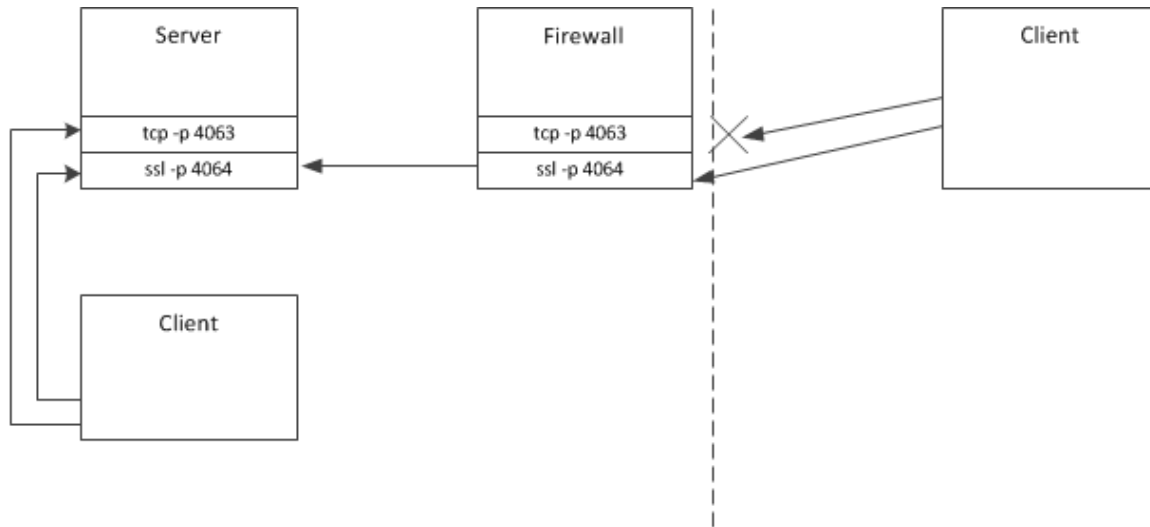

*An application of multiple protocol endpoints.*

The firewall in the illustration is configured to block external access to TCP port 4063 and to forward connections to port 4064 to the server machine.

One reason for using TCP behind the firewall is that it is more efficient than SSL and requires less administrative work. Of course, this scenario assumes that internal clients can be trusted, which is not true in many environments.

For more information on using SSL in complex network architectures, refer to our discussion of the [Glacier2 router](#).

#### See Also

- [Plug-in Facility](#)
- [Configuring IceSSL](#)
- [Object Adapter Endpoints](#)
- [Proxy Endpoints](#)
- [Glacier2](#)
- [Ice Plug-In Properties](#)

## Configuring IceSSL

After installing IceSSL, an application typically needs to define a handful of additional [properties](#) to configure settings such as the location of certificate and key files. This page provides an introduction to configuring the plug-in for each of the supported language mappings.

On this page:

- [C++ Configuration for IceSSL](#)
  - [DSA Example for C++](#)
  - [RSA and DSA Example for C++](#)
  - [ADH Example for C++](#)
- [Java Configuration for IceSSL](#)
  - [DSA Example for Java](#)
  - [ADH Example for Java](#)
- [.NET Configuration for IceSSL](#)
  - [Managing Certificates with the Microsoft Management Console](#)
  - [Using Certificate Files](#)
  - [Using Certificate Stores](#)
  - [Importing Certificates](#)
  - [Importing Private Keys](#)
- [Ice Touch Configuration for IceSSL](#)
  - [Keychains](#)
- [Configuring Ciphersuites](#)
  - [Configuring Ciphersuites in C++](#)
  - [Configuring Ciphersuites in Java](#)
- [Configuring Trust Relationships](#)
  - [Trusted Peers](#)
  - [Verification Depth](#)
- [Configuring Secure Proxies](#)
- [IceSSL Diagnostics](#)
  - [System Logging in Java](#)
  - [System Logging in .NET](#)

### C++ Configuration for IceSSL

Our first example shows the properties that are sufficient in many situations:

```
Ice.Plugin.IceSSL=IceSSL:createIceSSL
IceSSL.DefaultDir=/opt/certs
IceSSL.CertFile=pubkey.pem
IceSSL.KeyFile=privkey.pem
IceSSL.CertAuthFile=ca.pem
IceSSL.Password=password
```

The `IceSSL.DefaultDir` property is a convenient way to specify the default location of your certificate and key files. The three properties that follow it define the files containing the program's certificate, private key, and trusted CA certificate, respectively. This example assumes the files contain RSA keys, and IceSSL requires the files to use the Privacy Enhanced Mail (PEM) encoding. Finally, the `IceSSL.Password` property specifies the password of the private key.

Note that it is a security risk to define a password in a plain text file, such as an Ice configuration file, because anyone who can gain read access to your configuration file can obtain your password. IceSSL also supports [alternate ways](#) to supply a password.

### DSA Example for C++

If you used DSA to generate your keys, one additional property is necessary:

```
Ice.Plugin.IceSSL=IceSSL:createIceSSL
IceSSL.DefaultDir=/opt/certs
IceSSL.CertFile=pubkey_dsa.pem
IceSSL.KeyFile=privkey_dsa.pem
IceSSL.CertAuthFile=ca.pem
IceSSL.Password=password
IceSSL.Ciphers=DEFAULT:DSS
```

The `IceSSL.Ciphers` property adds support for DSS authentication to the plug-in's default set of ciphersuites.

## RSA and DSA Example for C++

It is also possible to specify certificates and keys for both RSA and DSA by including two filenames in the `IceSSL.CertFile` and `IceSSL.KeyFile` properties. The filenames must be separated using the platform's path separator. The example below demonstrates the Unix separator (a colon):

```
Ice.Plugin.IceSSL=IceSSL:createIceSSL
IceSSL.DefaultDir=/opt/certs
IceSSL.CertFile=pubkey_rsa.pem:pubkey_dsa.pem
IceSSL.KeyFile=privkey_rsa.pem:privkey_dsa.pem
IceSSL.CertAuthFile=ca.pem
IceSSL.Password=password
IceSSL.Ciphers=DEFAULT:DSS
```

On Windows, you would use a semicolon to separate the filenames.

## ADH Example for C++

The following example uses ADH (the Anonymous Diffie-Hellman cipher). ADH is not a good choice in most cases because, as its name implies, there is no authentication of the communicating parties, and it is vulnerable to man-in-the-middle attacks. However, it still provides encryption of the session traffic and requires very little administration and therefore may be useful in certain situations. The configuration properties shown below demonstrate how to use ADH:

```
Ice.Plugin.IceSSL=IceSSL:createIceSSL
IceSSL.Ciphers=ADH
IceSSL.VerifyPeer=0
```

The `IceSSL.Ciphers` property enables support for ADH, which is disabled by default.

The `IceSSL.VerifyPeer` property changes the plug-in's default behavior with respect to certificate verification. Without this setting, IceSSL rejects a connection if the peer does not supply a certificate (as is the case with ADH).

## Java Configuration for IceSSL

IceSSL uses Java's native format for storing keys and certificates: the keystore.

A keystore is represented as a file containing key pairs and associated certificates, and is usually administered using the `keytool` utility

supplied with the Java run time. Keystores serve two roles in Java's SSL architecture:

1. A keystore containing a key pair identifies the peer and is usually closely guarded.
2. A keystore containing public certificates represents the identities of trusted peers and can be freely shared. These keystores are also referred to as "truststores" when they are used to store only trusted certificate chains.

A single keystore file can fulfill both of these purposes.

Java supports a pluggable architecture for keystore implementations in which a system property selects a particular implementation as the default keystore type. IceSSL uses the default keystore type unless otherwise specified.

A password is assigned to each key pair in a keystore, as well as to the keystore itself. IceSSL must be provided with the password for the key pair, but the keystore password is optional. If a keystore password is specified, it is used only to verify the keystore's integrity. IceSSL requires that all of the key pairs in a keystore have the same password.

Our first example shows the properties that are sufficient in many situations:

```
Ice.Plugin.IceSSL=IceSSL.PluginFactory
IceSSL.DefaultDir=/opt/certs
IceSSL.Keystore=keys.jks
IceSSL.Truststore=ca.jks
IceSSL.Password=password
```

IceSSL resolves the filenames defined in its configuration properties as follows:

1. Attempt to open the file as a class loader resource. This is especially useful for deploying applications with special security restrictions, such as applets.
2. Attempt to open the file in the local file system.
3. If `IceSSL.DefaultDir` is defined, prepend its value and try steps 1 and 2 again. The `IceSSL.DefaultDir` property is a convenient way to specify the default location of your keystore and truststore files.

The `IceSSL.Password` property specifies the password of the key pair. Note that it is a security risk to define a password in a plain text file, such as an Ice configuration file, because anyone who can gain read access to your configuration file can obtain your password. IceSSL also supports [alternate ways](#) to supply a password.

## DSA Example for Java

Java supports both RSA and DSA keys. No additional properties are necessary to use DSA:

```
Ice.Plugin.IceSSL=IceSSL.PluginFactory
IceSSL.DefaultDir=/opt/certs
IceSSL.Keystore=dsakeys.jks
IceSSL.Truststore=ca.jks
IceSSL.Password=password
```

## ADH Example for Java

The following example uses ADH (the Anonymous Diffie-Hellman cipher). ADH is not a good choice in most cases because, as its name implies, there is no authentication of the communicating parties, and it is vulnerable to man-in-the-middle attacks. However, it still provides encryption of the session traffic and requires very little administration and therefore may be useful in certain situations. The configuration properties shown below demonstrate how to use ADH:

```
Ice.Plugin.IceSSL=IceSSL.PluginFactory
IceSSL.DefaultDir=/opt/certs
IceSSL.Ciphers=NONE (DH_anon)
IceSSL.VerifyPeer=0
```

The `IceSSL.Ciphers` property enables support for ADH, which is disabled by default.

The `IceSSL.VerifyPeer` property changes the plug-in's default behavior with respect to certificate verification. Without this setting, IceSSL rejects a connection if the peer does not supply a certificate (as is the case with ADH).

## .NET Configuration for IceSSL

The Common Language Runtime (CLR) in .NET uses certificate stores as the persistent repositories of certificates and keys. Furthermore, the CLR maintains two distinct sets of certificate stores, one for the current user and another for the local machine. Although it is possible to load a certificate and its corresponding private key from a regular file, the CLR requires trusted CA certificates to reside in an appropriate certificate store.

### Managing Certificates with the Microsoft Management Console

On Windows, you can use the Microsoft Management Console (MMC) to browse the contents of the various certificate stores. To start the console, run `MMC.EXE` from a command window, or choose Run from the Start menu and enter `MMC.EXE`.

Once the console is running, you need to install the Certificates "snap-in" by choosing Add/Remove Snap-in from the File menu. Click the Add button, choose Certificates in the popup window and click Add. If you wish to manage certificates for the current user, select My Current Account and click Finish. To manage certificates for the local computer, select Computer Account and click Next, then select Local Computer and click Finish.

When you have finished adding snap-ins, close the Add Standalone Snap-in window and click OK on the Add/Remove Snap-in window. Your Console Root window now contains a tree structure that you can expand to view the available certificate stores. If you have a certificate in a file that you want to add to a store, click on the desired store, then open the Action menu and select All Tasks/Import.

### Using Certificate Files

Our first example demonstrates how to configure IceSSL with a file that contains the program's certificate and key:

```
Ice.Plugin.IceSSL=IceSSL.dll:IceSSL.PluginFactory
IceSSL.DefaultDir=/opt/certs
IceSSL.CertFile=cert.pfx
IceSSL.Password=password
```

The `IceSSL.DefaultDir` property is a convenient way to specify the default location of your certificate file. This file must use the Personal Information Exchange (PFX, also known as PKCS#12) format and contain both a certificate and its corresponding private key. The `IceSSL.Password` property specifies the password used to secure the file.

Note that it is a security risk to define a password in a plain text file, such as an Ice configuration file, because anyone who can gain read access to your configuration file can obtain your password. IceSSL also supports [alternate ways](#) to supply a password.

This configuration assumes that any trusted CA certificates necessary to authenticate the program's peers are already installed in an appropriate certificate store. You may also use a configuration property to automatically import a certificate from a file, as described in below.

### Using Certificate Stores

If the program's certificate and private key are already installed in a certificate store, you can select it using the `IceSSL.FindCert` configuration property as shown in the following example:

```
Ice.Plugin.IceSSL=IceSSL.dll:IceSSL.PluginFactory
IceSSL.FindCert.LocalMachine.My=subject:"Quote Server"
```

An `IceSSL.FindCert` property executes a query in a particular certificate store and selects all of the certificates that match the given criteria. In the example above, the location of the certificate store is `LocalMachine`, and the store's name is `My`. When using MMC to browse the certificate stores, this specification is equivalent to the store "Personal" in the location "Certificates (Local Computer)."

The other legal value for the location component of the property name is `CurrentUser`. The following table shows the valid values for the store name component and their equivalents in MMC.

Property Name	MMC Name
AddressBook	Other People
AuthRoot	Third-Party Root Certification Authorities
CertificateAuthority	Intermediate Certification Authorities
Disallowed	Untrusted Certificates
My	Personal
Root	Trusted Root Certification Authorities
TrustedPeople	Trusted People
TrustedPublisher	Trusted Publishers

The search criteria consists of *name:value* pairs that perform case-insensitive comparisons against the fields of each certificate in the specified store, and the special property value `*` selects every certificate in the store. Typically, however, the criteria should select a single certificate. In a server, IceSSL must supply the CLR with the certificate that represents the server's identity; if a configuration matches several certificates, IceSSL chooses one (in an undefined manner) and logs a warning to notify you of the situation.

Selecting a certificate from a store is more secure than using a certificate file via the `IceSSL.CertFile` property because it is not necessary to specify a plain-text password. MMC prompts you for the password when initially importing a certificate into a store, so the password is not required when an application uses that certificate to identify itself.

## Importing Certificates

IceSSL can be configured to import a certificate into a particular store. The Ice demos and test suites use this capability to ensure that the CA certificate is present, which avoids the need for a user to manually import the certificate using MMC before using the Ice sample programs and tests.

The `IceSSL.ImportCert` property uses the same format for its name as the `IceSSL.FindCert` property described above, in that the certificate store's location and name are part of the property name:

```
IceSSL.ImportCert.LocalMachine.AuthRoot=cacert.pem
```

The property's value is the name of a certificate file and an optional password. If a file is protected with a password, append the password to the property value using a semicolon as the separator. IceSSL uses the value of `IceSSL.DefaultDir` to complete the file name if necessary. The CLR accepts a number of encoding formats for the certificate, including PEM, DER and PFX.

The store name should be chosen with care. When installing a trusted CA certificate, authentication succeeds only when the certificate is installed into one of the following stores:

- `LocalMachine.Root`
- `LocalMachine.AuthRoot`
- `CurrentUser.Root`

Note that administrative privileges are required when installing a certificate into a `LocalMachine` store.

If you specify a store name other than those listed in the table above, `IceSSL` creates a new store with the given name and adds the certificate to it. Once installed in the specified store, the application (or the user) is responsible for removing the certificate when it is no longer necessary.

## Importing Private Keys

`IceSSL` supports two properties for controlling how and where to import the private keys of X.509 certificates:

- `IceSSL.KeySet`
- `IceSSL.PersistKeySet`

If neither property is specified, `IceSSL` uses .NET's default behavior for importing private keys.

## Ice Touch Configuration for IceSSL

In `Ice Touch`, certificate files are loaded from the application's resource bundle. If the application's target platform is OS X, certificate files can also be loaded directly from the file system. Consider the following properties:

```
IceSSL.DefaultDir=certs
IceSSL.CertAuthFile=cacert.der
IceSSL.CertFile=cert.pfx
IceSSL.Password=password
```

The `IceSSL.DefaultDir` property is a convenient way to specify the location of your certificate files. Defining `IceSSL.DefaultDir` means `IceSSL` searches for certificate files relative to the specified directory. For the properties in the example above, `IceSSL` composes the pathnames `certs/cacert.der` and `certs/cert.pfx`. If `IceSSL.DefaultDir` is not defined, `IceSSL` uses the certificate file pathnames exactly as they are supplied.

As mentioned earlier, `IceSSL` has different semantics for locating certificate files depending on the target platform. For the iPhone and iPhone simulator, `IceSSL` attempts to open a certificate file in the application's resource bundle as `Resources/DefaultDir/file` if `IceSSL.DefaultDir` is defined, or as simply `Resources/file` otherwise. If the target platform is OS X and the certificate file cannot be found in the resource bundle, `IceSSL` also attempts to open the file in the file system as `DefaultDir/file` if a default directory is specified, or as simply `file` otherwise.

`IceSSL` requires that the CA certificate file specified by `IceSSL.CertAuthFile` use the DER format. The certificate file in `IceSSL.CertFile` must use the Personal Information Exchange (PEM, also known as PKCS#12) format and contain both a certificate and its corresponding private key. The `IceSSL.Password` property specifies the password used to secure the certificate file.

## Keychains

`IceSSL` imports the certificate specified by `IceSSL.CertFile` into a keychain. `IceSSL` uses the `login` keychain by default unless you choose a different one by defining the `IceSSL.Keychain` property:

```
IceSSL.Keychain=Test Keychain
```

The `login` keychain is the user's default keychain, which is normally unlocked after logging into the system. `IceSSL` does not usually require a password to import a certificate into the `login` keychain. However, if your `login` keychain is not unlocked automatically, or if you have selected a different keychain, you can supply a password using the `IceSSL.KeychainPassword` property:



```
IceSSL.KeychainPassword=password
```

## Configuring Ciphersuites

A ciphersuite represents a particular combination of encryption, authentication and hashing algorithms. The IceSSL plug-ins for C++ and Java allow you to configure the ciphersuites that their underlying SSL engines are allowed to negotiate during handshaking with a peer. By default, IceSSL uses the underlying engine's default ciphersuites, but you can define a property to customize the list as we demonstrated above with the ADH examples. Normally the default configuration is chosen to eliminate relatively insecure ciphersuites such as ADH, which is the reason it must be explicitly enabled.

### Configuring Ciphersuites in C++

The value of the `IceSSL.Ciphers` property is given directly to the low-level OpenSSL library, on which IceSSL is based. Therefore, OpenSSL determines the allowable ciphersuites, which in turn depend on how the OpenSSL distribution was compiled. You can obtain a complete list of the supported ciphersuites using the `openssl ciphers` command:

```
$ openssl ciphers
```

This command will likely generate a long list. To simplify the selection process, OpenSSL supports several classes of ciphers, as shown in the following table.

Class	Description
ALL	All possible combinations.
ADH	Anonymous ciphers.
LOW	Low bit-strength ciphers.
EXP	Export-crippled ciphers.

Classes and ciphers can be excluded by prefixing them with an exclamation point. The special keyword `@STRENGTH` sorts the cipher list in order of their strength, so that SSL gives preference to the more secure ciphers when negotiating a cipher suite. The `@STRENGTH` keyword must be the last element in the list.

For example, here is a good value for the `IceSSL.Ciphers` property:

```
ALL:!ADH:!LOW:!EXP:!MD5:@STRENGTH
```

This value excludes the ciphers with low bit strength and known problems, and orders the remaining ciphers according to their strength.

Note that no warning is given if an unrecognized cipher is specified.

### Configuring Ciphersuites in Java

IceSSL for Java interprets the value of `IceSSL.Ciphers` as a sequence of expressions that filter the selected ciphersuites using name and pattern matching. If the property is not defined, the Java security provider's default ciphersuites are used. The following table defines the valid expressions that may appear in the property value.

Expression	Description
NONE	Disables all ciphersuites. If specified, it must appear first.

ALL	Enables all supported ciphersuites. If specified, it must appear first. This expression should be used with caution, as it may enable low-security ciphersuites.
NAME	Enables the ciphersuite matching the given name.
!NAME	Disables the ciphersuite matching the given name.
(EXP)	Enables ciphersuites whose names contain the regular expression <i>EXP</i> .
!(EXP)	Disables ciphersuites whose names contain the regular expression <i>EXP</i> .

To determine the set of enabled ciphersuites, the plug-in begins with a list of ciphersuite names containing the default set as determined by the security provider. The expressions in the property value add and remove ciphersuites from this list and are evaluated in the order of appearance. For example, consider the following property definition:

```
IceSSL.Ciphers=NONE (RSA.*AES) !(EXPORT)
```

The expressions in this property have the following effects:

- NONE clears the list of enabled ciphersuites.
- (RSA.\*AES) is a regular expression that enables ciphersuites whose names contain the string "RSA" followed by "AES", meaning ciphersuites using RSA authentication and AES encryption.
- !(EXPORT) is a regular expression that disables any of the selected ciphersuites whose names contain the string "EXPORT", meaning ciphersuites having export-quality strength.

As another example, this property adds anonymous Diffie-Hellman to the default set of ciphersuites and disables export ciphersuites:

```
IceSSL.Client.Ciphers=(DH_anon) !(EXPORT)
```

Finally, this example selects only one ciphersuite:

```
IceSSL.Client.Ciphers=NONE SSL_RSA_WITH_RC4_128_SHA
```

## Configuring Trust Relationships

Declaring that you [trust a certificate authority](#) implies that you trust any peer whose certificate was signed directly or indirectly by that certificate authority. It is necessary to use this broad definition of trust in some applications, such as a public Web server. In more controlled environments, it is a good idea to restrict access as much as possible, and IceSSL provides a number of ways for you to do that.

### Trusted Peers

After the low-level SSL engine has completed its authentication process, IceSSL can be configured to take additional steps to verify whether a peer should be trusted. The `IceSSL.TrustOnly` family of properties defines a collection of acceptance and rejection filters that IceSSL applies to the distinguished name of a peer's certificate in order to determine whether to allow the connection to proceed. IceSSL permits the connection if the peer's distinguished name matches any of the acceptance filters and does not match any of the rejection filters.

A distinguished name uniquely identifies a person or entity and is generally represented in the following textual form:

```
C=US, ST=Florida, L=Palm Beach Gardens, O="ZeroC, Inc.", OU=Servers,
CN=Quote Server
```

Suppose we are configuring a client to communicate with the server whose distinguished name is shown above. If we know that the client is allowed to communicate only with this server, we can enforce this rule using the following property:

```
IceSSL.TrustOnly=O="ZeroC, Inc.", OU=Servers, CN=Quote Server
```

With this property in place, IceSSL allows a connection to proceed only if the distinguished name in the server's certificate matches this filter. The property may contain multiple filters, separated by semicolons, if the client needs to communicate with more than one server. Additional variations of the property are also supported.

If the `IceSSL.TrustOnly` properties do not provide the selectivity you require, the next step is to install a [custom certificate verifier](#).

## Verification Depth

In order to authenticate a peer, SSL obtains the peer's certificate chain, which includes the peer's certificate as well as that of the root CA. SSL verifies that each certificate in the chain is valid, but there still remains a subtle security risk. Suppose that we have identified a trusted root CA (via its certificate), and a peer has supplied a valid certificate chain signed by our trusted root CA. It is possible for an attacker to obtain a special signing certificate that is signed by our root CA and therefore trusted implicitly. The attacker can use this certificate to sign fraudulent certificates with the goal of masquerading as a trusted peer, presumably for some nefarious purpose.

We could use the `IceSSL.TrustOnly` properties described above in an attempt to defend against such an attack. However, the attacker could easily manufacture a certificate containing a distinguished name that satisfies the trust properties.

If you know that all trusted peers present certificate chains of a certain length, set the property `IceSSL.VerifyDepthMax` so that IceSSL automatically rejects longer chains. The default value of this property is two, therefore you may need to set it to a larger value if you expect peers to present longer chains.

In situations where you cannot make assumptions about the length of a peer's certificate chain, yet you still want to examine the chain before allowing the connection, you should install a [custom certificate verifier](#).

## Configuring Secure Proxies

Proxies may contain any combination of secure and insecure endpoints. An application that requires secure communication can guarantee that proxies it manufactures itself, such as those created by calling `stringToProxy`, contain only secure endpoints. However, the application cannot make the same assumption about proxies received as the result of a remote invocation.

The simplest way to guarantee that all proxies use only secure endpoints is to define the `Ice.Override.Secure` configuration property:

```
Ice.Override.Secure=1
```

Setting this property is equivalent to invoking the [proxy method](#) `ice_secure(true)` on every proxy. When enabled, [attempting to establish a connection](#) using a proxy that does not contain a secure endpoint results in `NoEndpointException`.

If you want the default behavior of proxies to give precedence to secure endpoints, you can set this property instead:

```
Ice.Default.PreferSecure=1
```

Note that proxies may still attempt to establish connections to insecure endpoints, but they try all secure endpoints first. This is equivalent to

invoking `ice_preferSecure(true)` on a proxy.

## IceSSL Diagnostics

You can use two configuration properties to obtain more information about the plug-in's activities. Setting `IceSSL.Trace.Security=1` enables the plug-in's diagnostic output, which includes a variety of messages regarding events such as ciphersuite selection, peer verification and trust evaluation. The other property, `Ice.Trace.Network`, determines how much information is logged about network events such as connections and packets. Note that the output generated by `Ice.Trace.Network` also includes other transports such as TCP and UDP.

## System Logging in Java

In Java, you can use a system property that displays a great deal of information about SSL certificates and connections, including the ciphersuite that is selected for use by each connection. For example, the following command sets the system property that activates the diagnostics:

```
$ java -Djavax.net.debug=ssl MyProgram
```

## System Logging in .NET

Enabling additional tracing output in .NET requires the creation of an XML file such as the one shown below:

## XML

```

<?xml version="1.0" encoding="UTF-8" ?>
<configuration>
 <system.diagnostics>
 <trace autoflush="true"/>
 <sources>
 <source name="System.Net">
 <listeners>
 <add name="System.Net"/>
 </listeners>
 </source>
 <source name="System.Net.Sockets">
 <listeners>
 <add name="System.Net"/>
 </listeners>
 </source>
 <source name="System.Net.Cache">
 <listeners>
 <add name="System.Net"/>
 </listeners>
 </source>
 </sources>
 <sharedListeners>
 <add
 name="System.Net"
 type="System.Diagnostics.TextWriterTraceListener"
 initializeData="trace.txt"
 />
 </sharedListeners>
 <switches>
 <add name="System.Net" value="Verbose"/>
 <add name="System.Net.Sockets" value="Verbose"/>

 <add name="System.Net.Cache" value="Verbose"/>
 </switches>
 </system.diagnostics>
</configuration>

```

In this example, the output is stored in the file `trace.txt`. To activate tracing, give the XML file the same name as your executable with a `.config` extension (such as `server.exe.config`), and place it in the same directory as the executable.

**See Also**

- [Proxy Methods](#)
- [Filtering Proxy Endpoints](#)
- [Public Key Infrastructure](#)
- [Using IceSSL](#)
- [Programming IceSSL](#)
- [Advanced IceSSL Topics](#)

- [IceSSL Properties](#)

## Programming IceSSL

The IceSSL [configuration properties](#) are flexible enough to satisfy the requirements of many applications, and IceSSL supports a public API that offers even more functionality for those applications that need it.

### Topics

- [Programming IceSSL in C++](#)
- [Programming IceSSL in Java](#)
- [Programming IceSSL in .NET](#)

### See Also

- [Configuring IceSSL](#)

## Programming IceSSL in C++

This page describes the C++ API for the IceSSL plug-in.

On this page:

- [The IceSSL Plugin Interface in C++](#)
- [Obtaining SSL Connection Information in C++](#)
- [Installing a Certificate Verifier in C++](#)
- [Using Certificates in C++](#)
- [Using Distinguished Names in C++](#)

### The IceSSL Plugin Interface in C++

Applications can interact directly with the IceSSL plug-in using the native C++ class `IceSSL::Plugin`. A reference to a `Plugin` object must be obtained from the communicator in which the plug-in is installed:

```
C++
```

```
Ice::CommunicatorPtr communicator = // ...
Ice::PluginManagerPtr pluginMgr = communicator->getPluginManager();
Ice::PluginPtr plugin = pluginMgr->getPlugin("IceSSL");
IceSSL::PluginPtr sslPlugin = IceSSL::PluginPtr::dynamicCast(plugin);
```

The `Plugin` class supports the following methods:

```
C++
```

```
namespace IceSSL
{
class Plugin : public Ice::Plugin
{
public:
 virtual void setContext(SSL_CTX*) = 0;
 virtual SSL_CTX* getContext() = 0;

 virtual void setCertificateVerifier(const CertificateVerifierPtr&)
= 0;

 virtual void setPasswordPrompt(const PasswordPromptPtr&) = 0;
};
typedef IceUtil::Handle<Plugin> PluginPtr;
}
```

The `setContext` and `getContext` methods are rarely used in practice. The `setCertificateVerifier` method installs a custom certificate verifier object that the plug-in invokes for each new connection. The `setPasswordPrompt` method provides an alternate way to supply IceSSL with passwords. We discuss certificate verifiers below and revisit the other methods in our discussion of [advanced IceSSL programming](#).

### Obtaining SSL Connection Information in C++

You can obtain information about any SSL connection using the `getInfo` operation on a [Connection](#) object. It returns an `IceSSL::Nati`



veConnectionInfo class instance that derives from the Slice class IceSSL::ConnectionInfo. The Slice base class is defined as follows:

Slice
<pre> module Ice {     local class ConnectionInfo {         bool incoming;         string adapterName;     };      local class IPConnectionInfo extends ConnectionInfo {         string localAddress;         int localPort;         string remoteAddress;         int remotePort;     }; };  module IceSSL {     local class ConnectionInfo extends Ice::IPConnectionInfo {         string cipher;         Ice::StringSeq certs;     }; }; </pre>

In turn, the C++ class NativeConnectionInfo is defined as follows:

C++
<pre> class NativeConnectionInfo : public ConnectionInfo { public:     std::vector&lt;CertificatePtr&gt; nativeCerts; };  typedef IceUtil::Handle&lt;NativeConnectionInfo&gt; NativeConnectionInfoPtr; </pre>

### Installing a Certificate Verifier in C++

A new connection undergoes a series of verification steps before an application is allowed to use it. The low-level SSL engine executes [certificate validation procedures](#) and, assuming the certificate chain is successfully validated, IceSSL performs [additional verification](#) as directed by its configuration properties. Finally, if a certificate verifier is installed, IceSSL invokes it to provide the application with an opportunity to decide whether to allow the connection to proceed.

The CertificateVerifier interface has only one method:

**C++**

```

namespace IceSSL
{
class CertificateVerifier : public IceUtil::Shared
{
public:

 virtual bool verify(const NativeConnectionInfoPtr&) = 0;
};
typedef IceUtil::Handle<CertificateVerifier> CertificateVerifierPtr;
}

```

IceSSL rejects the connection if `verify` returns `false`, and allows it to proceed if the method returns `true`. The `verify` method receives a `NativeConnectionInfo` object that describes the connection's attributes.

The `nativeCerts` member is a vector of certificates representing the peer's certificate chain. The vector is structured so that the first element is the peer's certificate, followed by its signing certificates in the order they appear in the chain, with the root CA certificate as the last element. The vector is empty if the peer did not present a certificate chain.

The `cipher` member is a description of the ciphersuite that SSL negotiated for this connection. The local and remote address information is provided in `localAddress` and `remoteAddress`, respectively.



A bug in Windows XP prevents IceSSL from obtaining the remote address information when using IPv6.

The `incoming` member indicates whether the connection is inbound (a server connection) or outbound (a client connection). Finally, if `incoming` is `true`, the `adapterName` member supplies the name of the object adapter that hosts the endpoint.

The following class is a simple implementation of a certificate verifier:

**C++**

```

class Verifier : public IceSSL::CertificateVerifier
{
public:

 bool verify(const IceSSL::NativeConnectionInfo& info)
 {
 if (!info.nativeCerts.empty())
 {
 string dn = info.nativeCerts[0].getIssuerDN();
 transform(dn.begin(), dn.end(), dn.begin(), ::tolower);
 if (dn.find("zeroc") != string::npos)
 {
 return true;
 }
 }
 return false;
 }
}

```

In this example, the verifier rejects the connection unless the string `zeroc` is present in the issuer's distinguished name of the peer's certificate. In a more realistic implementation, the application is likely to perform detailed inspection of the certificate chain.

Installing the verifier is a simple matter of calling `setCertificateVerifier` on the plug-in interface:

**C++**

```

IceSSL::PluginPtr sslPlugin = // ...
sslPlugin->setCertificateVerifier(new Verifier);

```

You should install the verifier before any SSL connections are established.

You can also install a certificate verifier [using a custom plug-in](#) to avoid making changes to the code of an existing application.

 The Ice run time calls the `verify` method during the connection-establishment process, therefore delays in the `verify` implementation have a direct impact on the performance of the application. Do not make remote invocations from your implementation of `verify`.

## Using Certificates in C++

The `ConnectionInfo` class contains a vector of `Certificate` objects representing the peer's certificate chain. `Certificate` is a reference-counted convenience class that hides the complexity of the underlying OpenSSL API. Its methods are inspired by the Java class `x509Certificate`:

**C++**

```

namespace IceSSL
{
class Certificate : public IceUtil::Shared
{
public:

 Certificate(X509*);

 static CertificatePtr load(const string&);
 static CertificatePtr decode(const string&);

 bool operator==(const Certificate&) const;
 bool operator!=(const Certificate&) const;

 PublicKeyPtr getPublicKey() const;

 bool verify(const PublicKeyPtr&) const;

 string encode() const;

 bool checkValidity() const;
 bool checkValidity(const IceUtil::Time&) const;

 IceUtil::Time getNotAfter() const;
 IceUtil::Time getNotBefore() const;

 string getSerialNumber() const;

 DistinguishedName getIssuerDN() const;
 vector<pair<int, string> > getIssuerAlternativeNames();

 DistinguishedName getSubjectDN() const;
 vector<pair<int, string> > getSubjectAlternativeNames();

 int getVersion() const;

 string toString() const;

 X509* getCert() const;
};
typedef IceUtil::Handle<Certificate> CertificatePtr;
}

```

The more commonly-used methods are described below; refer to the documentation in `IceSSL/Plugin.h` for information on the methods that are not covered.

The static method `load` creates a certificate from the contents of a PEM-encoded file. If an error occurs, the function raises `IceSSL::Cert`

`ifCertificateReadException`; the `reason` member provides a description of the problem.

Use `decode` to obtain a certificate from a PEM-encoded string representing a certificate. The caller must be prepared to catch `IceSSL::CertificateEncodingException` if `decode` fails; the `reason` member provides a description of the problem.

The `encode` method creates a PEM-encoded string that represents the certificate. The return value can later be passed to `decode` to recreate the certificate.

The `checkValidity` methods determine whether the certificate is valid. The overloading with no arguments returns true if the certificate is valid at the current time; the other overloading accepts an `IceUtil::Time` object and returns true if the certificate is valid at the given time.

The `getNotAfter` and `getNotBefore` methods return instances of `IceUtil::Time` that define the certificate's valid period.

The methods `getIssuerDN` and `getSubjectDN` supply the distinguished names of the certificate's issuer (i.e., the CA that signed the certificate) and subject (i.e., the person or entity to which the certificate was issued). The methods return instances of the class `IceSSL::DistinguishedName`, another convenience class that is described below.

Finally, the `toString` method returns a human-readable string describing the certificate.

## Using Distinguished Names in C++

X.509 certificates use a distinguished name to identify a person or entity. The name is an ordered sequence of relative distinguished names that supply values for fields such as common name, organization, state, and country. Distinguished names are commonly displayed in stringified form according to the rules specified by RFC 2253, as shown in the following example:

```
C=US, ST=Florida, L=Palm Beach Gardens, O="ZeroC, Inc.", OU=Servers,
CN=Quote Server
```

`DistinguishedName` is a convenience class provided by `IceSSL` to simplify the tasks of parsing, formatting and comparing distinguished names.

```

C++
namespace IceSSL
{
class DistinguishedName
{
public:

 DistinguishedName(const std::string&);
 DistinguishedName(const std::list<std::pair<std::string, std::string>>&);

 bool operator==(const DistinguishedName&) const;
 bool operator!=(const DistinguishedName&) const;
 bool operator<(const DistinguishedName&) const;

 bool match(const DistinguishedName&) const;

 operator std::string() const;
};
}

```

The first overloaded constructor accepts a string argument representing a distinguished name encoded using the rules set forth in RFC 2253. The new `DistinguishedName` instance preserves the order of the relative distinguished names in the string. The caller must be prepared to catch `IceSSL::ParseException` if an error occurs during parsing.

The second overloaded constructor requires a list of type-value pairs representing the relative distinguished names. The new `DistinguishedName` instance preserves the order of the relative distinguished names in the list.

The overloaded operator functions `operator==`, `operator!=`, and `operator<` perform an exact match of distinguished names in which the order of the relative distinguished names is important. For two distinguished names to be equal, they must have the same relative distinguished names in the same order.

The `match` function performs a partial comparison that does not consider the order of relative distinguished names. If `N1` and `N2` are instances of `DistinguishedName`, `N1.match(N2)` returns true if all of the relative distinguished names in `N2` are present in `N1`.

Finally, the string conversion operator encodes the distinguished name in the format described by RFC 2253.

**See Also**

- [Using Connections](#)
- [Public Key Infrastructure](#)
- [Configuring IceSSL](#)
- [Advanced IceSSL Topics](#)

## Programming IceSSL in Java

This page describes the Java API for the IceSSL plug-in.

On this page:

- [The IceSSL Plugin Interface in Java](#)
- [Obtaining SSL Connection Information in Java](#)
- [Installing a Certificate Verifier in Java](#)
- [Converting Certificates in Java](#)

### The IceSSL Plugin Interface in Java

Applications can interact directly with the IceSSL plug-in using the native Java interface `IceSSL.Plugin`. A reference to a `Plugin` object must be obtained from the communicator in which the plug-in is installed:

```

Java
Ice.Communicator comm = // ...
Ice.PluginManager pluginMgr = comm.getPluginManager();
Ice.Plugin plugin = pluginMgr.getPlugin("IceSSL");
IceSSL.Plugin sslPlugin = (IceSSL.Plugin)plugin;

```

The `Plugin` interface supports the following methods:

```

Java
package IceSSL;

public interface Plugin extends Ice.Plugin
{
 void setContext(javax.net.ssl.SSLContext context);
 javax.net.ssl.SSLContext getContext();

 void setCertificateVerifier(CertificateVerifier verifier);
 CertificateVerifier getCertificateVerifier();

 void setPasswordCallback>PasswordCallback callback);
 PasswordCallback getPasswordCallback();

 void setKeystoreStream(java.io.InputStream stream);

 void setTruststoreStream(java.io.InputStream stream);

 void addSeedStream(java.io.InputStream stream);
}

```

The methods are summarized below:

- `setContext`
- `getContext`

These methods are for [advanced use cases](#) and rarely used in practice.

- `setCertificateVerifier`  
`getCertificateVerifier`  
These methods install and retrieve a custom certificate verifier object that the plug-in invokes for each new connection. `getCertificateVerifier` returns null if a verifier has not been set.
- `setPasswordCallback`  
`getPasswordCallback`  
These methods install and retrieve a password callback object that supplies IceSSL with passwords. `getPasswordCallback` returns null if a callback has not been set. Using `setPasswordCallback` is a [more secure alternative](#) to setting passwords in clear-text configuration files.
- `setKeystoreStream`  
Supplies an input stream for a keystore containing the key pair. The `IceSSL.Keystore` property is ignored if this method is called with a non-null value. You may supply the same input stream object to this method and to `setTruststoreStream` if your keystore contains your key pair as well as your trusted CA certificates.
- `setTruststoreStream`  
Supplies an input stream for a truststore containing your trusted CA certificates. The `IceSSL.Truststore` property is ignored if this method is called with a non-null value. You may supply the same input stream object to this method and to `setKeystoreStream` if your keystore contains your key pair as well as your trusted CA certificates.
- `addSeedStream`  
Adds an input stream that supplies seed data for the random number generator. You may call this method multiple times if necessary.

## Obtaining SSL Connection Information in Java

You can obtain information about any SSL connection using the `getInfo` operation on a [Connection object](#). It returns an `IceSSL.NativeConnectionInfo` class instance that derives from the Slice class `IceSSL::ConnectionInfo`. The Slice base class is defined as follows:

```

Slice

module Ice {
 local class ConnectionInfo {
 bool incoming;
 string adapterName;
 };

 local class IPConnectionInfo extends ConnectionInfo {
 string localAddress;
 int localPort;
 string remoteAddress;
 int remotePort;
 };
};

module IceSSL {
 local class ConnectionInfo extends Ice::IPConnectionInfo {
 string cipher;
 Ice::StringSeq certs;
 };
};

```



In turn, the Java class `NativeConnectionInfo` is defined as follows.

```

Java
public class NativeConnectionInfo extends ConnectionInfo
{
 public java.security.cert.Certificate[] nativeCerts;
}

```

## Installing a Certificate Verifier in Java

A new connection undergoes a series of verification steps before an application is allowed to use it. The low-level SSL engine executes [certificate validation procedures](#) and, assuming the certificate chain is successfully validated, IceSSL performs [additional verification](#) as directed by its configuration properties. Finally, if a certificate verifier is installed, IceSSL invokes it to provide the application with an opportunity to decide whether to allow the connection to proceed.

The `CertificateVerifier` interface has only one method:

```

Java
package IceSSL;

public interface CertificateVerifier
{
 boolean verify(NativeConnectionInfo info);
}

```

IceSSL rejects the connection if `verify` returns `false`, and allows it to proceed if the method returns `true`. The `verify` method receives a `NativeConnectionInfo` object that describes the connection's attributes.

The `nativeCerts` member of the `NativeConnectionInfo` is an array of certificates representing the peer's certificate chain. The array is structured so that the first element is the peer's certificate, followed by its signing certificates in the order they appear in the chain, with the root CA certificate as the last element. This member is null if the peer did not present a certificate chain.

The `cipher` member is a description of the ciphersuite that SSL negotiated for this connection. The local and remote address information is provided in `localAddress` and `remoteAddress`, respectively. The `incoming` member indicates whether the connection is inbound (a server connection) or outbound (a client connection). Finally, if `incoming` is `true`, the `adapterName` member supplies the name of the object adapter that hosts the endpoint.

The following class is a simple implementation of a certificate verifier:

### Java

```
import java.security.cert.X509Certificate;
import javax.security.auth.x500.X500Principal;

class Verifier implements IceSSL.CertificateVerifier
{
 public boolean
 verify(IceSSL.NativeConnectionInfo info)
 {
 if (info.nativeCerts != null)
 {
 X509Certificate cert = (X509Certificate)info.nativeCerts[0];
 X500Principal p = cert.getIssuerX500Principal();
 if (p.getName().toLowerCase().indexOf("zeroc") != -1)
 {
 return true;
 }
 }
 return false;
 }
}
```

In this example, the verifier rejects the connection unless the string `zeroc` is present in the issuer's distinguished name of the peer's certificate. In a more realistic implementation, the application is likely to perform detailed inspection of the certificate chain.

Installing the verifier is a simple matter of calling `setCertificateVerifier` on the plug-in interface:

### Java

```
IceSSL.Plugin sslPlugin = // ...
sslPlugin.setCertificateVerifier(new Verifier());
```

You should install the verifier before any SSL connections are established. An alternate way of installing the verifier is to define the `IceSSL.CertVerifier` property with the class name of your verifier implementation. IceSSL instantiates the class using its default constructor.

You can also install a certificate verifier using a [custom plug-in](#) to avoid making changes to the code of an existing application.

 The Ice run time calls the `verify` method during the connection-establishment process, therefore delays in the `verify` implementation have a direct impact on the performance of the application. Do not make remote invocations from your implementation of `verify`.

## Converting Certificates in Java

Java does not provide a simple way to create a certificate object from a PEM-encoded string, therefore IceSSL offers the following convenience method:

**Java**

```
package IceSSL;

public final class Util
{
 // ...

 public static java.security.cert.X509Certificate
 createCertificate(String certPEM)
 throws java.security.cert.CertificateException;
}
```

Given a string in the PEM format, `createCertificate` returns the equivalent `X509Certificate` object.

**See Also**

- [Using Connections](#)
- [Public Key Infrastructure](#)
- [Configuring IceSSL](#)
- [Advanced IceSSL Topics](#)

## Programming IceSSL in .NET

This page describes the .NET API for the IceSSL plug-in.

On this page:

- [The IceSSL Plugin Interface in C#](#)
- [Obtaining SSL Connection Information in C#](#)
- [Installing a Certificate Verifier in C#](#)
- [Converting Certificates in C#](#)

### The IceSSL Plugin Interface in C#

Applications can interact directly with the IceSSL plug-in using the native C# interface `IceSSL.Plugin`. A reference to a `Plugin` object must be obtained from the communicator in which the plug-in is installed:

```

C#

Ice.Communicator comm = // ...
Ice.PluginManager pluginMgr = comm.getPluginManager();
Ice.Plugin plugin = pluginMgr.getPlugin("IceSSL");
IceSSL.Plugin sslPlugin = (IceSSL.Plugin)plugin;
```

The `Plugin` interface supports the following methods:

```

C#

namespace IceSSL
{
 using System.Security.Cryptography.X509Certificates;

 abstract public class Plugin : Ice.Plugin
 {
 abstract public void
 setCertificates(X509Certificate2Collection certs);

 abstract public void
 setCertificateVerifier(CertificateVerifier verifier);

 abstract public CertificateVerifier
 getCertificateVerifier();

 abstract public void
 setPasswordCallback>PasswordCallback callback);

 abstract public PasswordCallback
 getPasswordCallback();
 }
}
```

The methods are summarized below:

- `setCertificates`  
This method is for [advanced use cases](#) and rarely used in practice.
- `setCertificateVerifier`  
`getCertificateVerifier`  
These methods install and retrieve a custom certificate verifier object that the plug-in invokes for each new connection. `getCertificateVerifier` returns null if a verifier has not been set.
- `setPasswordCallback`  
`getPasswordCallback`  
These methods install and retrieve a password callback object that supplies IceSSL with passwords. `getPasswordCallback` returns null if a callback has not been set. Using `setPasswordCallback` is a [more secure alternative](#) to setting passwords in clear-text configuration files.

## Obtaining SSL Connection Information in C#

You can obtain information about any SSL connection using the `getInfo` operation on a [Connection object](#). It returns an `IceSSL.NativeConnectionInfo` class instance that derives from the Slice class `IceSSL::ConnectionInfo`. The Slice base class is defined as follows:

Slice
<pre> module Ice {     local class ConnectionInfo {         bool incoming;         string adapterName;     };      local class IPConnectionInfo extends ConnectionInfo {         string localAddress;         int localPort;         string remoteAddress;         int remotePort;     }; };  module IceSSL {     local class ConnectionInfo extends Ice::IPConnectionInfo {         string cipher;         Ice::StringSeq certs;     }; }; </pre>

In turn, the C# class `NativeConnectionInfo` is defined as follows.

**C#**

```
public sealed class NativeConnectionInfo : ConnectionInfo
{
 public System.Security.Cryptography.X509Certificates.X509Certificate2[] nativeCerts;
}
```

**Installing a Certificate Verifier in C#**

A new connection undergoes a series of verification steps before an application is allowed to use it. The low-level SSL engine executes [certificate validation procedures](#) and, assuming the certificate chain is successfully validated, IceSSL performs [additional verification](#) as directed by its configuration properties. Finally, if a certificate verifier is installed, IceSSL invokes it to provide the application with an opportunity to decide whether to allow the connection to proceed.

The `CertificateVerifier` interface has only one method:

**C#**

```
namespace IceSSL
{
 public interface CertificateVerifier
 {
 bool verify(NativeConnectionInfo info);
 }
}
```

IceSSL rejects the connection if `verify` returns `false`, and allows it to proceed if the method returns `true`. The `verify` method receives a `NativeConnectionInfo` object that describes the connection's attributes.

The `nativeCerts` member of `NativeConnectionInfo` is an array of certificates representing the peer's certificate chain. The array is structured so that the first element is the peer's certificate, followed by its signing certificates in the order they appear in the chain, with the root CA certificate as the last element. This member is null if the peer did not present a certificate chain.

The `cipher` member is a description of the ciphersuite that SSL negotiated for this connection. The local and remote address information is provided in `localAddress` and `remoteAddr`, respectively. The `incoming` member indicates whether the connection is inbound (a server connection) or outbound (a client connection). Finally, if `incoming` is `true`, the `adapterName` member supplies the name of the object adapter that hosts the endpoint.

The following class is a simple implementation of a certificate verifier:

**C#**

```
using System.Security.Cryptography.X509Certificates;

class Verifier : IceSSL.CertificateVerifier
{
 public boolean
 verify(IceSSL.NativeConnectionInfo info)
 {
 if (info.nativeCerts != null)
 {
 X500DistinguishedName dn = info.nativeCerts[0].IssuerName;
 if (dn.Name.ToLower().Contains("zeroc"))
 {
 return true;
 }
 }
 return false;
 }
}
```

In this example, the verifier rejects the connection unless the string `zeroc` is present in the issuer's distinguished name of the peer's certificate. In a more realistic implementation, the application is likely to perform detailed inspection of the certificate chain.

Installing the verifier is a simple matter of calling `setCertificateVerifier` on the plug-in interface:

**C#**

```
IceSSL.Plugin sslPlugin = // ...
sslPlugin.setCertificateVerifier(new Verifier());
```

You should install the verifier before any SSL connections are established. An alternate way of installing the verifier is to define the `IceSSL.CertVerifier` property with the class name of your verifier implementation. IceSSL instantiates the class using its default constructor.

You can also install a certificate verifier using a [custom plug-in](#) to avoid making changes to the code of an existing application.



The Ice run time calls the `verify` method during the connection-establishment process, therefore delays in the `verify` implementation have a direct impact on the performance of the application. Do not make remote invocations from your implementation of `verify`.

## Converting Certificates in C#

IceSSL offers the following convenience method to create a certificate object from a PEM-encoded string:

**C#**

```
namespace IceSSL
{
 using System.Security.Cryptography.X509Certificates;

 public sealed class Util
 {
 // ...

 public static X509Certificate2
 createCertificate(string certPEM);
 }
}
```

Given a string in the PEM format, `createCertificate` returns the equivalent `X509Certificate2` object.

**See Also**

- [Using Connections](#)
- [Public Key Infrastructure](#)
- [Configuring IceSSL](#)
- [Advanced IceSSL Topics](#)



## Advanced IceSSL Topics

This page discusses some additional capabilities of the IceSSL plug-in.

On this page:

- [Managing Certificate Passwords](#)
  - [Dynamic Properties](#)
  - [Password Callbacks in C++](#)
  - [Password Callbacks in Java](#)
  - [Password Callbacks in .NET](#)
- [Manually Configuring IceSSL](#)
- [Using Custom Plug-ins with IceSSL](#)

### Managing Certificate Passwords

IceSSL may need to obtain a password if it loads a file that contains secure data, such as an encrypted private key. An application can supply a plain-text password in a [configuration property](#), but doing so is a potential security risk. For example, if you define the property on the application's command-line, it may be possible for other users on the same host to see the password simply by obtaining a list of active processes. If you define the property in a configuration file, the password is only as secure as the file in which it is defined.

In highly secure environments where access to a host is tightly restricted, a password can safely be supplied as a plain-text configuration property, or the need for the password can be eliminated altogether by using unsecured key files.

In situations where password security is a concern, the application generally needs to take additional action.

#### Dynamic Properties

A common technique is to prompt the user for a password and transfer the user's input to a configuration property that the application defines dynamically, as shown below:

C++
<pre>string password = // ... Ice::InitializationData initData; initData.properties = Ice::createProperties(argc, argv); initData.properties-&gt;setProperty("IceSSL.Password", password); Ice::CommunicatorPtr comm = Ice::initialize(initData);</pre>

The password must be present in the property set before the communicator is initialized, since IceSSL needs the password during its initialization, and the communicator initializes plug-ins automatically by default.

#### Password Callbacks in C++

If a password is required but the application has not configured one, IceSSL prompts the user at the terminal during the plug-in's initialization. This behavior is not suitable for some types of applications, such as a program that runs automatically at system startup as a [Unix daemon](#) or [Windows service](#).

A terminal prompt is equally undesirable for graphical applications, which would generally prefer to prompt the user in an application window. The dynamic property technique described in the previous section is usually appropriate in this situation.

If your application must supply a password, and you do not want to use a configuration property or a terminal prompt, your remaining option is to install a `PasswordPrompt` object in the plug-in using the `setPasswordPrompt` method. The `PasswordPrompt` class is defined as follows:

**C++**

```

namespace IceSSL
{
class PasswordPrompt : public IceUtil::Shared
{
public:

 virtual std::string getPassword() = 0;
};
typedef IceUtil::Handle<PasswordPrompt> PasswordPromptPtr;
}

```

IceSSL invokes `getPassword` on the object when a password is required. If the object returns an incorrect password, IceSSL tries again, up to the limit defined by the `IceSSL.PasswordRetryMax` property.

Note that you must delay the initialization of the IceSSL plug-in until after the `PasswordPrompt` object is installed. To illustrate this point, consider the following example:

**C++**

```

Ice::CommunicatorPtr communicator = // ...
Ice::PluginManagerPtr pluginMgr = communicator->getPluginManager();
Ice::PluginPtr plugin = pluginMgr->getPlugin("IceSSL");
IceSSL::PluginPtr sslPlugin = IceSSL::PluginPtr::dynamicCast(plugin);
sslPlugin->setPasswordPrompt(new Prompt); // OOPS!

```

This code is incorrect because the `PasswordPrompt` object is installed too late: the communicator is already initialized, which means IceSSL has already attempted to load the file that required a password.

The correct approach is to define the `Ice.InitPlugins` configuration property:

```
Ice.InitPlugins=0
```

This setting causes the communicator to install, but not initialize, its configured plug-ins. The application becomes responsible for initializing the plug-ins, as shown below:

**C++**

```

Ice::CommunicatorPtr communicator = // ...
Ice::PluginManagerPtr pluginMgr = communicator->getPluginManager();
Ice::PluginPtr plugin = pluginMgr->getPlugin("IceSSL");
IceSSL::PluginPtr sslPlugin = IceSSL::PluginPtr::dynamicCast(plugin);
sslPlugin->setPasswordPrompt(new Prompt);
pluginMgr->initializePlugins();

```

We assume the communicator was initialized with `Ice.InitPlugins=0`. After installing the `PasswordPrompt` object, the application

invokes `initializePlugins` on the plug-in manager to complete the plug-in initialization process.

## Password Callbacks in Java

If you do not want to use configuration properties to define passwords, you can install a `PasswordCallback` object in the plug-in using a configuration property, or using the `setPasswordCallback` method. The `PasswordCallback` interface has the following definition:

```

Java

public interface PasswordCallback
{
 char[] getPassword(String alias);
 char[] getTruststorePassword();
 char[] getKeystorePassword();
}

```

The methods are described below:

- `getPassword`  
Supplies the password for the key with the given alias. The return value must not be null.
- `getTruststorePassword`  
Supplies the password for a truststore. The method may return null, in which case the integrity of the truststore is not verified.
- `getKeystorePassword` to obtain the password for a keystore.  
Supplies the password for a keystore. The method may return null, in which case the integrity of the keystore is not verified.

For each of these methods, IceSSL clears the contents of the returned array as soon as possible.

The simplest way to install the callback is by defining the configuration property `IceSSL.PasswordCallback`. The property's value is the name of your callback implementation class. IceSSL instantiates the class using its default constructor.

To install the callback manually, you must delay the initialization of the IceSSL plug-in until after the `PasswordCallback` object is installed. To illustrate this point, consider the following example:

```

Java

Ice.Communicator communicator = // ...
Ice.PluginManager pluginMgr = communicator.getPluginManager();
Ice.Plugin plugin = pluginMgr.getPlugin("IceSSL");
IceSSL.Plugin sslPlugin = (IceSSL.Plugin)plugin;
sslPlugin.setPasswordCallback(new CallbackI()); // OOPS!

```

This code is incorrect because the `PasswordCallback` object is installed too late: the communicator is already initialized, which means IceSSL has already attempted to retrieve the certificate that required a password.

The correct approach is to define the `Ice.InitPlugins` configuration property:

```

Ice.InitPlugins=0

```

This setting causes the communicator to install, but not initialize, its configured plug-ins. The application becomes responsible for initializing the plug-ins, as shown below:

**Java**

```
Ice.Communicator communicator = // ...
Ice.PluginManager pluginMgr = communicator.getPluginManager();
Ice.Plugin plugin = pluginMgr.getPlugin("IceSSL");
IceSSL.Plugin sslPlugin = (IceSSL.Plugin)plugin;
sslPlugin.setPasswordCallback(new CallbackI());
pluginMgr.initializePlugins();
```

We assume the communicator was initialized with `Ice.InitPlugins=0`. After installing the `PasswordCallback` object, the application invokes `initializePlugins` on the plug-in manager to complete the plug-in initialization process.

**Password Callbacks in .NET**

If you do not want to use configuration properties to define passwords, you can install a `PasswordCallback` object in the plug-in using a configuration property, or using the `setPasswordCallback` method. The `PasswordCallback` interface has the following definition:

**C#**

```
using System.Security;

public interface PasswordCallback
{
 SecureString getPassword(string file);
 SecureString getImportPassword(string file);
}
```

The methods are described below:

- `getPassword`  
Supplies the password for the given file. The method may return null if no password is required.
- `getImportPassword`  
Supplies the password for a file from which certificates are imported into the certificate store. The method may return null if no password is required.

The simplest way to install the callback is by defining the configuration property `IceSSL.PasswordCallback`. The property's value is the name of your callback implementation class. `IceSSL` instantiates the class using its default constructor.

To install the callback manually, you must delay the initialization of the `IceSSL` plug-in until after the `PasswordCallback` object is installed. To illustrate this point, consider the following example:

**C#**

```
Ice.Communicator communicator = // ...
Ice.PluginManager pluginMgr = communicator.getPluginManager();
Ice.Plugin plugin = pluginMgr.getPlugin("IceSSL");
IceSSL.Plugin sslPlugin = (IceSSL.Plugin)plugin;
sslPlugin.setPasswordCallback(new CallbackI()); // OOPS!
```

This code is incorrect because the `PasswordCallback` object is installed too late: the communicator is already initialized, which means IceSSL has already attempted to retrieve the certificate that required a password.

The correct approach is to define the `Ice.InitPlugins` configuration property:

```
Ice.InitPlugins=0
```

This setting causes the communicator to install, but not initialize, its configured plug-ins. The application becomes responsible for initializing the plug-ins, as shown below:

```
C#
Ice.Communicator communicator = // ...
Ice.PluginManager pluginMgr = communicator.getPluginManager();
Ice.Plugin plugin = pluginMgr.getPlugin("IceSSL");
IceSSL.Plugin sslPlugin = (IceSSL.Plugin)plugin;
sslPlugin.setPasswordCallback(new CallbackI());
pluginMgr.initializePlugins();
```

We assume the communicator was initialized with `Ice.InitPlugins=0`. After installing the `PasswordCallback` object, the application invokes `initializePlugins` on the plug-in manager to complete the plug-in initialization process.

## Manually Configuring IceSSL

The `Plugin` interface supports a method in each of the supported language mappings that provides an application with more control over the plug-in's configuration.

In C++ and Java, an application can call the `setContext` method to supply a pre-configured "context" object used by the underlying SSL engines. In .NET, the `setCertificates` method accepts a collection of certificates that the plug-in should use. In all cases, using one of these methods causes IceSSL to ignore (at a minimum) the configuration properties related to certificates and keys. The application is responsible for accumulating its certificates and keys, and must also deal with any password requirements.

Describing the use of these plug-in methods in detail is outside the scope of this manual, however it is important to understand their prerequisites. In particular, the application needs to have the communicator load the plug-in but not actually initialize it until after the application has had a chance to interact directly with it. (The previous section showed examples of this technique.) The application must define the `Ice.InitPlugins` configuration property:

```
Ice.InitPlugins=0
```

With this setting, the application becomes responsible for completing the plug-in initialization process by invoking `initializePlugins` on the `PluginManager`. The C# example below demonstrates the proper steps:

**C#**

```
Ice.Communicator comm = // ...
Ice.PluginManager pluginMgr = comm.getPluginManager();
Ice.Plugin plugin = pluginMgr.getPlugin("IceSSL");
IceSSL.Plugin sslPlugin = (IceSSL.Plugin)plugin;
X509Certificate2Collection certs = // ...
sslPlugin.setCertificates(certs);
pluginMgr.initializePlugins();
```

## Using Custom Plug-ins with IceSSL

The Ice [plug-in facility](#) is not restricted to protocol implementations. Ice only requires that a plug-in implement the `Ice::Plugin` interface and support the language-specific mechanism for dynamic loading.

The customization options of the IceSSL plug-in make it possible for you to install an application-specific implementation of a certificate verifier in an existing program. For example, you could install a custom certificate verifier in a Glacier2 router without the need to modify Glacier2's source code or rebuild the executable. You would have to write a C++ plug-in to accomplish this, since Glacier2 is written in C++. In short, your plug-in must interact with the IceSSL plug-in and install a certificate verifier.

For this technique to work, it is important that the plug-ins be loaded in a particular order. Specifically, the IceSSL plug-in must be loaded first, followed by the certificate verifier plug-in. By default, Ice loads plug-ins in an undefined order, but you can use the property `Ice.PluginLoadOrder` to specify a particular order.

As an example, let's write a plug-in that installs our simple [C++ certificate verifier](#). Here is the definition of our plug-in class:

**C++**

```

class VerifierPlugin : public Ice::Plugin
{
public:
 VerifierPlugin(const Ice::CommunicatorPtr & comm) :
 _comm(comm)
 {
 }

 virtual void initialize()
 {
 Ice::PluginManagerPtr pluginMgr = _comm->getPluginManager();
 Ice::PluginPtr plugin = pluginMgr->getPlugin("IceSSL");
 IceSSL::PluginPtr sslPlugin =
 IceSSL::PluginPtr::dynamicCast(plugin);
 sslPlugin->setCertificateVerifier(new Verifier);
 }

 virtual void destroy()
 {
 }

private:
 Ice::CommunicatorPtr _comm;
};

```

The class implements the two operations in the `Plugin` interface, `initialize` and `destroy`. The code in `initialize` installs the certificate verifier object, while nothing needs to be done in `destroy`.

The next step is to write the plug-in's factory function, which the communicator invokes to obtain an instance of the plug-in:

**C++**

```

extern "C"
{
 Ice::Plugin*
 createVerifierPlugin(
 const Ice::CommunicatorPtr & communicator,
 const string & name,
 const Ice::StringSeq & args)
 {
 return new VerifierPlugin(communicator);
 }
}

```

We can give the function any name; in this example, we chose `createVerifierPlugin`.

Finally, to install the plug-in we need to define the following properties:

```

C++

Ice.PluginLoadOrder=IceSSL,Verifier
Ice.Plugin.IceSSL=IceSSL:createIceSSL
Ice.Plugin.Verifier=Verifier:createVerifierPlugin
```

The value of `Ice.PluginLoadOrder` guarantees that `IceSSL` is loaded first. The plug-in specification `Verifier:createVerifierPlugin` identifies the name of the shared library or DLL and the name of the registration function.

There are a few more details you must attend to, such as ensuring that the factory function is exported properly and building the shared library or DLL that contains the new plug-in. Our discussion of the [plug-in facility](#) provides more information on developing a plug-in.

#### See Also

- [The Server-Side main Function in C++](#)
- [Configuring IceSSL](#)
- [Programming IceSSL in C++](#)
- [Programming IceSSL in Java](#)
- [Programming IceSSL in .NET](#)
- [Plug-in Facility](#)
- [IceSSL Properties](#)
- [Ice Plug-In Properties](#)



## Setting up a Certificate Authority

During development, it is convenient to have a simple way of creating new certificates. OpenSSL includes all of the necessary infrastructure for setting up your own certificate authority (CA), but it requires getting more familiar with OpenSSL than is really necessary. To simplify the process, Ice includes the Python script `iceca`, located in the `bin` subdirectory of your Ice installation, that hides the complexity of OpenSSL and allows you to quickly perform the essential tasks:

- initializing a new root CA
- generating new certificate requests
- signing certificate requests to create a valid certificate chain
- converting certificates to match platform-specific requirements.

You are not obligated to use this script; IceSSL accepts certificates from any source as long as they are provided in the appropriate formats. However, you may find this tool sufficient for your development needs, and possibly even for your deployed application as well.

On this page:

- [Initializing a Certificate Authority](#)
- [Generating Certificate Requests](#)
- [Signing Certificate Requests](#)
- [Importing Certificates](#)
- [Certificate Authority Diagnostics](#)

### Initializing a Certificate Authority

Some of the script's activities use a directory that contains configuration files and a database of issued certificates. The script selects a default location for this directory that depends on your platform, or you can specify the parent directory explicitly by defining the `ICE_CA_HOME` environment variable and the script will use `$ICE_CA_HOME/ca` for its files.

The script command `iceca init` initializes a new CA by preparing a database directory and generating the root CA certificate and private key. It accepts the following command-line arguments:

```
$ python iceca init [--no-password] [--overwrite]
```

Upon execution, the script first checks the database directory to determine whether it has already been initialized. If so, the script terminates immediately with a warning unless you specify the `--overwrite` option, in which case the script overwrites the previous contents of the directory.

Next, the script displays the database directory it is using and begins to prompt you for the information it needs to generate the root CA certificate and private key. It offers a default choice for the CA's distinguished name and allows you to change it:

```
The subject name for your CA will be
CN=Grid-CA , O=GridCA-server
Do you want to keep this as the CA subject name? (y/n) [y]
```

To specify an alternate value for the distinguished name, enter `n` and type the new information, otherwise hit `Enter` to proceed.

```
Enter the email address of the CA: ca-admin@company.com
```

The address you provide in response to this prompt is shown to users that create certificate requests. Enter the address to which such requests should be sent.

The script shows its progress as it generates the certificate and private key, then prompts you for a pass phrase. If you prefer not to secure your CA's private key with a pass phrase, use the `--no-password` option when starting the script.

Upon completion, the script emits the following instructions:

```
The CA is initialized.

You need to distribute the following files to all machines that
can request certificates:

C:\iceca\req.cnf
C:\iceca\ca_cert.pem

These files should be placed in the user's home directory in
~/.iceca. On Windows, place these files in <ice-install>/config.
```

In this example, the `ICE_CA_HOME` environment variable was set to `C:\iceca`. As the script states, the files `req.cnf` and `ca_cert.pem` must be present on each host that can generate a certificate request. The script suggests a location for these files, which is the default directory used by the scripts if `ICE_CA_HOME` is not defined.

The `ca_cert.pem` file contains the root CA's certificate. Your IceSSL configurations must identify this certificate (in its proper form for each platform) as a trusted certificate. For example, you can use this file directly in the configuration of the C++ plug-in:

```
IceSSL.CertAuthFile=C:\iceca\ca_cert.pem
```

For .NET applications, you should [import the certificate file](#) into the proper store.

In Java, you need to add the certificate to your truststore:

```
$ keytool -import -trustcacerts -file ca_cert.pem -keystore ca.jks
Enter keystore password:
```

The keytool program requires you to enter a password, which you could use as the value of the property `IceSSL.TruststorePassword`.

Now that your certificate authority is initialized, you can begin generating certificate requests.

## Generating Certificate Requests

The script command `iceca request` uses the files you created while [initializing the CA](#) to generate a request for a new certificate. It accepts the following command-line arguments:

```
$ python iceca request [--overwrite] [--no-password] file common-name
[email]
```

The script looks for the files `req.cnf` and `ca_cert.pem` in the directory defined by the `ICE_CA_HOME` environment variable. If that variable is not defined, the script uses a default directory that depends on your platform.

The purpose of the script is to generate two files: a private key and a file containing the certificate request. The request file must be transmitted to the certificate authority for signing, which produces a valid certificate chain.

The argument `file` is used as a prefix for the names of the two output files created by the script:

- `file_key.pem` contains the private key
- `file_req.pem` contains the certificate request

If the output files already exist, you must specify `--overwrite` to force the script to overwrite them.

The `common-name` argument defines the common name component of the certificate's distinguished name. If the optional `email` argument is provided, it is also included in the certificate request.

During execution, the script displays its progress as it generates the necessary files. It will prompt you for a pass phrase unless you used the `--no-password` option, and finish by showing the names of the files it created as well as instructions on how to proceed. The example below shows the output from generating a request for an IceGrid node using a filename prefix of `node`:

```
$ iceca request node "IceGrid Node"

Created key: node_key.pem
Created certificate request: node_req.pem

The certificate request must be signed by the CA. Send the
certificate request file to the CA at the following email
address:
ca-admin@company.com
```

The file `node_key.pem` is the new private key for the node; this file must be kept secure. The file `node_req.pem` must be given to the certificate authority. As a convenience, the script displays the CA's email address that you entered [during initialization](#).

## Signing Certificate Requests

As a certificate authority, you are responsible for certifying the validity of certificate requests by signing them with your private key. The product of signing a request is a valid certificate chain that a person or application can use as an identity. The `iceca sign` command performs this task for you and accepts the following command-line arguments:

```
$ python iceca sign [--overwrite] --in <req> --out <cert> [--ip <ip>
--dns <dns>]
```

The input file `req` is the certificate request, and the output file `cert` is the resulting certificate chain. The script does not overwrite the file `cert` unless you also specify `--overwrite`. The `--ip` and `--dns` options allow you to add subject alternative names to the certificate for IP and DNS addresses, respectively.

Continuing our [previous example](#), we can sign the node's request with the following command:

```
$ python iceca sign --in node_req.pem --out node_cert.pem
```

If the CA's private key is protected by a pass phrase, we must enter that first. Next, the script displays the relevant information from the certificate request and asks you to confirm that you wish to sign the certificate:

```
The Subject's Distinguished Name is as follows
organizationName :PRINTABLE:'Company.com'
commonName :PRINTABLE:'IceGrid Node TestNode'
Certificate is to be certified until Jun 15 18:32:36 2011 GMT
Sign the certificate? [y/n]:
```

After reviewing the request, enter `y` to sign the certificate, and `y` again to finish the process. Upon completion, the script stores the certificate chain in the file `node_cert.pem` in your current working directory. This file, together with the node's private key we created when [generating the request](#), establishes a secure identity for the node.

## Importing Certificates

For Java and .NET users, the private key and certificate chain must be converted into a suitable format for your platform. The script command `iceca import` simplifies this process and accepts the following command-line arguments:

```
$ python iceca import [--overwrite] [--key-pass password] [--store-pass
password]
 [--java alias cert key keystore] [--cs cert key out-file]
```

The script does not overwrite an existing file unless you specify `--overwrite`. To avoid interactive prompts for passwords, you can use the `--key-pass` option to specify the password for the private key, and the `--store-pass` option to define the password for the Java keystore. Completing our node example from prior sections, the command below imports the private key and certificate chain into a Java keystore:

```
$ python iceca import --java mycert node_cert.pem node_key.pem cert.jks
```

The value `mycert` represents the alias associated with this entry in the keystore, and `cert.jks` is the name of the new keystore file. In an IceSSL configuration, the property `IceSSL.Keystore` refers to this file.

The equivalent command for .NET is shown below:

```
$ python iceca import --cs node_cert.pem node_key.pem cert.pfx
```

The file `cert.pfx` uses the PKCS#12 encoding and contains the certificate chain and private key. You can import this certificate into a store, or refer directly to the file using the configuration property `IceSSL.CertFile`.

## Certificate Authority Diagnostics

If you encounter a problem while using the `iceca` script, or simply want to learn more about the underlying OpenSSL commands used by the script, you can run the script with the `--verbose` option as shown below:

```
$ python iceca --verbose command ...
```

This option causes the script to display the commands as it executes them.

The script creates temporary files and directories that are normally deleted prior to the script's completion. If you would like to examine the

contents of these files and directories, use the `--keep` option:

```
$ python iceca --keep command ...
```

**See Also**

- [Configuring IceSSL](#)

# Glacier2

Glacier2 is a lightweight firewall traversal solution for Ice applications.

**i** We present many examples of client/server applications in this manual, most of which assume that the client and server programs are running either on the same host, or on multiple hosts with no network restrictions. We can justify this assumption because this is an instructional text, but a real-world network environment is usually much more complicated: client and server hosts with access to public networks often reside behind protective router-firewalls that not only restrict incoming connections, but also allow the protected networks to run in a private address space using Network Address Translation (NAT). These features, which are practically mandatory in today's hostile network environments, also disrupt the ideal world in which our examples are running.

## Topics

- [Common Firewall Traversal Issues](#)
- [About Glacier2](#)
- [How Glacier2 Works](#)
- [Getting Started with Glacier2](#)
- [Callbacks through Glacier2](#)
- [Glacier2 Helper Classes](#)
- [Securing a Glacier2 Router](#)
- [Glacier2 Session Management](#)
- [Dynamic Request Filtering with Glacier2](#)
- [Glacier2 Request Buffering](#)
- [How Glacier2 uses Request Contexts](#)
- [Configuring Glacier2 behind an External Firewall](#)
- [Advanced Glacier2 Client Configurations](#)
- [IceGrid and Glacier2 Integration](#)
- [Glacier2 Metrics](#)

## Common Firewall Traversal Issues

Let's assume that a client and server need to communicate over an untrusted network, and that the client and server hosts reside in private networks behind firewalls:

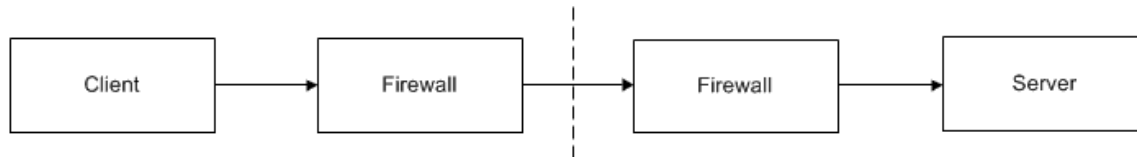

*Scenario 1: Client request in a typical network.*

Although the diagram looks fairly straightforward, there are several troublesome issues:

- A dedicated port on the server's firewall must be opened and configured to forward messages to the server.
- If the server uses multiple endpoints (e.g., to support both TCP and SSL), then a firewall port must be dedicated to each endpoint.
- The client's proxy must be configured to use the server's "public" endpoint, which is the host name and dedicated port of the firewall.
- If the server returns a proxy as the result of a request, the proxy must not contain the server's private endpoint because that endpoint is inaccessible to the client.

To complicate the scenario even further, the illustration below adds a callback from the server to the client. Callbacks imply that the client is also a server, therefore all of the issues associated with previous illustration now apply to the client as well.

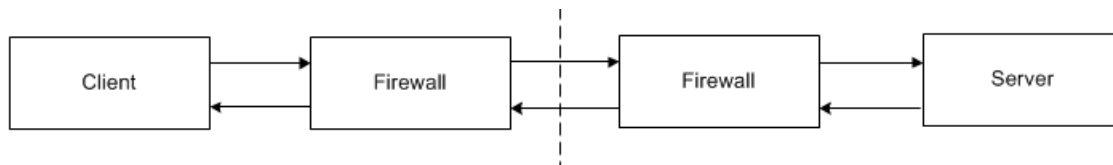

*Scenario 2: Callbacks in a typical network.*

As if this was not complicated enough already, the illustration below adds multiple clients and servers. Each additional server (including clients requiring callbacks) adds more work for the firewall administrator as more ports are dedicated to forwarding requests.

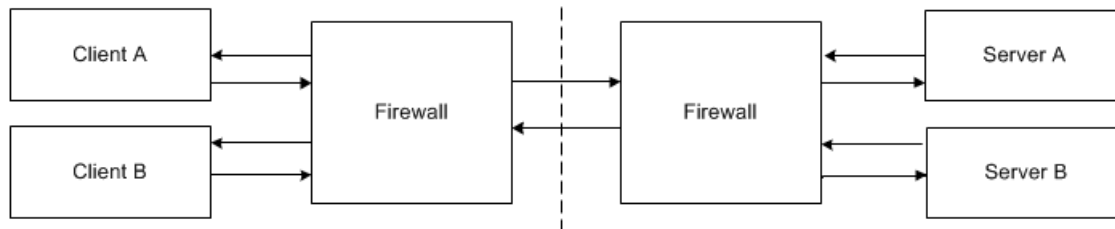

*Scenario 3: Multiple clients and servers with callbacks in a typical network.*

Clearly, these scenarios do not scale well, and are unnecessarily complex. Fortunately, Ice provides a solution in [Glacier2](#).

### See Also

- [About Glacier2](#)
- [How Glacier2 Works](#)
- [Getting Started with Glacier2](#)

## About Glacier2

Glacier2, the router-firewall for Ice applications, addresses [common firewall traversal issues](#) with minimal impact on clients or servers (or firewall administrators). In the illustration below, Glacier2 becomes the server firewall for Ice applications. What is not obvious in the diagram, however, is how Glacier2 eliminates much of the complexity of firewall traversal.

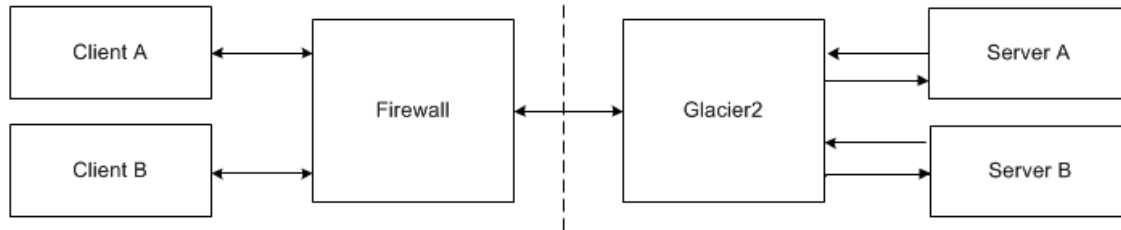

Complex network environments are a fact of life. Unfortunately, the cost of securing an enterprise's network is increased application complexity and administrative overhead. Glacier2 helps to minimize these costs by providing a low-impact, efficient and secure router for Ice applications.

Glacier2 has the following advantages and limitations.

### Advantages

- Clients often require only minimal changes to use Glacier2.
- Only one front-end port is necessary to support any number of servers, allowing a Glacier2 router to easily receive connections from a port-forwarding firewall.
- The number of connections to back-end servers is reduced. Glacier2 effectively acts as a connection concentrator, establishing a single connection to each back-end server to forward requests from any number of clients. Similarly, connections from back-end servers to Glacier2 for the purposes of sending callbacks are also concentrated.
- Servers are unaware of Glacier2's presence, and require no modifications whatsoever to use Glacier2. From a server's perspective, Glacier2 is just another local client, therefore servers are no longer required to advertise "public" endpoints in the proxies they create. Furthermore, back-end services such as [IceGrid](#) can continue to be used transparently via a Glacier2 router.
- [Callbacks through Glacier2](#) are supported without requiring new connections from servers to clients. In other words, a callback from a server to a client is sent over an existing connection from the client to the server, thereby eliminating the administrative requirements associated with supporting callbacks in the client firewall.
- Glacier2 requires no knowledge of the application's Slice definitions and therefore is very efficient: it routes request and reply messages without unmarshalling the message contents.
- In addition to its primary responsibility of forwarding Ice requests, Glacier2 offers support for [user-defined session management and authentication](#), [inactivity timeouts](#), and [request buffering and batching](#).

### Limitations

- Datagram protocols, such as UDP, are not supported.
- [Callback objects](#) in a client must use a Glacier2-supplied category in their identities.

### See Also

- [How Glacier2 Works](#)
- [Common Firewall Traversal Issues](#)
- [Callbacks through Glacier2](#)
- [IceGrid](#)



## How Glacier2 Works

The Ice core supports a generic router facility, represented by the `Ice::Router` interface, that allows a third-party service to "intercept" requests on a properly-configured proxy and deliver them to the intended server. Glacier2 is an implementation of this service, although other implementations are certainly possible.

Glacier2 normally runs on a host in the private network behind a [port-forwarding firewall](#), but it can also operate on a host with access to both public and private networks. In this configuration it follows that Glacier2 must have endpoints on each network.

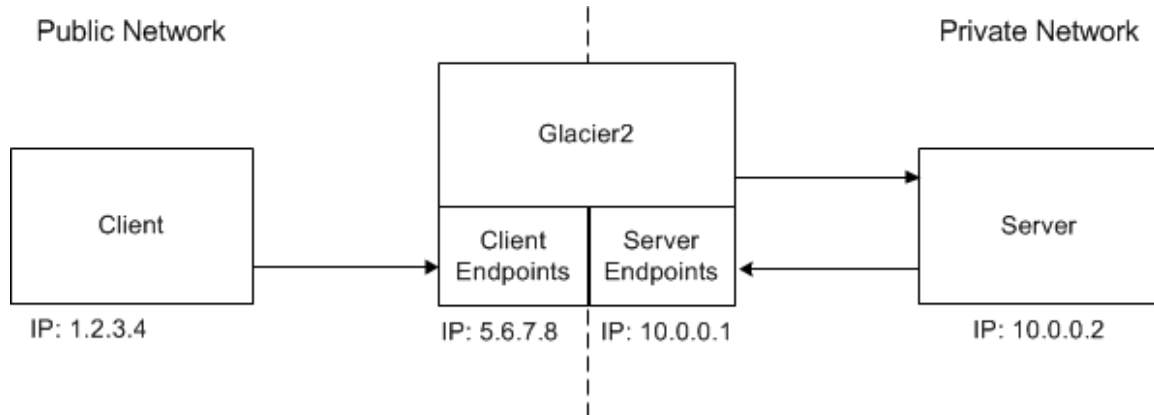

**i** For the sake of example, the router's public address is 5.6.7.8 and its private address is 10.0.0.1.

In the client, proxies must be configured to use Glacier2 as a router. This configuration can be done statically for all proxies created by a communicator, or programmatically for a particular proxy. A proxy configured to use a router is called a *routed proxy*.

When a client invokes an operation on a routed proxy, the client connects to one of Glacier2's client endpoints and sends the request as if Glacier2 is the server. Glacier2 then establishes an outgoing connection to the client's intended server in the private network, forwards the request to that server, and returns the reply (if any) to the client. Glacier2 is essentially acting as a local client on behalf of the remote client.

If a server returns a proxy as the result of an operation, that proxy contains the server's endpoints in the private network, as usual. (Remember, the server is unaware of Glacier2's presence, and therefore assumes that the proxy is usable by the client that requested it.) In the absence of a router, a client would receive an exception if it attempted to use such a proxy. When configured with a router, however, the client ignores the proxy's endpoints and always sends requests to the router's client endpoints instead.

Glacier2's server endpoints, which reside in the private network, are only used when a server makes a [callback to a client](#).

### See Also

- [Callbacks through Glacier2](#)
- [Configuring Glacier2 behind an External Firewall](#)

## Getting Started with Glacier2

On this page:

- [Using Glacier2](#)
- [Configuring the Router](#)
- [Writing a Password File](#)
- [Starting the Router](#)
- [Configuring a Glacier2 Client](#)
- [Glacier2 Object Identities](#)
- [Creating a Glacier2 Session](#)
- [Glacier2 Session Expiration](#)
- [Glacier2 Session Destruction](#)

### Using Glacier2

Using Glacier2 in a minimal configuration involves the following tasks:

1. Write a [configuration file](#) for the router.
2. Write a [password file](#) for the router. (Glacier2 also supports [other ways](#) to authenticate users.)
3. Decide whether to use the router's internal session manager, or supply your own [session manager](#).
4. [Start the router](#) on a host with access to the public and private networks.
5. Modify the [client configuration](#) to use the router.
6. Modify the client to create a [router session](#).
7. Ensure that the [router session remains active](#) for as long as the client requires it.



For the sake of example, the router's public address is 5.6.7.8 and its private address is 10.0.0.1.

### Configuring the Router

The following router configuration properties establish the necessary endpoint and define when a session expires due to inactivity:

```
Glacier2.Client.Endpoints=tcp -h 5.6.7.8 -p 4063
Glacier2.SessionTimeout=60
```

The endpoint defined by `Glacier2.Client.Endpoints` is used by the Ice run time in a client to interact directly with the router. It is also the endpoint where requests from routed proxies are sent. This endpoint is defined on the public network interface because it must be accessible to clients. Furthermore, the endpoint uses a fixed port because clients may be statically configured with a proxy for this endpoint. The port numbers 4063 (for TCP) and 4064 (for SSL) are reserved for Glacier2 by the Internet Assigned Numbers Authority (IANA).



This sample configuration uses TCP as the endpoint protocol, although in most cases, [SSL is preferable](#).

A client must [create a session](#) in order to use a Glacier2 router. Our setting for the `Glacier2.SessionTimeout` property causes the router to destroy sessions that have been idle for at least 60 seconds. It is not mandatory to define a timeout, but it is recommended, otherwise session state might accumulate in the router.

Note that this configuration enables the router to forward requests from clients to servers. Additional configuration is necessary to support [cal lbacks](#) from servers to clients.

You must also decide which authentication scheme (or schemes) to use. A [file-based](#) mechanism is available, as are [more sophisticated strategies](#).

If clients access a [location service](#) via the router, additional router configuration is typically necessary.

## Writing a Password File

The router's simplest authentication mechanism uses an access control list in a text file consisting of user name-password pairs. The password is a 13-character string encoded using the `crypt` algorithm, similar to a `passwd` file on a typical Unix system.

The property `Glacier2.CryptPasswords` specifies the name of the password file:

```
Glacier2.CryptPasswords=passwords
```

The format of the password file is very simple. Each user name-password pair must reside on a separate line, with whitespace separating the user name from the password. For example, the following password file contains an entry for the user name `test`:

```
test xxMqsnnDcK8tw
```

You can use the `openssl` utility (included in the OpenSSL toolkit) to generate `crypt` passwords:

```
$ openssl
OpenSSL> passwd
Password:
Verifying - Password:
xxMqsnnDcK8tw
```

At the prompt, issue the `passwd` command. You are asked for a password, and then asked to confirm the password, at which point the utility displays a `crypt`-encoded version of your password that you can paste into the router's password file.



The `crypt`-based authentication scheme is not intended for use in secure applications. We recommend installing a custom [permissions verifier](#) that uses a more secure form of authentication instead.

## Starting the Router

The router supports the following command-line options:

```
$ glacier2router -h
Usage: glacier2router [options]
Options:
-h, --help Show this message.
-v, --version Display the Ice version.
--nowarn Suppress warnings.
```

The `--nowarn` option prevents the router from displaying warning messages at startup when it is unable to contact a permissions verifier object or a session manager object specified by its configuration.

Additional command line options are supported, including those that allow the router to run as a [Windows service](#) or [Unix daemon](#), and Ice includes a [utility](#) to help you install the router as a Windows service.

Assuming our configuration properties are stored in a file named `config`, you can start the router with the following command:

```
$ glacier2router --Ice.Config=config
```

## Configuring a Glacier2 Client

The following properties configure a client to use a Glacier2 router:

```
Ice.Default.Router=Glacier2/router:tcp -h 5.6.7.8 -p 4063
Ice.ACM.Client=0
Ice.RetryIntervals=-1
```

The `Ice.Default.Router` property defines the router proxy. Its endpoints must match those in `Glacier2.Client.Endpoints`.

The `Ice.ACM.Client` property governs the behavior of [Active Connection Management \(ACM\)](#), which conserves resources by periodically closing idle outgoing connections. This feature must be disabled in a client that uses a Glacier2 router, otherwise ACM might transparently close a client's connection to a router and thereby terminate the router session prematurely. ACM is enabled by default, and therefore must be disabled by setting this property to zero.

Finally, setting `Ice.RetryIntervals` to -1 disables [automatic retries](#), which are not useful for proxies configured to use a Glacier2 router.

## Glacier2 Object Identities

A Glacier2 router hosts two well-known objects. The default identities of these objects are `Glacier2/router` and `Glacier2/admin`, corresponding to the `Glacier2::Router` and `Glacier2::Admin` interfaces, respectively. If an application requires the use of multiple different (that is, not replicated) routers, it is a good idea to assign unique identities to these objects by configuring the routers with different values of the `Glacier2.InstanceName` property, as shown in the following example:

```
Glacier2.InstanceName=PublicRouter
```

This property changes the category of the object identities, which become `PublicRouter/router` and `PublicRouter/admin`. The client's configuration must also be changed to reflect the new identity:

```
Ice.Default.Router=PublicRouter/router:tcp -h 5.6.7.8 -p 4063
```

One exception to this rule is if you deploy multiple Glacier2 routers as replicas, for example, to gain redundancy or to distribute the message-forwarding load over a number of machines. In that case, all the routers must use the same instance name, and the router clients can use proxies with multiple endpoints, such as:

```
Ice.Default.Router=PublicRouter/router:tcp -h 5.6.7.8 -p 4063:tcp -h
6.10.7.8 -p 4063
```

## Creating a Glacier2 Session

Session management is provided by the `Glacier2::Router` interface:

### Slice

```

module Glacier2 {
 exception PermissionDeniedException {
 string reason;
 };

 interface Router extends Ice::Router {
 Session* createSession(string userId, string password)
 throws PermissionDeniedException,
 CannotCreateSessionException;

 Session* createSessionFromSecureConnection()
 throws PermissionDeniedException,
 CannotCreateSessionException;

 idempotent string getCategoryForClient();

 void refreshSession()
 throws SessionNotExistException;

 void destroySession()
 throws SessionNotExistException;

 idempotent long getSessionTimeout();
 };
};

```

The interface defines two operations for creating sessions: `createSession` and `createSessionFromSecureConnection`. The router requires each client to create a session using one of these operations; only after the session is created will the router forward requests on behalf of the client.

The `createSession` operation expects a user name and password and, depending on the [router's configuration](#), returns either a `Session` proxy or nil. When using the default authentication scheme, the given user name and password must match an entry in the router's password file in order to successfully create a session.

The `createSessionFromSecureConnection` operation does not require a user name and password because it authenticates the client using the credentials associated with the client's [SSL connection](#) to the router.

To create a session, the client typically obtains the router proxy from the communicator, downcasts the proxy to the `Glacier2::Router` interface, and invokes one of the `create` operations. The sample code below demonstrates how to do it in C++; the code will look very similar in the other language mappings.

**C++**

```

Ice::RouterPrx defaultRouter = communicator->getDefaultRouter();
Glacier2::RouterPrx router =
Glacier2::RouterPrx::checkedCast(defaultRouter);
string username = ...;
string password = ...;
Glacier2::SessionPrx session;
try
{
 session = router->createSession(username, password);
}
catch(const Glacier2::PermissionDeniedException& ex)
{
 cout << "permission denied:\n" << ex.reason << endl;
}
catch(const Glacier2::CannotCreateSessionException& ex)
{
 cout << "cannot create session:\n" << ex.reason << endl;
}

```

If the router is configured with a [session manager](#), the `createSession` and `createSessionFromSecureConnection` operations may return a proxy for an object implementing the `Glacier2::Session` interface (or an application-specific derived interface). The client receives a null proxy if no session manager is configured.

A non-nil session proxy returned by a `create` operation must be configured with the router that created it because the session object is only accessible via the router. If the router is configured as the client's default router at the time `createSession` or `createSessionFromSecureConnection` is invoked, as is the case in the example above, then the session proxy is already properly configured and nothing else is required. Otherwise, the client must explicitly configure the session proxy with a router using the `ice_router` proxy method.

If the client wishes to destroy the session explicitly, it must invoke `destroySession` on the router proxy. If a client does not destroy its session, the router destroys it automatically when it expires due to inactivity. A client can obtain the inactivity timeout value by calling `getSessionTimeout` and keep the session alive by [periodically calling `refreshSession`](#) if necessary.



The `getCategoryForClient` operation is used to implement [callbacks](#) over bidirectional connections.

**Example**

An example of a Glacier2 client is provided in the directory `demo/Glacier2/callback`.

## Glacier2 Session Expiration

A Glacier2 router may be configured to destroy sessions after a period of inactivity. This feature allows the router, as well as a custom [session manager](#), to reclaim resources acquired during the session, but it requires some coordination between the router and its clients.

Ideally you would select a [session timeout](#) that is long enough to accommodate the usage patterns of your clients. For example, a session timeout of thirty seconds is a reasonable choice for a client that invokes an operation on a back-end server once every five seconds. However, that timeout could disrupt a different client that has long periods of inactivity, such as when its invocations are prompted by human interaction.

If you cannot predict with certainty the usage patterns of your clients, we recommend modifying the clients so that they actively prevent their sessions from expiring. A client simply needs to make an invocation at regular intervals, where the period is less than the router's timeout by

a comfortable margin. Typically a client creates a dedicated thread whose only purpose is keeping the session alive. It can accomplish this by invoking `refreshSession` on the router proxy, or by invoking the `ice_ping` operation on the proxy of any back-end object that is accessed via the router (including the `Session` proxy, if one was returned by `createSession`). Ice includes [helper classes](#) that you can use to simplify the task of create a session and keeping it alive.

Note that if a session times out, the next client invocation raises `ConnectionLostException`. To re-establish the session, the client must explicitly re-create it. If the client uses [callbacks](#), it must also re-create the callback adapter and re-register its callback servants.

## Glacier2 Session Destruction

A router session is destroyed automatically when the [session expires](#), and when a client explicitly destroys its session. The router also destroys a session if certain connection errors occur while attempting to route a request. These errors are represented by the run-time exceptions `SocketException`, `TimeoutException`, and `ProtocolException`. In other words, if any of these exceptions occur while Glacier2 attempts to establish a connection to the target back-end server, or forward a request to the target back-end server, the router automatically destroys the session.

### See Also

- [Callbacks through Glacier2](#)
- [Securing a Glacier2 Router](#)
- [Glacier2 Session Management](#)
- [Glacier2 Properties](#)
- [Windows Services](#)
- [Active Connection Management](#)
- [Automatic Retries](#)
- [Glacier2 Helper Classes](#)

## Callbacks through Glacier2

Callbacks from servers to clients are commonly used in distributed applications, often to notify the client about an event such as the completion of a long-running calculation or a change to a database record. Unfortunately, supporting callbacks in a complicated network environment presents its own [set of problems](#). Ice overcomes these obstacles using a Glacier2 router and bidirectional connections.

On this page:

- [Bidirectional Connections with Glacier2](#)
- [Callbacks and Connection Closure](#)
- [Configuring the Router for Callbacks](#)
- [Configuring the Client's Object Adapter with a Router](#)
- [Callback Object Identities](#)
- [Nested Invocations with a Router](#)
- [Handling Session Timeouts](#)



### Example

The `demo/Glacier2/callback` example illustrates the use of callbacks with Glacier2. The `README` file in the directory provides instructions on running the example, and comments in the configuration file describe the properties in detail.

## Bidirectional Connections with Glacier2

While a regular unrouted connection allows requests to flow in only one direction (from client to server), a [bidirectional connection](#) enables requests to flow in both directions. This capability is necessary to circumvent the network restrictions that commonly cause [firewall traversal issues](#), namely, client-side firewalls that prevent a server from establishing an independent connection directly to the client. By sending callback requests over the existing connection from the client to the server (more accurately, from the client to the router), we have created a virtual connection back to the client.

This diagram shows the steps involved in making a callback using Glacier2:

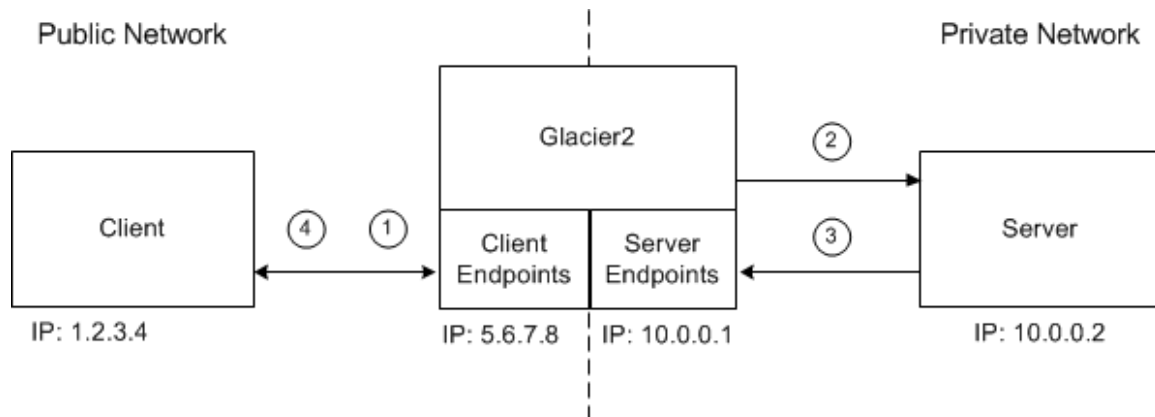

1. The client has a routed proxy for the server and makes an invocation. A connection is established to the router's client endpoint and the request is sent to the router.
2. The router, using information from the client's proxy, establishes a connection to the server and forwards the request. In this example, one of the arguments in the request is a proxy for a callback object in the client.
3. The server makes a callback to the client. For this to succeed, the proxy for the callback object must contain endpoints that are accessible to the server. The only path back to the client is through the router, therefore the proxy contains the [router's server endpoints](#). The server connects to the router and sends the request.
4. The router forwards the callback request to the client using the bidirectional connection established in step 1.

The arrows in the above illustration indicate the flow of requests; notice that two connections are used between the router and the server. Since the server is unaware of the router, it does not use routed proxies, and therefore does not use bidirectional connections.







It is also possible for applications to manually configure bidirectional connections without the use of a router.

## Callbacks and Connection Closure

When a client terminates, it closes its connection to the router. If a server later attempts to make a callback to the client, the attempt fails because the router has no connection to the client over which to forward the request. This situation is no worse than if the server attempted to contact the client directly, which would be prevented by the client's firewall. However, this illustrates the inherent limitation of bidirectional connections: the lifetime of a client's callback proxy is bounded by the lifetime of the client's router session.

## Configuring the Router for Callbacks

In order for the router to support callbacks from servers, it needs to have endpoints in the private network.

The configuration file shown below adds the property `Glacier2.Server.Endpoints`:

```
Glacier2.Client.Endpoints=tcp -h 5.6.7.8 -p 4063
Glacier2.Server.Endpoints=tcp -h 10.0.0.1
```

As this example shows, the server endpoint does not require a fixed port.

## Configuring the Client's Object Adapter with a Router

A client that receives callbacks is also a server, and therefore must have an object adapter. Typically, an object adapter has endpoints in the local network, but those endpoints are of no use to a server in our restricted network environment. We really want the client's callback proxy to contain the router's server endpoints, and we accomplish that by configuring the client's object adapter with a proxy for the router.?



Note that multiple object adapters created by the same communicator cannot use the same router.

We supply the router's proxy by creating the object adapter with `createObjectAdapterWithRouter`, or by defining the object adapter property `adapter.Router` as shown below:

```
CallbackAdapter.Router=Glacier2/router:tcp -h 5.6.7.8 -p 4063
```

For each object adapter, the Ice run time maintains a [list of endpoints](#) that are embedded in proxies created by that adapter. Normally, this list simply contains the local endpoints defined for the object adapter but, when the adapter is configured with a router, the list only contains the router's server endpoints.

An object adapter configured in this way allows the client to receive callback requests via the router. If the client also wants to service requests via local (non-routed) endpoints, the client must [create a separate adapter](#) for these requests.

## Callback Object Identities

Glacier2 assigns a unique category to each client for use in the [identities](#) of the client's callback objects. The client creates proxies that contain this identity category and pass these proxies to back-end servers for use in making callback requests to the client. This category serves two purposes:

1. Upon receipt of a callback request from a back-end server, the router uses the request's category to identify the intended client.
2. The category is sufficiently random that, without knowing the category in advance, it is practically impossible for a misbehaving or malicious back-end server to send callback requests to an arbitrary client.

A client can obtain its assigned category by calling `getCategoryForClient` on the `Router` interface as shown in the example below:

**C++**

```
Glacier2::RouterPrx router = // ...
string category = router->getCategoryForClient();
```

## Nested Invocations with a Router

If a router client intends to receive callbacks and make nested twoway invocations, it is important that the client be configured correctly. Specifically, you must [increase the size of the client thread pool](#) to at least two threads.

## Handling Session Timeouts

If the client's session [times out](#), the next invocation raises `ConnectionLostException`. The client can recover from this situation by re-creating the session, re-creating the callback adapter, and adding all the callback servants to the [Active Servant Map \(ASM\)](#) of the re-created adapter.

### See Also

- [Bidirectional Connections](#)
- [Object Adapter Endpoints](#)
- [Object Identity](#)
- [Getting Started with Glacier2](#)
- [The Active Servant Map](#)
- [Glacier2 Properties](#)

## Glacier2 Helper Classes

Ice includes a number of helper classes to help you build robust Glacier2 clients.

- [The Glacier2::Application Class](#)
- GUI Helper Classes
  - [The SessionFactoryHelper Class](#)
  - [The SessionHelper Class](#)
  - [The SessionCallback Interface](#)

### The Glacier2::Application Class

You may already be familiar with the [Ice::Application](#) class, which encapsulates some basic Ice functionality such as communicator initialization, communicator destruction, and proper handling of signals and exceptions. The [Glacier2::Application](#) extends [Ice::Application](#) to add functionality that is commonly needed by Glacier2 clients:

- Keeps a session alive by periodically sending "ping" requests from a background thread
- Automatically restarts a session if a failure occurs
- Optionally creates an object adapter for callbacks
- Destroys the session when the application completes

The C++ definition of [Glacier2::Application](#) is shown below. (The Java and C# versions offer identical functionality so we do not show them here.)

## C++

```

namespace Glacier2 {

class Application : public Ice::Application {
public:
 Application();
 Application(Ice::SignalPolicy policy);

 virtual int runWithSession(int argc, char* argv[]) = 0;

 virtual Glacier2::SessionPrx createSession() = 0;

 virtual void sessionDestroyed();

 static Glacier2::RouterPrx router();

 static Glacier2::SessionPrx session();

 void restart();

 std::string categoryForClient();

 Ice::Identity createCallbackIdentity(const std::string& name);

 Ice::ObjectPrx addWithUUID(const Ice::ObjectPtr& servant);

 Ice::ObjectAdapterPtr objectAdapter();
};
}

```

The following methods are supported:

- `Application()`  
Instantiating the class using its default constructor has the same semantics as calling `Application(Ice::HandleSignals)`.
- `Application(Ice::SignalPolicy policy)`  
This constructor allows you to indicate whether the class should handle signals. The `SignalPolicy` enumeration contains two enumerators: `HandleSignals` and `NoSignalHandling`. If you specify `HandleSignals`, the class automatically shuts down or destroys its communicator upon receipt of certain signals. Refer to the `Ice::Application` documentation in the relevant language mapping chapter for more information on signal handling.
- `int runWithSession(int argc, char* argv[])`  
This method must be overridden by a subclass and represents the "main loop" of the application. It is called after the communicator has been initialized and the Glacier2 session has been established. The argument vector passed to this method contains the arguments passed to `Application::main` with all Ice-related options removed. The implementation of `runWithSession` must return zero to indicate success and non-zero to indicate failure; the value returned by `runWithSession` becomes the return value of `Application::main`.

`runWithSession` can call `restart` to restart the session. This destroys the current session, creates a new session (by calling `cr`

ateSession), and calls `runWithSession` again. The `Application` base class also restarts the session if `runWithSession` raises (or allows to be raised) any of the following exceptions:

**This page contains macros or features from a plugin which requires a valid license.**

You will need to:

1. Install the [Plugin Licensing Manager](#).
2. Visit the Plugin Licensing Manager and acquire the necessary licenses.

[Licensing Help?](#)

The Adaptavist Content Formatting Macros plugin requires a license.

**This page contains macros or features from a plugin which requires a valid license.**

You will need to:

1. Install the [Plugin Licensing Manager](#).
2. Visit the Plugin Licensing Manager and acquire the necessary licenses.

[Licensing Help?](#)

The Adaptavist Content Formatting Macros plugin requires a license.

- `Ice::ConnectionLostException`

**This page contains macros or features from a plugin which requires a valid license.**

You will need to:

1. Install the [Plugin Licensing Manager](#).
2. Visit the Plugin Licensing Manager and acquire the necessary licenses.

[Licensing Help?](#)

The Adaptavist Content Formatting Macros plugin requires a license.

- `Ice::ConnectionRefusedException`

**This page contains macros or features from a plugin which requires a valid license.**

You will need to:

1. Install the [Plugin Licensing Manager](#).
2. Visit the Plugin Licensing Manager and acquire the necessary licenses.

[Licensing Help?](#)

The Adaptavist Content Formatting Macros plugin requires a license.

- `Ice::RequestFailedException`

**This page contains macros or features from a plugin which requires a valid license.**

You will need to:

1. Install the [Plugin Licensing Manager](#).
2. Visit the Plugin Licensing Manager and acquire the necessary licenses.

[Licensing Help?](#)

The Adaptavist Content Formatting Macros plugin requires a license.

- `Ice::TimeoutException`

**This page contains macros or features from a plugin which requires a valid license.**

You will need to:

1. Install the [Plugin Licensing Manager](#).
2. Visit the Plugin Licensing Manager and acquire the necessary licenses.

[Licensing Help?](#)

The Adaptavist Content Formatting Macros plugin requires a license.

- `Ice::UnknownLocalException`

All other exceptions cause the current session to be destroyed without restarting.

- `Glacier2::SessionPrx createSession()`  
This method must be overridden by a subclass to create the application's Glacier2 session. A successful call to `createSession` is followed by a call to `runWithSession`. The application terminates if `createSession` raises (or allows to be raised) an `Ice::LocalException`.
- `void sessionDestroyed()`  
A subclass can optionally override this method to take action when connectivity with the Glacier2 router is lost.
- `Glacier2::RouterPrx router()`  
Returns the proxy for the Glacier2 router.
- `Glacier2::SessionPrx session()`  
Returns the proxy for the current session.
- `void restart()`  
Causes `Application` to destroy the current session, create a new session (by calling `createSession`), and start a new main loop (in `runWithSession`). This method does not return but rather raises a `RestartSessionException` that is trapped by `Application`.
- `std::string categoryForClient()`  
Returns the category to be used in the identities of all of the client's callback objects. Clients must use this category for the router to forward [callback requests](#) to the intended client. The method raises `SessionNotExistException` if no session is currently active.
- `Ice::Identity createCallbackIdentity(const std::string& name)`  
Creates a new Ice identity for a callback object with the given identity name.
- `Ice::ObjectPrx addWithUUID(const Ice::ObjectPtr& servant)`  
Adds a servant to the callback object adapter's Active Servant Map using a UUID for the identity name.
- `Ice::ObjectAdapterPtr objectAdapter()`  
Returns the object adapter used for callbacks, creating the object adapter if necessary.



#### Example

The Ice distribution includes an example in `demo/Glacier2/callback` that shows how to use the `Glacier2::Application` class.

## GUI Helper Classes

The "main loop" design imposed by the `Glacier2::Application` class is not suitable for graphical applications, therefore Ice also includes a collection of Java and C# classes that better accommodate the needs of GUI programs:

- `Glacier2.SessionFactoryHelper`  
This class simplifies the task of creating a Glacier2 session. It provides overloaded `connect` methods that support the two authentication styles (user name/password and SSL credentials) accepted by the Glacier2 router, and returns an instance of `Glacier2.SessionHelper` for each new session.

- `Glacier2.SessionHelper`  
This class encapsulates a Glacier2 session and provides much of the same functionality as `Glacier2::Application`. The application must supply an instance of `Glacier2.SessionCallback` when creating the session; `SessionHelper` invokes this callback object when important events occur in the session's lifecycle.
- `Glacier2.SessionCallback`  
An application implements this interface to receive notification about session lifecycle events.

The classes are discussed further in the subsections below.



#### Example

You can find sample applications that make use of these classes in the `demo/Glacier2/chat` directory of your Ice distribution.

## The `SessionFactoryHelper` Class

The `SessionFactoryHelper` class provides convenience methods for configuring the settings that are commonly used to create a Glacier2 session, such as the router's host and port number. Once the application has completed its configuration, it calls one of the `connect` methods to initialize a communicator, establish a Glacier2 session, and receive a `SessionHelper` object with which it can manage the new session. An application should create a new `SessionFactoryHelper` object for each router instance that it uses.

`SessionFactoryHelper` creates an `Ice.InitializationData` object if the application does not pass one to the `SessionFactoryHelper` constructor. `SessionFactoryHelper` also creates a new property set if necessary, and then sets some configuration properties required by Glacier2 clients. The resulting `InitializationData` object is eventually used in `connect` to initialize a new communicator.

The Java definition of `SessionFactoryHelper` is shown below (the C# version is nearly identical and is not shown here):

## Java

```

package Glacier2;

public class SessionFactoryHelper {

 public SessionFactoryHelper(SessionCallback callback)
 throws Ice.InitializationException;

 public SessionFactoryHelper(Ice.InitializationData initData,
 SessionCallback callback)
 throws Ice.InitializationException;

 public SessionFactoryHelper(Ice.Properties properties,
 SessionCallback callback)
 throws Ice.InitializationException;

 public void setRouterIdentity(Ice.Identity identity);
 public Ice.Identity getRouterIdentity();

 public void setRouterHost(String hostname);
 public String getRouterHost();

 public void setSecure(boolean secure);
 public boolean getSecure();

 public void setTimeout(int timeoutMillisecs);
 public int getTimeout();

 public void setPort(int port);
 public int getPort();

 public Ice.InitializationData getInitializationData();

 public void setConnectContext(java.util.Map<String, String> ctx);

 public SessionHelper connect();
 public SessionHelper connect(String username, String password);
}

```

The following methods are supported:

- `SessionFactoryHelper(SessionCallback callback)`  
This constructor is useful when your application has no other configuration requirements. The constructor allocates an `InitializationData` object and a new property set. The callback argument must not be null.
- `SessionFactoryHelper(Ice.InitializationData initData, SessionCallback callback)`  
Use this constructor when you want to prepare your own instance of `InitializationData`. The callback argument must not be null.



- `SessionFactoryHelper(Ice.Properties properties, SessionCallback callback)`  
This constructor is convenient when you wish to supply an initial set of properties. The callback argument must not be null.
- `void setRouterIdentity(Ice.Identity identity)`  
`Ice.Identity getRouterIdentity()`  
Determines the object identity of the Glacier2 router. Note that this setting is only used if `Ice.Default.Router` is undefined.
- `void setRouterHost(String hostname)`  
`String getRouterHost()`  
Determines the host name of the Glacier2 router. Note that this setting is only used if `Ice.Default.Router` is undefined.
- `void setSecure(boolean secure)`  
`boolean getSecure()`  
Determines whether the connection to the Glacier2 router must be secure. Note that this setting is only used if `Ice.Default.Router` is undefined.
- `void setTimeout(int timeoutMillisecs)`  
`int getTimeout()`  
Determines the timeout setting (in milliseconds) for the connection to the Glacier2 router. No timeout is used if the argument is less than or equal to zero. Note that this setting is only used if `Ice.Default.Router` is undefined.
- `void setPort(int port)`  
`int getPort()`  
Determines the port on which the Glacier2 router is listening. Note that this setting is only used if `Ice.Default.Router` is undefined.
- `Ice.InitializationData getInitializationData()`  
Returns a reference to the `InitializationData` object that will be used during communicator initialization. If necessary, an application can make modifications to this object prior to calling `connect`.
- `void setConnectContext(java.util.Map<String, String> ctx)`  
Sets the request context to be used when creating a session. This method must be invoked prior to `connect`.
- `SessionHelper connect()`  
Initializes a communicator, creates a Glacier2 session using SSL credentials, and returns a new `SessionHelper` object. The `connected` method is invoked on the session callback if the session was created successfully, otherwise the callback's `connectFailed` method is invoked.
- `SessionHelper connect(String username, String password)`  
Initializes a communicator, creates a Glacier2 session using the given user name and password, and returns a new `SessionHelper` object. The `connected` method is invoked on the session callback if the session was created successfully, otherwise the callback's `connectFailed` method is invoked.

## The SessionHelper Class

The `SessionHelper` class encapsulates a Glacier2 session and keeps the session alive by periodically "pinging" the router. `SessionHelper` also provides several convenience methods for common session-related actions:

## Java

```

package Glacier2;

public class SessionHelper {

 public void destroy();

 public Ice.Communicator communicator();

 public String categoryForClient()
 throws SessionNotExistException;

 public Ice.ObjectPrx addWithUUID(Ice.Object servant)
 throws SessionNotExistException;

 public Glacier2.SessionPrx session()
 throws SessionNotExistException;

 public boolean isConnected();

 public Ice.ObjectAdapter objectAdapter()
 throws SessionNotExistException;
}

```

The following methods are supported:

- `void destroy()`  
Initiates the destruction of the Glacier2 session, including the communicator created by the `SessionHelper`. This is a non-blocking method that spawns a background thread to perform potentially blocking activities. `SessionHelper` invokes the `disconnected` method on the application's callback object to indicate the completion of the `destroy` request. If the session has already been destroyed when `destroy` is called, the method does nothing.
- `Ice.Communicator communicator()`  
Returns the communicator created by the `SessionHelper`.
- `String categoryForClient()`  
Returns the category that must be used in the identities of all callback objects. Raises `SessionNotExistException` if no session is currently active.
- `Ice.ObjectPrx addWithUUID(Ice.Object servant)`  
Adds a servant to the callback object adapter using a UUID for the identity name. Raises `SessionNotExistException` if no session is currently active.
- `Glacier2.SessionPrx session()`  
Returns a proxy for the Glacier2 session. Raises `SessionNotExistException` if no session is currently active.
- `boolean isConnected()`  
Returns true if the session is currently active, false otherwise.
- `Ice.ObjectAdapter objectAdapter()`  
Returns the callback object adapter, creating it if necessary. Raises `SessionNotExistException` if no session is currently active.

 The Java implementation of `SessionHelper` installs a JVM shutdown hook that calls `destroy` when the application is about to exit.

## The `SessionCallback` Interface

An application must supply an instance of `SessionCallback` when instantiating a `SessionFactoryHelper` object. The callback methods allow the application to receive notification about events in the lifecycle of the session:

### Java

```
package Glacier2;

public interface SessionCallback {

 void createdCommunicator(SessionHelper session);

 void connected(SessionHelper session)
 throws SessionNotExistException;

 void disconnected(SessionHelper session);

 void connectFailed(SessionHelper session, Throwable ex);
}
```

The following callback methods are supported:

- `void createdCommunicator(SessionHelper session)`  
Called after successfully initializing a communicator.
- `void connected(SessionHelper session)`  
Called after successfully establishing the Glacier2 session. The method can raise `SessionNotExistException` to force the new session to be destroyed.
- `void disconnected(SessionHelper session)`  
Called after the Glacier2 session is destroyed.
- `void connectFailed(SessionHelper session, Throwable ex)`  
Called if a failure occurred while attempting to establish a Glacier2 session.

### See Also

- [The Server-Side main Function in C++](#)
- [Callbacks through Glacier2](#)
- [Glacier2 Session Management](#)

## Securing a Glacier2 Router

As a firewall, a Glacier2 router represents a doorway into a private network, and in most cases that doorway should have a good lock. The obvious first step is to use [SSL](#) for the router's client endpoints. This allows you to secure the message traffic and restrict access to clients having the proper credentials. However, the router takes security even further by providing access control and filtering capabilities.

On this page:

- [Glacier2 Access Control](#)
  - [Password Authentication](#)
  - [Certificate Authentication](#)
  - [Interaction with a Permissions Verifier](#)
  - [Obtaining SSL Credentials for a Router Client](#)
- [Request Filtering](#)
  - [Address Filters](#)
  - [Category Filters](#)
  - [Identity Filters](#)
  - [Adapter Filters](#)
  - [Proxy Filters](#)
  - [Client Impact](#)
- [Glacier2 Routing Table](#)
- [Glacier2 Administrative Interface](#)

### Glacier2 Access Control

The authentication capabilities of SSL may not be sufficient for all applications: the certificate validation phase of the SSL handshake verifies that the user is who he says he is, but how do we know that he should be allowed to use the router? Glacier2 addresses this issue through the use of an access control facility that supports two forms of authentication: passwords and certificates. You can configure the router to use whichever authentication method is most appropriate for your application, or you can configure both methods in the same router.

#### Password Authentication

The router verifies the user name and password arguments to its `createSession` operation before it forwards any requests on behalf of the client. Given that the password is sent "in the clear," it is important to protect these values by using an SSL connection with the router.

There are two ways for the router to verify a user name and password. By default, the router uses a file-based access control list, but you can override this behavior by installing a proxy for an application-defined verifier object. Configuration properties define the password file name or the verifier proxy; if you install a verifier proxy, the password file is ignored. Since we have already discussed the [password file](#), we will focus on the custom verifier interface here.

An application that has special requirements can implement the interface `Glacier2::PermissionsVerifier` to gain programmatic control over access to a router. This can be especially useful in situations where a repository of account information already exists (such as an LDAP directory), in which case duplicating that information in another file would be tedious and error-prone.

The Slice definition for the interface contains just one operation:

**Slice**

```

module Glacier2 {
 interface PermissionsVerifier {
 idempotent bool checkPermissions(string userId, string password,
out string reason)
 throws PermissionDeniedException;
 };
};

```

The router invokes `checkPermissions` on the verifier object, passing it the user name and password arguments that were given to `createSession`. The operation must return true if the arguments are valid, and false otherwise. If the operation returns false, a reason can be provided in the output parameter. Starting with Ice 3.5, `checkPermissions` can also throw `Glacier2::PermissionDeniedException`. Glacier2 forwards this exception as-is to the client, which means the verifier can raise a subclass of `PermissionDeniedException` in order to provide more information to the client.

To configure a router with a custom verifier, set the configuration property `Glacier2.PermissionsVerifier` with the proxy for the object.

In situations where authentication is not necessary, such as during development or when running in a trusted environment, you can use Glacier2's built-in "null" permissions verifier. This object accepts any combination of user name and password, and you can enable it with the following property definition:

```
Glacier2.PermissionsVerifier=Glacier2/NullPermissionsVerifier
```

Note that the category of the object's identity (`Glacier2` in this example) must match the value of the property `Glacier2.InstanceName`.



#### Example

A sample implementation of the `PermissionsVerifier` interface is provided in the `demo/Glacier2/callback` directory.

## Certificate Authentication

The `createSessionFromSecureConnection` operation does not require a user name or password because the client's SSL connection to the router already supplies the credentials necessary to sufficiently identify the client, in the form of X.509 certificates.

It is up to you to decide what constitutes sufficient identification. For example, a single certificate could be shared by all clients if there is no need to distinguish between them, or you could generate a unique certificate for each client or a group of clients. Glacier2 does not enforce any particular policy, but simply delegates the decision of whether to accept the client's credentials to an application-defined object that implements the `Glacier2::SSLPermissionsVerifier` interface:

```

Slice
module Glacier2 {
 interface SSLPermissionsVerifier {
 idempotent bool authorize(SSLInfo info, out string reason)
 throws PermissionDeniedException;
 };
};

```

Router clients may only use `createSessionFromSecureConnection` if the router is configured with a proxy for an `SSLPermissionsVerifier` object. The implementation of `authorize` must return true to allow the client to establish a session. To reject the session, `authorize` must return false and may optionally provide a value for `reason`, which is returned to the client as a member of `PermissionDeniedException`. Starting with Ice 3.5, it can also throw `Glacier2::PermissionDeniedException`. Glacier2 forwards this exception as-is to the client, which means the verifier can raise a subclass of `PermissionDeniedException` in order to provide more information to the client.

The verifier examines the members of `SSLInfo` to authenticate a client:

### Slice

```

module Glacier2 {
 struct SSLInfo {
 string remoteHost;
 int remotePort;
 string localHost;
 int localPort;
 string cipher;
 Ice::StringSeq certs;
 };
};

```

The structure includes address information about the remote and local hosts, and a string that describes the ciphersuite negotiated for the SSL connection between the client and the router. These values are generally of interest for logging purposes, whereas the `certs` member supplies the information the verifier needs to make its decision. The client's certificate chain is represented as a sequence of strings that use the Privacy Enhanced Mail (PEM) encoding.

The first element of the sequence corresponds to the client's certificate, followed by its signing certificates. The certificate of the root Certificate Authority (CA) is the last element of the sequence. An empty sequence indicates that the client did not supply a certificate chain.

Although the certificate chain has already been validated by the SSL implementation, a verifier implementation typically needs to examine it in detail before making its decision. As a result, the verifier will need to convert the contents of `certs` into a more usable form. Some Ice platforms, such as Java and .NET, already provide certificate abstractions, and IceSSL supplies its own for C++ users. IceSSL for Java and .NET defines the method `IceSSL.Util.createCertificate`, which accepts a PEM-encoded string and returns an instance of the platform's certificate class. In C++, the class `IceSSL::Certificate` has a constructor that accepts a PEM-encoded string.

In addition to examining certificate attributes such as the distinguished name of the subject and issuer, it is also important that a verifier consider the [length of the certificate chain](#).

To install your verifier, set the `Glacier2.SSLPermissionsVerifier` property with the proxy of your verifier object.

In situations where authentication is not necessary, such as during development or when running in a trusted environment, you can use Glacier2's built-in "null" permissions verifier. This object accepts the credentials of any client, and you can enable it with the following property definition:

```
Glacier2.SSLPermissionsVerifier=Glacier2/NullSSLPermissionsVerifier
```

Note that the category of the object's identity (`Glacier2` in this example) must match the value of the property `Glacier2.InstanceName`.

## Interaction with a Permissions Verifier

The router attempts to contact the configured permissions verifiers at startup. If an object is unreachable, the router logs a warning message but continues its normal operation (you can suppress the warning using the `--nowarn` option.) The router does not contact a verifier again until it needs to invoke an operation on the object. For example, when a client asks the router to create a new session, the router makes another attempt to contact the verifier; if the object is still unavailable, the router logs a message and returns `PermissionDeniedException` to the client.

## Obtaining SSL Credentials for a Router Client

Servers that wish to receive information about a client's SSL connection to the router can define the `Glacier2.AddConnectionContext` property. When enabled, the router adds several entries to the request context of each invocation it forwards to a server, providing information such as the client's encoded certificate (if supplied) and addressing details. If the client's connection uses SSL, the router defines

the `_con.peerCert` entry in the context. A server can check for the presence of this entry and also extract additional context entries as shown below in this example:

```

C++

```

void unlockDoor(string id, const Ice::Current& curr)
{
    Ice::Context::const_iterator i = curr.ctx.find("_con.peerCert");
    if (i != curr.ctx.end()) {
        string certPEM;
        certPEM = i->second;
        cout << "Client address = "
             << curr.ctx["_con.remoteAddress"]
             << ":" << curr.ctx["_con.remotePort"] << endl;

        ...
    }
    ...
}

```

```

If the client supplied a certificate, the server can decode and examine it using the techniques discussed for `IceSSL`.

## Request Filtering

The Glacier2 router is capable of filtering requests based on a variety of criteria, which helps to ensure that clients do not gain access to unintended objects.

### Address Filters

To prevent a client from accessing arbitrary back-end hosts or ports, you can configure a Glacier2 router to validate the address information in each proxy that the client attempts to use. Two properties determine the router's filtering behavior:

- `Glacier2.Filter.Address.Accept`  
An address is accepted if it matches an entry in this property and does not match an entry in `Glacier2.Filter.Address.Reject`.
- `Glacier2.Filter.Address.Reject`  
An address is rejected if it matches an entry in this property.

The value of each property is a list of *address:port* pairs separated by spaces, as shown in the example below:

```
Glacier2.Filter.Address.Accept=192.168.1.5:4063 192.168.1.6:4063
```

This configuration allows clients to use only two hosts in the back-end network, and only one port on each host. A client that attempts to use a proxy containing any other host or port receives an `ObjectNotExistException` on its initial request.

You can also use ranges, groups and wildcards when defining your address filters. For example, the following property value shows how to use an address range:

```
Glacier2.Filter.Address.Accept=192.168.1.[5-6]:4063
```

This property is equivalent to the first example, but the range notation allows us to define the filter more concisely. Similarly, we can restate

the property using the group notation by separating values with a comma:

```
Glacier2.Filter.Address.Accept=192.168.1.[5,6]:4063
```

The wildcard notation uses the \* character to substitute for a value:

```
Glacier2.Filter.Address.Accept=10.0.*.1:4063
```

The range, group, and wildcard notation is also supported when specifying ports, as shown below:

```
Glacier2.Filter.Address.Accept=192.168.1.[5,6]:[10000-11000]
Glacier2.Filter.Address.Reject=192.168.1.[5,6]:[10500,10501]
```

In this configuration, the router allows clients to access all of the ports in the range 10000 to 11000, except for the two ports 10500 and 10501.

At first glance, you might think that the following property definition is pointless because it would prevent clients from accessing any back-end server:

```
Glacier2.Filter.Address.Reject=*
```

In reality, this configuration only prevents clients from accessing servers using direct proxies, that is, proxies that contain endpoints. As a result, the property causes Glacier2 to accept only [indirect proxies](#).



By default, a Glacier2 router forwards requests for any address, which is equivalent to defining the property `Glacier2.Filter.Address.Accept=*`.

## Category Filters

The `Ice::Identity` type contains two string members: `category` and `name`. You can configure a router with a list of valid identity categories, in which case it only routes requests for objects in those categories. The configuration property `Glacier2.Filter.Category.Accept` supplies the category list:

```
Glacier2.Filter.Category.Accept=cat1 cat2
```

This property does not affect the routing of [callback requests](#) from back-end servers to router clients.



By default a Glacier2 router forwards requests for any category.

If a category contains spaces, you can enclose the value in single or double quotes. If a category contains a quote character, it must be escaped with a leading backslash.

Glacier2 can optionally manipulate the category filter automatically. When you set `Glacier2.Filter.Category.AcceptUser` to a value of 1, the router adds the session's user name (for password authentication) or distinguished name (for SSL authentication) to the list of accepted categories. To ensure the uniqueness of your categories, you may prefer setting the property to a value of 2, which causes the router to prepend an underscore to the user name or distinguished name before adding it to the list.



A session manager can also configure category filters [dynamically](#) using Glacier2's `SessionControl` interface.

## Identity Filters

The ability to filter on identity categories, as described in the previous section, is a convenient way to limit clients to particular groups of objects. For even stricter control over the identities that clients are allowed to access, you can use the `Glacier2.Filter.Identity.Accept` property. The value of this property is a list of identities, separated by whitespace, representing the *only* objects the router's clients may use.

If an identity contains spaces, you can enclose the value in single or double quotes. If an identity contains a quote character, it must be escaped with a leading backslash.

Clearly, specifying a static list of identities is only practical for a small set of objects. Furthermore, in many applications, the complete set of identities cannot be known in advance, such as when objects are created on a per-session basis and use UUIDs in their identities. For these situations, category-based filtering is generally sufficient. However, a session manager can also use Glacier2's [dynamic filtering](#) interface, `SessionControl`, to manage the set of valid identities at run time.

## Adapter Filters

Applications often use `IceGrid` in their back-end network to simplify server administration and take advantage of the benefits offered by indirect proxies. Once you have configured Glacier2 with an appropriate [locator proxy](#), clients can use indirect proxies to refer to objects in IceGrid-managed servers. Indirect proxies come in two forms: one that contains only an identity, and one that contains an identity and an object adapter identifier. You can use the category and identity filters described in previous sections to control identity-only proxies, and you can use the property `Glacier2.Filter.AdapterId.Accept` to enforce restrictions on indirect proxies that use an object adapter identifier.

For example, the following property definition allows a client to use the proxy `factory@WidgetAdapter` but not the proxy `factory@SecretAdapter`:

```
Glacier2.Filter.AdapterId.Accept=WidgetAdapter
```

If an adapter identifier contains spaces, you can enclose the value in single or double quotes. If an adapter identifier contains a quote character, it must be escaped with a leading backslash.

A session manager can also configure this filter [dynamically](#) using Glacier2's `SessionControl` interface.

## Proxy Filters

The Glacier2 router maintains an internal routing table that contains an entry for each proxy used by a router client; the size of the routing table grows in proportion to the number of clients and their proxy usage. Furthermore, the amount of memory that the routing table consumes is affected by the number of endpoints in each proxy. Glacier2 provides two properties that you can use to limit the size of the routing table and defend against malicious router clients.

The property `Glacier2.RoutingTable.MaxSize` specifies the maximum number of entries allowed in the routing table. If the size of the table exceeds the value of this property, the router evicts older entries on a least-recently-used basis. (Eviction of proxies from the routing table is transparent to router clients.) The default size of the routing table is 1000, but you may need to define a different value depending on the needs of your application. While experimenting with different values, you may find it useful to define the property `Glacier2.Trace.RoutingTable` to see a log of the router's activities with respect to the routing table.

The property `Glacier2.Filter.ProxySizeMax` sets a limit on the size of a stringified proxy. The Ice run time places no limits on the size of proxy components such as identities and host names, but a malicious client could manufacture very large proxies in a denial-of-service attack on a Glacier2 router. By setting this property to a reasonably small value, you can prevent proxies from consuming excessive memory in the router process.

## Client Impact

The Glacier2 router immediately terminates a client's session if it attempts to use a proxy that is rejected by an address filter or exceeds the

size limit defined by the property `Glacier2.Filter.ProxySizeMax`. The Ice run time in the client responds by raising `ConnectionLostException` to the application.

For category, identity, and adapter identifier filters, the router raises `ObjectNotExistException` if any of the filters rejects a proxy and none of the filters accepts it.

To obtain more information on the router's reasons for terminating a session or rejecting a request, set the following property and examine the router's log output:

```
Glacier2.Client.Trace.Reject=1
```

## Glacier2 Routing Table

The Glacier2 router maintains an internal routing table for each session. The routing table holds every proxy used by its session. Consequently, the size of the routing table grows in proportion to the number of proxies used by a session. Furthermore, the amount of memory that all of the routing tables consume grows with the number of active sessions.

The property `Glacier2.RoutingTable.MaxSize` allows you to specify an upper limit on the number of entries in the routing table. If the size of the table exceeds the value of this property, the router evicts older entries on a least-recently-used basis. (Eviction of proxies from the routing table is transparent to router clients.) The default size of the routing table is 1000, but you may need to define a different value depending on the needs of your application. While experimenting with different values, you may find it useful to define the property `Glacier2.Trace.RoutingTable` to see a log of the router's activities with respect to the routing table.

The router does not remove entries from a session's routing table except when evicting an old entry to make room for a new one. In particular, an exception that occurs while routing a request for a proxy does *not* cause that proxy to be removed from the routing table. Note however that the routing table is destroyed upon session destruction.

## Glacier2 Administrative Interface

Glacier2 supports an administrative interface that allows you to shut down a router programmatically:

```

Slice
module Glacier2 {
 interface Admin {
 idempotent void shutdown();
 };
};
```

To prevent unwanted clients from using the `Admin` interface, the object is only accessible on the endpoints defined by the `Glacier2.Admin.Endpoints` property. This property has no default value, meaning you must define the property in order to make the `Admin` object accessible.

If you decide to define `Glacier2.Admin.Endpoints`, choose your endpoints carefully. We generally recommend the use of endpoints that are accessible only from behind a firewall.

### See Also

- [Glacier2 Properties](#)
- [IceSSL](#)
- [Getting Started with Glacier2](#)
- [Callbacks through Glacier2](#)
- [Dynamic Request Filtering with Glacier2](#)
- [IceGrid and Glacier2 Integration](#)



## Glacier2 Session Management

A Glacier2 router requires a client to [create a session](#) and forwards requests on behalf of the client until its session expires. A session expires when it is explicitly destroyed, or when it times out due to inactivity.

You can configure a router to use a custom session manager if your application needs to track the router's session activities. For example, your application may need to acquire resources and initialize the state of back-end services for each new session, and later reclaim those resources when the session expires.

As with the [authentication facility](#), Glacier2 provides two session manager interfaces that an application can implement. The `SessionManager` interface receives notifications about sessions that use password authentication, while the `SSLSessionManager` interface is for sessions authenticated using SSL certificates.

On this page:

- [Glacier2 Session Manager Interfaces](#)
- [Glacier2 Session Timeouts](#)
- [Invocation Timeouts on Routed Proxies](#)
- [Connection Caching for Session Managers](#)

## Glacier2 Session Manager Interfaces

The relevant Slice definitions are shown below:

Slice
<pre> module Glacier2 {     exception CannotCreateSessionException {         string reason;     };      interface Session {         void destroy();     };      interface SessionManager {         Session* create(string userId, SessionControl* control)             throws CannotCreateSessionException;     };      interface SSLSessionManager {         Session* create(SSLInfo info, SessionControl* control)             throws CannotCreateSessionException;     }; }; </pre>

When a client [creates a session](#) by invoking `createSession` on the `Router` interface, the router validates the client's user name and password and then calls `SessionManager::create`. Similarly, a call to `createSessionFromSecureConnection` causes the router to invoke `SSLSessionManager::create`. The `SSLInfo` structure provides details about the client's SSL connection. The second argument to the `create` operations is a proxy for a `SessionControl` object, which a session can use to perform [dynamic filtering](#).

The `create` operations must return the proxy of a new `Session` object, or raise `CannotCreateSessionException` and provide an appropriate reason. The `Session` proxy returned by `create` is ultimately returned to the client as the result of `createSession` or `createSessionFromSecureConnection`.

Glacier2 invokes the `destroy` operation on a `Session` proxy when the session expires, giving a custom session manager the opportunity to reclaim resources that were acquired for the session during `create`.

 The `create` operations may be called with information that identifies an existing session. For example, this can occur when a client loses its connection to the router but its previous session has not yet expired (and therefore the router has not yet invoked `destroy` on its `Session` proxy). A session manager implementation must be prepared to handle this situation.

To configure the router with a custom session manager, define the properties `Glacier2.SessionManager` or `Glacier2.SSLSessionManager` with the proxies of the session manager objects. If necessary, you can configure a router with proxies for both types of session managers. If a session manager proxy is not supplied, the call to `createSession` or `createSessionFromSecureConnection` always returns a null proxy.

The router attempts to contact the configured session manager at startup. If the object is unreachable, the router logs a warning message but continues its normal operation (you can suppress the warning using the `--nowarn` option). The router does not contact the session manager again until it needs to invoke an operation on the object. For example, when a client asks the router to create a new session, the router makes another attempt to contact the session manager; if the session manager is still unavailable, the router logs a message and returns `CannotCreateSessionException` to the client.

 **Example**  
A sample implementation of the `SessionManager` interface is provided in the `demo/Glacier2/callback` directory.

## Glacier2 Session Timeouts

The value of the `Glacier2.SessionTimeout` property specifies the number of seconds a session must be inactive before it expires. This property is not defined by default, which means sessions never expire due to inactivity. If a non-zero value is specified, it is very important that the application chooses a value that does not result in premature session expiration. For example, if it is normal for a client to create a session and then have long periods of inactivity, then a suitably long timeout must be chosen, or the client must actively keep its session alive, or timeouts must be disabled altogether.

Once a session has expired (or been destroyed for some other reason), the client will no longer be able to send requests via the router and receive a `ConnectionLostException` instead. The client must explicitly create a new session in order to continue using the router. If necessary, a client can use a [dedicated thread](#) to keep its session alive.

In general, we recommend the use of an appropriate session timeout, otherwise resources created for each session will accumulate in the router. However, you can safely disable the session timeout if the server regularly [calls back](#) to the client. In that case, Glacier2 will automatically destroy the session if a failure occurs while forwarding a server callback to the client.

## Invocation Timeouts on Routed Proxies

If your client requires invocation timeouts for routed proxies, you must set the timeout on the router proxy that you use to establish the session. This is because the Ice run time forwards the invocation to Glacier2, and the timeout applies to that invocation.

In other words, whatever timeout you set on the router proxy that you use to create the session is the timeout that applies to all routed proxies. Do not attempt to override the timeout on a per-proxy basis; if you do, any setting other than the timeout used to establish the session results in a `ConnectionLostException`. This is because proxies with different timeout values establish separate connections, but there can be only one connection to Glacier2.

 A future version of Ice may make it illegal to set a timeout on a routed proxy.

For invocations made by Glacier2 to the server, whatever timeout value is set on the *first* proxy that is used to make an invocation applies to all proxies for the same object. This is because Glacier2 adds the proxy to its routing table during the first invocation and, thereafter, reuses that cached proxy for all invocations to the same object identity. Here is an example to illustrate this:

**C++**

```
// 10-second session timeout for router.
ObjectPrx router = communicator->stringToProxy("Glacier2/router:tcp -h
host1 -p 4063 -t 10000");
communicator->setDefaultRouter(RouterPrx::uncheckedCast(router));

// Ping with 20-second timeout
communicator->stringToProxy("id:tcp -h host2 -p 12345 -t
20000")->ice_ping();

// Ping with 30-second timeout
communicator->stringToProxy("id:tcp -h host2 -p 12345 -t
30000")->ice_ping();
```

In this case, all invocations made by the client use a 10-second timeout to forward the invocations to Glacier2. The first call to `ice_ping`, when forwarded by Glacier2 to the server, uses a 20-second timeout. The second call to `ice_ping` also uses a 20-second timeout, even though the proxy specifies a 30-second timeout.

If you have a timeout on both the client-Glacier2 and the Glacier2-server connections, the timeout on the client-Glacier2 connection should be slightly longer; otherwise, invocation timeouts that are encountered by Glacier2 when it forwards an operation to the server cannot be propagated back to the client.

## Connection Caching for Session Managers

You can distribute the load among multiple session manager objects by configuring the router with a session manager proxy that contains multiple endpoints. Glacier2 disables [connection caching](#) on this proxy so that each invocation on a session manager attempts to use a different endpoint.

This behavior achieves a basic form of load balancing without depending on the [replication](#) features provided by IceGrid. Be aware that including an invalid endpoint in your session manager proxy, such as the endpoint of a session manager server that is not currently running, can cause router clients to experience delays during session creation.

If your session managers are in an IceGrid replica group, refer to [IceGrid and Glacier2 Integration](#) for more information on the router's caching behavior.

### See Also

- [Getting Started with Glacier2](#)
- [Securing a Glacier2 Router](#)
- [Dynamic Request Filtering with Glacier2](#)
- [IceGrid and Glacier2 Integration](#)
- [Object Adapter Replication](#)
- [Glacier2 Properties](#)

## Dynamic Request Filtering with Glacier2

Glacier2 can be [statically configured](#) to filter requests, and also allows a session manager to customize filters for each session at run time via its `SessionControl` interface:

Slice
<pre> module Glacier2 {     interface SessionControl {         StringSet* categories();         StringSet* adapterIds();         IdentitySet* identities();         void destroy();     }; }; </pre>

The router creates a `SessionControl` object for each client session and supplies a proxy for the object to the session manager `create` operations. Note that the `SessionControl` proxy is null unless the router is [configured with server endpoints](#).

Invoking the `destroy` operation causes the router to destroy the client's session, which eventually results in an invocation of `destroy` on the application-defined `Session` object, if one was provided.

The interface operations `categories`, `adapterIds`, and `identities` return proxies to objects representing the modifiable filters for the session. The router initializes these filters using their respective static configuration properties.

The `SessionControl` object uses a `StringSet` to manage the category and adapter identifier filters:

Slice
<pre> module Glacier2 {     interface StringSet {         idempotent void add(Ice::StringSeq additions);         idempotent void remove(Ice::StringSeq deletions);         idempotent Ice::StringSeq get();     }; }; </pre>

Similarly, the `IdentitySet` interface manages the identity filters:

Slice
<pre> module Glacier2 {     interface IdentitySet {         idempotent void add(Ice::IdentitySeq additions);         idempotent void remove(Ice::IdentitySeq deletions);         idempotent Ice::IdentitySeq get();     }; }; </pre>

In both interfaces, the `add` operation silently ignores duplicates, and the `remove` operation silently ignores non-existent entries.

Dynamic filtering is often necessary when each session must be restricted to a particular group of objects. Upon session creation, a session manager typically allocates a number of objects in back-end servers for that session to use. To prevent other sessions from accessing these objects (intentionally or not), the session manager can configure the session's filters so that it is only permitted to use the objects that were created for it.

For example, a session manager can retain the `SessionControl` proxy and add a new identity to the `IdentitySet` as each new object is created for the session. A simpler solution is to create a unique category for the session, add it to the session's category filter, and use that category in the identities of all objects accessible to that session. Using a category filter in this way reserves an identity namespace for each session and avoids the need to update the filter for each new object.

To aid in logging and debugging, you can select a category that identifies the client, such as the user name that was supplied during session creation, or an attribute of the client's certificate such as the common name, as long as the selected category is sufficiently unique that it will not conflict with another client's session. You must also ensure that the categories you assign to sessions never match the categories of back-end objects that are not meant to be accessed by router clients. As an example, consider the following session manager implementation:

```

C++

class SessionManagerI : public Glacier2::SessionManager
{
public:

 virtual Glacier2::SessionPrx
 create(const string& username, const Glacier2::SessionControlPrx&
 ctrl,
 const Ice::Current& curr)
 {
 string category = "_" + username;
 ctrl->categories()->add(category);
 // ...
 }
};
```

This session manager derives a category for the session by prepending an underscore to the user name and then adds this category to the session's filter. As long as our back-end objects do not use a leading underscore in their identity categories, this strategy guarantees that a session's category can never match the category of a back-end object.

For your convenience, Glacier2 already includes support for [automatic category filtering](#).

#### See Also

- [Callbacks through Glacier2](#)
- [Securing a Glacier2 Router](#)
- [Glacier2 Session Management](#)



## Glacier2 Request Buffering

A Glacier2 router can forward requests in buffered or unbuffered mode. In addition, the buffering mode can be set independently for each direction (client-to-server and server-to-client).

The configuration properties `Glacier2.Client.Buffered` and `Glacier2.Server.Buffered` govern the buffering behavior. The former affects buffering of requests from clients to servers, and the latter affects buffering of requests from servers to clients. If a property is not specified, the default value is 1, which enables buffering. A property value of 0 selects the unbuffered mode.

The primary difference between the two modes is in the way requests are forwarded:

- **Buffered**  
The router queues incoming requests and outgoing replies for delivery in a separate thread.
- **Unbuffered**  
The router forwards requests in the same thread that received the request.

Although unbuffered mode consumes fewer resources than buffered mode, certain features such as [request overriding](#) and [request batching](#) are available only in buffered mode.

### See Also

- [How Glacier2 uses Request Contexts](#)

## How Glacier2 uses Request Contexts

The Glacier2 router examines the [context](#) of an incoming request for special keys that affect how the router forwards the request. These contexts have the same semantics regardless of whether the request is sent from client to server or from server to client.

On this page:

- [The `\_fwd` Context](#)
- [The `\_ovrd` Context](#)
- [Forwarding Batch Requests](#)
- [Context Forwarding](#)

### The `_fwd` Context

The `_fwd` context determines the proxy mode that the router uses when forwarding the request. The value associated with the `_fwd` key must be a string containing one or more of the characters shown in the following table:

Value	Mode
d	datagram
D	Batch datagram
o	Oneway
O	Batch oneway
s	Secure
t	Twoway
z	Compress

*Legal values for the `_fwd` context key.*

These characters match the corresponding [stringified proxy options](#).

For requests whose `_fwd` context specify a batch mode, the forwarding behavior of the router depends on whether it is [batching requests](#).

If the `_fwd` key is not present in a request context, the mode used by the router to forward that request depends on the mode used by the client's proxy as well as the router's own configuration:

- If the client used twoway mode, the router also uses twoway mode.
- If the client sent the request as a oneway or batch oneway, the router's behavior is determined by its [configuration properties](#).

### The `_ovrd` Context

In buffered mode, the router allows a new incoming request to override any pending requests that are still in the router's queue, effectively replacing any pending requests with the new request.

For a new request to override a pending request, both requests must meet the following criteria:

- they specify the `_ovrd` key in the request context with the same value
- they are oneway requests
- they are requests on the same object.

This feature is intended to be used by clients that are sending frequent oneway requests in which the most recent request takes precedence. This feature minimizes the number of requests that are forwarded to the server when requests are sent frequently enough that they accumulate in the router's queue before the router has a chance to process them.

Note that the properties `Glacier2.Client.SleepTime` and `Glacier2.Server.SleepTime` can be used to add a delay to the router once it has sent all pending requests. Setting a delay increases the likelihood of overrides actually taking effect. These properties are described in the next section.

## Forwarding Batch Requests

Clients can direct the router to forward oneway requests in batches by including the `D` or `O` characters in the `_fwd` context. If the router is configured for buffered mode and several such requests accumulate in its queue, the router forwards them together in a `batch` rather than as individual requests.

In addition, the properties `Glacier2.Client.AlwaysBatch` and `Glacier2.Server.AlwaysBatch` determine whether oneway requests are always batched regardless of the `_fwd` context. The former property affects requests from clients to servers, while the latter affects requests from servers to clients. If a property is defined with a non-zero value, then all requests whose `_fwd` context includes the `o` character or were sent as oneway invocations are treated as if `O` were specified instead, and are batched when possible. Likewise, requests whose `_fwd` context includes the `d` character or were sent as datagram invocations are treated as if `D` were specified. If a property is not defined, the router only batches requests if specifically directed to do so by the `_fwd` context.

The configuration properties `Glacier2.Client.SleepTime` and `Glacier2.Server.SleepTime` can be used to force the router's delivery threads to sleep for the specified number of milliseconds after the router has sent all of its pending requests. (Incoming requests are queued during this period.) The delay is useful to increase the effectiveness of batching because it makes it more likely for additional requests to accumulate in a batch before the batch is sent. If these properties are not defined, or their value is zero, the corresponding thread does not sleep after sending queued requests.

## Context Forwarding

The configuration properties `Glacier2.Client.ForwardContext` and `Glacier2.Server.ForwardContext` determine whether the router includes the context when forwarding a request. The former property affects requests from clients to servers, while the latter affects requests from servers to clients. If a property is not defined or has the value zero, the router does not include the context when forwarding requests.

### See Also

- [Request Contexts](#)
- [Proxy and Endpoint Syntax](#)
- [Batched Invocations](#)
- [Glacier2 Properties](#)

## Configuring Glacier2 behind an External Firewall

The Glacier2 router requires only one external port to receive connections from clients and therefore can easily coexist with a network firewall device.

For example, consider the network shown in the following illustration:

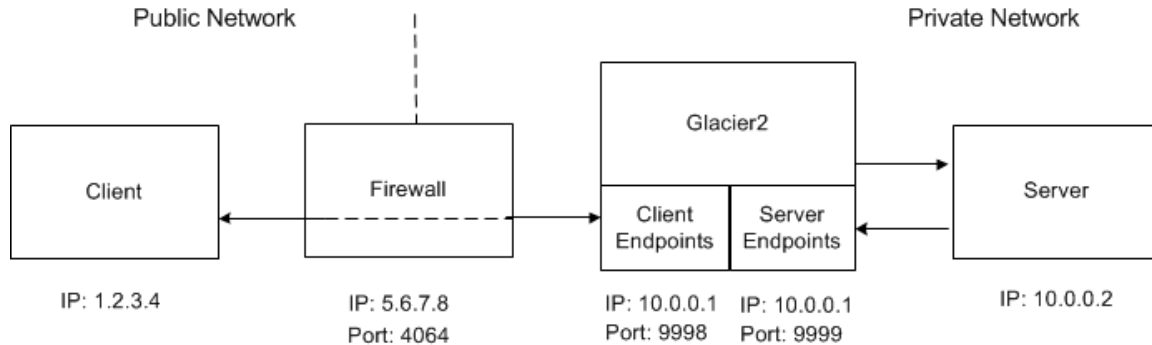

The Glacier2 router in the example above has both of its endpoints in the private network and its host requires only one IP address, unlike the example we showed in the discussion of [bidirectional connections](#) in which the Glacier2 host straddled both networks.

We assume that the firewall has been configured to forward connections from port 4064 to the router's client endpoint at port 9998. Meanwhile, the client must be configured to use the firewall's address information in its router proxy, as shown below:

```
Ice.Default.Router=Glacier2/router:ssl -h 5.6.7.8 -p 4064
```

The Glacier2 router configuration for this example requires the following properties:

```
Glacier2.Client.Endpoints=ssl -h 10.0.0.1 -p 9998
Glacier2.Client.PublishedEndpoints=ssl -h 5.6.7.8 -p 4064
Glacier2.Server.Endpoints=tcp -h 10.0.0.1 -p 9999
```

We need to specify [published endpoints](#) for the client object adapter because the router is located behind a firewall. Without this property, any proxies that the router creates would use the endpoints specified in `Glacier2.Client.Endpoints`, but of course those endpoints are inaccessible to clients outside the firewall. The `PublishedEndpoints` property forces the Ice run time to use the given endpoints in proxies created by the client object adapter.

Note also that the server endpoint in this example includes a fixed port (9999), but a fixed port is not required in the server endpoint for the router to operate properly.

### See Also

- [Callbacks through Glacier2](#)
- [Object Adapter Endpoints](#)
- [Glacier2 Properties](#)

## Advanced Glacier2 Client Configurations

This section details strategies that Glacier2 clients can use to address more advanced requirements.

On this page:

- [Callback Strategies with Multiple Object Adapters](#)
- [Using Multiple Routers](#)

### Callback Strategies with Multiple Object Adapters

An application that needs to support callback requests from a router as well as requests from local clients should use multiple object adapters to ensure that proxies created by these object adapters contain the appropriate endpoints. For example, suppose we have the network configuration as shown in the following illustration:

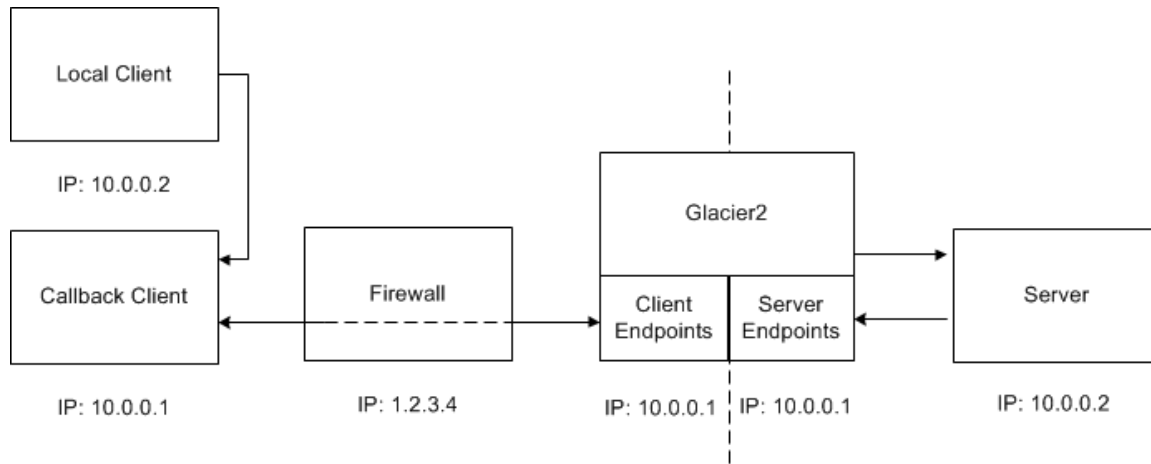

Notice that the two local area networks use the same private network addresses, which is not an unrealistic scenario.

Now, if the callback client were to use a single object adapter for handling both callback requests and local requests, then any proxies created by that object adapter would contain the application's local endpoints as well as the router's server endpoints. As you might imagine, this could cause some subtle problems.

1. When the local client attempts to establish a connection to the callback client via one of these proxies, it might arbitrarily select one of the router's server endpoints to try first. Since the router's server endpoints use addresses in the same network, the local client attempts to make a connection over the local network, with two possible outcomes: the connection attempts to those endpoints fail, in which case they are skipped and the real local endpoints are attempted; or, even worse, one of the endpoints might accidentally be valid in the local network, in which case the local client has just connected to some unintended server.
2. The server may encounter similar problems when attempting to establish a local connection to the router in order to make a callback request.

The solution is to dedicate an object adapter solely to handling callback requests, and another one for servicing local clients. The object adapter dedicated to callback requests must be [configured with the router proxy](#).

### Using Multiple Routers

A client is not limited to using only one router at a time: the [proxy method](#) `ice_router` allows a client to configure its routed proxies as necessary. With respect to callbacks, a client must create a new callback object adapter for each router that can forward callback requests to the client. A client must also be aware of the [object identities](#) in use by the routers.

#### See Also

- [Getting Started with Glacier2](#)
- [Callbacks through Glacier2](#)
- [Proxy Methods](#)



## IceGrid and Glacier2 Integration

IceGrid is a server activation and location service. This section describes the ways in which you can integrate Glacier2 and IceGrid.

On this page:

- [Configuring Router Clients for IceGrid](#)
- [Using Replicated Session Managers](#)

### Configuring Router Clients for IceGrid

It is not uncommon for a Glacier2 client to require access to a locator service such as IceGrid. In the absence of Glacier2, a locator client would typically define the property `Ice.Default.Locator` with a stringified proxy for the `locator` service. However, when that locator service is accessed via a Glacier2 router, the configuration requirements are slightly different. It is no longer necessary for the client's configuration to include `Ice.Default.Locator`; this property must be defined in the router's configuration instead.

For example, consider the following network architecture:

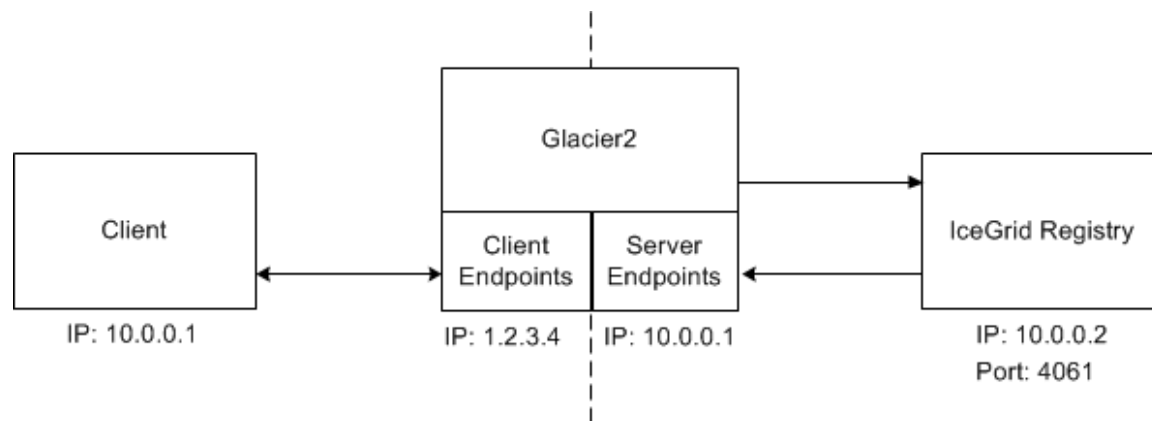

In this case the Glacier2 router's configuration must include the property shown below:

```
Ice.Default.Locator=IceGrid/Locator:tcp -h 10.0.0.2 -p 4061
```

### Using Replicated Session Managers

An IceGrid application might want to use [replication](#) to increase the availability of Glacier2 session managers. When you configure an indirect proxy for a session manager (and [configure Glacier2 with a locator proxy](#)), the Ice run time in the router queries the locator to obtain a proxy for a session manager replica.

By default, this proxy is cached for 10 minutes, meaning the router uses the same session manager proxy to create sessions for a 10-minute period, after which it queries the locator again. If you want to distribute the session-creation load among the session manager replicas more evenly, you can decrease the locator cache timeout using configuration properties.

For example, the following settings use a timeout of 30 seconds:

```
Glacier2.SessionManager.LocatorCacheTimeout=30
Glacier2.SSLSessionManager.LocatorCacheTimeout=30
```

As you can see, timeouts are specified individually for the `SessionManager` and `SSLSessionManager` proxies. You can also disable caching completely by using a value of 0, in which case the router queries the locator before every invocation on a session manager. See

the discussion of [session management](#) for more details.

**See Also**

- [IceGrid](#)
- [Glacier2 Session Management](#)
- [Getting Started with IceGrid](#)
- [Object Adapter Replication](#)



## Glacier2 Metrics

You can monitor Glacier2 using the [Administrative Facility](#) and the [Metrics Facet](#). Glacier2 provides a metrics class to monitor session related metrics. The Glacier2 session metrics class is defined in `Glacier2/Metrics.ice` and is shown below.

Slice
<pre> namespace IceMX { class SessionMetrics extends Metrics {     int forwardedClient = 0;     int forwardedServer = 0;     int routingTableSize = 0;     int queuedClient = 0;     int queuedServer = 0;     int overriddenClient = 0;     int overriddenServer = 0; }; }; </pre>

Glacier2 records session metrics in the `Session` metrics map, the metrics objects contained in this map are instances of the `IceMX::SessionMetrics` class show above. To configure a metrics view to record Glacier2 session metrics you can use [metrics properties](#) with the `IceMX.Metrics.view-name.Map.Session` prefix, for example:

- `IceMX.Metrics.SessionView.Map.Session.GroupBy=id` to configure a view containing one metrics object per session.
- `IceMX.Metrics.SessionView.Map.Session.GroupBy=none` to configure a view containing a single metrics object with metrics for all the sessions.

You can use the following attributes when configuring the Glacier2 Session metrics map:

Name	Description
id	A unique identifier to identify the session. This corresponds to the user Id for sessions created with a username/password and to the subject DN for sessions created from SSL.
parent	The Glacier2 router instance name.
none	The empty string.
endpoint	The stringified endpoint.
endpointType	The endpoint numerical type as defined in <code>Ice/Endpoint.ice</code> .
endpointIsDatagram	A boolean indicating if the endpoint is a datagram endpoint.
endpointIsSecure	A boolean indicating if the endpoint is secure.
endpointTimeout	The endpoint timeout.
endpointCompress	A boolean indicating if the endpoint requires compression.
endpointHost	The endpoint host.
endpointPort	The endpoint port.
connection	The connection description.

incoming	A boolean indicating if the connection is a server or client connection.
adapterName	If the connection is a server connection, adapterName will return the name of the adapter which created the connection, it will contain the empty string otherwise.
connectionId	The ID of the connection if one is set, the empty string otherwise.
localAddress	The connection's local address.
localPort	The connection's local port.
remoteAddress	The connection's remote address.
remotePort	The connection's remote port.
mcastAddress	The connection's multicast address.
mcastPort	The connection's multicast port.
state	The state of the connection.

The connection and endpoint attributes are for the connection tied to the Glacier2 session.

## See Also

- [Administrative Facility](#)
- [The Metrics Facet](#)
- [IceMX Metrics Properties](#)

# IceBox

IceBox is an easy-to-use framework for Ice application services. The Service Configurator pattern [1] is a useful technique for configuring services and centralizing their administration. In practical terms, this means services are developed as dynamically-loadable components that can be configured into a general purpose "super server" in whatever combinations are necessary. IceBox is an implementation of the Service Configurator pattern for Ice services.

A generic IceBox server replaces the typical monolithic Ice server you normally write. The IceBox server is configured via properties with the application-specific services it is responsible for loading and managing, and it can be administered remotely. There are several advantages in using this architecture:

- Services loaded by the same IceBox server can be configured to take advantage of Ice's [collocation optimizations](#). For example, if one service is a client of another service, and those services reside in the same IceBox server, then invocations between them can be optimized.
- Composing an application consisting of various services is done by configuration, not by compiling and linking. This decouples the service from the server, allowing services to be combined or separated as needed.
- Multiple Java services can be active in a single instance of a Java Virtual Machine (JVM). This conserves operating system resources when compared to running several monolithic servers, each in its own JVM.
- Services implement an IceBox service interface, providing a common framework for developers and a centralized administrative facility.
- IceBox support is [integrated into IceGrid](#), the server activation and deployment service.

IceBox offers a refreshing change of perspective: developers focus on writing services, not applications. The definition of an application changes as well; using IceBox, an application becomes a collection of discrete services whose composition is determined dynamically by configuration, rather than statically by the linker.

## Topics

- [Developing IceBox Services](#)
- [Configuring IceBox Services](#)
- [Starting the IceBox Server](#)
- [IceBox Administration](#)

## References

1. Jain, P., et al. 1997. [Dynamically Configuring Communication Services with the Service Configurator Pattern](#). C++ Report 9 (6).

## Developing IceBox Services

On this page:

- [The IceBox Service Interface](#)
- [IceBox Service Example in C++](#)
  - [C++ Service Entry Point](#)
- [IceBox Service Example in Java](#)
- [IceBox Service Example in C#](#)
- [IceBox Service Failures](#)

### The IceBox Service Interface

Writing an IceBox service requires implementing the `IceBox Service` interface:

Slice
<pre> module IceBox {   local interface Service {     void start(string name, Ice::Communicator communicator, Ice::StringSeq args);     void stop();   }; }; </pre>

As you can see, a service needs to implement only two operations, `start` and `stop`. These operations are invoked by the server; `start` is called after the service is loaded, and `stop` is called when the IceBox server is shutting down.

The `start` operation is the service's opportunity to initialize itself; this typically includes creating an object adapter and servants. The `name` and `args` parameters supply information from the service's [configuration](#), and the `communicator` parameter is an `Ice::Communicator` object created by the server for use by the service. Depending on the service configuration, this communicator instance may be [shared by other services](#) in the same IceBox server, therefore care should be taken to ensure that items such as object adapters are given unique names.

The `stop` operation must reclaim any resources used by the service. Generally, a service deactivates its object adapter, and may also need to invoke `waitForDeactivate` on the object adapter in order to ensure that all pending requests have been completed before the clean up process can proceed. The server is responsible for destroying the communicator instance that was passed to `start`.

Whether the service's implementation of `stop` should explicitly destroy its object adapter depends on other factors. For example, the adapter should be destroyed if the service uses a shared communicator, especially if the service could eventually be restarted. In other circumstances, the service can allow its adapter to be destroyed as part of the communicator's destruction.

These interfaces are declared as `local` for a reason: they represent a contract between the server and the service, and are not intended to be used by remote clients. Any interaction the service has with remote clients is done via servants created by the service.

### IceBox Service Example in C++

The example we present here is taken from the `IceBox/hello` sample program provided in the Ice distribution.

The class definition for our service is quite straightforward, but there are a few aspects worth mentioning:

**C++**

```
#include <IceBox/IceBox.h>

#if defined(_WIN32)
define HELLO_API __declspec(dllexport)
#else
define HELLO_API /**/
#endif

class HELLO_API HelloServiceI : public IceBox::Service {
public:
 virtual void start(const std::string&,
 const Ice::CommunicatorPtr&,
 const Ice::StringSeq&);
 virtual void stop();

private:
 Ice::ObjectAdapterPtr _adapter;
};
```

First, we include the `IceBox` header file so that we can derive our implementation from `IceBox::Service`. Second, the preprocessor definitions are necessary because, on Windows, this service resides in a Dynamic Link Library (DLL), therefore we need to export the class so that the server can load it properly.

The member definitions are equally straightforward:

**C++**

```

#include <Ice/Ice.h>
#include <HelloServiceI.h>
#include <HelloI.h>

using namespace std;

void
HelloServiceI::start(
 const string& name,
 const Ice::CommunicatorPtr& communicator,
 const Ice::StringSeq& args)
{
 _adapter = communicator->createObjectAdapter(name);
 Ice::ObjectPtr object = new HelloI(communicator);
 _adapter->add(object, communicator->stringToIdentity("hello"));
 _adapter->activate();
}

void
HelloServiceI::stop()
{
 _adapter->deactivate();
}

```

The `start` method creates an object adapter with the same name as the service, activates a single servant of type `HelloI` (not shown), and activates the object adapter. The `stop` method simply deactivates the object adapter.

**C++ Service Entry Point**

The last piece of the puzzle is the *entry point* function, which the IceBox server calls to obtain an instance of the service:

**C++**

```

extern "C" {
 HELLO_API IceBox::Service*
 create(Ice::CommunicatorPtr communicator)
 {
 return new HelloServiceI;
 }
}

```

In this example, the `create` function returns a new instance of the `Hello` service. The name of the function is not important, but it must have the signature shown above. In particular, the function must have C linkage, accept a single parameter of type `Ice::CommunicatorPtr`, and return a native pointer to `IceBox::Service`.

C linkage is required so that the IceBox server can locate this function in a dynamically-loaded library. The restrictions imposed on functions with C linkage prevent us from using the normal Ice calling conventions, which never return native pointers and always pass smart pointers

by const reference. For example, such a function cannot return an object type (such as a smart pointer), which forces us to return a native pointer instead.

[Configuring IceBox Services](#) provides more information on entry points and describes how to configure your service into an IceBox server.

## IceBox Service Example in Java

As with the C++ example presented in the previous section, the complete source for the Java example can be found in the `IceBox/hello` directory of the Ice distribution. The class definition for our service looks as follows:

```

Java

public class HelloServiceI implements IceBox.Service
{
 public void
 start(String name, Ice.Communicator communicator, String[] args)
 {
 _adapter = communicator.createObjectAdapter(name);
 Ice.Object object = new HelloI(communicator);
 _adapter.add(object, communicator.stringToIdentity("hello"));
 _adapter.activate();
 }

 public void
 stop()
 {
 _adapter.deactivate();
 }

 private Ice.ObjectAdapter _adapter;
}

```

The `start` method creates an object adapter with the same name as the service, activates a single servant of type `HelloI` (not shown), and activates the object adapter. The `stop` method simply deactivates the object adapter.

The server requires a service implementation to have a default constructor. This is the *entry point* for a Java IceBox service; that is, the server dynamically loads the service implementation class and invokes the default constructor to obtain an instance of the service.

This example is a trivial service, and yours will likely be much more interesting, but this does demonstrate how easy it is to write an IceBox service. After compiling the service implementation class, it can be configured into an IceBox server as described in [Configuring IceBox Services](#).

## IceBox Service Example in C#

The complete source for the C# example can be found in the `IceBox/hello` directory of the Ice distribution. The class definition for our service looks as follows:

**C#**

```

class HelloServiceI : IceBox.Service
{
 public void
 start(string name, Ice.Communicator communicator, string[] args)
 {
 _adapter = communicator.createObjectAdapter(name);
 _adapter.add(new HelloI(),
communicator.stringToIdentity("hello"));
 _adapter.activate();
 }

 public void
 stop()
 {
 _adapter.deactivate();
 }

 private Ice.ObjectAdapter _adapter;
}

```

The `start` method creates an object adapter with the same name as the service, activates a single servant of type `HelloI` (not shown), and activates the object adapter. The `stop` method simply deactivates the object adapter.

The server requires a service implementation to have a default constructor. This is the entry point for a C# IceBox service; that is, the server dynamically loads the service implementation class from an assembly and invokes the default constructor to obtain an instance of the service.

This example is a trivial service, and yours will likely be much more interesting, but this does demonstrate how easy it is to write an IceBox service. After compiling the service implementation class, it can be configured into an IceBox server as described in [Configuring IceBox Services](#).

## IceBox Service Failures

An exception raised by a service's implementation of its entry point, `start`, or `stop` methods causes IceBox to log a message. An exception that occurs during server startup also results in [server termination](#).

A service implementation can indicate a failure by raising `IceBox::FailureException`:

**Slice**

```

module IceBox {
 local exception FailureException {
 string reason;
 };
};

```

Note that, as a local exception, C++ users must instantiate `FailureException` with file and line number information:



### C++

```
throw IceBox::FailureException(__FILE__, __LINE__, "my error message");
```

#### See Also

- [Configuring IceBox Services](#)
- [Starting the IceBox Server](#)

## Configuring IceBox Services

On this page:

- [Installing an IceBox Service](#)
- [IceBox Service Configuration in C++](#)
- [IceBox Service Configuration in Java](#)
- [IceBox Service Configuration in C#](#)
- [Using a Shared Communicator](#)
- [Inheriting Properties from the IceBox Server](#)
- [Load Order for IceBox Services](#)
- [Logging Considerations for IceBox Services](#)

### Installing an IceBox Service

A service is configured into an IceBox server using a single `IceBox.Service` property. This property serves several purposes: it defines the name of the service, it provides the server with the service entry point, and it defines properties and arguments for the service.

The format of the property is shown below:

```
IceBox.Service.name=entry_point [args]
```

The *name* component of the property key is the service name (IceStorm, in this example). This name is passed to the service's `start` operation, and must be unique among all services configured in the same IceBox server. It is possible, though rarely necessary, to load two or more instances of the same service under different names.

The first argument in the property value is the entry point specification. Any arguments following the entry point specification are examined. If an argument has the form `--name=value`, then it is interpreted as a property definition that appears in the property set of the communicator passed to the service `start` operation. These arguments are removed, and any remaining arguments are passed to the `start` operation in the `args` parameter.

### IceBox Service Configuration in C++

For a C++ service, the [entry point](#) must have the form `library[,version]:symbol`, where *library* is the simple name of the service's shared library or DLL, and *symbol* is the name of the entry point function. A "simple name" is one without any platform-specific prefixes or extensions; the server adds appropriate decorations depending on the platform. The simple name may include a leading path, and the version is optional. If specified, the version is embedded in the library name.

As an example, here is how we could configure `IceStorm`, which is implemented as an IceBox service in C++:

```
IceBox.Service.IceStorm=IceStormService,35b:createIceStorm
```

IceBox uses the information provided in the entry point specification to compose a library name. For the `IceStorm` example shown above, IceBox on Windows would compose the library name `IceStormService35b.dll`. If IceBox is compiled with debug information, it appends a `d` to the library name, so the name becomes `IceStormService35bd.dll` instead.



The exact name of the library that is loaded depends on the naming conventions of the platform IceBox executes on. For example, on an OS X machine, the library name is `libIceStormService35b.dylib`.

If the simple name does not include a leading path, the shared library or DLL must reside in a directory that appears in `PATH` on Windows or the shared library search path (such as `LD_LIBRARY_PATH`) on POSIX systems.

The entry point function, *symbol*, must have the signature that we originally presented in our [example](#):

**C++**

```
extern "C" IceBox::Service* function(Ice::CommunicatorPtr);
```

The communicator instance passed to this function is the IceBox server's communicator and should only be used for administrative purposes. For example, the entry point function could use this communicator's logger to display log messages. For a service's normal operations, it must use the communicator that it receives as an argument to its `start` method.

Here is a sample configuration for our C++ service:

```
IceBox.Service.Hello=HelloService:create --Ice.Trace.Network=1 hello
there
```

This configuration results in the creation of a service named `Hello`. The service is expected to reside in `HelloService.dll` on Windows or `libHelloService.so` on Linux, and the entry point function `create` is invoked to create an instance of the service. The argument `--Ice.Trace.Network=1` is converted into a property definition, and the arguments `hello` and `there` become the two elements in the `args` sequence parameter that is passed to the `start` method.

## IceBox Service Configuration in Java

For a Java service, the [entry point](#) is typically the class name (including any package) of the service implementation class, but may also include a leading path to a class directory or JAR file. The class must define a public constructor.

To instantiate the service, the IceBox server first checks to see if the service defines a constructor taking an argument of type `Ice.Communicator`. If so, the service invokes this constructor and passes the server's communicator, which should only be used for administrative purposes. For example, the constructor could use this communicator's logger to display log messages. For a service's normal operations, it must use the communicator that it receives as an argument to its `start` method.

If the service does not define a constructor taking an `Ice.Communicator` argument, the server invokes the service's default constructor.

Here is a sample configuration for our [Java example](#):

```
IceBox.Service.Hello=HelloServiceI --Ice.Trace.Network=1 hello there
```

This configuration results in the creation of a service named `Hello`. The service is expected to reside in the class `HelloServiceI`. The argument `--Ice.Trace.Network=1` is converted into a property definition, and the arguments `hello` and `there` become the two elements in the `args` sequence parameter that is passed to the `start` method.

## IceBox Service Configuration in C#

The [entry point](#) of a .NET service has the form `assembly:class`. The `assembly` component can be specified as the name of a DLL, with an optional leading path, or as the partial or full name of an assembly residing in the Global Assembly Cache (GAC), such as `hello,Version=0.0.0.0,Culture=neutral`. The class component is the complete class name of the service implementation class, which must define a public constructor.

To instantiate the service, the IceBox server first checks to see if the service defines a constructor taking an argument of type `Ice.Communicator`. If so, the service invokes this constructor and passes the server's communicator, which should only be used for administrative purposes. For example, the constructor could use this communicator's logger to display log messages. For a service's normal operations, it must use the communicator that it receives as an argument to its `start` method.

If the service does not define a constructor taking an `Ice.Communicator` argument, the server invokes the service's default constructor.

Here is a sample configuration for our [C# example](#):

```
IceBox.Service.Hello=helloservice.dll:HelloServiceI
--Ice.Trace.Network=1 hello there
```

This configuration results in the creation of a service named `Hello`. The service is expected to reside in the assembly named `helloservice.dll`, implemented by the class `HelloServiceI`. The argument `--Ice.Trace.Network=1` is converted into a property definition, and the arguments `hello` and `there` become the two elements in the `args` sequence parameter that is passed to the `start` method.

## Using a Shared Communicator

A service can be configured to use a shared communicator using the `IceBox.UseSharedCommunicator.name` property:

```
IceBox.UseSharedCommunicator.Hello=1
```

The default behavior if this property is not specified is to create a new communicator instance for the service. However, if [collocation optimizations](#) between services are desired, each of those services must be configured to use the shared communicator.

## Inheriting Properties from the IceBox Server

By default, a service does not inherit the server's configuration properties. For example, consider the following server configuration:

```
IceBox.Service.Weather=... --Ice.Config=svc.cfg
Ice.Trace.Network=1
```

The `Weather` service only receives the properties that are defined in its `IceBox.Service` property. In the example above, the service's communicator is initialized with the properties from the file `svc.cfg`.

If services need to inherit the server's configuration properties, define the `IceBox.InheritProperties` property in the IceBox server's configuration:

```
IceBox.InheritProperties=1
```

The properties of the [shared communicator](#) are also affected by this setting.

## Load Order for IceBox Services

By default, the server loads the configured services in an undefined order, meaning services in the same IceBox server should not depend on one another. If services must be loaded in a particular order, the `IceBox.LoadOrder` property can be used:

```
IceBox.LoadOrder=Service1,Service2
```

In this example, `Service1` is loaded first, followed by `Service2`. Any remaining services are loaded after `Service2`, in an undefined order. Each service mentioned in `IceBox.LoadOrder` must have a matching `IceBox.Service` property.

During shutdown, services are stopped in the reverse of the order in which they were loaded.

## Logging Considerations for IceBox Services

In Ice 3.4 and earlier, the IceBox server configures a variation of its own logger in the communicator that it creates for each service (the only difference being a service-specific logging prefix), therefore the logging scheme you configure for the IceBox server must be appropriate for all of its services. The only way a service can configure a different logger is by using a [logger plug-in](#).

As of Ice 3.5, the IceBox server only configures a logger for a service if that service has not already specified its own logger via the [Ice.LogFile](#) or [Ice.UseSyslog](#) properties.

### See Also

- [IceBox Properties](#)
- [Developing IceBox Services](#)
- [IceStorm](#)
- [Location Transparency](#)
- [Ice Miscellaneous Properties](#)

## Starting the IceBox Server

Incorporating everything we discussed previously, we can now configure and start IceBox servers.

On this page:

- [Starting the C++ IceBox Server](#)
- [Starting the Java IceBox Server](#)
- [Starting the C# IceBox Server](#)
- [IceBox Server Failures](#)

## Starting the C++ IceBox Server

The configuration file for our example C++ service is shown below:

```
IceBox.Service.Hello=HelloService:create
Hello.Endpoints=tcp -p 10001
```

Notice that we define an endpoint for the object adapter created by the `Hello` service.

Assuming these properties reside in a configuration file named `config`, we can start the C++ IceBox server as follows:

```
$ icebox --Ice.Config=config
```

Additional command line options are supported, including those that allow the server to run as a [Windows service](#) or [Unix daemon](#).

## Starting the Java IceBox Server

Our Java configuration is nearly identical to the C++ version, except for the entry point specification:

```
IceBox.Service.Hello=HelloServiceI
Hello.Endpoints=tcp -p 10001
```

Notice that we define an endpoint for the object adapter created by the `Hello` service.

Assuming these properties reside in a configuration file named `config`, we can start the Java IceBox server as follows:

```
$ java IceBox.Server --Ice.Config=config
```

## Starting the C# IceBox Server

The configuration file for our example C# service is shown below:

```
IceBox.Service.Hello=helloservice.dll:HelloService
Hello.Endpoints=tcp -p 10001
```

Notice that we define an endpoint for the object adapter created by the `Hello` service.

Assuming these properties reside in a configuration file named `config`, we can start the C# IceBox server as follows:

```
$ iceboxnet --Ice.Config=config
```

## IceBox Server Failures

At startup, an IceBox server inspects its configuration for all properties having the prefix `IceBox.Service` and initializes each service. If initialization fails for a service, the IceBox server invokes the `stop` operation on any initialized services, reports an error, and terminates.

### See Also

- [The Server-Side main Function in C++](#)
- [IceBox Properties](#)

## IceBox Administration

An IceBox server internally creates an object called the service manager that is responsible for loading and initializing the configured services. You can optionally expose this object to remote clients, such as the IceBox and IceGrid administrative utilities, so that they can execute certain administrative tasks.

On this page:

- [IceBox Administrative Slice Interfaces](#)
  - [The IceBox ServiceManager Interface](#)
  - [The IceBox ServiceObserver Interface](#)
- [Enabling the Service Manager](#)
- [IceBox Object Identities](#)
  - [IceBox.ServiceManager Object Adapter](#)
  - [Ice Administrative Facility](#)
- [IceBox Administrative Client Configuration](#)
  - [Using the IceBox.ServiceManager Object Adapter](#)
  - [Using the Ice Administrative Facility](#)
- [IceBox Administrative Utility](#)

## IceBox Administrative Slice Interfaces

The Slice definitions shown below comprise the IceBox administrative interface:

Slice
<pre> module IceBox {   exception AlreadyStartedException {};   exception AlreadyStoppedException {};   exception NoSuchServiceException {};    interface ServiceObserver {     void servicesStarted(Ice::StringSeq services);     void servicesStopped(Ice::StringSeq services);   };    interface ServiceManager {     idempotent Ice::SliceChecksumDict getSliceChecksums();     void startService(string service)       throws AlreadyStartedException, NoSuchServiceException;     void stopService(string service)       throws AlreadyStoppedException, NoSuchServiceException;     void addObserver(ServiceObserver* observer)     void shutdown();   }; }; </pre>

### The IceBox ServiceManager Interface

The `ServiceManager` interface provides access to the service manager object of an IceBox server. It defines the following operations:



- `getSliceChecksums`  
Returns a dictionary of [checksums](#) that allows a client to verify that it is using the same Slice definitions as the server.
- `startService`  
Starts a pre-configured service that is currently inactive. This operation cannot be used to add new services at run time, nor will it cause an inactive service's implementation to be reloaded. If no matching service is found, the operation raises `NoSuchServiceException`. If the service is already active, the operation raises `AlreadyStartedException`.
- `stopService`  
Stops an active service but does not unload its implementation. The operation raises `NoSuchServiceException` if no matching service is found, and `AlreadyStoppedException` if the service is stopped at the time `stopService` is invoked.
- `addObserver`  
Adds an observer that is called when IceBox services are started or stopped. The service manager ignores operations that supply a null proxy, or a proxy that has already been registered.
- `shutdown`  
Terminates the services and shuts down the IceBox server.

## The IceBox ServiceObserver Interface

An administrative client that is interested in receiving callbacks when IceBox services are started or stopped must implement the `ServiceObserver` interface and register the callback object's proxy with the service manager using its `addObserver` operation. The `ServiceObserver` interface defines two operations:

- `servicesStarted`  
Invoked immediately upon registration to supply the current list of active services, and thereafter each time a service is started.
- `servicesStopped`  
Invoked whenever a service is stopped, and when the IceBox server is shutting down.

The IceBox server unregisters an observer if the invocation of either operation causes an exception.

Our discussion of [IceGrid](#) includes an example that demonstrates how to register a `ServiceObserver` callback with an IceBox server deployed with IceGrid.

## Enabling the Service Manager

IceBox's administrative functionality is disabled by default. You can enable it in two ways:

1. Define endpoints for the `IceBox.ServiceManager` object adapter.
2. Satisfy the prerequisites for enabling the Ice [administrative facility](#).

For example, the following configuration property enables the `IceBox.ServiceManager` object adapter:

```
IceBox.ServiceManager.Endpoints=tcp -h 127.0.0.1 -p 10000
```

Similarly, the Ice administrative facility requires that endpoints be defined for the `Ice.Admin` object adapter with the property `Ice.Admin.Endpoints`. Note that the `Ice.Admin` object adapter is enabled automatically in an IceBox server that is [deployed by IceGrid](#).

Regardless of which object adapter(s) you choose to enable, exposing the service manager makes an IceBox server vulnerable to denial-of-service attacks from malicious clients. Consequently, you should [choose the endpoints and transports carefully](#).

## IceBox Object Identities

Although an IceBox server has only one service manager object, the object is accessible via two different identities depending on how the administrative functionality was enabled.

### IceBox.ServiceManager Object Adapter

When this object adapter is enabled, the service manager object has the default identity `IceBox/ServiceManager`. If an application requires the use of multiple IceBox servers, it is a good idea to assign unique identities to their service manager objects by configuring the servers with different values for the `IceBox.InstanceName` property, as shown in the following example:

```
IceBox.InstanceName=IceBox1
```

This property changes the category of the object's identity, which becomes `IceBox1/ServiceManager`. A corresponding change must be made in the configuration of administrative clients.

### Ice Administrative Facility

When this facility is enabled, the service manager is added as a facet of the server's `admin` object. As a result, the identity of the service manager is the same as that of the `admin` object, and the name of its facet is `IceBox.ServiceManager`. The identity of the `admin` object uses either a UUID or a statically-configured value for its category, and the value `admin` for its name. For example, consider the following property definitions:

```
Ice.Admin.Endpoints=tcp -h 127.0.0.1 -p 10001
Ice.Admin.InstanceName=IceBox
```

In this case, the identity of the `admin` object is `IceBox/admin`.

IceBox also registers a `Properties` facet for each of its services so that the configuration properties of a service can be inspected remotely. The facet name is constructed as follows:

```
IceBox.Service.name.Properties
```

The value `name` represents the service name.

## IceBox Administrative Client Configuration

A client requiring administrative access to the service manager can create a proxy using the endpoints configured for the `service manager`.

### Using the IceBox.ServiceManager Object Adapter

To access the service manager via the `IceBox.ServiceManager` object adapter, the proxy should use the default identity `IceBox/ServiceManager` unless the server has [changed the category](#) using the `IceBox.InstanceName` property.

### Using the Ice Administrative Facility

To access the service manager via the administrative facility, the client must first obtain (or be able to construct) a proxy for the `admin` object. The default identity of the `admin` object uses a UUID for its category, which means the client cannot predict the identity and therefore will be unable to construct the proxy itself. If the IceBox server is deployed with IceGrid, the client can use the technique described in our discussion of [IceGrid](#) to access its `admin` object.

In the absence of IceGrid, the IceBox server should set the `Ice.Admin.InstanceName` property if remote administration is required. In so doing, the identity of the `admin` object becomes well-known, and a client can construct the proxy on its own. For example, let us assume that

the IceBox server defines the following property:

```
Ice.Admin.InstanceName=IceBox
```

A client can define the proxy for the `admin` object in a configuration property as follows:

```
ServiceManager.Proxy=IceBox/admin -f IceBox.ServiceManager -h 127.0.0.1
-p 10001
```

The proxy option `-f IceBox.ServiceManager` specifies the name of the service manager's administrative facet.

## IceBox Administrative Utility

IceBox includes C++ and Java implementations of an administrative utility. The utilities have the same usage:

```
Usage: iceboxadmin [options] [command...]
Options:
-h, --help Show this message.
-v, --version Display the Ice version.

Commands:
start SERVICE Start a service.
stop SERVICE Stop a service.
shutdown Shutdown the server.
```

The C++ utility is named `iceboxadmin`, while the Java utility is represented by the class `IceBox.Admin`.

The `start` command is equivalent to invoking `startService` on the service manager interface. Its purpose is to start a pre-configured service; it cannot be used to add new services at run time. Note that this command does not cause the service's implementation to be reloaded.

Similarly, the `stop` command stops the requested service but does not cause the IceBox server to unload the service's implementation.

The `shutdown` command stops all active services and shuts down the IceBox server.

The C++ and Java utilities obtain the service manager's proxy from the property `IceBoxAdmin.ServiceManager.Proxy`, therefore this proxy must be defined in the program's configuration file or on the command line, and the proxy's contents of depend on the server's configuration. If the IceBox server is deployed with IceGrid, we recommend using the IceGrid [administrative utilities](#) instead, which provide equivalent commands for administering an IceBox server. Otherwise, the proxy should have the [endpoints](#) and [identity](#) configured for the server.

### See Also

- [Slice Checksums](#)
- [Administrative Facility](#)
- [The admin Object](#)
- [The Properties Facet](#)
- [icegridadmin Command Line Tool](#)
- [IceGrid and the Administrative Facility](#)
- [IceBox Properties](#)
- [IceBoxAdmin Properties](#)
- [Ice Administrative Properties](#)



## IceStorm

IceStorm is an efficient publish/subscribe service for Ice applications. Applications often need to disseminate information to multiple recipients. For example, suppose we are developing a weather monitoring application in which we collect measurements such as wind speed and temperature from a meteorological tower and periodically distribute them to weather monitoring stations. We initially consider using the architecture shown below:

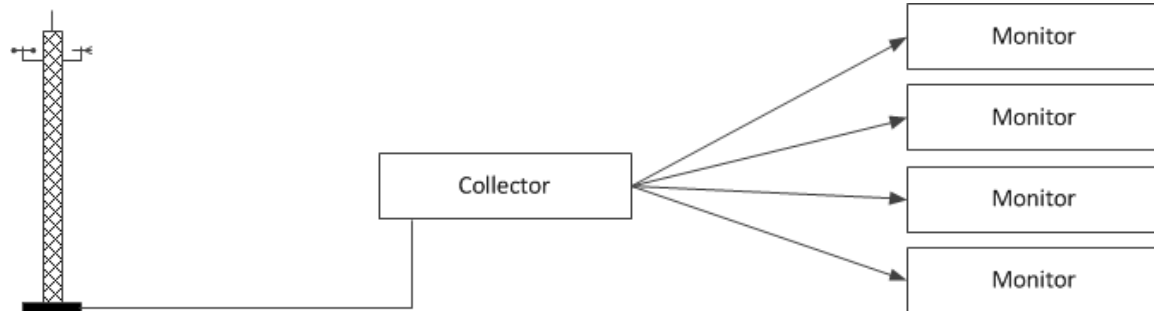

*Initial design for a weather monitoring application.*

However, the primary disadvantage of this architecture is that it tightly couples the collector to its monitors, needlessly complicating the collector implementation by requiring it to manage the details of monitor registration, measurement delivery, and error recovery. We can rid ourselves of these mundane duties by incorporating IceStorm into our architecture, as shown below:

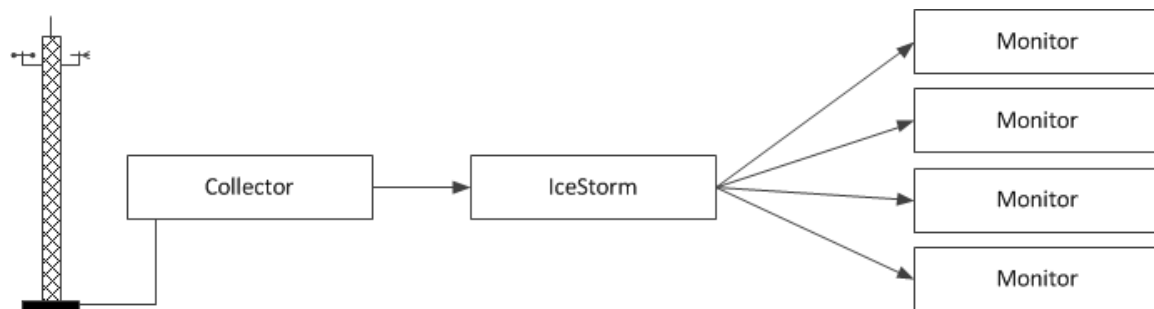

*A weather monitoring application using IceStorm.*

IceStorm simplifies the collector implementation significantly by decoupling it from the monitors. As a publish/subscribe service, IceStorm acts as a mediator between the collector (the publisher) and the monitors (the subscribers), and offers several advantages:

- When the collector is ready to distribute a new set of measurements, it makes a single request to the IceStorm server. The IceStorm server takes responsibility for delivering the request to the monitors, including handling any exceptions caused by ill-behaved or missing subscribers. The collector no longer needs to be aware of its monitors, or whether it even has any monitors at that moment.
- Similarly, monitors interact with the IceStorm server to perform tasks such as subscribing and unsubscribing, thereby allowing the collector to focus on its application-specific responsibilities and not on administrative trivia.
- The collector and monitor applications require very few changes to incorporate IceStorm.

## Topics

- [IceStorm Concepts](#)
- [IceStorm Interfaces](#)
- [Using IceStorm](#)
- [Highly Available IceStorm](#)
- [IceStorm Administration](#)
- [Topic Federation](#)
- [IceStorm Quality of Service](#)
- [IceStorm Delivery Modes](#)
- [Configuring IceStorm](#)
- [IceStorm Metrics](#)

## IceStorm Concepts

This section discusses several concepts that are important for understanding IceStorm's capabilities.

- **Message**

An IceStorm *message* is strongly typed and is represented by an invocation of a Slice operation: the operation name identifies the type of the message, and the operation parameters define the message contents. A message is published by invoking the operation on an IceStorm proxy in the normal fashion. Similarly, subscribers receive the message as a regular servant upcall. As a result, IceStorm uses the "push" model for message delivery; polling is not supported.

- **IceStorm Topics**

An application indicates its interest in receiving messages by subscribing to a *topic*. An IceStorm server supports any number of topics, which are created dynamically and distinguished by unique names. Each topic can have multiple publishers and subscribers.

A topic is essentially equivalent to an application-defined Slice interface: the operations of the interface define the types of messages supported by the topic. A publisher uses a proxy for the topic interface to send its messages, and a subscriber implements the topic interface (or an interface derived from the topic interface) in order to receive the messages. This is no different than if the publisher and subscriber were communicating directly in the traditional client-server style; the interface represents the contract between the client (the publisher) and the server (the subscriber), except IceStorm transparently forwards each message to multiple recipients.

IceStorm does not verify that publishers and subscribers are using compatible interfaces, therefore applications must ensure that topics are used correctly.

- **Unidirectional Messages**

IceStorm messages are *unidirectional*, that is, they must have `void` return type, cannot have out-parameters, and cannot raise user exceptions. It follows that a publisher cannot receive replies from its subscribers. Any of the Ice transports (TCP, SSL, and UDP) can be used to publish and receive messages.

- **Federation**

IceStorm supports the formation of topic graphs, also known as *federation*. A topic graph is formed by creating links between topics, where a *link* is a unidirectional association from one topic to another. Each link has a *cost* that may restrict message delivery on that link. A message published on a topic is also published on all of the topic's links for which the message cost does not exceed the link cost.

Once a message has been published on a link, the receiving topic publishes the message to its subscribers, but does not publish it on any of its links. In other words, IceStorm messages propagate at most one hop from the originating topic in a federation.

The following figure presents an example of topic federation. Topic  $T_1$  has links to  $T_2$  and  $T_3$ , as indicated by the arrows. The subscribers  $S_1$  and  $S_2$  receive all messages published on  $T_2$ , as well as those published on  $T_1$ . Subscriber  $S_3$  receives messages only from  $T_1$ , and  $S_4$  receives messages from both  $T_3$  and  $T_1$ .

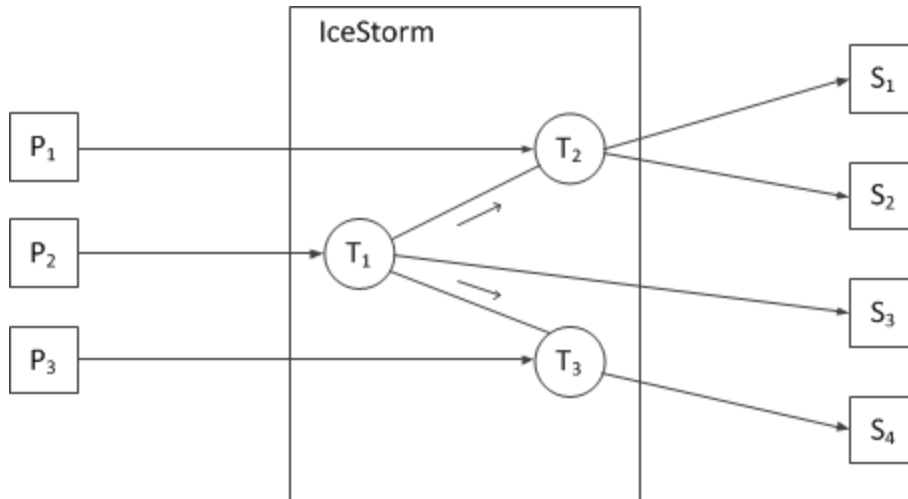

*Topic federation.*

IceStorm makes no attempt to prevent a subscriber from receiving duplicate messages. For example, if a subscriber is subscribed to both  $T_2$  and  $T_3$ , then it would receive two requests for each message published on  $T_1$ .

- **Quality of Service**

IceStorm allows each subscriber to specify its own *quality of service* (QoS) parameters that affect the delivery of its messages. Quality of service parameters are represented as a dictionary of name-value pairs.

- **Replication**

IceStorm supports [replication](#) to provide higher availability for publishers and subscribers.

- **Persistent Mode**

IceStorm's default behavior maintains information about topics, links, and subscribers in a database. However, a message sent via IceStorm is not stored persistently, but rather is discarded as soon as it is delivered to the topic's current set of subscribers. If an error occurs during delivery to a subscriber, IceStorm does not queue messages for that subscriber.

- **Transient Mode**

IceStorm can optionally run in a fully transient mode in which no database is required. Replication is not supported in this mode.

- **Subscriber Errors**

If IceStorm encounters a failure while attempting to deliver a message to a subscriber, the subscriber is immediately unsubscribed from the topic on which the message was published. This is important if you make changes to a Slice data type or operation signature: if you do, you must ensure that both publishers and subscribers use the same Slice definitions; if you do not, IceStorm is likely to encounter marshaling errors when forwarding an event to a subscriber with a mismatched Slice definition and remove the subscription.

#### See Also

- [Oneway Invocations](#)
- [Topic Federation](#)
- [IceStorm Quality of Service](#)
- [Configuring IceStorm](#)
- [Freeze](#)

## IceStorm Interfaces

This page provides a brief introduction to the Slice interfaces comprising the IceStorm service. See the online [Slice API Reference XREF](#) for the Slice documentation.

On this page:

- [The TopicManager Interface](#)
- [The Topic Interface](#)

### The TopicManager Interface

The `TopicManager` is a singleton object that acts as a factory and repository of `Topic` objects. Its interface and related types are shown below:

Slice
<pre> module IceStorm { dictionary&lt;string, Topic*&gt; TopicDict;  exception TopicExists {     string name; };  exception NoSuchTopic {     string name; };  interface TopicManager {     Topic* create(string name) throws TopicExists;     idempotent Topic* retrieve(string name) throws NoSuchTopic;     idempotent TopicDict retrieveAll();     idempotent Ice::SliceChecksumDict getSliceChecksums(); }; }; </pre>

The `create` operation is used to create a new topic, which must have a unique name. The `retrieve` operation allows a client to obtain a proxy for an existing topic, and `retrieveAll` supplies a dictionary of all existing topics. The `getSliceChecksums` operation returns [Slice checksums](#) for the IceStorm definitions.

### The Topic Interface

The `Topic` interface represents a topic and provides several administrative operations for configuring links and managing subscribers.



### Slice

```

module IceStorm {
struct LinkInfo {
 Topic* theTopic;
 string name;
 int cost;
};
sequence<LinkInfo> LinkInfoSeq;

dictionary<string, string> QoS;

exception LinkExists {
 string name;
};

exception NoSuchLink {
 string name;
};

exception AlreadySubscribed {};

exception BadQoS {
 string reason;
};

interface Topic {
 idempotent string getName();
 idempotent Object* getPublisher();
 idempotent Object* getNonReplicatedPublisher();
 Object* subscribeAndGetPublisher(QoS theQoS, Object* subscriber)
 throws AlreadySubscribed, BadQoS;
 idempotent void unsubscribe(Object* subscriber);
 idempotent void link(Topic* linkTo, int cost)
 throws LinkExists;
 idempotent void unlink(Topic* linkTo) throws NoSuchLink;
 idempotent LinkInfoSeq getLinkInfoSeq();
 void destroy();
};
};

```

The `getName` operation returns the name assigned to the topic, while the `getPublisher` and `getNonReplicatedPublisher` operations return proxies for the topic's [publisher object](#).

The `subscribeAndGetPublisher` operation adds a subscriber's proxy to the topic; if another subscriber proxy already exists with the same object identity, the operation throws `AlreadySubscribed`. The operation returns a proxy for a [subscriber-specific publisher object](#).

The `unsubscribe` operation removes the subscriber from the topic.

A link to another topic is created using the `link` operation; if a link already exists to the given topic, the `LinkExists` exception is raised.

Links are destroyed using the `unlink` operation.

Finally, the `destroy` operation permanently destroys the topic.

**See Also**

- [Slice Checksums](#)
- [Using an IceStorm Publisher Object](#)
- [Publishing to a Specific Subscriber](#)
- [Topic Federation](#)

## Using IceStorm

Now we'll expand on the earlier [weather monitoring example](#), demonstrating how to create, subscribe to and publish messages on a topic. We use the following Slice definitions in our example:

```

Slice

```
struct Measurement {
    string tower; // tower id
    float windSpeed; // knots
    short windDirection; // degrees
    float temperature; // degrees Celsius
};

interface Monitor {
    void report(Measurement m);
};
```

```

Monitor is our topic interface. For the sake of simplicity, it defines just one operation, `report`, taking a `Measurement` struct as its only parameter.

### Topics

- [Implementing an IceStorm Publisher](#)
- [Using an IceStorm Publisher Object](#)
- [Implementing an IceStorm Subscriber](#)
- [Publishing to a Specific Subscriber](#)

### See Also

- [IceStorm](#)

## Implementing an IceStorm Publisher

The implementation of our weather measurement collector application can be summarized easily:

1. Obtain a proxy for the `TopicManager`. This is the primary IceStorm object, used by both publishers and subscribers.
2. Obtain a proxy for the `Weather` topic, either by creating the topic if it does not exist, or retrieving the proxy for the existing topic.
3. Obtain a proxy for the `Weather` topic's "publisher object." This proxy is provided for the purpose of publishing messages, and therefore is narrowed to the topic interface (`Monitor`).
4. Collect and report measurements.

We present collector implementations in C++ and Java below.

On this page:

- [Publisher Example in C++](#)
- [Publisher Example in Java](#)

### Publisher Example in C++

As usual, our C++ example begins by including the necessary header files. The interesting ones are `IceStorm/IceStorm.h`, which is generated from the IceStorm Slice definitions, and `Monitor.h`, containing the generated code for our monitor definitions shown above.

## C++

```

#include <Ice/Ice.h>
#include <IceStorm/IceStorm.h>
#include <Monitor.h>

int main(int argc, char* argv[])
{
 ...
 Ice::ObjectPrx obj = communicator->stringToProxy("IceStorm/TopicManager:tcp -p 9999");
 IceStorm::TopicManagerPrx topicManager =
IceStorm::TopicManagerPrx::checkedCast(obj);
 IceStorm::TopicPrx topic;
 while (!topic) {
 try {
 topic = topicManager->retrieve("Weather");
 } catch (const IceStorm::NoSuchTopic&) {
 try {
 topic = topicManager->create("Weather");
 } catch (const IceStorm::TopicExists&) {
 // Another client created the topic.
 }
 }
 }

 Ice::ObjectPrx pub = topic->getPublisher()->ice_oneway();
 MonitorPrx monitor = MonitorPrx::uncheckedCast(pub);
 while (true) {
 Measurement m = getMeasurement();
 monitor->report(m);
 }
 ...
}

```

Note that this example assumes that IceStorm uses the [instance name](#) `IceStorm`. The actual instance name may differ, and you need to use it as the category when calling `stringToProxy`.

After obtaining a proxy for the topic manager, the collector attempts to retrieve the topic. If the topic does not exist yet, the collector receives a `NoSuchTopic` exception and then creates the topic:

**C++**

```

IceStorm::TopicPrx topic;
while(!topic) {
 try {
 topic = topicManager->retrieve("Weather");
 } catch (const IceStorm::NoSuchTopic&) {
 try {
 topic = topicManager->create("Weather");
 } catch (const IceStorm::TopicExists&) {
 // Another client created the topic.
 }
 }
}

```

The next step is obtaining a proxy for the publisher object, which the collector narrows to the `Monitor` interface. (We create a oneway proxy for the publisher purely for efficiency reasons.)

**C++**

```

Ice::ObjectPrx pub = topic->getPublisher()->ice_oneway();
MonitorPrx monitor = MonitorPrx::uncheckedCast(pub);

```

Finally, the collector enters its main loop, collecting measurements and publishing them via the `IceStorm` publisher object:

**C++**

```

while (true) {
 Measurement m = getMeasurement();
 monitor->report(m);
}

```

## Publisher Example in Java

The equivalent Java version is shown below:

## Java

```

public static void main(String[] args)
{
 ...
 Ice.ObjectPrx obj = communicator.stringToProxy("IceStorm/TopicManager:tcp -p 9999");
 IceStorm.TopicManagerPrx topicManager =
IceStorm.TopicManagerPrxHelper.checkedCast(obj);
 IceStorm.TopicPrx topic = null;
 while (topic == null) {
 try {
 topic = topicManager.retrieve("Weather");
 } catch (IceStorm.NoSuchTopic ex) {
 try {
 topic = topicManager.create("Weather");
 } catch (IceStorm.TopicExists ex) {
 // Another client created the topic.
 }
 }
 }

 Ice.ObjectPrx pub = topic.getPublisher().ice_oneway();
 MonitorPrx monitor = MonitorPrxHelper.uncheckedCast(pub);
 while (true) {
 Measurement m = getMeasurement();
 monitor.report(m);
 }
 ...
}

```

Note that this example assumes that IceStorm uses the [instance name](#) IceStorm. The actual instance name may differ, and you need to use it as the category when calling `stringToProxy`.

After obtaining a proxy for the topic manager, the collector attempts to retrieve the topic. If the topic does not exist yet, the collector receives a `NoSuchTopic` exception and then creates the topic:

**Java**

```

IceStorm.TopicPrx topic = null;
while (topic == null) {
 try {
 topic = topicManager.retrieve("Weather");
 } catch (IceStorm.NoSuchTopic ex) {
 try {
 topic = topicManager.create("Weather");
 } catch (IceStorm.TopicExists ex) {
 // Another client created the topic.
 }
 }
}

```

The next step is obtaining a proxy for the publisher object, which the collector narrows to the `Monitor` interface:

**Java**

```

Ice.ObjectPrx pub = topic.getPublisher().ice_oneway();
MonitorPrx monitor = MonitorPrxHelper.uncheckedCast(pub);

```

Finally, the collector enters its main loop, collecting measurements and publishing them via the `IceStorm` publisher object:

**Java**

```

while (true) {
 Measurement m = getMeasurement();
 monitor.report(m);
}

```

**See Also**

- [Configuring IceStorm](#)



## Using an IceStorm Publisher Object

Each topic creates a publisher object for the express purpose of publishing messages. It is a special object in that it implements an Ice interface that allows the object to receive and forward requests (i.e., IceStorm messages) without requiring knowledge of the operation types.

On this page:

- [Type Safety Considerations for the Publisher Object](#)
- [Publish using Oneway or Twoway Invocations?](#)
- [Selecting a Transport for the Publisher Object](#)
- [Using Request Contexts with the Publisher Object](#)

### Type Safety Considerations for the Publisher Object

From the publisher's perspective, the publisher object appears to be an application-specific type. In reality, the publisher object can forward requests for any type, and that introduces a degree of risk: a misbehaving publisher can use `uncheckedCast` to narrow the publisher object to any type and invoke any operation; the publisher object unknowingly forwards those requests to the subscribers.

If a publisher sends a request using an incorrect type, the Ice run time in a subscriber typically responds by raising `OperationNotExistException`. However, since the subscriber receives its messages as oneway invocations, no response can be sent to the publisher object to indicate this failure, and therefore neither the publisher nor the subscriber is aware of the type-mismatch problem. In short, IceStorm places the burden on the developer to ensure that publishers and subscribers are using it correctly.

### Publish using Oneway or Twoway Invocations?

IceStorm messages are unidirectional, but publishers may use either oneway or twoway invocations when sending messages to the publisher object. Each invocation style has advantages and disadvantages that you should consider when deciding which one to use. The differences between the invocation styles affect a publisher in four ways:

- **Efficiency**  
Oneway invocations have the advantage in efficiency because the Ice run time in the publisher does not await a reply to each message (and, of course, no reply is sent by IceStorm on the wire).
- **Ordering**  
The use of oneway invocations by a publisher may affect the order in which subscribers receive messages. If ordering is important, use twoway invocations with a **reliability QoS** of `ordered`, or use a single thread in the subscriber.
- **Reliability**  
**Oneway invocations can be lost** under certain circumstances, even when they are sent over a reliable transport such as TCP. If the loss of messages is unacceptable, or you are unable to address the potential causes of lost oneway messages, then twoway invocations are recommended.
- **Delays**  
A publisher may experience network-related delays when sending messages to IceStorm if subscribers are slow in processing messages. Twoway invocations are more susceptible to these delays than oneway invocations.

### Selecting a Transport for the Publisher Object

Each publisher can select its own transport for message delivery, therefore the transport used by a publisher to communicate with IceStorm has no effect on how IceStorm delivers messages to its subscribers.

For example, a publisher can use a UDP transport if the possibility of lost messages is acceptable (and if IceStorm provides a UDP endpoint to publishers). However, the TCP or SSL transports are generally recommended for IceStorm's publisher endpoint in order to ensure that published messages are delivered reliably to IceStorm, even if they may not be delivered reliably to some subscribers.

### Using Request Contexts with the Publisher Object

A **request context** is an optional argument of all remote invocations. If a publisher supplies a request context when publishing a message, IceStorm will forward it intact to subscribers.

Services such as [Glacier2](#) employ request contexts to provide applications with more control over the service's behavior. For example, if a

publisher knows that IceStorm is delivering messages to subscribers via a Glacier2 router, the publisher can influence Glacier2's behavior by including a request context, as shown in the following C++ example:

```

C++

```
Ice::ObjectPrx pub = topic->getPublisher();
Ice::Context ctx;
ctx["_fwd"] = "Oz";
MonitorPrx monitor = MonitorPrx::uncheckedCast(pub->ice_context(ctx
));
```

```

The `_fwd` context key, when encountered by Glacier2, causes the router to forward the request using compressed [batch oneway](#) messages. The `ice_context` [proxy method](#) is used to obtain a proxy that includes the Glacier2 request context in every invocation, eliminating the need for the publisher to specify it explicitly.

**See Also**

- [IceStorm Quality of Service](#)
- [Oneway Invocations](#)
- [Request Contexts](#)
- [How Glacier2 uses Request Contexts](#)
- [Batched Invocations](#)
- [Proxy Methods](#)

## Implementing an IceStorm Subscriber

Our weather measurement subscriber implementation takes the following steps:

1. Obtain a proxy for the `TopicManager`. This is the primary `IceStorm` object, used by both publishers and subscribers.
2. Create an object adapter to host our `Monitor` servant.
3. Instantiate the `Monitor` servant and activate it with the object adapter.
4. Subscribe to the `Weather` topic.
5. Process `report` messages until shutdown.
6. Unsubscribe from the `Weather` topic.

We present monitor implementations in C++ and Java below.

On this page:

- [Subscriber Example in C++](#)
- [Subscriber Example in Java](#)

### Subscriber Example in C++

Our C++ monitor implementation begins by including the necessary header files. The interesting ones are `IceStorm/IceStorm.h`, which is generated from the `IceStorm` Slice definitions, and `Monitor.h`, containing the generated code for our [monitor definitions](#):

**C++**

```

#include <Ice/Ice.h>
#include <IceStorm/IceStorm.h>
#include <Monitor.h>

using namespace std;

class MonitorI : virtual public Monitor {
public:
 virtual void report(const Measurement& m, const Ice::Current&) {
 cout << "Measurement report:" << endl
 << " Tower: " << m.tower << endl
 << " W Spd: " << m.windSpeed << endl
 << " W Dir: " << m.windDirection << endl
 << " Temp: " << m.temperature << endl
 << endl;
 }
};

int main(int argc, char* argv[])
{
 ...
 Ice::ObjectPrx obj = communicator->stringToProxy("IceStorm/TopicManager:tcp -p 9999");
 IceStorm::TopicManagerPrx topicManager =
IceStorm::TopicManagerPrx::checkedCast(obj);

 Ice::ObjectAdapterPtr adapter = communicator->createObjectAdapter("MonitorAdapter");

 MonitorPtr monitor = new MonitorI;
 Ice::ObjectPrx proxy = adapter->addWithUUID(monitor)->ice_oneway();
 adapter->activate();

 IceStorm::TopicPrx topic;
 try {
 topic = topicManager->retrieve("Weather");
 IceStorm::QoS qos;
 topic->subscribeAndGetPublisher(qos, proxy);
 }
 catch (const IceStorm::NoSuchTopic&) {
 // Error! No topic found!
 ...
 }

 communicator->waitForShutdown();

 topic->unsubscribe(proxy);
 ...
}

```

Our implementation of the `Monitor` servant is currently quite simple. A real implementation might update a graphical display, or incorporate the measurements into an ongoing calculation.

```
C++
```

```
class MonitorI : virtual public Monitor {
public:
 virtual void report(const Measurement& m, const Ice::Current&) {
 cout << "Measurement report:" << endl
 << " Tower: " << m.tower << endl
 << " W Spd: " << m.windSpeed << endl
 << " W Dir: " << m.windDirection << endl
 << " Temp: " << m.temperature << endl
 << endl;
 }
};
```

After obtaining a proxy for the topic manager, the program creates an object adapter, instantiates the `Monitor` servant and activates it:

```
C++
```

```
Ice::ObjectAdapterPtr adapter =
communicator->createObjectAdapter("MonitorAdapter");

MonitorPtr monitor = new MonitorI;
Ice::ObjectPrx proxy = adapter->addWithUUID(monitor)->ice_oneway();
adapter->activate();
```

Note that the code creates a oneway proxy for the `Monitor` servant. This is for efficiency reasons: by subscribing with a oneway proxy, IceStorm will deliver events to the subscriber via [oneway messages](#), instead of via twoway messages. We also activate the object adapter at this time, which means the servant can now begin receiving invocations.

Next, the monitor subscribes to the topic:

```
C++
```

```
IceStorm::TopicPrx topic;
try {
 topic = topicManager->retrieve("Weather");
 IceStorm::QoS qos;
 topic->subscribeAndGetPublisher(qos, proxy);
}
catch (const IceStorm::NoSuchTopic&) {
 // Error! No topic found!
 ...
}
```

Finally, the monitor blocks until the communicator is shutdown. After `waitForShutdown` returns, the monitor cleans up by unsubscribing from the topic:

**C++**

```
adapter->activate();
communicator->waitForShutdown();

topic->unsubscribe(proxy);
```

**Subscriber Example in Java**

The Java implementation of the monitor is shown below:

## Java

```

class MonitorI extends _MonitorDisp {
 public void report(Measurement m, Ice.Current curr) {
 System.out.println(
 "Measurement report:\n" +
 " Tower: " + m.tower + "\n" +
 " W Spd: " + m.windSpeed + "\n" +
 " W Dir: " + m.windDirection + "\n" +
 " Temp: " + m.temperature + "\n");
 }
}

public static void main(String[] args)
{
 ...
 Ice.ObjectPrx obj = communicator.stringToProxy("IceStorm/TopicManager:tcp -p 9999");
 IceStorm.TopicManagerPrx topicManager =
 IceStorm.TopicManagerPrxHelper.checkedCast(obj);

 Ice.ObjectAdapterPtr adapter =
 communicator.createObjectAdapter("MonitorAdapter");

 Monitor monitor = new MonitorI();
 Ice.ObjectPrx proxy = adapter.addWithUUID(monitor).ice_oneway();
 adapter.activate();

 IceStorm.TopicPrx topic = null;
 try {
 topic = topicManager.retrieve("Weather");
 java.util.Map qos = null;
 topic.subscribeAndGetPublisher(qos, proxy);
 }
 catch (IceStorm.NoSuchTopic ex) {
 // Error! No topic found!
 ...
 }

 communicator.waitForShutdown();

 topic.unsubscribe(proxy);
 ...
}

```

Our implementation of the `Monitor` servant is currently quite simple. A real implementation might update a graphical display, or incorporate the measurements into an ongoing calculation.

### Java

```
class MonitorI extends _MonitorDisp {
 public void report(Measurement m, Ice.Current curr) {
 System.out.println(
 "Measurement report:\n" +
 " Tower: " + m.tower + "\n" +
 " W Spd: " + m.windSpeed + "\n" +
 " W Dir: " + m.windDirection + "\n" +
 " Temp: " + m.temperature + "\n");
 }
}
```

After obtaining a proxy for the topic manager, the program creates an object adapter, instantiates the `Monitor` servant and activates it:

### Java

```
Monitor monitor = new MonitorI();
Ice.ObjectPrx proxy = adapter.addWithUUID(monitor).ice_oneway();
adapter.activate();
```

Note that the code creates a oneway proxy for the `Monitor` servant. This is for efficiency reasons: by subscribing with a oneway proxy, IceStorm will deliver events to the subscriber via [oneway messages](#), instead of via twoway messages. We also activate the object adapter at this time, which means the servant can now begin receiving invocations.

Next, the monitor subscribes to the topic:

### Java

```
IceStorm.TopicPrx topic = null;
try {
 topic = topicManager.retrieve("Weather");
 java.util.Map qos = null;
 topic.subscribeAndGetPublisher(qos, proxy);
}
catch (IceStorm.NoSuchTopic ex) {
 // Error! No topic found!
 ...
}
```

Finally, the monitor blocks until the communicator is shutdown. After `waitForShutdown` returns, the monitor cleans up by unsubscribing from the topic:



## Java

```
communicator.waitForShutdown();

topic.unsubscribe(proxy);
```

### See Also

- [Using IceStorm](#)
- [Oneway Invocations](#)

## Publishing to a Specific Subscriber

If you send events to the publisher object you obtain by calling `Topic::getPublisher`, the event is forwarded to all subscribers for that topic:

### C++

```
IceStorm::TopicPrx topic = ...;
Ice::ObjectPrx pub = topic->getPublisher()->ice_oneway();

MonitorPrx monitor = MonitorPrx::uncheckedCast(pub);
Measurement m = ...;

monitor->report(m); // Sent to all subscribers
```

You can also publish an event to a single specific subscriber, by using the return value of `subscribeAndGetPublisher`. For example:

### C++

```
MonitorPtr monitor = new MonitorI;
Ice::ObjectPrx proxy = adapter->addWithUUID(monitor)->ice_oneway();

IceStorm::topicPrx topic = ...;

Icestorm::QoS qos;
Ice::ObjectPrx pub = topic->subscribeAndGetPublisher(qos, proxy);
MonitorPrx monitor = MonitorPrx::uncheckedCast(pub);

Measurement m = ...;
monitor->report(m); // Sent only to this subscriber
```

Note that, here, we save the return value of `subscribeAndGetPublisher`. The return value is a proxy that connects specifically to the `MonitorI` instance denoted by `proxy`. However, when the code calls `report` on that proxy, instead of directly invoking on the `MonitorI` instance, the request is forwarded via `IceStorm`.

As it stands, this code is not very interesting. After all, the call to `monitor->report` is just a round-about way for the subscriber to publish a message to itself. However, the subscriber can pass this subscriber-specific publisher proxy to another process. When that process publishes an event via the proxy, the event is sent only to the specific subscriber, instead of to all subscribers for the topic. In turn, this is useful if you are using the observer pattern, with all observers attached to an `IceStorm` topic.

As an example, we might have a list whose state is to be monitored by a number of observers. Updates to the list are published to an `IceStorm` topic, say, `ListUpdates`. The observers of the list subscribe with an interface such as:

### Slice

```
interface ListObserver {
 void init(/* The entire state of the list */);
 void itemChange(/* The added or deleted item */);
};
```

The idea is that, when an observer first starts observing the list, the `init` operation is called on the observer and passed the entire list. This initializes the observer with the current state of the list. Thereafter, whenever the list changes, it calls `itemChange` on the observer to inform it of the addition or deletion of an item. (The details of how this happens are secondary; the important point is that the observer is informed of the current state of the list initially and, thereafter, receives incremental updates about modifications to the list, rather than the entire list whenever it changes.)

The list itself might look something like this:

Slice
<pre>interface List {     void add(Item i);     void remove(Item i);      void addObserver(ListObserver* lo);     void removeObserver(ListObserver* lo); };</pre>

The list provides operations to add and remove an item, as well as operations to add and remove an observer. Every time `add` or `remove` are called on the list, the list publishes an `itemChange` event to the `ListUpdates` topic; this informs all the subscribed observers of the change to the list. However, when an observer is first added, the observer's `init` operation must be called. Moreover, we want to call that method only once for each observer, so we cannot just publish the initial state of the list on a topic that all observers subscribe to.

The subscriber-specific proxy that is returned by `subscribeAndGetPublisher` solves this nicely: the implementation of `addObserver` calls `subscribeAndGetPublisher`, and then invokes `init` on the observer. This both subscribes the observer to the topic, and `IceStorm` forwards the call to `init` to the observer. This is preferable to the list invoking `init` on the observer directly: if the observer is misbehaved (for example, if its `init` implementation blocks for some time), the list is unaffected because `IceStorm` shields the list from such behavior.

**See Also**

- [Using IceStorm](#)

## Highly Available IceStorm

IceStorm offers a highly available (HA) mode that employs master-slave replication with automatic failover in case the master fails.

On this page:

- [IceStorm Replication Algorithm](#)
- [IceStorm Replica States](#)
- [Client Considerations for IceStorm Replication](#)
- [Subscriber Considerations for IceStorm Replication](#)
- [Publisher Considerations for IceStorm Replication](#)

### IceStorm Replication Algorithm

HA IceStorm uses the Garcia-Molina "Invitation Election Algorithm" [1] in which each replica has a priority and belongs to a replica group. The replica with the highest priority in the group becomes the coordinator, and the remaining replicas are slaves of the coordinator.

All replicas are statically configured with information about all other replicas, including their priority. The group combining works as follows:

- When recovering from an error, or during startup, replicas form a single self-coordinated group.
- Coordinators periodically attempt to combine their groups with other groups in order to form larger groups.

At regular intervals, slave replicas contact their coordinator to ensure that the coordinator is still the master of the slave's group. If a failure occurs, the replica considers itself in error and performs error recovery as described above.

Replication commences once a group contains a majority of replicas. A majority is necessary to avoid the possibility of network partitioning, in which two groups of replicas form that cannot communicate and whose database contents diverge. With respect to IceStorm, a consequence of requiring a majority is that a minimum of three replicas are necessary.

An exception to the majority rule is made during full system startup (i.e., when no replica is currently running). In this situation, replication can only commence with the participation of every replica in the group. This requirement guarantees that the databases of all replicas are synchronized, and avoids the risk that the database of an offline replica might contain more recent information.

Once a majority group has been formed, all database states are compared. The most recent database state (as determined by comparing a time stamp recorded upon each database change) is transferred to all replicas and replication commences. IceStorm is now available for use.

### IceStorm Replica States

IceStorm replicas can have one of four states:

- **Inactive:**  
The node is inactive and awaiting an election.
- **Election:**  
The node is electing a coordinator.
- **Reorganization:**  
The replica group is reorganizing.
- **Normal:**  
The replica group is active and replicating.

For debugging purposes, you can obtain the state of the replicas using the `replica` command of the `icestormadmin` utility, as shown below:

```

$ icestormadmin --Ice.Config=config
>>> replica
replica count: 3
1: id: 1
1: coord: 3
1: group name: 3:191131CC-703A-41D6-8B80-D19F0D5F0410
1: state: normal
1: group:
1: max: 3
2: id: 2
2: coord: 3
2: group name: 3:191131CC-703A-41D6-8B80-D19F0D5F0410
2: state: normal
2: group:
2: max: 3
3: id: 3
3: coord: 3
3: group name: 3:191131CC-703A-41D6-8B80-D19F0D5F0410
3: state: normal
3: group: 1,2
3: max: 3

```

Each line begins with the identifier of the replica. The command displays the following information:

- `id`  
The identifier of the replica.
- `coord`  
The identifier of the group's coordinator.
- `group name`  
The name of the group to which this replica belongs.
- `state`  
The replica's current state.
- `group`  
The identifiers of the other replicas in the group. Note that only the coordinator knows, or cares about, this information.
- `max`  
The maximum number of replicas seen by this replica. This value is used during startup to determine whether full participation is necessary. If the value is less than the total number of replicas, full participation is required.

## Client Considerations for IceStorm Replication

As previously noted, an individual IceStorm replica can be in one of several states. However, IceStorm clients have a different perspective in which the replication group as a whole is in one of the states shown below:

- `Down`  
All requests to IceStorm fail.
- `Inactive`  
All requests to IceStorm block until the replica is either down (in which case the request fails), or becomes Active.

- Active  
Requests are processed.

It is also possible, but highly unlikely, for a request to result in an `Ice::UnknownException`. This can happen, for example, if a replica loses the majority and thus progresses to the inactive state during request processing. In this case, the result of the request is indeterminate (the request may or may not have succeeded) and therefore the IceStorm client can draw no conclusion. The client should retry the request and be prepared for the request to fail. Consider this example:

```
C++
```

```
TopicPrx topic = ...;
Ice::ObjectPrx sub = ...;
IceStorm::QoS qos;
topic->subscribeAndGetPublisher(qos, sub);
```

The call to `subscribeAndGetPublisher` may fail in very rare cases with an `UnknownException`, indicating that the subscription may or may not have succeeded. Here is the proper way to deal with the possibility of an `UnknownException`:

```
C++
```

```
TopicPrx topic = ...;
Ice::ObjectPrx sub = ...;
IceStorm::QoS qos;
while(true) {
 try {
 topic->subscriberAndGetPublisher(qos, sub);
 } catch(const Ice::UnknownException&) {
 continue;
 } catch(const IceStorm::AlreadySubscribed&) {
 // Expected.
 }
 break;
}
```

## Subscriber Considerations for IceStorm Replication

Subscribers can receive events from any replica. The subscriber will stop receiving events under two circumstances:

- The subscriber is unsubscribed by calling `Topic::unsubscribe`.
- The subscriber is removed as a result of a failure to deliver events. Subscribers can optionally configure a [quality of service](#) parameter that causes IceStorm to make additional delivery attempts.

## Publisher Considerations for IceStorm Replication

A publisher for HA IceStorm typically receives a proxy containing multiple endpoints. With this proxy, the publisher normally binds to a single replica and continues using that replica unless there is a failure, or until [active connection management](#) (ACM) closes the connection.

As with non-HA IceStorm, [event delivery ordering](#) can be guaranteed if the subscriber and publisher are suitably configured and the publisher continues to use the same replica when publishing events.

Ordering guarantees are lost as soon as a publisher changes to a different replica. Furthermore, a publisher may receive no notification that a change has occurred, which is possible under two circumstances:

- ACM has closed the connection.
- Publishing to a replica fails and the Ice invocation can be [retried](#), in which case the Ice run time in the publisher automatically and transparently attempts to send the request to another replica. The publisher receives an exception if the invocation cannot be retried.

A publisher has two ways of ensuring that it is notified about a change in replicas:

- The simplest method is to use the `Topic::getNonReplicatedPublisher` operation. The proxy returned by this operation points directly at the current replica and no transparent failover to a different can occur.
- If you never want transparent failover to occur during publishing, you can [configure your publisher proxy](#) so that it contains only one endpoint. In this configuration, the `Topic::getPublisher` operation behaves exactly like `getNonReplicatedPublisher`.

Of the two strategies, using `getNonReplicatedPublisher` is preferable for two reasons:

- It does not involve changes to IceStorm's configuration.
- It is still possible to obtain a replicated publisher proxy by calling `getPublisher`, whereas if you had used the second strategy you would have eliminated that possibility.

The second strategy may be necessary in certain circumstances, such as when an existing IceStorm application is deployed and cannot be changed.

Regardless of the strategy you choose, a publisher can recover from the failure of a replica by requesting another proxy from the replicated topic using `getPublisher` or `getNonReplicatedPublisher`.

#### See Also

- [IceStorm Administration](#)
- [IceStorm Quality of Service](#)
- [Active Connection Management](#)
- [IceStorm Delivery Modes](#)
- [Automatic Retries](#)
- [Configuring IceStorm](#)

#### References

1. Garcia-Molina, H. 1982. [Elections in a Distributed Computing System](#). *IEEE Transactions on Computers* 31 (1): 48-59.

## IceStorm Administration

The IceStorm administration tool is a command-line program that provides administrative control of an IceStorm server. The tool requires that the `IceStormAdmin.TopicManager.Default` property be defined, as in the IceStorm server configuration.

The following command-line options are supported:

```
$ icestormadmin -h
Usage: icestormadmin [options] [file...]
Options:
-h, --help Show this message.
-v, --version Display the Ice version.
-e COMMANDS Execute COMMANDS.
-d, --debug Print debug messages.
```

If one or more `-e` options are specified, the tool executes the given commands and exits, otherwise the tool enters an interactive session. The `help` command displays the following usage information:

- `help`  
Print this message.
- `exit`, `quit`  
Exit this program.
- `create TOPICS`  
Add *TOPICS*.
- `destroy TOPICS`  
Remove *TOPICS*.
- `link FROM TO [COST]`  
Link *FROM* to *TO* with the optional *COST*.
- `unlink FROM TO`  
Unlink *TO* from *FROM*.
- `links [INSTANCE-NAME]`  
Without an argument, `links` displays the links of all topics in the current topic manager. You can specify a different topic manager by providing its instance name.
- `topics [INSTANCE-NAME]`  
Without an argument, `topics` displays the names of all topics in the current topic manager. You can specify a different topic manager by providing its instance name.
- `current [INSTANCE-NAME]`  
Set the current topic manager to the topic manager with instance name *INSTANCE-NAME*. The proxy of the corresponding topic manager must be specified by setting an `IceStormAdmin.TopicManager.name` property. Without an argument, the command shows the current topic manager.
- `replica [INSTANCE-NAME]`  
Display replication information for the given *INSTANCE-NAME*.
- `subscribers TOPICS`  
Displays the identities of the subscribers for each of the *TOPICS*.

Some of the commands accept one or more topic names (*TOPICS*) as arguments. Topic names containing white space or matching a command keyword must be enclosed in single or double quotes.



By default, `icestormadmin` uses the topic manager specified by the setting of the `IceStormAdmin.TopicManager.Default` property, which specifies the proxy for the topic manager. For example, without additional arguments, the `create` command operates on that topic manager.

If you are using multiple topic managers, you can specify the proxies by setting the property `IceStormAdmin.TopicManager.name` for each topic manager. For example:

```
IceStormAdmin.TopicManager.A=A/TopicManager:tcp -h x -p 9995
IceStormAdmin.TopicManager.B=Foo/TopicManager:tcp -h x -p 9996
IceStormAdmin.TopicManager.C=Bar/TopicManager:tcp -h z -p 9995
```

This sets the proxies for three topic managers. Note that `name` need not match the instance name of the corresponding topic manager — `name` simply serves as a tag. With these property settings, the `icestormadmin` commands that accept a topic can now specify a topic manager other than the default topic manager that is configured with `IceStormAdmin.TopicManager.Default`. For example:

```
current Foo
create myTopic
create Bar/myOtherTopic
```

This sets the current topic manager to the one with instance name `Foo`; the first `create` command then creates the topic within that topic manager, whereas the second `create` command uses the topic manager with instance name `Bar`.

#### See Also

- [Configuring IceStorm](#)
- [Highly Available IceStorm](#)
- [IceStorm Properties](#)

## Topic Federation

The ability to link topics together into a federation provides IceStorm applications with a lot of flexibility, while the notion of a "cost" associated with links allows applications to restrict the flow of messages in creative ways. IceStorm applications have complete control of topic federation using the `TopicManager` interface described in the online [XREF Slice API Reference](#), allowing links to be created and removed dynamically as necessary. For many applications, however, the topic graph is static and therefore can be configured using the [administrative tool](#).

On this page:

- [IceStorm Message Propagation](#)
- [Using Cost to Limit Message Propagation](#)
  - [Request Context for Cost](#)
  - [Publishing a Message with a Cost](#)
  - [Receiving a Message with a Cost](#)
- [Automating IceStorm Federation](#)
  - [Administration Tool Script](#)
- [Proxy Considerations for IceStorm Federation](#)

## IceStorm Message Propagation

IceStorm messages are never propagated over more than one link. For example, consider the topic graph shown below:

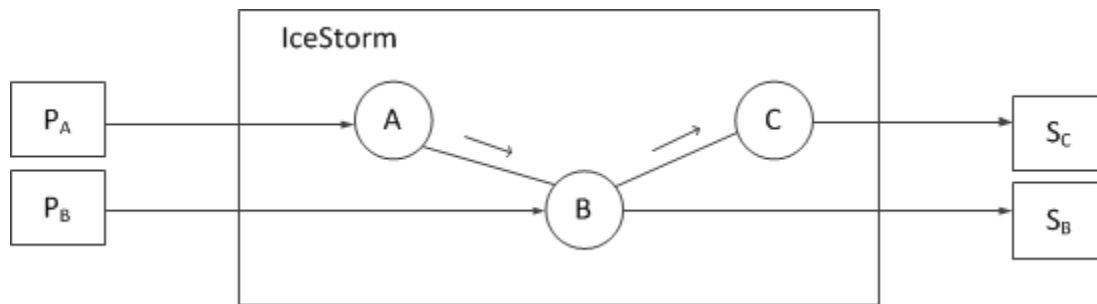

*Message propagation.*

In this case, messages published on A are propagated to B, but B does not propagate A's messages to C. Therefore, subscriber  $S_B$  receives messages published on topics A and B, but subscriber  $S_C$  only receives messages published on topics B and C. If the application needs messages to propagate from A to C, then a link must be established directly between A and C.

## Using Cost to Limit Message Propagation

As described above, IceStorm messages are only propagated on the originating topic's immediate links. In addition, applications can use the notion of cost to further restrict message propagation.

A cost is associated with messages and links. When a message is published on a topic, the topic compares the cost associated with each of its links against the message cost, and only propagates the message on those links whose cost equals or exceeds the message cost. A cost value of zero (0) has the following implications:

- messages with a cost value of zero (0) are published on all of the topic's links regardless of the link cost;
- links with a cost value of zero (0) accept all messages regardless of the message cost.

For example, consider the following topic graph:

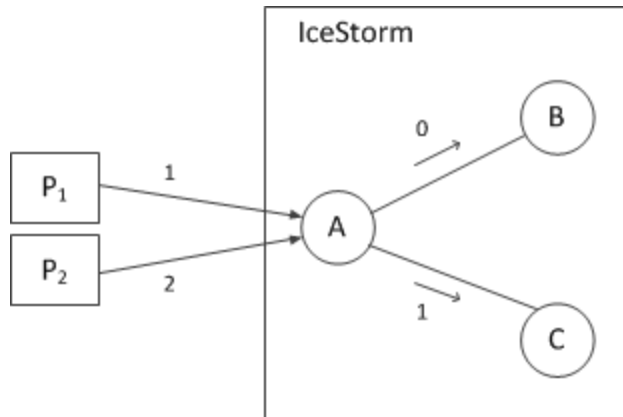

*Cost semantics.*

Publisher  $P_1$  publishes a message on topic A with a cost of 1. This message is propagated on the link to topic B because the link has a cost of 0 and therefore accepts all messages. The message is also propagated on the link to topic C, because the message cost does not exceed the link cost (1). On the other hand, the message published by  $P_2$  with a cost of 2 is only propagated on the link to B.

### Request Context for Cost

The cost of a message is specified in an Ice [request context](#). Each Ice proxy operation has an implicit argument of type `Ice::Context` representing the request context. This argument is rarely used, but it is the ideal location for specifying the cost of an IceStorm message because an application only needs to supply a request context if it actually uses IceStorm's cost feature. If the request context does not contain a cost value, the message is assigned the default cost value of zero (0).

### Publishing a Message with a Cost

The code examples below demonstrate how a collector can publish a measurement with a cost value of 5. First, the C++ version:

```

C++

Measurement m = getMeasurement();
Ice::Context ctx;
ctx["cost"] = "5";
monitor->report(m, ctx);

```

And here is the equivalent version in Java:

```

Java

Measurement m = getMeasurement();
java.util.HashMap ctx = new java.util.HashMap();
ctx.put("cost", "5");
monitor.report(m, ctx);

```

### Receiving a Message with a Cost

A subscriber can discover the cost of a message by examining the request context supplied in the `Ice::Current` argument. For example, here is a C++ implementation of `Monitor::report` that displays the cost value if it is present:

**C++**

```

virtual void report(const Measurement& m,
const Ice::Current& curr) {
 Ice::Context::const_iterator p = curr.ctx.find("cost");
 cout << "Measurement report:" << endl
 << " Tower: " << m.tower << endl
 << " W Spd: " << m.windSpeed << endl
 << " W Dir: " << m.windDirection << endl
 << " Temp: " << m.temperature << endl
 << " Temp: " << m.temperature << endl;
 if (p != curr.ctx.end())
 cout << " Cost: " << p->second << endl;
 cout << endl;
}

```

And here is the equivalent Java implementation:

**Java**

```

public void report(Measurement m, Ice.Current curr) {
 String cost = null;
 if (curr.ctx != null)
 cost = curr.ctx.get("cost");
 System.out.println(
 "Measurement report:\n" +
 " Tower: " + m.tower + "\n" +
 " W Spd: " + m.windSpeed + "\n" +
 " W Dir: " + m.windDirection + "\n" +
 " Temp: " + m.temperature);
 if (cost != null)
 System.out.println(" Cost: " + cost);
 System.out.println();
}

```

For the sake of efficiency, the Ice for Java run time may supply a null value for the request context in `Ice.Current`, therefore an application is required to check for null before using the request context.

## Automating IceStorm Federation

Given the restrictions on message propagation described in the previous sections, creating a complex topic graph can be a tedious endeavor. Of course, creating a topic graph is not typically a common occurrence, since IceStorm keeps a persistent record of the graph. However, there are situations where an automated procedure for creating a topic graph can be valuable, such as during development when the graph might change significantly and often, or when graphs need to be recomputed based on changing costs.

### Administration Tool Script

A simple way to automate the creation of a topic graph is to create a text file containing commands to be executed by the IceStorm administration tool. For example, the commands to create the topic graph shown [earlier](#) are shown below:

```
create A B C
link A B 0
link A C 1
```

If we store these commands in the file `graph.txt`, we can execute them using the following command:

```
$ icestormadmin --Ice.Config=config graph.txt
```

We assume that the configuration file `config` contains the definition for the property `IceStormAdmin.TopicManager.Default`.

## Proxy Considerations for IceStorm Federation

Note that, if you federate IceStorm servers, you must ensure that the proxies for the linked topics always use the same host and port (or, alternatively, can be indirectly bound via [IceGrid](#)), otherwise the federation cannot be re-established if one of the servers in the federation shuts down and is restarted later.

### See Also

- [IceStorm Administration](#)
- [Request Contexts](#)
- [The Current Object](#)
- [IceStorm Properties](#)
- [IceGrid](#)

## IceStorm Quality of Service

An IceStorm subscriber specifies Quality of Service (QoS) parameters at the time of subscription. The supported QoS parameters are described in the sections below

On this page:

- [Reliability QoS for IceStorm](#)
- [Retry Count QoS for IceStorm](#)
- [IceStorm QoS Example](#)

### Reliability QoS for IceStorm

The QoS parameter `reliability` affects message delivery. The only legal values at this point are `ordered` and the empty string. If not specified, the default value is the empty string (meaning not ordered).

The `ordered` reliability QoS requires a twoway subscriber proxy. If you specify this reliability QoS, IceStorm will forward events in the order they are received but doesn't forward them immediately. Instead, IceStorm waits for the reply from the forwarding of an event before forwarding the next event. This guarantees that the subscriber will process the events in the same order as they were received even if its `threading model` doesn't serialize incoming requests.

### Retry Count QoS for IceStorm

IceStorm automatically removes a subscriber if `ObjectNotExistException` or `NotRegisteredException` is raised while attempting to deliver an event. IceStorm considers these exceptions as indicators of a hard failure, after which it is unnecessary to continue event delivery.

For other kinds of failures, IceStorm uses the QoS parameter `retryCount` to determine when to remove a subscriber. A value of `-1` means IceStorm retries forever and never automatically removes a subscriber unless a hard failure occurs. A value of zero means IceStorm never retries and immediately removes the subscriber. For positive values, IceStorm decrements the subscriber's retry count for each failure and removes the subscriber once it reaches zero. Linked topics always have a configured retry count of `-1`. The default value of the `retryCount` parameter is zero.

A retry count of `-1` adds some resiliency to your IceStorm application by ignoring intermittent network failures such as `ConnectionRefusedException`. However, there is also some risk inherent in using a retry count of `-1` because an improperly configured subscriber may never be removed. For example, consider what happens when a subscriber registers using a transient endpoint: if that subscriber happens to terminate and resubscribe with a different endpoint, IceStorm will continue trying to deliver events to the subscriber at its old endpoint. IceStorm can only remove the subscriber if it receives a hard error, and that is only possible when the subscriber is reachable.

To use a retry count of `-1` successfully, the subscriber should either register with a fixed endpoint, or use `IceGrid` to take advantage of indirect proxies and automatic activation. Furthermore, if the subscriber is expected to function correctly after a restart of its process, the subscriber must use the same `identity`. The application can rely on the `subscribeAndGetPublisher` operation to raise `AlreadySubscribed` when the subscriber is already subscribed.

### IceStorm QoS Example

The Slice type `IceStorm::QoS` is defined as a dictionary whose key and value types are both `string`, therefore the QoS parameter name and value are both represented as strings. The code we presented in our earlier [subscriber example](#) used an empty dictionary for the QoS argument, meaning default values are used. The C++ and Java examples shown below illustrate how to set the `reliability` parameter to `ordered`.

Here is the C++ example:

**C++**

```
IceStorm::QoS qos;
qos["reliability"] = "ordered";
topic->subscribeAndGetPublisher(qos, proxy->ice_twoway());
```

Here is the Java example:

**Java**

```
java.util.Map qos = new java.util.HashMap();
qos.put("reliability", "ordered");
topic.subscribeAndGetPublisher(qos, proxy.ice_twoway());
```

**See Also**

- [IceGrid](#)
- [Implementing an IceStorm Subscriber](#)
- [IceStorm Delivery Modes](#)
- [Object Identity](#)

## IceStorm Delivery Modes

The delivery mode for events sent to subscribers is controlled by the proxy that the subscriber passes to IceStorm. For example, if the subscriber subscribes with a oneway proxy, events will be forwarded by IceStorm as oneway messages.

On this page:

- [Subscribing with a Twoway Proxy](#)
- [Subscribing with a Oneway Proxy](#)
- [Subscribing with a Batch Oneway Proxy](#)
- [Subscribing with a Datagram Proxy](#)
- [Subscribing with a Batch Datagram Proxy](#)

### Subscribing with a Twoway Proxy

In this mode each event is sent to the subscriber as a separate twoway message. This allows the subscriber to enable server-side [active connection management](#) (ACM) without risking lost messages, because IceStorm will re-send an event if the subscriber happens to close its connection at the wrong moment.

If you combine a twoway proxy with a [reliability QoS](#) of `ordered`, messages will be forwarded to the subscriber in the order in which they are received. This is guaranteed because IceStorm will wait for a reply from the subscriber for each event before sending the next event.

Without ordered delivery, events may be delivered out-of-order to the subscriber because IceStorm will send an event as soon as possible (without waiting for a reply for the preceding event). If the subscriber uses a thread pool with more than one thread, this can result in out-of-order dispatch of messages in the subscriber.

For single-threaded subscribers and subscribers using a [serialized thread pool](#), twoway delivery always produces in-order dispatch of events in the subscriber.

With twoway delivery, IceStorm is informed of any failure to deliver an event by the Ice run time. For example, IceStorm may not be able to establish a connection to a subscriber, or may receive an `ObjectNotExistException` when it forwards an event. Any failure to deliver an event to a subscriber (possibly after a transparent retry by the Ice run time) results in the cancellation of the corresponding subscription.

### Subscribing with a Oneway Proxy

In this mode each event is sent to the subscriber as a [oneway message](#). If more than one event is ready to be delivered, the events are sent in a single batch. This delivery mode is more efficient than using twoway delivery. However, the subscriber cannot use active connection management without the risk of events being lost. In addition, if something goes wrong with the subscriber, such as the subscriber having destroyed its callback object without unsubscribing, or having subscribed an object with the wrong interface, IceStorm does not notice the failure and will continue to send events to the non-existent subscriber object for as long as it can maintain a connection to the subscriber's endpoint.

For multi-threaded subscribers, oneway delivery can result in out-of-order delivery of events. For single-threaded subscribers and subscribers using a serialized thread pool, events are delivered in order.

### Subscribing with a Batch Oneway Proxy

With this delivery mode, IceStorm buffers events from publishers and sends them in [batches](#) to the subscriber. This reduces network overhead and is more efficient than oneway delivery. However, as for oneway delivery, the subscriber cannot use active connection management without the risk of losing events. In addition, events can be delivered out of order if the subscriber is multi-threaded. Batch oneway delivery, while providing better throughput, increases latency because events arrive in "bursts". You can control the interval at which batched events are flushed by setting the `IceStorm.Flush.Timeout` property.

### Subscribing with a Datagram Proxy



With this delivery mode, events are forwarded as UDP messages, optionally with multicast semantics. This means that events can be delivered out of order, can be lost, and can even be duplicated. In addition, IceStorm cannot detect anything about the delivery status of events. This means that if a subscriber disappears without unsubscribing, IceStorm will attempt to forward events to the subscriber indefinitely. If you use datagram delivery, you need to be careful that subscribers unsubscribe before they disappear; otherwise, stale subscriptions can accumulate in IceStorm over time, bogging down the service as it delivers more and more events to subscribers that no longer exist.

## Subscribing with a Batch Datagram Proxy

With this delivery mode, events are forwarded as batches within a datagram. The same considerations as for datagram delivery and oneway batched delivery apply here. In addition, keep in mind that, due to the size limit for datagrams, batched datagram delivery makes sense only if events are small. (You should also consider enabling compression with this delivery mode.)

### See Also

- [Active Connection Management](#)
- [Oneway Invocations](#)
- [The Ice Threading Model](#)
- [Batched Invocations](#)
- [IceStorm Properties](#)

## Configuring IceStorm

IceStorm is a relatively lightweight service in that it requires very little configuration and is implemented as an `IceBox` service. The configuration properties supported by IceStorm are described in [IceStorm Properties](#); some of them control diagnostic output and are not discussed here.

On this page:

- [IceStorm Property Prefix](#)
- [IceStorm Server Configuration](#)
- [Deploying IceStorm Replicas](#)
  - [IceGrid Deployment](#)
  - [Manual Deployment](#)
- [IceStorm Client Configuration](#)
- [IceStorm Object Identities](#)

### IceStorm Property Prefix

As you will see in [IceStorm Properties](#), IceStorm uses its `IceBox` service name as the prefix for all of its properties. For example, the property `service.TopicManager.Endpoints` becomes `DemoIceStorm.TopicManager.Endpoints` when IceStorm is configured as the `IceBox` service `DemoIceStorm`.

### IceStorm Server Configuration

The first step is configuring `IceBox` to run the IceStorm service:

```
IceBox.Service.DemoIceStorm=IceStormService,34:createIceStorm --Ice.Config=config.service
```

In this example, the IceStorm service itself is configured by the properties in the `config.service` file, which might look as follows for a non-replicated service:

```
Freeze.DbEnv.DemoIceStorm.DbHome=db
DemoIceStorm.TopicManager.Endpoints=tcp -p 9999
DemoIceStorm.Publish.Endpoints=tcp -p 10000
```

IceStorm uses `Freeze` to manage the service's persistent state, therefore the first property specifies the path name of the `Freeze` database environment directory for the service. Here the directory `db` is used, which must already exist in the current working directory. This property can be omitted when the service is running in [transient mode](#).

The final two properties specify the endpoints used by the IceStorm object adapters; notice that their property names begin with `DemoIceStorm`, matching the service name. The `TopicManager` property specifies the endpoints on which the `TopicManager` and `Topic` objects reside; these endpoints must use a connection-oriented protocol such as TCP or SSL. The `Publish` property specifies the endpoints used by topic [publisher objects](#); using datagram endpoints in this property is possible but carries additional risk.

IceStorm's default [thread pool](#) configuration is sufficient when the service is running on a single CPU machine. On a host with multiple CPUs, you may be able to improve IceStorm's performance by increasing the size of its client-side thread pool using the `Ice.ThreadPool.Client.*` properties, but the optimal number of threads can only be determined with careful benchmarking.

### Deploying IceStorm Replicas

There are two ways of deploying IceStorm in its [highly available](#) (replicated) mode. In both cases, adding another replica requires that all active replicas be stopped while their configurations are updated; it is not possible to add a replica while replication is running.

To remove a replica, stop all replicas and alter the configuration as necessary. You must be careful not to remove a replica if it has the latest database state. This situation will never occur during normal operation since the database state of all replicas is identical. However, in the event of a crash it is possible for a coordinator to have later database state than all replicas. The safest approach is to verify that all replicas are active prior to stopping them. You can do this using the `icestormadmin` utility by checking that all replicas are in the `Normal` state.

## IceGrid Deployment

`IceGrid` is a convenient way of deploying `IceStorm` replicas. The term *replica* is also used in the context of `IceGrid`, specifically when referring to groups of object adapters that participate in [replication](#). It is important to be aware of the distinction between `IceStorm` replication and object adapter replication; `IceStorm` replication uses object adapter replication when deployed with `IceGrid`, but `IceStorm` does not *require* object adapter replication as you will see below.

An `IceGrid` deployment typically uses two adapter replica groups: one for the publisher proxies, and another for the topics, as shown below:

```

XML

<replica-group id="DemoIceStorm-PublishReplicaGroup">
</replica-group>

<replica-group id="DemoIceStorm-TopicManagerReplicaGroup">
 <object identity="DemoIceStorm/TopicManager"
type="::IceStorm::TopicManager"/>
</replica-group>
```

The object adapters are then configured to use these replica groups:

```

XML

<adapter name="{service}.Publish"
 endpoints="tcp"
 replica-group="{instance-name}-PublishReplicaGroup"/>

<adapter name="{service}.TopicManager"
 endpoints="tcp"
 replica-group="{instance-name}-TopicManagerReplicaGroup"/>
```

An application may not want [publisher proxies](#) to contain multiple endpoints. In this case you should remove `PublishReplicaGroup` from the above deployment.

The next step is defining the endpoints for the adapter `Node`, which is used internally for communication with other `IceStorm` replicas and is not part of an adapter replica group:

```

XML

<adapter name="{service}.Node" endpoints="tcp"/>
```

Finally, you must define the node ID for each `IceStorm` replica using the `NodeId` property. The node ID must be a non-negative integer:

**XML**

```
<property name="${service}.NodeId" value="${index}"/>
```

**Example**

You can find a complete C++ example of an IceGrid deployment in the directory `demo/IceStorm/replicated`.

**Manual Deployment**

You can also deploy IceStorm replicas without IceGrid, although it requires more manual configuration; an IceGrid deployment is simpler to maintain.

The first step is defining the set of node proxies using properties of the form `Nodes.id`. These proxies allow replicas to contact each other; their object identities are composed using `instance-name/nodeid`.

For example, assuming we are using the IceBox service name `IceStorm` and have three replicas with the identifiers 0, 1, 2 and an instance name of `DemoIceStorm`, we can configure the proxies as shown below:

```
IceStorm.InstanceName=DemoIceStorm
IceStorm.Nodes.0=DemoIceStorm/node0:tcp -p 13000
IceStorm.Nodes.1=DemoIceStorm/node1:tcp -p 13010
IceStorm.Nodes.2=DemoIceStorm/node2:tcp -p 13020
```

These properties must be defined in each replica. Additionally, each replica must define its node ID, as well as the node's endpoints. For example, we can configure node 0 as follows:

```
IceStorm.NodeId=0
IceStorm.Node.Endpoints=tcp -p 13000
```

The endpoints for each replica and ID must match the proxies configured in the `Nodes.id` properties.

Two additional properties allow you to configure replicated endpoints:

- `service-name.ReplicatedTopicManagerEndpoints`  
Defines the endpoints contained in proxies returned by the topic manager.
- `service-name.ReplicatedPublishEndpoints`  
Defines the endpoints contained in the publisher proxy returned by the topic.

For example, suppose we configure three replicas:

```

IceStorm.NodeId=0
IceStorm.TopicManager.Endpoints=tcp -p 10000
IceStorm.Publish.Endpoints=tcp -p 10001:udp -p 10001

IceStorm.NodeId=1
IceStorm.TopicManager.Endpoints=tcp -p 10010
IceStorm.Publish.Endpoints=tcp -p 10011:udp -p 10011

IceStorm.NodeId=2
IceStorm.TopicManager.Endpoints=tcp -p 10020
IceStorm.Publish.Endpoints=tcp -p 10021:udp -p 10021

```

Each replica should also define these properties:

```

IceStorm.ReplicatedPublishEndpoints=\
tcp -p 10001:tcp -p 10011:tcp -p 10021:udp -p 10001:udp -p 10011:udp -p
10021
IceStorm.ReplicatedTopicManagerEndpoints=tcp -p 10000:tcp -p 10010:tcp
-p 10020

```

An application may not want [publisher proxies](#) to contain multiple endpoints. In this case you should remove the definition of the `ReplicatedPublishEndpoints` property from the above deployment.



#### Example

You can find a complete C++ example of a manual deployment in the directory `demo/IceStorm/replicated2`.

## IceStorm Client Configuration

Clients of the service can define a proxy for the `TopicManager` object as follows:

```

TopicManager.Proxy=IceStorm/TopicManager:tcp -p 9999

```

The name of the property is not relevant, but the endpoint must match that of the `service.TopicManager.Endpoints` property, and the object identity must use the IceStorm [instance name](#) as the category and `TopicManager` as the name.

## IceStorm Object Identities

IceStorm hosts one [well-known object](#), which implements the `IceStorm::TopicManager` interface. The default identity of this object is `IceStorm/TopicManager`, as seen in the stringified proxy example above. If an application requires the use of multiple IceStorm services, it is a good idea to assign unique identities to the well-known objects by configuring the services with different values for the `service.InstanceName` property, as shown in the following example:

```

DemoIceStorm.InstanceName=Measurement

```

This property changes the category of the object's identity, which becomes `Measurement/TopicManager`. The client's configuration must also be changed to reflect the new identity:

```
TopicManager.Proxy=Measurement/TopicManager:tcp -p 9999
```

**See Also**

- [IceStorm Properties](#)
- [IceBox](#)
- [Freeze](#)
- [IceGrid](#)
- [The Ice Threading Model](#)
- [Object Adapter Replication](#)
- [IceStorm Administration](#)
- [Using an IceStorm Publisher Object](#)
- [Highly Available IceStorm](#)

## IceStorm Metrics

You can monitor IceStorm using the [Administrative Facility](#) and the [Metrics Facet](#). IceStorm provides two metrics class to monitor topic and subscriber related metrics. These classes are defined in `IceStorm/Metrics.ice` and are shown below.

Slice
<pre>namespace IceMX { class TopicMetrics extends Metrics {     long published = 0;     long forwarded = 0; }; class SubscriberMetrics extends Metrics {     int queued = 0;     int outstanding = 0;     long delivered = 0; }; };</pre>

IceStorm records metrics in the metrics map described below.

Metrics map name	Slice class	Description	Property prefix
Topic	<code>IceMX::TopicMetrics</code>	Topic metrics	<code>IceMX.Metrics.view-name.Map.Topic</code>
Subscriber	<code>IceMX::SubscriberMetrics</code>	Subscriber metrics	<code>IceMX.Metrics.view-name.Map.Subscriber</code>

To configure a metrics view to record IceStorm topic and subscriber you can use for example:

- `IceMX.Metrics.IceStormView.Map.Topic.GroupBy=id`
- `IceMX.Metrics.IceStormView.Map.Subscriber.GroupBy=id`

This will configure a view containing only the `Topic` and `Subscriber` maps. All the topics and subscribers from the IceStorm service will be monitored individually with separate metrics object.

You can use the following attributes when configuring the IceStorm `Topic` map:

Name	Description
id	The id is the topic name.
parent	The IceStorm service name.
none	The empty string.
topic	The topic name.
service	The IceStorm service name.

The `Subscriber` map can be configured with the following attributes:

Name	Description
------	-------------

id	The id of the subscriber metrics is the stringified proxy of the subscriber.
parent	The name of the topic name to which this subscriber belongs.
none	The empty string.
topic	The name of the topic name to which this subscriber belongs.
service	The IceStorm service name.
identity	The identity of the subscriber proxy.
facet	The facet of the subscriber proxy.
encoding	The encoding of the subscriber proxy.
mode	The mode of the subscriber proxy.
proxy	The subscriber proxy.
link	The proxy of the topic linked to the the topic which owns this subscriber.
state	The state of the subscriber. It can either be "online", "offline" or "error".

## See Also

- [Administrative Facility](#)
- [The Metrics Facet](#)
- [IceMX Metrics Properties](#)



# IcePatch2

IcePatch2 is the Ice solution for secure replication of a directory tree.



IcePatch2 supersedes IcePatch, which was a previous version of this service.

IcePatch2 is an efficient file patching service that is easy to configure and use. It includes the following components:

- the IcePatch server (`icepatch2server`)
- a text-based IcePatch client (`icepatch2client`)
- a text-based tool to compress files and calculate checksums (`icepatch2calc`)
- a Slice API and C++ convenience library for developing custom IcePatch2 clients

As with all Ice services, IcePatch2 can be configured to use Ice facilities such as [Glacier2](#) for firewall support and [IceSSL](#) for secure communication.

IcePatch2 is conceptually quite simple. The server is given responsibility for a file system directory (the *data directory*) containing the files and subdirectories that are to be distributed to IcePatch2 clients. You use `icepatch2calc` to compress these files and to generate an index containing a checksum for each file. The server transmits the compressed files to the client, which recreates the data directory and its contents on the client side, patching any files that have changed since the previous run.

IcePatch2 is efficient: transfer rates for files are comparable to what you would get using `ftp`.

IcePatch2 addresses a requirement common to both development and deployment scenarios: the safe, secure, and efficient replication of a directory tree. The IcePatch2 server is easy to configure and efficient. For simple uses, IcePatch2 provides a client that can be used to patch directory hierarchies from the command line. With the C++ utility library, you can also create custom patch clients if you require better integration of the client with your application.

## Topics

- [Using icepatch2calc](#)
- [Running the IcePatch2 Server](#)
- [Running the IcePatch2 Client](#)
- [IcePatch2 Object Identities](#)
- [IcePatch2 Client Utility Library](#)

## Using icepatch2calc

This page describes how to prepare a file set using `icepatch2calc`.

On this page:

- [Preparing a File Set using `icepatch2calc`](#)
- [icepatch2calc Command Line Options](#)

### Preparing a File Set using `icepatch2calc`

Suppose we have the directories and files shown below:

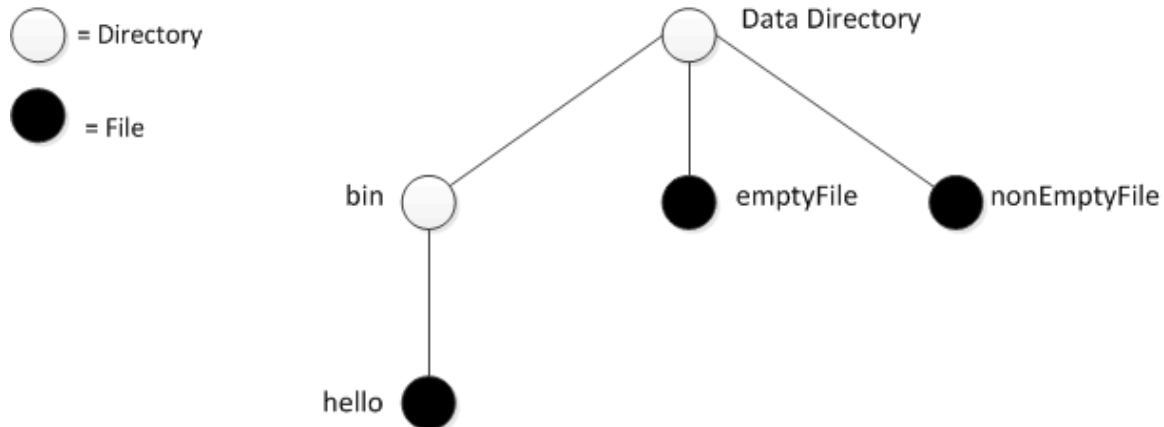

*An example data directory.*

Assume that the file named `emptyFile` is empty (contains zero bytes) and that the remaining files contain data.

To prepare this directory for the transmission by the server, you must first run `icepatch2calc`. (The command shown assumes that the data directory is the current directory.)

```
$ icepatch2calc .
```

After running this command, the contents of the data directory look as follows:

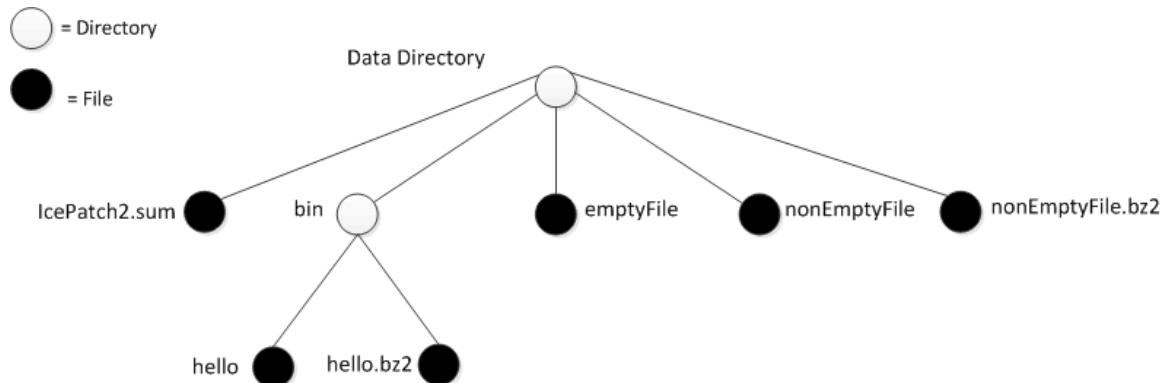

*Contents of the data directory after running `icepatch2calc`.*

Note that `icepatch2calc` compresses the files in the data directory (except for `emptyFile`, which is not compressed). Also note that `icepatch2calc` creates an additional file, `IcePatch2.sum` in the data directory. The contents of this file are as follows:

```
. 3a52ce780950d4d969792a2559cd519d7ee8c727 -1
./bin bd362140a3074eb3edb5e4657561e029092c3d91 -1
./bin/hello 77b11db586a1f20aab8553284241bb3cd532b3d5 70
./emptyFile 082c37fc2641db68d195df83844168f8a464eada 0
./nonEmptyFile aec7301c408e6ce184ae5a34e0ea46e0f0563746 72
```

Each line in the checksum file contains the name of the *uncompressed* file or directory (relative to the data directory), the checksum of the *uncompressed* file, and a byte count. For directories, the count is `-1`; for uncompressed files, the count is `0`; for compressed files, the count is the number of bytes in the *compressed* file. The lines in the file are sorted alphabetically by their pathname.

If you add files or delete files from the data directory or make changes to existing files, you must stop the server, run `icepatch2calc` again to update the `IcePatch2.sum` checksum file, and restart the server.

## icepatch2calc Command Line Options

`icepatch2calc` has the following syntax:

```
icepatch2calc [options] data_dir [file...]
```

Normally, you will run `icepatch2calc` by simply specifying a data directory, in which case the program traverses the data directory, compresses all files, and creates an entry in the checksum file for each file and directory.

You can also nominate specific files or directories on the command line. In this case, `icepatch2calc` only compresses and calculates checksums for the specified files and directories. This is useful if you have a very large file tree and want to refresh the checksum entries for only a few selected files or directories that you have updated. (In this case, the program does not traverse the entire data directory and, therefore, will also not detect any updated, added, or deleted files, except in any of the specified directories.) Any file or directory names you specify on the command line must either be pathnames relative to the data directory or, if you use absolute pathnames, those pathnames must have the data directory as a prefix.

The command supports the following options:

- `-h, --help`  
Displays a help message.
- `-v, --version`  
Displays the version number.
- `-z, --compress`  
Normally, `icepatch2calc` scans the data directory and compresses a file only if no compressed version exists, or if the compressed version of a file has a modification time that predates that of the uncompressed version. If you specify `-z`, the tool re-scans and recompresses the entire data directory, regardless of the time stamps on files. This option is useful if you suspect that time stamps in the data directory may be incorrect.
- `-Z, --no-compress`  
This option allows you to create a client-side checksum file. Do not use this option when creating the checksum file for the server — the option is for creating a client-side `IcePatch2.sum` file for [updates of software on distribution media](#).
- `-i, --case-insensitive`  
This option disallows file names that differ only in case. (An error message will be printed if `icepatch2calc` encounters any files that differ in case only.) This is particularly useful for Unix servers with Windows clients, since Windows folds the case of file names, and therefore such files would override each other on the Windows client.
- `-V, --verbose`

This option prints a progress message for each file that is compressed and for each checksum that is computed.

**See Also**

- [Running the IcePatch2 Client](#)

## Running the IcePatch2 Server

This page describes how to run the IcePatch2 server.

On this page:

- [Starting icepatch2server](#)
- [icepatch2server Command Line Options](#)

### Starting icepatch2server

Once you have run `icepatch2calc` on the data directory, you can start the `icepatch2server`:

```
$ icepatch2server .
```

The server expects the data directory as its single command-line argument. If you omit to specify the data directory, the server uses the setting of the `IcePatch2.Directory` property to determine the data directory.

You must also specify the endpoints at which the server listens for client requests, by setting the `IcePatch2.Endpoints` property.

### icepatch2server Command Line Options

Regardless of whether you run the server under Windows or a Unix-like operating system, it provides the following options:

- `-h, --help`  
Displays a help message.
- `-v, --version`  
Displays a version number.

Additional command line options are supported, including those that allow the server to run as a [Windows service](#) or [Unix daemon](#).

#### See Also

- [The Server-Side main Function in C++](#)

## Running the IcePatch2 Client

This page describes how to use the IcePatch2 client.

On this page:

- [Patching with `icepatch2client`](#)
- [Using `icepatch2client` for Partial Updates](#)
- [Preventing Deletion of Local Files](#)
- [Patching Software Installed from Media](#)
- [Setting Transfer Size for `icepatch2client`](#)
- [icepatch2client Command Line Options](#)

## Patching with `icepatch2client`

Once the `icepatch2server` is running, you can use `icepatch2client` to get a copy of the data directory that is maintained by the server. For example:

```
$ icepatch2client --IcePatch2Client.Proxy="IcePatch2Server/server:tcp -h
somehost.com -p 10000" .
```

The client expects the data directory as its single command-line argument. You must provide a proxy to the IcePatch2 server with the `IcePatch2Client.Proxy` property, as shown above.

If you have not run the client previously, it asks you whether you want to do a thorough patch. You must reply "yes" at this point (or run the client with the `-t` option to perform a [thorough update](#)). The client then executes the following steps:

1. It traverses the local data directory and creates a local `IcePatch2.sum` checksum file.
2. It obtains the relevant list of checksums from the server and compares it to the list of checksums it has built locally:
  - The client deletes each file that appears in the local checksum file but not in the server's file.
  - The client retrieves every file that appears in the server's checksum file, but not in the local checksum file.
  - The client patches every file that, locally, has a checksum that differs from the corresponding checksum on the server side.

When the client finishes, the contents of the data directory on the client side exactly match the contents of the data directory on the server side. However, only the uncompressed files are created on the client side — the server stores the compressed version of the files simply to avoid redundantly compressing a file every time it is retrieved by a client.



On the initial patch, any files that exist in the client's data directory are deleted or, if they have the same name as a file on the server, will be overwritten with the corresponding file as it exists on the server.

## Using `icepatch2client` for Partial Updates

Once you have run the client, the client-side data directory contains an `IcePatch2.sum` file that reflects the contents of the data directory. If you run `icepatch2client` a second time, the program uses the contents of the local checksum file: for each entry in the local checksum file, the client compares the local checksum with the server-side checksum for the same file; if the checksums differ, the client updates the corresponding file. In addition, the client deletes any files that appear in the client's checksum file but not in the server's checksum file, and it fetches any files that appear in the server's checksum file but are missing from the client's checksum file.

If you edit a client-side file and change its contents, `icepatch2client` does *not* realize that this has happened and therefore will not patch the file to be in sync with the version on the server again. This is because the client does not automatically recompute the checksum for a file to see whether the stored checksum in `IcePatch2.sum` still agrees with the actual checksum for the current file contents.

Similarly, if you create an arbitrary file on the client side, but that file is not mentioned in either the client's or the server's checksum file, that file will simply be left alone. In other words, a normal patch operates on the differences between the client's and server's checksum files, not

on any differences that could be detected by examining the contents of the file system.

If you have locally created files that have nothing to do with the distribution or if you have locally modified some files and want to make sure that those modified files are updated to reflect the contents of the same files on the server side, you must run a thorough patch with the `-t` option. This forces the client to traverse the local data directory and recompute the checksum for each file, and then compare these checksums against the server-side ones. As a result, if you edit a file locally so it differs from the server-side version, `-t` forces that file to be updated. Similarly, if you have added a file of your own on the client side that does not have a counterpart on the server side, that file will be deleted by a thorough patch.

## Preventing Deletion of Local Files

By default, a normal patch deletes any files that appear in the client's checksum file but that are absent in the server's checksum file. Similarly, by default, a thorough patch deletes all files in the local data directory that do not appear in the server's checksum file. If you do not want this behavior, you can set the `IcePatch2Client.Remove` property to 0 (the default value is 1). This prevents deletion of files and directories that exist only on the client side, whether the patch is a normal patch or a thorough patch.

## Patching Software Installed from Media

Suppose you distribute your application on a DVD that clients use to install the software. The DVD might be out of date so, after installation, the install script needs to perform a patch to update the application to the latest version. The script can perform a thorough patch to do this but, for large file sets, this is expensive because the client has to recompute the checksum for every file in the distribution.

To avoid this cost, you can place all the files for the distribution into a directory on the server and run `icepatch2calc -Z` on that directory. With the `-Z` option, `icepatch2calc` creates a checksum file with the correct checksums, but with a file size of 0 for each file, that is, the `-Z` option omits compressing the files (and the considerable cost associated with that). Once you have created the new `IcePatch2.sum` file in this way, you can include it on the DVD and install it on the client along with all the other files.

This guarantees that the checksum file on the client is in agreement with the actual files that were just installed and, therefore, it is sufficient for the install script to do a normal patch to update the distribution and so avoid the cost of recomputing the checksum for every file.

## Setting Transfer Size for `icepatch2client`

You can set the `IcePatch2Client.ChunkSize` property to control the number of bytes that the client fetches per request. The default value is 100 kilobytes.

## `icepatch2client` Command Line Options

The client supports the following options:

- `-h, --help`  
Displays a help message.
- `-v, --version`  
Displays a version number.
- `-t, --thorough`  
Do a thorough patch, recomputing all checksums.

### See Also

- [Running the IcePatch2 Server](#)
- [IcePatch2Client Properties](#)

## IcePatch2 Object Identities

An IcePatch2 service hosts one well-known object, which implements the `IcePatch2::FileServer` interface and has the default identity `IcePatch2/server`. If an application requires the use of multiple IcePatch2 services, it is a good idea to assign unique identities to the well-known objects by configuring the services with different values for the `IcePatch2.InstanceName` property, as shown in the following example:

```
$ icepatch2server --IcePatch2.InstanceName=PublicFiles ...
```

This property changes the category of the server object's identity, which becomes `PublicFiles/server`.

### See Also

- [Object Identity](#)
- [IcePatch2 Properties](#)



## IcePatch2 Client Utility Library

IcePatch2 includes a pair of C++ classes that simplify the task of writing your own patch client, along with a Microsoft Foundation Classes (MFC) example that shows how to use these classes. You can find the MFC example in the subdirectory `demo/IcePatch2/MFC` of your Ice distribution.

The remainder of this section discusses the classes. To incorporate them into a custom patch client, your program must include the header file `IcePatch2/ClientUtil.h` and link with the IcePatch2 library.

On this page:

- [Performing a Patch](#)
  - [Constructing a Patcher](#)
  - [Executing the Patch](#)
- [Monitoring Patch Progress](#)

### Performing a Patch

The `Patcher` class encapsulates all of the patching logic required by a client:

**C++**

```

namespace IcePatch2 {
class Patcher : ... {
public:

 Patcher(const Ice::CommunicatorPtr& communicator,
 const PatcherFeedbackPtr& feedback);

 Patcher(const FileServerPrx& server,
 const PatcherFeedbackPtr& feedback,
 const std::string& dataDir, bool thorough,
 Ice::Int chunkSize, Ice::Int remove);

 bool prepare();

 bool patch(const std::string& dir);

 void finish();
};
typedef IceUtil::Handle<Patcher> PatcherPtr;
}

```

### Constructing a Patcher

The constructors provide two ways of configuring a `Patcher` instance. The first form obtains the following [IcePatch2Client configuration properties](#) from the supplied communicator:

- `IcePatch2Client.Proxy`
- `IcePatch2Client.Directory`
- `IcePatch2Client.Thorough`
- `IcePatch2Client.ChunkSize`
- `IcePatch2Client.Remove`

The second constructor accepts arguments that correspond to each of these properties.

Both constructors also accept a `PatcherFeedback` object, which allows the client to [monitor the progress](#) of the patch.

## Executing the Patch

`Patcher` provides three methods that reflect the three stages of a patch:

- `bool prepare()`  
The first stage of a patch includes reading the contents of the checksum file (if present), retrieving the file information from the server, and examining the local data directory to compose the list of files that require updates. The `PatcherFeedback` object is notified incrementally about each local task and has the option of aborting the patch at any time. This method returns true if patch preparation completed successfully, or false if the `PatcherFeedback` object aborted the patch. If an error occurs, `prepare` raises an exception in the form of a `std::string` containing a description of the problem.
- `bool patch(const std::string& dir)`  
The second stage of a patch updates the files in the local data directory. If the `dir` argument is an empty string or `""`, `patch` updates the entire data directory. Otherwise, `patch` updates only those files whose path names begin with the path in `dir`. For each file requiring an update, `Patcher` downloads its compressed data from the server and writes it to the local data directory. The `PatcherFeedback` object is notified about the progress of each file and, as in the preparation stage, may abort the patch if necessary. This method returns true if patching completed successfully, or false if the `PatcherFeedback` object aborted the patch. If an error occurs, `patch` raises an exception in the form of a `std::string` containing a description of the problem.
- `void finish()`  
The final stage of a patch writes a new checksum file to the local data directory. If an error occurs, `finish` raises an exception in the form of a `std::string` containing a description of the problem.

The code below demonstrates a simple patch client:

```

C++

#include <IcePatch2/ClientUtil.h>
...
Ice::CommunicatorPtr communicator = ...;
IcePatch2::PatcherFeedbackPtr feedback = new MyPatcherFeedbackI;
IcePatch2::PatcherPtr patcher =
 new IcePatch2::Patcher(communicator, feedback);

try {
 bool aborted = !patcher->prepare();
 if(!aborted)
 aborted = !patcher->patch("");
 if(!aborted)
 patcher->finish();
 if(aborted)
 cerr << "Patch aborted" << endl;
} catch(const string& reason) {
 cerr << "Patch error: " << reason << endl;
}

```

For a more sophisticated example, see `demo/IcePatch2/MFC` in your Ice distribution.

## Monitoring Patch Progress

The class `PatcherFeedback` is an abstract base class that allows you to monitor the progress of a `Patcher` object. The class declaration is shown below:

```

C++

namespace IcePatch2 {
class PatcherFeedback : ... {
public:

 virtual bool noFileSummary(const std::string& reason) = 0;

 virtual bool checksumStart() = 0;
 virtual bool checksumProgress(const std::string& path) = 0;
 virtual bool checksumEnd() = 0;

 virtual bool fileListStart() = 0;
 virtual bool fileListProgress(Ice::Int percent) = 0;
 virtual bool fileListEnd() = 0;

 virtual bool patchStart(
 const std::string& path, Ice::Long size,
 Ice::Long updated, Ice::Long total) = 0;
 virtual bool patchProgress(
 Ice::Long pos, Ice::Long size,
 Ice::Long updated, Ice::Long total) = 0;
 virtual bool patchEnd() = 0;
};
typedef IceUtil::Handle<PatcherFeedback> PatcherFeedbackPtr;
}

```

Each of these methods returns a boolean value:

- true allows `Patcher` to continue
- false directs `Patcher` to abort the patch.

The methods are described below.

- `bool noFileSummary(const std::string& reason)`  
 Invoked when the local checksum file cannot be found. Returning true initiates a thorough patch, while returning false causes `Patcher::prepare` to return false.
- `bool checksumStart()`  
`bool checksumProgress(const std::string& path)`  
`bool checksumEnd()`  
 Invoked by `Patcher::prepare` during a thorough patch. The `checksumProgress` method is invoked as each file's checksum is being computed.
- `bool fileListStart()`  
`bool fileListProgress(Ice::Int percent)`  
`bool fileListEnd()`  
 Invoked by `Patcher::prepare` when collecting the list of files to be updated. The `percent` argument to `fileListProgress` indicates how much of the collection process has completed so far.
- `bool patchStart(const std::string& path, Ice::Long size, Ice::Long updated, Ice::Long total)`

```
bool patchProgress(Ice::Long pos, Ice::Long size, Ice::Long updated, Ice::Long total)
bool patchEnd()
```

For each file that requires updating, `Patcher::patch` invokes `patchStart` to indicate the beginning of the patch, `patchProgress` one or more times as chunks of the file are downloaded and written, and finally `patchEnd` to signal the completion of the file's patch. The `path` argument supplies the path name of the file, and `size` provides the file's compressed size. The `pos` argument denotes the number of bytes written so far, while `updated` and `total` represent the cumulative number of bytes updated so far and the total number of bytes to be updated, respectively, of the entire patch operation.

**See Also**

- [IcePatch2Client Properties](#)

# Property Reference

This section provides a reference for all properties used by the Ice run time and its services.

Unless stated otherwise in the description of an individual property, its default value is the empty string. If a property takes a numeric value, the empty string is interpreted as zero.

Note that Ice reads properties that control the run time and its services only once on start-up, when you create a communicator. This means that you must set Ice-related properties to their correct values before you create a communicator. If you change the value of an Ice-related property after that point, it is likely that the new setting will simply be ignored.

## Topics

- [Ice Configuration Property](#)
- [Ice Trace Properties](#)
- [Ice Warning Properties](#)
- [Ice Object Adapter Properties](#)
- [Ice Administrative Properties](#)
- [Ice Plug-In Properties](#)
- [Ice Thread Pool Properties](#)
- [Ice Default and Override Properties](#)
- [Ice Proxy Properties](#)
- [Ice Transport Properties](#)
- [Ice Miscellaneous Properties](#)
- [IceSSL Properties](#)
- [IceBox Properties](#)
- [IceBoxAdmin Properties](#)
- [IceGrid Properties](#)
- [IceGrid Administrative Client Properties](#)
- [IceMX Metrics Properties](#)
- [IceStorm Properties](#)
- [Glacier2 Properties](#)
- [Freeze Properties](#)
- [IcePatch2 Properties](#)
- [IcePatch2Client Properties](#)

# Ice Configuration Property

## Ice.Config

### Synopsis

```
--Ice.Config
--Ice.Config=1
--Ice.Config=config_file[,config_file,...]
```

### Description

This property must be set from the command line with one of the options `--Ice.Config`, `--Ice.Config=1`, or `--Ice.Config=config_file`.

If the `Ice.Config` property is empty or set to 1, the Ice run time examines the contents of the `ICE_CONFIG` environment variable to retrieve the path names of one or more configuration files. Otherwise, `Ice.Config` must be set to the path names of one or more configuration files, separated by commas. (Path names can be relative or absolute.) Further property values are read from the configuration files thus specified.

In Java, Ice first attempts to open a configuration file as a [class loader resource](#). If that attempt fails, Ice opens the configuration file in the local file system.

Configuration files use a simple [syntax](#) consisting of `name=value` pairs with support for comments and escaping.

### See Also

- [Using Configuration Files](#)
- [Configuration File Syntax](#)
- [Alternate Property Stores](#)

## Ice Trace Properties

On this page:

- [Ice.Trace.Admin.Properties](#)
- [Ice.Trace.GC](#)
- [Ice.Trace.Locator](#)
- [Ice.Trace.Network](#)
- [Ice.Trace.Protocol](#)
- [Ice.Trace.Retry](#)
- [Ice.Trace.Slicing](#)
- [Ice.Trace.ThreadPool](#)

### Ice.Trace.Admin.Properties

#### Synopsis

`Ice.Trace.Admin.Properties=num`

#### Description

Controls the trace level for property updates made via the [Properties](#) facet:

0	No property trace (default).
1	Trace property addition, modification, and removal.

### Ice.Trace.GC

#### Synopsis

`Ice.Trace.GC=num`

#### Description

Ice for C++ includes a [garbage collector](#) for Slice objects. This property controls the trace level for the garbage collector:

0	No garbage collector trace (default).
1	Show the total number of instances collected, the total number of instances examined, the time spent in the collector in milliseconds, and the total number of runs of the collector.
2	Like 1, but also produces a trace message for each run of the collector.

### Ice.Trace.Locator

#### Synopsis

`Ice.Trace.Locator=num`

#### Description

The Ice run time makes [locator](#) requests to resolve the endpoints of object adapters and well-known objects. Requests on the locator registry are used to update object adapter endpoints and set the server process proxy. This property controls the trace level for the Ice run time's interactions with the locator:

0	No locator trace (default).
1	Trace Ice locator and locator registry requests.
2	Like 1, but also trace the removal of endpoints from the cache.

## Ice.Trace.Network

### Synopsis

`Ice.Trace.Network=num`

### Description

Controls the trace level for low-level network activities such as connection establishment and read/write operations:

0	No network trace (default).
1	Trace successful connection establishment and closure.
2	Like 1, but also trace attempts to bind, connect, and disconnect sockets.
3	Like 2, but also trace data transfer, the <a href="#">published endpoints</a> for an object adapter, and the current list of local addresses for an endpoint that uses the wildcard address.

## Ice.Trace.Protocol

### Synopsis

`Ice.Trace.Protocol=num`

### Description

Controls the trace level for Ice [protocol](#) messages:

0	No protocol trace (default).
1	Trace Ice protocol messages.

## Ice.Trace.Retry

### Synopsis

`Ice.Trace.Retry=num`

### Description

Ice supports [automatic retries](#) in case of a request failure. This property controls the trace level for retry attempts:

0	No request retry trace (default).
1	Trace Ice operation call retries.
2	Also trace Ice endpoint usage.



## Ice.Trace.Slicing

### Synopsis

`Ice.Trace.Slicing=num`

### Description

The Ice data encoding for [exceptions](#) and [classes](#) enables a receiver to slice an unknown exception or class type to a known type. This property controls the trace level for slicing activities:

0	No trace of slicing activity (default).
1	Trace all exception and class types that are unknown to the receiver and therefore sliced.

## Ice.Trace.ThreadPool

### Synopsis

`Ice.Trace.ThreadPool=num`

### Description

Controls the trace level for the Ice [thread pool](#):

0	No trace of thread pool activity (default).
1	Trace the creation, growing, and shrinking of thread pools.

## Ice Warning Properties

On this page:

- [Ice.Warn.AMICallback](#)
- [Ice.Warn.Connections](#)
- [Ice.Warn.Datagrams](#)
- [Ice.Warn.Dispatch](#)
- [Ice.Warn.Endpoints](#)
- [Ice.Warn.UnknownProperties](#)
- [Ice.Warn.UnusedProperties](#)

### Ice.Warn.AMICallback

#### Synopsis

`Ice.Warn.AMICallback=num`

#### Description

If `num` is set to a value larger than zero, warnings are printed if an AMI callback raises an exception. The default value is 1.

### Ice.Warn.Connections

#### Synopsis

`Ice.Warn.Connections=num`

#### Description

If `num` is set to a value larger than zero, Ice applications print warning messages for certain exceptional conditions in connections. The default value is 0.

### Ice.Warn.Datagrams

#### Synopsis

`Ice.Warn.Datagrams=num`

#### Description

If `num` is set to a value larger than zero, a server prints a warning message if it receives a datagram that exceeds the server's receive buffer size. (Note that this condition is not detected by all UDP implementations — some implementations silently drop received datagrams that are too large.) The default value is 0.

### Ice.Warn.Dispatch

#### Synopsis

`Ice.Warn.Dispatch=num`

#### Description

If `num` is set to a value larger than zero, Ice applications print warning messages for certain exceptions that are raised while an incoming request is dispatched.

Warning levels:

0	No warnings.
1	Print warnings for unexpected <code>Ice::LocalException</code> , <code>Ice::UserException</code> , C++ exceptions, and Java run-time exceptions (default).
2	Like 1, but also issue warnings for <code>Ice::ObjectNotExistException</code> , <code>Ice::FacetNotExistException</code> , and <code>Ice::OperationNotExistException</code> .

## Ice.Warn.Endpoints

### Synopsis

`Ice.Warn.Endpoints=num`

### Description

If `num` is set to a value larger than zero, a warning is printed if a stringified proxy contains an endpoint that cannot be parsed. (For example, stringified proxies containing SSL endpoints cause this warning in versions of Ice that do not support SSL.) The default value is 1.

## Ice.Warn.UnknownProperties

### Synopsis

`Ice.Warn.UnknownProperties=num`

### Description

If `num` is set to a value larger than zero, the Ice run time prints a warning about unknown properties for [object adapters](#) and [proxies](#). The default value is 1.

## Ice.Warn.UnusedProperties

### Synopsis

`Ice.Warn.UnusedProperties=num`

### Description

If `num` is set to a value larger than zero, the Ice run time prints a warning during communicator destruction about properties that were set but not read. This warning is useful for detecting mis-spelled properties, such as `Filesystem.MaxFileSize`. The default value is 0.

## Ice Object Adapter Properties

On this page:

- [adapter.ACM](#)
- [adapter.AdapterId](#)
- [adapter.Endpoints](#)
- [adapter.Locator](#)
- [adapter.ProxyOptions](#)
- [adapter.PublishedEndpoints](#)
- [adapter.ReplicaGroupId](#)
- [adapter.Router](#)
- [adapter.ThreadPool.Serialize](#)
- [adapter.ThreadPool.Size](#)
- [adapter.ThreadPool.SizeMax](#)
- [adapter.ThreadPool.SizeWarn](#)
- [adapter.ThreadPool.StackSize](#)
- [adapter.ThreadPool.ThreadIdleTime](#)
- [adapter.ThreadPool.ThreadPriority](#)

### ***adapter.ACM***

#### **Synopsis**

`adapter.ACM=num`

#### **Description**

If `num` is set to a value larger than zero, [Active Connection Management \(ACM\)](#) is enabled for the adapter, causing it to automatically close incoming connections after they have been idle for `num` seconds. The default value is the setting of `Ice.ACM.Server`.

Note that ACM can cause incoming oneway requests to be silently discarded.

### ***adapter.AdapterId***

#### **Synopsis**

`adapter.AdapterId=id`

#### **Description**

Specifies an identifier for the object adapter with the name `adapter`. This identifier must be unique among all object adapters using the same `locator` instance. If a locator proxy is defined using `adapter.Locator` or `Ice.Default.Locator`, this object adapter sets its endpoints with the locator registry upon activation.

### ***adapter.Endpoints***

#### **Synopsis**

`adapter.Endpoints=endpoints`

#### **Description**

Sets the [endpoints](#) for the object adapter `adapter` to `endpoints`. These endpoints specify the network interfaces on which the object adapter receives requests. Proxies created by the object adapter contain these endpoints, unless the `adapter.PublishedEndpoints` pro

perty is also specified.

## ***adapter.Locator***

### **Synopsis**

```
adapter.Locator=locator
```

### **Description**

Specifies a [locator](#) for the object adapter with the name *adapter*. The value is a stringified proxy to the Ice locator interface.

As a proxy property, you can configure additional [aspects of the proxy](#) using properties.

## ***adapter.ProxyOptions***

### **Synopsis**

```
adapter.ProxyOptions=options
```

### **Description**

Specifies the [proxy options](#) for proxies created by the object adapter. The value is a string representing the proxy options as they would be specified in a stringified proxy. The default value is "-t", that is, proxies created by the object adapter are configured to use twoway invocations by default.

## ***adapter.PublishedEndpoints***

### **Synopsis**

```
adapter.PublishedEndpoints=endpoints
```

### **Description**

When creating a proxy, the object adapter *adapter* normally includes the endpoints defined by *adapter.Endpoints*. If *adapter.PublishedEndpoints* is defined, the object adapter [publishes these endpoints](#) instead. This is useful in many situations, such as when a server resides behind a port-forwarding firewall, in which case the object adapter's public endpoints must specify the address and port of the firewall. The *adapter.ProxyOptions* property also influences the proxies created by an object adapter.

## ***adapter.ReplicaGroupId***

### **Synopsis**

```
adapter.ReplicaGroupId=id
```

### **Description**

Identifies the group of [replicated object adapters](#) to which this adapter belongs. The replica group is treated as a virtual object adapter, so that an indirect proxy of the form *identity@id* refers to the object adapters in the group. During binding, a client will attempt to establish a connection to an endpoint of one of the participating object adapters, and automatically try others until a connection is successfully established or all attempts have failed. Similarly, an outstanding request will, when permitted, automatically fail over to another object adapter of the replica group upon connection failure. The set of endpoints actually used by the client during binding is determined by the locator's configuration policies.

Defining a value for this property has no effect unless `adapter.AdapterId` is also defined. Furthermore, the locator registry may require replica groups to be defined in advance (see `IceGrid.Registry.DynamicRegistration`), otherwise `Ice.NotRegisteredException` is raised upon adapter activation. Regardless of whether an object adapter is replicated, it can always be addressed individually in an indirect proxy if it defines a value for `adapter.AdapterId`.

## **`adapter.Router`**

### **Synopsis**

```
adapter.Router=router
```

### **Description**

Specifies a [router](#) for the object adapter with the name `adapter`. The value is a stringified proxy to the Ice router control interface. Defining a router allows the object adapter to receive callbacks from the router over a [bidirectional connection](#), thereby avoiding the need for the router to establish a connection back to the object adapter.

A router can only be assigned to one object adapter. Specifying the same router for more than one object adapter results in undefined behavior. The default value is no router.

As a proxy property, you can configure additional [aspects of the proxy](#) using properties.

## **`adapter.ThreadPool.Serialize`**

### **Synopsis**

```
adapter.ThreadPool.Serialize=num
```

### **Description**

If `num` is a value greater than zero, the adapter's thread pool serializes all messages from each connection. It is not necessary to enable this feature in a thread pool whose maximum size is one thread. In a [multi-threaded pool](#), enabling serialization allows requests from different connections to be dispatched concurrently while preserving the order of messages on each connection. Note that serialization has a significant impact on latency and throughput. If not defined, the default value is zero.

## **`adapter.ThreadPool.Size`**

### **Synopsis**

```
adapter.ThreadPool.Size=num
```

### **Description**

A communicator creates a default server thread pool that dispatches requests to its object adapters. An object adapter can also be configured with its own [thread pool](#). This is useful in avoiding deadlocks due to thread starvation by ensuring that a minimum number of threads is available for dispatching requests to certain Ice objects.

`num` is the initial number of threads in the thread pool. The default value is zero, meaning that an object adapter by default uses the communicator's server thread pool. See `Ice.ThreadPool.name.Size` for more information.

## **`adapter.ThreadPool.SizeMax`**

### **Synopsis**

`adapter.ThreadPool.SizeMax=num`

### **Description**

`num` is the maximum number of threads for the [thread pool](#). See [Ice.ThreadPool.name.SizeMax](#) for more information.

The default value is the value of `adapter.ThreadPool.Size`, meaning the thread pool can never grow larger than its initial size.

## **`adapter.ThreadPool.SizeWarn`**

### **Synopsis**

`adapter.ThreadPool.SizeWarn=num`

### **Description**

Whenever `num` threads are active in a [thread pool](#), a "low on threads" warning is printed. The default value is zero, which disables the warning.

## **`adapter.ThreadPool.StackSize`**

### **Synopsis**

`adapter.ThreadPool.StackSize=num`

### **Description**

`num` is the stack size (in bytes) of threads in the [thread pool](#). The default value is zero, meaning the operating system's default is used.

## **`adapter.ThreadPool.ThreadIdleTime`**

### **Synopsis**

`adapter.ThreadPool.ThreadIdleTime=num`

### **Description**

In a dynamically-sized [thread pool](#), Ice reaps a thread after it is idle for `num` seconds. Setting this property to zero disables idle thread reaping. If not specified, the default value is 60 seconds. See [Ice.ThreadPool.name.ThreadIdleTime](#) for more information.

## **`adapter.ThreadPool.ThreadPriority`**

### **Synopsis**

`adapter.ThreadPool.ThreadPriority=num`

### **Description**

`num` specifies a thread priority for the object adapter's [thread pool](#). The object adapter creates its threads with the specified priority. Leaving this property unset causes the adapter to create threads with the priority specified by [Ice.ThreadPool.Server.ThreadPriority](#) or, if that property is unset, the priority specified by [Ice.ThreadPriority](#).

## Ice Administrative Properties

On this page:

- [Ice.Admin.AdapterProperty](#)
- [Ice.Admin.DelayCreation](#)
- [Ice.Admin.Facets](#)
- [Ice.Admin.InstanceName](#)
- [Ice.Admin.ServerId](#)

### Ice.Admin.AdapterProperty

#### Synopsis

`Ice.Admin.AdapterProperty=value`

#### Description

The Ice run time creates an [administrative object adapter](#) named `Ice.Admin` if `Ice.Admin.Endpoints` is defined and one of the following are true:

- `Ice.Admin.InstanceName` is defined
- `Ice.Admin.ServerId` and `Ice.Default.Locator` are defined

The purpose of this object adapter is to host an Ice object whose facets provide [administrative capabilities](#) to remote clients. [Adapter properties](#) can be used to configure the `Ice.Admin` object adapter.

Note that enabling the `Ice.Admin` object adapter is a security risk because a hostile client could use the administrative object to shut down the process. As a result, the [endpoints](#) for this object adapter should be carefully defined so that only trusted clients are allowed to use it.

### Ice.Admin.DelayCreation

#### Synopsis

`Ice.Admin.DelayCreation=num`

#### Description

If `num` is a value greater than zero, the Ice run time delays the creation of the [administrative object adapter](#) until `getAdmin` is invoked on the communicator. If not specified, the default value is zero, meaning the object adapter is created immediately after all plug-ins are initialized.

### Ice.Admin.Facets

#### Synopsis

`Ice.Admin.Facets=name [name ...]`

#### Description

Specifies the facets enabled by the [administrative object](#), allowing you to [filter](#) the facets that the administrative object enables by default. Facet names are delimited by commas or white space. A facet name that contains white space must be enclosed in single or double quotes. If not specified, all facets are enabled.

### Ice.Admin.InstanceName

#### Synopsis



`Ice.Admin.InstanceName=name`

### **Description**

Specifies an identity category for the [administrative object](#). If defined, the identity of the object becomes `name/admin`. If not specified, the default identity category is a UUID.

## **Ice.Admin.ServerId**

### **Synopsis**

`Ice.Admin.ServerId=id`

### **Description**

Specifies an identifier that uniquely identifies the process when the `Ice.Admin` object adapter [registers itself with the locator registry](#).

## Ice Plug-In Properties

On this page:

- [Ice.InitPlugins](#)
- [Ice.Plugin.name.cpp](#)
- [Ice.Plugin.name.java](#)
- [Ice.Plugin.name.clr](#)
- [Ice.Plugin.name](#)
- [Ice.PluginLoadOrder](#)

### Ice.InitPlugins

#### Synopsis

```
Ice.InitPlugins=num
```

#### Description

If *num* is a value greater than zero, the Ice run time automatically initializes the plug-ins it has loaded. The order in which plug-ins are loaded and initialized is determined by [Ice.PluginLoadOrder](#). An application may need to set this property to zero in order to [interact directly with a plug-in](#) after it has been loaded but before it is initialized. In this case, the application must invoke `initializePlugins` on the plug-in manager to complete the initialization process. If not defined, the default value is 1.

### Ice.Plugin.name.cpp

#### Synopsis

```
Ice.Plugin.name.cpp=path[,version]:function [args]
```

#### Description

Defines a C++ [plug-in](#) to be installed during communicator initialization. The *path* and optional *version* components are used to construct the path name of a DLL or shared library. If no version is supplied, the Ice version is used. The *function* component is the name of a function with C linkage. For example, the entry point `MyPlugin,35:create` would imply a shared library name of `libMyPlugin.so.35` on Unix and `MyPlugin35.dll` on Windows. Furthermore, if Ice is built on Windows with debugging, a `d` is automatically appended to the version (for example, `MyPlugin35d.dll`).

The function must be declared with external linkage and have the following signature:

C++
<pre>&lt;Plugin&gt;* function(const Ice::CommunicatorPtr&amp; communicator,                     const std::string&amp; name,                     const Ice::StringSeq&amp; args);</pre>

Note that the function must return a pointer and not a smart pointer. The Ice run time deallocates the object when it unloads the library.

Any arguments that follow the entry point are passed to the entry point function. For example:

<pre>Ice.Plugin.MyPlugin.cpp=MyFactory,35:create arg1 arg2</pre>
------------------------------------------------------------------

Whitespace separates the arguments, and any arguments that contain whitespace must be enclosed in quotes.

The *path* component may optionally contain a relative or absolute path name, indicated by the presence of a path separator (/ or \). In this case, the last component of the path is used to construct the version-specific name of the shared library or DLL. Consider this example:

```
Ice.Plugin.MyPlugin.cpp=./MyFactory,35:create arg1 arg2
```

The use of a relative path means the Ice run time will look in the current working directory for `libMyPlugin.so.35` on Unix or `MyPlugin35.dll` on Windows.

If the *path* component contains spaces, the entire entry point must be enclosed in quotes:

```
Ice.Plugin.MyPlugin.cpp="C:\Program Files\MyPlugin\MyFactory,35:create"
arg1 arg2
```

If the *path* component does not include a leading path name, Ice delegates to the operating system to locate the shared library or DLL, which typically means that the plug-in can reside in any of the directories in your shared library or DLL search path.

## Ice.Plugin.name.java

### Synopsis

```
Ice.Plugin.name.java=[path:]class [args]
```

### Description

Defines a Java [plug-in](#) to be installed during communicator initialization. The specified class must implement the `Ice.PluginFactory` interface. Any arguments that follow the class name are passed to the `create` method. For example:

```
Ice.Plugin.MyPlugin.java=MyFactory arg1 arg2
```

Whitespace separates the arguments, and any arguments that contain whitespace must be enclosed in quotes.

If *path* is specified, it may be the path name of a JAR file or class directory, as shown below:

```
Ice.Plugin.MyPlugin.java=MyFactory.jar:MyFactory
Ice.Plugin.MyOtherPlugin.java=/classes:MyOtherFactory
```

If *path* contains spaces, it must be enclosed in quotes:

```
Ice.Plugin.MyPlugin.java="factory classes.jar":MyFactory
```

If *class* is specified without a path, Ice attempts to load the class using [class loaders](#) in a well-defined order.

## Ice.Plugin.name.clr

### Synopsis

```
Ice.Plugin.name.clr=assembly:class [args]
```

### Description

Defines a .NET [plug-in](#) to be installed during communicator initialization. The *assembly* component can be a partially or fully qualified assembly name, such as `myplugin,Version=0.0.0.0,Culture=neutral`, or an assembly DLL name such as `myplugin.dll`, and may optionally include a leading relative or absolute path name.

 You *must* use a fully-qualified assembly name to load a plug-in from an assembly in the Global Assembly Cache.

The specified class must implement the `Ice.PluginFactory` interface. Any arguments that follow the class name are passed to the factory's `create` method. For example:

```
Ice.Plugin.MyPlugin.clr=MyFactory,Version=1.2.3.4,Culture=neutral:MyFactory arg1 arg2
```

Whitespace separates the arguments, and any arguments that contain whitespace must be enclosed in quotes.

If you specify a relative path name in the entry point, the assembly is located relative to the program's current working directory:

```
Ice.Plugin.MyPlugin.clr=..\MyFactory.dll:MyFactory arg1 arg2
```

Enclose the assembly's path name in quotes if it contains spaces:

```
Ice.Plugin.MyPlugin.clr="C:\Program Files\MyPlugin\MyFactory.dll:MyFactory" arg1 arg2
```

Finally, if the assembly uses a leading path name, be sure to include the `.dll` extension.

## Ice.Plugin.name

### Synopsis

```
Ice.Plugin.name=entry_point [args]
```

### Description

Defines a [plug-in](#) to be installed during communicator initialization. The format of *entry\_point* varies by Ice implementation language, therefore this property cannot be defined in a configuration file that is shared by programs in different languages. Ice provides an alternate syntax that facilitates such sharing:

- `Ice.Plugin.name.cpp` for C++
- `Ice.Plugin.name.java` for Java
- `Ice.Plugin.name.clr` for the .NET Common Language Runtime

Refer to the relevant property for your language mapping for details on the entry point syntax.

## Ice.PluginLoadOrder

### Synopsis

`Ice.PluginLoadOrder=names`

**Description**

Determines the order in which [plug-ins](#) are loaded. The Ice run time loads the plug-ins in the order they appear in *names*, where each plug-in name is separated by a comma or white space. Any plug-ins not mentioned in *names* are loaded afterward, in an undefined order.

## Ice Thread Pool Properties

A communicator creates two [thread pools](#): the client thread pool dispatches AMI callbacks and incoming requests on [bidirectional connections](#), and the server thread pool dispatches requests to [object adapters](#).

This page describes configuration properties for the client and server thread pools. These thread pools are named `Client` and `Server`, respectively. In the property descriptions below, replace *name* with `Client` or `Server`.

On this page:

- [Ice.ThreadPool.name.Serialize](#)
- [Ice.ThreadPool.name.Size](#)
- [Ice.ThreadPool.name.SizeMax](#)
- [Ice.ThreadPool.name.SizeWarn](#)
- [Ice.ThreadPool.name.StackSize](#)
- [Ice.ThreadPool.name.ThreadIdleTime](#)
- [Ice.ThreadPool.name.ThreadPriority](#)
- [Ice.ThreadPriority](#)

### Ice.ThreadPool.name.Serialize

#### Synopsis

```
Ice.ThreadPool.name.Serialize=num
```

#### Description

If *num* is a value greater than zero, the `Client` or `Server` [thread pool](#) serializes all messages from each connection. It is not necessary to enable this feature in a thread pool whose maximum size is one thread. In a multi-threaded pool, enabling serialization allows requests from different connections to be dispatched concurrently while preserving the order of messages on each connection. Note that serialization has a significant impact on latency and throughput. If not defined, the default value is zero.

### Ice.ThreadPool.name.Size

#### Synopsis

```
Ice.ThreadPool.name.Size=num
```

#### Description

[Thread pools](#) in Ice can grow and shrink dynamically, based on an average load factor. A thread pool always has at least one thread and may grow as load increases up to the maximum size specified by `Ice.ThreadPool.name.SizeMax`. If `SizeMax` is not specified, Ice uses the value of *num* as the pool's maximum size. The `Client` or `Server` thread pool is initialized with *num* active threads, but the pool may shrink to only one thread during idle periods as determined by `Ice.ThreadPool.name.ThreadIdleTime`.

If not specified, the default value is one for both properties.

An object adapter can also be configured with its own [thread pool](#).

Note that multiple threads for the client thread pool are only required for [nested AMI invocations](#), or to allow multiple AMI callbacks to be dispatched concurrently.

To monitor the thread pool activities of the Ice run time, enable the `Ice.Trace.ThreadPool` property.

### Ice.ThreadPool.name.SizeMax

#### Synopsis

`Ice.ThreadPool.name.SizeMax=num`

### **Description**

`num` is the maximum number of threads for the `Client` or `Server` [thread pool](#). Refer to the `Ice.ThreadPool.name.Size` property for more information on configuring the size of a thread pool.

The default value for `SizeMax` is the value of `Size`, meaning the thread pool can never grow larger than its initial size.

To monitor the thread pool activities of the Ice run time, enable the `Ice.Trace.ThreadPool` property.

## **Ice.ThreadPool.name.SizeWarn**

### **Synopsis**

`Ice.ThreadPool.name.SizeWarn=num`

### **Description**

Whenever `num` threads are active in the `Client` or `Server` [thread pool](#), a "low on threads" warning is printed. The default value is zero, which disables the warning.

To monitor the thread pool activities of the Ice run time, enable the `Ice.Trace.ThreadPool` property.

## **Ice.ThreadPool.name.StackSize**

### **Synopsis**

`Ice.ThreadPool.name.StackSize=num`

### **Description**

`num` is the stack size (in bytes) of threads in the `Client` or `Server` [thread pool](#). The default value is zero, meaning the operating system's default is used.

## **Ice.ThreadPool.name.ThreadIdleTime**

### **Synopsis**

`Ice.ThreadPool.name.ThreadIdleTime=num`

### **Description**

Ice can automatically reap idle threads in the `Client` or `Server` [thread pool](#) to conserve resources. This property specifies the number of seconds a thread must be idle before it is reaped. If not specified, the default value is 60 seconds.

To disable the reaping of idle threads, set `ThreadIdleTime` to zero. In this situation, the thread pool is initialized with `Ice.ThreadPool.name.Size` active threads and may grow to contain `Ice.ThreadPool.name.SizeMax` active threads, but the size of the pool never decreases.

To monitor the thread pool activities of the Ice run time, enable the `Ice.Trace.ThreadPool` property.

## **Ice.ThreadPool.name.ThreadPriority**

**Synopsis**

`Ice.ThreadPool.name.ThreadPriority=num`

**Description**

*num* specifies a thread priority for the threads in the Client or Server [thread pool](#). Leaving this property unset causes the run time to create threads with the default priority specified by [Ice.ThreadPriority](#).

This property is unset by default.

You can also override the default priority for a specific object adapter using [adapter.ThreadPool.ThreadPriority](#).

**Ice.ThreadPriority****Synopsis**

`Ice.ThreadPriority=num`

**Description**

*num* specifies a thread priority. Threads created by the Ice run time are created with the specified priority by default. Leaving this property unset causes the run time to create threads with the system default priority. This property is unset by default.

You can separately override the default priorities for the client and server thread pools using [Ice.ThreadPool.name.ThreadPriority](#) as well as for a specific object adapter using [adapter.ThreadPool.ThreadPriority](#).



## Ice Default and Override Properties

On this page:

- [Ice.Default.CollocationOptimized](#)
- [Ice.Default.EncodingVersion](#)
- [Ice.Default.EndpointSelection](#)
- [Ice.Default.Host](#)
- [Ice.Default.Locator](#)
- [Ice.Default.LocatorCacheTimeout](#)
- [Ice.Default.Package](#)
- [Ice.Default.PreferSecure](#)
- [Ice.Default.Protocol](#)
- [Ice.Default.Router](#)
- [Ice.Default.SlicedFormat](#)
- [Ice.Override.Compress](#)
- [Ice.Override.CloseTimeout](#)
- [Ice.Override.ConnectTimeout](#)
- [Ice.Override.Secure](#)
- [Ice.Override.Timeout](#)

### Ice.Default.CollocationOptimized

#### Synopsis

```
Ice.Default.CollocationOptimized=num
```

#### Description

Specifies whether proxy invocations use [collocation optimization](#) by default. When enabled, proxy invocations on a collocated servant (i.e., a servant whose object adapter was created by the same communicator as the proxy) are made as a direct method call if possible. Collocated invocations are more efficient because they avoid the overhead of marshaling parameters and sending requests over the network.

Collocation optimization is not supported for asynchronous or Dynamic Ice invocations, nor is it supported in Ice for Python.

If not specified, the default value is 1. Set the property to 0 to disable collocation optimization by default.

### Ice.Default.EncodingVersion

#### Synopsis

```
Ice.Default.EncodingVersion=ver
```

#### Description

If this property is not defined, Ice 3.5 uses encoding version 1.1 by default. To force the Ice run time to use encoding version 1.0 as the default instead, set this property to 1.0:

```
Ice.Default.EncodingVersion=1.0
```

### Ice.Default.EndpointSelection

#### Synopsis

```
Ice.Default.EndpointSelection=policy
```

#### Description

This property controls the default [endpoint selection](#) policy for proxies with multiple endpoints. Permissible values are `Ordered` and `Random`. The default value of this property is `Random`.

## Ice.Default.Host

### Synopsis

```
Ice.Default.Host=host
```

### Description

If an endpoint does not specify a host name (i.e., without a `-h host` option), the `host` value from this property is used instead. The property has no default value.

## Ice.Default.Locator

### Synopsis

```
Ice.Default.Locator=locator
```

### Description

Specifies a default [locator](#) for all proxies and object adapters. The value is a stringified proxy for the `IceGrid` locator object. The default locator can be overridden on a proxy using the `ice_locator` [proxy method](#). The default value is no locator.

The default identity of the `IceGrid` locator object is `IceGrid/Locator`, but this identity is influenced by the `IceGrid.InstanceName` property. The locator object is available on the `IceGrid` client endpoints. For example, suppose `IceGrid.Registry.Client.Endpoints` is set as follows:

```
IceGrid.Registry.Client.Endpoints=tcp -p 12000 -h localhost
```

In this case, the stringified proxy for the `IceGrid` locator is:

```
Ice.Default.Locator=IceGrid/Locator:tcp -p 12000 -h localhost
```

As a proxy property, you can configure additional [aspects of the proxy](#) using properties.

## Ice.Default.LocatorCacheTimeout

### Synopsis

```
Ice.Default.LocatorCacheTimeout=num
```

### Description

Specifies the default [locator cache](#) timeout for indirect proxies. If `num` is set to a value larger than zero, locator cache entries older than `num` seconds are ignored. If set to 0, the locator cache is not used. If set to `-1`, locator cache entries do not expire.

Once a cache entry has expired, the Ice run time performs a new locate request to refresh the cache before sending the next invocation; therefore, the invocation is delayed until the run time has refreshed the entry. If you set `Ice.BackgroundLocatorCacheUpdates` to a non-zero value, the lookup to refresh the cache is still performed but happens in the background; this avoids the delay for the first invocation that follows expiry of a cache entry.

## Ice.Default.Package

### Synopsis

`Ice.Default.Package=package`

### Description

Ice for Java allows you to [customize](#) the packaging of generated code. If you use this feature, the Ice run time requires additional configuration in order to successfully unmarshal exceptions and concrete class types. This property specifies a default package to use if other attempts by the Ice run time to dynamically load a generated class have failed. Also see [Ice.Package.module](#).

## Ice.Default.PreferSecure

### Synopsis

`Ice.Default.PreferSecure=num`

### Description

Specifies whether secure endpoints are given [precedence](#) in proxies by default. The default value of `num` is zero, meaning that insecure endpoints are given preference.

Setting this property to a non-zero value is the equivalent of invoking the [proxy method](#) `ice_preferSecure(true)` on proxies created by the Ice run time, such as those returned by `stringToProxy` or received as the result of an invocation. Proxies created by methods such as `ice_oneway` inherit the setting of the original proxy. If you want to force all proxies to use only secure endpoints, use [Ice.Override.Secure](#) instead.

See [Configuring Secure Proxies](#) for a discussion of secure proxies.

## Ice.Default.Protocol

### Synopsis

`Ice.Default.Protocol=protocol`

### Description

Sets the [protocol](#) that is being used if an endpoint uses default as the protocol specification. The default value is `tcp`.

## Ice.Default.Router

### Synopsis

`Ice.Default.Router=router`

### Description

Specifies the default [router](#) for all proxies. The value is a stringified proxy for the Glacier2 router control interface. The default router can be overridden on a proxy using the `ice_router` [proxy method](#). The default value is no router.

As a proxy property, you can configure additional [aspects of the proxy](#) using properties.

## Ice.Default.SlicedFormat

### Synopsis

```
Ice.Default.SlicedFormat=num
```

### **Description**

Specifies the encoding format of Slice classes and exceptions. The default value of *num* is zero, meaning that the encoding uses the compact format. Set this property to a non-zero format to use the sliced format by default. This setting is only relevant when using version 1.1 of the Ice encoding.

Note that you can also specify whether certain operations use the sliced format by annotating their definitions with [metadata](#).

## **Ice.Override.Compress**

### **Synopsis**

```
Ice.Override.Compress=num
```

### **Description**

If set, this property overrides [compression](#) settings in all proxies. If *num* is set to a value larger than zero, compression is enabled. If zero, compression is disabled.

The setting of this property is ignored in the server role.

Note that, if a client sets `Ice.Override.Compress=1` and sends a compressed request to a server that does not support compression, the server will close the connection and the client will receive `ConnectionLostException`.

If a client does not support compression and `Ice.Override.Compress=1`, the setting is ignored and a warning message is printed on `stderr`.

Regardless of the setting of this property, requests smaller than 100 bytes are never compressed.

## **Ice.Override.CloseTimeout**

### **Synopsis**

```
Ice.Override.CloseTimeout=num
```

### **Description**

This property overrides timeout settings used to [close connections](#). *num* is the timeout value in milliseconds, or `-1` for no timeout. If this property is not defined, then `Ice.Override.Timeout` is used. If `Ice.Override.Timeout` is not defined, the endpoint timeout is used.

## **Ice.Override.ConnectTimeout**

### **Synopsis**

```
Ice.Override.ConnectTimeout=num
```

### **Description**

This property overrides timeout settings used to [establish connections](#). *num* is the timeout value in milliseconds, or `-1` for no timeout. If this property is not defined, then `Ice.Override.Timeout` is used. If `Ice.Override.Timeout` is not defined, the endpoint timeout is used.

## **Ice.Override.Secure**

### **Synopsis**

```
Ice.Override.Secure=num
```

**Description**

If set to a value larger than zero, this property overrides security settings in all proxies by allowing only secure endpoints. Defining this property is equivalent to invoking the `ice_secure(true)` [proxy method](#) on every proxy. If you wish to give priority to secure endpoints without precluding the use of non-secure endpoints, use `Ice.Default.PreferSecure`. Refer to [Configuring Secure Proxies](#) for more information on secure proxies.

**Ice.Override.Timeout****Synopsis**

```
Ice.Override.Timeout=num
```

**Description**

If set, this property overrides timeout settings in all endpoints. `num` is the timeout value in milliseconds, or `-1` for no timeout.

## Ice Proxy Properties

The communicator operation `propertyToProxy` creates a proxy from a group of configuration properties. The argument to `propertyToProxy` is a string representing the base name of the property group (shown as *name* in the property descriptions below). This name must correspond to a property that supplies the stringified form of the proxy. Subordinate properties can be defined to customize the proxy's local configuration.

The communicator operation `proxyToProperty` performs the inverse operation, that is, returns the property group for a proxy.

On this page:

- [name](#)
- [name.CollocationOptimized](#)
- [name.ConnectionCached](#)
- [name.EndpointSelection](#)
- [name.Locator](#)
- [name.LocatorCacheTimeout](#)
- [name.PreferSecure](#)
- [name.Router](#)

### ***name***

#### **Synopsis**

`name=proxy`

#### **Description**

The base property of the group with an application-specific *name* supplying the stringified representation of a proxy. Use the communicator operation `propertyToProxy` to retrieve the property and convert it into a proxy.

### ***name.CollocationOptimized***

#### **Synopsis**

`name.CollocationOptimized=num`

#### **Description**

If *num* is a value greater than zero, the proxy is configured to use `collocated invocations` when possible. Defining this property is equivalent to invoking the `ice_collocationOptimized proxy method`.

### ***name.ConnectionCached***

#### **Synopsis**

`name.ConnectionCached=num`

#### **Description**

If *num* is a value greater than zero, the proxy `caches` its chosen connection for use in subsequent requests. Defining this property is equivalent to invoking the `ice_connectionCached proxy method`.

### ***name.EndpointSelection***

**Synopsis**

```
name.EndpointSelection=type
```

**Description**

Specifies the proxy's [endpoint selection](#) type. Legal values are `Random` and `Ordered`. Defining this property is equivalent to invoking the `ice_endpointSelection` proxy method.

**name.Locator****Synopsis**

```
name.Locator=proxy
```

**Description**

Specifies the proxy of the [locator](#) to be used by this proxy. Defining this property is equivalent to invoking the `ice_locator` proxy method.

This is a proxy property, so you can configure additional local aspects of the proxy with subordinate properties. For example:

```
MyProxy.Locator=...
MyProxy.Locator.EndpointSelection=Ordered
```

**name.LocatorCacheTimeout****Synopsis**

```
name.LocatorCacheTimeout=num
```

**Description**

Specifies the [locator cache](#) timeout to be used by this proxy. Defining this property is equivalent to invoking the `ice_locatorCacheTimeout` proxy method.

**name.PreferSecure****Synopsis**

```
name.PreferSecure=num
```

**Description**

If `num` is a value greater than zero, the proxy gives [precedence](#) to secure endpoints. If not defined, the proxy uses the value of `Ice.Default.PreferSecure`.

Defining this property is equivalent to invoking the `ice_preferSecure` proxy method.

**name.Router****Synopsis**

```
name.Router=proxy
```

**Description**

Specifies the proxy of the [router](#) to be used by this proxy. Defining this property is equivalent to invoking the `ice_router proxy` method.

This is a proxy property, so you can configure additional local aspects of the proxy with subordinate properties. For example:

```
MyProxy.Router=...
MyProxy.Router.PreferSecure=1
```



## Ice Transport Properties

On this page:

- [Ice.IPv4](#)
- [Ice.IPv6](#)
- [Ice.PreferIPv6Address](#)
- [Ice.TCP.Backlog](#)
- [Ice.TCP.RcvSize](#)
- [Ice.TCP.SndSize](#)
- [Ice.UDP.RcvSize](#)
- [Ice.UDP.SndSize](#)

### Ice.IPv4

#### Synopsis

`Ice.IPv4=num`

#### Description

Specifies whether Ice uses IPv4. If `num` is a value greater than zero, IPv4 is enabled. If not specified, the default value is 1.

### Ice.IPv6

#### Synopsis

`Ice.IPv6=num`

#### Description

Specifies whether Ice uses IPv6. If `num` is a value greater than zero, IPv6 is enabled. If not specified, the default value is 1.

#### Platform Notes

##### Java

Java's default network stack always accepts both IPv4 and IPv6 connections regardless of the settings of `Ice.IPv6`. You can configure the Java run time to use only IPv4 by starting your application with the following JVM option:

```

Java

java -Djava.net.preferIPv4Stack=true ...

```

### Ice.PreferIPv6Address

#### Synopsis

`Ice.PreferIPv6Address=num`

#### Description

If both IPv4 and IPv6 are enabled (the default), specifies whether Ice prefers IPv6 addresses over IPv4 addresses when resolving hostnames. If `num` is a value greater than zero, IPv6 addresses are preferred. If not specified, the default value is 0.

## Ice.TCP.Backlog

### Synopsis

`Ice.TCP.Backlog=num`

### Description

Specifies the size of the listen queue for each TCP or SSL server endpoint. If not defined, the default value for C++ programs uses the value of `SOMAXCONN` if present, or `511` otherwise. In Java and .NET, the default value is `511`.

## Ice.TCP.RcvSize

### Synopsis

`Ice.TCP.RcvSize=num`

### Description

This property sets the TCP receive buffer size to the specified value in bytes. The default value depends on the configuration of the local TCP stack. (A common default values is `65535` bytes.)

The OS may impose lower and upper limits on the receive buffer size or otherwise adjust the buffer size. If a limit is requested that is lower than the OS-imposed minimum, the value is silently adjusted to the OS-imposed minimum. If a limit is requested that is larger than the OS-imposed maximum, the value is adjusted to the OS-imposed maximum; in addition, Ice logs a warning showing the requested size and the adjusted size.

## Ice.TCP.SndSize

### Synopsis

`Ice.TCP.SndSize=num`

### Description

This property sets the TCP send buffer size to the specified value in bytes. The default value depends on the configuration of the local TCP stack. (A common default values is `65535` bytes.)

The OS may impose lower and upper limits on the send buffer size or otherwise adjust the buffer size. If a limit is requested that is lower than the OS-imposed minimum, the value is silently adjusted to the OS-imposed minimum. If a limit is requested that is larger than the OS-imposed maximum, the value is adjusted to the OS-imposed maximum; in addition, Ice logs a warning showing the requested size and the adjusted size.

## Ice.UDP.RcvSize

### Synopsis

`Ice.UDP.RcvSize=num`

### Description

This property sets the UDP receive buffer size to the specified value in bytes. Ice messages larger than `num - 28` bytes cause a `DatagramLimitException`. The default value depends on the configuration of the local UDP stack. (Common default values are `65535` and `8192` bytes.)

The OS may impose lower and upper limits on the receive buffer size or otherwise adjust the buffer size. If a limit is requested that is lower than the OS-imposed minimum, the value is silently adjusted to the OS-imposed minimum. If a limit is requested that is larger than the OS-imposed maximum, the value is adjusted to the OS-imposed maximum; in addition, Ice logs a warning showing the requested size and the adjusted size.

Values less than 28 are ignored.

Note that, on many operating systems, it is possible to set a buffer size greater than 65535. Such settings do not change the hard limit of 65507 bytes for the payload of a UDP packet, but merely affect how much data can be buffered by the kernel.

Settings less than 65535 limit the size of Ice datagrams as well as adjust the kernel buffer sizes.

## Ice.UDP.SndSize

### Synopsis

`Ice.UDP.SndSize=num`

### Description

This property sets the UDP send buffer size to the specified value in bytes. Ice messages larger than `num - 28` bytes cause a `DatagramLimitException`. The default value depends on the configuration of the local UDP stack. (Common default values are 65535 and 8192 bytes.)

The OS may impose lower and upper limits on the send buffer size or otherwise adjust the buffer size. If a limit is requested that is lower than the OS-imposed minimum, the value is silently adjusted to the OS-imposed minimum. If a limit is requested that is larger than the OS-imposed maximum, the value is adjusted to the OS-imposed maximum; in addition, Ice logs a warning showing the requested size and the adjusted size.

Values less than 28 are ignored.

Note that, on many operating systems, it is possible to set a buffer size greater than 65535. Such settings do not change the hard limit of 65507 bytes for the payload of a UDP packet, but merely affect how much data can be buffered by the kernel.

Settings less than 65535 limit the size of Ice datagrams as well as adjust the kernel buffer sizes.

## Ice Miscellaneous Properties

On this page:

- `Ice.ACM.Client`
- `Ice.ACM.Server`
- `Ice.BackgroundLocatorCacheUpdates`
- `Ice.BatchAutoFlush`
- `Ice.CacheMessageBuffers`
- `Ice.ChangeUser`
- `Ice.ClientAccessPolicyProtocol`
- `Ice.Compression.Level`
- `Ice.ConsoleListener`
- `Ice.EventLog.Source`
- `Ice.FactoryAssemblies`
- `Ice.GC.Interval`
- `Ice.ImplicitContext`
- `Ice.LogFile`
- `Ice.MessageSizeMax`
- `Ice.MonitorConnections`
- `Ice.Nohup`
- `Ice.NullHandleAbort`
- `Ice.Package.module`
- `Ice.PrintAdapterReady`
- `Ice.PrintProcessId`
- `Ice.PrintStackTraces`
- `Ice.ProgramName`
- `Ice.RetryIntervals`
- `Ice.ServerIdleTime`
- `Ice.SOCKSProxyHost`
- `Ice.SOCKSProxyPort`
- `Ice.StdErr`
- `Ice.StdOut`
- `Ice.SyslogFacility`
- `Ice.UseSyslog`

### Ice.ACM.Client

#### **Synopsis**

`Ice.ACM.Client=num`

#### **Description**

If `num` is set to a value larger than zero, client-side [Active Connection Management](#) (ACM) is enabled. This means that connections are automatically closed by the client after they have been idle for `num` seconds. This is transparent to applications because connections closed by ACM are automatically reestablished if they are needed again. The default value is 60, meaning that idle connections are automatically closed after one minute.

Applications may need to disable client-side ACM in certain situations, such as when using [bidirectional connections](#). You can disable ACM by setting this property to zero.

### Ice.ACM.Server

#### **Synopsis**

`Ice.ACM.Server=num`

**Description**

This property is the server-side equivalent of `#Ice.ACM.Client`. If `num` is set to a value larger than zero, server-side [Active Connection Management](#) (ACM) is enabled, in which the server automatically closes an incoming connection after it has been idle for `num` seconds. The default value is 0, meaning that server-side ACM is disabled by default.

Server-side ACM can cause incoming oneway requests to be silently discarded.

**Ice.BackgroundLocatorCacheUpdates****Synopsis**

```
Ice.BackgroundLocatorCacheUpdates=num
```

**Description**

If `num` is set to zero (the default), an invocation on an indirect proxy whose endpoints are older than the configured [locator cache](#) timeout triggers a locator cache update; the run time delays the invocation until the new endpoints are returned by the locator.

If `num` is set to a value larger than zero, an invocation on an indirect proxy with expired endpoints still triggers a locator cache update, but the update is performed in the background, and the run time uses the expired endpoints for the invocation. This avoids delaying the first invocation that follows expiry of a cache entry.

**Ice.BatchAutoFlush****Synopsis**

```
Ice.BatchAutoFlush=num
```

**Description**

This property controls how the Ice run time deals with flushing of [batch messages](#). If `num` is set to a non-zero value (the default), the run time automatically forces a flush of the current batch when a new message is added to a batch and that message would cause the batch to exceed `#Ice.MessageSizeMax`. If `num` is set to zero, batches must be flushed explicitly by the application; in this case, if the application adds more messages to a batch than permitted by `Ice.MessageSizeMax`, the application receives a `MemoryLimitException` when it flushes the batch.

**Ice.CacheMessageBuffers****Synopsis**

```
Ice.CacheMessageBuffers=num (Java, .NET)
```

**Description**

If `num` is a value greater than zero, the Ice run time caches message buffers for future reuse. This can improve performance and reduce the amount of garbage produced by Ice internals that the garbage collector would eventually spend time to reclaim. However, for applications that exchange very large messages, this cache may consume excessive amounts of memory and therefore should be disabled by setting this property to zero.



This property affects the caching of message buffers for synchronous invocations. The Ice run time never caches message buffers for asynchronous invocations.

**Platform Notes**

- Java  
Ice allocates non-direct message buffers when this property is set to 1 and direct message buffers when set to 2. Use of direct message buffers minimizes copying and typically results in improved throughput. If not defined, the default value is 2.
- .NET  
If not defined, the default value is 1.

## Ice.ChangeUser

### Synopsis

`Ice.ChangeUser=user` (C++ & Unix only)

### Description

If set, Ice changes the user and group id to the respective ids of `user` in `/etc/passwd`. This only works if the Ice application is executed by the super-user.

## Ice.ClientAccessPolicyProtocol

### Synopsis

`Ice.ClientAccessPolicyProtocol=type` (Silverlight only)

### Description

If set to `Http`, Ice for Silverlight configures an outgoing socket to use the HTTP [access policy](#) protocol rather than the default TCP protocol.

## Ice.Compression.Level

### Synopsis

`Ice.Compression.Level=num`

### Description

Specifies the bzip2 compression level to use when [compressing protocol messages](#). Legal values for `num` are 1 to 9, where 1 represents the fastest compression and 9 represents the best compression. Note that higher levels cause the bzip2 algorithm to devote more resources to the compression effort, and may not result in a significant improvement over lower levels. If not specified, the default value is 1.

## Ice.ConsoleListener

### Synopsis

`Ice.ConsoleListener=num` (.NET)

### Description

If `num` is non-zero, the Ice run time installs a `ConsoleTraceListener` that writes its messages to `stderr`. If `num` is zero, logging is disabled. Note that the setting of `#Ice.LogFile` overrides this property: if `Ice.LogFile` is set, messages are written to the log file regardless of the setting of `Ice.ConsoleListener`.

## Ice.EventLog.Source

### Synopsis

`Ice.EventLog.Source=name` (C++ & Windows only)

### Description

Specifies the name of an event log source to be used by a Windows service that subclasses `Ice::Service`. The value of `name` represents a subkey of the `Eventlog` registry key. An application (or administrator) typically prepares the registry key when the service is installed. If no matching registry key is found, Windows logs events in the `Application` log. Any backslashes in `name` are silently converted to forward slashes. If not defined, `Ice::Service` uses the service name as specified by the `--service` option.

## Ice.FactoryAssemblies

### Synopsis

`Ice.FactoryAssemblies=assembly [assembly ...]` (Silverlight, .NET CF)

### Description

The [Silverlight and Compact Framework](#) versions of Ice for .NET are unable to automatically discover all dependent assemblies during program startup. To assist the Ice run time in locating user exceptions and concrete Slice classes, you must explicitly list the assemblies that contain Slice-generated code. The value of this property is a whitespace-separated list of assembly names, which may be simple names (such as `client`) or fully-qualified names (such as `client,Version=1.0.0.0,Culture=neutral,PublicKeyToken=...`). Do not use spaces in a fully-qualified assembly name.

When searching for a class, Ice first checks in the assemblies specified by this property. If the type is not found, Ice automatically looks in the standard Ice assemblies (`Ice`, `Glacier2`, `IceBox`, `IceGrid`, `IcePatch2`, and `IceStorm`). This means it is not necessary for you to explicitly include the standard Ice assemblies in this property.

Note that the program itself is also considered an assembly. If you compiled the main program directly with Slice-generated code, your `Ice.FactoryAssemblies` property must include the program itself if the generated code includes user exceptions or concrete classes. For simple build scenarios in which all generated code is compiled directly into the executable, the following configuration setting is sufficient:

```
Ice.FactoryAssemblies=client
```

This example assumes the executable is named `client.exe`. On the other hand, if Slice-generated code is also compiled into a dependent assembly, your configuration might look like this instead:

```
Ice.FactoryAssemblies=client MyOtherAssembly
```

Failing to define `Ice.FactoryAssemblies` can cause the Ice run time in the receiver to raise `NoObjectFactoryException`, `UnmarshalingOutOfBoundsException` or `UnknownUserException`. If you are experiencing either of these exceptions, verify that your assemblies are configured correctly.

## Ice.GC.Interval

### Synopsis

`Ice.GC.Interval=num` (C++)

### Description

Ice for C++ includes a [garbage collector](#) for Slice objects. This property determines the frequency with which the garbage collector runs. If the interval is set to zero (the default), no collector thread is created. Otherwise, the collector thread runs every `num` seconds. You can trace the garbage collector's activities by setting the `Ice.Trace.GC` property.

## Ice.ImplicitContext

### Synopsis

`Ice.ImplicitContext=type`

### Description

Specifies whether a communicator has an [implicit request context](#) and, if so, at what scope the context applies. Legal values for this property are `None` (equivalent to the empty string), `PerThread`, and `Shared`. If not specified, the default value is `None`.

## Ice.LogFile

### Synopsis

`Ice.LogFile=file`

### Description

Replaces the communicator's [default logger](#) with a simple file-based logger implementation. This property does not affect the [per-process logger](#). The logger creates the specified file if necessary, otherwise it appends to the file. If the logger is unable to open the file, the application receives an `InitializationException` during [communicator initialization](#). If a logger object is supplied in the `InitializationData` argument during communicator initialization, it takes precedence over this property.

The logger does not provide any built-in support for log file maintenance (such as log rotation), but it can coexist with system tools such as `logrotate`.

## Ice.MessageSizeMax

### Synopsis

`Ice.MessageSizeMax=num`

### Description

This property controls the maximum size (in kilobytes) of an uncompressed protocol message that is accepted or sent by the Ice run time. The size includes the size of the Ice protocol header. The default size is 1024 (1 Megabyte). Settings with a value less than 1 are ignored.

If a client sends a message that exceeds the client's `Ice.MessageSizeMax`, or the server returns a reply that exceeds the client's `Ice.MessageSizeMax`, the client receives a `MemoryLimitException`.

If a client sends a message that exceeds the server's `Ice.MessageSizeMax`, the server immediately closes its connection, so the client receives a `ConnectionLostException` in that case. In addition, the server logs a `MemoryLimitException` if `Ice.Warn.Connections` is set.

If the server returns a reply that exceeds the server's `Ice.MessageSizeMax`, the server logs a `MemoryLimitException` (if `Ice.Warn.Connections` is set) but does not close its connection to the client. The client receives an `UnknownLocalException` in this case.

## Ice.MonitorConnections

### Synopsis

`Ice.MonitorConnections=num`

### Description

If [Active Connection Management](#) (ACM) is enabled, the Ice run time scans for idle connections to be closed once every `num` seconds. If you



do not set this property or set *num* to zero or a negative value, the run time applies a heuristic to determine how often to scan for idle connections: the default scanning interval is the 10% of smallest configured ACM timeout, with a minimum of 5 seconds, and a maximum of 5 minutes.

## Ice.Nohup

### Synopsis

`Ice.Nohup=num`

### Description

If *num* is set to a value larger than zero, the `Application` convenience class (as well as the `Ice::Service` class in C++) ignore `SIGHUP` on Unix and `CTRL_LOGOFF_EVENT` on Windows. As a result, an application that sets `Ice.Nohup` continues to run if the user that started the application logs off. The default value for `Application` is 0, and the default value for `Ice::Service` is 1.

## Ice.NullHandleAbort

### Synopsis

`Ice.NullHandleAbort=num`

### Description

If *num* is set to a value larger than zero, invoking an operation using a null [smart pointer](#) causes the program to abort immediately instead of raising `IceUtil::NullHandleException`.

## Ice.Package.module

### Synopsis

`Ice.Package.module=package` (Java)

### Description

Ice for Java allows you to [customize](#) the packaging of generated code. If you use this feature, the Ice run time requires additional configuration in order to successfully unmarshal exceptions and concrete class types. This property associates a top-level Slice *module* with a Java *package*. If all top-level modules are generated into the same user-defined package, it is easier to use `Ice.Default.Package` instead.

## Ice.PrintAdapterReady

### Synopsis

`Ice.PrintAdapterReady=num`

### Description

If *num* is set to a value larger than zero, an object adapter prints "*adapter\_name* ready" on standard output after activation is complete. This is useful for scripts that need to wait until an object adapter is ready to be used.

## Ice.PrintProcessId

### Synopsis

```
Ice.PrintProcessId=num
```

### Description

If *num* is set to a value larger than zero, the process ID is printed on standard output upon startup.

## Ice.PrintStackTraces

### Synopsis

```
Ice.PrintStackTraces=num
```

### Description

If *num* is set to a value larger than zero, inserting an exception that derives from `IceUtil::Exception` into a [logger helper class](#) (such as `Ice::Warning`) also displays the exception's stack trace. Likewise, the `ice_stackTrace` function on the base exception class, `IceUtil::Exception`, will return the stack trace or an empty string depending on the value *num*. If not set, the default value depends on how the Ice run time is compiled: 0 for an optimized build and 1 for a debug build.

Stack traces are currently not available on Solaris.

On Windows, stack traces are available in debug builds and in release builds built with the environment variable `RELEASEPDBS` set to `yes`. The release DLLs included in the standard Ice binary distribution are built with `RELEASEPDBS` not set (i.e. `.PDB` files are not generated, and no stack trace support is included).

When generating a stack trace, Windows will attempt to locate the `.PDB` files at the location stored in the associated DLLs; in case the `.PDB` file is not found at this location, Windows will attempt to locate this file using the following search path: current working directory, then the directory of the `IceUtil` DLL, and finally the search path specified by the environment variable `_NT_SYMBOL_PATH`. Therefore, if your `.PDB` files are no longer where you built them, you will need to copy them next to the `IceUtil` DLL or include their new directory in the `_NT_SYMBOL_PATH` environment variable.

## Ice.ProgramName

### Synopsis

```
Ice.ProgramName=name
```

### Description

*name* is the program name, which is [set automatically](#) from `argv[0]` (C++) and from `AppDomain.CurrentDomain.FriendlyName` (.NET) during initialization. For Java, `Ice.ProgramName` is initialized to the empty string. The default name can be overridden by setting this property.

## Ice.RetryIntervals

### Synopsis

```
Ice.RetryIntervals=num [num ...]
```

### Description

This property defines the number of times an operation is [automatically retried](#) and the delay between each retry. For example, if the property is set to `0 100 500`, the operation is retried 3 times: immediately after the first failure, again after waiting 100ms after the second failure, and again after waiting 500ms after the third failure. The default value (0) means Ice retries once immediately. If set to `-1`, no retry occurs.

## Ice.ServerIdleTime

### Synopsis

`Ice.ServerIdleTime=num`

### Description

If *num* is set to a value larger than zero, Ice automatically calls `Communicator::shutdown` once the communicator has been idle for *num* seconds. This shuts down the communicator's server side and causes all threads waiting in `Communicator::waitForShutdown` to return. After that, a server will typically do some clean-up work before exiting. The default value is zero, meaning that the server will not shut down automatically. This property is often used for servers that are automatically [activated by IceGrid](#).

## Ice.SOCKSProxyHost

### Synopsis

`Ice.SOCKSProxyHost=addr`

### Description

Specifies the host name or IP address of a SOCKS proxy server. If *addr* is not empty, Ice uses the designated SOCKS proxy server for all outgoing (client) connections.



Ice currently only supports the SOCKS4 protocol, which means only IPv4 connections are allowed.

## Ice.SOCKSProxyPort

### Synopsis

`Ice.SOCKSProxyPort=num`

### Description

The port number of the SOCKS proxy server. If not specified, the default value is 1080.

## Ice.StdErr

### Synopsis

`Ice.StdErr=filename`

### Description

If *filename* is not empty, the standard error stream of this process is redirected to this file, in append mode. This property is checked only for the first communicator that is created in a process.

## Ice.StdOut

### Synopsis

`Ice.StdOut=filename`

**Description**

If *filename* is not empty, the standard output stream of this process is redirected to this file, in append mode. This property is checked only for the first communicator created in a process.

**Ice.SyslogFacility****Synopsis**

`Ice.SyslogFacility=string` (Unix only)

**Description**

This property sets the syslog facility to *string*. This property has no effect if `Ice.UseSyslog` is not set.

*string* can be any of syslog facilities: LOG\_AUTH, LOG\_AUTHPRIV, LOG\_CRON, LOG\_DAEMON, LOG\_FTP, LOG\_KERN, LOG\_LOCAL0, LOG\_LOCAL1, LOG\_LOCAL2, LOG\_LOCAL3, LOG\_LOCAL4, LOG\_LOCAL5, LOG\_LOCAL6, LOG\_LOCAL7, LOG\_LPR, LOG\_MAIL, LOG\_NEWS, LOG\_SYSLOG, LOG\_USER, LOG\_UUCP.

The default value is LOG\_USER.

**Ice.UseSyslog****Synopsis**

`Ice.UseSyslog=num` (Unix only)

**Description**

If *num* is set to a value larger than zero, a special `logger` is installed that logs to the `syslog` service instead of standard error. The identifier for `syslog` is the value of `#Ice.ProgramName`. Use `#Ice.SyslogFacility` to select a `syslog` facility.

## IceSSL Properties

On this page:

- `IceSSL.Alias`
- `IceSSL.CertAuthDir`
- `IceSSL.CertAuthFile`
- `IceSSL.CertFile`
- `IceSSL.CertVerifier`
- `IceSSL.CheckCertName`
- `IceSSL.CheckCRL`
- `IceSSL.Ciphers`
- `IceSSL.DefaultDir`
- `IceSSL.DH.bits`
- `IceSSL.EntropyDaemon`
- `IceSSL.FindCert.location.name`
- `IceSSL.ImportCert.location.name`
- `IceSSL.InitOpenSSL`
- `IceSSL.Keychain`
- `IceSSL.KeychainPassword`
- `IceSSL.KeyFile`
- `IceSSL.KeySet`
- `IceSSL.Keystore`
- `IceSSL.KeystorePassword`
- `IceSSL.KeystoreType`
- `IceSSL.Password`
- `IceSSL.PasswordCallback`
- `IceSSL.PasswordRetryMax`
- `IceSSL.PersistKeySet`
- `IceSSL.Protocols`
- `IceSSL.Random`
- `IceSSL.Trace.Security`
- `IceSSL.TrustOnly`
- `IceSSL.TrustOnly.Client`
- `IceSSL.TrustOnly.Server`
- `IceSSL.TrustOnly.Server.AdapterName`
- `IceSSL.Truststore`
- `IceSSL.TruststorePassword`
- `IceSSL.TruststoreType`
- `IceSSL.VerifyDepthMax`
- `IceSSL.VerifyPeer`

### IceSSL.Alias

#### Synopsis

`IceSSL.Alias=alias` (Java)

#### Description

Selects a particular certificate from the key store specified by `IceSSL.Keystore`. The certificate identified by `alias` is presented to the peer request during authentication.

### IceSSL.CertAuthDir

#### Synopsis

`IceSSL.CertAuthDir=path` (C++)

### **Description**

Specifies the `directory` containing the certificates of trusted certificate authorities. The directory must be prepared in advance using the OpenSSL utility `c_rehash`. The path name may be specified relative to the default directory defined by `IceSSL.DefaultDir`.

## **IceSSL.CertAuthFile**

### **Synopsis**

`IceSSL.CertAuthFile=file` (C++, Ice Touch)

### **Description**

Specifies a file containing the certificate of a trusted certificate authority. The file name may be specified relative to the default directory defined by `IceSSL.DefaultDir`.

### **Platform Notes**

#### **C++**

The certificate must be encoded using the PEM format.

#### **Ice Touch**

The certificate must be encoded using the DER format.

If `IceSSL.DefaultDir` is also defined, IceSSL attempts to open the specified CA certificate file as `Resources/DefaultDir/file` in the application's resource bundle and as `DefaultDir/file` in the file system.

If `IceSSL.DefaultDir` is not defined, IceSSL attempts to open the specified CA certificate file as `Resources/file` in the application's resource bundle and as `file` in the file system.

If this property is not defined, IceSSL looks for suitable CA certificates in the user's keychains and in the system keychain.

## **IceSSL.CertFile**

### **Synopsis**

`IceSSL.CertFile=file` (.NET, Ice Touch)

`IceSSL.CertFile=file[:file]` (C++ & Unix only)

`IceSSL.CertFile=file[;file]` (C++ & Windows only)

### **Description**

Specifies a file that contains the program's certificate, and may also contain the corresponding private key. The file name may be specified relative to the default directory defined by `IceSSL.DefaultDir`.

### **Platform Notes**

#### **C++**

The private key is optional; if not present, the file containing the private key must be identified by `IceSSL.KeyFile`. If a password is required, OpenSSL will prompt the user at the terminal unless the application has installed a `password handler` or supplied the password using `IceSSL.Password`. The certificate must be encoded using the PEM format.

OpenSSL allows you to specify certificates for both RSA and DSA. To specify both certificates, separate the filenames using the platform's path separator character.

**.NET**

The file must use the PFX (PKCS#12) format and contain the certificate and its private key. The password for the file must be supplied using `IceSSL.Password`.

**Ice Touch**

The file must use the PFX (PKCS#12) format and contain the certificate and its private key. The password for the file must be supplied using `IceSSL.Password`. The certificate is imported into the keychain identified by the `IceSSL.Keychain` property.

If `IceSSL.DefaultDir` is also defined, IceSSL attempts to open the specified certificate file as `Resources/DefaultDir/file` in the application's resource bundle and as `DefaultDir/file` in the file system.

If `IceSSL.DefaultDir` is not defined, IceSSL attempts to open the specified certificate file as `Resources/file` in the application's resource bundle and as `file` in the file system.

## IceSSL.CertVerifier

**Synopsis**

`IceSSL.CertVerifier=classname` (Java, .NET)

**Description**

Specifies the name of a Java or .NET class that implements the `IceSSL.CertificateVerifier` interface for performing application-defined [certificate verification](#).

## IceSSL.CheckCertName

**Synopsis**

`IceSSL.CheckCertName=num`

**Description**

If `num` is a value greater than zero, IceSSL attempts to match the server's host name as specified in the proxy endpoint against the common name component of the server certificate's subject name. If no match is found, IceSSL attempts to match the host name against the DNS and IP address fields of the server certificate's subject alternative name. The search does not issue any DNS queries but simply performs a case-insensitive string match. The server's certificate is accepted if its common name or any of its DNS or IP addresses matches the host name in the proxy endpoint. IceSSL skips this validation step if the server does not supply a certificate, or if the proxy endpoint does not include a host name and `Ice.Default.Host` is not defined. This property has no affect on a server's validation of a client's certificate. If no match is found, IceSSL aborts the connection attempt and raises an exception. If not defined, the default value is zero.

## IceSSL.CheckCRL

**Synopsis**

`IceSSL.CheckCRL=num` (.NET)

**Description**

If `num` is a value greater than zero, IceSSL checks the certificate revocation list to determine if the peer's certificate has been revoked. If so, IceSSL aborts the connection and raises an exception.

## IceSSL.Ciphers

## Synopsis

`IceSSL.Ciphers=ciphers` (C++, Java)

## Description

Specifies the cipher suites that IceSSL is allowed to negotiate. A cipher suite is a set of algorithms that satisfies the four requirements for establishing a secure connection: signing and authentication, key exchange, secure hashing, and encryption. Some algorithms satisfy more than one requirement, and there are many possible combinations.

## Platform Notes

### C++

The value of this attribute is given directly to the OpenSSL library and is dependent on how OpenSSL was compiled. You can obtain a complete list of the supported cipher suites using the command `openssl ciphers`. This command will likely generate a long list. To simplify the selection process, OpenSSL supports several classes of ciphers. Classes and ciphers can be excluded by prefixing them with an exclamation point. The special keyword `@STRENGTH` sorts the cipher list in order of their strength, so that SSL gives preference to the more secure ciphers when negotiating a cipher suite. The `@STRENGTH` keyword must be the last element in the list. The classes are:

ALL	Enables all supported cipher suites. This class should be used with caution, as it may enable low-security cipher suites.
ADH	Anonymous ciphers.
LOW	Low bit-strength ciphers.
EXP	Export-crippled ciphers.

Here is an example of a reasonable setting:

```
ALL : !ADH : !LOW : !EXP : !MD5 : @STRENGTH
```

This value excludes the ciphers with low bit-strength and known problems, and orders the remaining ciphers according to their strength. Note that no warning is given if an unrecognized cipher is specified.

### Java

The property value is interpreted as a list of tokens delimited by white space. The plug-in executes the tokens in the order of appearance in order to assemble the list of enabled cipher suites. The table below describes the tokens:

NONE	Disables all cipher suites. If specified, it must be the first token in the list.
ALL	Enables all supported cipher suites. If specified, it must be the first token in the list. This token should be used with caution, as it may enable low-security cipher suites.
NAME	Enables the cipher suite matching the given name.
!NAME	Disables the cipher suite matching the given name.
( EXP )	Enables cipher suites whose names contain the regular expression <i>EXP</i> . For example, the value <code>NONE ( .*DH_anon.* )</code> selects only cipher suites that use anonymous Diffie-Hellman authentication.



!( <i>EXP</i> )	Disables cipher suites whose names contain the regular expression <i>EXP</i> . For example, the value ALL !(. *DH_anon. *) enables all cipher suites except those that use anonymous Diffie-Hellman authentication.
-----------------	---------------------------------------------------------------------------------------------------------------------------------------------------------------------------------------------------------------------

If not specified, the plug-in uses the security provider's default cipher suites. Enable `IceSSL.Trace.Security` to determine which cipher suites are enabled by default, or to verify your cipher suite configuration.

## IceSSL.DefaultDir

### Synopsis

`IceSSL.DefaultDir=path`

### Description

Specifies the default directory in which to look for certificate, key, and key store files. See the descriptions of the relevant properties for more information.

## IceSSL.DH.bits

### Synopsis

`IceSSL.DH.bits=file` (C++)

### Description

Specifies a *file* containing Diffie Hellman parameters whose key length is *bits*, as shown in the following example:

```
IceSSL.DH.1024=dhparams1024.pem
```

IceSSL supplies default parameters for key lengths of 512, 1024, 2048, and 4096 bits, which are used if no user-defined parameters of the desired key length are specified. The file name may be specified relative to the default directory defined by `IceSSL.DefaultDir`. The parameters must be encoded using the PEM format.

## IceSSL.EntropyDaemon

### Synopsis

`IceSSL.EntropyDaemon=file` (C++)

### Description

Specifies a Unix domain socket for the entropy gathering daemon, from which OpenSSL gathers entropy data to initialize its random number generator.

## IceSSL.FindCert.location.name

### Synopsis

`IceSSL.FindCert.location.name=criteria` (.NET)

**Description**

Queries the certificate repository for matching certificates and adds them to the application's collection of certificates that are used for authentication. The value for *location* must be `LocalMachine` or `CurrentUser`.

The *name* corresponds to the .NET enumeration `StoreName` and may be one of the following values: `AddressBook`, `AuthRoot`, `CertificateAuthority`, `Disallowed`, `My`, `Root`, `TrustedPeople`, `TrustedPublisher`. It is also possible to use an arbitrary value for *name*.

The value for *criteria* may be `*`, in which case all of the certificates in the store are selected. Otherwise, *criteria* must be one or more *field:value* pairs separated by white space. The valid field names are described below:

Issuer	Matches a substring of the issuer's name.
IssuerDN	Matches the issuer's entire distinguished name.
Serial	Matches the certificate's serial number.
Subject	Matches a substring of the subject's name.
SubjectDN	Matches the subject's entire distinguished name.
SubjectKeyId	Matches the certificate's subject key identifier.
Thumbprint	Matches the certificate's thumbprint.

The field names are case-insensitive. If multiple criteria are specified, only certificates that match all criteria are selected. Values must be enclosed in single or double quotes to preserve white space.

Multiple occurrences of the property are allowed, but only one query is possible for each location/name combination. The certificates from all queries are combined to form the certificate collection, including a certificate loaded using `IceSSL.CertFile`. Here are some sample queries:

```
IceSSL.FindCert.LocalMachine.My=issuer:verisign serial:219336
IceSSL.FindCert.CurrentUser.Root=subject:"Joe's Certificate"
```

A server requires a certificate for authentication purposes, therefore `IceSSL` selects the first certificate in the accumulated collection. This is normally the certificate loaded via `IceSSL.CertFile`, if that property was defined. Otherwise, one of the certificates from `IceSSL.FindCert.location.name` is selected. Since `IceSSL` does not guarantee the order in which it evaluates `IceSSL.FindCert.location.name` properties, it is recommended that the criteria select only one certificate.

**IceSSL.ImportCert.location.name****Synopsis**

```
IceSSL.ImportCert.location.name=file[:password] (.NET)
```

**Description**

Imports the certificate in *file* into the specified certificate store. The value for *location* must be `LocalMachine` or `CurrentUser`. The *name* corresponds to the .NET enumeration `StoreName` and may be one of the following values: `AddressBook`, `AuthRoot`, `CertificateAuthority`, `Disallowed`, `My`, `Root`, `TrustedPeople`, `TrustedPublisher`. It is also possible to use an arbitrary value for *name*, which adds a new store to the repository. If you are importing a trusted CA certificate, it must be added to `AuthRoot` or `Root`.

The *password* is optional; it is only necessary if the certificate file also contains a private key or uses a secure storage format such as PFX.

The file name and password may be enclosed in single or double quotes if necessary. The file name may be specified relative to the default directory defined by `IceSSL.DefaultDir`.

Importing a certificate into `LocalMachine` requires administrator privileges, while importing into `CurrentUser` may cause the platform to prompt the user for confirmation.

## IceSSL.InitOpenSSL

### Synopsis

`IceSSL.InitOpenSSL=num` (C++)

### Description

Indicates whether IceSSL should perform the global initialization tasks for the OpenSSL library. The default value is 1, meaning IceSSL will initialize OpenSSL. An application can set this property to zero if it wishes to perform the OpenSSL initialization itself, which can be useful when the application uses multiple components that depend on OpenSSL.

## IceSSL.Keychain

### Synopsis

`IceSSL.Keychain=name` (Ice Touch)

### Description

Specifies the name of keychain in which to import the certificate identified by `IceSSL.CertFile`. If not defined, the keychain named `login` is used by default. Note that this property is only relevant for the iPhone simulator and OS X targets.

## IceSSL.KeychainPassword

### Synopsis

`IceSSL.KeychainPassword=password` (Ice Touch)

### Description

Specifies the password for the keychain identified by `IceSSL.Keychain`. If not defined, IceSSL attempts to open the keychain without a password. Note that this property is only relevant for the iPhone simulator and OS X targets.

## IceSSL.KeyFile

### Synopsis

`IceSSL.KeyFile=file` (C++)

### Description

Specifies a file containing the private key associated with the certificate identified by `IceSSL.CertFile`. The file name may be specified relative to the default directory defined by `IceSSL.DefaultDir`. The key must be encoded using the PEM format.

## IceSSL.KeySet

### Synopsis

`IceSSL.KeySet=DefaultKeySet|MachineKeySet|UserKeySet` (.NET)

### Description

Specifies how and where to import the private key of an X.509 certificate. The possible values correspond directly to flags in the .NET enumeration `X509KeyStorageFlags`. If not defined, the default value is `DefaultKeySet`.

The `IceSSL.PersistKeySet` property affects the lifetime of the private key.

## IceSSL.Keystore

### Synopsis

`IceSSL.Keystore=file` (Java)

### Description

Specifies a key store file containing certificates and their private keys. If the key store contains multiple certificates, you should specify a particular one to use for authentication using `IceSSL.Alias`. IceSSL first attempts to open the file as a class loader resource and then as a regular file. If the file cannot be found in the file system, IceSSL attempts to open the file relative to the directory specified by `IceSSL.DefaultDir`. The format of the file is determined by `IceSSL.KeystoreType`.

If this property is not defined, the application will not be able to supply a certificate during SSL handshaking. As a result, the application may not be able to negotiate a secure connection, or might be required to use an anonymous cipher suite.

## IceSSL.KeystorePassword

### Synopsis

`IceSSL.KeystorePassword=password` (Java)

### Description

Specifies the password used to verify the integrity of the key store defined by `IceSSL.Keystore`. The integrity check is skipped if this property is not defined.

It is a security risk to use a plain-text password in a configuration file.

## IceSSL.KeystoreType

### Synopsis

`IceSSL.KeystoreType=type` (Java)

### Description

Specifies the format of the key store file defined by `IceSSL.Keystore`. Legal values are `JKS` and `PKCS12`. If not defined, the JVM's default value is used (normally `JKS`).

## IceSSL.Password

### Synopsis

`IceSSL.Password=password`

### Description

Specifies the password necessary to decrypt the private key. It is a security risk to use a plain-text password in a configuration file.

### Platform Notes

**C++**

This property supplies the password that was used to secure the private key contained in the file defined by `IceSSL.CertFile` or `IceSSL.KeyFile`. If this property is not defined and you have not installed a `password callback` object, OpenSSL will prompt the user for a password if one is necessary.

**Java**

This property supplies the password that was used to secure the private key contained in the key store defined by `IceSSL.Keystore`. All of the keys in the key store must use the same password.

**.NET**

This property supplies the password that was used to secure the file defined by `IceSSL.CertFile`.

**Ice Touch**

This property supplies the password that was used to secure the file defined by `IceSSL.CertFile`.

## IceSSL.PasswordCallback

**Synopsis**

`IceSSL.PasswordCallback=classname` (Java, .NET)

**Description**

Specifies the name of a Java or .NET class that implements the `IceSSL.PasswordCallback` interface. Using a `password callback` is a more secure alternative to specifying a password in a plain-text configuration file.

## IceSSL.PasswordRetryMax

**Synopsis**

`IceSSL.PasswordRetryMax=num` (C++)

**Description**

Specifies the number of attempts IceSSL should allow the user to make when entering a password. If not defined, the default value is 3.

## IceSSL.PersistKeySet

**Synopsis**

`IceSSL.PersistKeySet=num` (.NET)

**Description**

If `num` is a value greater than zero, IceSSL includes the `PersistKeySet` flag when importing the private key of an X.509 certificate to ensure the key is stored in a persistent container. The `PersistKeySet` flag is one of the flags in the .NET enumeration `X509KeyStorageFlags`. If not defined, the default value is zero.

The `IceSSL.KeySet` property determines the location of the private key.

## IceSSL.Protocols

**Synopsis**

`IceSSL.Protocols=list` (C++, Java, .NET)

### Description

Specifies the protocols to allow during SSL handshaking. Legal values are `SSL3`, `TLS1`, `TLS1_0` (alias for `TLS1`), `TLS1_1`, and `TLS1_2`. You may also specify multiple values, separated by commas or white space. If this property is not defined, the platform's default is used.

 In C#, the options `TLS1_1` and `TLS1_2` require .NET 4.5 or later.

## IceSSL.Random

### Synopsis

`IceSSL.Random=filelist` (C++, Java)

### Description

Specifies one or more files containing data to use when seeding the random number generator. The file names should be separated using the platform's path separator (a colon on Unix and a semicolon on Windows). The file names may be specified relative to the default directory defined by `IceSSL.DefaultDir`.

In Java, IceSSL first attempts to open the files as class loader resources and then as regular files.

## IceSSL.Trace.Security

### Synopsis

`IceSSL.Trace.Security=num` (C++, Java, .NET)

### Description

The SSL plug-in trace level:

0	No security tracing (default).
1	Display diagnostic information about SSL connections.

## IceSSL.TrustOnly

### Synopsis

`IceSSL.TrustOnly=ENTRY[;ENTRY;...]` (C++, Java, .NET)

### Description

Identifies [trusted](#) and [untrusted](#) peers. This family of properties provides an additional level of authentication by using the peer certificate's distinguished name (DN) to decide whether to accept or reject a connection.

Each `ENTRY` in the property value consists of relative distinguished name (RDN) components, formatted according to the rules in [RFC 2253](#). Specifically, the components must be separated by commas, and any component that contains a comma must be escaped or enclosed in quotes. For example, the following two property definitions are equivalent:

```
IceSSL.TrustOnly=O="Acme, Inc.",OU=Sales
IceSSL.TrustOnly=O=Acme\, Inc.,OU="Sales"
```

Use a semicolon to separate multiple entries in a property:

```
IceSSL.TrustOnly=O=Acme\, Inc.,OU=Sales;O=Acme\, Inc.,OU=Marketing
```

By default, each entry represents an acceptance entry. A ! character appearing at the beginning of an entry signifies a rejection entry. The order of the entries in a property is not important.

After the SSL engine has successfully completed its authentication process, IceSSL evaluates the relevant `IceSSL.TrustOnly` properties in an attempt to find an entry that matches the peer certificate's DN. For a match to be successful, the peer DN must contain an exact match for all of the RDN components in an entry. An entry may contain as many RDN components as you wish, depending on how narrowly you need to restrict access. The order of the RDN components in an entry is not important.

The connection semantics are described below:

1. IceSSL aborts the connection if any rejection or acceptance entries are defined and the peer does not supply a certificate.
2. IceSSL aborts the connection if the peer DN matches any rejection entry. (This is true even if the peer DN also matches an acceptance entry.)
3. IceSSL accepts the connection if the peer DN matches any acceptance entry, or if no acceptance entries are defined.

Our original example limits access to people in the sales and marketing departments:

```
IceSSL.TrustOnly=O=Acme\, Inc.,OU=Sales;O=Acme\, Inc.,OU=Marketing
```

If it later becomes necessary to deny access to certain individuals in these departments, you can add a rejection entry and restart the program:

```
IceSSL.TrustOnly=O=Acme\, Inc.,OU=Sales; O=Acme\, Inc.,OU=Marketing;
!O=Acme\, Inc.,CN=John Smith
```

While testing your trust configuration, you may find it helpful to set the `IceSSL.Trace.Security` property to a non-zero value, which causes IceSSL to display the DN of each peer during connection establishment.

This property affects incoming and outgoing connections. IceSSL also supports similar properties that affect only incoming connections or only outgoing connections.

## IceSSL.TrustOnly.Client

### Synopsis

```
IceSSL.TrustOnly.Client=ENTRY[;ENTRY;...] (C++, Java, .NET)
IceSSL.TrustOnly.Client=ID (Ice Touch)
```

### Description

Identifies trusted and untrusted peers for outgoing (client) connections. The entries defined in this property are combined with those of `IceSSL.TrustOnly`.

## Platform Notes

### Ice Touch

For an outgoing connection to succeed, the peer certificate's subject key identifier must match the property value exactly. The property value is formatted as a series of hexadecimal values separated by colons or spaces, as shown in the example below:

```
C2:E8:D3:33:D7:83:99:6E:08:F7:C2:34:31:F7:1E:8E:44:87:38:57
```

Since this value is specific to a single certificate authority, this property is valid only when used in conjunction with `IceSSL.CertAuthFile`.

## IceSSL.TrustOnly.Server

### Synopsis

```
IceSSL.TrustOnly.Server=ENTRY[;ENTRY; . . .] (C++, Java, .NET)
```

### Description

Identifies trusted and untrusted peers for incoming ("server") connections. The entries defined in this property are combined with those of `IceSSL.TrustOnly`. To configure trusted and untrusted peers for a particular object adapter, use `IceSSL.TrustOnly.Server.AdapterName`.

## IceSSL.TrustOnly.Server.AdapterName

### Synopsis

```
IceSSL.TrustOnly.Server.AdapterName=ENTRY[;ENTRY; . . .] (C++, Java, .NET)
```

### Description

Identifies trusted and untrusted peers for incoming (server) connections to the object adapter `AdapterName`. The entries defined in this property are combined with those of `IceSSL.TrustOnly` and `IceSSL.TrustOnly.Server`.

## IceSSL.Truststore

### Synopsis

```
IceSSL.Truststore=file (Java)
```

### Description

Specifies a key store file containing the certificates of trusted certificate authorities. IceSSL first attempts to open the file as a class loader resource and then as a regular file. If the file cannot be found in the file system, IceSSL attempts to open the file relative to the directory specified by `IceSSL.DefaultDir`. The format of the file is determined by `IceSSL.TruststoreType`.

If this property is not defined, IceSSL uses the value of `IceSSL.Keystore` by default. If no truststore is specified and the keystore does not contain a valid certificate chain, the application will not be able to authenticate the peer's certificate during SSL handshaking. As a result, the application may not be able to negotiate a secure connection, or might be required to use an anonymous cipher suite.

## IceSSL.TruststorePassword

### Synopsis



`IceSSL.TruststorePassword=password` (Java)

### Description

Specifies the password used to verify the integrity of the key store defined by `IceSSL.Truststore`. The integrity check is skipped if this property is not defined.

It is a security risk to use a plain-text password in a configuration file.

## IceSSL.TruststoreType

### Synopsis

`IceSSL.TruststoreType=type` (Java)

### Description

Specifies the format of the key store file defined by `IceSSL.Truststore`. Legal values are `JKS` and `PKCS12`. If not defined, the default value is `JKS`.

## IceSSL.VerifyDepthMax

### Synopsis

`IceSSL.VerifyDepthMax=num` (C++, Java, .NET)

### Description

Specifies the [maximum depth](#) of a trusted peer's certificate chain, including the peer's certificate. A value of zero accepts chains of any length. If not defined, the default value is 2.

## IceSSL.VerifyPeer

### Synopsis

`IceSSL.VerifyPeer=num` (C++, Java, .NET)

### Description

Specifies the verification requirements to use during SSL handshaking. The legal values are shown in the table below. If this property is not defined, the default value is 2.

0	For an outgoing connection, the client verifies the server's certificate (if an anonymous cipher is not used) but does not abort the connection if verification fails. For an incoming connection, the server does not request a certificate from the client.
1	For an outgoing connection, the client verifies the server's certificate and aborts the connection if verification fails. For an incoming connection, the server requests a certificate from the client and verifies it if one is provided, aborting the connection if verification fails.
2	For an outgoing connection, the semantics are the same as for the value 1. For an incoming connection, the server requires a certificate from the client and aborts the connection if verification fails.

***Platform Notes***

***.NET***

This property has no effect on outgoing connections, since .NET always uses the semantics of value 2. For an incoming connection, the value 0 has the same semantics as the value 1.

## IceBox Properties

On this page:

- [IceBox.InheritProperties](#)
- [IceBox.InstanceName](#)
- [IceBox.LoadOrder](#)
- [IceBox.PrintServicesReady](#)
- [IceBox.Service.name](#)
- [IceBox.ServiceManager.AdapterProperty](#)
- [IceBox.UseSharedCommunicator.name](#)

### IceBox.InheritProperties

#### Synopsis

```
IceBox.InheritProperties=num
```

#### Description

If *num* is set to a value larger than zero, each service inherits the configuration properties of the IceBox server's communicator. If not defined, the default value is zero.

### IceBox.InstanceName

#### Synopsis

```
IceBox.InstanceName=name
```

#### Description

Specifies an [alternate identity category](#) for the IceBox service manager object. If defined, the identity of the object becomes *name/ServiceManager*. If not specified, the default identity category is *IceBox*.

### IceBox.LoadOrder

#### Synopsis

```
IceBox.LoadOrder=names
```

#### Description

Determines the [order](#) in which services are loaded. The service manager loads the services in the order they appear in *names*, where each service name is separated by a comma or white space. Any services not mentioned in *names* are loaded afterward, in an undefined order.

### IceBox.PrintServicesReady

#### Synopsis

```
IceBox.PrintServicesReady=token
```

#### Description

If this property is set to a value greater than zero, the service manager prints "*token* ready" on standard output once initialization of all the services is complete. This is useful for scripts that need to wait until all services are ready to be used.

## IceBox.Service.name

### Synopsis

```
IceBox.Service.name=entry_point [args]
```

### Description

Defines a [service](#) to be loaded during IceBox initialization. Any arguments that follow the entry point are examined; those matching the `--name.*=value` pattern are interpreted as property definitions and appear in the property set of the communicator that is passed to the service `start` method, and all remaining arguments are passed to the `start` method in the `args` parameter. Whitespace separates the arguments, and any arguments that contain whitespace must be enclosed in quotes.

### Platform Notes

#### C++

The value of `entry_point` has the following form:

```
path[,version]:function
```

The `path` and optional `version` components are used to construct the name of a DLL or shared library. If no version is supplied, the version is the empty string. The `function` component is the name of a function with extern C linkage. For example, the entry point `IceStormService,35:createIceStorm` implies a shared library name of `libIceStormService.so.35` on Unix and `IceStormService35.dll` on Windows. Furthermore, if IceBox is built on Windows with debugging, a `d` is automatically appended to the version (e.g., `IceStormService35d.dll`).

The function must be declared with extern C linkage and have the following signature:

```
C++
IceBox::Service* function(Ice::CommunicatorPtr c);
```

Note that the function must return a pointer and not a smart pointer. The Ice core deallocates the object when it unloads the library. The communicator instance passed to this function is the server's communicator, which is not the same as the communicator passed to the service's `start` method.

The `path` component may optionally contain a relative or absolute path name, indicated by the presence of a path separator (`/` or `\`). In this case, the last component of the path is used to construct the name of the shared library or DLL. Consider this example:

```
IceBox.Service.IceStorm=./IceStormService,35:createIceStorm
```

The use of a relative path means the Ice run time will look in the current working directory for `libIceStormService.so.35` on Unix or `IceStormService35.dll` on Windows.

If the `path` component contains spaces, the entire entry point must be enclosed in quotes:

```
IceBox.Service.IceStorm="C:\Program
Files\ZeroC\Ice-3.5b\bin\IceStormService,35:createIceStorm"
```

If the `path` component does not include a leading path name, Ice delegates to the operating system to locate the shared library or DLL, which typically means that the plug-in can reside in any of the directories in your shared library or DLL search path.

**Java**

The value of *entry\_point* has the following form:

```
[path:]class
```

The *class* component must be the name of a class that implements the `IceBox.Service` interface and provides at least one of the constructors shown in the example below:

```

Java

public class MyService implements IceBox.Service
{
 public MyService(Ice.Communicator serverCommunicator);
 public MyService();

 // ...
}
```

The constructor taking an `Ice.Communicator` argument is invoked if present, otherwise the default constructor is invoked.

If *path* is specified, it may be the path name of a JAR file or class directory, as shown below:

```

IceBox.Service.MyService=MyService.jar:MyServiceImpl
IceBox.Service.MyOtherService=/classes:MyOtherServiceImpl
```

If *path* contains spaces, it must be enclosed in quotes:

```

IceBox.Service.MyService="factory classes.jar":MyServiceImpl
```

IceBox uses a single class loader to load all services having the same value for *path*.

If *class* is specified without a path, IceBox attempts to load the class using [class loaders](#) in a well-defined order.

**.NET**

The value of *entry\_point* has the form *assembly:class*. The *assembly* can be a partially or fully qualified assembly name, such as `myplugin,Version=0.0.0.0,Culture=neutral`, or an assembly DLL name such as `myplugin.dll`, and may optionally include a leading relative or absolute path name.



You *must* use a fully-qualified assembly name to load a service from an assembly in the Global Assembly Cache.

The specified class must implement the `IceBox.Service` interface and provide at least one of the constructors shown in the example below:

**C#**

```
public class MyService : IceBox.Service
{
 public MyService(Ice.Communicator serverCommunicator);
 public MyService();

 // ...
}
```

The constructor taking an `Ice.Communicator` argument is invoked if present, otherwise the default constructor is invoked.

If you specify a relative path name in the entry point, the assembly is located relative to the program's current working directory:

```
IceBox.Service.MyService=..\MyService.dll:MyServiceImpl
```

Enclose the assembly's path name in quotes if it contains spaces:

```
IceBox.Service.MyService="C:\Program
Files\MyService\MyService.dll:MyServiceImpl"
```

Finally, if the assembly uses a leading path name, be sure to include the `.dll` extension.

## IceBox.ServiceManager.AdapterProperty

### Synopsis

```
IceBox.ServiceManager.AdapterProperty=value
```

### Description

IceBox uses the adapter name `IceBox.ServiceManager` for its object adapter. Therefore, [adapter properties](#) can be used to configure the IceBox object adapter.

## IceBox.UseSharedCommunicator.name

### Synopsis

```
IceBox.UseSharedCommunicator.name=num
```

### Description

If `num` is set to a value larger than zero, the service manager supplies the service with the given `name` a communicator that might be shared by other services. If the `#IceBox.InheritProperties` property is also defined, the shared communicator inherits the properties of the IceBox server. If not defined, the default value is zero.

## IceBoxAdmin Properties

### IceBoxAdmin.ServiceManager.Proxy

#### **Synopsis**

`IceBoxAdmin.ServiceManager.Proxy=proxy`

#### **Description**

This property configures the proxy that is used by the [iceboxadmin](#) utility to locate the service manager.

## IceGrid Properties

On this page:

- IceGrid.InstanceName
- IceGrid.Node.AllowEndpointsOverride
- IceGrid.Node.AllowRunningServersAsRoot
- IceGrid.Node.*AdapterProperty*
- IceGrid.Node.CollocateRegistry
- IceGrid.Node.Data
- IceGrid.Node.DisableOnFailure
- IceGrid.Node.Name
- IceGrid.Node.Output
- IceGrid.Node.PrintServersReady
- IceGrid.Node.ProcessorSocketCount
- IceGrid.Node.PropertiesOverride
- IceGrid.Node.RedirectErrToOut
- IceGrid.Node.Trace.Activator
- IceGrid.Node.Trace.Adapter
- IceGrid.Node.Trace.Patch
- IceGrid.Node.Trace.Replica
- IceGrid.Node.Trace.Server
- IceGrid.Node.UserAccountMapper
- IceGrid.Node.UserAccounts
- IceGrid.Node.WaitTime
- IceGrid.Registry.AdminCryptPasswords
- IceGrid.Registry.AdminPermissionsVerifier
- IceGrid.Registry.AdminSessionFilters
- IceGrid.Registry.AdminSessionManager.*AdapterProperty*
- IceGrid.Registry.AdminSSLPermissionsVerifier
- IceGrid.Registry.Client.*AdapterProperty*
- IceGrid.Registry.CryptPasswords
- IceGrid.Registry.Data
- IceGrid.Registry.DefaultTemplates
- IceGrid.Registry.DynamicRegistration
- IceGrid.Registry.Internal.*AdapterProperty*
- IceGrid.Registry.NodeSessionTimeout
- IceGrid.Registry.PermissionsVerifier
- IceGrid.Registry.ReplicaName
- IceGrid.Registry.ReplicaSessionTimeout
- IceGrid.Registry.Server.*AdapterProperty*
- IceGrid.Registry.SessionFilters
- IceGrid.Registry.SessionManager.*AdapterProperty*
- IceGrid.Registry.SessionTimeout
- IceGrid.Registry.SSLPermissionsVerifier
- IceGrid.Registry.Trace.Adapter
- IceGrid.Registry.Trace.Application
- IceGrid.Registry.Trace.Locator
- IceGrid.Registry.Trace.Node
- IceGrid.Registry.Trace.Object
- IceGrid.Registry.Trace.Patch
- IceGrid.Registry.Trace.Replica
- IceGrid.Registry.Trace.Server
- IceGrid.Registry.Trace.Session
- IceGrid.Registry.UserAccounts

### IceGrid.InstanceName



**Synopsis**

`IceGrid.InstanceName=name`

**Description**

Specifies an alternate identity category for the [well-known IceGrid objects](#). If defined, the identities of the IceGrid objects become:

```
name/AdminSessionManager
name/AdminSessionManager-replica
name/AdminSSLSessionManager
name/AdminSSLSessionManager-replica
name/NullPermissionsVerifier
name/NullSSLPermissionsVerifier
name/Locator
name/Query
name/Registry
name/Registry-replica
name/RegistryUserAccountMapper
name/RegistryUserAccountMapper-replica
name/SessionManager
name/SSLSessionManager
```

If not specified, the default identity category is `IceGrid`.

**IceGrid.Node.AllowEndpointsOverride****Synopsis**

`IceGrid.Node.AllowEndpointsOverride=num`

If `num` is set to a non-zero value, an IceGrid node permits servers to override previously set endpoints even if the server is active. Setting this property to a non-zero value is necessary if the servers managed by the node use the object adapter operation `refreshPublishedEndpoints`. The default value of `num` is zero.

**IceGrid.Node.AllowRunningServersAsRoot****Synopsis**

`IceGrid.Node.AllowRunningServersAsRoot=num`

If `num` is set to a non-zero value, an IceGrid node will permit servers started by the node to run with super-user privileges. Note that you should not set this property unless the node uses a secure endpoint; otherwise, clients can start arbitrary processes with super-user privileges on the node's machine.

The default value of `num` is zero.

**IceGrid.Node.AdapterProperty****Synopsis**

`IceGrid.Node.AdapterProperty=value`

**Description**

An IceGrid node uses the adapter name `IceGrid.Node` for the object adapter that the registry contacts to communicate with the node.

Therefore, [adapter properties](#) can be used to configure this adapter.

## IceGrid.Node.CollocateRegistry

### Synopsis

```
IceGrid.Node.CollocateRegistry=num
```

### Description

If *num* is set to a value larger than zero, the [node](#) collocates the IceGrid registry.

The collocated registry is configured with the same properties as the standalone IceGrid registry.

## IceGrid.Node.Data

### Synopsis

```
IceGrid.Node.Data=path
```

### Description

Defines the path of the IceGrid node [data directory](#). The node creates `distrib`, `servers`, and `tmp` subdirectories in this directory if they do not already exist. The `distrib` directory contains [distribution](#) files downloaded by the node from an IcePatch2 server. The `servers` directory contains configuration data for each [deployed server](#). The `tmp` directory holds temporary files.

## IceGrid.Node.DisableOnFailure

### Synopsis

```
IceGrid.Node.DisableOnFailure=num
```

### Description

The node considers a server to have terminated improperly if it has a non-zero exit code or if it exits due to one of the signals `SIGABRT`, `SIGBUS`, `SIGILL`, `SIGFPE`, or `SIGSEGV`. The node marks such a server as disabled if *num* is a non-zero value; a [disabled server](#) cannot be activated on demand. For values of *num* greater than zero, the server is disabled for *num* seconds. If *num* is a negative value, the server is disabled indefinitely, or until it is explicitly enabled or started via an administrative action. The default value is zero, meaning the node does not disable servers in this situation.

## IceGrid.Node.Name

### Synopsis

```
IceGrid.Node.Name=name
```

### Description

Defines the *name* of the IceGrid node. All nodes using the same registry must have unique names; a node refuses to start if there is a node with the same name running already. This property must be defined for each node.

## IceGrid.Node.Output

### Synopsis

```
IceGrid.Node.Output=path
```

**Description**

Defines the path of the IceGrid node output directory. If set, the node redirects the `stdout` and `stderr` output of the started servers to files named `server.out` and `server.err` in this directory. Otherwise, the started servers share the `stdout` and `stderr` of the node's process.

**IceGrid.Node.PrintServersReady****Synopsis**

```
IceGrid.Node.PrintServersReady=token
```

**Description**

The IceGrid node prints "*token* ready" on standard output after all the servers managed by the node are ready. This is useful for scripts that wish to wait until all servers have been started and are ready for use.

**IceGrid.Node.ProcessorSocketCount****Synopsis**

```
IceGrid.Node.ProcessorSocketCount=num
```

**Description**

This property sets the number of processor sockets. This value is reported by the `icegridadmin node sockets` command. On Windows Vista (or later), Windows Server 2008 (or later), and Linux systems, the number of processor sockets is set automatically by the Ice run time. On other systems, the run time cannot obtain the socket count from the operating system; you can use this property to set the number of processor sockets manually on such systems.

**IceGrid.Node.PropertiesOverride****Synopsis**

```
IceGrid.Node.PropertiesOverride=overrides
```

**Description**

Defines a list of properties that override the properties defined in server deployment descriptors. For example, in some cases it is desirable to set the property `Ice.Default.Host` for servers, but not in server deployment descriptors. The property definitions must be separated by white space.

**IceGrid.Node.RedirectErrToOut****Synopsis**

```
IceGrid.Node.RedirectErrToOut=num
```

**Description**

If *num* is set to a value larger than zero, the `stderr` of each started server is redirected to the server's `stdout`.

**IceGrid.Node.Trace.Activator****Synopsis**

`IceGrid.Node.Trace.Activator=num`

### **Description**

The activator trace level:

0	No activator trace (default).
1	Trace process activation, termination.
2	Like 1, but more verbose, including process signaling and more diagnostic messages on process activation.
3	Like 2, but more verbose, including more diagnostic messages on process activation (e.g., path, working directory, and arguments of the activated process).

## **IceGrid.Node.Trace.Adapter**

### **Synopsis**

`IceGrid.Node.Trace.Adapter=num`

### **Description**

The object adapter trace level:

0	No object adapter trace (default).
1	Trace object adapter addition, removal.
2	Like 1, but more verbose, including object adapter activation and deactivation and more diagnostic messages.
3	Like 2, but more verbose, including object adapter transitional state change (for example, "waiting for activation").

## **IceGrid.Node.Trace.Patch**

### **Synopsis**

`IceGrid.Node.Trace.Patch=num`

### **Description**

The patch trace level:

0	No patching trace (default).
1	Show summary of patch progress.
2	Like 1, but more verbose, including download statistics.
3	Like 2, but more verbose, including checksum information.

## **IceGrid.Node.Trace.Replica**

**Synopsis**

`IceGrid.Node.Trace.Replica=num`

**Description**

The replica trace level:

0	No replica trace (default).
1	Trace session lifecycle between nodes and replicas.
2	Like 1, but more verbose, including session establishment attempts and failures.
3	Like 2, but more verbose, including keep alive messages sent to the replica.

**IceGrid.Node.Trace.Server****Synopsis**

`IceGrid.Node.Trace.Server=num`

**Description**

The server trace level:

0	No server trace (default).
1	Trace server addition, removal.
2	Like 1, but more verbose, including server activation and deactivation, property updates, and more diagnostic messages.
3	Like 2, but more verbose, including server transitional state change (activating and deactivating).

**IceGrid.Node.UserAccountMapper****Synopsis**

`IceGrid.Node.UserAccountMapper=proxy`

**Description**

Specifies the proxy of an object that implements the `IceGrid::UserAccountMapper` interface for [customizing](#) the user accounts under which servers are activated. The IceGrid node invokes this proxy to map session identifiers (the user ID for sessions created with a user ID and password, or the distinguished name for sessions created from a secure connection) to user accounts.

As a proxy property, you can configure additional [aspects of the proxy](#) using properties.

**IceGrid.Node.UserAccounts****Synopsis**

`IceGrid.Node.UserAccounts=file`

**Description**

Specifies the file name of an IceGrid node user account map file. Each line of the file must contain an identifier and a user account, separated by white space. The identifier will be matched against the client session identifier (the user ID for sessions created with a user ID and password, or the distinguished name for sessions created from a secure connection). This user account map file is used by the node to [map session identifiers to user accounts](#). This property is ignored if `IceGrid.Node.UserAccountMapper` is defined.

**IceGrid.Node.WaitTime****Synopsis**

```
IceGrid.Node.WaitTime=num
```

**Description**

Defines the interval in seconds that IceGrid waits for [server activation and deactivation](#).

If a server is automatically activated and does not register its object adapter endpoints within this time interval, the node assumes there is a problem with the server and returns an empty set of endpoints to the client.

If a server is being gracefully deactivated and IceGrid does not detect the server deactivation during this time interval, IceGrid kills the server.

The default value is 60 seconds.

**IceGrid.Registry.AdminCryptPasswords****Synopsis**

```
IceGrid.Registry.AdminCryptPasswords=file
```

**Description**

Specifies the file name of an IceGrid registry [access control list for administrative clients](#). Each line of the file must contain a user name and a password, separated by white space. The password must be a 13-character crypt-encoded string. If this property is not defined, the default value is `admin_passwords`. This property is ignored if `IceGrid.Registry.AdminPermissionsVerifier` is defined.

**IceGrid.Registry.AdminPermissionsVerifier****Synopsis**

```
IceGrid.Registry.AdminPermissionsVerifier=proxy
```

**Description**

Specifies the proxy of an object that implements the `Glacier2::PermissionsVerifier` interface for [controlling access to IceGrid administrative sessions](#). The IceGrid registry invokes this proxy to validate each new administrative session created by a client with the `IceGrid::Registry` interface.

As a proxy property, you can configure additional [aspects of the proxy](#) using properties.

**IceGrid.Registry.AdminSessionFilters****Synopsis**

```
IceGrid.Registry.AdminSessionFilters=num
```

**Description**

This property controls whether IceGrid establishes filters for sessions created with the [IceGrid session manager](#). If *num* is set to a value larger than zero, IceGrid establishes these filters, so [Glacier2](#) limits access to the `IceGrid::AdminSession` object and the `IceGrid::Admin` object that is returned by the `getAdmin` operation. If *num* is set to zero, IceGrid does not establish filters, so access to these objects is controlled solely by Glacier2's configuration.

The default value is 1.

**IceGrid.Registry.AdminSessionManager.AdapterProperty****Synopsis**

```
IceGrid.Registry.AdminSessionManager.AdapterProperty=value
```

**Description**

The IceGrid registry uses the adapter name `IceGrid.Registry.AdminSessionManager` for the object adapter that processes incoming requests from [IceGrid administrative sessions](#). Therefore, [adapter properties](#) can be used to configure this adapter. (Note any setting of `IceGrid.Registry.AdminSessionManager.AdapterId` is ignored because the registry always provides a direct adapter.)

For security reasons, defining endpoints for this object adapter is optional. If you do define endpoints, they should only be accessible to Glacier2 routers used to create IceGrid administrative sessions.

**IceGrid.Registry.AdminSSLPermissionsVerifier****Synopsis**

```
IceGrid.Registry.AdminSSLPermissionsVerifier=proxy
```

**Description**

Specifies the proxy of an object that implements the `Glacier2::SSLPermissionsVerifier` interface for [controlling access to IceGrid administrative sessions](#). The IceGrid registry invokes this proxy to validate each new administrative session created by a client from a secure connection with the `IceGrid::Registry` interface.

As a proxy property, you can configure additional [aspects of the proxy](#) using the properties.

**IceGrid.Registry.Client.AdapterProperty****Synopsis**

```
IceGrid.Registry.Client.AdapterProperty=value
```

**Description**

IceGrid uses the adapter name `IceGrid.Registry.Client` for the object adapter that processes incoming requests from clients. Therefore, [adapter properties](#) can be used to configure this adapter. (Note any setting of `IceGrid.Registry.Client.AdapterId` is ignored because the registry always provides a direct adapter.)

Note that `IceGrid.Registry.Client.Endpoints` controls the client endpoint for the registry. The port numbers 4061 (for TCP) and 4062 (for SSL) are reserved for the registry by the [Internet Assigned Numbers Authority \(IANA\)](#).

**IceGrid.Registry.CryptPasswords****Synopsis**

```
IceGrid.Registry.CryptPasswords=file
```

### Description

Specifies the file name of an IceGrid registry [access control list](#). Each line of the file must contain a user name and a password, separated by white space. The password must be a 13-character crypt-encoded string. If this property is not defined, the default value is `passwords`. This property is ignored if `IceGrid.Registry.PermissionsVerifier` is defined.

## IceGrid.Registry.Data

### Synopsis

```
IceGrid.Registry.Data=path
```

### Description

Defines the path of the IceGrid registry [data directory](#). The directory specified in `path` must already exist. This property must be defined only when the registry uses [Freeze](#) or SQLite for its database storage.

## IceGrid.Registry.DefaultTemplates

### Synopsis

```
IceGrid.Registry.DefaultTemplates=path
```

### Description

Defines the path name of an XML file containing default [template descriptors](#). A sample file named `config/templates.xml` that contains convenient server templates for Ice services is provided in the Ice distribution.

## IceGrid.Registry.DynamicRegistration

### Synopsis

```
IceGrid.Registry.DynamicRegistration=num
```

### Description

If `num` is set to a value larger than zero, the locator registry does not require Ice servers to preregister object adapters and replica groups, but rather creates them automatically if they do not exist. If this property is not defined, or `num` is set to zero, an attempt to register an unknown object adapter or replica group causes adapter activation to fail with `Ice.NotRegisteredException`. An object adapter registers itself when the `adapter.AdapterId` property is defined. The `adapter.ReplicaGroupId` property identifies the replica group.

## IceGrid.Registry.Internal.AdapterProperty

### Synopsis

```
IceGrid.Registry.Internal.AdapterProperty=value
```

### Description

The IceGrid registry uses the adapter name `IceGrid.Registry.Internal` for the object adapter that processes incoming requests from nodes and slave replicas. Therefore, [adapter properties](#) can be used to configure this adapter. (Note any setting of `IceGrid.Registry.Internal.AdapterId` is ignored because the registry always provides a direct adapter.)



## IceGrid.Registry.NodeSessionTimeout

### Synopsis

```
IceGrid.Registry.NodeSessionTimeout=num
```

### Description

Each IceGrid node establishes a session with the registry that must be refreshed periodically. If a node does not refresh its session within *num* seconds, the node's session is destroyed and the servers deployed on that node become unavailable to new clients. If not specified, the default value is 30 seconds.

## IceGrid.Registry.PermissionsVerifier

### Synopsis

```
IceGrid.Registry.PermissionsVerifier=proxy
```

### Description

Specifies the proxy of an object that implements the `Glacier2::PermissionsVerifier` interface for [controlling access to IceGrid sessions](#). The IceGrid registry invokes this proxy to validate each new client session created by a client with the `IceGrid::Registry` interface.

As a proxy property, you can configure additional [aspects of the proxy](#) using properties.

## IceGrid.Registry.ReplicaName

### Synopsis

```
IceGrid.Registry.ReplicaName=name
```

### Description

Specifies the name of a [registry replica](#). If not defined, the default value is `Master`, which is the name reserved for the master replica. Each registry replica must have a unique name.

## IceGrid.Registry.ReplicaSessionTimeout

### Synopsis

```
IceGrid.Registry.ReplicaSessionTimeout=num
```

### Description

Each IceGrid [registry replica](#) establishes a session with the master registry that must be refreshed periodically. If a replica does not refresh its session within *num* seconds, the replica's session is destroyed and the replica no longer receives replication information from the master registry. If not specified, the default value is 30 seconds.

## IceGrid.Registry.Server.AdapterProperty

### Synopsis

```
IceGrid.Registry.Server.AdapterProperty=value
```

**Description**

The IceGrid registry uses the adapter name `IceGrid.Registry.Server` for the object adapter that processes incoming requests from servers. Therefore, [adapter properties](#) can be used to configure this adapter. (Note any setting of `IceGrid.Registry.Server.AdapterId` is ignored because the registry always provides a direct adapter.)

**IceGrid.Registry.SessionFilters****Synopsis**

```
IceGrid.Registry.SessionFilters=num
```

**Description**

This property controls whether IceGrid establishes filters for sessions created with the [IceGrid session manager](#). If `num` is set to a value larger than zero, IceGrid establishes these filters, so Glacier2 limits access to the `IceGrid::Query` and `IceGrid::Session` objects, and to objects and adapters allocated by the session. If `num` is set to zero, IceGrid does not establish filters, so access to objects is controlled solely by Glacier2's configuration.

The default value is 0.

**IceGrid.Registry.SessionManager.AdapterProperty****Synopsis**

```
IceGrid.Registry.SessionManager.AdapterProperty=value
```

**Description**

The IceGrid registry uses the adapter name `IceGrid.Registry.SessionManager` for the object adapter that processes incoming requests from [client sessions](#). Therefore, [adapter properties](#) can be used to configure this adapter. (Note any setting of `IceGrid.Registry.SessionManager.AdapterId` is ignored because the registry always provides a direct adapter.)

For security reasons, defining endpoints for this object adapter is optional. If you do define endpoints, they should only be accessible to Glacier2 routers used to create IceGrid client sessions.

**IceGrid.Registry.SessionTimeout****Synopsis**

```
IceGrid.Registry.SessionTimeout=num
```

**Description**

IceGrid [clients](#) or [administrative clients](#) might establish a session with the registry. This session must be refreshed periodically. If the client does not refresh its session within `num` seconds, the session is destroyed. If not specified, the default value is 30 seconds.

**IceGrid.Registry.SSLPermissionsVerifier****Synopsis**

```
IceGrid.Registry.SSLPermissionsVerifier=proxy
```

**Description**

Specifies the proxy of an object that implements the `Glacier2::SSLPermissionsVerifier` interface for [controlling access to IceGrid](#)

**sessions.** The IceGrid registry invokes this proxy to validate each new client session created by a client from a secure connection with the `IceGrid::Registry` interface.

As a proxy property, you can configure additional [aspects of the proxy](#) using properties.

## IceGrid.Registry.Trace.Adapter

### Synopsis

`IceGrid.Registry.Trace.Adapter=num`

### Description

The object adapter trace level:

0	No object adapter trace (default).
1	Trace object adapter registration, removal, and replication.

## IceGrid.Registry.Trace.Application

### Synopsis

`IceGrid.Registry.Trace.Application=num`

### Description

The application trace level:

0	No application trace (default).
1	Trace application addition, update, and removal.

## IceGrid.Registry.Trace.Locator

### Synopsis

`IceGrid.Registry.Trace.Locator=num`

### Description

The locator and locator registry trace level:

0	No locator trace (default).
1	Trace failures to locate an adapter or object, and failures to register adapter endpoints.
2	Like 1, but more verbose, including registration of adapter endpoints.

## IceGrid.Registry.Trace.Node

### Synopsis

`IceGrid.Registry.Trace.Node=num`

**Description**

The node trace level:

0	No node trace (default).
1	Trace node registration, removal.
2	Like 1, but more verbose, including load statistics.

**IceGrid.Registry.Trace.Object****Synopsis**

`IceGrid.Registry.Trace.Object=num`

**Description**

The object trace level:

0	No object trace (default).
1	Trace object registration, removal.

**IceGrid.Registry.Trace.Patch****Synopsis**

`IceGrid.Registry.Trace.Patch=num`

**Description**

The patch trace level:

0	No patching trace (default).
1	Show summary of patch progress.

**IceGrid.Registry.Trace.Replica****Synopsis**

`IceGrid.Registry.Trace.Replica=num`

**Description**

The server trace level:

0	No server trace (default).
1	Trace session lifecycle between master replica and slaves.

**IceGrid.Registry.Trace.Server****Synopsis**

`IceGrid.Registry.Trace.Server=num`

### **Description**

The server trace level:

0	No server trace (default).
1	Trace server registration, removal.

## **IceGrid.Registry.Trace.Session**

### **Synopsis**

`IceGrid.Registry.Trace.Session=num`

### **Description**

The session trace level:

0	No client or admin session trace (default).
1	Trace client or admin session registration, removal.
2	Like 1, but more verbose, includes keep alive messages.

## **IceGrid.Registry.UserAccounts**

### **Synopsis**

`IceGrid.Registry.UserAccounts=file`

### **Description**

Specifies the file name of an IceGrid registry user account map file. Each line of the file must contain an identifier and a user account, separated by white space. The identifier will be matched against the client session identifier (the user ID for sessions created with a user ID and password, or the distinguished name for sessions created from a secure connection). This user account map file is used by IceGrid nodes to map session identifiers to user accounts if the nodes' `IceGrid.Node.UserAccountMapper` property is set to the proxy `IceGrid/RegistryUserAccountMapper`.

## IceGrid Administrative Client Properties

On this page:

- [IceGridAdmin.AuthenticateUsingSSL](#)
- [IceGridAdmin.Password](#)
- [IceGridAdmin.Replica](#)
- [IceGridAdmin.Trace.Observers](#)
- [IceGridAdmin.Trace.SaveToRegistry](#)
- [IceGridAdmin.Username](#)

### IceGridAdmin.AuthenticateUsingSSL

#### Synopsis

```
IceGridAdmin.AuthenticateUsingSSL=num
```

#### Description

If *num* is a value greater than zero, `icegridadmin` uses SSL authentication when establishing its session with the IceGrid registry. If not defined or the value is zero, `icegridadmin` uses user name and password authentication.

### IceGridAdmin.Password

#### Synopsis

```
IceGridAdmin.Password=password
```

#### Description

Specifies the password that `icegridadmin` should use when authenticating its session with the IceGrid registry. For security reasons you may prefer not to define a password in a plain-text configuration property, in which case you should omit this property and allow `icegridadmin` to prompt you for it interactively. This property is ignored when SSL authentication is enabled via `#IceGridAdmin.AuthenticateUsingSSL`.

### IceGridAdmin.Replica

#### Synopsis

```
IceGridAdmin.Replica=name
```

#### Description

Specifies the name of the registry replica that `icegridadmin` should contact. If not defined, the default value is `Master`.

### IceGridAdmin.Trace.Observers

#### Synopsis

```
IceGridAdmin.Trace.Observers=num
```

#### Description

If *num* is a value greater than zero, the IceGrid graphical administrative client displays trace information about the observer callbacks it receives from the registry. If not defined, the default value is zero.

## IceGridAdmin.Trace.SaveToRegistry

### **Synopsis**

`IceGridAdmin.Trace.SaveToRegistry=num`

### **Description**

If *num* is a value greater than zero, the IceGrid graphical administrative client displays trace information about the modifications it commits to the registry. If not defined, the default value is zero.

## IceGridAdmin.Username

### **Synopsis**

`IceGridAdmin.Username=name`

### **Description**

Specifies the username that `icegridadmin` should use when authenticating its session with the IceGrid registry. This property is ignored when SSL authentication is enabled via `#IceGridAdmin.AuthenticateUsingSSL`.

## IceMX Metrics Properties

On this page:

- [prefix.GroupBy](#)
- [prefix.Accept.attribute](#)
- [prefix.Reject.attribute](#)
- [prefix.Disabled](#)
- [prefix.RetainDetached](#)

Metrics view are configured with the properties described below. The *prefix* below can be replaced with one of the following:

- IceMX.Metrics.view-name
- IceMX.Metrics.view-name.Map.map-name
- IceMX.Metrics.view-name.Map.map-name.Map.submap-name

If a view is defined without Map properties, the view will contain all the metrics map known by the [Metrics facet](#). If a view defines one or more map properties it will only contain these maps.

For a list of supported maps see:

- [The Metrics Facet](#)
- [Glacier2 Metrics](#)
- [IceStorm Metrics](#)

### ***prefix.GroupBy***

#### **Synopsis**

*prefix.GroupBy=delimited attributes*

#### **Description**

This property defines how metrics are grouped and how the ID of each metrics object is created. The grouping is based on attributes specific to the instrumented object or operation. For example, you can group the invocation metrics by operation name or proxy identity. All the invocations with the same operation name or proxy identity will record metrics using the same metrics object. You can specify several attributes to group metrics based on multiple attributes. You must delimit the attributes with delimiters when specify the value of the GroupBy property. A delimiter is any character which is not an alpha numeric or the dot character. Attributes which can be used to specify the value of this property are defined in relevant section of the Ice manual. Here are some examples of GroupBy properties.

- IceMX.Metrics.MyView.GroupBy=operation
- IceMX.Metrics.MyView.GroupBy=identity [operation]
- IceMX.Metrics.MyView.GroupBy=remoteHost:remotePort

### ***prefix.Accept.attribute***

#### **Synopsis**

*prefix.Accept.attribute=regex*

#### **Description**

This property defines a rule to accept the monitoring of an instrumented object or operation based on the value of one of its attribute. If the *attribute* matches the specified *regex* and if it satisfies other *Accept* and *Reject* filters the instrumented object or operation will be monitored.

For example, to accept monitoring instrumented objects or operations which are from the object adapter named "MyAdapter", you can setup the following accept property:



- `IceMX.Metrics.MyView.Accept.parent=MyAdapter`

## ***prefix.Reject.attribute***

### **Synopsis**

`prefix.Reject.attribute=regex`

### **Description**

This property defines a rule to accept the monitoring of an instrumented object or operation based on the value of one of its attribute. If the `attribute` matches the specified `regex` and if it satisfies other `Accept` and `Reject` filters the instrumented object or operation will be monitored.

For example, to reject monitoring instrumented objects or operations which are from the object adapter named "Ice.Admin", you can setup the following reject property:

- `IceMX.Metrics.MyView.Reject.parent=Ice\.Admin`

## ***prefix.Disabled***

### **Synopsis**

`prefix.Disabled=num`

### **Description**

If `num` is set to a value larger than zero, the metrics view or the map is disabled. This property is useful to pre-configure a view or map. The view can be disabled initially to not incur overhead and enabled only when needed at runtime.

## ***prefix.RetainDetached***

### **Synopsis**

`prefix.RetainedDetached=num`

### **Description**

If `num` is set to a value larger than zero, up to `num` metrics object whose `current` value is 0 will be kept in memory by the metrics map. This is useful to prevent indefinite memory growth if the monitoring of an instrumented object or operation creates a unique metrics object, only the last `num` metrics object will be kept in memory. The default value is 10, meaning that at most ten metrics object with a `current` value equal to 0 will be retained by the metrics map.

## IceStorm Properties

IceStorm is an IceBox service that you can install using any name you like. For example:

```
IceBox.Service.DataFeed=IceStormService, ...
```

The service name you choose is also used as the prefix for IceStorm's configuration properties. In the example above, the IceStorm configuration properties would use the `DataFeed` prefix, as in `DataFeed.Discard.Interval=10`.

In the property descriptions below, replace *service* with the service name from your IceStorm configuration.

On this page:

- `service.Discard.Interval`
- `service.Election.ElectionTimeout`
- `service.Election.MasterTimeout`
- `service.Election.ResponseTimeout`
- `service.Flush.Timeout`
- `service.InstanceName`
- `service.Node.AdapterProperty`
- `service.NodeId`
- `service.Nodes.id`
- `service.Publish.AdapterProperty`
- `service.ReplicatedPublishEndpoints`
- `service.ReplicatedTopicManagerEndpoints`
- `service.Send.Timeout`
- `service.TopicManager.AdapterProperty`
- `service.Trace.Election`
- `service.Trace.Replication`
- `service.Trace.Subscriber`
- `service.Trace.Topic`
- `service.Trace.TopicManager`
- `service.Transient`
- `IceStormAdmin.TopicManager.Default`
- `IceStormAdmin.TopicManager.name`

### ***service.Discard.Interval***

#### **Synopsis**

```
service.Discard.Interval=num
```

#### **Description**

An IceStorm server detects when a subscriber to which it forwards events becomes non-functional and, at that point, stops delivery attempts to that subscriber for *num* seconds before trying to forward events to that subscriber again. The default value of this property is 60 seconds.

### ***service.Election.ElectionTimeout***

#### **Synopsis**

```
service.Election.ElectionTimeout=num
```

#### **Description**

This property is used by a [replicated IceStorm deployment](#). It specifies the interval in seconds at which a coordinator attempts to form larger groups of replicas. If not defined, the default value is 10.

## **service.Election.MasterTimeout**

### **Synopsis**

```
service.Election.MasterTimeout=num
```

### **Description**

This property is used by a [replicated IceStorm deployment](#). It specifies the interval in seconds at which a slave checks the status of the coordinator. If not defined, the default value is 10.

## **service.Election.ResponseTimeout**

### **Synopsis**

```
service.Election.ResponseTimeout=num
```

### **Description**

This property is used by a [replicated IceStorm deployment](#). It specifies the interval in seconds that a replica waits for replies to an invitation to form a larger group. Lower priority replicas wait for intervals inversely proportional to the maximum priority:

$$\text{ResponseTimeout} + \text{ResponseTimeout} * (\text{max} - \text{pri})$$

If not defined, the default value is 10.

## **service.Flush.Timeout**

### **Synopsis**

```
service.Flush.Timeout=num
```

### **Description**

Defines the interval in milliseconds with which events are sent to [batch subscribers](#). The default is 1000ms.

## **service.InstanceName**

### **Synopsis**

```
service.InstanceName=name
```

### **Description**

Specifies an alternate identity category for all [objects](#) hosted by the IceStorm object adapters. If not specified, the default identity category is IceStorm.

## ***service.Node.AdapterProperty***

### **Synopsis**

`service.Node.AdapterProperty=value`

### **Description**

In a [replicated deployment](#), IceStorm uses the adapter name `service.Node` for the replica node's object adapter. Therefore, [adapter properties](#) can be used to configure this adapter.

## ***service.NodeId***

### **Synopsis**

`service.NodeId=value`

### **Description**

Specifies the node ID of an IceStorm [replica](#), where `value` is a non-negative integer. The node ID is also used as the replica's priority, such that a larger value assigns higher priority to the replica. The replica with the highest priority becomes the coordinator of its group. This property must be defined for each replica.

## ***service.Nodes.id***

### **Synopsis**

`service.Nodes.id=value`

### **Description**

This property is used for a manual deployment of [highly available IceStorm](#), in which each of the replicas must be explicitly configured with the proxies of all other replicas. The value is a proxy for the replica with the given node `id`. A replica's object identity has the form `instance-name/nodeid`, such as `DemoIceStorm/node2`.

## ***service.Publish.AdapterProperty***

### **Synopsis**

`service.Publish.AdapterProperty=value`

### **Description**

IceStorm uses the adapter name `service.Publish` for the object adapter that processes incoming requests from publishers. Therefore, [adapter properties](#) can be used to configure this adapter.

## ***service.ReplicatedPublishEndpoints***

### **Synopsis**

`service.ReplicatedPublishEndpoints=value`

### **Description**

This property is used for a manual deployment of [highly available IceStorm](#). It specifies the set of endpoints returned for the publisher proxy returned from `IceStorm::Topic::getPublisher`.

If this property is not defined, the publisher proxy returned by a topic instance points directly at that replica and, should the replica become unavailable, publishers will not transparently failover to other replicas.

## ***service.ReplicatedTopicManagerEndpoints***

### ***Synopsis***

```
service.ReplicatedTopicManagerEndpoints=value
```

### ***Description***

This property is used for a manual deployment of [highly available IceStorm](#). It specifies the set of endpoints used in proxies that refer to a replicated topic. This set of endpoints should contain the endpoints of each IceStorm replica.

For example, the operation `IceStorm::TopicManager::create` returns a proxy that contains this set of endpoints.

## ***service.Send.Timeout***

### ***Synopsis***

```
service.Send.Timeout=num
```

### ***Description***

IceStorm applies a send timeout when it forwards events to subscribers. The value of this property determines how long IceStorm will wait for forwarding of an event to complete. If an event cannot be forwarded within *num* milliseconds, the subscriber is considered dead and its subscription is cancelled. The default value is 60 seconds. Setting this property to a negative value disables timeouts.

## ***service.TopicManager.AdapterProperty***

### ***Synopsis***

```
service.TopicManager.AdapterProperty=value
```

### ***Description***

IceStorm uses the adapter name `service.TopicManager` for the topic manager's object adapter. Therefore, [adapter properties](#) can be used to configure this adapter.

## ***service.Trace.Election***

### ***Synopsis***

```
service.Trace.Election=num
```

### ***Description***

Trace activity related to elections:

0	No election trace (default).
---	------------------------------

1	Trace election activity.
---	--------------------------

## **service.Trace.Replication**

### **Synopsis**

`service.Trace.Replication=num`

### **Description**

Trace activity related to replication:

0	No replication trace (default).
1	Trace replication activity.

## **service.Trace.Subscriber**

### **Synopsis**

`service.Trace.Subscriber=num`

### **Description**

The subscriber trace level:

0	No subscriber trace (default).
1	Trace topic diagnostic information on subscription and unsubscription.
2	Like 1, but more verbose, including state transitions for a subscriber (such as going offline after a temporary network failure, and going online again after a successful retry, etc.).

## **service.Trace.Topic**

### **Synopsis**

`service.Trace.Topic=num`

### **Description**

The topic trace level:

0	No topic trace (default).
1	Trace topic links, subscription, and unsubscription.
2	Like 1, but more verbose, including QoS information, and other diagnostic information.

## **service.Trace.TopicManager**

**Synopsis**

```
service.Trace.TopicManager=num
```

**Description**

The topic manager trace level:

0	No topic manager trace (default).
1	Trace topic creation.

**service.Transient****Synopsis**

```
service.Transient=num
```

**Description**

If *num* is a value greater than zero, IceStorm runs in a fully transient mode in which no database is required. Replication is not supported in this mode. If not defined, the default value is zero.

**IceStormAdmin.TopicManager.Default****Synopsis**

```
IceStormAdmin.TopicManager.Default=proxy
```

**Description**

Defines the proxy for the default IceStorm topic manager. This property is used by `icegridadmin`. IceStorm applications may choose to use this property for their configuration as well.

**IceStormAdmin.TopicManager.name****Synopsis**

```
IceStormAdmin.TopicManager.name=proxy
```

**Description**

Defines a proxy for an IceStorm topic manager for `icestormadmin`. Properties with this pattern are used by `icestormadmin` if multiple topic managers are in use, for example:

```
IceStormAdmin.TopicManager.A=A/TopicManager:tcp -h x -p 9995
IceStormAdmin.TopicManager.B=Foo/TopicManager:tcp -h x -p 9995
IceStormAdmin.TopicManager.C=Bar/TopicManager:tcp -h x -p 9987
```

This sets the proxies for three topic managers. Note that *name* need not match the instance name of the corresponding topic manager — *name* simply serves as a tag. With these property settings, the `icestormadmin` commands that accept a topic can now specify a topic manager other than the default topic manager that is configured with `IceStormAdmin.TopicManager.Default`. For example:

```
current Foo
create myTopic
create Bar/myOtherTopic
```

This sets the current topic manager to the one with instance name `Foo`; the first `create` command then creates the topic within that topic manager, whereas the second `create` command uses the topic manager with instance name `Bar`.



## Glacier2 Properties

On this page:

- `Glacier2.AddConnectionContext`
- `Glacier2.AddSSLContext`
- `Glacier2.AddUserToAllowCategories`
- `Glacier2.Admin.AdapterProperty`
- `Glacier2.AllowCategories`
- `Glacier2.Client.AlwaysBatch`
- `Glacier2.Client.Buffered`
- `Glacier2.Client.AdapterProperty`
- `Glacier2.Client.ForwardContext`
- `Glacier2.Client.SleepTime`
- `Glacier2.Client.Trace.Override`
- `Glacier2.Client.Trace.Reject`
- `Glacier2.Client.Trace.Request`
- `Glacier2.CryptPasswords`
- `Glacier2.Filter.AdapterId.Accept`
- `Glacier2.Filter.Address.Accept`
- `Glacier2.Filter.Address.Reject`
- `Glacier2.Filter.Category.Accept`
- `Glacier2.Filter.Category.AcceptUser`
- `Glacier2.Filter.Identity.Accept`
- `Glacier2.Filter.ProxySizeMax`
- `Glacier2.InstanceName`
- `Glacier2.PermissionsVerifier`
- `Glacier2.ReturnClientProxy`
- `Glacier2.RoutingTable.MaxSize`
- `Glacier2.Server.AdapterProperty`
- `Glacier2.Server.AlwaysBatch`
- `Glacier2.Server.Buffered`
- `Glacier2.Server.ForwardContext`
- `Glacier2.Server.SleepTime`
- `Glacier2.Server.Trace.Override`
- `Glacier2.Server.Trace.Request`
- `Glacier2.SessionManager`
- `Glacier2.SessionTimeout`
- `Glacier2.SSLPermissionsVerifier`
- `Glacier2.SSLSessionManager`
- `Glacier2.Trace.RoutingTable`
- `Glacier2.Trace.Session`

### Glacier2.AddConnectionContext

#### Synopsis

```
Glacier2.AddConnectionContext=num
```

#### Description

If `num` is set to 1 or 2, Glacier2 adds a number of key-value pairs to the [request context](#) that it sends with each request. If `num` is set to 1, these entries are added to the context for all forwarded requests. If `num` is set to 2, the contexts are added only to calls to `checkPermissions` and `authorize` on permission verifiers, and to calls to `create` on session managers.

If `num` is non-zero, Glacier2 adds the following context entries:

<code>_con.type</code>	The type of the connection as returned by <code>Connection::type</code> .
------------------------	---------------------------------------------------------------------------

<code>_con.localAddress</code>	The local address (TCP and SSL only).
<code>_con.localPort</code>	The local port (TCP and SSL only).
<code>_con.remoteAddress</code>	The remote address (TCP and SSL only).
<code>_con.remotePort</code>	The remote port (TCP and SSL only).
<code>_con.cipher</code>	The cipher (SSL only).
<code>_con.peerCert</code>	The first certificate of the client certificate chain (SSL only).

The default value is zero, meaning that no contexts are added.

## Glacier2.AddSSLContext

### Synopsis

`Glacier2.AddSSLContext=num`

### Description

For sessions created with `createSessionFromSecureConnection`, this property, when set to a value greater than zero, instructs Glacier2 to provide additional information in the context of each request:

<code>SSL.Active</code>	If the client established an SSL connection to the router, this entry is present and has the value 1. This entry is not present if SSL was not used.
<code>SSL.Cipher</code>	A description of the ciphersuite negotiated for the SSL connection.
<code>SSL.Remote.Host</code>	The client's originating host name or address.
<code>SSL.Remote.Port</code>	The client's originating port number.
<code>SSL.Local.Host</code>	The router's local host name or address.
<code>SSL.Local.Port</code>	The router's local port number.
<code>SSL.PeerCert</code>	If the client supplied a certificate, this entry is present and contains the encoded certificate in PEM format.

Note that these SSL context entries are forwarded regardless of the setting of `Glacier2.Client.ForwardContext`.

If this property is not defined, its default value is zero.

This property is deprecated and supported only for backward-compatibility. New applications should use `#Glacier2.AddConnectionContext`.

## Glacier2.AddUserToAllowCategories

### Synopsis

`Glacier2.AddUserToAllowCategories=num`

### Description

Specifies whether to add an authenticated user ID to the `#Glacier2.AllowCategories` property when creating a new session. The legal values are shown below:

0	Do not add the user ID (default).
1	Add the user ID.
2	Add the user ID with a leading underscore.

This property is deprecated and supported only for backward-compatibility. New applications should use `#Glacier2.Filter.Category.AcceptUser`.

## Glacier2.Admin.AdapterProperty

### Synopsis

`Glacier2.Admin.AdapterProperty=value`

### Description

Glacier2 uses the adapter name `Glacier2.Admin` for its `administrative` object adapter. Therefore, `adapter properties` can be used to configure this adapter.

The `Glacier2.Admin.Endpoints` property must be defined to enable the administrative object adapter.

Glacier2's administrative interface allows a remote client to shut down the router; we generally recommend the use of endpoints that are accessible only from behind a firewall.

## Glacier2.AllowCategories

### Synopsis

`Glacier2.AllowCategories=list`

### Description

Specifies a white space-separated list of identity categories. If this property is defined, then the Glacier2 router only allows requests to Ice objects with an identity that matches one of the categories from this list. If `#Glacier2.AddUserToAllowCategories` is defined with a non-zero value, the router automatically adds the user ID of each session to this list.

This property is deprecated and supported only for backward-compatibility. New applications should use `#Glacier2.Filter.Category.Accept`.

## Glacier2.Client.AlwaysBatch

### Synopsis

`Glacier2.Client.AlwaysBatch=num`

### Description

If `num` is set to a value larger than zero, the Glacier2 router always batches queued oneway requests from clients to servers regardless of the value of their `_fwd` contexts. This property is only relevant when `#Glacier2.Client.Buffered` is enabled. The default value is 0.

## Glacier2.Client.Buffered

### Synopsis

`Glacier2.Client.Buffered=num`

**Description**

If *num* is set to a value larger than zero, the Glacier2 router operates in [buffered mode](#), in which incoming requests from clients are queued and processed in a separate thread. If *num* is set to zero, the router operates in unbuffered mode in which a request is forwarded in the same thread that received it. The default value is 1.

**Glacier2.Client.AdapterProperty****Synopsis**

```
Glacier2.Client.AdapterProperty=value
```

**Description**

Glacier2 uses the adapter name `Glacier2.Client` for the object adapter that it provides to clients. Therefore, [adapter properties](#) can be used to configure this adapter.

This adapter must be accessible to clients of Glacier2. Use of a secure transport for this adapter is highly recommended.

Note that `Glacier2.Registry.Client.Endpoints` controls the client endpoint for Glacier2. The port numbers 4063 (for TCP) and 4064 (for SSL) are reserved for Glacier2 by the [Internet Assigned Numbers Authority \(IANA\)](#).

**Glacier2.Client.ForwardContext****Synopsis**

```
Glacier2.Client.ForwardContext=num
```

**Description**

If *num* is set to a value larger than zero, the Glacier2 router includes the [request context](#) when forwarding requests from clients to servers. The default value is 0.

**Glacier2.Client.SleepTime****Synopsis**

```
Glacier2.Client.SleepTime=num
```

**Description**

If *num* is set to a value larger than zero, the Glacier2 router sleeps for the specified number of milliseconds after forwarding all queued requests from a client. This delay is useful for [batched delivery](#) because it makes it more likely for events to accumulate in a single batch. Similarly, if [overrides](#) are used, the delay makes it more likely for overrides to actually take effect. This property is only relevant when `#Glacier2.Client.Buffered` is enabled. The default value is 0.

**Glacier2.Client.Trace.Override****Synopsis**

```
Glacier2.Client.Trace.Override=num
```

**Description**

If *num* is set to a value larger than zero, the Glacier2 router logs a trace message whenever a request was [overridden](#). The default value is 0.

## Glacier2.Client.Trace.Reject

### Synopsis

`Glacier2.Client.Trace.Reject=num`

### Description

If `num` is set to a value larger than zero, the Glacier2 router logs a trace message whenever the router's configured [filters](#) reject a client's request. The default value is 0.

## Glacier2.Client.Trace.Request

### Synopsis

`Glacier2.Client.Trace.Request=num`

### Description

If `num` is set to a value larger than zero, the Glacier2 router logs a trace message for each request that is forwarded from a client. The default value is 0.

## Glacier2.CryptPasswords

### Synopsis

`Glacier2.CryptPasswords=file`

### Description

Specifies the file name of a Glacier2 [access control list](#). Each line of the file must contain a user name and a password, separated by white space. The password must be a 13-character crypt-encoded string. This property is ignored if `#Glacier2.PermissionsVerifier` is defined.

## Glacier2.Filter.AdapterId.Accept

### Synopsis

`Glacier2.Filter.AdapterId.Accept=list`

### Description

Specifies a space-separated list of adapter identifiers. If defined, the Glacier2 router [filters requests](#) so that it only allows requests to Ice objects with an adapter identifier that matches one of the entries in this list.

Identifiers that contain spaces must be enclosed in single or double quotes. Single or double quotes that appear within an identifier must be escaped with a leading backslash.

## Glacier2.Filter.Address.Accept

### Synopsis

`Glacier2.Filter.Address.Accept=list`

### Description

Specifies a space-separated list of address-port pairs. When defined, the Glacier2 router [filters requests](#) so that it only allows requests to Ice objects through proxies that contain network endpoint information that matches an address-port pair listed in this property. If not defined, the default value is `*`, which indicates that any network address is permitted. Requests accepted by this property may be rejected by the `#Glacier2.Filter.Address.Reject` property.

Each pair is of the form `address:port`. The `address` or `port` number portion can include wildcards (`*`) or value ranges or groups. Ranges and groups have the form `[value1, value2, value3, ...]` and/or `[value1-value2]`. Wildcards, ranges, and groups may appear anywhere in the address-port pair string.

## Glacier2.Filter.Address.Reject

### Synopsis

```
Glacier2.Filter.Address.Reject=list
```

### Description

Specifies a space-separated list of address-port pairs. When defined, the Glacier2 router rejects requests to Ice objects through proxies that contain network endpoint information that matches an address-port pair listed in this property. If not set, the Glacier2 router allows requests to any network address unless the `#Glacier2.Filter.Address.Accept` property is set, in which case requests will be accepted or rejected based on the `Glacier2.Filter.Address.Accept` property. If both the `Glacier2.Filter.Address.Accept` and `Glacier2.Filter.Address.Reject` properties are defined, the `Glacier2.Filter.Address.Reject` property takes precedence.

Each pair is of the form `address:port`. The `address` or `port` number portion can include wildcards (`*`) or value ranges or groups. Ranges and groups have the form `[value1, value2, value3, ...]` and/or `[value1-value2]`. Wildcards, ranges, and groups may appear anywhere in the address-port pair string.

## Glacier2.Filter.Category.Accept

### Synopsis

```
Glacier2.Filter.Category.Accept=list
```

### Description

Specifies a space-separated list of identity categories. If defined, the Glacier2 router [filters requests](#) so that it only allows requests to Ice objects with an identity that matches one of the categories in this list. If `#Glacier2.Filter.Category.AcceptUser` is defined with a non-zero value, the router automatically adds the user name of each session to this list.

Categories that contain spaces must be enclosed in single or double quotes. Single or double quotes that appear within a category must be escaped with a leading backslash.

## Glacier2.Filter.Category.AcceptUser

### Synopsis

```
Glacier2.Filter.Category.AcceptUser=num
```

### Description

Specifies whether to add an authenticated user ID to the `#Glacier2.Filter.Category.Accept` property when creating a new session. The legal values are shown below:

0	Do not add the user ID (default).
1	Add the user ID.

2

Add the user ID with a leading underscore.

## Glacier2.Filter.Identity.Accept

### Synopsis

```
Glacier2.Filter.Identity.Accept=list
```

### Description

Specifies a space-separated list of identities. If defined, the Glacier2 router [filters requests](#) so that it only allows requests to Ice objects with an identity that matches one of the entries in this list.

Identities that contain spaces must be enclosed in single or double quotes. Single or double quotes that appear within an identity must be escaped with a leading backslash.

## Glacier2.Filter.ProxySizeMax

### Synopsis

```
Glacier2.Filter.ProxySizeMax=num
```

### Description

If set, the Glacier2 router [rejects requests](#) whose stringified proxies are longer than *num*. This helps secure the system against attack. If not set, Glacier2 will accept requests using proxies of any length.

## Glacier2.InstanceName

### Synopsis

```
Glacier2.InstanceName=name
```

### Description

Specifies a default identity category for the [Glacier2 objects](#). If defined, the identity of the Glacier2 administrative interface becomes *name/admin* and the identity of the Glacier2 router interface becomes *name/router*.

If not defined, the default value is `Glacier2`.

## Glacier2.PermissionsVerifier

### Synopsis

```
Glacier2.PermissionsVerifier=proxy
```

### Description

Specifies the proxy of an object that implements the `Glacier2::PermissionsVerifier` interface for [controlling access to Glacier2 sessions](#). The router invokes this proxy to validate the user name and password of each new session. Sessions created from a secure connection are verified by the object specified in `#Glacier2.SSLPermissionsVerifier`. For simple configurations, you can specify the name of a password file using `#Glacier2.CryptPasswords`.

Glacier2 supplies a "null" permissions verifier object that accepts any username and password combination for situations in which no authentication is necessary. To enable this verifier, set the property value to `instance/NullPermissionsVerifier`, where *instance* is the value of `#Glacier2.InstanceName`.

As a proxy property, you can configure additional [aspects of the proxy](#) using properties.

## Glacier2.ReturnClientProxy

### Synopsis

```
Glacier2.ReturnClientProxy=num
```

### Description

If *num* is a value greater than zero, Glacier2 maintains backward compatibility with clients using Ice versions prior to 3.2.0. In this case you should also define `Glacier2.Client.PublishedEndpoints` to specify the endpoints that clients should use to contact the router. For example, if the Glacier2 router resides behind a network firewall, the `Glacier2.Client.PublishedEndpoints` property should specify the firewall's external endpoints.

If not defined, the default value is zero.

## Glacier2.RoutingTable.MaxSize

### Synopsis

```
Glacier2.RoutingTable.MaxSize=num
```

### Description

This property sets the size of the router's [routing table](#) to *num* entries. If more proxies are added to the table than this value, proxies are evicted from the table on a least-recently used basis.

Clients based on Ice version 3.1 and later automatically retry operation calls on evicted proxies and transparently re-add such proxies to the table. Clients based on Ice versions earlier than 3.1 receive an `ObjectNotExistException` for invocations on evicted proxies. For such older clients, *num* must be set to a sufficiently large value to prevent these clients from failing.

The default size of the routing table is 1000.

## Glacier2.Server.AdapterProperty

### Synopsis

```
Glacier2.Server.AdapterProperty=value
```

### Description

Glacier2 uses the adapter name `Glacier2.Server` for the object adapter that it provides to servers. Therefore, [adapter properties](#) can be used to configure this adapter.

This adapter provides access to the `SessionControl` interface and must be accessible to servers that call back to router clients.

## Glacier2.Server.AlwaysBatch

### Synopsis

```
Glacier2.Server.AlwaysBatch=num
```

### Description

If *num* is set to a value larger than zero, the Glacier2 router always batches queued oneway requests from servers to clients regardless of the value of their `_fwd` contexts. This property is only relevant when `#Glacier2.Server.Buffered` is enabled. The default value is 0.



## Glacier2.Server.Buffered

### Synopsis

`Glacier2.Server.Buffered=num`

### Description

If *num* is set to a value larger than zero, the Glacier2 router operates in **buffered mode**, in which incoming requests from servers are queued and processed in a separate thread. If *num* is set to zero, the router operates in **unbuffered mode** in which a request is forwarded in the same thread that received it. The default value is 1.

## Glacier2.Server.ForwardContext

### Synopsis

`Glacier2.Server.ForwardContext=num`

### Description

If *num* is set to a value larger than zero, the Glacier2 router includes the **request context** when forwarding requests from servers to clients. The default value is 0.

## Glacier2.Server.SleepTime

### Synopsis

`Glacier2.Server.SleepTime=num`

### Description

If *num* is set to a value larger than zero, the Glacier2 router sleeps for the specified number of milliseconds after forwarding all queued requests from a server. This delay is useful for **batched delivery** because it makes it more likely for events to accumulate in a single batch. Similarly, if overrides are used, the delay makes it more likely for overrides to actually take effect. This property is only relevant when `#Glacier2.Server.Buffered` is enabled. The default value is 0.

## Glacier2.Server.Trace.Override

### Synopsis

`Glacier2.Server.Trace.Override=num`

### Description

If *num* is set to a value larger than zero, the Glacier2 router logs a trace message whenever a request is **overridden**. The default value is 0.

## Glacier2.Server.Trace.Request

### Synopsis

`Glacier2.Server.Trace.Request=num`

### Description

If *num* is set to a value larger than zero, the Glacier2 router logs a trace message for each request that is forwarded from a server. The

default value is 0.

## Glacier2.SessionManager

### Synopsis

`Glacier2.SessionManager=proxy`

### Description

Specifies the proxy of an object that implements the `Glacier2::SessionManager` interface. The router invokes this proxy to create a new session for a client, but only after the router validates the client's user name and password.

As a proxy property, you can configure additional [aspects of the proxy](#) using properties.

## Glacier2.SessionTimeout

### Synopsis

`Glacier2.SessionTimeout=num`

### Description

If `num` is set to a value larger than zero, a client's session with the Glacier2 router [expires](#) after the specified `num` seconds of inactivity. The default value is 0, meaning sessions do not expire due to inactivity.

It is important to choose `num` such that client sessions do not expire prematurely.

Setting the session timeout enables [Active Connection Management](#) (ACM) for client connections (by setting `Glacier2.Client.ACM`). By default, the ACM timeout is set to twice the session timeout. If no session timeout is defined, ACM is disabled.

## Glacier2.SSLPermissionsVerifier

### Synopsis

`Glacier2.SSLPermissionsVerifier=proxy`

### Description

Specifies the proxy of an object that implements the `Glacier2::SSLPermissionsVerifier` interface for [controlling access to Glacier2 sessions](#). The router invokes this proxy to verify the credentials of clients that attempt to create a session from a secure connection. Sessions created with a user name and password are verified by the object specified in `#Glacier2.PermissionsVerifier`.

Glacier2 supplies a "null" permissions verifier object that accepts the credentials of any client for situations in which no authentication is necessary. To enable this verifier, set the property value to `instance/NullSSLPermissionsVerifier`, where `instance` is the value of `#Glacier2.InstanceName`.

As a proxy property, you can configure additional [aspects of the proxy](#) using properties.

## Glacier2.SSLSessionManager

### Synopsis

`Glacier2.SSLSessionManager=proxy`

### Description

Specifies the proxy of an object that implements the `Glacier2::SSLSessionManager` interface for [managing sessions](#). The router invokes this proxy to create a new session for a client that has called `createSessionFromSecureConnection`.

As a proxy property, you can configure additional [aspects of the proxy](#) using properties.

## Glacier2.Trace.RoutingTable

### Synopsis

`Glacier2.Trace.RoutingTable=num`

### Description

The routing table trace level:

0	No routing table trace (default).
1	Logs a message for each proxy that is added to the routing table.
2	Logs a message for each proxy that is evicted from the routing table (see <code>#Glacier2.RoutingTable.MaxSize</code> ).
3	Combines the output for trace levels 1 and 2.

## Glacier2.Trace.Session

### Synopsis

`Glacier2.Trace.Session=num`

### Description

If `num` is set to a value larger than zero, the Glacier2 router logs trace messages about session-related activities. The default value is 0.

## Freeze Properties

On this page:

- Freeze.DbEnv.*env-name*.CheckpointPeriod
- Freeze.DbEnv.*env-name*.DbHome
- Freeze.DbEnv.*env-name*.DbPrivate
- Freeze.DbEnv.*env-name*.DbRecoverFatal
- Freeze.DbEnv.*env-name*.EncodingVersion
- Freeze.DbEnv.*env-name*.LockFile
- Freeze.DbEnv.*env-name*.OldLogsAutoDelete
- Freeze.DbEnv.*env-name*.PeriodicCheckpointMinSize
- Freeze.Evictor.*env-name.filename.name*.BtreeMinKey
- Freeze.Evictor.*env-name.filename.name*.Checksum
- Freeze.Evictor.*env-name.filename*.MaxTxSize
- Freeze.Evictor.*env-name.filename*.PageSize
- Freeze.Evictor.*env-name.filename*.PopulateEmptyIndices
- Freeze.Evictor.*env-name.filename*.RollbackOnUserException
- Freeze.Evictor.*env-name.filename*.SavePeriod
- Freeze.Evictor.*env-name.filename*.SaveSizeTrigger
- Freeze.Evictor.*env-name.filename*.StreamTimeout
- Freeze.Map.*name*.BtreeMinKey
- Freeze.Map.*name*.Checksum
- Freeze.Map.*name*.PageSize
- Freeze.Trace.DbEnv
- Freeze.Trace.Evictor
- Freeze.Trace.Map
- Freeze.Trace.Transaction
- Freeze.Warn.Deadlocks
- Freeze.Warn.Rollback

### Freeze.DbEnv.*env-name*.CheckpointPeriod

#### Synopsis

```
Freeze.DbEnv.env-name.CheckpointPeriod=num
```

#### Description

Every Berkeley DB environment created by Freeze has an associated thread that checkpoints this environment every *num* seconds. If *num* is less than 0, no checkpointing is performed. The default is 120 seconds.

### Freeze.DbEnv.*env-name*.DbHome

#### Synopsis

```
Freeze.DbEnv.env-name.DbHome=db-home
```

#### Description

Defines the home directory of this Freeze database environment. The default directory is *env-name*.

### Freeze.DbEnv.*env-name*.DbPrivate

**Synopsis**

```
Freeze.DbEnv.env-name.DbPrivate=num
```

**Description**

If *num* is set to a value larger than zero, Freeze instructs Berkeley DB to use process-private memory instead of shared memory. The default value is 1. Set this property to 0 in order to run a [FreezeScript](#) utility, or a Berkeley DB utility such as `db_archive`, on a running environment.

**Freeze.DbEnv.env-name.DbRecoverFatal****Synopsis**

```
Freeze.DbEnv.env-name.DbRecoverFatal=num
```

**Description**

If *num* is set to a value larger than zero, fatal recovery is performed when the environment is opened. The default value is 0.

**Freeze.DbEnv.env-name.EncodingVersion****Synopsis**

```
Freeze.DbEnv.env-name.EncodingVersion=encoding
```

**Description**

Defines the encoding used to decode keys and to encode keys and values. The default value is the value of `Ice.Default.EncodingVersion`.

**Freeze.DbEnv.env-name.LockFile****Synopsis**

```
Freeze.DbEnv.env-name.LockFile=num
```

**Description**

If *num* is set to a value larger than zero, Freeze creates a lock file in the database environment to prevent other processes from opening the environment. The default value is 1.

Note that applications should not normally disable the lock file because simultaneous access to the same environment by multiple processes can lead to data corruption.

[FreezeScript](#) utilities automatically disable the lock file when `Freeze.DbEnv.env-name.DbPrivate` is set to zero.

**Freeze.DbEnv.env-name.OldLogsAutoDelete**

```
Freeze.DbEnv.env-name.OldLogsAutoDelete=num
```

If *num* is set to a value larger than zero, old transactional logs no longer in use are deleted after each periodic checkpoint (see `Freeze.DbEnv.env-name.CheckpointPeriod`). The default value is 1.

## Freeze.DbEnv.*env-name*.PeriodicCheckpointMinSize

### Synopsis

Freeze.DbEnv.*env-name*.PeriodicCheckpointMinSize=*num*

### Description

*num* is the minimum size in kilobytes for the periodic checkpoint (see [Freeze.DbEnv.\*env-name\*.CheckpointPeriod](#)). This value is passed to Berkeley DB's `checkpoint` function. The default is 0 (which means no minimum).

## Freeze.Evictor.*env-name*.*filename*.*name*.BtreeMinKey

### Synopsis

Freeze.Evictor.*env-name*.*filename*.*name*.BtreeMinKey=*num*

### Description

*name* represents a database name or an index name. This property sets the B-tree minkey of the corresponding Berkeley DB database. *num* is ignored if it is less than 2. Please refer to the [Berkeley DB documentation](#) for details.

## Freeze.Evictor.*env-name*.*filename*.*name*.Checksum

### Synopsis

{{Freeze.Evictor.*env-name*.*filename*.Checksum=*num*

### Description

If *num* is greater than 0, checksums on the corresponding Berkeley DB database(s) are enabled. Please refer to the [Berkeley DB documentation](#) for details.

## Freeze.Evictor.*env-name*.*filename*.MaxTxSize

### Synopsis

Freeze.Evictor.*env-name*.*filename*.MaxTxSize=*num*

### Description

Freeze can use a [background thread](#) to save updates to the database. Transactions are used to save many facets together. *num* defines the maximum number of facets saved per transaction. The default is  $10 * \text{SaveSizeTrigger}$  (see [Freeze.Evictor.\*env-name\*.\*filename\*.SaveSizeTrigger](#)); if this value is negative, the actual value is set to 100.

## Freeze.Evictor.*env-name*.*filename*.PageSize

### Synopsis

Freeze.Evictor.*env-name*.*filename*.PageSize=*num*

### Description

If *num* is greater than 0, it sets the page size of the corresponding Berkeley DB database(s). Please refer to the [Berkeley DB documentation](#) for details.

## Freeze.Evictor.*env-name.filename*.PopulateEmptyIndices

### Synopsis

```
Freeze.Evictor.env-name.filename.PopulateEmptyIndices=num
```

### Description

When *num* is not 0 and you create an evictor with one or more empty indexes, the `createBackgroundSaveEvictor` or `createTransactionalEvictor` call will populate these indexes by iterating over all the corresponding facets. This is particularly useful after transforming a Freeze evictor with `FreezeScript`, since `FreezeScript` does not transform indexes; however this can significantly slow down the creation of the evictor if you have an empty index because none of the facets currently in the database match the type of this index. The default value for this property is 0.

## Freeze.Evictor.*env-name.filename*.RollbackOnUserException

### Synopsis

```
Freeze.Evictor.env-name.filename.RollbackOnUserException=num
```

### Description

If *num* is non-zero, a transactional evictor rolls back its transaction if the outcome of the dispatch is a user exception. If *num* is 0 (the default), the transactional evictor commits the transaction.

## Freeze.Evictor.*env-name.filename*.SavePeriod

### Synopsis

```
Freeze.Evictor.env-name.filename.SavePeriod=num
```

### Description

Freeze can use a [background thread](#) to save updates to the database. After *num* milliseconds without saving, if any facet is created, modified, or destroyed, this background thread wakes up to save these facets. When *num* is 0, there is no periodic saving. The default is 6000.

## Freeze.Evictor.*env-name.filename*.SaveSizeTrigger

### Synopsis

```
Freeze.Evictor.env-name.filename.SaveSizeTrigger=num
```

### Description

Freeze can use a [background thread](#) to save updates to the database. When *num* is 0 or positive, as soon as *num* or more facets have been created, modified, or destroyed, this background thread wakes up to save them. When *num* is negative, there is no size trigger. The default is 10.

## Freeze.Evictor.*env-name.filename*.StreamTimeout

### Synopsis

`Freeze.Evictor.env-name.filename.StreamTimeout=num`

### Description

When the saving thread saves an object, it needs to lock this object in order to get a consistent copy of the object's state. If the lock cannot be acquired within *num* seconds, a fatal error is generated. If a [fatal error callback](#) was registered by the application, this callback is called; otherwise the program is terminated immediately. When *num* is 0 or negative, there is no timeout. The default value is 0.

## Freeze.Map.*name*.BtreeMinKey

### Synopsis

`Freeze.Map.name.BtreeMinKey=num`

### Description

*name* may represent a database name or an index name. This property sets the B-tree minkey of the corresponding Berkeley DB database. *num* is ignored if it is less than 2. Please refer to the [Berkeley DB documentation](#) for details.

## Freeze.Map.*name*.Checksum

### Synopsis

`Freeze.Map.name.Checksum=num`

### Description

*name* may represent a database name or an index name. If *num* is greater than 0, checksums for the corresponding Berkeley DB database are enabled. Please refer to the [Berkeley DB documentation](#) for details.

## Freeze.Map.*name*.PageSize

### Synopsis

`Freeze.Map.name.PageSize=num`

### Description

*name* may represent a database name or an index name. If *num* is greater than 0, it sets the page size of the corresponding Berkeley DB database. Please refer to the [Berkeley DB documentation](#) for details.

## Freeze.Trace.DbEnv

### Synopsis

`Freeze.Trace.DbEnv=num`

### Description

The Freeze database environment activity trace level:



0	No database environment activity trace (default).
1	Trace database open and close.
2	Also trace checkpoints and the removal of old log files.

## Freeze.Trace.Evictor

### Synopsis

`Freeze.Trace.Evictor=num`

### Description

The Freeze evictor activity trace level:

0	No evictor activity trace (default).
1	Trace Ice object and facet creation and destruction, facet streaming time, facet saving time, object eviction (every 50 objects) and evictor deactivation.
2	Also trace object lookups, and all object evictions.
3	Also trace object retrieval from the database.

## Freeze.Trace.Map

### Synopsis

`Freeze.Trace.Map=num`

### Description

The Freeze map activity trace level:

0	No map activity trace (default).
1	Trace database open and close.
2	Also trace iterator and transaction operations, and reference counting of the underlying database.

## Freeze.Trace.Transaction

### Synopsis

`Freeze.Trace.Transaction=num`

### Description

The Freeze transaction activity trace level:

0	No transaction activity trace (default).
1	Trace transaction IDs and commit and rollback activity.

## Freeze.Warn.Deadlocks

### **Synopsis**

`Freeze.Warn.Deadlocks=num`

### **Description**

If *num* is set to a value larger than zero, Freeze logs a warning message when a deadlock occur. The default value is 0.

## Freeze.Warn.Rollback

### **Synopsis**

`Freeze.Warn.Deadlocks=num`

### **Description**

If *num* is set to a value larger than zero, Freeze logs a warning message when it rolls back a transaction that goes out of scope together with its associated connection. The default value is 1. (C++ only)

## IcePatch2 Properties

On this page:

- [IcePatch2.AdapterProperty](#)
- [IcePatch2.Directory](#)
- [IcePatch2.InstanceName](#)

### IcePatch2.AdapterProperty

#### Synopsis

```
IcePatch2.AdapterProperty=value
```

#### Description

IcePatch2 uses the adapter name `IcePatch2` for the server. Therefore, [adapter properties](#) can be used to configure this adapter.

### IcePatch2.Directory

#### Synopsis

```
IcePatch2.Directory=dir
```

#### Description

The IcePatch2 server uses this property to determine the data directory if no data directory is specified on the command line.

This property is also used by IcePatch2 clients to determine the local data directory.

### IcePatch2.InstanceName

#### Synopsis

```
IcePatch2.InstanceName=name
```

#### Description

Specifies the identity category for well-known IcePatch2 [objects](#). If defined, the identity of the `IcePatch2::Admin` interface becomes `name/admin` and the identity of the `IcePatch2::FileServer` interface becomes `name/server`.

If not defined, the default value is `IcePatch2`.

## IcePatch2Client Properties

On this page:

- [IcePatch2Client.ChunkSize](#)
- [IcePatch2Client.Directory](#)
- [IcePatch2Client.Proxy](#)
- [IcePatch2Client.Remove](#)
- [IcePatch2Client.Thorough](#)

### IcePatch2Client.ChunkSize

#### Synopsis

`IcePatch2Client.ChunkSize=kilobytes`

#### Description

The IcePatch2 client uses this property to determine how many kilobytes are retrieved with each call to `getFileCompressed`.

The default value is 100.

### IcePatch2Client.Directory

#### Synopsis

`IcePatch2Client.Directory=dir`

#### Description

The IcePatch2 client uses this property to determine the local data directory.

### IcePatch2Client.Proxy

#### Synopsis

`IcePatch2Client.Proxy=proxy`

#### Description

The IcePatch2 client uses this property to locate the IcePatch2 server.

### IcePatch2Client.Remove

#### Synopsis

`IcePatch2Client.Remove=num`

#### Description

This property determines whether IcePatch2 clients delete files that exist locally, but not on the server. A negative or zero value prevents removal of files. A value of 1 enables removal and causes the client to halt with an error if removal of a file fails. A value of 2 or greater also enables removal, but causes the client to silently ignore errors during removal.

The default value is 1.

## IcePatch2Client.Thorough

### **Synopsis**

`IcePatch2Client.Thorough=num`

### **Description**

This property determines whether IcePatch2 clients recompute checksums. Any value greater than zero is interpreted as true. The default value is 0 (false).

## Windows Services

A Windows service is a program that runs in the background and typically does not require user intervention. Similar to a daemon on Unix platforms, a Windows service is usually launched automatically when the operating system starts and runs until the system shuts down.

Ice includes the `Service` class that simplifies the task of writing an Ice-based Windows service in C++. Writing the service is only the first step, however, as it is also critically important that the service be installed and configured correctly for successful operation. Service installation and configuration is outside the scope of the `Service` class because these tasks are generally not performed by the service itself but rather as part of a larger administrative effort to deploy an application. Furthermore, there are security implications to consider when a service is able to install itself: such a service typically needs administrative rights to perform the installation, but does not necessarily need those rights while it is running. A better strategy is to grant administrative rights to a separate installer program and not to the service itself.

### Topics

- [Installing a Windows Service](#)
- [Using the Ice Service Installer](#)
- [Manually Installing a Service](#)
- [Troubleshooting Windows Services](#)

## Installing a Windows Service

The installation of a Windows service varies in complexity with the needs of the application, but usually involves the following activities:

- Selecting the user account in which the service will run.
- Registering the service and establishing its activation mode and dependencies.
- Creating one or more file system directories to contain executables, libraries, and supporting files or databases.
- Configuring those directories with appropriate permissions so that they are accessible to the user account selected for the service.
- Creating keys in the Windows registry.
- Configuring the Windows Event Log so that the service can report status and error messages.

There are many ways to perform these tasks. For example, an administrator can [execute them manually](#). Another option is to write a script or program tailored to the needs of your application. Finally, you can build an installer using a developer tool such as InstallShield.

## Selecting a User Account for the Service

Before installing a service, you should give careful consideration to the user account that will run the service. Unless your service has special requirements, we recommend that you use the built-in account that Windows provides specifically for this purpose. On Windows XP and Windows Server 2003, the fully-qualified name for this account is `NT Authority\LocalService`; in an English locale, its name is displayed as `Local Service`. On Windows Vista (or later), the account name is simply `Local Service`.

### See Also

- [Manually Installing a Service](#)

## Using the Ice Service Installer

Ice provides the command-line tool `iceserviceinstall` to assist you in installing and uninstalling the following Windows services:

- [IceGrid registry](#)
- [IceGrid node](#)
- [Glacier2 router](#)

Ice includes other programs that can also be run as Windows services, such as the [IceBox](#) and [IcePatch2](#) servers. Typically it is not necessary to install these programs as Windows services because they can be launched by an IceGrid node service. However, if you wish to run an IceBox or IcePatch2 server as a Windows service without the use of IceGrid, you must [manually install](#) the service.

Here we describe how to use the Ice service installer and discuss its actions and prerequisites.

On this page:

- [iceserviceinstall Command Line Options](#)
- [Security Considerations for Ice Services](#)
- [iceserviceinstall Configuration File](#)
  - [Sample Configuration Files](#)
- [iceserviceinstall Properties](#)
- [Service Installation Process](#)
- [Uninstalling a Service](#)

### iceserviceinstall Command Line Options

`iceserviceinstall` supports the following options and arguments:

```
iceserviceinstall [options] service config-file [property ...]

Options:
-h, --help Show this message.
-n, --nopause Do not call pause after displaying a message.
-v, --version Display the Ice version.
-u, --uninstall Uninstall the Windows service.
```

The *service* and *config-file* arguments are required during installation and uninstallation.

The *service* argument selects the type of service you are installing; use one of the following values:

- `icegridregistry`
- `icegridnode`
- `glacier2router`

Note that the Ice service installer currently does not support the installation of an IceGrid node with a collocated registry, therefore you must install the registry and node separately.

The *config-file* argument specifies the name of an [Ice configuration file](#).

When installing a service, properties can be defined on the command line using the `--name=value` syntax, or they can be defined in the configuration file. The supported properties are described [below](#).

### Security Considerations for Ice Services

None of the Ice services require privileges beyond a normal user account. In the case of the IceGrid node service in particular, we do not recommend running it in a [user account](#) with elevated privileges because the service is responsible for launching server executables, and



those servers would inherit the node's access rights.

## iceserviceinstall Configuration File

The Ice service installer requires that you specify the path name of the Ice configuration file for the service being installed or uninstalled. The tool needs this path name for several reasons:

- During installation, it verifies that the configuration file has sufficient access rights.
- It configures a newly-installed service to load the configuration file using its absolute path name, therefore you must decide in advance where the file will be located.
- It reads the configuration file and examines certain service-specific properties. For example, prior to installing an IceGrid registry service, the tool verifies that the directory specified by the property `IceGrid.Registry.Data` has sufficient access rights.
- The tool supports its own configuration parameters that may also be defined as [properties](#) in this file.

You may still modify a service's configuration file after installation, but you should uninstall and reinstall the service if you change any of the properties that influence the service installer's actions. The table below describes the service properties that affect the installer:

Property	Service	Description
<code>IceGrid.InstanceName</code>	IceGrid Registry	Value appears in the service name; also included in the default display name if one is not defined.
<code>IceGrid.Node.Data</code>	IceGrid Node	Directory is created if necessary; access rights are verified.
<code>IceGrid.Node.Name</code>	IceGrid Node	Value appears in the service name; also included in the default display name if one is not defined.
<code>IceGrid.Registry.Data</code>	IceGrid Registry	Directory is created if necessary; access rights are verified.
<code>Ice.Default.Locator</code>	IceGrid Node, Glacier2 Router	The IceGrid instance name is derived from the identity in this proxy.
<code>Ice.EventLog.Source</code>	All	Specifies the name of an event log source for the service.

The steps performed by the tool during an installation are described in detail [below](#).

## Sample Configuration Files

Ice includes sample configuration files for the IceGrid and Glacier2 services in the `config` subdirectory of your Ice installation. We recommend that you review the comments and settings in these files to familiarize yourself with a typical configuration of each service.

You can modify a configuration file to suit your needs or copy one to use as a starting point for your own configuration.

## iceserviceinstall Properties

The Ice service installer uses a set of optional properties that customize the installation process. These properties can be defined in the service's configuration file as discussed above, or they can be defined on the command line using the familiar `--name=value` syntax:

```
iceserviceinstall --DependOnRegistry=1 ...
```

The installer's properties are listed below:

- `AutoStart=num`  
If `num` is a value greater than zero, the service is configured to start automatically at system start up. Set this property to zero to configure the service to start on demand instead. If not specified, the default value is 1.
- `DependOnRegistry=num`  
If `num` is a value greater than zero, the service is configured to depend on the IceGrid registry, meaning Windows will start the registry prior to starting this service. Enabling this feature also requires that the property `Ice.Default.Locator` be defined in `config-file`. If not specified, the default value is zero.
- `Description=value`  
A brief description of the service. If not specified, a general description is used.
- `DisplayName=name`  
The friendly name that identifies the service to the user. If not specified, `iceserviceinstall` composes a default display name.
- `EventLog=name`  
The name of the event log used by the service. If not specified, the default value is `Application`.
- `ImagePath=path`  
The path name of the service executable. If not specified, `iceserviceinstall` assumes the service executable resides in the same directory as itself and fails if the executable is not found.
- `ObjectName=name`  
Specifies the account used to run the service. If not specified, the default value is `NT Authority\LocalService`.
- `Password=value`  
The password required by the account specified in `ObjectName`.

## Service Installation Process

The Ice service installer performs a number of steps to install a service. As discussed [earlier](#), you must specify the path name of the service's configuration file because the service installer uses certain properties during the installation process. The actions taken by the service installer are described below:

- Obtain the service's *instance name* from the configuration file. The instance name is specified by the property `IceGrid.InstanceName` or `Glacier2.InstanceName`. If an instance name is not specified, the default value is `IceGrid` or `Glacier2`, respectively. If the service being installed depends on the IceGrid registry, the IceGrid instance name is derived from the value of the `Ice.Default.Locator` property.
- For an IceGrid node, obtain the node's name from the property `IceGrid.Node.Name`. This property must be defined when installing a node.
- Compose the service name from the service type, instance name, and node name (for an IceGrid node). For example, the default service name for an IceGrid registry is `icegridregistry.IceGrid`. Note that the service name is not the same as the display name.
- Resolve the user account specified by `ObjectName`.
- For an IceGrid registry, create the data directory specified by the property `IceGrid.Registry.Data` and ensure that the user account specified by `ObjectName` has read/write access to the directory.
- For an IceGrid node, create the data directory specified by the property `IceGrid.Node.Data` and ensure that the user account specified by `ObjectName` has read/write access to the directory.
- For an IceGrid node, ensure that the user account specified by `ObjectName` has read access to the following registry key:  
`HKLM\SOFTWARE\Microsoft\Windows NT\CurrentVersion\Perflib`  
This key allows the node to access [CPU utilization statistics](#).
- Ensure that the user account specified by `ObjectName` has read/write access to the configuration file.
- Create a new Windows event log by adding the registry key specified by `EventLog`.
- Add an event log source under `EventLog` for the source name specified by `Ice.EventLog.Source`. If this property is not defined, the service name is used as the source name.
- Install the service, including command line arguments that specify the service name (`--service name`) and the absolute path name of the configuration file (`--Ice.Config=config-file`).

The Ice service installer currently does *not* perform these tasks:

- Modify access rights for the service's executable or its DLL dependencies
- Verify that the user account specified by `ObjectName` has the right to "Log on as a service"

## Uninstalling a Service

When uninstalling an existing service, the Ice service installer first ensures that the service is stopped, then proceeds to remove the service. The service's event log source is removed and, if the service is not using the `Application` log, the event log registry key is also removed.

### See Also

- [icegridregistry](#)
- [icegridnode](#)
- [Getting Started with Glacier2](#)
- [IceBox](#)
- [IcePatch2](#)
- [Installing a Windows Service](#)
- [Manually Installing a Service](#)
- [Troubleshooting Windows Services](#)
- [IceGrid Properties](#)
- [Glacier2 Properties](#)

## Manually Installing a Service

This page describes how to manually install and configure an Ice service using the `IcePatch2` service as a case study. For the purposes of this discussion, we assume that Ice is installed in the directory `C:\Ice`. We also assume that you have administrative access to your system, which is required by many of the installation steps discussed below.

On this page:

- [Selecting a User Account for the IcePatch2 Service](#)
- [Preparing a Directory for the IcePatch2 Service](#)
  - [Selecting a Directory for the IcePatch2 Service](#)
  - [Creating the Directory for the IcePatch2 Service](#)
  - [Populating the Directory for the IcePatch2 Service](#)
- [Configuration File for the IcePatch2 Service](#)
- [Creating the IcePatch2 Service](#)
- [Creating the Event Log for the IcePatch2 Service](#)
  - [Using the Application Log for the IcePatch2 Service](#)
  - [Using a Custom Log for the IcePatch2 Service](#)
  - [Registry Caching for the IcePatch2 Service](#)
- [Starting the IcePatch2 Service](#)
- [Testing the IcePatch2 Service](#)

### Selecting a User Account for the IcePatch2 Service

The `IcePatch2` service can run in a regular user account, therefore we will follow our own recommendation and use the `Local Service` account.

### Preparing a Directory for the IcePatch2 Service

The service needs a directory in which to store the files that it distributes to clients. A common mistake is assuming that a service will be able to access a file or directory that you created using your current account, which is likely to cause the service to fail in a way that is difficult to diagnose. To prevent such failures, we will ensure that the directory has the necessary permissions for the service to access it while running in the `Local Service` account.

### Selecting a Directory for the IcePatch2 Service

The directory tree for our `IcePatch2` service is shown below:

```
C:\Documents and Settings\
 LocalService\
 Local Settings\
 Application Data\
 ZeroC\
 icepatch2\
 data\
```

Note that this tree applies to Windows XP and Windows Server 2003, and is locale dependent. On Windows Vista (or later), we would use the following tree instead:

```
C:\Windows\
 ServiceProfiles\
 LocalService\
 AppData\
 Local\
 ZeroC\
 icepatch2\
 data\
```

For this example, we will use the Windows XP directory tree.

### Creating the Directory for the IcePatch2 Service

Since `Local Service` is a built-in account, its user directory should already exist and have the proper access rights.

 If you open `C:\Documents and Settings` in Windows Explorer, the `LocalService` directory may not be visible until you modify your folder options to show protected files and folders.

If the directory does not exist, we can create it in a command window with the following steps:

```
> cd \Documents and Settings
> mkdir LocalService
```

At this point we could create the rest of the directory hierarchy. However, a newly-created directory inherits the privileges of its enclosing directory, and we have not yet modified the privileges of the `LocalService` directory to grant access to the `Local Service` account. At present, the privileges of the `LocalService` directory are inherited from `Documents and Settings` and require modification. In general, it is better to establish the necessary access rights on the parent directory prior to creating any subdirectories, so we will modify the `LocalService` directory first.

On all Windows systems, we can use the command-line utility `cacls`. The following command does what we need:

```
> cacls LocalService /G "Local Service":F Administrators:F
```

By omitting the `/E` option to `cacls`, we have replaced all of the prior access rights on the directory with the rights given in this command. As a result, the `Local Service` account and anyone in the `Administrators` group are granted full access to the directory, while all others are forbidden. (We grant full access to the `Administrators` group because presumably someone other than the `Local Service` account will need to manage the subdirectory, create the configuration file, and so on). You can verify the directory's current privilege settings by running `cacls` without options:

```
> cacls LocalService
```

Now we can create the remaining subdirectories, and they will automatically inherit the access rights established for the `LocalService` directory:

```
> cd LocalService
> mkdir "Local Settings\Application Data\ZeroC\icepatch2\data"
```

If you want to further restrict access to files or subdirectories, you can modify them as necessary using the `cacls` utility. Note however that certain actions may cause a file to revert back to the access rights of its enclosing directory. For example, modifying a file using a text editor is often the equivalent of erasing the file and recreating it, which discards any access rights you may have previously set for the file.

On some versions of Windows XP, and on Windows Server 2003 and Windows Vista (or later), you can manage privilege settings interactively using Windows Explorer. For example, right click on the `LocalService` directory, select Properties, and select the Security tab. Next select Advanced and Edit, uncheck "Include inheritable permissions from this object's parent," and select Copy. Remove all permission entries, then add entries for Local Service and the Administrators group and grant Full Control to each.

## Populating the Directory for the IcePatch2 Service

Now you can copy the files that will be distributed to clients into the `data` subdirectory. The new files should inherit the access rights of their enclosing directory. For the sake of discussion, let's copy some Slice files from the Ice distribution into the data directory:

```
> cd "Local Settings\Application Data\ZeroC\icepatch2\data"
> copy \Ice\slice\Ice*.ice
```

Next we need to run `icepatch2calc` to prepare the directory for use by the IcePatch2 service:

```
> icepatch2calc .
```

## Configuration File for the IcePatch2 Service

IcePatch2 requires a minimal set of configuration properties. We could specify them on the service's command line, but if we later want to modify those properties we would have to reinstall the service. Defining the properties in a file simplifies the task of modifying the service's configuration.

Our IcePatch2 configuration is quite simple:

```
IcePatch2.Directory=C:\Documents and Settings\LocalService\
Local Settings\Application Data\ZeroC\icepatch2\data
IcePatch2.Endpoints=tcp -p 10000
```

The `IcePatch2.Directory` property specifies the location of the server's data directory, which we created in the previous section.

We will save our configuration properties into the following file:

```
C:\Ice\config\icepatch2.cfg
```

We must also ensure that the service has permission to access its configuration file. The Ice run time never modifies a configuration file, therefore read access is sufficient. The configuration file likely already has the necessary access rights, which we can verify using the `cacls` utility that we described earlier:

```
> cacls C:\Ice\config\icepatch2.cfg
```

## Creating the IcePatch2 Service

We will use Microsoft's Service Control (`sc`) utility in a command window to create the service.

 See <http://support.microsoft.com/kb/251192> for more information about the `sc` utility.

Our first `sc` command does the majority of the work (the command is formatted for readability but must be typed on a single line):

```
> sc create icepatch2 binPath= "C:\Ice\bin\icepatch2server.exe
--Ice.Config=C:\Ice\config\icepatch2.cfg --service icepatch2"
DisplayName= "IcePatch2 Server" start= auto
obj= "NT Authority\LocalService" password= ""
```

There are several important aspects of this command:

- The service name is `icepatch2`. You can use whatever name you like, as long as it does not conflict with an existing service. Note however that this name is used in other contexts, such as in the `--service` option discussed below, therefore you must use it consistently.
- Following the service are several options. Note that all of the option names end with an equals sign and are separated from their arguments with at least one space.
- The `binPath=` option is required. We supply the full path name of the `IcePatch2` server executable, as well as command-line arguments that define the location of the configuration file and the name of the service, all enclosed in quotes.
- The `DisplayName=` option sets a friendly name for the service.
- The `start=` option configures the start up behavior for the service. We used the argument `auto` to indicate the service should be started automatically when Windows boots.
- The `obj=` option selects the user account in which this service runs. As we [explained](#), the `Local Service` account is appropriate for most services.
- The `password=` option supplies the password associated with the user account indicated by `obj=`. The `Local Service` account has an empty password.

The `sc` utility should report success if it was able to create the service as specified. You can verify that the new service was created with this command:

```
> sc qc icepatch2
```

Alternatively, you can start the Services administrative control panel and inspect the properties of the `IcePatch2` service.

If you start the control panel, you will notice that the entry for `IcePatch2` does not have a description. To add a description for the service, use the following command:

```
> sc description icepatch2 "IcePatch2 file server"
```

After refreshing the list of services, you should see the new description.

## Creating the Event Log for the IcePatch2 Service

By default, programs such as the IcePatch2 service that utilize the `Service` class log messages to the `Application` event log. Below we describe how to prepare the Windows registry for the service's default behavior, and we also show how to use a custom event log instead. We make use of Microsoft's Registry (`reg`) utility to modify the registry, although you could also use the interactive `regedit` tool. As always, caution is recommended whenever you modify the registry.

## Using the Application Log for the IcePatch2 Service

We must configure an event log source for events to display properly. The first step is to create a registry key with the name of the source. Since the `Service` class uses the service name as the source name by default, we add the key `icepatch2` as shown below:

```
> reg add
HKLM\SYSTEM\CurrentControlSet\Services\EventLog\Application\icepatch2
```

Inside this key we must add a value specifies the location of the Ice run time DLL:

```
> reg add
HKLM\SYSTEM\CurrentControlSet\Services\EventLog\Application\icepatch2
/v ErrorMessageFile /t REG_EXPAND_SZ /d C:\Ice\bin\ice34.dll
```

We will also add a value indicating the types of events that the source supports:

```
> reg add
HKLM\SYSTEM\CurrentControlSet\Services\EventLog\Application\icepatch2
/v TypesSupported /t REG_DWORD /d 7
```

The value 7 corresponds to the combination of the following event types:

- EVENTLOG\_ERROR\_TYPE
- EVENTLOG\_WARNING\_TYPE
- EVENTLOG\_INFORMATION\_TYPE

You can verify that the registry values have been defined correctly using the following command:

```
> reg query
HKLM\SYSTEM\CurrentControlSet\Services\EventLog\Application\icepatch2
```

Our configuration of the event log is now complete.

### Changing the Source Name for the IcePatch2 Service

Using the configuration described in the previous section, events logged by the IcePatch2 service are recorded in the event log using the source name `icepatch2`. If you prefer to use a source name that differs from the service name, you can replace `icepatch2` in the registry commands with the name of your choosing, but you must also add a matching definition for the property `Ice.EventLog.Source` to the service's configuration file.

For example, to use the source name `Ice File Patching Service`, you would add the registry key as shown below:



```
> reg add
"HKLM\SYSTEM\CurrentControlSet\Services\EventLog\Application\Ice File
Patching Service"
```

The commands to add the `EventMessageFile` and `TypesSupported` values must be modified in a similar fashion. Finally, add the following configuration property to `icepatch2.cfg`:

```
Ice.EventLog.Source=Ice File Patching Service
```

## Using a Custom Log for the IcePatch2 Service

You may decide that you want your services to record messages into an application-specific log instead of the `Application` log that is shared by other unrelated services. As an example, let us create a log named `MyApp`:

```
> reg add "HKLM\SYSTEM\CurrentControlSet\Services\EventLog\MyApp"
```

Next we add a subkey for the `IcePatch2` service. As described in the previous section, we will use a friendlier source name:

```
> reg add "HKLM\SYSTEM\CurrentControlSet\Services\EventLog\MyApp\Ice
File Patching Service"
```

Now we can define values for `EventMessageFile` and `TypesSupported`:

```
> reg add "HKLM\SYSTEM\CurrentControlSet\Services\EventLog\MyApp\Ice
File Patching Service"
/v EventMessageFile /t REG_EXPAND_SZ /d C:\Ice\bin\ice34.dll

> reg add "HKLM\SYSTEM\CurrentControlSet\Services\EventLog\MyApp\Ice
File Patching Service"
/v TypesSupported /t REG_DWORD /d 7
```

Finally, we define `Ice.EventLog.Source` in the `IcePatch2` service's configuration file:

```
Ice.EventLog.Source=Ice File Patching Service
```

Note that you must restart the Event Viewer control panel after adding the `MyApp` registry key in order to see the new log.

## Registry Caching for the IcePatch2 Service

The first time a service logs an event, Windows' Event Log service caches the registry entries associated with the service's source. If you wish to modify a service's event log configuration, such as changing the service to use a custom log instead of the `Application` log, you should perform the following steps:

1. Stop the service.

2. Remove the unwanted event log registry key.
3. Add the new event log registry key(s).
4. Restart the system (or at least the Event Log service).
5. Start the service and verify that the log entries appear in the intended log.

After following these steps, open a log entry and ensure that it displays properly. If it does not, for example if the event properties indicate that the description of an event cannot be found, the problem is likely due to a misconfigured event source. Verify that the value of `EventMessageFile` refers to the correct location of the Ice run time DLL, and that the service is defining `Ice.EventLog.Source` in its configuration file (if necessary).

## Starting the IcePatch2 Service

We are at last ready to start the service. In a command window, you can use the `sc` utility:

```
> sc start icepatch2
```

The program usually responds with status information indicating that the start request is pending. You can query the service's status to verify that it started successfully:

```
> sc query icepatch2
```

The service should now be in the running state. If it is not in this state, open the Event Viewer control panel and inspect the relevant log for more information that should help you to locate the problem. Even if the service started successfully, you may still want to use the Event Viewer to confirm that the service is using the log you expected.

## Testing the IcePatch2 Service

Ice includes a graphical IcePatch2 client in the `demo/IcePatch2/MFC` directory of the Ice distribution. Once you have built the client, you can use it to test that the service is working properly.

### See Also

- [IcePatch2](#)
- [Ice::Service Class](#)
- [Installing a Windows Service](#)

## Troubleshooting Windows Services

This page describes how to troubleshoot Windows Services.

On this page:

- [Missing Libraries for a Windows Service](#)
- [Windows Firewall Interference](#)
- [IceGrid Node Performance Monitoring Issues](#)

### Missing Libraries for a Windows Service

One failure that commonly occurs when starting a Windows service is caused by missing DLLs, which usually results in an error window stating a particular DLL cannot be found. Fixing this problem can often be a trial-and-error process because the DLL mentioned in the error may depend on other DLLs that are also missing. It is important to understand that a Windows service is launched by the operating system and can be configured to execute as a different user, which means the service's environment (most importantly its `PATH`) may not match yours and therefore extra steps are necessary to ensure that the service can locate its required DLLs.

 The command-line utility `dumpbin` can be used to discover the dependencies of an executable or DLL.

The simplest approach is to copy all of the necessary DLLs to the directory containing the service executable. If this solution is undesirable, another option is to modify the system `PATH` to include the directory or directories containing the required DLLs. (Note that modifying the system `PATH` requires restarting the system.) Finally, you can copy the necessary DLLs to `\WINDOWS\system32`, although we do not recommend this approach.

 Copying DLLs to `\WINDOWS\system32` often results in subtle problems later when trying to develop using newer versions of the DLLs. Inevitably you will forget about the DLLs in `\WINDOWS\system32` and struggle to determine why your application is misbehaving or failing to start.

Assuming that DLL issues are resolved, a Windows service can fail to start for a number of other reasons, including

- invalid command-line arguments or configuration properties
- inability to access necessary resources such as file systems and databases, because either the resources do not exist or the service does not have sufficient access rights to them
- networking issues, such as attempting to open a port that is already in use, or DNS lookup failures

Failures encountered by the Ice run time prior to initialization of the communicator are reported to the Windows event log if no other logger implementation is defined, so that should be the first place you look. Typically you will find an entry in the `System` event log resembling the following message:

```
The IcePatch2 service terminated with service-specific error 1.
```

Error code 1 corresponds to `EXIT_FAILURE`, the value used by the `Service` class to indicate a failure during startup. Additional diagnostic messages may be available in the `Application` event log. See [Ice::Service Logging Considerations](#) for more information on configuring a logger for a Windows service.

As we mentioned earlier, insufficient access rights can also prevent a Windows service from starting successfully. By default, a Windows service is configured to run under a local system account, in which case the service may not be able to access resources owned by other users. It may be necessary for you to configure a service to run under a [different account](#), which you can do using the Services control panel. You should also review the [access rights](#) of files and directories required by the service.

### Windows Firewall Interference

Your choice of user account determines whether you receive any notification when the Windows Firewall blocks the ports that are used by your service. For example, if you use `Local Service` as we [recommended](#), you will not see any Windows Security Alert dialog (see this [MI](#)

[Microsoft article](#) for details).

If you are not prompted to unblock your service, you will need to manually add an exception in Windows Firewall. For example, follow the steps below to unblock the ports of a Glacier2 router service:

1. Open the Windows Firewall Settings panel and navigate to the Exceptions panel.
2. Select "Add program..."
3. Select "Browse," navigate to the Glacier2 router executable, and click "OK."

Note that adding an exception for a program unblocks all ports on which the program listens. Review the endpoint configurations of your services carefully to ensure that no unnecessary ports are opened.

For services listening on one or a few fixed ports, you could also create port exceptions in your Windows Firewall. Refer to the Windows Firewall documentation for details.

## IceGrid Node Performance Monitoring Issues

The IceGrid node uses Windows' `Perflib` facility to obtain statistics about the CPU utilization of its host for [load balancing](#) purposes. On Vista-derived operating systems, the IceGrid node may log the following warning message:

```
warning: Unable to lookup the performance counter name
```

This message is an indication that the node does not have sufficient privileges to access a key in the Windows registry:

```
HKLM\SOFTWARE\Microsoft\Windows NT\CurrentVersion\Perflib
```

As part of its installation procedure, the `iceserviceinstall` utility modifies the permissions of this registry key to grant read access to the node's designated user account. If you are trying to change the node's user account, we recommend using the `iceserviceinstall` utility to uninstall and reinstall the node. If you wish to modify the permissions of this registry key manually, follow these steps:

1. Start `regedit` and navigate to the `Perflib` key.
2. Right click on `Perflib` and select `Permissions`.
3. If the desired user account is not already present, click `Add` to add the user account. Enter `LOCAL SERVICE` if you wish to run the node in the Local Service account, otherwise enter the name of the user account. Press `OK`.
4. Check the `Read` box in the `Allow` column to grant read access to the registry key and press `OK` to apply the changes.

Another way to grant the node's user account with the necessary access rights is to add it to the `Performance Monitor Users` group.

### See Also

- [Load Balancing](#)
- [Installing a Windows Service](#)
- [Manually Installing a Service](#)

## Binary Distributions

ZeroC supplies binary distributions for the combinations of platforms and compilers that Ice supports. The packaging of each distribution varies with the platform:

- a Microsoft Installer (MSI) for Windows
- a collection of RPMs for Red Hat Enterprise Linux and SuSE Linux Enterprise Server
- a compressed TAR file (*tarball*) for other Unix platforms

In general, the binary distributions are intended for the developer, and not for the end users of the developer's application. In other words, ZeroC expects you, as an Ice developer, to bundle the necessary Ice run time components into your own installation package. This chapter discusses ZeroC's binary distributions and provides guidelines for distributing your applications.

### Topics

- [Ice Developer Kits](#)
- [Guidelines for Distributing Ice Applications](#)

## Ice Developer Kits

The Windows installer and the Unix tarballs are developer kits that provide everything necessary for you to develop applications with Ice, including header files, pre-compiled shared libraries, Slice compilers, and executables for services such as IceGrid. The Windows installer also includes the source code for sample programs as well as debug versions of the Ice run time libraries.



Sample programs for Unix platforms are provided as a separate source tarball.

The RPM distributions are different than the monolithic distributions of other platforms. Packaged using standard RPM conventions, these distributions include separate run time and developer kit RPMs for each language mapping. For example, the `ice-java` RPM contains the Ice for Java run time (`Ice.jar`), while the `ice-java-devel` RPM contains development tools such as the Slice-to-Java compiler. Additional RPMs are provided for third-party dependencies that are not included in the Red Hat distribution, or whose versions are out of date, such as Berkeley DB.

Regardless of the platform, we do not recommend using Ice developer kits as a way of installing the Ice run time components required by your application because the majority of what is installed by a developer kit is irrelevant to end user applications. The RPM distribution, however, is packaged in such a way that you may find it convenient to simply redistribute select Ice run time RPMs along with your application.

## Guidelines for Distributing Ice Applications

This page provides some guidance for developers that are planning to distribute an Ice-based application. We can start by listing items that typically should not be included in your binary distribution:

- Slice compilers
- Slice files (unless you are using a scripting language, as discussed below)
- Executables and libraries for Ice services and tools that your application does not use
- For C++ programs on Windows:
  - DLLs built in debug mode (such as `ice35bd.dll`)
  - Program database (PDB) files
  - Header files
  - Import library (LIB) files

Each of the language mappings is discussed in its own subsection below. In the following discussion, we use the term *library* to refer to a shared library or DLL as appropriate for the platform.

On this page:

- [C++ Distribution](#)
  - [Discovering Dependencies](#)
- [.NET Distribution](#)
- [Java Distribution](#)
- [Python and Ruby Distributions](#)
- [PHP Distribution](#)

### C++ Distribution

The `Ice` library contains the implementation of the core Ice run time. Supplemental libraries provide the stubs and skeletons for the Ice services, as well as utility functions used by Ice, its services, and Ice applications:

- `Glacier2`
- `IceBox`
- `IceGrid`
- `IcePatch2`
- `IceSSL`
- `IceStorm`

The `IceUtil` library is a dependency of the `Ice` library and therefore must be distributed with any Ice application. The `IceXML` library is required by certain Ice services.

Your distribution needs to include only those libraries that your application uses. If your application implements an `IceBox` service, you must also distribute the `IceBox` server executable (`icebox`).

### Discovering Dependencies

On Windows, you can use the `dumpbin` utility in a command window to display the dependencies of a DLL or executable. For example, here is the output for the `glacier2router` executable:

```
> dumpbin /dependents glacier2router.exe
ice35b.dll
iceutil35b.dll
LIBEAY32.dll
glacier235b.dll
icessl35b.dll
MSVCP100.dll
MSVCR100.dll
KERNEL32.dll
```

We can deduce from the names of the Microsoft Visual C++ run time DLLs that this Ice installation was compiled with Visual Studio 2010. Note that each of these DLLs has its own dependencies, which can be inspected using additional `dumpbin` commands. However, tracking down the dependencies recursively through each DLL can quickly become tedious, therefore you should consider using the [Dependency Walker](#) graphical utility instead.

On Unix, the `ldd` utility displays the dependencies of shared libraries and executables.

## .NET Distribution

The `Ice` assembly contains the implementation of the core Ice run time. Supplemental assemblies provide the stubs and skeletons for the Ice services:

- `Glacier2`
- `IceBox`
- `IceGrid`
- `IcePatch2`
- `IceSSL`
- `IceStorm`

Your distribution needs to include only those assemblies that your application uses. If your application implements an `IceBox` service, you must also distribute the `IceBox` server executable (`iceboxnet.exe`).

On Mono, the file `Ice.dll.config` provides a mapping for the Bzip2 DLL. If your application does not use Ice's protocol compression feature, you do not need to distribute this file. Otherwise, you should include the file and verify that its mapping is appropriate for your target platform.

## Java Distribution

The `Ice.jar` file contains the core Ice run time and the `IceSSL` plug-in. Supplemental JAR files provide the stubs and skeletons for the Ice services:

- `Glacier2`
- `IceBox`
- `IceGrid`
- `IcePatch2`
- `IceSSL`
- `IceStorm`

If your application uses `Freeze`, you must also distribute `Freeze.jar` along with the Berkeley DB run time libraries and JAR file.

For assistance with packaging your Java application, consider using a utility such as [ProGuard](#).

## Python and Ruby Distributions



The Ice run time for a Python or Ruby application consists of the following components:

- the library for the scripting language extension: `IcePy` or `IceRuby`
- the libraries required by the extension: `Ice`, `IceUtil`, and `Slice`
- the source code generated from the `Slice` files in the Ice distribution

In addition, your distribution should include the source code generated for your own `Slice` files, or the `Slice` files themselves if your application loads them dynamically.

## PHP Distribution

The Ice run time for a PHP application consists of the following components:

- the library for the scripting language extension: `IcePHP` or `php_ice`
- the libraries required by the extension: `Ice`, `IceUtil`, and `Slice`
- the source code generated from the `Slice` files in the Ice distribution

In addition, your distribution should include the source code generated for your own `Slice` files.

### See Also

- [IceGrid Persistent Data](#)
- [Configuring IceStorm](#)

## Deprecated AMI Mapping

This section describes the deprecated API for Asynchronous Method Invocation (AMI).

 As of version 3.4, Ice provides a new API for asynchronous method invocation (refer to the relevant language mappings for details). The mapping described here is the old AMI mapping, which is deprecated and will be removed in a future version of Ice.

### Topics

- [Overview of Deprecated AMI Mapping](#)
- [Deprecated AMI Language Mappings](#)
- [Advanced Topics for Deprecated AMI Mapping](#)

## Overview of Deprecated AMI Mapping

On this page:

- [Motivation for AMI](#)
  - [Simulating AMI using Oneway Invocations](#)
- [AMI Semantics](#)
- [Controlling AMI Code Generation using Metadata](#)
- [AMI Interfaces](#)
  - [Proxy Method for AMI Interfaces](#)
  - [Callback Object for AMI Interfaces](#)

### Motivation for AMI

Modern middleware technologies attempt to ease the programmer's transition to distributed application development by making remote invocations as easy to use as traditional method calls: a method is invoked on an object and, when the method completes, the results are returned or an exception is raised. Of course, in a distributed system the object's implementation may reside on another host, and consequently there are some semantic differences that the programmer must be aware of, such as the overhead of remote invocations and the possibility of network-related errors. Despite those issues, the programmer's experience with object-oriented programming is still relevant, and this *synchronous* programming model, in which the calling thread is blocked until the operation returns, is familiar and easily understood.

Ice is inherently an asynchronous middleware platform that simulates synchronous behavior for the benefit of applications (and their programmers). When an Ice application makes a synchronous twoway invocation on a proxy for a remote object, the operation's in parameters are marshaled into a message that is written to a transport, and the calling thread is blocked in order to simulate a synchronous method call. Meanwhile, the Ice run time operates in the background, processing messages until the desired reply is received and the calling thread can be unblocked to unmarshal the results.

There are many cases, however, in which the blocking nature of synchronous programming is too restrictive. For example, the application may have useful work it can do while it awaits the response to a remote invocation; using a synchronous invocation in this case forces the application to either postpone the work until the response is received, or perform this work in a separate thread. When neither of these alternatives are acceptable, the asynchronous facilities provided with Ice are an effective solution for improving performance and scalability, or simplifying complex application tasks.

### Simulating AMI using Oneway Invocations

Before we get into the details of the AMI facilities that Ice provides, let's explore the idea of using [oneway invocations](#) to achieve similar results. As an example, consider an application with a graphical user interface. This application typically must avoid blocking the window system's event dispatch thread because blocking makes the application unresponsive to user commands. In this situation, making a synchronous remote invocation is asking for trouble.

The application could attempt to avoid this situation using oneway invocations, which by definition cannot return a value or have any `out` parameters. Since the Ice run time does not expect a reply, the invocation blocks only as long as it takes to establish a connection (if necessary), marshal the request, and copy the message into the local transport buffer. However, these network activities may still block. Furthermore, the use of oneway invocations may require unacceptable changes to the interface definitions. For example, a twoway invocation that returns results or raises user exceptions must be converted into at least two operations: one for the client to invoke with oneway semantics that contains only in parameters, and one (or more) for the server to invoke to notify the client of the results.

To illustrate these changes, suppose that we have the following Slice definition:

**Slice**

```
interface I {
 int op(string s, out long l);
};
```

In its current form, the operation `op` is not suitable for a oneway invocation because it has an `out` parameter and a non-void return type. In order to accommodate a oneway invocation of `op`, we can change the Slice definitions as shown below:

**Slice**

```
interface ICallback {
 void opResults(int result, long l);
};

interface I {
 void op(ICallback* cb, string s);
};
```

We made several modifications to the original definition:

- We added the interface `ICallback`, containing an operation `opResults` whose arguments represent the results of the original twoway operation. The server invokes this operation to notify the client of the completion of the operation.
- We modified `I::op` to be compliant with oneway semantics: it now has a `void` return type, and takes only in parameters.
- We added a parameter to `I::op` that allows the client to supply a proxy for its callback object.

As you can see, we have made significant changes to our interface definitions to accommodate the implementation requirements of the client. One ramification of these changes is that the client must now also be a server, because it must create an instance of `ICallback` and register it with an object adapter in order to receive notifications of completed operations.

A more severe ramification, however, is the impact these changes have on the type system, and therefore on the server. Whether a client invokes an operation synchronously or asynchronously should be irrelevant to the server; this is an artifact of behavior that should have no impact on the type system. By changing the type system as shown above, we have tightly coupled the server to the client, and eliminated the ability for `op` to be invoked synchronously.

To make matters even worse, consider what would happen if `op` could raise [user exceptions](#). In this case, `ICallback` would have to be expanded with additional operations that allow the server to notify the client of the occurrence of each exception. Since exceptions cannot be used as parameter or member types in Slice, this quickly becomes a difficult endeavor, and the results are likely to be equally difficult to use.

At this point, you will hopefully agree that this technique is flawed in many ways, so why do we bother describing it in such detail? The reason is that the Ice implementation of AMI uses a strategy similar to the one described above, with several important differences:

1. No changes to the type system are required in order to use AMI. The on-the-wire representation of the data is identical, therefore synchronous and asynchronous clients and servers can coexist in the same system, using the same operations.
2. The AMI solution accommodates exceptions in a reasonable way.
3. Using AMI does not require the client to also be a server.
4. Ice guarantees that AMI requests never block the calling thread.

## AMI Semantics

*Asynchronous Method Invocation (AMI)* is the term used to describe the client-side support for the asynchronous programming model. AMI supports both oneway and twoway requests, but unlike their synchronous counterparts, AMI requests never block the calling thread. When a client issues an AMI request, the Ice run time hands the message off to the local transport buffer or, if the buffer is currently full, queues the request for later delivery. The application can then continue its activities and, in the case of a twoway invocation, is notified when the reply eventually arrives. Notification occurs via a callback to an application-supplied programming-language object.



Polling for a response is not supported in the deprecated AMI mapping, but polling is supported in the new API.

The use of an asynchronous model does not affect what is sent "on the wire." Specifically, the invocation model used by a client is transparent to the server, and the dispatch model used by a server is transparent to the client. Therefore, a server has no way to distinguish a client's synchronous invocation from an asynchronous invocation, and a client has no way to distinguish a server's synchronous reply from

an asynchronous reply.

## Controlling AMI Code Generation using Metadata

A programmer indicates a desire to use an asynchronous model (AMI, AMD, or both) by annotating Slice definitions with `metadata`. The programmer can specify this metadata at two levels: for an interface or class, or for an individual operation. If specified for an interface or class, then asynchronous support is generated for all of its operations. Alternatively, if asynchronous support is needed only for certain operations, then the generated code can be minimized by specifying the metadata only for those operations that require it.

Synchronous invocation methods are always generated in a proxy; specifying AMI metadata merely adds asynchronous invocation methods. In contrast, specifying AMD metadata causes the synchronous dispatch methods to be *replaced* with their asynchronous counterparts. This semantic difference between AMI and AMD is ultimately practical: it is beneficial to provide a client with synchronous and asynchronous versions of an invocation method, but doing the equivalent in a server would require the programmer to implement both versions of the dispatch method, which has no tangible benefits and several potential pitfalls.

Consider the following Slice definitions:

Slice
<pre>["ami"] interface I {     bool isValid();     float computeRate(); };  interface J {     ["amd"]          void startProcess();     ["ami", "amd"] int endProcess(); };</pre>

In this example, all proxy methods of interface `I` are generated with support for synchronous and asynchronous invocations. In interface `J`, the `startProcess` operation uses asynchronous dispatch, and the `endProcess` operation supports asynchronous invocation and dispatch.

Specifying metadata at the operation level, rather than at the interface or class level, not only minimizes the amount of generated code, but more importantly, it minimizes complexity. Although the asynchronous model is more flexible, it is also more complicated to use. It is therefore in your best interest to limit the use of the asynchronous model to those operations for which it provides a particular advantage, while using the simpler synchronous model for the rest.

## AMI Interfaces

AMI operations have the same semantics in all of the language mappings that support asynchronous invocations. This section provides a language-independent introduction to the AMI model.

### Proxy Method for AMI Interfaces

Annotating a Slice operation with the AMI metadata tag does not prevent an application from invoking that operation using the traditional synchronous model. Rather, the presence of the metadata extends the proxy with an asynchronous version of the operation, so that invocations can be made using either model.

The asynchronous operation never blocks the calling thread. If the message cannot be accepted into the local transport buffer without blocking, the Ice run time queues the request and immediately returns control to the calling thread.

The parameters of the asynchronous operation are modified similar to our [earlier example](#): the first argument is a callback object (described below), followed by any `in` parameters in the order of declaration. The operation's return value and `out` parameters, if any, are passed to the callback object when the response is received.

The asynchronous operation only raises `CommunicatorDestroyedException` directly; all other exceptions are reported to the callback object.

Finally, the return value of the asynchronous operation is a boolean that indicates whether the Ice run time was able to send the request synchronously; that is, whether the entire message was immediately accepted by the local transport buffer. An application can use this value to implement flow control.

## Callback Object for AMI Interfaces

The asynchronous operation requires the application to supply a callback object as the first argument. This object is an instance of an application-defined class; in strongly-typed languages this class must inherit from a superclass generated by the Slice compiler. In contrast to the [oneway example](#), the callback object is a purely local object that is invoked by the Ice run time in the client, and not by the remote server.

The Ice run time always invokes methods of the callback object from a thread in an Ice thread pool, and never from the thread that is invoking the asynchronous operation. Exceptions raised by a callback object are ignored but may cause the Ice run time to log a warning message depending on the value of the `Ice.Warn.AMICallback` property.

The callback class must define the methods `ice_response` and `ice_exception`:

- `ice_response`  
Invoked by the Ice run time to supply the results of a successful twoway invocation; this method is not invoked for oneway invocations. The arguments to `ice_response` consist of the return value (if the operation returns a non-void type) followed by any out parameters in the order of declaration.
- `ice_exception`  
[Handles errors](#) that occur during the invocation. The only exception that can be raised to the thread invoking the asynchronous operation is `CommunicatorDestroyedException`; all other errors, including user exceptions, are passed to the callback object via its `ice_exception` method. In the case of a oneway invocation, `ice_exception` is only invoked if an error occurs before the request is sent.

For an asynchronous invocation, the Ice run time calls `ice_response` or `ice_exception`, but not both. It is possible for one of these methods to be called before control returns to the thread that is invoking the operation.

A callback object may optionally define a third method, `ice_sent`:

- `ice_sent`  
Invoked when the entire message has been passed to the local transport buffer to provide [flow control](#) functionality. The Ice run time does not invoke `ice_sent` if the asynchronous operation returned true to indicate that the message was sent synchronously. An application must make no assumptions about the order of invocations on a callback object; `ice_sent` can be called before, after, or concurrently with `ice_response` or `ice_exception`.

### See Also

- [Metadata](#)
- [Oneway Invocations](#)
- [Advanced Topics for Deprecated AMI Mapping](#)

## Deprecated AMI Language Mappings

The deprecated AMI language mappings are described in separate subsections below.

On this page:

- [Deprecated AMI Mapping for C++](#)
- [Deprecated AMI Mapping for Java](#)
- [Deprecated AMI Mapping for C#](#)
- [Deprecated AMI Mapping for Python](#)
- [Examples using Deprecated AMI Mapping](#)
  - [C++ Client Example](#)
  - [Java Client Example](#)
  - [C# Client Example](#)
  - [Python Client Example](#)

### Deprecated AMI Mapping for C++

The C++ mapping emits the following code for each AMI operation:

1. An abstract callback class whose name is formed using the pattern `AMI_class_op`. For example, an operation named `foo` defined in interface `I` results in a class named `AMI_I_foo`. The class is generated in the same scope as the interface or class containing the operation. Two methods must be defined by the subclass:

```

C++

void ice_response(<params>);
void ice_exception(const Ice::Exception &);
```

2. An additional proxy method, having the mapped name of the operation with the suffix `_async`. This method returns a boolean indicating whether the request was [sent synchronously](#). The first parameter is a smart pointer to an instance of the callback class described above. The remaining parameters comprise the `in` parameters of the operation, in the order of declaration.

For example, suppose we have defined the following operation:

```

Slice

interface I {
 ["ami"] int foo(short s, out long l);
};
```

The callback class generated for operation `foo` is shown below:

```

C++

class AMI_I_foo : public ... {
public:
 virtual void ice_response(Ice::Int, Ice::Long) = 0;
 virtual void ice_exception(const Ice::Exception&) = 0;
};
typedef IceUtil::Handle<AMI_I_foo> AMI_I_fooPtr;
```

The proxy method for asynchronous invocation of operation `foo` is generated as follows:

```
C++
```

```
bool foo_async(const AMI_I_fooPtr&, Ice::Short);
```

The [overview](#) describes the proxy methods and callback objects in greater detail.

## Deprecated AMI Mapping for Java

The Java mapping emits the following code for each AMI operation:

1. An abstract callback class whose name is formed using the pattern `AMI_class_op`. For example, an operation named `foo` defined in interface `I` results in a class named `AMI_I_foo`. The class is generated in the same scope as the interface or class containing the operation. Three methods must be defined by the subclass:

```
Java
```

```
public void ice_response(<params>);
public void ice_exception(Ice.LocalException ex);
public void ice_exception(Ice.UserException ex);
```

2. An additional proxy method, having the mapped name of the operation with the suffix `_async`. This method returns a boolean indicating whether the request was [sent synchronously](#). The first parameter is a reference to an instance of the callback class described above. The remaining parameters comprise the `in` parameters of the operation, in the order of declaration.

For example, suppose we have defined the following operation:

```
Slice
```

```
interface I {
 ["ami"] int foo(short s, out long l);
};
```

The callback class generated for operation `foo` is shown below:

```
Java
```

```
public abstract class AMI_I_foo extends ... {
 public abstract void ice_response(int __ret, long l);
 public abstract void ice_exception(Ice.LocalException ex);
 public abstract void ice_exception(Ice.UserException ex);
}
```

The proxy methods for asynchronous invocation of operation `foo` are generated as follows:



### Java

```
public boolean foo_async(AMI_I_foo __cb, short s);
public boolean foo_async(AMI_I_foo __cb, short s,
 java.util.Map<String, String> __ctx);
```

As usual, the version of the operation without a context parameter forwards an empty context to the version with a context parameter.

The [overview](#) describes the proxy methods and callback objects in greater detail.

## Deprecated AMI Mapping for C#

The C# mapping emits the following code for each AMI operation:

1. An abstract callback class whose name is formed using the pattern `AMI_class_op`. For example, an operation named `foo` defined in interface `I` results in a class named `AMI_I_foo`. The class is generated in the same scope as the interface or class containing the operation. Two methods must be defined by the subclass:

### C#

```
public abstract void ice_response(<params>);
public abstract void ice_exception(Ice.Exception ex);
```

2. An additional proxy method, having the mapped name of the operation with the suffix `_async`. This method returns a boolean indicating whether the request was [sent synchronously](#). The first parameter is a reference to an instance of the callback class described above. The remaining parameters comprise the in parameters of the operation, in the order of declaration.

For example, suppose we have defined the following operation:

### Slice

```
interface I {
 ["ami"] int foo(short s, out long l);
};
```

The callback class generated for operation `foo` is shown below:

### C#

```
public abstract class AMI_I_foo : ...
{
 public abstract void ice_response(int __ret, long l);
 public abstract void ice_exception(Ice.Exception ex);
}
```

The proxy method for asynchronous invocation of operation `foo` is generated as follows:

**C#**

```
bool foo_async(AMI_I_foo __cb, short s);
bool foo_async(AMI_I_foo __cb, short s,
Dictionary<string, string> __ctx);
```

As usual, the version of the operation without a context parameter forwards an empty context to the version with a context parameter.

The [overview](#) describes the proxy methods and callback objects in greater detail.

**Deprecated AMI Mapping for Python**

For each AMI operation, the Python mapping emits an additional proxy method having the mapped name of the operation with the suffix `_async`. This method returns a boolean indicating whether the request was [sent synchronously](#). The first parameter is a reference to a callback object; the remaining parameters comprise the `in` parameters of the operation, in the order of declaration.

Unlike the mappings for strongly-typed languages, the Python mapping does not generate a callback class for asynchronous operations. In fact, the callback object's type is irrelevant; the Ice run time simply requires that it define the `ice_response` and `ice_exception` methods :

**Python**

```
def ice_response(self, <params>)
def ice_exception(self, ex)
```

For example, suppose we have defined the following operation:

**Slice**

```
interface I {
 ["ami"] int foo(short s, out long l);
};
```

The method signatures required for the callback object of operation `foo` are shown below:

**Python**

```
class ...
 #
 # Operation signatures:
 #
 # def ice_response(self, _result, l)
 # def ice_exception(self, ex)
```

The proxy method for asynchronous invocation of operation `foo` is generated as follows:

**Python**

```
def foo_async(self, __cb, s)
```

The [overview](#) describes the proxy methods and callback objects in greater detail.

**Examples using Deprecated AMI Mapping**

To demonstrate the use of AMI in Ice, let's define the Slice interface for a simple computational engine:

**Slice**

```
module Demo {
 sequence<float> Row;
 sequence<Row> Grid;

 exception RangeError {};

 interface Model {
 ["ami"] Grid interpolate(Grid data, float factor)
 throws RangeError;
 };
};
```

Given a two-dimensional grid of floating point values and a factor, the `interpolate` operation returns a new grid of the same size with the values interpolated in some interesting (but unspecified) way. In the sections below, we present C++, Java, and C# clients that invoke `interpolate` using AMI.

**C++ Client Example**

We must first define our callback implementation class, which derives from the generated class `AMI_Model_interpolate`:

**C++**

```

class AMI_Model_interpolateI : public Demo::AMI_Model_interpolate
{
public:
 virtual void ice_response(const Demo::Grid& result)
 {
 cout << "received the grid" << endl;
 // ... postprocessing ...
 }

 virtual void ice_exception(const Ice::Exception& ex)
 {
 try {
 ex.ice_throw();
 } catch (const Demo::RangeError& e) {
 cerr << "interpolate failed: range error" << endl;
 } catch (const Ice::LocalException& e) {
 cerr << "interpolate failed: " << e << endl;
 }
 }
};

```

The implementation of `ice_response` reports a successful result, and `ice_exception` displays a diagnostic if an exception occurs.

The code to invoke `interpolate` is equally straightforward:

**C++**

```

Demo::ModelPrx model = ...;
AMI_Model_interpolatePtr cb = new AMI_Model_interpolateI;
Demo::Grid grid;
initializeGrid(grid);
model->interpolate_async(cb, grid, 0.5);

```

After obtaining a proxy for a `Model` object, the client instantiates a callback object, initializes a grid and invokes the asynchronous version of `interpolate`. When the Ice run time receives the response to this request, it invokes the callback object supplied by the client.

## Java Client Example

We must first define our callback implementation class, which derives from the generated class `AMI_Model_interpolate`:

### Java

```
class AMI_Model_interpolateI extends Demo.AMI_Model_interpolate {
 public void ice_response(float[][] result)
 {
 System.out.println("received the grid");
 // ... postprocessing ...
 }

 public void ice_exception(Ice.UserException ex)
 {
 assert(ex instanceof Demo.RangeError);
 System.err.println("interpolate failed: range error");
 }

 public void ice_exception(Ice.LocalException ex)
 {
 System.err.println("interpolate failed: " + ex);
 }
}
```

The implementation of `ice_response` reports a successful result, and the `ice_exception` methods display a diagnostic if an exception occurs.

The code to invoke `interpolate` is equally straightforward:

### Java

```
Demo.ModelPrx model = ...;
AMI_Model_interpolate cb = new AMI_Model_interpolateI();
float[][] grid = ...;
initializeGrid(grid);
model.interpolate_async(cb, grid, 0.5);
```

After obtaining a proxy for a `Model` object, the client instantiates a callback object, initializes a grid and invokes the asynchronous version of `interpolate`. When the Ice run time receives the response to this request, it invokes the callback object supplied by the client.

## C# Client Example

We must first define our callback implementation class, which derives from the generated class `AMI_Model_interpolate`:

**C#**

```
using System;

class AMI_Model_interpolateI : Demo.AMI_Model_interpolate {
 public override void ice_response(float[][] result)
 {
 Console.WriteLine("received the grid");
 // ... postprocessing ...
 }

 public override void ice_exception(Ice.Exception ex)
 {
 Console.Error.WriteLine("interpolate failed: " + ex);
 }
}
```

The implementation of `ice_response` reports a successful result, and the `ice_exception` method displays a diagnostic if an exception occurs.

The code to invoke `interpolate` is equally straightforward:

**C#**

```
Demo.ModelPrx model = ...;
AMI_Model_interpolate cb = new AMI_Model_interpolateI();
float[][] grid = ...;
initializeGrid(grid);
model.interpolate_async(cb, grid, 0.5);
```

## Python Client Example

We must first define our callback implementation class:

### Python

```
class AMI_Model_interpolateI(object):
 def ice_response(self, result):
 print "received the grid"
 # ... postprocessing ...

 def ice_exception(self, ex):
 try:
 raise ex
 except Demo.RangeError, e:
 print "interpolate failed: range error"
 except Ice.LocalException, e:
 print "interpolate failed: " + str(e)
```

The implementation of `ice_response` reports a successful result, and the `ice_exception` method displays a diagnostic if an exception occurs.

The code to invoke `interpolate` is equally straightforward:

### Python

```
model = ...
cb = AMI_Model_interpolateI()
grid = ...
initializeGrid(grid)
model.interpolate_async(cb, grid, 0.5)
```

#### See Also

- [Overview of Deprecated AMI Mapping](#)

## Advanced Topics for Deprecated AMI Mapping

On this page:

- [AMI Concurrency Issues](#)
- [Flow Control using Deprecated AMI Mapping](#)
  - [Implementing `ice\_sent` in C++](#)
  - [Implementing `ice\_sent` in Java](#)
  - [Implementing `ice\_sent` in C#](#)
  - [Implementing `ice\_sent` in Python](#)
- [Flushing Batch Requests using Deprecated AMI Mapping](#)
  - [C++ Mapping](#)
  - [Java Mapping](#)
  - [C# Mapping](#)
  - [Python Mapping](#)
- [Handling Timeouts with Deprecated AMI Mapping](#)
- [Handling Errors with Deprecated AMI Mapping](#)
- [AMI Limitations](#)

### AMI Concurrency Issues

Support for asynchronous invocations in Ice is enabled by the client [thread pool](#), whose threads are primarily responsible for processing reply messages. It is important to understand the concurrency issues associated with asynchronous invocations:

- A callback object must not be used for multiple simultaneous invocations. An application that needs to aggregate information from multiple replies can create a separate object to which the callback objects delegate.
- Calls to the callback object are always made by threads from an Ice thread pool, therefore synchronization may be necessary if the application might interact with the callback object at the same time as the reply arrives. Furthermore, since the Ice run time never invokes callback methods from the client's calling thread, the client can safely make AMI invocations while holding a lock without risk of a deadlock.
- The number of threads in the client thread pool determines the maximum number of simultaneous callbacks possible for asynchronous invocations. The default size of the client thread pool is one, meaning invocations on callback objects are serialized. If the size of the thread pool is increased, the application may require synchronization, and replies can be dispatched out of order. The client thread pool can also be configured to [serialize messages](#) received over a connection so that AMI replies from a connection are dispatched in the order they are received.
- A [limitation](#) of AMI is the lack of support for collocation optimization. As a result, AMI invocations are always sent "over the wire" and thus are dispatched by the server thread pool.

### Flow Control using Deprecated AMI Mapping

The Ice run time queues asynchronous requests when necessary to avoid blocking the calling thread, but places no upper limit on the number of queued requests or the amount of memory they can consume. To prevent unbounded memory utilization, Ice provides the infrastructure necessary for an application to implement its own flow-control logic by combining the following API components:

- The return value of the asynchronous proxy method
- The `ice_sent` method in the AMI callback object

The return value of the proxy method determines whether the request was queued. If the proxy method returns true, no flow control is necessary because the request was accepted by the local transport buffer and therefore the Ice run time did not need to queue it. In this situation, the Ice run time does not invoke the `ice_sent` method on the callback object; the return value of the proxy method is sufficient notification that the request was sent.

If the proxy method returns false, the Ice run time has queued the request. Now the application must decide how to proceed with subsequent invocations:

- The application can be structured so that at most one request is queued. For example, the next invocation can be initiated when the `ice_sent` method is called for the previous invocation.



- A more sophisticated solution is to establish a maximum allowable number of queued requests and maintain a counter (with appropriate synchronization) to regulate the flow of invocations.

Naturally, the requirements of the application must dictate an implementation strategy.

## Implementing `ice_sent` in C++

To indicate its interest in receiving `ice_sent` invocations, an AMI callback object must also derive from the C++ class `Ice::AMISentCallback`:

```

C++

namespace Ice {
 class AMISentCallback {
 public:
 virtual ~AMISentCallback();
 virtual void ice_sent() = 0;
 };
}
```

We can modify our [sample client](#) to include an `ice_sent` callback as shown below:

```

C++

class AMI_Model_interpolateI : public Demo::AMI_Model_interpolate,
 public Ice::AMISentCallback
{
public:
 // ...

 virtual void ice_sent()
 {
 cout << "request sent successfully" << endl;
 }
};
```

## Implementing `ice_sent` in Java

To indicate its interest in receiving `ice_sent` invocations, an AMI callback object must also implement the Java interface `Ice.AMISentCallback`:

```

Java

package Ice;

public interface AMISentCallback {
 void ice_sent();
}
```

We can modify our [sample client](#) to include an `ice_sent` callback as shown below:

```

Java
class AMI_Model_interpolateI extends Demo.AMI_Model_interpolate
 implements Ice.AMISentCallback {
 // ...

 public void ice_sent()
 {
 System.out.println("request sent successfully");
 }
}

```

### Implementing `ice_sent` in C#

To indicate its interest in receiving `ice_sent` invocations, an AMI callback object must also implement the C# interface `Ice.AMISentCallback`:

```

C#
namespace Ice {
 public interface AMISentCallback
 {
 void ice_sent();
 }
}

```

We can modify our [sample client](#) to include an `ice_sent` callback as shown below:

```

C#
class AMI_Model_interpolateI : Demo.AMI_Model_interpolate,
 Ice.AMISentCallback {
 // ...

 public void ice_sent()
 {
 Console.Out.WriteLine("request sent successfully");
 }
}

```

### Implementing `ice_sent` in Python

To indicate its interest in receiving `ice_sent` invocations, an AMI callback object need only define the `ice_sent` method.

We can modify our [sample client](#) to include an `ice_sent` callback as shown below:

**Python**

```
class AMI_Model_interpolateI(object):
 # ...

 def ice_sent(self):
 print "request sent successfully"
```

**Flushing Batch Requests using Deprecated AMI Mapping**

Applications that send [batched requests](#) can either flush a batch explicitly or allow the Ice run time to flush automatically. The proxy method `ice_flushBatchRequests` performs an immediate flush using the synchronous invocation model and may block the calling thread until the entire message can be sent. Ice also provides an asynchronous version of this method for applications that wish to flush batch requests without the risk of blocking.

The proxy method `ice_flushBatchRequests_async` initiates an asynchronous flush. Its only argument is a callback object; this object must define an `ice_exception` method for receiving a notification if an error occurs before the message is sent.

If the application is interested in [flow control](#), the return value of `ice_flushBatchRequests_async` is a boolean indicating whether the message was sent synchronously. Furthermore, the callback object can define an `ice_sent` method that is invoked when an asynchronous flush completes.

**C++ Mapping**

The base proxy class `ObjectPrx` defines the asynchronous flush operation as shown below:

**C++**

```
namespace Ice {
 class ObjectPrx : ... {
 public:
 // ...
 bool ice_flushBatchRequests_async(
 const Ice::AMI_Object_ice_flushBatchRequestsPtr& cb)
 };
}
```

The argument is a smart pointer for an object that implements the following class:

**C++**

```
namespace Ice {
 class AMI_Object_ice_flushBatchRequests : ... {
 public:
 virtual void ice_exception(const Ice::Exception& ex) = 0;
 };
}
```

As an example, the class below demonstrates how to define a callback class that also receives a notification when the asynchronous flush completes:

```
C++
```

```
class MyFlushCallbackI : public Ice::AMI_Object_ice_flushBatchRequests,
 public Ice::AMISentCallback
{
public:
 virtual void ice_exception(const Ice::Exception& ex);
 virtual void ice_sent();
};
```

## Java Mapping

The base proxy class `ObjectPrx` defines the asynchronous flush operation as shown below:

```
Java
```

```
package Ice;

public class ObjectPrx ... {
 // ...
 boolean ice_flushBatchRequests_async(AMI_Object_ice_flushBatchReque
sts cb);
}
```

The argument is a reference for an object that implements the following class:

```
Java
```

```
package Ice;

public abstract class AMI_Object_ice_flushBatchRequests ...
{
 public abstract void ice_exception(LocalException ex);
}
```

As an example, the class below demonstrates how to define a callback class that also receives a notification when the asynchronous flush completes:

**Java**

```
class MyFlushCallbackI extends Ice.AMI_Object_ice_flushBatchRequests
 implements Ice.AMISentCallback
{
 public void ice_exception(Ice.LocalException ex) { ... }
 public void ice_sent() { ... }
}
```

**C# Mapping**

The base proxy class `ObjectPrx` defines the asynchronous flush operation as shown below:

**C#**

```
namespace Ice {
 public class ObjectPrx : ... {
 // ...
 bool ice_flushBatchRequests_async(AMI_Object_ice_flushBatchRequ
ests cb);
 }
}
```

The argument is a reference for an object that implements the following class:

**C#**

```
namespace Ice {
 public abstract class AMI_Object_ice_flushBatchRequests ... {
 public abstract void ice_exception(Ice.Exception ex);
 }
}
```

As an example, the class below demonstrates how to define a callback class that also receives a notification when the asynchronous flush completes:

**C#**

```
class MyFlushCallbackI : Ice.AMI_Object_ice_flushBatchRequests,
 Ice.AMISentCallback
{
 public override void
 ice_exception(Ice.LocalException ex) { ... }

 public void ice_sent() { ... }
}
```

## Python Mapping

The base proxy class defines the asynchronous flush operation as shown below:

```

Python
def ice_flushBatchRequests_async(self, cb)
```

The `cb` argument represents a callback object that must implement an `ice_exception` method. As an example, the class below demonstrates how to define a callback class that also receives a notification when the asynchronous flush completes:

```

Python
class MyFlushCallbackI(object):
 def ice_exception(self, ex):
 # handle an exception

 def ice_sent(self):
 # flush has completed
```

## Handling Timeouts with Deprecated AMI Mapping

Timeouts for asynchronous invocations behave like those for synchronous invocations: an `Ice::TimeoutException` is raised if the response is not received within the given time period. In the case of an asynchronous invocation, however, the exception is reported to the `ice_exception` method of the invocation's callback object. For example, we can handle this exception in C++ as shown below:

```

C++
class AMI_Model_interpolateI : public Demo::AMI_Model_interpolate
{
public:
 // ...

 virtual void ice_exception(const Ice::Exception& ex)
 {
 try {
 ex.ice_throw();
 } catch (const Demo::RangeError& e) {
 cerr << "interpolate failed: range error" << endl;
 } catch (const Ice::TimeoutException&) {
 cerr << "interpolate failed: timeout" << endl;
 } catch (const Ice::LocalException& e) {
 cerr << "interpolate failed: " << e << endl;
 }
 }
};
```

## Handling Errors with Deprecated AMI Mapping

It is important to remember that all errors encountered by an AMI invocation (except `CommunicatorDestroyedException`) are reported back via the `ice_exception` callback, even if the error condition is encountered "on the way out", when the operation is invoked. The reason for this is consistency: if an invocation, such as `foo_async` could throw exceptions, you would have to handle exceptions in two places in your code: at the point of call for exceptions that are encountered "on the way out", and in `ice_exception` for error conditions that are detected after the call is initiated.

Where this matters is if you want to send off a number of AMI calls, each of which depends on the preceding call to have succeeded. For example:

**C++**

```
p1->foo_async(cb1);
p2->bar_async(cb2);
```

If `bar` depends for its correct working on the successful completion of `foo`, this code will not work because the `bar` invocation will be sent regardless of whether `foo` failed or not.

In such cases, where you need to be sure that one call is dispatched only if a preceding call succeeds, you must instead invoke `bar` from within `foo`'s `ice_response` implementation, instead of from the main-line code.

## AMI Limitations

AMI invocations cannot be sent using [collocated optimization](#). If you attempt to invoke an AMI operation using a proxy that is configured to use collocation optimization, the Ice run time will raise `CollocationOptimizationException` if the servant happens to be collocated; the request is sent normally if the servant is not collocated. This optimization is enabled by default (as specified by the `Ice.Default.CollocationOptimized` property) but can be disabled on individual proxies using a [proxy method](#).

### See Also

- [Location Transparency](#)
- [The Ice Threading Model](#)
- [Thread Pool Design Considerations](#)
- [Deprecated AMI Language Mappings](#)

## IDE Integration

ZeroC provides plug-ins for several popular integrated development environments to simplify the task of building applications with Ice.

### Topics

- [Visual Studio Add-in](#)
- [Eclipse Plug-in](#)
- [Xcode Plug-in](#)



## Visual Studio Add-in

The Ice Visual Studio Add-in manages all aspects of code generation for C++ and .NET projects, including automatically recompiling Slice files that have changed, removing obsolete generated files, and tracking dependencies.

On this page:

- [Activating the Add-in for a Visual Studio Project](#)
- [Configuring Project Settings for Visual Studio](#)
- [Using Environment Variables in Visual Studio Settings](#)
- [Adding Slice Files to a Visual Studio Project](#)
- [Generating Code for a Visual Studio Project](#)
- [How the Add-in Locates your Ice Installation](#)
- [\\$\(IceHome\) Macro](#)
- [\\$\(IceInclude\) Macro](#)
- [\\$\(IceBin\) Macro](#)
- [\\$\(IceLib\) Macro](#)
- [.NET DEVPATH support](#)
- [Command-line Builds using Visual Studio](#)

### Activating the Add-in for a Visual Studio Project

Right-click on the project in the Solution Explorer and choose *Ice Configuration...* or select *Ice Configuration...* in the *Tools* menu. This opens a dialog that allows you to configure the project settings for Ice.



Note that, after adding new configurations or platforms to your project, it may be necessary to disable and then re-enable the add-in for the new configuration or platform to get the correct Ice settings.

### Configuring Project Settings for Visual Studio

The following settings are available:

- **Enable Ice Builder**  
This box must be checked to enable the Ice Builder in your project.
- **Trace Level**  
You can change the verbosity of messages printed to the *Output* panel by selecting a different trace level, where **Errors Only** is less verbose and **Debug** is more verbose.
- **Output directory for generated files**  
Set the directory for storing generated files.
- **Slice compiler options**  
Tick the corresponding check boxes to pass `--tie` (.NET only), `--ice`, `--checksum`, or `--stream` options to the Slice compiler.
- **Additional Slice compiler options**  
Enter extra Slice compiler options not supported by **Slice compiler options**. These options are entered the same as they would be on the command line. For example, you can define preprocessor macros by entering `-DFOO -DBAR`.
- **Macro for exporting symbols from DLL (C++ only)**  
The macro for annotating generated code to mark symbols that should be exported from a shared library or DLL, equivalent to the Slice compiler option `--dll-export`.
- **Slice include directories**  
The list of directories to search for included Slice files (`-I` option). The checkbox for each path controls whether the path is passed to the `-I` option as an absolute path or as a path relative to the project directory.





The add-in automatically adds the main `slice` directory of your Ice installation to this list.

- **Link project with these additional libraries** (C++ only)  
Every Ice project is linked with the `Ice` and `IceUtil` libraries. You can link with additional Ice libraries by checking the appropriate boxes.
- **Add references to the following assemblies** (.NET only)  
Every Ice project references the `Ice` assembly. You can reference additional Ice assemblies by checking the appropriate boxes.

## Using Environment Variables in Visual Studio Settings

You can include references to environment variables in the settings for **Output directory for generated files**, **Additional Slice compiler options**, and **Slice include directories**. To do this, the environment variable must be entered using the format `$(VAR)`. For example, for **Slice include directories** you could use `$(MY_PATH)`.

You cannot use environment variables in the `--header-ext` and `--source-ext` options in **Additional Slice compiler options**.

## Adding Slice Files to a Visual Studio Project

Use *Add -> New Item...* and select *Slice File (.ice)* as the template to create and add a Slice file to a project. To add an existing Slice file to a project, use *Add -> Existing Item...*

## Generating Code for a Visual Studio Project

The add-in compiles a Slice file whenever you save the file. The add-in tracks dependencies among Slice files in the project and, after a change, recompiles only the affected files.

Generated files are automatically added to the project. For example, for `Demo.ice`, the add-in for C++ adds `Demo.cpp` and `Demo.h` to the project, whereas the add-in for .NET adds `Demo.cs` to the project.

Slice compilation errors are displayed in the Visual Studio *Output* and *Error List* panels.

## How the Add-in Locates your Ice Installation

The add-in derives the location of your Ice installation from the location of its own DLL. For example, if the add-in's DLL is installed in `C:\Ice\vsaddin` then the add-in uses `C:\Ice` as the top-level Ice installation directory. The add-in uses this top-level directory to compose the path names of other subdirectories, such as `C:\Ice\slice` as the location of the Slice files included in your Ice distribution, `C:\Ice\bin` as the location of the Slice compilers, and so on.

### `$(IceHome)` Macro

The add-in makes extensive use of the `$(IceHome)` macro in C++ projects. `$(IceHome)` provides the full path to the home directory of the Ice installation on the local computer. This macro may be used in user settings, for example to locate `slice2freeze.exe` (as `$(IceHome)\bin\slice2freeze.exe`) or the Ice Slice directory (as `$(IceHome)\slice`).

This macro is set through a Visual Studio C++ property sheet installed as part of the Ice installation on Windows: `%AllUsersProfile%\ZeroC\Ice.props` for Visual Studio 2010 and Visual Studio 2012.

### `$(IceInclude)` Macro

The `$(IceInclude)` macro provides the full path to the C++ `include` directory of the Ice installation on the local computer.

### `$(IceBin)` Macro

The `$(IceBin)` macro provides the full path to the C++ `bin` directory of the Ice installation on the local computer. The macro takes into

account the platform and compiler that are being used. The macro is used for example to set the `PATH` environment variable when debugging C++ applications.

## `$(IceLib)` Macro

The `$(IceLib)` macro provides the full path to the C++ `lib` directory of the Ice installation on the local computer. The macro takes into account the platform and compiler that are being used. The macro is used for example to set the library path in the linker settings.

## .NET DEVPATH support

The add-in detects if a .NET project is configured for development mode by inspecting the `<application-name>.exe.config` file. If a project is in development mode, the Ice assemblies directory is automatically added to the `DEVPATH` environment variable when the demo is run. References to Ice components are also set with `Copy Local` to false to avoid copying Ice assemblies to the project's output directory. Note that the `Copy Local` setting is not changed for references that are already added to the project.

## Command-line Builds using Visual Studio

The add-in supports command-line builds using `devenv`. For example:

```
devenv MyProject.sln /build
```

Note that for this to work, command-line builds must be enabled for the add-in in the IDE; see *Tools -> Add-in Manager* and check *Command Line* for Ice.

### See Also

- [slice2cpp Command-Line Options](#)
- [slice2cs Command-Line Options](#)

## Eclipse Plug-in

The Slice2Java Eclipse plug-in manages all aspects of code generation, including automatically recompiling Slice files that have changed, removing obsolete generated classes, and tracking dependencies.

On this page:

- [Configuring the Slice2Java Eclipse Plug-in](#)
- [Activating the Slice2Java Plug-in for a Project](#)
- [Configuring Slice2Java Project Settings](#)
  - [Settings in the Source Tab](#)
  - [Settings in the Options Tab](#)
- [Configuring Slice2Java File Settings](#)

## Configuring the Slice2Java Eclipse Plug-in

Choose *Window -> Preferences*, select *Slice2Java*, and review the default setting for the location of your Ice installation. The property pane will display an error message if the plug-in considers the specified location to be invalid. If necessary, click *Browse...* to pick the top-level directory of your Ice installation and apply your changes.

The Slice2Java plug-in automatically configures a workspace classpath variable named `ICE_JAR_HOME` that refers to the subdirectory containing the Ice JAR files. This variable is primarily intended for use in Android projects.

## Activating the Slice2Java Plug-in for a Project

You can activate the Slice2Java plug-in for your project by right-clicking on the project, choosing *Slice2Java* and clicking *Add Slice2Java builder*. The plug-in immediately makes several additions to your project:

- Creates a `slice` subdirectory to contain your Slice files. The plug-in automatically compiles any Slice file that you add to this directory.
- Creates a `generated` subdirectory to hold the Java source files that the slice2java translator generates from your Slice files.
- Adds a library reference to the Ice run time JAR file (`Ice.jar`). The plug-in assumes that the JAR file resides in the `lib` subdirectory of your Ice installation.

## Configuring Slice2Java Project Settings

To configure the project-specific Slice2Java settings, select *Properties* from the *Project* menu or right-click on the name of your project and choose *Properties*. Click on *Slice2Java Properties* to view the plug-in's configuration settings, which are presented in two tabs: Source and Options.

### Settings in the Source Tab

This tab configures the directories of your Slice files and generated code. The plug-in includes the `slice` subdirectory by default, but you can remove this directory and add other directories if necessary. The plug-in only compiles Slice files that are located in the configured subdirectories.

For the generated code, the plug-in uses the default name `generated` for the subdirectory. If you want to store your generated code in a different directory, you must first create the directory and then click *Browse* to select it. The new directory must be empty otherwise the plug-in will reject your change. The plug-in also requires exclusive use of this directory, therefore you must not place other project resources in it.

### Settings in the Options Tab

This tab is where you configure additional plug-in settings. You can enter a list of include directories corresponding to the compiler's `-I` option. You can also specify preprocessor macros and metadata definitions in the fields provided. Finally, checkboxes offer additional control over certain features of the plug-in and the Slice compiler. When enabled, the checkboxes have the following semantics:

- **Enable streaming** generates code to support the dynamic streaming API
- **Enable tie** generates TIE classes
- **Enable ice** instructs the compiler to accept Slice symbols that use the `ice` prefix
- **Enable console** causes the plug-in to emit diagnostic information about its activities to Eclipse's console
- **Enable underscore** determines whether underscores are permitted in Slice identifiers (this feature is only supported in Ice 3.4.1 or later)

Options are also provided for adding reference to libraries for the various Ice services, such as IceGrid and Glacier2.

## Configuring Slice2Java File Settings

The [project settings](#) described above serve as the default compiler settings for all Slice files in the project. You may also override the compiler settings on a per-file basis by selecting a Slice file in *Package Explorer* and choosing *Properties* from the *File* menu, or by right-clicking on the file and choosing *Properties*. Select *Slice2Java Properties* to configure the Slice compiler settings, which have the same semantics as those in the *Options* tab described earlier.

### See Also

- [Using the Slice Compiler for Java](#)

## Xcode Plug-in

The Xcode plug-in manages all aspects of code generation, including automatically recompiling Slice files that have changed, removing obsolete generated classes, and tracking dependencies. The Xcode plugin is provided with the Ice Touch installer.

On this page:

- [Adding Slice Files to an Xcode Project](#)
- [Configuring Xcode Project Settings](#)
- [Xcode Project Settings for Cocoa and iPhone Applications](#)
- [Configuring Non-SDK Builds](#)
- [Generating Code using Xcode](#)

### Adding Slice Files to an Xcode Project

To add an existing Slice file, select a folder in the project, select *File*, and choose *Add -> Existing Files...*

To create a new Slice file, select a folder in the project, select *File*, and choose *New -> New Files...* Select the *Other* category and choose *Empty File* as the file type. Save the file with a `.ice` extension.

### Configuring Xcode Project Settings

The Xcode plug-in is configured using the per-target info build settings, just as you would configure the compiler settings. Select a target, and then select the build settings tab, and enter `slice` in the *Search in Build Settings* field.

- **Header Directory**  
Directory to use as the header include directory in source files.
- **Header Search Paths**  
The list of directories to search for included Slice files (`-I` option). Note that the Ice Slice files are automatically in the header search path.
- **Ice Home**  
If you are building with the Ice Touch Xcode SDK, this should be left unset; otherwise, if using the command-line toolkit or regular Ice, set this to the location of the installation (`/Library/Developer/Ice-3.5.0` or `/Library/Developer/IceTouch-1.3.0`).
- **Output Directory**  
Directory to place files generated by the Slice compiler.
- **Permit 'Ice' prefix**  
Pass `--ice` to the Slice compiler.
- **Streaming support**  
Pass `--stream` to the Slice compiler (C++ only).
- **Checksum support**  
Pass `--checksum` to the Slice compiler (C++ only).
- **Preprocessor Macros**  
Set the list of preprocessor macros to define (`-D` option).
- **Translate C++ code**  
Leave this option unset for an SDK build. For non-SDK builds, setting this option means `slice2cpp` is used to compile the Slice files; otherwise, `slice2objc` is used.
- **Underscore support**  
Permit underscores in Slice identifiers.
- **Link with Ice services client libraries**  
Link with Glacier2, IceStorm and IceGrid client libraries.

You can also define Slice compiler options for individual Slice source files. Select your project in the Project Navigator, select the relevant target (you may have only one), then select the *Build Phases* tab, expand the *Compile Sources* phase and the *Compiler Flags* column lets you set each file's options for that target.

## Xcode Project Settings for Cocoa and iPhone Applications

For Cocoa and iPhone applications, which use the Xcode SDK, you must add the appropriate directory to *Additional SDKs*:

Objective-C SDK	<code>/Library/Developer/IceTouch-1.3/SDKs/ObjC/\$(PLATFORM_NAME).sdk</code>
C++ SDK	<code>/Library/Developer/IceTouch-1.3/SDKs/Cpp/\$(PLATFORM_NAME).sdk</code>

In addition, when creating a new iPhone Xcode project, you must set the Code Signing Resource Rules Path to:

```
$(SDKROOT)/ResourceRules.plist
```

You must also add the following to the `Frameworks` folder:

```
CFNetwork.framework
Security.framework
Foundation.framework
```

When using the Objective-C SDK you must also add the following to the `Frameworks` folder:

```
ExternalAccessory.framework
```

## Configuring Non-SDK Builds

For non-SDK builds, you must configure the location of the Ice or Ice Touch header and library directories.

Under the *Search Paths* section in the project build settings:

- Add `/Library/Developer/Ice-3.5.0/include` for Ice or `/Library/Developer/IceTouch-1.3.0/include` to the *Header Search Paths* setting.
- Add `/Library/Developer/Ice-3.5.0/lib` for Ice or `/Library/Developer/IceTouch-1.3.0/lib` to the *Library Search Paths* setting.

## Generating Code using Xcode

The plug-in compiles a Slice file whenever you build the project. The extension tracks dependencies among Slice files in the project and recompiles only those files that require it after a change.

### See Also

- [slice2objc Command-Line Options](#)

# Slice API Reference

## Modules

[Ice](#) — The Ice core library.

[IceGrid](#) — IceGrid is a server activation and deployment tool.

[Freeze](#) — Freeze provides automatic persistence for Ice servants.

[IceSSL](#) — IceSSL provides a secure transport for Ice.

[Glacier2](#) — Glacier2 is a firewall solution for Ice.

[IceBox](#) — IceBox is an application server specifically for Ice applications.

[IceStorm](#) — A messaging service with support for federation.

[IcePatch2](#) — IcePatch can be used to update file hierarchies in a simple and efficient manner.

[IceMX](#) — The Ice Management eXtension facility.

---



# Ice Slice API

---

## Ice

### Overview

#### module Ice

The Ice core library. Among many other features, the Ice core library manages all the communication tasks using an efficient protocol (including protocol compression and support for both TCP and UDP), provides a thread pool for multi-threaded servers, and additional functionality that supports high scalability.

### Module Index

[Instrumentation](#) — The Instrumentation local interfaces enable observing a number of Ice core internal components (threads, connections, etc).

### Class Index

[ConnectionInfo](#) — Base class providing access to the connection details.  
[EndpointInfo](#) — Base class providing access to the endpoint details.  
[IPConnectionInfo](#) — Provides access to the connection details of an IP connection  
[IPEndpointInfo](#) — Provides access to the address details of a IP endpoint.  
[OpaqueEndpointInfo](#) — Provides access to the details of an opaque endpoint.  
[TCPConnectionInfo](#) — Provides access to the connection details of a TCP connection  
[TCPEndpointInfo](#) — Provides access to a TCP endpoint information.  
[UDPConnectionInfo](#) — Provides access to the connection details of a UDP connection  
[UDPEndpointInfo](#) — Provides access to an UDP endpoint information.

### Interface Index

[Communicator](#) — The central object in Ice.  
[Connection](#) — The user-level interface to a connection.  
[Endpoint](#) — The user-level interface to an endpoint.  
[ImplicitContext](#) — An interface to associate implicit contexts with communicators.  
[Locator](#) — The Ice locator interface.  
[LocatorRegistry](#) — The Ice locator registry interface.  
[Logger](#) — The Ice message logger.  
[ObjectAdapter](#) — The object adapter provides an up-call interface from the Ice run time to the implementation of Ice objects.  
[ObjectFactory](#) — A factory for objects.  
[Plugin](#) — A communicator plug-in.  
[PluginManager](#) — Each communicator has a plug-in manager to administer the set of plug-ins.  
[Process](#) — An administrative interface for process management.  
[Properties](#) — A property set used to configure Ice and Ice applications.  
[PropertiesAdmin](#) — The PropertiesAdmin interface provides remote access to the properties of a communicator.  
[Router](#) — The Ice router interface.  
[ServantLocator](#) — A servant locator is called by an object adapter to locate a servant that is not found in its active servant map.  
[Stats](#) — An interface Ice uses to report statistics, such as how much data is sent or received. (*Deprecated*)

### Exception Index

[AdapterAlreadyActiveException](#) — This exception is raised if a server tries to set endpoints for an adapter that is already active.  
[AdapterNotFoundException](#) — This exception is raised if an adapter cannot be found.  
[AlreadyRegisteredException](#) — An attempt was made to register something more than once with the Ice run time.

**BadMagicException** — This exception indicates that a message did not start with the expected magic number ('I', 'c', 'e', 'P').

**CloneNotImplementedException** — An attempt was made to clone a class that does not support cloning.

**CloseConnectionException** — This exception indicates that the connection has been gracefully shut down by the server.

**CloseTimeoutException** — This exception indicates a connection closure timeout condition.

**CollocationOptimizationException** — This exception is raised if a feature is requested that is not supported with collocation optimization.

**CommunicatorDestroyedException** — This exception is raised if the [Communicator](#) has been destroyed.

**CompressionException** — This exception indicates a problem with compressing or uncompressing data.

**ConnectFailedException** — This exception indicates connection failures.

**ConnectTimeoutException** — This exception indicates a connection establishment timeout condition.

**ConnectionLostException** — This exception indicates a lost connection.

**ConnectionNotValidatedException** — This exception is raised if a message is received over a connection that is not yet validated.

**ConnectionRefusedException** — This exception indicates a connection failure for which the server host actively refuses a connection.

**ConnectionTimeoutException** — This exception indicates that a connection has been shut down because it has been idle for some time.

**DNSException** — This exception indicates a DNS problem.

**DatagramLimitException** — A datagram exceeds the configured size.

**EncapsulationException** — This exception indicates a malformed data encapsulation.

**EndpointParseException** — This exception is raised if there was an error while parsing an endpoint.

**EndpointSelectionTypeParseException** — This exception is raised if there was an error while parsing an endpoint selection type.

**FacetNotExistException** — This exception is raised if no facet with the given name exists, but at least one facet with the given identity exists.

**FeatureNotSupportedException** — This exception is raised if an unsupported feature is used.

**FileException** — This exception indicates file errors.

**FixedProxyException** — This exception indicates that an attempt has been made to change the connection properties of a fixed proxy.

**ForcedCloseConnectionException** — This exception is raised by an operation call if the application forcefully closes the connection [Connecton::close](#).

**IdentityParseException** — This exception is raised if there was an error while parsing a stringified identity.

**IllegalIdentityException** — This exception is raised if an illegal identity is encountered.

**IllegalMessageSizeException** — This exception indicates that a message size is less than the minimum required size.

**InitializationException** — This exception is raised when a failure occurs during initialization.

**InvalidReplicaGroupIdException** — This exception is raised if the replica group provided by the server is invalid.

**MarshalException** — This exception is raised for errors during marshaling or unmarshaling data.

**MemoryLimitException** — This exception is raised if a request size exceeds the limit specified by the `Ice.MessageSizeMax` property.

**NoEndpointException** — This exception is raised if no suitable endpoint is available.

**NoObjectFactoryException** — This exception is raised if no suitable object factory was found during unmarshaling of a `Slice` class instance.

**NotRegisteredException** — An attempt was made to find or deregister something that is not registered with the Ice run time or Ice locator.

**ObjectAdapterDeactivatedException** — This exception is raised if an attempt is made to use a deactivated [ObjectAdapter](#).

**ObjectAdapterIdInUseException** — This exception is raised if an [ObjectAdapter](#) cannot be activated.

**ObjectNotExistException** — This exception is raised if an object does not exist on the server, that is, if no facets with the given identity exist.

**ObjectNotFoundException** — This exception is raised if an object cannot be found.

**OperationNotExistException** — This exception is raised if an operation for a given object does not exist on the server.

**PluginInitializationException** — This exception indicates that a failure occurred while initializing a plug-in.

**ProtocolException** — A generic exception base for all kinds of protocol error conditions.

**ProxyParseException** — This exception is raised if there was an error while parsing a stringified proxy.

**ProxyUnmarshalException** — This exception is raised if inconsistent data is received while unmarshaling a proxy.

**RequestFailedException** — This exception is raised if a request failed.

**ResponseSentException** — Indicates that the response to a request has already been sent; re-dispatching such a request is not possible.

**SecurityException** — This exception indicates a failure in a security subsystem, such as the `IceSSL` plug-in.

**ServerNotFoundException** — This exception is raised if a server cannot be found.

**SocketException** — This exception indicates socket errors.

**StringConversionException** — This exception is raised when a string conversion to or from UTF-8 fails during marshaling or unmarshaling.

**SyscallException** — This exception is raised if a system error occurred in the server or client process.

**TimeoutException** — This exception indicates a timeout condition.

**TwowayOnlyException** — The operation can only be invoked with a twoway request.

**UnexpectedObjectException** — This exception is raised if the type of an unmarshaled `Slice` class instance does not match its expected type.

**UnknownException** — This exception is raised if an operation call on a server raises an unknown exception.

**UnknownLocalException** — This exception is raised if an operation call on a server raises a local exception.

**UnknownMessageException** — This exception indicates that an unknown protocol message has been received.

**UnknownReplyStatusException** — This exception indicates that an unknown reply status has been received.

[UnknownRequestIdException](#) — This exception indicates that a response for an unknown request ID has been received.

[UnknownUserException](#) — An operation raised an incorrect user exception.

[UnmarshalOutOfBoundsException](#) — This exception is raised if an out-of-bounds condition occurs during unmarshaling.

[UnsupportedEncodingException](#) — This exception indicates an unsupported data encoding version.

[UnsupportedProtocolException](#) — This exception indicates an unsupported protocol version.

[VersionMismatchException](#) — This exception is raised if the Ice library version does not match the version in the Ice header files.

[VersionParseException](#) — This exception is raised if there was an error while parsing a version.

## Structure Index

[Current](#) — Information about the current method invocation for servers.

[EncodingVersion](#) — A version structure for the encoding version.

[Identity](#) — The identity of an Ice object.

[ProtocolVersion](#) — A version structure for the protocol version.

## Sequence Index

[BoolSeq](#) — A sequence of bools.

[ByteSeq](#) — A sequence of bytes.

[DoubleSeq](#) — A sequence of doubles.

[EndpointSeq](#) — A sequence of endpoints.

[FloatSeq](#) — A sequence of floats.

[IdentitySeq](#) — A sequence of identities.

[IntSeq](#) — A sequence of ints.

[LongSeq](#) — A sequence of longs.

[ObjectProxySeq](#) — A sequence of object proxies.

[ObjectSeq](#) — A sequence of objects.

[ShortSeq](#) — A sequence of shorts.

[StringSeq](#) — A sequence of strings.

## Dictionary Index

[Context](#) — A request context.

[FacetMap](#) — A mapping from facet name to servant.

[ObjectDict](#) — A mapping between identities and Ice objects.

[PropertyDict](#) — A simple collection of properties, represented as a dictionary of key/value pairs.

[SliceChecksumDict](#) — A mapping from type IDs to Slice checksums.

## Constant Index

[TCPEndpointType](#) — Uniquely identifies TCP endpoints.

[UDPEndpointType](#) — Uniquely identifies UDP endpoints.

## Enumeration Index

[EndpointSelectionType](#) — Determines the order in which the Ice run time uses the endpoints in a proxy when establishing a connection.

[OperationMode](#) — The [OperationMode](#) determines the retry behavior an invocation in case of a (potentially) recoverable error.

## Sequences

### `sequence<bool>` [BoolSeq](#)

A sequence of bools.

### `sequence<byte>` [ByteSeq](#)

A sequence of bytes.

**Used By**

- BadMagicException::badMagic
- IcePatch2::ByteSeqSeq
- IcePatch2::FileInfo::checksum
- IcePatch2::FileServer::getChecksum
- IcePatch2::FileServer::getFileCompressed
- OpaqueEndpointInfo::rawBytes

**sequence<double> DoubleSeq**

A sequence of doubles.

**local sequence<Endpoint> EndpointSeq**

A sequence of endpoints.

**Used By**

- ObjectAdapter::getEndpoints
- ObjectAdapter::getPublishedEndpoints

**sequence<float> FloatSeq**

A sequence of floats.

**sequence<Identity> IdentitySeq**

A sequence of identities.

**Used By**

- Glacier2::IdentitySet::add
- Glacier2::IdentitySet::get
- Glacier2::IdentitySet::remove
- IceStorm::Topic::getSubscribers

**sequence<int> IntSeq**

A sequence of ints.

**sequence<long> LongSeq**

A sequence of longs.

**sequence<Object\*> ObjectProxySeq**

A sequence of object proxies.

**Used By**

- IceGrid::Query::findAllObjectsByType
- IceGrid::Query::findAllReplicas
- Router::addProxies

**sequence<Object> ObjectSeq**

A sequence of objects.

### **sequence<short> ShortSeq**

A sequence of shorts.

### **sequence<string> StringSeq**

A sequence of strings.

#### **Used By**

- Glacier2::SSLInfo::certs
- Glacier2::StringSet::add
- Glacier2::StringSet::get
- Glacier2::StringSet::remove
- IceBox::Service::start
- IceBox::ServiceObserver::servicesStarted
- IceBox::ServiceObserver::servicesStopped
- IceGrid::Admin::getAllAdapterIds
- IceGrid::Admin::getAllApplicationNames
- IceGrid::Admin::getAllNodeNames
- IceGrid::Admin::getAllRegistryNames
- IceGrid::Admin::getAllServerIds
- IceGrid::ApplicationUpdateDescriptor::removeNodes
- IceGrid::ApplicationUpdateDescriptor::removePropertySets
- IceGrid::ApplicationUpdateDescriptor::removeReplicaGroups
- IceGrid::ApplicationUpdateDescriptor::removeServerTemplates
- IceGrid::ApplicationUpdateDescriptor::removeServiceTemplates
- IceGrid::ApplicationUpdateDescriptor::removeVariables
- IceGrid::CommunicatorDescriptor::logs
- IceGrid::DistributionDescriptor::directories
- IceGrid::FileIterator::read
- IceGrid::NodeUpdateDescriptor::removePropertySets
- IceGrid::NodeUpdateDescriptor::removeServers
- IceGrid::NodeUpdateDescriptor::removeVariables
- IceGrid::PatchException::reasons
- IceGrid::PropertySetDescriptor::references
- IceGrid::ServerDescriptor::envs
- IceGrid::ServerDescriptor::options
- IceGrid::TemplateDescriptor::parameters
- IceMX::MetricsAdmin::getMetricsViewNames
- IceSSL::ConnectionInfo::certs
- PluginManager::getPlugins
- Properties::getCommandLineOptions
- Properties::getPropertyAsListWithDefault
- Properties::getPropertyAsList
- Properties::parseCommandLineOptions
- Properties::parseIceCommandLineOptions

## **Dictionaries**

### **dictionary<string, string> Context**

A request context. `Context` is used to transmit metadata about a request from the server to the client, such as Quality-of-Service (QoS) parameters. Each operation on the client has a `Context` as its implicit final parameter.

#### **Used By**

- `Current::ctx`
- `ImplicitContext::getContext`
- `ImplicitContext::setContext`
- `Instrumentation::CommunicatorObserver::getInvocationObserver`

### local dictionary<string, Object> FacetMap

A mapping from facet name to servant.

#### Used By

- `ObjectAdapter::findAllFacets`
- `ObjectAdapter::removeAllFacets`

### local dictionary<Identity, Object> ObjectDict

A mapping between identities and Ice objects.

### dictionary<string, string> PropertyDict

A simple collection of properties, represented as a dictionary of key/value pairs. Both key and value are strings.

#### Used By

- `Communicator::proxyToProperty`
- `Properties::getPropertiesForPrefix`
- `PropertiesAdmin::getPropertiesForPrefix`
- `PropertiesAdmin::setProperties`

#### See Also

- `Properties::getPropertiesForPrefix`

### dictionary<string, string> SliceChecksumDict

A mapping from type IDs to Slice checksums. The dictionary allows verification at run time that client and server use matching Slice definitions.

#### Used By

- `IceBox::ServiceManager::getSliceChecksums`
- `IceGrid::Admin::getSliceChecksums`
- `IceStorm::TopicManager::getSliceChecksums`

## Constants

```
const short TCPEndpointType = 1;
```

Uniquely identifies TCP endpoints.

```
const short UDPEndpointType = 3;
```

Uniquely identifies UDP endpoints.

---

## Ice-AdapterAlreadyActiveException

---

### Ice::AdapterAlreadyActiveException

#### Overview

#### exception AdapterAlreadyActiveException

This exception is raised if a server tries to set endpoints for an adapter that is already active.

#### *Used By*

- Ice::LocatorRegistry::setAdapterDirectProxy
  - Ice::LocatorRegistry::setReplicatedAdapterDirectProxy
-

## Ice-AdapterNotFoundException

---

### Ice::AdapterNotFoundException

#### Overview

exception AdapterNotFoundException

This exception is raised if an adapter cannot be found.

#### *Used By*

- Ice::Locator::findAdapterById
  - Ice::LocatorRegistry::setAdapterDirectProxy
  - Ice::LocatorRegistry::setReplicatedAdapterDirectProxy
-



# Ice-AlreadyRegisteredException

---

## Ice::AlreadyRegisteredException

### Overview

#### local exception `AlreadyRegisteredException`

An attempt was made to register something more than once with the Ice run time. This exception is raised if an attempt is made to register a servant, servant locator, facet, object factory, plug-in, object adapter, object, or user exception factory more than once for the same ID.

### Data Member Index

`kindOfObject` — The kind of object that is registered already: "servant", "servant locator", "object factory", "plug-in", "object adapter", "object", or "user exception factory".

`id` — The ID (or name) of the object that is registered already.

### Data Members

**string** `kindOfObject`;

The kind of object that is registered already: "servant", "servant locator", "object factory", "plug-in", "object adapter", "object", or "user exception factory".

**string** `id`;

The ID (or name) of the object that is registered already.

---

## Ice-BadMagicException

---

### Ice::BadMagicException

#### Overview

local exception `BadMagicException` extends `Ice::ProtocolException`

This exception indicates that a message did not start with the expected magic number ('I', 'c', 'e', 'P').

#### Data Member Index

`badMagic` — A sequence containing the first four bytes of the incorrect message.

#### Data Members

`Ice::ByteSeq` `badMagic`;

A sequence containing the first four bytes of the incorrect message.

---

## Ice-CloneNotImplementedException

---

### Ice::CloneNotImplementedException

#### Overview

#### local exception CloneNotImplementedException

An attempt was made to clone a class that does not support cloning. This exception is raised if `ice_clone` is called on a class that is derived from an abstract Slice class (that is, a class containing operations), and the derived class does not provide an implementation of the `ice_clone` operation (C++ only).

---

## Ice-CloseConnectionException

---

### Ice::CloseConnectionException

#### Overview

local exception `CloseConnectionException` extends `Ice::ProtocolException`

This exception indicates that the connection has been gracefully shut down by the server. The operation call that caused this exception has not been executed by the server. In most cases you will not get this exception, because the client will automatically retry the operation call in case the server shut down the connection. However, if upon retry the server shuts down the connection again, and the retry limit has been reached, then this exception is propagated to the application code.

---

## Ice-CloseTimeoutException

---

### Ice::CloseTimeoutException

#### Overview

local exception `CloseTimeoutException` extends `Ice::TimeoutException`

This exception indicates a connection closure timeout condition.

---

## Ice-CollocationOptimizationException

---

### Ice::CollocationOptimizationException

#### Overview

local exception `CollocationOptimizationException`

This exception is raised if a feature is requested that is not supported with collocation optimization.

---

# Ice-Communicator

---

## Ice::Communicator

### Overview

#### local interface Communicator

The central object in Ice. One or more communicators can be instantiated for an Ice application. Communicator instantiation is language-specific, and not specified in Slice code.

#### Used By

- [Freeze::Connection::getCommunicator](#)
- [Ice::ObjectAdapter::getCommunicator](#)
- [IceBox::Service::start](#)

#### See Also

- [Ice::Logger](#)
- [Ice::Stats](#)
- [Ice::ObjectAdapter](#)
- [Ice::Properties](#)
- [Ice::ObjectFactory](#)

### Operation Index

[destroy](#) — Destroy the communicator.

[shutdown](#) — Shuts down this communicator's server functionality, which includes the deactivation of all object adapters.

[waitForShutdown](#) — Wait until the application has called [shutdown](#) (or [destroy](#)).

[isShutdown](#) — Check whether communicator has been shut down.

[stringToProxy](#) — Convert a stringified proxy into a proxy.

[proxyToString](#) — Convert a proxy into a string.

[propertyToProxy](#) — Convert a set of proxy properties into a proxy.

[proxyToProperty](#) — Convert a proxy to a set of proxy properties.

[stringToIdentity](#) — Convert a string into an identity.

[identityToString](#) — Convert an identity into a string.

[createObjectAdapter](#) — Create a new object adapter.

[createObjectAdapterWithEndpoints](#) — Create a new object adapter with endpoints.

[createObjectAdapterWithRouter](#) — Create a new object adapter with a router.

[addObjectFactory](#) — Add an object factory to this communicator.

[findObjectFactory](#) — Find an object factory registered with this communicator.

[getImplicitContext](#) — Get the implicit context associated with this communicator.

[getProperties](#) — Get the properties for this communicator.

[getLogger](#) — Get the logger for this communicator.

[getStats](#) — Get the statistics callback object for this communicator.

[getObserver](#) — Get the observer resolver object for this communicator.

[getDefaultRouter](#) — Get the default router this communicator.

[setDefaultRouter](#) — Set a default router for this communicator.

[getDefaultLocator](#) — Get the default locator this communicator.

[setDefaultLocator](#) — Set a default Ice locator for this communicator.

[getPluginManager](#) — Get the plug-in manager for this communicator.

[flushBatchRequests](#) — Flush any pending batch requests for this communicator.

[getAdmin](#) — Get a proxy to the main facet of the Admin object.

[addAdminFacet](#) — Add a new facet to the Admin object.

[removeAdminFacet](#) — Remove the following facet to the Admin object.

[findAdminFacet](#) — Returns a facet of the Admin object.

## Operations

### void destroy()

Destroy the communicator. This operation calls `shutdown` implicitly. Calling `destroy` cleans up memory, and shuts down this communicator's client functionality and destroys all object adapters. Subsequent calls to `destroy` are ignored.

#### See Also

- `shutdown`
- `Ice::ObjectAdapter::destroy`

### void shutdown()

Shuts down this communicator's server functionality, which includes the deactivation of all object adapters. (Attempts to use a deactivated object adapter raise `Ice::ObjectAdapterDeactivatedException`.) Subsequent calls to `shutdown` are ignored.

*After `shutdown` returns, no new requests are processed. However, requests that have been started before `shutdown` was called might still be active. You can use `waitForShutdown` to wait for the completion of all requests.*

#### See Also

- `destroy`
- `waitForShutdown`
- `Ice::ObjectAdapter::deactivate`

### void waitForShutdown()

Wait until the application has called `shutdown` (or `destroy`). On the server side, this operation blocks the calling thread until all currently-executing operations have completed. On the client side, the operation simply block until another thread has called `shutdown` or `destroy`.

A typical use of this operation is to call it from the main thread, which then waits until some other thread calls `shutdown`. After shut-down is complete, the main thread returns and can do some cleanup work before it finally calls `destroy` to shut down the client functionality, and then exits the application.

#### See Also

- `shutdown`
- `destroy`
- `Ice::ObjectAdapter::waitForDeactivate`

### bool isShutdown()

Check whether communicator has been shut down.

#### Return Value

True if the communicator has been shut down; false otherwise.

#### See Also

- `shutdown`

### Object\* stringToProxy(string str)

Convert a stringified proxy into a proxy. For example, `MyCategory/MyObject:tcp -h some_host -p 10000` creates a proxy that refers to the Ice object having an identity with a name "MyObject" and a category "MyCategory", with the server running on host



"some\_host", port 10000. If the stringified proxy does not parse correctly, the operation throws one of [Ice::ProxyParseException](#), [Ice::EndpointParseException](#), or [Ice::IdentityParseException](#). An appendix in the Ice manual provides a detailed description of the syntax supported by stringified proxies.

**Parameters**

`str` — The stringified proxy to convert into a proxy.

**Return Value**

The proxy, or nil if `str` is an empty string.

**See Also**

- [proxyToString](#)

**string proxyToString(Object\* obj)**

Convert a proxy into a string.

**Parameters**

`obj` — The proxy to convert into a stringified proxy.

**Return Value**

The stringified proxy, or an empty string if `obj` is nil.

**See Also**

- [stringToProxy](#)

**Object\* propertyToProxy(string property)**

Convert a set of proxy properties into a proxy. The "base" name supplied in the `property` argument refers to a property containing a stringified proxy, such as `MyProxy=id:tcp -h localhost -p 10000`. Additional properties configure local settings for the proxy, such as `MyProxy.PreferSecure=1`. The "Properties" appendix in the Ice manual describes each of the supported proxy properties.

**Parameters**

`property` — The base property name.

**Return Value**

The proxy.

**Ice::PropertyDict proxyToProperty(Object\* proxy, string property)**

Convert a proxy to a set of proxy properties.

**Parameters**

`proxy` — The proxy.

`property` — The base property name.

**Return Value**

The property set.

**Ice::Identity stringToIdentity(string str)**

Convert a string into an identity. If the string does not parse correctly, the operation throws `Ice::IdentityParseException`.

**Parameters**

`str` — The string to convert into an identity.

**Return Value**

The identity.

**See Also**

- [identityToString](#)

**string identityToString(Ice::Identity ident)**

Convert an identity into a string.

**Parameters**

`ident` — The identity to convert into a string.

**Return Value**

The "stringified" identity.

**See Also**

- [stringToIdentity](#)

**Ice::ObjectAdapter createObjectAdapter(string name)**

Create a new object adapter. The endpoints for the object adapter are taken from the property `name.Endpoints`.

It is legal to create an object adapter with the empty string as its name. Such an object adapter is accessible via bidirectional connections or by collocated invocations that originate from the same communicator as is used by the adapter.

Attempts to create a named object adapter for which no configuration can be found raise `Ice::InitializationException`.

**Parameters**

`name` — The object adapter name.

**Return Value**

The new object adapter.

**See Also**

- [createObjectAdapterWithEndpoints](#)
- [Ice::ObjectAdapter](#)
- [Ice::Properties](#)

**Ice::ObjectAdapter createObjectAdapterWithEndpoints(string name, string endpoints)**

Create a new object adapter with endpoints. This operation sets the property `name.Endpoints`, and then calls [createObjectAdapter](#). It is provided as a convenience function.

Calling this operation with an empty name will result in a UUID being generated for the name.

**Parameters**

`name` — The object adapter name.

`endpoints` — The endpoints for the object adapter.

#### **Return Value**

The new object adapter.

#### **See Also**

- [createObjectAdapter](#)
- [Ice::ObjectAdapter](#)
- [Ice::Properties](#)

### **Ice::ObjectAdapter createObjectAdapterWithRouter(string name, Ice::Router\* rtr)**

Create a new object adapter with a router. This operation creates a routed object adapter.

Calling this operation with an empty name will result in a UUID being generated for the name.

#### **Parameters**

`name` — The object adapter name.

`rtr` — The router.

#### **Return Value**

The new object adapter.

#### **See Also**

- [createObjectAdapter](#)
- [Ice::ObjectAdapter](#)
- [Ice::Properties](#)

### **void addObjectFactory(Ice::ObjectFactory factory, string id)**

Add an object factory to this communicator. Installing a factory with an id for which a factory is already registered throws [Ice::AlreadyRegisteredException](#).

When unmarshaling an Ice object, the Ice run time reads the most-derived type id off the wire and attempts to create an instance of the type using a factory. If no instance is created, either because no factory was found, or because all factories returned nil, the behavior of the Ice run time depends on the format with which the object was marshaled:

If the object uses the "sliced" format, Ice ascends the class hierarchy until it finds a type that is recognized by a factory, or it reaches the least-derived type. If no factory is found that can create an instance, the run time throws [Ice::NoObjectFactoryException](#).

If the object uses the "compact" format, Ice immediately raises [Ice::NoObjectFactoryException](#).

The following order is used to locate a factory for a type:

1. The Ice run-time looks for a factory registered specifically for the type.
2. If no instance has been created, the Ice run-time looks for the default factory, which is registered with an empty type id.
3. If no instance has been created by any of the preceding steps, the Ice run-time looks for a factory that may have been statically generated by the language mapping for non-abstract classes.

#### **Parameters**

`factory` — The factory to add.

`id` — The type id for which the factory can create instances, or an empty string for the default factory.

#### **See Also**

- [findObjectFactory](#)

- [Ice::ObjectFactory](#)

### **Ice::ObjectFactory** findObjectFactory(string id)

Find an object factory registered with this communicator.

#### **Parameters**

`id` — The type id for which the factory can create instances, or an empty string for the default factory.

#### **Return Value**

The object factory, or null if no object factory was found for the given id.

#### **See Also**

- [addObjectFactory](#)
- [Ice::ObjectFactory](#)

### **Ice::ImplicitContext** getImplicitContext()

Get the implicit context associated with this communicator.

#### **Return Value**

The implicit context associated with this communicator; returns null when the property `Ice.ImplicitContext` is not set or is set to `None`.

### **Ice::Properties** getProperties()

Get the properties for this communicator.

#### **Return Value**

This communicator's properties.

#### **See Also**

- [Ice::Properties](#)

### **Ice::Logger** getLogger()

Get the logger for this communicator.

#### **Return Value**

This communicator's logger.

#### **See Also**

- [Ice::Logger](#)

### **Ice::Stats** getStats()

Get the statistics callback object for this communicator.

#### **Return Value**

This communicator's statistics callback object.

#### **See Also**

- [Ice::Stats](#)

**Ice::Instrumentation::CommunicatorObserver** `getObserver()`

Get the observer resolver object for this communicator.

**Return Value**

This communicator's observer resolver object.

**See Also**

- [Ice::Stats](#)

**Ice::Router\*** `getDefaultRouter()`

Get the default router this communicator.

**Return Value**

The default router for this communicator.

**See Also**

- [setDefaultRouter](#)
- [Ice::Router](#)

**void** `setDefaultRouter(Ice::Router* rtr)`

Set a default router for this communicator. All newly created proxies will use this default router. To disable the default router, null can be used. Note that this operation has no effect on existing proxies.

*You can also set a router for an individual proxy by calling the operation `ice_router` on the proxy.*

**Parameters**

`rtr` — The default router to use for this communicator.

**See Also**

- [getDefaultRouter](#)
- [createObjectAdapterWithRouter](#)
- [Ice::Router](#)

**Ice::Locator\*** `getDefaultLocator()`

Get the default locator this communicator.

**Return Value**

The default locator for this communicator.

**See Also**

- [setDefaultLocator](#)
- [Ice::Locator](#)

**void** `setDefaultLocator(Ice::Locator* loc)`

Set a default Ice locator for this communicator. All newly created proxy and object adapters will use this default locator. To disable the default locator, null can be used. Note that this operation has no effect on existing proxies or object adapters.

*You can also set a locator for an individual proxy by calling the operation `ice_locator` on the proxy, or for an object adapter by calling the operation `setLocator` on the object adapter.*

**Parameters**

`loc` — The default locator to use for this communicator.

**See Also**

- [getDefaultLocator](#)
- [Ice::Locator](#)
- [Ice::ObjectAdapter::setLocator](#)

**Ice::PluginManager getPluginManager()**

Get the plug-in manager for this communicator.

**Return Value**

This communicator's plug-in manager.

**See Also**

- [Ice::PluginManager](#)

**[ "async" ] void flushBatchRequests()**

Flush any pending batch requests for this communicator. This causes all batch requests that were sent via proxies obtained via this communicator to be sent to the server.

**Object\* getAdmin()**

Get a proxy to the main facet of the Admin object. When `Ice.Admin.DelayCreation` is greater than 0, it is necessary to call `getAdmin()` after the communicator is initialized to create the Admin object. Otherwise, the Admin object is created automatically after all the plug-ins are initialized.

**Return Value**

The main ("") facet of the Admin object; a null proxy if no Admin object is configured.

**void addAdminFacet(Object servant, string facet)**

Add a new facet to the Admin object. Adding a servant with a facet that is already registered throws `Ice::AlreadyRegisteredException`.

**Parameters**

`servant` — The servant that implements the new Admin facet.

`facet` — The name of the new Admin facet.

**Object removeAdminFacet(string facet)**

Remove the following facet to the Admin object. Removing a facet that was not previously registered throws `Ice::NotRegisteredException`.

**Parameters**

`facet` — The name of the Admin facet.

**Return Value**

The servant associated with this Admin facet.

**Object findAdminFacet(string facet)**

Returns a facet of the Admin object.

**Parameters**

facet — The name of the Admin facet.

**Return Value**

The servant associated with this Admin facet, or null if no facet is registered with the given name.

---

## Ice-CommunicatorDestroyedException

---

### Ice::CommunicatorDestroyedException

#### Overview

local exception `CommunicatorDestroyedException`

This exception is raised if the `Ice::Communicator` has been destroyed.

#### See Also

- `Ice::Communicator::destroy`
-



## Ice-CompressionException

---

### Ice::CompressionException

#### Overview

local exception `CompressionException` extends `Ice::ProtocolException`

This exception indicates a problem with compressing or uncompressing data.

---

## Ice-ConnectFailedException

---

### Ice::ConnectFailedException

#### Overview

local exception `ConnectFailedException` extends `Ice::SocketException`

This exception indicates connection failures.

#### *Derived Exceptions*

- `Ice::ConnectionRefusedException`
-

# Ice-Connection

---

## Ice::Connection

### Overview

#### local interface Connection

The user-level interface to a connection.

#### Used By

- [Ice::Current::con](#)

### Operation Index

[close](#) — Close a connection, either gracefully or forcefully.

[createProxy](#) — Create a special proxy that always uses this connection.

[setAdapter](#) — Explicitly set an object adapter that dispatches requests that are received over this connection.

[getAdapter](#) — Get the object adapter that dispatches requests for this connection.

[getEndpoint](#) — Get the endpoint from which the connection was created.

[flushBatchRequests](#) — Flush any pending batch requests for this connection.

[type](#) — Return the connection type.

[timeout](#) — Get the timeout for the connection.

[toString](#) — Return a description of the connection as human readable text, suitable for logging or error messages.

[getInfo](#) — Returns the connection information.

### Operations

#### void close(bool force)

Close a connection, either gracefully or forcefully. If a connection is closed forcefully, it closes immediately, without sending the relevant close connection protocol messages to the peer and waiting for the peer to acknowledge these protocol messages.

#### Parameters

`force` — If true, close forcefully. Otherwise the connection is closed gracefully.

#### Object\* createProxy(Ice::Identity id)

Create a special proxy that always uses this connection. This can be used for callbacks from a server to a client if the server cannot directly establish a connection to the client, for example because of firewalls. In this case, the server would create a proxy using an already established connection from the client.

#### Parameters

`id` — The identity for which a proxy is to be created.

#### Return Value

A proxy that matches the given identity and uses this connection.

#### See Also

- [setAdapter](#)

#### void setAdapter(Ice::ObjectAdapter adapter)

Explicitly set an object adapter that dispatches requests that are received over this connection. A client can invoke an operation on a server using a proxy, and then set an object adapter for the outgoing connection that is used by the proxy in order to receive callbacks. This is useful if the server cannot establish a connection back to the client, for example because of firewalls.

#### **Parameters**

`adapter` — The object adapter that should be used by this connection to dispatch requests. The object adapter must be activated. When the object adapter is deactivated, it is automatically removed from the connection.

#### **See Also**

- [createProxy](#)
- [setAdapter](#)

#### **Ice::ObjectAdapter getAdapter()**

Get the object adapter that dispatches requests for this connection.

#### **Return Value**

The object adapter that dispatches requests for the connection, or null if no adapter is set.

#### **See Also**

- [setAdapter](#)

#### **Ice::Endpoint getEndpoint()**

Get the endpoint from which the connection was created.

#### **Return Value**

The endpoint from which the connection was created.

#### **[ "async" ] void flushBatchRequests()**

Flush any pending batch requests for this connection. This causes all batch requests that were sent via proxies that use this connection to be sent to the server.

#### **string type()**

Return the connection type. This corresponds to the endpoint type, i.e., "tcp", "udp", etc.

#### **Return Value**

The type of the connection.

#### **int timeout()**

Get the timeout for the connection.

#### **Return Value**

The connection's timeout.

#### **string toString()**

Return a description of the connection as human readable text, suitable for logging or error messages.

#### **Return Value**

The description of the connection as human readable text.

**Ice::ConnectionInfo** getInfo()

Returns the connection information.

***Return Value***

The connection information.

---

# Ice-ConnectionInfo

---

## Ice::ConnectionInfo

### Overview

#### local class ConnectionInfo

Base class providing access to the connection details.

#### *Derived Classes and Interfaces*

- [Ice::IPConnectionInfo](#)

#### *Used By*

- [Ice::Connection::getInfo](#)
- [Ice::Instrumentation::CommunicatorObserver::getConnectionObserver](#)
- [Ice::Instrumentation::InvocationObserver::getRemoteObserver](#)

### Data Member Index

[incoming](#) — Whether or not the connection is an incoming or outgoing connection.

[adapterName](#) — The name of the adapter associated with the connection.

[connectionId](#) — The connection id.

### Data Members

**bool incoming;**

Whether or not the connection is an incoming or outgoing connection.

**string adapterName;**

The name of the adapter associated with the connection.

**string connectionId;**

The connection id.

---

## Ice-ConnectionLostException

---

### Ice::ConnectionLostException

#### Overview

local exception `ConnectionLostException` extends `Ice::SocketException`

This exception indicates a lost connection.

---

## Ice-ConnectionNotValidatedException

---

### Ice::ConnectionNotValidatedException

#### Overview

local exception `ConnectionNotValidatedException` extends `Ice::ProtocolException`

This exception is raised if a message is received over a connection that is not yet validated.

---



## Ice-ConnectionRefusedException

---

### Ice::ConnectionRefusedException

#### Overview

local exception `ConnectionRefusedException` extends `Ice::ConnectFailedException`

This exception indicates a connection failure for which the server host actively refuses a connection.

---

## Ice-ConnectionTimeoutException

---

### Ice::ConnectionTimeoutException

#### Overview

local exception `ConnectionTimeoutException` extends [Ice::TimeoutException](#)

This exception indicates that a connection has been shut down because it has been idle for some time.

---

## Ice-ConnectTimeoutException

---

### Ice::ConnectTimeoutException

#### Overview

local exception `ConnectTimeoutException` extends `Ice::TimeoutException`

This exception indicates a connection establishment timeout condition.

---

# Ice-Current

---

## Ice::Current

### Overview

#### local struct Current

Information about the current method invocation for servers. Each operation on the server has a `Current` as its implicit final parameter. `Current` is mostly used for Ice services. Most applications ignore this parameter.

#### Used By

- `Ice::Instrumentation::CommunicatorObserver::getDispatchObserver`
- `Ice::ServantLocator::finished`
- `Ice::ServantLocator::locate`

### Data Member Index

`adapter` — The object adapter.

`con` — Information about the connection over which the current method invocation was received.

`id` — The Ice object identity.

`facet` — The facet.

`operation` — The operation name.

`mode` — The mode of the operation.

`ctx` — The request context, as received from the client.

`requestId` — The request id unless oneway (0) or collocated (-1).

`encoding` — The encoding version used to encode the input and output parameters.

### Data Members

#### **Ice::ObjectAdapter** adapter;

The object adapter.

#### **Ice::Connection** con;

Information about the connection over which the current method invocation was received. If the invocation is direct due to collocation optimization, this value is set to null.

#### **Ice::Identity** id;

The Ice object identity.

#### **string** facet;

The facet.

#### **string** operation;

The operation name.

#### **Ice::OperationMode** mode;

The mode of the operation.

#### **Ice::Context** ctx;

The request context, as received from the client.

**int requestId;**

The request id unless oneway (0) or collocated (-1).

**Ice::EncodingVersion encoding;**

The encoding version used to encode the input and output parameters.

---

## Ice-DatagramLimitException

---

### Ice::DatagramLimitException

#### Overview

local exception `DatagramLimitException` extends `Ice::ProtocolException`

A datagram exceeds the configured size. This exception is raised if a datagram exceeds the configured send or receive buffer size, or exceeds the maximum payload size of a UDP packet (65507 bytes).

---

## Ice-DNSException

---

### Ice::DNSException

#### Overview

#### local exception DNSException

This exception indicates a DNS problem. For details on the cause, [error](#) should be inspected.

#### Data Member Index

[error](#) — The error number describing the DNS problem.

[host](#) — The host name that could not be resolved.

#### Data Members

**int error;**

The error number describing the DNS problem. For C++ and Unix, this is equivalent to `h_errno`. For C++ and Windows, this is the value returned by `WSAGetLastError()`.

**string host;**

The host name that could not be resolved.

---

## Ice-EncapsulationException

---

### Ice::EncapsulationException

#### Overview

local exception EncapsulationException extends [Ice::MarshalException](#)

This exception indicates a malformed data encapsulation.

---



# Ice-EncodingVersion

---

## Ice::EncodingVersion

### Overview

#### struct EncodingVersion

A version structure for the encoding version.

#### *Used By*

- Freeze::Connection::getEncoding
- Ice::Current::encoding
- Ice::OpaqueEndpointInfo::rawEncoding
- Ice::UnsupportedEncodingException::bad
- Ice::UnsupportedEncodingException::supported

### Data Member Index

major  
minor

### Data Members

byte major;

byte minor;

---

# Ice-Endpoint

---

## Ice::Endpoint

### Overview

#### local interface Endpoint

The user-level interface to an endpoint.

#### *Used By*

- [Ice::Connection::getEndpoint](#)
- [Ice::EndpointSeq](#)
- [Ice::Instrumentation::CommunicatorObserver::getConnectionEstablishmentObserver](#)
- [Ice::Instrumentation::CommunicatorObserver::getConnectionObserver](#)
- [Ice::Instrumentation::CommunicatorObserver::getEndpointLookupObserver](#)
- [Ice::Instrumentation::InvocationObserver::getRemoteObserver](#)

### Operation Index

[toString](#) — Return a string representation of the endpoint.

[getInfo](#) — Returns the endpoint information.

### Operations

#### string [toString\(\)](#)

Return a string representation of the endpoint.

#### *Return Value*

The string representation of the endpoint.

#### [Ice::EndpointInfo](#) [getInfo\(\)](#)

Returns the endpoint information.

#### *Return Value*

The endpoint information class.

---

# Ice-EndpointInfo

---

## Ice::EndpointInfo

### Overview

#### local class EndpointInfo

Base class providing access to the endpoint details.

#### Derived Classes and Interfaces

- [Ice::IPEndpointInfo](#)
- [Ice::OpaqueEndpointInfo](#)

#### Used By

- [Ice::Endpoint::getInfo](#)

### Operation Index

[type](#) — Returns the type of the endpoint.

[datagram](#) — Returns true if this endpoint is a datagram endpoint.

[secure](#) — Returns true if this endpoint is a secure endpoint.

### Data Member Index

[timeout](#) — The timeout for the endpoint in milliseconds.

[compress](#) — Specifies whether or not compression should be used if available when using this endpoint.

### Operations

#### short type()

Returns the type of the endpoint.

#### bool datagram()

Returns true if this endpoint is a datagram endpoint.

#### bool secure()

Returns true if this endpoint is a secure endpoint.

### Data Members

#### int timeout;

The timeout for the endpoint in milliseconds. 0 means non-blocking, -1 means no timeout.

#### bool compress;

Specifies whether or not compression should be used if available when using this endpoint.

---

## Ice-EndpointParseException

---

### Ice::EndpointParseException

#### Overview

local exception `EndpointParseException`

This exception is raised if there was an error while parsing an endpoint.

#### Data Member Index

`str` — Describes the failure and includes the string that could not be parsed.

#### Data Members

`string str;`

Describes the failure and includes the string that could not be parsed.

---

## Ice-EndpointSelectionType

---

### Ice::EndpointSelectionType

#### Overview

#### enum EndpointSelectionType

Determines the order in which the Ice run time uses the endpoints in a proxy when establishing a connection.

#### Enumerator Index

**Random** — `Random` causes the endpoints to be arranged in a random order.

**Ordered** — `Ordered` forces the Ice run time to use the endpoints in the order they appeared in the proxy.

#### Enumerators

##### Random

`Random` causes the endpoints to be arranged in a random order.

##### Ordered

`Ordered` forces the Ice run time to use the endpoints in the order they appeared in the proxy.

---

## Ice-EndpointSelectionTypeParseException

---

### Ice::EndpointSelectionTypeParseException

#### Overview

local exception `EndpointSelectionTypeParseException`

This exception is raised if there was an error while parsing an endpoint selection type.

#### Data Member Index

`str` — Describes the failure and includes the string that could not be parsed.

#### Data Members

`string str;`

Describes the failure and includes the string that could not be parsed.

---

## Ice-FacetNotExistException

---

### Ice::FacetNotExistException

#### Overview

local exception `FacetNotExistException` extends `Ice::RequestFailedException`

This exception is raised if no facet with the given name exists, but at least one facet with the given identity exists.

---

## Ice-FeatureNotSupportedException

---

### Ice::FeatureNotSupportedException

#### Overview

local exception `FeatureNotSupportedException`

This exception is raised if an unsupported feature is used. The unsupported feature string contains the name of the unsupported feature

#### Data Member Index

`unsupportedFeature` — The name of the unsupported feature.

#### Data Members

`string unsupportedFeature;`

The name of the unsupported feature.

---



## Ice-FileException

---

### Ice::FileException

#### Overview

local exception `FileException` extends `Ice::SyscallException`

This exception indicates file errors.

#### Data Member Index

`path` — The path of the file responsible for the error.

#### Data Members

`string path;`

The path of the file responsible for the error.

---

## Ice-FixedProxyException

---

### Ice::FixedProxyException

#### Overview

local exception `FixedProxyException`

This exception indicates that an attempt has been made to change the connection properties of a fixed proxy.

---

## Ice-ForcedCloseConnectionException

---

### Ice::ForcedCloseConnectionException

#### Overview

local exception `ForcedCloseConnectionException` extends `Ice::ProtocolException`

This exception is raised by an operation call if the application forcefully closes the connection `Ice::Connection::close`.

#### See Also

- `Ice::Connection::close`
-

# Ice-Identity

---

## Ice::Identity

### Overview

#### struct Identity

The identity of an Ice object. In a proxy, an empty `name` denotes a nil proxy. An identity with an empty `name` and a non-empty `category` is illegal. You cannot add a servant with an empty name to the Active Servant Map.

#### Used By

- Freeze::BackgroundSaveEvictor::keepFacet
- Freeze::BackgroundSaveEvictor::keep
- Freeze::BackgroundSaveEvictor::releaseFacet
- Freeze::BackgroundSaveEvictor::release
- Freeze::Evictor::addFacet
- Freeze::Evictor::add
- Freeze::Evictor::hasFacet
- Freeze::Evictor::hasObject
- Freeze::Evictor::removeFacet
- Freeze::Evictor::remove
- Freeze::EvictorIterator::next
- Freeze::ServantInitializer::initialize
- Ice::Communicator::identityToString
- Ice::Communicator::stringToIdentity
- Ice::Connection::createProxy
- Ice::Current::id
- Ice::IdentitySeq
- Ice::IllegalIdentityException::id
- Ice::Locator::findObjectById
- Ice::ObjectAdapter::addFacet
- Ice::ObjectAdapter::add
- Ice::ObjectAdapter::createDirectProxy
- Ice::ObjectAdapter::createIndirectProxy
- Ice::ObjectAdapter::createProxy
- Ice::ObjectAdapter::findAllFacets
- Ice::ObjectAdapter::findFacet
- Ice::ObjectAdapter::find
- Ice::ObjectAdapter::removeAllFacets
- Ice::ObjectAdapter::removeFacet
- Ice::ObjectAdapter::remove
- Ice::ObjectDict
- Ice::RequestFailedException::id
- IceGrid::Admin::getObjectInfo
- IceGrid::Admin::removeObject
- IceGrid::AdminSession::setObserversByIdentity
- IceGrid::ObjectDescriptor::id
- IceGrid::ObjectExistsException::id
- IceGrid::ObjectNotRegisteredException::id
- IceGrid::ObjectObserver::objectRemoved
- IceGrid::ObserverAlreadyRegisteredException::id
- IceGrid::Query::findObjectById
- IceGrid::Session::allocateObjectById
- IceGrid::Session::releaseObject

**See Also**

- [Ice::ServantLocator](#)
- [Ice::ObjectAdapter::addServantLocator](#)

**Data Member Index**

[name](#) — The name of the Ice object.

[category](#) — The Ice object category.

**Data Members**

**string name;**

The name of the Ice object.

**string category;**

The Ice object category.

---

## Ice-IdentityParseException

---

### Ice::IdentityParseException

#### Overview

#### local exception IdentityParseException

This exception is raised if there was an error while parsing a stringified identity.

#### Data Member Index

`str` — Describes the failure and includes the string that could not be parsed.

#### Data Members

`string str;`

Describes the failure and includes the string that could not be parsed.

---

# Ice-IllegalIdentityException

---

## Ice::IllegalIdentityException

### Overview

local exception `IllegalIdentityException`

This exception is raised if an illegal identity is encountered.

### Data Member Index

`id` — The illegal identity.

### Data Members

**Ice::Identity** `id`;

The illegal identity.

---

## Ice-IllegalMessageSizeException

---

### Ice::IllegalMessageSizeException

#### Overview

local exception `IllegalMessageSizeException` extends `Ice::ProtocolException`

This exception indicates that a message size is less than the minimum required size.

---



# Ice-ImplicitContext

---

## Ice::ImplicitContext

### Overview

#### local interface `ImplicitContext`

An interface to associate implicit contexts with communicators. When you make a remote invocation without an explicit `Ice::Context` parameter, Ice uses the per-proxy `Ice::Context` (if any) combined with the `ImplicitContext` associated with the communicator.

Ice provides several implementations of `ImplicitContext`. The implementation used depends on the value of the `Ice.ImplicitContext` property.

`None` (default) — No implicit context at all.

`PerThread` — The implementation maintains a `Ice::Context` per thread.

`Shared` — The implementation maintains a single `Ice::Context` shared by all threads.

`ImplicitContext` also provides a number of operations to create, update or retrieve an entry in the underlying context without first retrieving a copy of the entire context. These operations correspond to a subset of the `java.util.Map` methods, with `java.lang.Object` replaced by `string` and null replaced by the empty-string.

#### Used By

- `Ice::Communicator::getImplicitContext`

### Operation Index

`getContext` — Get a copy of the underlying context.

`setContext` — Set the underlying context.

`containsKey` — Check if this key has an associated value in the underlying context.

`get` — Get the value associated with the given key in the underlying context.

`put` — Create or update a key/value entry in the underlying context.

`remove` — Remove the entry for the given key in the underlying context.

### Operations

#### `Ice::Context` `getContext()`

Get a copy of the underlying context.

#### Return Value

A copy of the underlying context.

#### `void` `setContext(Ice::Context newContext)`

Set the underlying context.

#### Parameters

`newContext` — The new context.

#### `bool` `containsKey(string key)`

Check if this key has an associated value in the underlying context.

#### Parameters

`key` — The key.

**Return Value**

True if the key has an associated value, False otherwise.

**string get(string key)**

Get the value associated with the given key in the underlying context. Returns an empty string if no value is associated with the key. [containsKey](#) allows you to distinguish between an empty-string value and no value at all.

**Parameters**

`key` — The key.

**Return Value**

The value associated with the key.

**string put(string key, string value)**

Create or update a key/value entry in the underlying context.

**Parameters**

`key` — The key.

`value` — The value.

**Return Value**

The previous value associated with the key, if any.

**string remove(string key)**

Remove the entry for the given key in the underlying context.

**Parameters**

`key` — The key.

**Return Value**

The value associated with the key, if any.

---

## Ice-InitializationException

---

### Ice::InitializationException

#### Overview

local exception InitializationException

This exception is raised when a failure occurs during initialization.

#### Data Member Index

`reason` — The reason for the failure.

#### Data Members

`string reason;`

The reason for the failure.

---

## Ice-InvalidReplicaGroupIdException

---

### Ice::InvalidReplicaGroupIdException

#### Overview

exception InvalidReplicaGroupIdException

This exception is raised if the replica group provided by the server is invalid.

#### *Used By*

- [Ice::LocatorRegistry::setReplicatedAdapterDirectProxy](#)
-

# Ice-IPConnectionInfo

---

## Ice::IPConnectionInfo

### Overview

local class `IPConnectionInfo` extends `Ice::ConnectionInfo`

Provides access to the connection details of an IP connection

#### *Derived Classes and Interfaces*

- `Ice::TCPConnectionInfo`
- `Ice::UDPConnectionInfo`
- `IceSSL::ConnectionInfo`

### Data Member Index

`localAddress` — The local address.

`localPort` — The local port.

`remoteAddress` — The remote address.

`remotePort` — The remote port.

### Data Members

**string localAddress;**

The local address.

**int localPort;**

The local port.

**string remoteAddress;**

The remote address.

**int remotePort;**

The remote port.

---

# Ice-IPEndpointInfo

---

## Ice::IPEndpointInfo

### Overview

local class `IPEndpointInfo` extends `Ice::EndpointInfo`

Provides access to the address details of a IP endpoint.

#### *Derived Classes and Interfaces*

- `Ice::TCPEndpointInfo`
- `Ice::UDPEndpointInfo`
- `IceSSL::EndpointInfo`

#### *See Also*

- `Ice::Endpoint`

### Data Member Index

`host` — The host or address configured with the endpoint.

`port` — The port number.

### Data Members

`string host;`

The host or address configured with the endpoint.

`int port;`

The port number.

---

# Ice-Locator

---

## Ice::Locator

### Overview

#### interface Locator

The Ice locator interface. This interface is used by clients to lookup adapters and objects. It is also used by servers to get the locator registry proxy.

*The `Ice::Locator` interface is intended to be used by Ice internals and by locator implementations. Regular user code should not attempt to use any functionality of this interface directly.*

#### Derived Classes and Interfaces

- [IceGrid::Locator](#)

### Operation Index

[findObjectById](#) — Find an object by identity and return its proxy.

[findAdapterById](#) — Find an adapter by id and return its proxy (a dummy direct proxy created by the adapter).

[getRegistry](#) — Get the locator registry.

### Operations

[ "amd", "nonmutating" ] **Object\*** [findObjectById\(Ice::Identity id\)](#) throws **Ice::ObjectNotFoundException**

Find an object by identity and return its proxy.

#### Parameters

`id` — The identity.

#### Return Value

The proxy, or null if the object is not active.

#### Exceptions

[Ice::ObjectNotFoundException](#) — Raised if the object cannot be found.

[ "amd", "nonmutating" ] **Object\*** [findAdapterById\(string id\)](#) throws **Ice::AdapterNotFoundException**

Find an adapter by id and return its proxy (a dummy direct proxy created by the adapter).

#### Parameters

`id` — The adapter id.

#### Return Value

The adapter proxy, or null if the adapter is not active.

#### Exceptions

[Ice::AdapterNotFoundException](#) — Raised if the adapter cannot be found.

[ "nonmutating" ] **Ice::LocatorRegistry\*** [getRegistry\(\)](#)

Get the locator registry.

***Return Value***

The locator registry.

---



# Ice-LocatorRegistry

---

## Ice::LocatorRegistry

### Overview

#### interface LocatorRegistry

The Ice locator registry interface. This interface is used by servers to register adapter endpoints with the locator.

*The `Ice::LocatorRegistry` interface is intended to be used by Ice internals and by locator implementations. Regular user code should not attempt to use any functionality of this interface directly.*

### Operation Index

`setAdapterDirectProxy` — Set the adapter endpoints with the locator registry.  
`setReplicatedAdapterDirectProxy` — Set the adapter endpoints with the locator registry.  
`setServerProcessProxy` — Set the process proxy for a server.

### Operations

[ "amd" ] void `setAdapterDirectProxy`(string id, Object\* proxy) throws `Ice::AdapterNotFoundException`, `Ice::AdapterAlreadyActiveException`

Set the adapter endpoints with the locator registry.

#### Parameters

`id` — The adapter id.  
`proxy` — The adapter proxy (a dummy direct proxy created by the adapter). The direct proxy contains the adapter endpoints.

#### Exceptions

`Ice::AdapterNotFoundException` — Raised if the adapter cannot be found, or if the locator only allows registered adapters to set their active proxy and the adapter is not registered with the locator.  
`Ice::AdapterAlreadyActiveException` — Raised if an adapter with the same id is already active.

[ "amd" ] void `setReplicatedAdapterDirectProxy`(string adapterId, string replicaGroupId, Object\* p) throws `Ice::AdapterNotFoundException`, `Ice::AdapterAlreadyActiveException`, `Ice::InvalidReplicaGroupIdException`

Set the adapter endpoints with the locator registry.

#### Parameters

`adapterId` — The adapter id.  
`replicaGroupId` — The replica group id.  
`p` — The adapter proxy (a dummy direct proxy created by the adapter). The direct proxy contains the adapter endpoints.

#### Exceptions

`Ice::AdapterNotFoundException` — Raised if the adapter cannot be found, or if the locator only allows registered adapters to set their active proxy and the adapter is not registered with the locator.  
`Ice::AdapterAlreadyActiveException` — Raised if an adapter with the same id is already active.  
`Ice::InvalidReplicaGroupIdException` — Raised if the given replica group doesn't match the one registered with the locator registry for this object adapter.

[ "amd" ] void `setServerProcessProxy`(string id, `Ice::Process*` proxy) throws `Ice::ServerNotFoundException`

Set the process proxy for a server.

**Parameters**

`id` — The server id.

`proxy` — The process proxy.

**Exceptions**

[Ice::ServerNotFoundException](#) — Raised if the server cannot be found.

---

# Ice-Logger

---

## Ice::Logger

### Overview

#### local interface `Logger`

The Ice message logger. Applications can provide their own logger by implementing this interface and installing it in a communicator.

#### *Used By*

- `Ice::Communicator::getLogger`
- `cloneWithPrefix`

### Operation Index

`print` — Print a message.

`trace` — Log a trace message.

`warning` — Log a warning message.

`error` — Log an error message.

`cloneWithPrefix` — Returns a clone of the logger with a new prefix.

### Operations

#### `void print(string message)`

Print a message. The message is printed literally, without any decorations such as executable name or time stamp.

#### `void trace(string category, string message)`

Log a trace message.

#### *Parameters*

`category` — The trace category.

`message` — The trace message to log.

#### `void warning(string message)`

Log a warning message.

#### *Parameters*

`message` — The warning message to log.

#### *See Also*

- `error`

#### `void error(string message)`

Log an error message.

#### *Parameters*

`message` — The error message to log.

#### *See Also*

- `warning`

### **Ice::Logger cloneWithPrefix(string prefix)**

Returns a clone of the logger with a new prefix.

#### ***Parameters***

`prefix` — The new prefix for the logger.

---

# Ice-MarshalException

---

## Ice::MarshalException

### Overview

local exception `MarshalException` extends `Ice::ProtocolException`

This exception is raised for errors during marshaling or unmarshaling data.

#### *Derived Exceptions*

- `Ice::EncapsulationException`
  - `Ice::MemoryLimitException`
  - `Ice::NoObjectFactoryException`
  - `Ice::ProxyUnmarshalException`
  - `Ice::StringConversionException`
  - `Ice::UnexpectedObjectException`
  - `Ice::UnmarshalOutOfBoundsException`
-

## Ice-MemoryLimitException

---

### Ice::MemoryLimitException

#### Overview

local exception `MemoryLimitException` extends `Ice::MarshalException`

This exception is raised if a request size exceeds the limit specified by the `Ice.MessageSizeMax` property.

---

## Ice-NoEndpointException

---

### Ice::NoEndpointException

#### Overview

local exception `NoEndpointException`

This exception is raised if no suitable endpoint is available.

#### Data Member Index

`proxy` — The stringified proxy for which no suitable endpoint is available.

#### Data Members

`string proxy;`

The stringified proxy for which no suitable endpoint is available.

---

## Ice-NoObjectFactoryException

---

### Ice::NoObjectFactoryException

#### Overview

local exception `NoObjectFactoryException` extends `Ice::MarshalException`

This exception is raised if no suitable object factory was found during unmarshaling of a Slice class instance.

#### See Also

- [Ice::ObjectFactory](#)
- [Ice::Communicator::addObjectFactory](#)
- [Ice::Communicator::findObjectFactory](#)

#### Data Member Index

`type` — The Slice type ID of the class instance for which no no factory could be found.

#### Data Members

`string type;`

The Slice type ID of the class instance for which no no factory could be found.

---



# Ice-NotRegisteredException

---

## Ice::NotRegisteredException

### Overview

#### local exception NotRegisteredException

An attempt was made to find or deregister something that is not registered with the Ice run time or Ice locator. This exception is raised if an attempt is made to remove a servant, servant locator, facet, object factory, plug-in, object adapter, object, or user exception factory that is not currently registered. It's also raised if the Ice locator can't find an object or object adapter when resolving an indirect proxy or when an object adapter is activated.

### Data Member Index

**kindOfObject** — The kind of object that could not be removed: "servant", "servant locator", "object factory", "plug-in", "object adapter", "object", or "user exception factory".

**id** — The ID (or name) of the object that could not be removed.

### Data Members

**string kindOfObject;**

The kind of object that could not be removed: "servant", "servant locator", "object factory", "plug-in", "object adapter", "object", or "user exception factory".

**string id;**

The ID (or name) of the object that could not be removed.

---

# Ice-ObjectAdapter

---

## Ice::ObjectAdapter

### Overview

#### local interface ObjectAdapter

The object adapter provides an up-call interface from the Ice run time to the implementation of Ice objects. The object adapter is responsible for receiving requests from endpoints, and for mapping between servants, identities, and proxies.

#### Used By

- [Freeze::ServantInitializer::initialize](#)
- [Ice::Communicator::createObjectAdapterWithEndpoints](#)
- [Ice::Communicator::createObjectAdapterWithRouter](#)
- [Ice::Communicator::createObjectAdapter](#)
- [Ice::Connection::getAdapter](#)
- [Ice::Connection::setAdapter](#)
- [Ice::Current::adapter](#)

#### See Also

- [Ice::Communicator](#)
- [Ice::ServantLocator](#)

### Operation Index

[getName](#) — Get the name of this object adapter.

[getCommunicator](#) — Get the communicator this object adapter belongs to.

[activate](#) — Activate all endpoints that belong to this object adapter.

[hold](#) — Temporarily hold receiving and dispatching requests.

[waitForHold](#) — Wait until the object adapter holds requests.

[deactivate](#) — Deactivate all endpoints that belong to this object adapter.

[waitForDeactivate](#) — Wait until the object adapter has deactivated.

[isDeactivated](#) — Check whether object adapter has been deactivated.

[destroy](#) — Destroys the object adapter and cleans up all resources held by the object adapter.

[add](#) — Add a servant to this object adapter's Active Servant Map.

[addFacet](#) — Like [add](#), but with a facet.

[addWithUUID](#) — Add a servant to this object adapter's Active Servant Map, using an automatically generated UUID as its identity.

[addFacetWithUUID](#) — Like [addWithUUID](#), but with a facet.

[addDefaultServant](#) — Add a default servant to handle requests for a specific category.

[remove](#) — Remove a servant (that is, the default facet) from the object adapter's Active Servant Map.

[removeFacet](#) — Like [remove](#), but with a facet.

[removeAllFacets](#) — Remove all facets with the given identity from the Active Servant Map.

[removeDefaultServant](#) — Remove the default servant for a specific category.

[find](#) — Look up a servant in this object adapter's Active Servant Map by the identity of the Ice object it implements.

[findFacet](#) — Like [find](#), but with a facet.

[findAllFacets](#) — Find all facets with the given identity in the Active Servant Map.

[findByProxy](#) — Look up a servant in this object adapter's Active Servant Map, given a proxy.

[addServantLocator](#) — Add a Servant Locator to this object adapter.

[removeServantLocator](#) — Remove a Servant Locator from this object adapter.

[findServantLocator](#) — Find a Servant Locator installed with this object adapter.

[findDefaultServant](#) — Find the default servant for a specific category.

[createProxy](#) — Create a proxy for the object with the given identity.

[createDirectProxy](#) — Create a direct proxy for the object with the given identity.

[createIndirectProxy](#) — Create an indirect proxy for the object with the given identity.

[setLocator](#) — Set an Ice locator for this object adapter.

[refreshPublishedEndpoints](#) — Refresh the set of published endpoints.

[getEndpoints](#) — Get the set of endpoints configured with this object adapter.

[getPublishedEndpoints](#) — Get the set of endpoints that proxies created by this object adapter will contain.

## Operations

### string getName()

Get the name of this object adapter.

#### **Return Value**

This object adapter's name.

### Ice::Communicator getCommunicator()

Get the communicator this object adapter belongs to.

#### **Return Value**

This object adapter's communicator.

#### **See Also**

- [Ice::Communicator](#)

### void activate()

Activate all endpoints that belong to this object adapter. After activation, the object adapter can dispatch requests received through its endpoints.

#### **See Also**

- [hold](#)
- [deactivate](#)

### void hold()

Temporarily hold receiving and dispatching requests. The object adapter can be reactivated with the [activate](#) operation.

*Holding is not immediate, i.e., after [hold](#) returns, the object adapter might still be active for some time. You can use [waitForHold](#) to wait until holding is complete.*

#### **See Also**

- [activate](#)
- [deactivate](#)
- [waitForHold](#)

### void waitForHold()

Wait until the object adapter holds requests. Calling [hold](#) initiates holding of requests, and [waitForHold](#) only returns when holding of requests has been completed.

#### **See Also**

- [hold](#)
- [waitForDeactivate](#)
- [Ice::Communicator::waitForShutdown](#)

**void deactivate()**

Deactivate all endpoints that belong to this object adapter. After deactivation, the object adapter stops receiving requests through its endpoints. Object adapters that have been deactivated must not be reactivated again, and cannot be used otherwise. Attempts to use a deactivated object adapter raise `Ice::ObjectAdapterDeactivatedException`; however, attempts to `deactivate` an already deactivated object adapter are ignored and do nothing. Once deactivated, it is possible to destroy the adapter to clean up resources and then create and activate a new adapter with the same name.

*After `deactivate` returns, no new requests are processed by the object adapter. However, requests that have been started before `deactivate` was called might still be active. You can use `waitForDeactivate` to wait for the completion of all requests for this object adapter.*

**See Also**

- [activate](#)
- [hold](#)
- [waitForDeactivate](#)
- [Ice::Communicator::shutdown](#)

**void waitForDeactivate()**

Wait until the object adapter has deactivated. Calling `deactivate` initiates object adapter deactivation, and `waitForDeactivate` only returns when deactivation has been completed.

**See Also**

- [deactivate](#)
- [waitForHold](#)
- [Ice::Communicator::waitForShutdown](#)

**bool isDeactivated()**

Check whether object adapter has been deactivated.

**Return Value**

Whether adapter has been deactivated.

**See Also**

- [Ice::Communicator::shutdown](#)

**void destroy()**

Destroys the object adapter and cleans up all resources held by the object adapter. If the object adapter has not yet been deactivated, `destroy` implicitly initiates the deactivation and waits for it to finish. Subsequent calls to `destroy` are ignored. Once `destroy` has returned, it is possible to create another object adapter with the same name.

**See Also**

- [deactivate](#)
- [waitForDeactivate](#)
- [Ice::Communicator::destroy](#)

**Object\* add(Object servant, Ice::Identity id)**

Add a servant to this object adapter's Active Servant Map. Note that one servant can implement several Ice objects by registering the servant with multiple identities. Adding a servant with an identity that is in the map already throws `Ice::AlreadyRegisteredException`.

**Parameters**

`servant` — The servant to add.

`id` — The identity of the Ice object that is implemented by the servant.

**Return Value**

A proxy that matches the given identity and this object adapter.

**See Also**

- [Ice::Identity](#)
- [addFacet](#)
- [addWithUUID](#)
- [remove](#)
- [find](#)

**Object\* addFacet(Object servant, Ice::Identity id, string facet)**

Like [add](#), but with a facet. Calling `add(servant, id)` is equivalent to calling [addFacet](#) with an empty facet.

**Parameters**

`servant` — The servant to add.

`id` — The identity of the Ice object that is implemented by the servant.

`facet` — The facet. An empty facet means the default facet.

**Return Value**

A proxy that matches the given identity, facet, and this object adapter.

**See Also**

- [Ice::Identity](#)
- [add](#)
- [addFacetWithUUID](#)
- [removeFacet](#)
- [findFacet](#)

**Object\* addWithUUID(Object servant)**

Add a servant to this object adapter's Active Servant Map, using an automatically generated UUID as its identity. Note that the generated UUID identity can be accessed using the proxy's `ice_getIdentity` operation.

**Parameters**

`servant` — The servant to add.

**Return Value**

A proxy that matches the generated UUID identity and this object adapter.

**See Also**

- [Ice::Identity](#)
- [add](#)
- [addFacetWithUUID](#)
- [remove](#)
- [find](#)

**Object\* addFacetWithUUID(Object servant, string facet)**

Like [addWithUUID](#), but with a facet. Calling `addWithUUID(servant)` is equivalent to calling [addFacetWithUUID](#) with an empty facet.

**Parameters**

`servant` — The servant to add.

`facet` — The facet. An empty facet means the default facet.

**Return Value**

A proxy that matches the generated UUID identity, facet, and this object adapter.

**See Also**

- [Ice::Identity](#)
- [addFacet](#)
- [addWithUUID](#)
- [removeFacet](#)
- [findFacet](#)

**void addDefaultServant(Object servant, string category)**

Add a default servant to handle requests for a specific category. Adding a default servant for a category for which a default servant is already registered throws [Ice::AlreadyRegisteredException](#). To dispatch operation calls on servants, the object adapter tries to find a servant for a given Ice object identity and facet in the following order:

1. The object adapter tries to find a servant for the identity and facet in the Active Servant Map.
2. If no servant has been found in the Active Servant Map, the object adapter tries to find a default servant for the category component of the identity.
3. If no servant has been found by any of the preceding steps, the object adapter tries to find a default servant for an empty category, regardless of the category contained in the identity.
4. If no servant has been found by any of the preceding steps, the object adapter gives up and the caller receives [Ice::ObjectNotExistException](#) or [Ice::FacetNotExistException](#).

**Parameters**

`servant` — The default servant.

`category` — The category for which the default servant is registered. An empty category means it will handle all categories.

**See Also**

- [removeDefaultServant](#)
- [findDefaultServant](#)

**Object remove(Ice::Identity id)**

Remove a servant (that is, the default facet) from the object adapter's Active Servant Map.

**Parameters**

`id` — The identity of the Ice object that is implemented by the servant. If the servant implements multiple Ice objects, [remove](#) has to be called for all those Ice objects. Removing an identity that is not in the map throws [Ice::NotRegisteredException](#).

**Return Value**

The removed servant.

**See Also**

- [Ice::Identity](#)
- [add](#)
- [addWithUUID](#)

**Object removeFacet(Ice::Identity id, string facet)**

Like `remove`, but with a facet. Calling `remove(id)` is equivalent to calling `removeFacet` with an empty facet.

#### Parameters

`id` — The identity of the Ice object that is implemented by the servant.

`facet` — The facet. An empty facet means the default facet.

#### Return Value

The removed servant.

#### See Also

- [Ice::Identity](#)
- [addFacet](#)
- [addFacetWithUUID](#)

### Ice::FacetMap removeAllFacets(Ice::Identity id)

Remove all facets with the given identity from the Active Servant Map. The operation completely removes the Ice object, including its default facet. Removing an identity that is not in the map throws [Ice::NotRegisteredException](#).

#### Parameters

`id` — The identity of the Ice object to be removed.

#### Return Value

A collection containing all the facet names and servants of the removed Ice object.

#### See Also

- [remove](#)
- [removeFacet](#)

### Object removeDefaultServant(string category)

Remove the default servant for a specific category. Attempting to remove a default servant for a category that is not registered throws [Ice::NotRegisteredException](#).

#### Parameters

`category` — The category of the default servant to remove.

#### Return Value

The default servant.

#### See Also

- [addDefaultServant](#)
- [findDefaultServant](#)

### Object find(Ice::Identity id)

Look up a servant in this object adapter's Active Servant Map by the identity of the Ice object it implements.

*This operation only tries to look up a servant in the Active Servant Map. It does not attempt to find a servant by using any installed [Ice::ServantLocator](#).*

#### Parameters

`id` — The identity of the Ice object for which the servant should be returned.

**Return Value**

The servant that implements the Ice object with the given identity, or null if no such servant has been found.

**See Also**

- [Ice::Identity](#)
- [findFacet](#)
- [findByProxy](#)

**Object findFacet(Ice::Identity id, string facet)**

Like [find](#), but with a facet. Calling `find(id)` is equivalent to calling [findFacet](#) with an empty facet.

**Parameters**

`id` — The identity of the Ice object for which the servant should be returned.

`facet` — The facet. An empty facet means the default facet.

**Return Value**

The servant that implements the Ice object with the given identity and facet, or null if no such servant has been found.

**See Also**

- [Ice::Identity](#)
- [find](#)
- [findByProxy](#)

**Ice::FacetMap findAllFacets(Ice::Identity id)**

Find all facets with the given identity in the Active Servant Map.

**Parameters**

`id` — The identity of the Ice object for which the facets should be returned.

**Return Value**

A collection containing all the facet names and servants that have been found, or an empty map if there is no facet for the given identity.

**See Also**

- [find](#)
- [findFacet](#)

**Object findByProxy(Object\* proxy)**

Look up a servant in this object adapter's Active Servant Map, given a proxy.

*This operation only tries to lookup a servant in the Active Servant Map. It does not attempt to find a servant by using any installed `Ice::ServantLocator`.*

**Parameters**

`proxy` — The proxy for which the servant should be returned.

**Return Value**

The servant that matches the proxy, or null if no such servant has been found.



**See Also**

- [find](#)
- [findFacet](#)

**void addServantLocator(Ice::ServantLocator locator, string category)**

Add a Servant Locator to this object adapter. Adding a servant locator for a category for which a servant locator is already registered throws [Ice::AlreadyRegisteredException](#). To dispatch operation calls on servants, the object adapter tries to find a servant for a given Ice object identity and facet in the following order:

1. The object adapter tries to find a servant for the identity and facet in the Active Servant Map.
2. If no servant has been found in the Active Servant Map, the object adapter tries to find a servant locator for the category component of the identity. If a locator is found, the object adapter tries to find a servant using this locator.
3. If no servant has been found by any of the preceding steps, the object adapter tries to find a locator for an empty category, regardless of the category contained in the identity. If a locator is found, the object adapter tries to find a servant using this locator.
4. If no servant has been found by any of the preceding steps, the object adapter gives up and the caller receives [Ice::ObjectNotExistException](#) or [Ice::FacetNotExistException](#).

*Only one locator for the empty category can be installed.*

**Parameters**

`locator` — The locator to add.

`category` — The category for which the Servant Locator can locate servants, or an empty string if the Servant Locator does not belong to any specific category.

**See Also**

- [Ice::Identity](#)
- [removeServantLocator](#)
- [findServantLocator](#)
- [Ice::ServantLocator](#)

**Ice::ServantLocator removeServantLocator(string category)**

Remove a Servant Locator from this object adapter.

**Parameters**

`category` — The category for which the Servant Locator can locate servants, or an empty string if the Servant Locator does not belong to any specific category.

**Return Value**

The Servant Locator, or throws [Ice::NotRegisteredException](#) if no Servant Locator was found for the given category.

**See Also**

- [Ice::Identity](#)
- [addServantLocator](#)
- [findServantLocator](#)
- [Ice::ServantLocator](#)

**Ice::ServantLocator findServantLocator(string category)**

Find a Servant Locator installed with this object adapter.

**Parameters**

`category` — The category for which the Servant Locator can locate servants, or an empty string if the Servant Locator does not belong to any specific category.

**Return Value**

The Servant Locator, or null if no Servant Locator was found for the given category.

**See Also**

- [Ice::Identity](#)
- [addServantLocator](#)
- [removeServantLocator](#)
- [Ice::ServantLocator](#)

**Object `findDefaultServant(string category)`**

Find the default servant for a specific category.

**Parameters**

`category` — The category of the default servant to find.

**Return Value**

The default servant or null if no default servant was registered for the category.

**See Also**

- [addDefaultServant](#)
- [removeDefaultServant](#)

**Object\* `createProxy(Ice::Identity id)`**

Create a proxy for the object with the given identity. If this object adapter is configured with an adapter id, the return value is an indirect proxy that refers to the adapter id. If a replica group id is also defined, the return value is an indirect proxy that refers to the replica group id. Otherwise, if no adapter id is defined, the return value is a direct proxy containing this object adapter's published endpoints.

**Parameters**

`id` — The object's identity.

**Return Value**

A proxy for the object with the given identity.

**See Also**

- [Ice::Identity](#)

**Object\* `createDirectProxy(Ice::Identity id)`**

Create a direct proxy for the object with the given identity. The returned proxy contains this object adapter's published endpoints.

**Parameters**

`id` — The object's identity.

**Return Value**

A proxy for the object with the given identity.

**See Also**

- [Ice::Identity](#)

### Object\* createIndirectProxy(Ice::Identity id)

Create an indirect proxy for the object with the given identity. If this object adapter is configured with an adapter id, the return value refers to the adapter id. Otherwise, the return value contains only the object identity.

#### Parameters

`id` — The object's identity.

#### Return Value

A proxy for the object with the given identity.

#### See Also

- [Ice::Identity](#)

### void setLocator(Ice::Locator\* loc)

Set an Ice locator for this object adapter. By doing so, the object adapter will register itself with the locator registry when it is activated for the first time. Furthermore, the proxies created by this object adapter will contain the adapter name instead of its endpoints.

#### Parameters

`loc` — The locator used by this object adapter.

#### See Also

- [createDirectProxy](#)
- [Ice::Locator](#)
- [Ice::LocatorRegistry](#)

### void refreshPublishedEndpoints()

Refresh the set of published endpoints. The run time re-reads the `PublishedEndpoints` property if it is set and re-reads the list of local interfaces if the adapter is configured to listen on all endpoints. This operation is useful to refresh the endpoint information that is published in the proxies that are created by an object adapter if the network interfaces used by a host changes.

### Ice::EndpointSeq getEndpoints()

Get the set of endpoints configured with this object adapter.

#### Return Value

The set of endpoints.

#### See Also

- [Ice::Endpoint](#)

### Ice::EndpointSeq getPublishedEndpoints()

Get the set of endpoints that proxies created by this object adapter will contain.

#### Return Value

The set of published endpoints.

#### See Also

- `refreshPublishedEndpoints`
  - `Ice::Endpoint`
-

# Ice-ObjectAdapterDeactivatedException

---

## Ice::ObjectAdapterDeactivatedException

### Overview

local exception `ObjectAdapterDeactivatedException`

This exception is raised if an attempt is made to use a deactivated `Ice::ObjectAdapter`.

### See Also

- `Ice::ObjectAdapter::deactivate`
- `Ice::Communicator::shutdown`

### Data Member Index

`name` — Name of the adapter.

### Data Members

`string name;`

Name of the adapter.

---

## Ice-ObjectAdapterIdInUseException

---

### Ice::ObjectAdapterIdInUseException

#### Overview

local exception `ObjectAdapterIdInUseException`

This exception is raised if an `Ice::ObjectAdapter` cannot be activated. This happens if the `Ice::Locator` detects another active `Ice::ObjectAdapter` with the same adapter id.

#### Data Member Index

`id` — Adapter ID.

#### Data Members

`string id;`

Adapter ID.

---

# Ice-ObjectFactory

---

## Ice::ObjectFactory

### Overview

#### local interface ObjectFactory

A factory for objects. Object factories are used in several places, for example, when receiving "objects by value" and when Freeze restores a persistent object. Object factories must be implemented by the application writer, and registered with the communicator.

#### Used By

- [Ice::Communicator::addObjectFactory](#)
- [Ice::Communicator::findObjectFactory](#)

#### See Also

- [Freeze](#)

### Operation Index

[create](#) — Create a new object for a given object type.

[destroy](#) — Called when the factory is removed from the communicator, or if the communicator is destroyed.

### Operations

#### Object create(string type)

Create a new object for a given object type. The type is the absolute Slice type id, i.e., the id relative to the unnamed top-level Slice module. For example, the absolute Slice type id for interfaces of type `Bar` in the module `Foo` is `::Foo::Bar`.

*The leading "::" is required.*

#### Parameters

`type` — The object type.

#### Return Value

The object created for the given type, or nil if the factory is unable to create the object.

#### void destroy()

Called when the factory is removed from the communicator, or if the communicator is destroyed.

#### See Also

- [Ice::Communicator::destroy](#)
-

## Ice-ObjectNotExistException

---

### Ice::ObjectNotExistException

#### Overview

local exception `ObjectNotExistException` extends `Ice::RequestFailedException`

This exception is raised if an object does not exist on the server, that is, if no facets with the given identity exist.

---



## Ice-ObjectNotFoundException

---

### Ice::ObjectNotFoundException

#### Overview

exception `ObjectNotFoundException`

This exception is raised if an object cannot be found.

#### *Used By*

- `Ice::Locator::findObjectById`
-

# Ice-OpaqueEndpointInfo

---

## Ice::OpaqueEndpointInfo

### Overview

local class `OpaqueEndpointInfo` extends `Ice::EndpointInfo`

Provides access to the details of an opaque endpoint.

#### See Also

- [Ice::Endpoint](#)

### Data Member Index

[rawEncoding](#) — The encoding version of the opaque endpoint (to decode or encode the `rawBytes`).

[rawBytes](#) — The raw encoding of the opaque endpoint.

### Data Members

**Ice::EncodingVersion** `rawEncoding`;

The encoding version of the opaque endpoint (to decode or encode the `rawBytes`).

**Ice::ByteSeq** `rawBytes`;

The raw encoding of the opaque endpoint.

---

# Ice-OperationMode

---

## Ice::OperationMode

### Overview

#### enum OperationMode

The `OperationMode` determines the retry behavior an invocation in case of a (potentially) recoverable error.

#### Used By

- `Current::mode`

### Enumerator Index

**Normal** — Ordinary operations have `Normal` mode.

**Nonmutating** — Operations that use the Slice `nonmutating` keyword must not modify object state.

**Idempotent** — Operations that use the Slice `idempotent` keyword can modify object state, but invoking an operation twice in a row must result in the same object state as invoking it once.

### Enumerators

#### Normal

Ordinary operations have `Normal` mode. These operations modify object state; invoking such an operation twice in a row has different semantics than invoking it once. The Ice run time guarantees that it will not violate at-most-once semantics for `Normal` operations.

#### Nonmutating

Operations that use the Slice `nonmutating` keyword must not modify object state. For C++, nonmutating operations generate `const` member functions in the skeleton. In addition, the Ice run time will attempt to transparently recover from certain run-time errors by re-issuing a failed request and propagate the failure to the application only if the second attempt fails.

*Nonmutating is deprecated; Use the `idempotent` keyword instead. For C++, to retain the mapping of nonmutating operations to C++ `const` member functions, use the `["cpp:const"]` metadata directive.*

#### Idempotent

Operations that use the Slice `idempotent` keyword can modify object state, but invoking an operation twice in a row must result in the same object state as invoking it once. For example, `x = 1` is an idempotent statement, whereas `x += 1` is not. For idempotent operations, the Ice run-time uses the same retry behavior as for nonmutating operations in case of a potentially recoverable error.

---

## Ice-OperationNotExistException

---

### Ice::OperationNotExistException

#### Overview

local exception `OperationNotExistException` extends `Ice::RequestFailedException`

This exception is raised if an operation for a given object does not exist on the server. Typically this is caused by either the client or the server using an outdated Slice specification.

---

# Ice-Plugin

---

## Ice::Plugin

### Overview

#### local interface Plugin

A communicator plug-in. A plug-in generally adds a feature to a communicator, such as support for a protocol. The communicator loads its plug-ins in two stages: the first stage creates the plug-ins, and the second stage invokes [initialize](#) on each one.

#### *Used By*

- [Ice::PluginManager::addPlugin](#)
- [Ice::PluginManager::getPlugin](#)

### Operation Index

[initialize](#) — Perform any necessary initialization steps.

[destroy](#) — Called when the communicator is being destroyed.

### Operations

#### **void initialize()**

Perform any necessary initialization steps.

#### **void destroy()**

Called when the communicator is being destroyed.

---

## Ice-PluginInitializationException

---

### Ice::PluginInitializationException

#### Overview

local exception `PluginInitializationException`

This exception indicates that a failure occurred while initializing a plug-in.

#### Data Member Index

`reason` — The reason for the failure.

#### Data Members

`string reason;`

The reason for the failure.

---

# Ice-PluginManager

---

## Ice::PluginManager

### Overview

#### local interface PluginManager

Each communicator has a plug-in manager to administer the set of plug-ins.

#### Used By

- [Ice::Communicator::getPluginManager](#)

### Operation Index

[initializePlugins](#) — Initialize the configured plug-ins.

[getPlugins](#) — Get a list of plugins installed.

[getPlugin](#) — Obtain a plug-in by name.

[addPlugin](#) — Install a new plug-in.

[destroy](#) — Called when the communicator is being destroyed.

### Operations

#### void initializePlugins()

Initialize the configured plug-ins. The communicator automatically initializes the plug-ins by default, but an application may need to interact directly with a plug-in prior to initialization. In this case, the application must set `Ice.InitPlugins=0` and then invoke [initializePlugins](#) manually. The plug-ins are initialized in the order in which they are loaded. If a plug-in raises an exception during initialization, the communicator invokes `destroy` on the plug-ins that have already been initialized.

#### Exceptions

[Ice::InitializationException](#) — Raised if the plug-ins have already been initialized.

#### Ice::StringSeq getPlugins()

Get a list of plugins installed.

#### Return Value

The names of the plugins installed.

#### See Also

- [getPlugin](#)

#### Ice::Plugin getPlugin(string name)

Obtain a plug-in by name.

#### Parameters

`name` — The plug-in's name.

#### Return Value

The plug-in.

**Exceptions**

[Ice::NotRegisteredException](#) — Raised if no plug-in is found with the given name.

**void addPlugin(string name, [Ice::Plugin pi](#))**

Install a new plug-in.

**Parameters**

`name` — The plug-in's name.

`pi` — The plug-in.

**Exceptions**

[Ice::AlreadyRegisteredException](#) — Raised if a plug-in already exists with the given name.

**void destroy()**

Called when the communicator is being destroyed.

---



# Ice-Process

---

## Ice::Process

### Overview

#### interface Process

An administrative interface for process management. Managed servers must implement this interface.

*A servant implementing this interface is a potential target for denial-of-service attacks, therefore proper security precautions should be taken. For example, the servant can use a UUID to make its identity harder to guess, and be registered in an object adapter with a secured endpoint.*

### Operation Index

[shutdown](#) — Initiate a graceful shut-down.

[writeMessage](#) — Write a message on the process' stdout or stderr.

### Operations

#### void shutdown()

Initiate a graceful shut-down.

#### See Also

- [Ice::Communicator::shutdown](#)

#### void writeMessage(string message, int fd)

Write a message on the process' stdout or stderr.

#### Parameters

`message` — The message.

`fd` — 1 for stdout, 2 for stderr.

---

# Ice-Properties

---

## Ice::Properties

### Overview

#### local interface Properties

A property set used to configure Ice and Ice applications. Properties are key/value pairs, with both keys and values being strings. By convention, property keys should have the form *application-name[.category[.sub-category]].name*.

#### Used By

- [Ice::Communicator::getProperties](#)
- [clone](#)

### Operation Index

[getProperty](#) — Get a property by key.

[getPropertyWithDefault](#) — Get a property by key.

[getPropertyAsInt](#) — Get a property as an integer.

[getPropertyAsIntWithDefault](#) — Get a property as an integer.

[getPropertyAsList](#) — Get a property as a list of strings.

[getPropertyAsListWithDefault](#) — Get a property as a list of strings.

[getPropertiesForPrefix](#) — Get all properties whose keys begins with *prefix*.

[setProperty](#) — Set a property.

[getCommandLineOptions](#) — Get a sequence of command-line options that is equivalent to this property set.

[parseCommandLineOptions](#) — Convert a sequence of command-line options into properties.

[parseIceCommandLineOptions](#) — Convert a sequence of command-line options into properties.

[load](#) — Load properties from a file.

[clone](#) — Create a copy of this property set.

### Operations

#### string getProperty(string key)

Get a property by key. If the property is not set, an empty string is returned.

#### Parameters

*key* — The property key.

#### Return Value

The property value.

#### See Also

- [setProperty](#)

#### string getPropertyWithDefault(string key, string value)

Get a property by key. If the property is not set, the given default value is returned.

#### Parameters

*key* — The property key.

*value* — The default value to use if the property does not exist.

**Return Value**

The property value or the default value.

**See Also**

- [setProperty](#)

**int getPropertyAsInt(string key)**

Get a property as an integer. If the property is not set, 0 is returned.

**Parameters**

`key` — The property key.

**Return Value**

The property value interpreted as an integer.

**See Also**

- [setProperty](#)

**int::getPropertyAsIntWithDefault(string key, int value)**

Get a property as an integer. If the property is not set, the given default value is returned.

**Parameters**

`key` — The property key.

`value` — The default value to use if the property does not exist.

**Return Value**

The property value interpreted as an integer, or the default value.

**See Also**

- [setProperty](#)

**Ice::StringSeq getPropertyAsList(string key)**

Get a property as a list of strings. If the property is not set, an empty list is returned. The strings in the list can contain whitespace if they are enclosed in single or double quotes. If quotes are mismatched, an empty list is returned. Within single quotes or double-quotes, you can escape the quote in question with `\`, e.g. O'Reilly can be written as O'Reilly, "O'Reilly" or 'O'Reilly'.

**Parameters**

`key` — The property key.

**Return Value**

The property value interpreted as a list of strings.

**See Also**

- [setProperty](#)

**Ice::StringSeq getPropertyAsListWithDefault(string key, Ice::StringSeq value)**

Get a property as a list of strings. If the property is not set, the default list is returned. The strings in the list can contain whitespace if they are enclosed in single or double quotes. If quotes are mismatched, the default list is returned. Within single quotes or double-quotes, you can escape the quote in question with `\`, e.g. O'Reilly can be written as O'Reilly, "O'Reilly" or 'O'Reilly'.

#### Parameters

`key` — The property key.

`value` — The default value to use if the property is not set.

#### Return Value

The property value interpreted as list of strings, or the default value.

#### See Also

- [setProperty](#)

### Ice::PropertyDict getPropertiesForPrefix(string prefix)

Get all properties whose keys begins with *prefix*. If *prefix* is an empty string, then all properties are returned.

#### Parameters

`prefix` — The prefix to search for (empty string if none).

#### Return Value

The matching property set.

### void setProperty(string key, string value)

Set a property. To unset a property, set it to the empty string.

#### Parameters

`key` — The property key.

`value` — The property value.

#### See Also

- [getProperty](#)

### Ice::StringSeq getCommandLineOptions()

Get a sequence of command-line options that is equivalent to this property set. Each element of the returned sequence is a command-line option of the form `--key=value`.

#### Return Value

The command line options for this property set.

### Ice::StringSeq parseCommandLineOptions(string prefix, Ice::StringSeq options)

Convert a sequence of command-line options into properties. All options that begin with `--prefix.` are converted into properties. If the prefix is empty, all options that begin with `--` are converted to properties.

#### Parameters

`prefix` — The property prefix, or an empty string to convert all options starting with `--`.

`options` — The command-line options.

***Return Value***

The command-line options that do not start with the specified prefix, in their original order.

**Ice::StringSeq parseIceCommandLineOptions(Ice::StringSeq options)**

Convert a sequence of command-line options into properties. All options that begin with one of the following prefixes are converted into properties: `--Ice`, `--IceBox`, `--IceGrid`, `--IcePatch2`, `--IceSSL`, `--IceStorm`, `--Freeze`, and `--Glacier2`.

***Parameters***

`options` — The command-line options.

***Return Value***

The command-line options that do not start with one of the listed prefixes, in their original order.

**`void load(string file)`**

Load properties from a file.

***Parameters***

`file` — The property file.

**Ice::Properties clone()**

Create a copy of this property set.

***Return Value***

A copy of this property set.

---

# Ice-PropertiesAdmin

---

## Ice::PropertiesAdmin

### Overview

#### interface PropertiesAdmin

The PropertiesAdmin interface provides remote access to the properties of a communicator.

### Operation Index

`getProperty` — Get a property by key.

`getPropertiesForPrefix` — Get all properties whose keys begin with *prefix*.

`setProperty` — Update the communicator's properties with the given property set.

### Operations

#### string getProperty(string key)

Get a property by key. If the property is not set, an empty string is returned.

##### Parameters

`key` — The property key.

##### Return Value

The property value.

#### [ "java:type:java.util.TreeMap<String, String>" ] Ice::PropertyDict getPropertiesForPrefix(string prefix)

Get all properties whose keys begin with *prefix*. If *prefix* is an empty string then all properties are returned.

##### Parameters

`prefix` — The prefix to search for (empty string if none).

##### Return Value

The matching property set.

#### [ "amd" ] void setProperties(Ice::PropertyDict newProperties)

Update the communicator's properties with the given property set.

##### Parameters

`newProperties` — Properties to be added, changed, or removed. If an entry in *newProperties* matches the name of an existing property, that property's value is replaced with the new value. If the new value is an empty string, the property is removed. Any existing properties that are not modified or removed by the entries in *newProperties* are retained with their original values.

---

# Ice-ProtocolException

---

## Ice::ProtocolException

### Overview

#### local exception ProtocolException

A generic exception base for all kinds of protocol error conditions.

#### *Derived Exceptions*

- Ice::BadMagicException
- Ice::CloseConnectionException
- Ice::CompressionException
- Ice::ConnectionNotValidatedException
- Ice::DatagramLimitException
- Ice::ForcedCloseConnectionException
- Ice::IllegalMessageSizeException
- Ice::MarshalException
- Ice::UnknownMessageException
- Ice::UnknownReplyStatusException
- Ice::UnknownRequestIdException
- Ice::UnsupportedEncodingException
- Ice::UnsupportedProtocolException

#### Data Member Index

`reason` — The reason for the failure.

#### Data Members

`string reason;`

The reason for the failure.

---

# Ice-ProtocolVersion

---

## Ice::ProtocolVersion

### Overview

#### struct ProtocolVersion

A version structure for the protocol version.

#### *Used By*

- Ice::UnsupportedProtocolException::bad
- Ice::UnsupportedProtocolException::supported

### Data Member Index

major  
minor

### Data Members

byte major;

byte minor;

---



## Ice-ProxyParseException

---

### Ice::ProxyParseException

#### Overview

local exception `ProxyParseException`

This exception is raised if there was an error while parsing a stringified proxy.

#### Data Member Index

`str` — Describes the failure and includes the string that could not be parsed.

#### Data Members

`string str;`

Describes the failure and includes the string that could not be parsed.

---

## Ice-ProxyUnmarshalException

---

### Ice::ProxyUnmarshalException

#### Overview

local exception `ProxyUnmarshalException` extends `Ice::MarshalException`

This exception is raised if inconsistent data is received while unmarshaling a proxy.

---

# Ice-RequestFailedException

---

## Ice::RequestFailedException

### Overview

#### local exception RequestFailedException

This exception is raised if a request failed. This exception, and all exceptions derived from [Ice::RequestFailedException](#), are transmitted by the Ice protocol, even though they are declared `local`.

#### Derived Exceptions

- [Ice::FacetNotExistException](#)
- [Ice::ObjectNotExistException](#)
- [Ice::OperationNotExistException](#)

### Data Member Index

[id](#) — The identity of the Ice Object to which the request was sent.

[facet](#) — The facet to which the request was sent.

[operation](#) — The operation name of the request.

### Data Members

#### **Ice::Identity** id;

The identity of the Ice Object to which the request was sent.

#### **string** facet;

The facet to which the request was sent.

#### **string** operation;

The operation name of the request.

---

## Ice-ResponseSentException

---

### Ice::ResponseSentException

#### Overview

local exception `ResponseSentException`

Indicates that the response to a request has already been sent; re-dispatching such a request is not possible.

---

# Ice-Router

---

## Ice::Router

### Overview

#### interface Router

The Ice router interface. Routers can be set either globally with `Ice::Communicator::setDefaultRouter`, or with `ice_router` on specific proxies.

#### Derived Classes and Interfaces

- [Glacier2::Router](#)

### Operation Index

`getClientProxy` — Get the router's client proxy, i.e., the proxy to use for forwarding requests from the client to the router.  
`getServerProxy` — Get the router's server proxy, i.e., the proxy to use for forwarding requests from the server to the router.  
`addProxy` — Add new proxy information to the router's routing table. (*Deprecated*)  
`addProxies` — Add new proxy information to the router's routing table.

### Operations

#### [ "nonmutating" ] Object\* getClientProxy()

Get the router's client proxy, i.e., the proxy to use for forwarding requests from the client to the router.

#### Return Value

The router's client proxy.

#### [ "nonmutating" ] Object\* getServerProxy()

Get the router's server proxy, i.e., the proxy to use for forwarding requests from the server to the router.

#### Return Value

The router's server proxy.

#### void addProxy(Object\* proxy)

Add new proxy information to the router's routing table.

*This operation is deprecated, and only used for old Ice clients (older than version 3.1).*

*addProxy() is deprecated, use addProxies() instead.*

#### Parameters

`proxy` — The proxy to add.

#### Ice::ObjectProxySeq addProxies(Ice::ObjectProxySeq proxies)

Add new proxy information to the router's routing table.

#### Parameters

`proxies` — The proxies to add.

***Return Value***

Proxies discarded by the router.

---

## Ice-SecurityException

---

### Ice::SecurityException

#### Overview

local exception `SecurityException`

This exception indicates a failure in a security subsystem, such as the IceSSL plug-in.

#### Data Member Index

`reason` — The reason for the failure.

#### Data Members

`string reason;`

The reason for the failure.

---

# Ice-ServantLocator

---

## Ice::ServantLocator

### Overview

#### local interface ServantLocator

A servant locator is called by an object adapter to locate a servant that is not found in its active servant map.

#### Derived Classes and Interfaces

- [Freeze::Evictor](#)

#### Used By

- [Ice::ObjectAdapter::addServantLocator](#)
- [Ice::ObjectAdapter::findServantLocator](#)
- [Ice::ObjectAdapter::removeServantLocator](#)

#### See Also

- [Ice::ObjectAdapter](#)
- [Ice::ObjectAdapter::addServantLocator](#)
- [Ice::ObjectAdapter::findServantLocator](#)

### Operation Index

`locate` — Called before a request is dispatched if a servant cannot be found in the object adapter's active servant map.

`finished` — Called by the object adapter after a request has been made.

`deactivate` — Called when the object adapter in which this servant locator is installed is deactivated.

### Operations

#### Object `locate(Ice::Current curr, out LocalObject cookie)`

Called before a request is dispatched if a servant cannot be found in the object adapter's active servant map. Note that the object adapter does not automatically insert the returned servant into its active servant map. This must be done by the servant locator implementation, if this is desired. `locate` can throw any user exception. If it does, that exception is marshaled back to the client. If the Slice definition for the corresponding operation includes that user exception, the client receives that user exception; otherwise, the client receives [Ice::UnknownUserException](#). If `locate` throws any exception, the Ice run time does *not* call `finished`.

*If you call `locate` from your own code, you must also call `finished` when you have finished using the servant, provided that `locate` returned a non-null servant; otherwise, you will get undefined behavior if you use servant locators such as the [Freeze::Evictor](#).*

#### Parameters

`curr` — Information about the current operation for which a servant is required.

`cookie` — A "cookie" that will be passed to `finished`.

#### Return Value

The located servant, or null if no suitable servant has been found.

#### See Also

- [Ice::ObjectAdapter](#)
- [Ice::Current](#)
- [finished](#)



**void finished(Ice::Current curr, Object servant, LocalObject cookie)**

Called by the object adapter after a request has been made. This operation is only called if `locate` was called prior to the request and returned a non-null servant. This operation can be used for cleanup purposes after a request. `finished` can throw any user exception. If it does, that exception is marshaled back to the client. If the Slice definition for the corresponding operation includes that user exception, the client receives that user exception; otherwise, the client receives `Ice::UnknownUserException`. If both the operation and `finished` throw an exception, the exception thrown by `finished` is marshaled back to the client.

**Parameters**

`curr` — Information about the current operation call for which a servant was located by `locate`.

`servant` — The servant that was returned by `locate`.

`cookie` — The cookie that was returned by `locate`.

**See Also**

- [Ice::ObjectAdapter](#)
- [Ice::Current](#)
- [locate](#)

**void deactivate(string category)**

Called when the object adapter in which this servant locator is installed is deactivated.

**Parameters**

`category` — Indicates for which category the servant locator is being deactivated.

**See Also**

- [Ice::ObjectAdapter::deactivate](#)
  - [Ice::Communicator::shutdown](#)
  - [Ice::Communicator::destroy](#)
-

## Ice-ServerNotFoundException

---

### Ice::ServerNotFoundException

#### Overview

exception `ServerNotFoundException`

This exception is raised if a server cannot be found.

#### *Used By*

- `Ice::LocatorRegistry::setServerProcessProxy`
-

# Ice-SocketException

---

## Ice::SocketException

### Overview

local exception `SocketException` extends `Ice::SyscallException`

This exception indicates socket errors.

### *Derived Exceptions*

- `Ice::ConnectFailedException`
  - `Ice::ConnectionLostException`
-

# Ice-Stats

---

## Ice::Stats

### Overview

#### local interface Stats

An interface Ice uses to report statistics, such as how much data is sent or received. Applications must provide their own `Ice::Stats` by implementing this interface and installing it in a communicator.

*This local interface is deprecated as of Ice 3.5.*

*Stats is deprecated; you should use instead Ice Metrics or Ice Instrumentation*

#### Used By

- `Ice::Communicator::getStats`

### Operation Index

`bytesSent` — Callback to report that data has been sent.

`bytesReceived` — Callback to report that data has been received.

### Operations

#### `void bytesSent(string protocol, int num)`

Callback to report that data has been sent.

This operation is deprecated.

#### Parameters

`protocol` — The protocol over which data has been sent (for example "tcp", "udp", or "ssl").

`num` — How many bytes have been sent.

#### `void bytesReceived(string protocol, int num)`

Callback to report that data has been received.

This operation is deprecated.

#### Parameters

`protocol` — The protocol over which data has been received (for example "tcp", "udp", or "ssl").

`num` — How many bytes have been received.

---

## Ice-StringConversionException

---

### Ice::StringConversionException

#### Overview

local exception `StringConversionException` extends `Ice::MarshalException`

This exception is raised when a string conversion to or from UTF-8 fails during marshaling or unmarshaling.

---

# Ice-SyscallException

---

## Ice::SyscallException

### Overview

#### local exception SyscallException

This exception is raised if a system error occurred in the server or client process. There are many possible causes for such a system exception. For details on the cause, [error](#) should be inspected.

#### *Derived Exceptions*

- [Ice::FileException](#)
- [Ice::SocketException](#)

### Data Member Index

[error](#) — The error number describing the system exception.

### Data Members

`int error;`

The error number describing the system exception. For C++ and Unix, this is equivalent to `errno`. For C++ and Windows, this is the value returned by `GetLastError()` or `WSAGetLastError()`.

---

## Ice-TCPConnectionInfo

---

### Ice::TCPConnectionInfo

#### Overview

local class TCPConnectionInfo extends [Ice::IPConnectionInfo](#)

Provides access to the connection details of a TCP connection

---

## Ice-TCPEndpointInfo

---

### Ice::TCPEndpointInfo

#### Overview

local class TCPEndpointInfo extends [Ice::IPEndpointInfo](#)

Provides access to a TCP endpoint information.

#### See Also

- [Ice::Endpoint](#)
-



# Ice-TimeoutException

---

## Ice::TimeoutException

### Overview

#### local exception TimeoutException

This exception indicates a timeout condition.

#### *Derived Exceptions*

- [Ice::CloseTimeoutException](#)
  - [Ice::ConnectTimeoutException](#)
  - [Ice::ConnectionTimeoutException](#)
-

## Ice-TwowayOnlyException

---

### Ice::TwowayOnlyException

#### Overview

#### local exception TwowayOnlyException

The operation can only be invoked with a twoway request. This exception is raised if an attempt is made to invoke an operation with `ice_oneway`, `ice_batchOneway`, `ice_datagram`, or `ice_batchDatagram` and the operation has a return value, out-parameters, or an exception specification.

#### Data Member Index

`operation` — The name of the operation that was invoked.

#### Data Members

`string operation;`

The name of the operation that was invoked.

---

## Ice-UDPConnectionInfo

---

### Ice::UDPConnectionInfo

#### Overview

local class `UDPConnectionInfo` extends `Ice::IPConnectionInfo`

Provides access to the connection details of a UDP connection

#### Data Member Index

`mcastAddress` — The multicast address.

`mcastPort` — The multicast port.

#### Data Members

**string mcastAddress;**

The multicast address.

**int mcastPort;**

The multicast port.

---

# Ice-UDPEndpointInfo

---

## Ice::UDPEndpointInfo

### Overview

local class `UDPEndpointInfo` extends `Ice::IPEndpointInfo`

Provides access to an UDP endpoint information.

#### See Also

- [Ice::Endpoint](#)

### Data Member Index

[mcastInterface](#) — The multicast interface.

[mcastTtl](#) — The multicast time-to-live (or hops).

### Data Members

`string mcastInterface;`

The multicast interface.

`int mcastTtl;`

The multicast time-to-live (or hops).

---

# Ice-UnexpectedObjectException

---

## Ice::UnexpectedObjectException

### Overview

Local exception `UnexpectedObjectException` extends `Ice::MarshalException`

This exception is raised if the type of an unmarshaled Slice class instance does not match its expected type. This can happen if client and server are compiled with mismatched Slice definitions or if a class of the wrong type is passed as a parameter or return value using dynamic invocation. This exception can also be raised if `IceStorm` is used to send Slice class instances and an operation is subscribed to the wrong topic.

### Data Member Index

`type` — The Slice type ID of the class instance that was unmarshaled.

`expectedType` — The Slice type ID that was expected by the receiving operation.

### Data Members

`string type;`

The Slice type ID of the class instance that was unmarshaled.

`string expectedType;`

The Slice type ID that was expected by the receiving operation.

---

# Ice-UnknownException

---

## Ice::UnknownException

### Overview

#### local exception UnknownException

This exception is raised if an operation call on a server raises an unknown exception. For example, for C++, this exception is raised if the server throws a C++ exception that is not directly or indirectly derived from `Ice::LocalException` or `Ice::UserException`.

#### *Derived Exceptions*

- [Ice::UnknownLocalException](#)
- [Ice::UnknownUserException](#)

### Data Member Index

`unknown` — This field is set to the textual representation of the unknown exception if available.

### Data Members

`string unknown;`

This field is set to the textual representation of the unknown exception if available.

---

## Ice-UnknownLocalException

---

### Ice::UnknownLocalException

#### Overview

local exception `UnknownLocalException` extends `Ice::UnknownException`

This exception is raised if an operation call on a server raises a local exception. Because local exceptions are not transmitted by the Ice protocol, the client receives all local exceptions raised by the server as `Ice::UnknownLocalException`. The only exception to this rule are all exceptions derived from `Ice::RequestFailedException`, which are transmitted by the Ice protocol even though they are declared `local`.

---

## Ice-UnknownMessageException

---

### Ice::UnknownMessageException

#### Overview

local exception `UnknownMessageException` extends `Ice::ProtocolException`

This exception indicates that an unknown protocol message has been received.

---



## Ice-UnknownReplyStatusException

---

### Ice::UnknownReplyStatusException

#### Overview

local exception `UnknownReplyStatusException` extends `Ice::ProtocolException`

This exception indicates that an unknown reply status has been received.

---

## Ice-UnknownRequestIdException

---

### Ice::UnknownRequestIdException

#### Overview

local exception `UnknownRequestIdException` extends `Ice::ProtocolException`

This exception indicates that a response for an unknown request ID has been received.

---

## Ice-UnknownUserException

---

### Ice::UnknownUserException

#### Overview

local exception `UnknownUserException` extends `Ice::UnknownException`

An operation raised an incorrect user exception. This exception is raised if an operation raises a user exception that is not declared in the exception's `throws` clause. Such undeclared exceptions are not transmitted from the server to the client by the Ice protocol, but instead the client just gets an `Ice::UnknownUserException`. This is necessary in order to not violate the contract established by an operation's signature: Only local exceptions and user exceptions declared in the `throws` clause can be raised.

---

## Ice-UnmarshalOutOfBoundsException

---

### Ice::UnmarshalOutOfBoundsException

#### Overview

local exception `UnmarshalOutOfBoundsException` extends [Ice::MarshalException](#)

This exception is raised if an out-of-bounds condition occurs during unmarshaling.

---

# Ice-UnsupportedEncodingException

---

## Ice::UnsupportedEncodingException

### Overview

local exception `UnsupportedEncodingException` extends `Ice::ProtocolException`

This exception indicates an unsupported data encoding version.

### Data Member Index

`bad` — The version of the unsupported encoding.

`supported` — The version of the encoding that is supported.

### Data Members

`Ice::EncodingVersion bad;`

The version of the unsupported encoding.

`Ice::EncodingVersion supported;`

The version of the encoding that is supported.

---

# Ice-UnsupportedProtocolException

---

## Ice::UnsupportedProtocolException

### Overview

local exception `UnsupportedProtocolException` extends `Ice::ProtocolException`

This exception indicates an unsupported protocol version.

### Data Member Index

`bad` — The version of the unsupported protocol.

`supported` — The version of the protocol that is supported.

### Data Members

`Ice::ProtocolVersion bad;`

The version of the unsupported protocol.

`Ice::ProtocolVersion supported;`

The version of the protocol that is supported.

---

## Ice-VersionMismatchException

---

### Ice::VersionMismatchException

#### Overview

local exception `VersionMismatchException`

This exception is raised if the Ice library version does not match the version in the Ice header files.

---

## Ice-VersionParseException

---

### Ice::VersionParseException

#### Overview

local exception `VersionParseException`

This exception is raised if there was an error while parsing a version.

#### Data Member Index

`str` — Describes the failure and includes the string that could not be parsed.

#### Data Members

`string str;`

Describes the failure and includes the string that could not be parsed.

---



# Ice-Instrumentation

---

## Ice::Instrumentation

### Overview

#### module Instrumentation

The Instrumentation local interfaces enable observing a number of Ice core internal components (threads, connections, etc).

### Interface Index

[CommunicatorObserver](#) — The communicator observer interface used by the Ice run-time to obtain and update observers for its observable objects.

[ConnectionObserver](#) — The connection observer interface to instrument Ice connections.

[DispatchObserver](#) — The dispatch observer to instrument servant dispatch.

[InvocationObserver](#) — The invocation observer to instrument invocations on proxies.

[Observer](#) — The object observer interface used by instrumented objects to notify the observer of their existence.

[ObserverUpdater](#) — The observer updater interface.

[RemoteObserver](#) — The remote invocation observer to instrument invocations that go over the wire.

[ThreadObserver](#) — The thread observer interface to instrument Ice threads.

### Enumeration Index

[ConnectionState](#) — The state of an Ice connection.

[ThreadState](#) — The thread state enumeration keeps track of the different possible states of Ice threads.

---

## Ice-Instrumentation-CommunicatorObserver

---

### Ice::Instrumentation::CommunicatorObserver

#### Overview

#### *local interface CommunicatorObserver*

The communicator observer interface used by the Ice run-time to obtain and update observers for its observable objects. This interface should be implemented by add-ins that wish to observe Ice objects in order to collect statistics. An instance of this interface can be provided to the Ice run-time through the Ice communicator initialization data.

#### Used By

- [Ice::Communicator::getObserver](#)

#### Operation Index

[getConnectionEstablishmentObserver](#) — This method should return an observer for the given endpoint information and connector.

[getEndpointLookupObserver](#) — This method should return an observer for the given endpoint information.

[getConnectionObserver](#) — This method should return a connection observer for the given connection.

[getThreadObserver](#) — This method should return a thread observer for the given thread.

[getInvocationObserver](#) — This method should return an invocation observer for the given invocation.

[getDispatchObserver](#) — This method should return a dispatch observer for the given dispatch.

[setObserverUpdater](#) — The Ice run-time calls this method when the communicator is initialized.

#### Operations

#### ***Ice::Instrumentation::Observer getConnectionEstablishmentObserver(Ice::Endpoint endpt, string connector)***

This method should return an observer for the given endpoint information and connector. The Ice run-time calls this method for each connection establishment attempt.

#### Parameters

`endpt` — The endpoint.

`connector` — The description of the connector. For IP transports, this is typically the IP address to connect to.

#### Return Value

The observer to instrument the connection establishment.

#### ***Ice::Instrumentation::Observer getEndpointLookupObserver(Ice::Endpoint endpt)***

This method should return an observer for the given endpoint information. The Ice run-time calls this method to resolve an endpoint and obtain the list of connectors. For IP endpoints, this typically involves doing a DNS lookup to obtain the IP addresses associated with the DNS name.

#### Parameters

`endpt` — The endpoint.

#### Return Value

The observer to instrument the endpoint lookup.

#### ***Ice::Instrumentation::ConnectionObserver getConnectionObserver(Ice::ConnectionInfo c, Ice::Endpoint e, Ice::Instrumentation::ConnectionStates, Ice::Instrumentation::ConnectionObserver o)***

This method should return a connection observer for the given connection. The Ice run-time calls this method for each new connection and for all the Ice communicator connections when `ObserverUpdater::updateConnections` is called.

#### Parameters

`c` — The connection information.

*e* — The connection endpoint.  
*s* — The state of the connection.  
*o* — The old connection observer if one is already set or a null reference otherwise.  
 Return Value

The connection observer to instrument the connection.

***Ice::Instrumentation::ThreadObserver* getThreadObserver(*string parent, string id, Ice::Instrumentation::ThreadState s, Ice::Instrumentation::ThreadObserver o*)**

This method should return a thread observer for the given thread. The Ice run-time calls this method for each new thread and for all the Ice communicator threads when `ObserverUpdater::updateThreads` is called.

Parameters

*parent* — The parent of the thread.  
*id* — The ID of the thread to observe.  
*s* — The state of the thread.  
*o* — The old thread observer if one is already set or a null reference otherwise.  
 Return Value

The thread observer to instrument the thread.

***Ice::Instrumentation::InvocationObserver* getInvocationObserver(*Object\* prx, string operation, Ice::Context ctx*)**

This method should return an invocation observer for the given invocation. The Ice run-time calls this method for each new invocation on a proxy.

Parameters

*prx* — The proxy used for the invocation.  
*operation* — The name of the invocation.  
*ctx* — The context specified by the user.  
 Return Value

The invocation observer to instrument the invocation.

***Ice::Instrumentation::DispatchObserver* getDispatchObserver(*Ice::Current c, int size*)**

This method should return a dispatch observer for the given dispatch. The Ice run-time calls this method each time it receives an incoming invocation to be dispatched for an Ice object.

Parameters

*c* — The current object as provided to the Ice servant dispatching the invocation.  
*size* — The size of the dispatch.  
 Return Value

The dispatch observer to instrument the dispatch.

***void setObserverUpdater(Ice::Instrumentation::ObserverUpdater updater)***

The Ice run-time calls this method when the communicator is initialized. The add-in implementing this interface can use this object to get the Ice run-time to re-obtain observers for observed objects.

Parameters

*updater* — The observer updater object.

## Ice-Instrumentation-ConnectionObserver

---

### Ice::Instrumentation::ConnectionObserver

#### Overview

*local interface ConnectionObserver extends Ice::Instrumentation::Observer*

The connection observer interface to instrument Ice connections.

Used By

- [Ice::Instrumentation::CommunicatorObserver::getConnectionObserver](#)

#### Operation Index

[sentBytes](#) — Notification of sent bytes over the connection.

[receivedBytes](#) — Notification of received bytes over the connection.

#### Operations

##### ***void sentBytes(int num)***

Notification of sent bytes over the connection.

Parameters

`num` — The number of bytes sent.

##### ***void receivedBytes(int num)***

Notification of received bytes over the connection.

Parameters

`num` — The number of bytes received.

---

## Ice-Instrumentation-ConnectionState

---

### Ice::Instrumentation::ConnectionState

#### Overview

#### *local enum ConnectionState*

The state of an Ice connection.

Used By

- [CommunicatorObserver::getConnectionObserver](#)

#### Enumerator Index

[ConnectionStateValidating](#) — The connection is being validated.

[ConnectionStateHolding](#) — The connection is holding the reception of new messages.

[ConnectionStateActive](#) — The connection is active and can send and receive messages.

[ConnectionStateClosing](#) — The connection is being gracefully shutdown and waits for the peer to close its end of the connection.

[ConnectionStateClosed](#) — The connection is closed and waits for potential dispatch to be finished before being destroyed and detached from the observer.

#### Enumerators

#### ***ConnectionStateValidating***

The connection is being validated.

#### ***ConnectionStateHolding***

The connection is holding the reception of new messages.

#### ***ConnectionStateActive***

The connection is active and can send and receive messages.

#### ***ConnectionStateClosing***

The connection is being gracefully shutdown and waits for the peer to close its end of the connection.

#### ***ConnectionStateClosed***

The connection is closed and waits for potential dispatch to be finished before being destroyed and detached from the observer.

---

## Ice-Instrumentation-DispatchObserver

---

### Ice::Instrumentation::DispatchObserver

#### Overview

*local interface DispatchObserver extends Ice::Instrumentation::Observer*

The dispatch observer to instrument servant dispatch.

Used By

- Ice::Instrumentation::CommunicatorObserver::getDispatchObserver

#### Operation Index

`userException` — Notification of a user exception.

`reply` — Reply notification.

#### Operations

##### ***void userException()***

Notification of a user exception.

##### ***void reply(int size)***

Reply notification.

Parameters

`size` — The size of the reply.

---

## Ice-Instrumentation-InvocationObserver

---

### Ice::Instrumentation::InvocationObserver

#### Overview

#### **local interface InvocationObserver extends Ice::Instrumentation::Observer**

The invocation observer to instrument invocations on proxies. A proxy invocation can either result in a collocated or remote invocation. If it results in a remote invocation, a sub-observer is requested for the remote invocation.

Used By

- [Ice::Instrumentation::CommunicatorObserver::getInvocationObserver](#)

#### Operation Index

[retried](#) — Notification of the invocation being retried.

[userException](#) — Notification of a user exception.

[getRemoteObserver](#) — Get a remote observer for this invocation.

#### Operations

##### **void retried()**

Notification of the invocation being retried.

##### **void userException()**

Notification of a user exception.

##### **Ice::Instrumentation::RemoteObserver getRemoteObserver(Ice::ConnectionInfo con, Ice::Endpoint endpt, int requestId, int size)**

Get a remote observer for this invocation.

Parameters

`con` — The connection information.

`endpt` — The connection endpoint.

`requestId` — The ID of the invocation.

`size` — The size of the invocation.

Return Value

The observer to instrument the remote invocation.

---

## Ice-Instrumentation-Observer

---

### Ice::Instrumentation::Observer

#### Overview

#### *local interface Observer*

The object observer interface used by instrumented objects to notify the observer of their existence.

Derived Classes and Interfaces

- [Ice::Instrumentation::ConnectionObserver](#)
- [Ice::Instrumentation::DispatchObserver](#)
- [Ice::Instrumentation::InvocationObserver](#)
- [Ice::Instrumentation::RemoteObserver](#)
- [Ice::Instrumentation::ThreadObserver](#)

Used By

- [Ice::Instrumentation::CommunicatorObserver::getConnectionEstablishmentObserver](#)
- [Ice::Instrumentation::CommunicatorObserver::getEndpointLookupObserver](#)

#### Operation Index

[attach](#) — This method is called when the instrumented object is created or when the observer is attached to an existing object.

[detach](#) — This method is called when the instrumented object is destroyed and as a result the observer detached from the object.

[failed](#) — Notification of a failure.

#### Operations

##### ***void attach()***

This method is called when the instrumented object is created or when the observer is attached to an existing object.

##### ***void detach()***

This method is called when the instrumented object is destroyed and as a result the observer detached from the object.

##### ***void failed(string exceptionName)***

Notification of a failure.

Parameters

`exceptionName` — The name of the exception.

---



## Ice-Instrumentation-ObserverUpdater

---

### Ice::Instrumentation::ObserverUpdater

#### Overview

#### *local interface ObserverUpdater*

The observer updater interface. This interface is implemented by the Ice run-time and an instance of this interface is provided by the Ice communicator on initialization to the `Ice::Instrumentation::CommunicatorObserver` object set with the communicator initialization data. The Ice communicator calls `Ice::Instrumentation::CommunicatorObserver::setObserverUpdater` to provide the observer updater. This interface can be used by add-ins implementing the `Ice::Instrumentation::CommunicatorObserver` interface to update the observers of connections and threads.

#### Used By

- `Ice::Instrumentation::CommunicatorObserver::setObserverUpdater`

#### Operation Index

`updateConnectionObservers` — Update connection observers associated with each of the Ice connection from the communicator and its object adapters.

`updateThreadObservers` — Update thread observers associated with each of the Ice thread from the communicator and its object adapters.

#### Operations

#### ***void updateConnectionObservers()***

Update connection observers associated with each of the Ice connection from the communicator and its object adapters. When called, this method goes through all the connections and for each connection `Ice::Instrumentation::CommunicatorObserver::getConnectionObserver` is called. The implementation of `getConnectionObserver` has the possibility to return an updated observer if necessary.

#### ***void updateThreadObservers()***

Update thread observers associated with each of the Ice thread from the communicator and its object adapters. When called, this method goes through all the threads and for each thread `Ice::Instrumentation::CommunicatorObserver::getThreadObserver` is called. The implementation of `getThreadObserver` has the possibility to return an updated observer if necessary.

---

## Ice-Instrumentation-RemoteObserver

---

### Ice::Instrumentation::RemoteObserver

#### Overview

**local interface RemoteObserver extends Ice::Instrumentation::Observer**

The remote invocation observer to instrument invocations that go over the wire.

Used By

- Ice::Instrumentation::InvocationObserver::getRemoteObserver

#### Operation Index

[reply](#) — Reply notification.

#### Operations

##### **void reply(int size)**

Reply notification.

Parameters

`size` — The size of the reply.

---

## Ice-Instrumentation-ThreadObserver

---

### Ice::Instrumentation::ThreadObserver

#### Overview

**local interface ThreadObserver extends Ice::Instrumentation::Observer**

The thread observer interface to instrument Ice threads. This can be threads from the Ice thread pool or utility threads used by the Ice core.  
Used By

- [Ice::Instrumentation::CommunicatorObserver::getThreadObserver](#)

#### Operation Index

[stateChanged](#) — Notification of thread state change.

#### Operations

**void stateChanged(Ice::Instrumentation::ThreadState oldState, Ice::Instrumentation::ThreadState newState)**

Notification of thread state change.

Parameters

`oldState` — The previous thread state.

`newState` — The new thread state.

---

## Ice-Instrumentation-ThreadState

---

### Ice::Instrumentation::ThreadState

#### Overview

#### *local enum ThreadState*

The thread state enumeration keeps track of the different possible states of Ice threads.

Used By

- [CommunicatorObserver::getThreadObserver](#)
- [ThreadObserver::stateChanged](#)

#### Enumerator Index

[ThreadStateIdle](#) — The thread is idle.

[ThreadStateInUseForIO](#) — The thread is in use performing reads or writes for Ice connections.

[ThreadStateInUseForUser](#) — The thread is calling user code (servant implementation, AMI callbacks).

[ThreadStateInUseForOther](#) — The thread is performing other internal activities (DNS lookups, timer callbacks, etc).

#### Enumerators

##### ***ThreadStateIdle***

The thread is idle.

##### ***ThreadStateInUseForIO***

The thread is in use performing reads or writes for Ice connections. This state is only for threads from an Ice thread pool.

##### ***ThreadStateInUseForUser***

The thread is calling user code (servant implementation, AMI callbacks). This state is only for threads from an Ice thread pool.

##### ***ThreadStateInUseForOther***

The thread is performing other internal activities (DNS lookups, timer callbacks, etc).

---

# IceGrid Slice API

---

## IceGrid

### Overview

#### module IceGrid

IceGrid is a server activation and deployment tool. IceGrid, simplifies the complex task of deploying applications in a heterogeneous computer network.

### Class Index

[AdaptiveLoadBalancingPolicy](#) — Adaptive load balancing policy.  
[BoxedDistributionDescriptor](#) — A "boxed" distribution descriptor.  
[BoxedString](#) — A "boxed" string.  
[CommunicatorDescriptor](#) — A communicator descriptor.  
[IceBoxDescriptor](#) — An IceBox server descriptor.  
[LoadBalancingPolicy](#) — A base class for load balancing policies.  
[OrderedLoadBalancingPolicy](#) — Ordered load balancing policy.  
[RandomLoadBalancingPolicy](#) — Random load balancing policy.  
[RoundRobinLoadBalancingPolicy](#) — Round robin load balancing policy.  
[ServerDescriptor](#) — An Ice server descriptor.  
[ServiceDescriptor](#) — An IceBox service descriptor.

### Interface Index

[AdapterObserver](#) — This interface allows applications to monitor the state of object adapters that are registered with IceGrid.  
[Admin](#) — The IceGrid administrative interface.  
[AdminSession](#) — Used by administrative clients to view, update, and receive observer updates from the IceGrid registry.  
[ApplicationObserver](#) — The database observer interface.  
[FileIterator](#) — This interface provides access to IceGrid log file contents.  
[FileParser](#) — `icegridadmin` provides a [FileParser](#) object to transform XML files into [ApplicationDescriptor](#) objects.  
[Locator](#) — The IceGrid locator interface provides access to the [Query](#) and [Registry](#) object of the IceGrid registry.  
[NodeObserver](#) — The node observer interface.  
[ObjectObserver](#) — This interface allows applications to monitor IceGrid well-known objects.  
[Query](#) — The IceGrid query interface.  
[Registry](#) — The IceGrid registry allows clients create sessions directly with the registry.  
[RegistryObserver](#) — This interface allows applications to monitor changes the state of the registry.  
[Session](#) — A session object is used by IceGrid clients to allocate and release objects.  
[UserAccountMapper](#) — A user account mapper object is used by IceGrid nodes to map session identifiers to user accounts.

### Exception Index

[AccessDeniedException](#) — This exception is raised if a registry lock wasn't acquired or is already held by a session.  
[AdapterNotExistException](#) — This exception is raised if an adapter does not exist.  
[AllocationException](#) — This exception is raised if the allocation of an object failed.  
[AllocationTimeoutException](#) — This exception is raised if the request to allocate an object times out.  
[ApplicationNotExistException](#) — This exception is raised if an application does not exist.  
[BadSignalException](#) — This exception is raised if an unknown signal was sent to to a server.  
[DeploymentException](#) — An exception for deployment errors.  
[FileNotAvailableException](#) — This exception is raised if a file is not available.  
[NodeNotExistException](#) — This exception is raised if a node does not exist.  
[NodeUnreachableException](#) — This exception is raised if a node could not be reached.

**ObjectExistsException** — This exception is raised if an object already exists.

**ObjectNotRegisteredException** — This exception is raised if an object is not registered.

**ObserverAlreadyRegisteredException** — This exception is raised if an observer is already registered with the registry.

**ParseException** — This exception is raised if an error occurs during parsing.

**PatchException** — This exception is raised if a patch failed.

**PermissionDeniedException** — This exception is raised if a client is denied the ability to create a session with IceGrid.

**RegistryNotExistException** — This exception is raised if a registry does not exist.

**RegistryUnreachableException** — This exception is raised if a registry could not be reached.

**ServerNotExistException** — This exception is raised if a server does not exist.

**ServerStartException** — This exception is raised if a server failed to start.

**ServerStopException** — This exception is raised if a server failed to stop.

**ServerUnreachableException** — This exception is raised if a server could not be reached.

**UserAccountNotFoundException** — This exception is raised if a user account for a given session identifier can't be found.

## Structure Index

**AdapterDescriptor** — An Ice object adapter descriptor.

**AdapterDynamicInfo** — Dynamic information about the state of an adapter.

**AdapterInfo** — Information about an adapter registered with the IceGrid registry.

**ApplicationDescriptor** — An application descriptor.

**ApplicationInfo** — Information about an IceGrid application.

**ApplicationUpdateDescriptor** — An application update descriptor to describe the updates to apply to a deployed application.

**ApplicationUpdateInfo** — Information about updates to an IceGrid application.

**DbEnvDescriptor** — A Freeze database environment descriptor.

**DistributionDescriptor** — A distribution descriptor defines an IcePatch2 server and the directories to retrieve from the patch server.

**LoadInfo** — Information about the load of a node.

**NodeDescriptor** — A node descriptor.

**NodeDynamicInfo** — Dynamic information about the state of a node.

**NodeInfo** — Information about an IceGrid node.

**NodeUpdateDescriptor** — A node update descriptor to describe the updates to apply to a node of a deployed application.

**ObjectDescriptor** — An Ice object descriptor.

**ObjectInfo** — Information about an Ice object.

**PropertyDescriptor** — Property descriptor.

**PropertySetDescriptor** — A property set descriptor.

**RegistryInfo** — Information about an IceGrid registry replica.

**ReplicaGroupDescriptor** — A replica group descriptor.

**ServerDynamicInfo** — Dynamic information about the state of a server.

**ServerInfo** — Information about a server managed by an IceGrid node.

**ServerInstanceDescriptor** — A server template instance descriptor.

**ServiceInstanceDescriptor** — A service template instance descriptor.

**TemplateDescriptor** — A template descriptor for server or service templates.

## Sequence Index

**AdapterDescriptorSeq** — A sequence of adapter descriptors.

**AdapterDynamicInfoSeq** — A sequence of adapter dynamic information structures.

**AdapterInfoSeq** — A sequence of adapter information structures.

**ApplicationDescriptorSeq** — A sequence of application descriptors.

**ApplicationInfoSeq** — A sequence of **ApplicationInfo** structures.

**DbEnvDescriptorSeq** — A sequence of database environment descriptors.

**NodeDynamicInfoSeq** — A sequence of node dynamic information structures.

**NodeUpdateDescriptorSeq** — A sequence of node update descriptors.

**ObjectDescriptorSeq** — A sequence of object descriptors.

**ObjectInfoSeq** — A sequence of object information structures.

**PropertyDescriptorSeq** — A sequence of property descriptors.

**RegistryInfoSeq** — A sequence of **RegistryInfo** structures.

**ReplicaGroupDescriptorSeq** — A sequence of replica groups.

[ServerDescriptorSeq](#) — A sequence of server descriptors.

[ServerDynamicInfoSeq](#) — A sequence of server dynamic information structures.

[ServerInstanceDescriptorSeq](#) — A sequence of server instance descriptors.

[ServiceDescriptorSeq](#) — A sequence of service descriptors.

[ServiceInstanceDescriptorSeq](#) — A sequence of service instance descriptors.

## Dictionary Index

[NodeDescriptorDict](#) — Mapping of node name to node descriptor.

[PropertySetDescriptorDict](#) — A mapping of property set name to property set descriptor.

[StringObjectProxyDict](#) — A dictionary of proxies.

[StringStringDict](#) — A mapping of string to string.

[TemplateDescriptorDict](#) — A mapping of template identifier to template descriptor.

## Enumeration Index

[LoadSample](#) — Determines which load sampling interval to use.

[ServerState](#) — An enumeration representing the state of the server.

## Sequences

[ "java:type:java.util.LinkedList<AdapterDescriptor>" ] [sequence<AdapterDescriptor>](#) [AdapterDescriptorSeq](#)

A sequence of adapter descriptors.

### Used By

- [CommunicatorDescriptor::adapters](#)

[ "java:type:java.util.LinkedList<AdapterDynamicInfo>" ] [sequence<AdapterDynamicInfo>](#) [AdapterDynamicInfoSeq](#)

A sequence of adapter dynamic information structures.

### Used By

- [NodeDynamicInfo::adapters](#)

[sequence<AdapterInfo>](#) [AdapterInfoSeq](#)

A sequence of adapter information structures.

### Used By

- [AdapterObserver::adapterInit](#)
- [Admin::getAdapterInfo](#)

[ "java:type:java.util.LinkedList<ApplicationDescriptor>" ] [sequence<ApplicationDescriptor>](#) [ApplicationDescriptorSeq](#)

A sequence of application descriptors.

[ "java:type:java.util.LinkedList<ApplicationInfo>" ] [sequence<ApplicationInfo>](#) [ApplicationInfoSeq](#)

A sequence of [ApplicationInfo](#) structures.

### Used By

- `ApplicationObserver::applicationInit`

[ "java:type:java.util.LinkedList<DbEnvDescriptor>" ] sequence<**DbEnvDescriptor**> **DbEnvDescriptorSeq**

A sequence of database environment descriptors.

**Used By**

- `CommunicatorDescriptor::dbEnvs`

sequence<**NodeDynamicInfo**> **NodeDynamicInfoSeq**

A sequence of node dynamic information structures.

**Used By**

- `NodeObserver::nodeInit`

[ "java:type:java.util.LinkedList<NodeUpdateDescriptor>" ] sequence<**NodeUpdateDescriptor**> **NodeUpdateDescriptorSeq**

A sequence of node update descriptors.

**Used By**

- `ApplicationUpdateDescriptor::nodes`

[ "java:type:java.util.LinkedList<ObjectDescriptor>" ] sequence<**ObjectDescriptor**> **ObjectDescriptorSeq**

A sequence of object descriptors.

**Used By**

- `AdapterDescriptor::allocatables`
- `AdapterDescriptor::objects`
- `ReplicaGroupDescriptor::objects`

sequence<**ObjectInfo**> **ObjectInfoSeq**

A sequence of object information structures.

**Used By**

- `Admin::getAllObjectInfos`
- `Admin::getObjectInfosByType`
- `ObjectObserver::objectInit`

[ "java:type:java.util.LinkedList<PropertyDescriptor>" ] sequence<**PropertyDescriptor**> **PropertyDescriptorSeq**

A sequence of property descriptors.

**Used By**

- `DbEnvDescriptor::properties`
- `PropertySetDescriptor::properties`



**sequence<RegistryInfo> RegistryInfoSeq**

A sequence of RegistryInfo structures.

**Used By**

- RegistryObserver::registryInit

**[ "java:type:java.util.LinkedList<ReplicaGroupDescriptor>" ] sequence<ReplicaGroupDescriptor> ReplicaGroupDescriptorSeq**

A sequence of replica groups.

**Used By**

- ApplicationDescriptor::replicaGroups
- ApplicationUpdateDescriptor::replicaGroups

**[ "java:type:java.util.LinkedList<ServerDescriptor>" ] sequence<ServerDescriptor> ServerDescriptorSeq**

A sequence of server descriptors.

**Used By**

- NodeDescriptor::servers
- NodeUpdateDescriptor::servers

**[ "java:type:java.util.LinkedList<ServerDynamicInfo>" ] sequence<ServerDynamicInfo> ServerDynamicInfoSeq**

A sequence of server dynamic information structures.

**Used By**

- NodeDynamicInfo::servers

**[ "java:type:java.util.LinkedList<ServerInstanceDescriptor>" ] sequence<ServerInstanceDescriptor> ServerInstanceDescriptorSeq**

A sequence of server instance descriptors.

**Used By**

- NodeDescriptor::serverInstances
- NodeUpdateDescriptor::serverInstances

**[ "java:type:java.util.LinkedList<ServiceDescriptor>" ] sequence<ServiceDescriptor> ServiceDescriptorSeq**

A sequence of service descriptors.

**[ "java:type:java.util.LinkedList<ServiceInstanceDescriptor>" ] sequence<ServiceInstanceDescriptor> ServiceInstanceDescriptorSeq**

A sequence of service instance descriptors.

**Used By**

- IceBoxDescriptor::services

## Dictionaries

### `dictionary<string, NodeDescriptor> NodeDescriptorDict`

Mapping of node name to node descriptor.

#### Used By

- `ApplicationDescriptor::nodes`

### `dictionary<string, PropertySetDescriptor> PropertySetDescriptorDict`

A mapping of property set name to property set descriptor.

#### Used By

- `ApplicationDescriptor::propertySets`
- `ApplicationUpdateDescriptor::propertySets`
- `NodeDescriptor::propertySets`
- `NodeUpdateDescriptor::propertySets`
- `ServerInstanceDescriptor::servicePropertySets`

### `dictionary<string, Object*> StringObjectProxyDict`

A dictionary of proxies.

### `dictionary<string, string> StringStringDict`

A mapping of string to string.

#### Used By

- `ApplicationDescriptor::variables`
- `ApplicationUpdateDescriptor::variables`
- `NodeDescriptor::variables`
- `NodeUpdateDescriptor::variables`
- `ServerInstanceDescriptor::parameterValues`
- `ServiceInstanceDescriptor::parameterValues`
- `TemplateDescriptor::parameterDefaults`

### `dictionary<string, TemplateDescriptor> TemplateDescriptorDict`

A mapping of template identifier to template descriptor.

#### Used By

- `ApplicationDescriptor::serverTemplates`
  - `ApplicationDescriptor::serviceTemplates`
  - `ApplicationUpdateDescriptor::serverTemplates`
  - `ApplicationUpdateDescriptor::serviceTemplates`
-

# IceGrid-AdapterDescriptor

---

## IceGrid::AdapterDescriptor

### Overview

[ "cpp:comparable" ] struct AdapterDescriptor

An Ice object adapter descriptor.

### Used By

- [IceGrid::AdapterDescriptorSeq](#)

### Data Member Index

[name](#) — The object adapter name.

[description](#) — The description of this object adapter.

[id](#) — The object adapter id.

[replicaGroupId](#) — The replica id of this adapter.

[priority](#) — The adapter priority.

[registerProcess](#) — Flag to specify if the object adapter will register a process object.

[serverLifetime](#) — If true the lifetime of this object adapter is the same of the server lifetime.

[objects](#) — The well-known object descriptors associated with this object adapter.

[allocatables](#) — The allocatable object descriptors associated with this object adapter.

### Data Members

**string name;**

The object adapter name.

**string description;**

The description of this object adapter.

**string id;**

The object adapter id.

**string replicaGroupId;**

The replica id of this adapter.

**string priority;**

The adapter priority. This is eventually used when the adapter is member of a replica group to sort the adapter endpoints by priority.

**bool registerProcess;**

Flag to specify if the object adapter will register a process object.

**bool serverLifetime;**

If true the lifetime of this object adapter is the same of the server lifetime. This information is used by the IceGrid node to figure out the server state: the server is active only if all its "server lifetime" adapters are active.

**IceGrid::ObjectDescriptorSeq objects;**

The well-known object descriptors associated with this object adapter.

**IceGrid::ObjectDescriptorSeq** allocatables;

The allocatable object descriptors associated with this object adapter.

---

# IceGrid-AccessDeniedException

---

## IceGrid::AccessDeniedException

### Overview

exception `AccessDeniedException`

This exception is raised if a registry lock wasn't acquired or is already held by a session.

### *Used By*

- `IceGrid::Admin::addApplication`
- `IceGrid::Admin::instantiateServer`
- `IceGrid::Admin::removeApplication`
- `IceGrid::Admin::syncApplicationWithoutRestart`
- `IceGrid::Admin::syncApplication`
- `IceGrid::Admin::updateApplicationWithoutRestart`
- `IceGrid::Admin::updateApplication`
- `IceGrid::AdminSession::finishUpdate`
- `IceGrid::AdminSession::startUpdate`

### Data Member Index

`lockUserId` — The id of the user holding the lock (if any).

### Data Members

`string lockUserId;`

The id of the user holding the lock (if any).

---

## IceGrid-AdapterDynamicInfo

---

### IceGrid::AdapterDynamicInfo

#### Overview

#### **struct AdapterDynamicInfo**

Dynamic information about the state of an adapter.

#### **Used By**

- [IceGrid::AdapterDynamicInfoSeq](#)
- [IceGrid::NodeObserver::updateAdapter](#)

#### **Data Member Index**

[id](#) — The id of the adapter.

[proxy](#) — The direct proxy containing the adapter endpoints.

#### **Data Members**

**string id;**

The id of the adapter.

**Object\* proxy;**

The direct proxy containing the adapter endpoints.

---

# IceGrid-AdapterInfo

---

## IceGrid::AdapterInfo

### Overview

[ "cpp:comparable" ] struct AdapterInfo

Information about an adapter registered with the IceGrid registry.

#### *Used By*

- [IceGrid::AdapterInfoSeq](#)
- [IceGrid::AdapterObserver::adapterAdded](#)
- [IceGrid::AdapterObserver::adapterUpdated](#)

### Data Member Index

[id](#) — The id of the adapter.

[proxy](#) — A dummy direct proxy that contains the adapter endpoints.

[replicaGroupId](#) — The replica group id of the object adapter, or empty if the adapter doesn't belong to a replica group.

### Data Members

**string id;**

The id of the adapter.

**Object\* proxy;**

A dummy direct proxy that contains the adapter endpoints.

**string replicaGroupId;**

The replica group id of the object adapter, or empty if the adapter doesn't belong to a replica group.

---

# IceGrid-AdapterNotExistException

---

## IceGrid::AdapterNotExistException

### Overview

exception AdapterNotExistException

This exception is raised if an adapter does not exist.

### Used By

- [IceGrid::Admin::getAdapterInfo](#)
- [IceGrid::Admin::removeAdapter](#)

### Data Member Index

`id` — The id of the object adapter.

### Data Members

`string id;`

The id of the object adapter.

---



# IceGrid-AdapterObserver

---

## IceGrid::AdapterObserver

### Overview

#### interface AdapterObserver

This interface allows applications to monitor the state of object adapters that are registered with IceGrid.

### Operation Index

`adapterInit` — `adapterInit` is called after registration of an observer to indicate the state of the registry.

`adapterAdded` — The `adapterAdded` operation is called to notify an observer when a dynamically-registered adapter was added.

`adapterUpdated` — The `adapterUpdated` operation is called to notify an observer when a dynamically-registered adapter was updated.

`adapterRemoved` — The `adapterRemoved` operation is called to notify an observer when a dynamically-registered adapter was removed.

### Operations

#### `void adapterInit(IceGrid::AdapterInfoSeq adpts)`

`adapterInit` is called after registration of an observer to indicate the state of the registry.

##### **Parameters**

`adpts` — The adapters that were dynamically registered with the registry (not through the deployment mechanism).

#### `void adapterAdded(IceGrid::AdapterInfo info)`

The `adapterAdded` operation is called to notify an observer when a dynamically-registered adapter was added.

##### **Parameters**

`info` — The details of the new adapter.

#### `void adapterUpdated(IceGrid::AdapterInfo info)`

The `adapterUpdated` operation is called to notify an observer when a dynamically-registered adapter was updated.

##### **Parameters**

`info` — The details of the updated adapter.

#### `void adapterRemoved(string id)`

The `adapterRemoved` operation is called to notify an observer when a dynamically-registered adapter was removed.

##### **Parameters**

`id` — The ID of the removed adapter.

---

## IceGrid-AdaptiveLoadBalancingPolicy

---

### IceGrid::AdaptiveLoadBalancingPolicy

#### Overview

class `AdaptiveLoadBalancingPolicy` extends `IceGrid::LoadBalancingPolicy`

Adaptive load balancing policy.

#### Data Member Index

`loadSample` — The load sample to use for the load balancing.

#### Data Members

`string loadSample;`

The load sample to use for the load balancing. The allowed values for this attribute are "1", "5" and "15", representing respectively the load average over the past minute, the past 5 minutes and the past 15 minutes.

---

# IceGrid-Admin

---

## IceGrid::Admin

### Overview

#### interface Admin

The IceGrid administrative interface.

Allowing access to this interface is a security risk! Please see the IceGrid documentation for further information.

### Operation Index

[addApplication](#) — Add an application to IceGrid.

[syncApplication](#) — Synchronize a deployed application with the given application descriptor.

[updateApplication](#) — Update a deployed application with the given update application descriptor.

[syncApplicationWithoutRestart](#) — Synchronize a deployed application with the given application descriptor.

[updateApplicationWithoutRestart](#) — Update a deployed application with the given update application descriptor only if no server restarts are necessary for the update of the application.

[removeApplication](#) — Remove an application from IceGrid.

[instantiateServer](#) — Instantiate a server template from an application on the given node.

[patchApplication](#) — Patch the given application data.

[getApplicationInfo](#) — Get an application descriptor.

[getDefaultApplicationDescriptor](#) — Get the default application descriptor.

[getAllApplicationNames](#) — Get all the IceGrid applications currently registered.

[getServerInfo](#) — Get the server information for the server with the given id.

[getServerState](#) — Get a server's state.

[getServerPid](#) — Get a server's system process id.

[getServerAdminCategory](#) — Get the category for server admin objects.

[getServerAdmin](#) — Get a proxy to the server's admin object.

[enableServer](#) — Enable or disable a server.

[isServerEnabled](#) — Check if the server is enabled or disabled.

[startServer](#) — Start a server and wait for its activation.

[stopServer](#) — Stop a server.

[patchServer](#) — Patch a server.

[sendSignal](#) — Send signal to a server.

[writeMessage](#) — Write message on server stdout or stderr. (*Deprecated*)

[getAllServerIds](#) — Get all the server ids registered with IceGrid.

[getAdapterInfo](#) — Get the adapter information for the replica group or adapter with the given id.

[removeAdapter](#) — Remove the adapter with the given id.

[getAllAdapterIds](#) — Get all the adapter ids registered with IceGrid.

[addObject](#) — Add an object to the object registry.

[updateObject](#) — Update an object in the object registry.

[addObjectWithType](#) — Add an object to the object registry and explicitly specify its type.

[removeObject](#) — Remove an object from the object registry.

[getObjectInfo](#) — Get the object info for the object with the given identity.

[getObjectInfosByType](#) — Get the object info of all the registered objects with the given type.

[getAllObjectInfos](#) — Get the object info of all the registered objects whose stringified identities match the given expression.

[pingNode](#) — Ping an IceGrid node to see if it is active.

[getNodeLoad](#) — Get the load averages of the node.

[getNodeInfo](#) — Get the node information for the node with the given name.

[getNodeProcessorSocketCount](#) — Get the number of physical processor sockets for the machine running the node with the given name.

[shutdownNode](#) — Shutdown an IceGrid node.

[getNodeHostname](#) — Get the hostname of this node.

[getAllNodeNames](#) — Get all the IceGrid nodes currently registered.

pingRegistry — Ping an IceGrid registry to see if it is active.  
 getRegistryInfo — Get the registry information for the registry with the given name.  
 shutdownRegistry — Shutdown an IceGrid registry.  
 getAllRegistryNames — Get all the IceGrid registries currently registered.  
 shutdown — Shut down the IceGrid registry.  
 getSliceChecksums — Returns the checksums for the IceGrid Slice definitions.

## Operations

**void addApplication(IceGrid::ApplicationDescriptor descriptor) throws IceGrid::AccessDeniedException, IceGrid::DeploymentException**

Add an application to IceGrid.

### Parameters

descriptor — The application descriptor.

### Exceptions

`IceGrid::AccessDeniedException` — Raised if the session doesn't hold the exclusive lock or if another session is holding the lock.  
`IceGrid::DeploymentException` — Raised if application deployment failed.

**void syncApplication(IceGrid::ApplicationDescriptor descriptor) throws IceGrid::AccessDeniedException, IceGrid::DeploymentException, IceGrid::ApplicationNotExistException**

Synchronize a deployed application with the given application descriptor. This operation will replace the current descriptor with this new descriptor.

### Parameters

descriptor — The application descriptor.

### Exceptions

`IceGrid::AccessDeniedException` — Raised if the session doesn't hold the exclusive lock or if another session is holding the lock.  
`IceGrid::DeploymentException` — Raised if application deployment failed.  
`IceGrid::ApplicationNotExistException` — Raised if the application doesn't exist.

**void updateApplication(IceGrid::ApplicationUpdateDescriptor descriptor) throws IceGrid::AccessDeniedException, IceGrid::DeploymentException, IceGrid::ApplicationNotExistException**

Update a deployed application with the given update application descriptor.

### Parameters

descriptor — The update descriptor.

### Exceptions

`IceGrid::AccessDeniedException` — Raised if the session doesn't hold the exclusive lock or if another session is holding the lock.  
`IceGrid::DeploymentException` — Raised if application deployment failed.  
`IceGrid::ApplicationNotExistException` — Raised if the application doesn't exist.

**[ "ami" ] void syncApplicationWithoutRestart(IceGrid::ApplicationDescriptor descriptor) throws IceGrid::AccessDeniedException, IceGrid::DeploymentException, IceGrid::ApplicationNotExistException**

Synchronize a deployed application with the given application descriptor. This operation will replace the current descriptor with this new descriptor only if no server restarts are necessary for the update of the application. If some servers need to be restarted, the synchronization is rejected with a `DeploymentException`.

**Parameters**

`descriptor` — The application descriptor.

**Exceptions**

`IceGrid::AccessDeniedException` — Raised if the session doesn't hold the exclusive lock or if another session is holding the lock.

`IceGrid::DeploymentException` — Raised if application deployment failed.

`IceGrid::ApplicationNotExistException` — Raised if the application doesn't exist.

**[ "ami" ] void updateApplicationWithoutRestart(IceGrid::ApplicationUpdateDescriptor descriptor) throws IceGrid::AccessDeniedException, IceGrid::DeploymentException, IceGrid::ApplicationNotExistException**

Update a deployed application with the given update application descriptor only if no server restarts are necessary for the update of the application. If some servers need to be restarted, the synchronization is rejected with a `DeploymentException`.

**Parameters**

`descriptor` — The update descriptor.

**Exceptions**

`IceGrid::AccessDeniedException` — Raised if the session doesn't hold the exclusive lock or if another session is holding the lock.

`IceGrid::DeploymentException` — Raised if application deployment failed.

`IceGrid::ApplicationNotExistException` — Raised if the application doesn't exist.

**void removeApplication(string name) throws IceGrid::AccessDeniedException, IceGrid::DeploymentException, IceGrid::ApplicationNotExistException**

Remove an application from IceGrid.

**Parameters**

`name` — The application name.

**Exceptions**

`IceGrid::AccessDeniedException` — Raised if the session doesn't hold the exclusive lock or if another session is holding the lock.

`IceGrid::ApplicationNotExistException` — Raised if the application doesn't exist.

**void instantiateServer(string application, string node, IceGrid::ServerInstanceDescriptor desc) throws IceGrid::AccessDeniedException, IceGrid::ApplicationNotExistException, IceGrid::DeploymentException**

Instantiate a server template from an application on the given node.

**Parameters**

`application` — The application name.

`node` — The name of the node where the server will be deployed.

`desc` — The descriptor of the server instance to deploy.

**Exceptions**

`IceGrid::AccessDeniedException` — Raised if the session doesn't hold the exclusive lock or if another session is holding the lock.

`IceGrid::DeploymentException` — Raised if server instantiation failed.

`IceGrid::ApplicationNotExistException` — Raised if the application doesn't exist.

**[ "amd" ] void patchApplication(string name, bool shutdown) throws IceGrid::ApplicationNotExistException, IceGrid::PatchException**

Patch the given application data.

**Parameters**

`name` — The application name.

`shutdown` — If true, the servers depending on the data to patch will be shut down if necessary.

**Exceptions**

`IceGrid::ApplicationNotExistException` — Raised if the application doesn't exist.

`IceGrid::PatchException` — Raised if the patch failed.

[ "nonmutating" ] **IceGrid::ApplicationInfo** `getApplicationInfo(string name)` throws **IceGrid::ApplicationNotExistException**

Get an application descriptor.

**Parameters**

`name` — The application name.

**Return Value**

The application descriptor.

**Exceptions**

`IceGrid::ApplicationNotExistException` — Raised if the application doesn't exist.

[ "nonmutating" ] **IceGrid::ApplicationDescriptor** `getDefaultApplicationDescriptor()` throws **IceGrid::DeploymentException**

Get the default application descriptor.

**Exceptions**

`IceGrid::DeploymentException` — Raised if the default application descriptor can't be accessed or is invalid.

[ "nonmutating" ] **Ice::StringSeq** `getAllApplicationNames()`

Get all the IceGrid applications currently registered.

**Return Value**

The application names.

[ "nonmutating" ] **IceGrid::ServerInfo** `getServerInfo(string id)` throws **IceGrid::ServerNotExistException**

Get the server information for the server with the given id.

**Parameters**

`id` — The server id.

**Return Value**

The server information.

**Exceptions**

`IceGrid::ServerNotExistException` — Raised if the server doesn't exist.

[ "nonmutating" ] **IceGrid::ServerState** `getServerState(string id)` throws **IceGrid::ServerNotExistException**, **IceGrid::NodeUnreachableException**, **IceGrid::DeploymentException**

Get a server's state.

**Parameters**

id — The server id.

**Return Value**

The server state.

**Exceptions**

[IceGrid::ServerNotExistException](#) — Raised if the server doesn't exist.

[IceGrid::NodeUnreachableException](#) — Raised if the node could not be reached.

[IceGrid::DeploymentException](#) — Raised if the server couldn't be deployed on the node.

**[ "nonmutating" ] int getServerPid(string id) throws [IceGrid::ServerNotExistException](#), [IceGrid::NodeUnreachableException](#), [IceGrid::DeploymentException](#)**

Get a server's system process id. The process id is operating system dependent.

**Parameters**

id — The server id.

**Return Value**

The server's process id.

**Exceptions**

[IceGrid::ServerNotExistException](#) — Raised if the server doesn't exist.

[IceGrid::NodeUnreachableException](#) — Raised if the node could not be reached.

[IceGrid::DeploymentException](#) — Raised if the server couldn't be deployed on the node.

**string getServerAdminCategory()**

Get the category for server admin objects. You can manufacture a server admin proxy from the admin proxy by changing its identity: use the server ID as name and the returned category as category.

**Return Value**

The category for server admin objects.

**Object\* getServerAdmin(string id) throws [IceGrid::ServerNotExistException](#), [IceGrid::NodeUnreachableException](#), [IceGrid::DeploymentException](#)**

Get a proxy to the server's admin object.

**Parameters**

id — The server id.

**Return Value**

A proxy to the server's admin object

**Exceptions**

[IceGrid::ServerNotExistException](#) — Raised if the server doesn't exist.

[IceGrid::NodeUnreachableException](#) — Raised if the node could not be reached.

`IceGrid::DeploymentException` — Raised if the server couldn't be deployed on the node.

**`void enableServer(string id, bool enabled) throws IceGrid::ServerNotExistException, IceGrid::NodeUnreachableException, IceGrid::DeploymentException`**

Enable or disable a server. A disabled server can't be started on demand or administratively. The enable state of the server is not persistent: if the node is shut down and restarted, the server will be enabled by default.

**Parameters**

`id` — The server id.

`enabled` — True to enable the server, false to disable it.

**Exceptions**

`IceGrid::ServerNotExistException` — Raised if the server doesn't exist.

`IceGrid::NodeUnreachableException` — Raised if the node could not be reached.

`IceGrid::DeploymentException` — Raised if the server couldn't be deployed on the node.

**`[ "nonmutating" ] bool isServerEnabled(string id) throws IceGrid::ServerNotExistException, IceGrid::NodeUnreachableException, IceGrid::DeploymentException`**

Check if the server is enabled or disabled.

**Parameters**

`id` — The server id.

**Exceptions**

`IceGrid::ServerNotExistException` — Raised if the server doesn't exist.

`IceGrid::NodeUnreachableException` — Raised if the node could not be reached.

`IceGrid::DeploymentException` — Raised if the server couldn't be deployed on the node.

**`[ "amd" ] void startServer(string id) throws IceGrid::ServerNotExistException, IceGrid::ServerStartException, IceGrid::NodeUnreachableException, IceGrid::DeploymentException`**

Start a server and wait for its activation.

**Parameters**

`id` — The server id.

**Exceptions**

`IceGrid::ServerNotExistException` — Raised if the server doesn't exist.

`IceGrid::ServerStartException` — Raised if the server couldn't be started.

`IceGrid::NodeUnreachableException` — Raised if the node could not be reached.

`IceGrid::DeploymentException` — Raised if the server couldn't be deployed on the node.

**`[ "amd" ] void stopServer(string id) throws IceGrid::ServerNotExistException, IceGrid::ServerStopException, IceGrid::NodeUnreachableException, IceGrid::DeploymentException`**

Stop a server.

**Parameters**

`id` — The server id.

**Exceptions**



`IceGrid::ServerNotExistException` — Raised if the server doesn't exist.

`IceGrid::ServerStopException` — Raised if the server couldn't be stopped.

`IceGrid::NodeUnreachableException` — Raised if the node could not be reached.

`IceGrid::DeploymentException` — Raised if the server couldn't be deployed on the node.

[ "amd" ] **void patchServer(string id, bool shutdown) throws `IceGrid::ServerNotExistException`, `IceGrid::NodeUnreachableException`, `IceGrid::DeploymentException`, `IceGrid::PatchException`**

Patch a server.

#### Parameters

`id` — The server id.

`shutdown` — If true, servers depending on the data to patch will be shut down if necessary.

#### Exceptions

`IceGrid::ServerNotExistException` — Raised if the server doesn't exist.

`IceGrid::NodeUnreachableException` — Raised if the node could not be reached.

`IceGrid::DeploymentException` — Raised if the server couldn't be deployed on the node.

`IceGrid::PatchException` — Raised if the patch failed.

**void sendSignal(string id, string signal) throws `IceGrid::ServerNotExistException`, `IceGrid::NodeUnreachableException`, `IceGrid::DeploymentException`, `IceGrid::BadSignalException`**

Send signal to a server.

#### Parameters

`id` — The server id.

`signal` — The signal, for example SIGTERM or 15.

#### Exceptions

`IceGrid::ServerNotExistException` — Raised if the server doesn't exist.

`IceGrid::NodeUnreachableException` — Raised if the node could not be reached.

`IceGrid::DeploymentException` — Raised if the server couldn't be deployed on the node.

`IceGrid::BadSignalException` — Raised if the signal is not recognized by the target server.

**void writeMessage(string id, string message, int fd) throws `IceGrid::ServerNotExistException`, `IceGrid::NodeUnreachableException`, `IceGrid::DeploymentException`**

Write message on server stdout or stderr.

*This operation is deprecated as of version 3.3.*

*writeMessage is deprecated, use instead the Process facet of the server Admin object.*

#### Parameters

`id` — The server id.

`message` — The message.

`fd` — 1 for stdout, 2 for stderr.

#### Exceptions

`IceGrid::ServerNotExistException` — Raised if the server doesn't exist.

`IceGrid::NodeUnreachableException` — Raised if the node could not be reached.

`IceGrid::DeploymentException` — Raised if the server couldn't be deployed on the node.

[ "nonmutating" ] **Ice::StringSeq getAllServerIds()**

Get all the server ids registered with IceGrid.

**Return Value**

The server ids.

[ "nonmutating" ] **IceGrid::AdapterInfoSeq getAdapterInfo(string id) throws IceGrid::AdapterNotExistException**

Get the adapter information for the replica group or adapter with the given id.

**Parameters**

id — The adapter id.

**Return Value**

A sequence of adapter information structures. If the given id refers to an adapter, this sequence will contain only one element. If the given id refers to a replica group, the sequence will contain the adapter information of each member of the replica group.

**Exceptions**

[IceGrid::AdapterNotExistException](#) — Raised if the adapter or replica group doesn't exist.

**void removeAdapter(string id) throws IceGrid::AdapterNotExistException, IceGrid::DeploymentException**

Remove the adapter with the given id.

**Parameters**

id — The adapter id.

**Exceptions**

[IceGrid::AdapterNotExistException](#) — Raised if the adapter doesn't exist.

[ "nonmutating" ] **Ice::StringSeq getAllAdapterIds()**

Get all the adapter ids registered with IceGrid.

**Return Value**

The adapter ids.

**void addObject(Object\* obj) throws IceGrid::ObjectExistsException, IceGrid::DeploymentException**

Add an object to the object registry. IceGrid will get the object type by calling `ice_id` on the given proxy. The object must be reachable.

**Parameters**

obj — The object to be added to the registry.

**Exceptions**

[IceGrid::ObjectExistsException](#) — Raised if the object is already registered.

[IceGrid::DeploymentException](#) — Raised if the object can't be added. This might be raised if the invocation on the proxy to get the object type failed.

**void updateObject(Object\* obj) throws IceGrid::ObjectNotRegisteredException, IceGrid::DeploymentException**

Update an object in the object registry. Only objects added with this interface can be updated with this operation. Objects added with deployment descriptors should be updated with the deployment mechanism.

**Parameters**

`obj` — The object to be updated to the registry.

**Exceptions**

`IceGrid::ObjectNotRegisteredException` — Raised if the object isn't registered with the registry.

`IceGrid::DeploymentException` — Raised if the object can't be updated. This might happen if the object was added with a deployment descriptor.

**`void addObjectWithType(Object* obj, string type) throws IceGrid::ObjectExistsException, IceGrid::DeploymentException`**

Add an object to the object registry and explicitly specify its type.

**Parameters**

`obj` — The object to be added to the registry.

`type` — The object type.

**Exceptions**

`IceGrid::ObjectExistsException` — Raised if the object is already registered.

**`void removeObject(Ice::Identity id) throws IceGrid::ObjectNotRegisteredException, IceGrid::DeploymentException`**

Remove an object from the object registry. Only objects added with this interface can be removed with this operation. Objects added with deployment descriptors should be removed with the deployment mechanism.

**Parameters**

`id` — The identity of the object to be removed from the registry.

**Exceptions**

`IceGrid::ObjectNotRegisteredException` — Raised if the object isn't registered with the registry.

`IceGrid::DeploymentException` — Raised if the object can't be removed. This might happen if the object was added with a deployment descriptor.

**[ "nonmutating" ] `IceGrid::ObjectInfo getObjectInfo(Ice::Identity id) throws IceGrid::ObjectNotRegisteredException`**

Get the object info for the object with the given identity.

**Parameters**

`id` — The identity of the object.

**Return Value**

The object info.

**Exceptions**

`IceGrid::ObjectNotRegisteredException` — Raised if the object isn't registered with the registry.

**[ "nonmutating" ] `IceGrid::ObjectInfoSeq getObjectInfosByType(string type)`**

Get the object info of all the registered objects with the given type.

**Parameters**

`type` — The type of the object.

**Return Value**

The object infos.

[ "nonmutating" ] **IceGrid::ObjectInfoSeq getAllObjectInfos(string expr)**

Get the object info of all the registered objects whose stringified identities match the given expression.

**Parameters**

`expr` — The expression to match against the stringified identities of registered objects. The expression may contain a trailing wildcard (\*) character.

**Return Value**

All the object infos with a stringified identity matching the given expression.

[ "nonmutating" ] **bool pingNode(string name) throws IceGrid::NodeNotExistException**

Ping an IceGrid node to see if it is active.

**Parameters**

`name` — The node name.

**Return Value**

true if the node ping succeeded, false otherwise.

**Exceptions**

[IceGrid::NodeNotExistException](#) — Raised if the node doesn't exist.

[ "nonmutating" ] **IceGrid::LoadInfo getNodeLoad(string name) throws IceGrid::NodeNotExistException, IceGrid::NodeUnreachableException**

Get the load averages of the node.

**Parameters**

`name` — The node name.

**Return Value**

The node load information.

**Exceptions**

[IceGrid::NodeNotExistException](#) — Raised if the node doesn't exist.

[IceGrid::NodeUnreachableException](#) — Raised if the node could not be reached.

[ "nonmutating" ] **IceGrid::NodeInfo getNodeInfo(string name) throws IceGrid::NodeNotExistException, IceGrid::NodeUnreachableException**

Get the node information for the node with the given name.

**Parameters**

`name` — The node name.

**Return Value**

The node information.

**Exceptions**

[IceGrid::NodeNotExistException](#) — Raised if the node doesn't exist.

[IceGrid::NodeUnreachableException](#) — Raised if the node could not be reached.

**[ "nonmutating" ] int getNodeProcessorSocketCount(string name) throws IceGrid::NodeNotExistException, IceGrid::NodeUnreachableException**

Get the number of physical processor sockets for the machine running the node with the given name. Note that this method will return 1 on operating systems where this can't be automatically determined and where the `IceGrid.Node.ProcessorSocketCount` property for the node is not set.

**Parameters**

name — The node name.

**Return Value**

The number of processor sockets or 1 if the number of sockets can't be determined.

**Exceptions**

[IceGrid::NodeNotExistException](#) — Raised if the node doesn't exist.

[IceGrid::NodeUnreachableException](#) — Raised if the node could not be reached.

**void shutdownNode(string name) throws IceGrid::NodeNotExistException, IceGrid::NodeUnreachableException**

Shutdown an IceGrid node.

**Parameters**

name — The node name.

**Exceptions**

[IceGrid::NodeNotExistException](#) — Raised if the node doesn't exist.

[IceGrid::NodeUnreachableException](#) — Raised if the node could not be reached.

**[ "nonmutating" ] string getNodeHostname(string name) throws IceGrid::NodeNotExistException, IceGrid::NodeUnreachableException**

Get the hostname of this node.

**Parameters**

name — The node name.

**Return Value**

The node hostname.

**Exceptions**

[IceGrid::NodeNotExistException](#) — Raised if the node doesn't exist.

[IceGrid::NodeUnreachableException](#) — Raised if the node could not be reached.

**[ "nonmutating" ] Ice::StringSeq getAllNodeNames()**

Get all the IceGrid nodes currently registered.

**Return Value**

The node names.

**bool pingRegistry(string name) throws IceGrid::RegistryNotExistException**

Ping an IceGrid registry to see if it is active.

**Parameters**

name — The registry name.

**Return Value**

true if the registry ping succeeded, false otherwise.

**Exceptions**

[IceGrid::RegistryNotExistException](#) — Raised if the registry doesn't exist.

**IceGrid::RegistryInfo getRegistryInfo(string name) throws IceGrid::RegistryNotExistException, IceGrid::RegistryUnreachableException**

Get the registry information for the registry with the given name.

**Parameters**

name — The registry name.

**Return Value**

The registry information.

**Exceptions**

[IceGrid::RegistryNotExistException](#) — Raised if the registry doesn't exist.

[IceGrid::RegistryUnreachableException](#) — Raised if the registry could not be reached.

**void shutdownRegistry(string name) throws IceGrid::RegistryNotExistException, IceGrid::RegistryUnreachableException**

Shutdown an IceGrid registry.

**Parameters**

name — The registry name.

**Exceptions**

[IceGrid::RegistryNotExistException](#) — Raised if the registry doesn't exist.

[IceGrid::RegistryUnreachableException](#) — Raised if the registry could not be reached.

**Ice::StringSeq getAllRegistryNames()**

Get all the IceGrid registries currently registered.

**Return Value**

The registry names.

**void shutdown()**

Shut down the IceGrid registry.

**[ "nonmutating" ] Ice::SliceChecksumDict getSliceChecksums()**

Returns the checksums for the IceGrid Slice definitions.

***Return Value***

A dictionary mapping Slice type ids to their checksums.

---

# IceGrid-AdminSession

---

## IceGrid::AdminSession

### Overview

interface `AdminSession` extends `Glacier2::Session`

Used by administrative clients to view, update, and receive observer updates from the IceGrid registry. Admin sessions are created either with the `IceGrid::Registry` object or the registry admin `Glacier2::SessionManager` object.

#### See Also

- `IceGrid::Registry`
- `Glacier2::SessionManager`

### Operation Index

`keepAlive` — Keep the session alive.

`getAdmin` — Get the admin interface.

`getAdminCallbackTemplate` — Get a "template" proxy for admin callback objects.

`setObservers` — Set the observer proxies that receive notifications when the state of the registry or nodes changes.

`setObserversByIdentity` — Set the observer identities that receive notifications the state of the registry or nodes changes.

`startUpdate` — Acquires an exclusive lock to start updating the registry applications.

`finishUpdate` — Finish updating the registry and release the exclusive lock.

`getReplicaName` — Get the name of the registry replica hosting this session.

`openServerLog` — Open the given server log file for reading.

`openServerStdErr` — Open the given server stderr file for reading.

`openServerStdOut` — Open the given server stdout file for reading.

`openNodeStdErr` — Open the given node stderr file for reading.

`openNodeStdOut` — Open the given node stdout file for reading.

`openRegistryStdErr` — Open the given registry stderr file for reading.

`openRegistryStdOut` — Open the given registry stdout file for reading.

### Operations

#### `void keepAlive()`

Keep the session alive. Clients should call this operation regularly to prevent the server from reaping the session.

#### See Also

- `IceGrid::Registry::getSessionTimeout`

#### [ "nonmutating" ] `IceGrid::Admin*` `getAdmin()`

Get the admin interface. The admin object returned by this operation can only be accessed by the session.

#### **Return Value**

The admin interface proxy.

#### `Object*` `getAdminCallbackTemplate()`

Get a "template" proxy for admin callback objects. An Admin client uses this proxy to set the category of its callback objects, and the published endpoints of the object adapter hosting the admin callback objects.

#### **Return Value**



A template proxy. The returned proxy is null when the Admin session was established using Glacier2.

**void setObservers(IceGrid::RegistryObserver\* registryObs, IceGrid::NodeObserver\* nodeObs, IceGrid::ApplicationObserver\* appObs, IceGrid::AdapterObserver\* adptObs, IceGrid::ObjectObserver\* objObs) throws IceGrid::ObserverAlreadyRegisteredException**

Set the observer proxies that receive notifications when the state of the registry or nodes changes.

**Parameters**

registryObs — The registry observer.  
 nodeObs — The node observer.  
 appObs — The application observer.  
 adptObs — The adapter observer.  
 objObs — The object observer.

**Exceptions**

[IceGrid::ObserverAlreadyRegisteredException](#) — Raised if an observer is already registered with this registry.

**void setObserversByIdentity(Ice::Identity registryObs, Ice::Identity nodeObs, Ice::Identity appObs, Ice::Identity adptObs, Ice::Identity objObs) throws IceGrid::ObserverAlreadyRegisteredException**

Set the observer identities that receive notifications the state of the registry or nodes changes. This operation should be used by clients that are using a bidirectional connection to communicate with the session.

**Parameters**

registryObs — The registry observer identity.  
 nodeObs — The node observer identity.  
 appObs — The application observer.  
 adptObs — The adapter observer.  
 objObs — The object observer.

**Exceptions**

[IceGrid::ObserverAlreadyRegisteredException](#) — Raised if an observer is already registered with this registry.

**int startUpdate() throws IceGrid::AccessDeniedException**

Acquires an exclusive lock to start updating the registry applications.

**Return Value**

The current serial.

**Exceptions**

[IceGrid::AccessDeniedException](#) — Raised if the exclusive lock can't be acquired. This might happen if the lock is currently acquired by another session.

**void finishUpdate() throws IceGrid::AccessDeniedException**

Finish updating the registry and release the exclusive lock.

**Exceptions**

[IceGrid::AccessDeniedException](#) — Raised if the session doesn't hold the exclusive lock.

**string getReplicaName()**

Get the name of the registry replica hosting this session.

**Return Value**

The replica name of the registry.

**IceGrid::FileIterator\*** `openServerLog(string id, string path, int count)` throws **IceGrid::FileNotAvailableException**, **IceGrid::ServerNotExistException**, **IceGrid::NodeUnreachableException**, **IceGrid::DeploymentException**

Open the given server log file for reading. The file can be read with the returned file iterator.

**Parameters**

`id` — The server id.

`path` — The path of the log file. A log file can be opened only if it's declared in the server or service deployment descriptor.

`count` — Specifies where to start reading the file. If negative, the file is read from the beginning. If 0 or positive, the file is read from the last `count` lines.

**Return Value**

An iterator to read the file.

**Exceptions**

**IceGrid::FileNotAvailableException** — Raised if the file can't be read.

**IceGrid::ServerNotExistException** — Raised if the server doesn't exist.

**IceGrid::NodeUnreachableException** — Raised if the node could not be reached.

**IceGrid::DeploymentException** — Raised if the server couldn't be deployed on the node.

**IceGrid::FileIterator\*** `openServerStdErr(string id, int count)` throws **IceGrid::FileNotAvailableException**, **IceGrid::ServerNotExistException**, **IceGrid::NodeUnreachableException**, **IceGrid::DeploymentException**

Open the given server stderr file for reading. The file can be read with the returned file iterator.

**Parameters**

`id` — The server id.

`count` — Specifies where to start reading the file. If negative, the file is read from the beginning. If 0 or positive, the file is read from the last `count` lines.

**Return Value**

An iterator to read the file.

**Exceptions**

**IceGrid::FileNotAvailableException** — Raised if the file can't be read.

**IceGrid::ServerNotExistException** — Raised if the server doesn't exist.

**IceGrid::NodeUnreachableException** — Raised if the node could not be reached.

**IceGrid::DeploymentException** — Raised if the server couldn't be deployed on the node.

**IceGrid::FileIterator\*** `openServerStdOut(string id, int count)` throws **IceGrid::FileNotAvailableException**, **IceGrid::ServerNotExistException**, **IceGrid::NodeUnreachableException**, **IceGrid::DeploymentException**

Open the given server stdout file for reading. The file can be read with the returned file iterator.

**Parameters**

`id` — The server id.

`count` — Specifies where to start reading the file. If negative, the file is read from the beginning. If 0 or positive, the file is read from the last `count` lines.

**Return Value**

An iterator to read the file.

**Exceptions**

`IceGrid::FileNotAvailableException` — Raised if the file can't be read.  
`IceGrid::ServerNotExistException` — Raised if the server doesn't exist.  
`IceGrid::NodeUnreachableException` — Raised if the node could not be reached.  
`IceGrid::DeploymentException` — Raised if the server couldn't be deployed on the node.

**`IceGrid::FileIterator*` `openNodeStdErr(string name, int count)` throws `IceGrid::FileNotAvailableException`, `IceGrid::NodeNotExistException`, `IceGrid::NodeUnreachableException`**

Open the given node stderr file for reading. The file can be read with the returned file iterator.

**Parameters**

`name` — The node name.  
`count` — Specifies where to start reading the file. If negative, the file is read from the beginning. If 0 or positive, the file is read from the last `count` lines.

**Return Value**

An iterator to read the file.

**Exceptions**

`IceGrid::FileNotAvailableException` — Raised if the file can't be read.  
`IceGrid::NodeNotExistException` — Raised if the node doesn't exist.  
`IceGrid::NodeUnreachableException` — Raised if the node could not be reached.

**`IceGrid::FileIterator*` `openNodeStdOut(string name, int count)` throws `IceGrid::FileNotAvailableException`, `IceGrid::NodeNotExistException`, `IceGrid::NodeUnreachableException`**

Open the given node stdout file for reading. The file can be read with the returned file iterator.

**Parameters**

`name` — The node name.  
`count` — Specifies where to start reading the file. If negative, the file is read from the beginning. If 0 or positive, the file is read from the last `count` lines.

**Return Value**

An iterator to read the file.

**Exceptions**

`IceGrid::FileNotAvailableException` — Raised if the file can't be read.  
`IceGrid::NodeNotExistException` — Raised if the node doesn't exist.  
`IceGrid::NodeUnreachableException` — Raised if the node could not be reached.

**`IceGrid::FileIterator*` `openRegistryStdErr(string name, int count)` throws `IceGrid::FileNotAvailableException`, `IceGrid::RegistryNotExistException`, `IceGrid::RegistryUnreachableException`**

Open the given registry stderr file for reading. The file can be read with the returned file iterator.

**Parameters**

`name` — The registry name.

`count` — Specifies where to start reading the file. If negative, the file is read from the beginning. If 0 or positive, the file is read from the last `count` lines.

**Return Value**

An iterator to read the file.

**Exceptions**

`IceGrid::FileNotAvailableException` — Raised if the file can't be read.

`IceGrid::RegistryNotExistException` — Raised if the registry doesn't exist.

`IceGrid::RegistryUnreachableException` — Raised if the registry could not be reached.

**IceGrid::FileIterator\* openRegistryStdOut(string name, int count) throws IceGrid::FileNotAvailableException, IceGrid::RegistryNotExistException, IceGrid::RegistryUnreachableException**

Open the given registry stdout file for reading. The file can be read with the returned file iterator.

**Parameters**

`name` — The registry name.

`count` — Specifies where to start reading the file. If negative, the file is read from the beginning. If 0 or positive, the file is read from the last `count` lines.

**Return Value**

An iterator to read the file.

**Exceptions**

`IceGrid::FileNotAvailableException` — Raised if the file can't be read.

`IceGrid::RegistryNotExistException` — Raised if the registry doesn't exist.

`IceGrid::RegistryUnreachableException` — Raised if the registry could not be reached.

# IceGrid-AllocationException

---

## IceGrid::AllocationException

### Overview

exception AllocationException

This exception is raised if the allocation of an object failed.

#### *Derived Exceptions*

- [IceGrid::AllocationTimeoutException](#)

#### *Used By*

- [IceGrid::Session::allocateObjectById](#)
- [IceGrid::Session::allocateObjectByType](#)
- [IceGrid::Session::releaseObject](#)

### Data Member Index

[reason](#) — The reason why the object couldn't be allocated.

### Data Members

**string** reason;

The reason why the object couldn't be allocated.

---

## IceGrid-AllocationTimeoutException

---

### IceGrid::AllocationTimeoutException

#### Overview

exception `AllocationTimeoutException` extends `IceGrid::AllocationException`

This exception is raised if the request to allocate an object times out.

---

# IceGrid-ApplicationDescriptor

---

## IceGrid::ApplicationDescriptor

### Overview

#### struct ApplicationDescriptor

An application descriptor.

#### Used By

- `IceGrid::Admin::addApplication`
- `IceGrid::Admin::getDefaultApplicationDescriptor`
- `IceGrid::Admin::syncApplicationWithoutRestart`
- `IceGrid::Admin::syncApplication`
- `IceGrid::ApplicationDescriptorSeq`
- `IceGrid::ApplicationInfo::descriptor`
- `IceGrid::FileParser::parse`

### Data Member Index

`name` — The application name.  
`variables` — The variables defined in the application descriptor.  
`replicaGroups` — The replica groups.  
`serverTemplates` — The server templates.  
`serviceTemplates` — The service templates.  
`nodes` — The application nodes.  
`distrib` — The application distribution.  
`description` — The description of this application.  
`propertySets` — Property set descriptors.

### Data Members

**string name;**

The application name.

**[ "java:type:java.util.TreeMap<String, String>" ] IceGrid::StringStringDict variables;**

The variables defined in the application descriptor.

**IceGrid::ReplicaGroupDescriptorSeq replicaGroups;**

The replica groups.

**IceGrid::TemplateDescriptorDict serverTemplates;**

The server templates.

**IceGrid::TemplateDescriptorDict serviceTemplates;**

The service templates.

**IceGrid::NodeDescriptorDict nodes;**

The application nodes.

**IceGrid::DistributionDescriptor** distrib;

The application distribution.

**string** description;

The description of this application.

**IceGrid::PropertySetDescriptorDict** propertySets;

Property set descriptors.

---



# IceGrid-ApplicationInfo

---

## IceGrid::ApplicationInfo

### Overview

#### struct ApplicationInfo

Information about an IceGrid application.

#### Used By

- [IceGrid::Admin::getApplicationInfo](#)
- [IceGrid::ApplicationInfoSeq](#)
- [IceGrid::ApplicationObserver::applicationAdded](#)

### Data Member Index

[uuid](#) — Unique application identifier.

[createTime](#) — The creation time.

[createUser](#) — The user who created the application.

[updateTime](#) — The update time.

[updateUser](#) — The user who updated the application.

[revision](#) — The application revision number.

[descriptor](#) — The application descriptor

### Data Members

#### string uuid;

Unique application identifier.

#### long createTime;

The creation time.

#### string createUser;

The user who created the application.

#### long updateTime;

The update time.

#### string updateUser;

The user who updated the application.

#### int revision;

The application revision number.

#### [IceGrid::ApplicationDescriptor](#) descriptor;

The application descriptor

---

# IceGrid-ApplicationNotExistException

---

## IceGrid::ApplicationNotExistException

### Overview

#### exception ApplicationNotExistException

This exception is raised if an application does not exist.

#### *Used By*

- IceGrid::Admin::getApplicationInfo
- IceGrid::Admin::instantiateServer
- IceGrid::Admin::patchApplication
- IceGrid::Admin::removeApplication
- IceGrid::Admin::syncApplicationWithoutRestart
- IceGrid::Admin::syncApplication
- IceGrid::Admin::updateApplicationWithoutRestart
- IceGrid::Admin::updateApplication

### Data Member Index

`name` — The name of the application.

### Data Members

`string name;`

The name of the application.

---

# IceGrid-ApplicationObserver

---

## IceGrid::ApplicationObserver

### Overview

#### interface ApplicationObserver

The database observer interface. Observers should implement this interface to receive information about the state of the IceGrid registry database.

### Operation Index

**applicationInit** — `applicationInit` is called after the registration of an observer to indicate the state of the registry.

**applicationAdded** — The `applicationAdded` operation is called to notify an observer that an application was added.

**applicationRemoved** — The `applicationRemoved` operation is called to notify an observer that an application was removed.

**applicationUpdated** — The `applicationUpdated` operation is called to notify an observer that an application was updated.

### Operations

#### void applicationInit(int serial, IceGrid::ApplicationInfoSeq applications)

`applicationInit` is called after the registration of an observer to indicate the state of the registry.

##### Parameters

`serial` — The current serial number of the registry database. This serial number allows observers to make sure that their internal state is synchronized with the registry.

`applications` — The applications currently registered with the registry.

#### void applicationAdded(int serial, IceGrid::ApplicationInfo desc)

The `applicationAdded` operation is called to notify an observer that an application was added.

##### Parameters

`serial` — The new serial number of the registry database.

`desc` — The descriptor of the new application.

#### void applicationRemoved(int serial, string name)

The `applicationRemoved` operation is called to notify an observer that an application was removed.

##### Parameters

`serial` — The new serial number of the registry database.

`name` — The name of the application that was removed.

#### void applicationUpdated(int serial, IceGrid::ApplicationUpdateInfo desc)

The `applicationUpdated` operation is called to notify an observer that an application was updated.

##### Parameters

`serial` — The new serial number of the registry database.

`desc` — The descriptor of the update.

---

# IceGrid-ApplicationUpdateDescriptor

---

## IceGrid::ApplicationUpdateDescriptor

### Overview

#### struct ApplicationUpdateDescriptor

An application update descriptor to describe the updates to apply to a deployed application.

#### Used By

- `IceGrid::Admin::updateApplicationWithoutRestart`
- `IceGrid::Admin::updateApplication`
- `IceGrid::ApplicationUpdateInfo::descriptor`

### Data Member Index

`name` — The name of the application to update.  
`description` — The updated description (or null if the description wasn't updated.)  
`distrib` — The updated distribution application descriptor.  
`variables` — The variables to update.  
`removeVariables` — The variables to remove.  
`propertySets` — The property sets to update.  
`removePropertySets` — The property sets to remove.  
`replicaGroups` — The replica groups to update.  
`removeReplicaGroups` — The replica groups to remove.  
`serverTemplates` — The server templates to update.  
`removeServerTemplates` — The ids of the server template to remove.  
`serviceTemplates` — The service templates to update.  
`removeServiceTemplates` — The ids of the service template to remove.  
`nodes` — The application nodes to update.  
`removeNodes` — The nodes to remove.

### Data Members

#### `string name;`

The name of the application to update.

#### `IceGrid::BoxedString description;`

The updated description (or null if the description wasn't updated.)

#### `IceGrid::BoxedDistributionDescriptor distrib;`

The updated distribution application descriptor.

#### `[ "java:type:java.util.TreeMap<String, String>" ] IceGrid::StringStringDict variables;`

The variables to update.

#### `Ice::StringSeq removeVariables;`

The variables to remove.

#### `IceGrid::PropertySetDescriptorDict propertySets;`

The property sets to update.

**Ice::StringSeq** removePropertySets;

The property sets to remove.

**IceGrid::ReplicaGroupDescriptorSeq** replicaGroups;

The replica groups to update.

**Ice::StringSeq** removeReplicaGroups;

The replica groups to remove.

**IceGrid::TemplateDescriptorDict** serverTemplates;

The server templates to update.

**Ice::StringSeq** removeServerTemplates;

The ids of the server template to remove.

**IceGrid::TemplateDescriptorDict** serviceTemplates;

The service templates to update.

**Ice::StringSeq** removeServiceTemplates;

The ids of the service template to remove.

**IceGrid::NodeUpdateDescriptorSeq** nodes;

The application nodes to update.

**Ice::StringSeq** removeNodes;

The nodes to remove.

---

# IceGrid-ApplicationUpdateInfo

---

## IceGrid::ApplicationUpdateInfo

### Overview

#### **struct ApplicationUpdateInfo**

Information about updates to an IceGrid application.

#### **Used By**

- [IceGrid::ApplicationObserver::applicationUpdated](#)

### Data Member Index

[updateTime](#) — The update time.

[updateUser](#) — The user who updated the application.

[revision](#) — The application revision number.

[descriptor](#) — The update descriptor.

### Data Members

#### **long updateTime;**

The update time.

#### **string updateUser;**

The user who updated the application.

#### **int revision;**

The application revision number.

#### **IceGrid::ApplicationUpdateDescriptor descriptor;**

The update descriptor.

---

## IceGrid-BadSignalException

---

### IceGrid::BadSignalException

#### Overview

exception `BadSignalException`

This exception is raised if an unknown signal was sent to to a server.

#### *Used By*

- `IceGrid::Admin::sendSignal`

#### Data Member Index

`reason` — The details of the unknown signal.

#### Data Members

`string reason;`

The details of the unknown signal.

---

# IceGrid-BoxedDistributionDescriptor

---

## IceGrid::BoxedDistributionDescriptor

### Overview

**class** `BoxedDistributionDescriptor`

A "boxed" distribution descriptor.

### *Used By*

- `IceGrid::ApplicationUpdateDescriptor::distrib`

### Data Member Index

`value` — The value of the boxed distribution descriptor.

### Data Members

**IceGrid::DistributionDescriptor** `value`;

The value of the boxed distribution descriptor.

---



## IceGrid-BoxedString

---

### IceGrid::BoxedString

#### Overview

#### class BoxedString

A "boxed" string.

#### *Used By*

- [IceGrid::ApplicationUpdateDescriptor::description](#)
- [IceGrid::NodeUpdateDescriptor::description](#)
- [IceGrid::NodeUpdateDescriptor::loadFactor](#)

#### Data Member Index

[value](#) — The value of the boxed string.

#### Data Members

**string value;**

The value of the boxed string.

---

# IceGrid-CommunicatorDescriptor

---

## IceGrid::CommunicatorDescriptor

### Overview

**class** CommunicatorDescriptor

A communicator descriptor.

#### *Derived Classes and Interfaces*

- [IceGrid::ServerDescriptor](#)
- [IceGrid::ServiceDescriptor](#)

#### *Used By*

- [IceGrid::TemplateDescriptor::descriptor](#)

### Data Member Index

[adapters](#) — The object adapters.  
[propertySet](#) — The property set.  
[dbEnvs](#) — The database environments.  
[logs](#) — The path of each log file.  
[description](#) — A description of this descriptor.

### Data Members

**IceGrid::AdapterDescriptorSeq** adapters;

The object adapters.

**IceGrid::PropertySetDescriptor** propertySet;

The property set.

**IceGrid::DbEnvDescriptorSeq** dbEnvs;

The database environments.

**Ice::StringSeq** logs;

The path of each log file.

**string** description;

A description of this descriptor.

---

# IceGrid-DbEnvDescriptor

---

## IceGrid::DbEnvDescriptor

### Overview

[ "cpp:comparable" ] struct DbEnvDescriptor

A Freeze database environment descriptor.

### Used By

- [IceGrid::DbEnvDescriptorSeq](#)

### Data Member Index

[name](#) — The name of the database environment.

[description](#) — The description of this database environment.

[dbHome](#) — The home of the database environment (i.e., the directory where the database files will be stored).

[properties](#) — The configuration properties of the database environment.

### Data Members

**string name;**

The name of the database environment.

**string description;**

The description of this database environment.

**string dbHome;**

The home of the database environment (i.e., the directory where the database files will be stored). If empty, the node will provide a default database directory, otherwise the directory must exist.

**IceGrid::PropertyDescriptorSeq properties;**

The configuration properties of the database environment.

---

# IceGrid-DeploymentException

---

## IceGrid::DeploymentException

### Overview

#### exception DeploymentException

An exception for deployment errors.

#### Used By

- IceGrid::Admin::addApplication
- IceGrid::Admin::addObjectWithType
- IceGrid::Admin::addObject
- IceGrid::Admin::enableServer
- IceGrid::Admin::getDefaultApplicationDescriptor
- IceGrid::Admin::getServerAdmin
- IceGrid::Admin::getServerPid
- IceGrid::Admin::getServerState
- IceGrid::Admin::instantiateServer
- IceGrid::Admin::isServerEnabled
- IceGrid::Admin::patchServer
- IceGrid::Admin::removeAdapter
- IceGrid::Admin::removeApplication
- IceGrid::Admin::removeObject
- IceGrid::Admin::sendSignal
- IceGrid::Admin::startServer
- IceGrid::Admin::stopServer
- IceGrid::Admin::syncApplicationWithoutRestart
- IceGrid::Admin::syncApplication
- IceGrid::Admin::updateApplicationWithoutRestart
- IceGrid::Admin::updateApplication
- IceGrid::Admin::updateObject
- IceGrid::Admin::writeMessage
- IceGrid::AdminSession::openServerLog
- IceGrid::AdminSession::openServerStdErr
- IceGrid::AdminSession::openServerStdOut

### Data Member Index

`reason` — The reason for the failure.

### Data Members

`string reason;`

The reason for the failure.

---

# IceGrid-DistributionDescriptor

---

## IceGrid::DistributionDescriptor

### Overview

[ "cpp:comparable" ] struct DistributionDescriptor

A distribution descriptor defines an IcePatch2 server and the directories to retrieve from the patch server.

### Used By

- IceGrid::ApplicationDescriptor::distrib
- IceGrid::BoxedDistributionDescriptor::value
- IceGrid::ServerDescriptor::distrib

### Data Member Index

[icepatch](#) — The proxy of the IcePatch2 server.

[directories](#) — The source directories.

### Data Members

**string icepatch;**

The proxy of the IcePatch2 server.

[ "java:type:java.util.LinkedList<String>" ] **Ice::StringSeq directories;**

The source directories.

---

# IceGrid-FileIterator

---

## IceGrid::FileIterator

### Overview

#### interface FileIterator

This interface provides access to IceGrid log file contents.

### Operation Index

`read` — Read lines from the log file.

`destroy` — Destroy the iterator.

### Operations

**`bool read(int size, out Ice::StringSeq lines) throws IceGrid::FileNotAvailableException`**

Read lines from the log file.

#### *Parameters*

`size` — Specifies the maximum number of bytes to be received. The server will ensure that the returned message doesn't exceed the given `size`.

`lines` — The lines read from the file. If there was nothing to read from the file since the last call to `read`, an empty sequence is returned. The last line of the sequence is always incomplete (and therefore no 'n' should be added when writing the last line to the to the output device).

#### *Return Value*

True if EOF is encountered.

#### *Exceptions*

`IceGrid::FileNotAvailableException` — Raised if there was a problem to read lines from the file.

**`void destroy()`**

Destroy the iterator.

---

# IceGrid-FileNotAvailableException

---

## IceGrid::FileNotAvailableException

### Overview

exception `FileNotAvailableException`

This exception is raised if a file is not available.

### Used By

- `IceGrid::AdminSession::openNodeStdErr`
- `IceGrid::AdminSession::openNodeStdOut`
- `IceGrid::AdminSession::openRegistryStdErr`
- `IceGrid::AdminSession::openRegistryStdOut`
- `IceGrid::AdminSession::openServerLog`
- `IceGrid::AdminSession::openServerStdErr`
- `IceGrid::AdminSession::openServerStdOut`
- `IceGrid::FileIterator::read`

### See Also

- `IceGrid::AdminSession::openServerStdOut`
- `IceGrid::AdminSession::openServerStdErr`
- `IceGrid::AdminSession::openNodeStdOut`
- `IceGrid::AdminSession::openNodeStdErr`
- `IceGrid::AdminSession::openRegistryStdOut`
- `IceGrid::AdminSession::openRegistryStdErr`

### Data Member Index

`reason` — The reason for the failure.

### Data Members

`string reason;`

The reason for the failure.

---

# IceGrid-FileParser

---

## IceGrid::FileParser

### Overview

#### interface FileParser

icegridadmin provides a [IceGrid::FileParser](#) object to transform XML files into [IceGrid::ApplicationDescriptor](#) objects.

### Operation Index

[parse](#) — Parse a file.

### Operations

**[IceGrid::ApplicationDescriptor](#) [parse](#)(string xmlFile, [IceGrid::Admin\\*](#) adminProxy) throws [IceGrid::ParseException](#)**

Parse a file.

#### **Parameters**

`xmlFile` — Full pathname to the file.

`adminProxy` — An Admin proxy, used only to retrieve default templates when needed. May be null.

#### **Return Value**

The application descriptor.

#### **Exceptions**

[IceGrid::ParseException](#) — Raised if an error occurred during parsing.

---



## IceGrid-IceBoxDescriptor

---

### IceGrid::IceBoxDescriptor

#### Overview

class `IceBoxDescriptor` extends `IceGrid::ServerDescriptor`

An IceBox server descriptor.

#### Data Member Index

`services` — The service instances.

#### Data Members

`IceGrid::ServiceInstanceDescriptorSeq` `services`;

The service instances.

---

# IceGrid-LoadBalancingPolicy

---

## IceGrid::LoadBalancingPolicy

### Overview

#### class LoadBalancingPolicy

A base class for load balancing policies.

#### *Derived Classes and Interfaces*

- [IceGrid::AdaptiveLoadBalancingPolicy](#)
- [IceGrid::OrderedLoadBalancingPolicy](#)
- [IceGrid::RandomLoadBalancingPolicy](#)
- [IceGrid::RoundRobinLoadBalancingPolicy](#)

#### *Used By*

- [IceGrid::ReplicaGroupDescriptor::loadBalancing](#)

### Data Member Index

[nReplicas](#) — The number of replicas that will be used to gather the endpoints of a replica group.

### Data Members

**string nReplicas;**

The number of replicas that will be used to gather the endpoints of a replica group.

---

# IceGrid-LoadInfo

---

## IceGrid::LoadInfo

### Overview

#### struct LoadInfo

Information about the load of a node.

#### Used By

- [IceGrid::Admin::getNodeLoad](#)

### Data Member Index

[avg1](#) — The load average over the past minute.

[avg5](#) — The load average over the past 5 minutes.

[avg15](#) — The load average over the past 15 minutes.

### Data Members

**float avg1;**

The load average over the past minute.

**float avg5;**

The load average over the past 5 minutes.

**float avg15;**

The load average over the past 15 minutes.

---

# IceGrid-Locator

---

## IceGrid::Locator

### Overview

interface `Locator` extends `Ice::Locator`

The IceGrid locator interface provides access to the `IceGrid::Query` and `IceGrid::Registry` object of the IceGrid registry.

#### See Also

- [IceGrid::Query](#)
- [IceGrid::Registry](#)

### Operation Index

[getLocalRegistry](#) — Get the proxy of the registry object hosted by this IceGrid registry.

[getLocalQuery](#) — Get the proxy of the query object hosted by this IceGrid registry.

### Operations

#### `IceGrid::Registry*` [getLocalRegistry\(\)](#)

Get the proxy of the registry object hosted by this IceGrid registry.

##### *Return Value*

The proxy of the registry object.

#### `IceGrid::Query*` [getLocalQuery\(\)](#)

Get the proxy of the query object hosted by this IceGrid registry.

##### *Return Value*

The proxy of the query object.

---

# IceGrid-NodeDescriptor

---

## IceGrid::NodeDescriptor

### Overview

**struct NodeDescriptor**

A node descriptor.

#### Used By

- [IceGrid::NodeDescriptorDict](#)

### Data Member Index

[variables](#) — The variables defined for the node.

[serverInstances](#) — The server instances.

[servers](#) — Servers (which are not template instances).

[loadFactor](#) — Load factor of the node.

[description](#) — The description of this node.

[propertySets](#) — Property set descriptors.

### Data Members

[ "java:type:java.util.TreeMap<String, String>" ] [IceGrid::StringStringDict](#) variables;

The variables defined for the node.

[IceGrid::ServerInstanceDescriptorSeq](#) serverInstances;

The server instances.

[IceGrid::ServerDescriptorSeq](#) servers;

Servers (which are not template instances).

**string loadFactor;**

Load factor of the node.

**string description;**

The description of this node.

[IceGrid::PropertySetDescriptorDict](#) propertySets;

Property set descriptors.

---

# IceGrid-NodeDynamicInfo

---

## IceGrid::NodeDynamicInfo

### Overview

#### struct NodeDynamicInfo

Dynamic information about the state of a node.

#### Used By

- [IceGrid::NodeDynamicInfoSeq](#)
- [IceGrid::NodeObserver::nodeUp](#)

### Data Member Index

[info](#) — Some static information about the node.

[servers](#) — The dynamic information of the servers deployed on this node.

[adapters](#) — The dynamic information of the adapters deployed on this node.

### Data Members

#### [IceGrid::NodeInfo](#) info;

Some static information about the node.

#### [IceGrid::ServerDynamicInfoSeq](#) servers;

The dynamic information of the servers deployed on this node.

#### [IceGrid::AdapterDynamicInfoSeq](#) adapters;

The dynamic information of the adapters deployed on this node.

---

# IceGrid-NodeInfo

---

## IceGrid::NodeInfo

### Overview

#### struct NodeInfo

Information about an IceGrid node.

#### Used By

- [IceGrid::Admin::getNodeInfo](#)
- [IceGrid::NodeDynamicInfo::info](#)

### Data Member Index

`name` — The name of the node.

`os` — The operating system name.

`hostname` — The network name of the host running this node (as defined in `uname()`).

`release` — The operation system release level (as defined in `uname()`).

`version` — The operation system version (as defined in `uname()`).

`machine` — The machine hardware type (as defined in `uname()`).

`nProcessors` — The number of processor threads on the node.

`dataDir` — The path to the node data directory.

### Data Members

#### string name;

The name of the node.

#### string os;

The operating system name.

#### string hostname;

The network name of the host running this node (as defined in `uname()`).

#### string release;

The operation system release level (as defined in `uname()`).

#### string version;

The operation system version (as defined in `uname()`).

#### string machine;

The machine hardware type (as defined in `uname()`).

#### int nProcessors;

The number of processor threads on the node. For example, `nProcessors` is 8 on a computer with a single quad-core processor and two HT threads per core.

#### string dataDir;

The path to the node data directory.

---



# IceGrid-NodeNotExistException

---

## IceGrid::NodeNotExistException

### Overview

exception `NodeNotExistException`

This exception is raised if a node does not exist.

### *Used By*

- `IceGrid::Admin::getNodeHostname`
- `IceGrid::Admin::getNodeInfo`
- `IceGrid::Admin::getNodeLoad`
- `IceGrid::Admin::getNodeProcessorSocketCount`
- `IceGrid::Admin::pingNode`
- `IceGrid::Admin::shutdownNode`
- `IceGrid::AdminSession::openNodeStdErr`
- `IceGrid::AdminSession::openNodeStdOut`

### Data Member Index

`name` — The node name.

### Data Members

`string name;`

The node name.

---

# IceGrid-NodeObserver

---

## IceGrid::NodeObserver

### Overview

#### interface NodeObserver

The node observer interface. Observers should implement this interface to receive information about the state of the IceGrid nodes.

### Operation Index

`nodeInit` — The `nodeInit` operation indicates the current state of nodes.

`nodeUp` — The `nodeUp` operation is called to notify an observer that a node came up.

`nodeDown` — The `nodeDown` operation is called to notify an observer that a node went down.

`updateServer` — The `updateServer` operation is called to notify an observer that the state of a server changed.

`updateAdapter` — The `updateAdapter` operation is called to notify an observer that the state of an adapter changed.

### Operations

#### `void nodeInit(IceGrid::NodeDynamicInfoSeq nodes)`

The `nodeInit` operation indicates the current state of nodes. It is called after the registration of an observer.

##### *Parameters*

`nodes` — The current state of the nodes.

#### `void nodeUp(IceGrid::NodeDynamicInfo node)`

The `nodeUp` operation is called to notify an observer that a node came up.

##### *Parameters*

`node` — The node state.

#### `void nodeDown(string name)`

The `nodeDown` operation is called to notify an observer that a node went down.

##### *Parameters*

`name` — The node name.

#### `void updateServer(string node, IceGrid::ServerDynamicInfo updatedInfo)`

The `updateServer` operation is called to notify an observer that the state of a server changed.

##### *Parameters*

`node` — The node hosting the server.

`updatedInfo` — The new server state.

#### `void updateAdapter(string node, IceGrid::AdapterDynamicInfo updatedInfo)`

The `updateAdapter` operation is called to notify an observer that the state of an adapter changed.

##### *Parameters*

`node` — The node hosting the adapter.

`updatedInfo` — The new adapter state.

---

# IceGrid-NodeUnreachableException

---

## IceGrid::NodeUnreachableException

### Overview

#### exception NodeUnreachableException

This exception is raised if a node could not be reached.

#### Used By

- IceGrid::Admin::enableServer
- IceGrid::Admin::getNodeHostname
- IceGrid::Admin::getNodeInfo
- IceGrid::Admin::getNodeLoad
- IceGrid::Admin::getNodeProcessorSocketCount
- IceGrid::Admin::getServerAdmin
- IceGrid::Admin::getServerPid
- IceGrid::Admin::getServerState
- IceGrid::Admin::isServerEnabled
- IceGrid::Admin::patchServer
- IceGrid::Admin::sendSignal
- IceGrid::Admin::shutdownNode
- IceGrid::Admin::startServer
- IceGrid::Admin::stopServer
- IceGrid::Admin::writeMessage
- IceGrid::AdminSession::openNodeStdErr
- IceGrid::AdminSession::openNodeStdOut
- IceGrid::AdminSession::openServerLog
- IceGrid::AdminSession::openServerStdErr
- IceGrid::AdminSession::openServerStdOut

### Data Member Index

`name` — The name of the node that is not reachable.

`reason` — The reason why the node couldn't be reached.

### Data Members

**string name;**

The name of the node that is not reachable.

**string reason;**

The reason why the node couldn't be reached.

---

# IceGrid-NodeUpdateDescriptor

---

## IceGrid::NodeUpdateDescriptor

### Overview

#### struct NodeUpdateDescriptor

A node update descriptor to describe the updates to apply to a node of a deployed application.

#### Used By

- [IceGrid::NodeUpdateDescriptorSeq](#)

### Data Member Index

[name](#) — The name of the node to update.

[description](#) — The updated description (or null if the description wasn't updated.)

[variables](#) — The variables to update.

[removeVariables](#) — The variables to remove.

[propertySets](#) — The property sets to update.

[removePropertySets](#) — The property sets to remove.

[serverInstances](#) — The server instances to update.

[servers](#) — The servers which are not template instances to update.

[removeServers](#) — The ids of the servers to remove.

[loadFactor](#) — The updated load factor of the node (or null if the load factor was not updated).

### Data Members

#### string name;

The name of the node to update.

#### IceGrid::BoxedString description;

The updated description (or null if the description wasn't updated.)

#### [ "java:type:java.util.TreeMap<String, String>" ] IceGrid::StringStringDict variables;

The variables to update.

#### Ice::StringSeq removeVariables;

The variables to remove.

#### IceGrid::PropertyDescriptorDict propertySets;

The property sets to update.

#### Ice::StringSeq removePropertySets;

The property sets to remove.

#### IceGrid::ServerInstanceDescriptorSeq serverInstances;

The server instances to update.

#### IceGrid::ServerDescriptorSeq servers;

The servers which are not template instances to update.

**Ice::StringSeq** removeServers;

The ids of the servers to remove.

**IceGrid::BoxedString** loadFactor;

The updated load factor of the node (or null if the load factor was not updated).

---

# IceGrid-ObjectDescriptor

---

## IceGrid::ObjectDescriptor

### Overview

#### **struct** ObjectDescriptor

An Ice object descriptor.

#### **Used By**

- [IceGrid::ObjectDescriptorSeq](#)

### Data Member Index

[id](#) — The identity of the object.

[type](#) — The object type.

[proxyOptions](#) — Proxy options to use with the proxy created for this Ice object.

### Data Members

#### **Ice::Identity** id;

The identity of the object.

#### **string** type;

The object type.

#### **string** proxyOptions;

Proxy options to use with the proxy created for this Ice object. If empty, the proxy will be created with the proxy options specified on the object adapter or replica group.

---

## IceGrid-ObjectExistsException

---

### IceGrid::ObjectExistsException

#### Overview

exception `ObjectExistsException`

This exception is raised if an object already exists.

#### *Used By*

- `IceGrid::Admin::addObjectWithType`
- `IceGrid::Admin::addObject`

#### Data Member Index

`id` — The identity of the object.

#### Data Members

**Ice::Identity** `id`;

The identity of the object.

---



# IceGrid-ObjectInfo

---

## IceGrid::ObjectInfo

### Overview

[ "cpp:comparable" ] struct ObjectInfo

Information about an Ice object.

#### *Used By*

- IceGrid::Admin::getObjectInfo
- IceGrid::ObjectInfoSeq
- IceGrid::ObjectObserver::objectAdded
- IceGrid::ObjectObserver::objectUpdated

### Data Member Index

[proxy](#) — The proxy of the object.

[type](#) — The type of the object.

### Data Members

**Object\* proxy;**

The proxy of the object.

**string type;**

The type of the object.

---

# IceGrid-ObjectNotRegisteredException

---

## IceGrid::ObjectNotRegisteredException

### Overview

exception `ObjectNotRegisteredException`

This exception is raised if an object is not registered.

### *Used By*

- `IceGrid::Admin::getObjectInfo`
- `IceGrid::Admin::removeObject`
- `IceGrid::Admin::updateObject`
- `IceGrid::Session::allocateObjectById`
- `IceGrid::Session::releaseObject`

### Data Member Index

`id` — The identity of the object.

### Data Members

**Ice::Identity** `id`;

The identity of the object.

---

# IceGrid-ObjectObserver

---

## IceGrid::ObjectObserver

### Overview

#### interface ObjectObserver

This interface allows applications to monitor IceGrid well-known objects.

### Operation Index

**objectInit** — `objectInit` is called after the registration of an observer to indicate the state of the registry.

**objectAdded** — The `objectAdded` operation is called to notify an observer when an object was added to the `IceGrid::Admin` interface.

**objectUpdated** — `objectUpdated` is called to notify an observer when an object registered with the `IceGrid::Admin` interface was updated.

**objectRemoved** — `objectRemoved` is called to notify an observer when an object registered with the `IceGrid::Admin` interface was removed.

### Operations

#### void objectInit(IceGrid::ObjectInfoSeq objects)

`objectInit` is called after the registration of an observer to indicate the state of the registry.

##### **Parameters**

`objects` — The objects registered with the `IceGrid::Admin` interface (not through the deployment mechanism).

#### void objectAdded(IceGrid::ObjectInfo info)

The `objectAdded` operation is called to notify an observer when an object was added to the `IceGrid::Admin` interface.

##### **Parameters**

`info` — The details of the added object.

#### void objectUpdated(IceGrid::ObjectInfo info)

`objectUpdated` is called to notify an observer when an object registered with the `IceGrid::Admin` interface was updated.

##### **Parameters**

`info` — The details of the updated object.

#### void objectRemoved(Ice::Identity id)

`objectRemoved` is called to notify an observer when an object registered with the `IceGrid::Admin` interface was removed.

##### **Parameters**

`id` — The identity of the removed object.

---

## IceGrid-ObserverAlreadyRegisteredException

---

### IceGrid::ObserverAlreadyRegisteredException

#### Overview

exception `ObserverAlreadyRegisteredException`

This exception is raised if an observer is already registered with the registry.

#### Used By

- `IceGrid::AdminSession::setObserversByIdentity`
- `IceGrid::AdminSession::setObservers`

#### See Also

- `IceGrid::AdminSession::setObservers`
- `IceGrid::AdminSession::setObserversByIdentity`

#### Data Member Index

`id` — The identity of the observer.

#### Data Members

**Ice::Identity** `id`;

The identity of the observer.

---

## IceGrid-OrderedLoadBalancingPolicy

---

### IceGrid::OrderedLoadBalancingPolicy

#### Overview

`class OrderedLoadBalancingPolicy` extends `IceGrid::LoadBalancingPolicy`

Ordered load balancing policy.

---

## IceGrid-ParseException

---

### IceGrid::ParseException

#### Overview

exception ParseException

This exception is raised if an error occurs during parsing.

#### Used By

- [IceGrid::FileParser::parse](#)

#### Data Member Index

`reason` — The reason for the failure.

#### Data Members

`string reason;`

The reason for the failure.

---

## IceGrid-PatchException

---

### IceGrid::PatchException

#### Overview

exception PatchException

This exception is raised if a patch failed.

#### *Used By*

- IceGrid::Admin::patchApplication
- IceGrid::Admin::patchServer

#### Data Member Index

[reasons](#) — The reasons why the patch failed.

#### Data Members

[Ice::StringSeq](#) reasons;

The reasons why the patch failed.

---

# IceGrid-PermissionDeniedException

---

## IceGrid::PermissionDeniedException

### Overview

exception `PermissionDeniedException`

This exception is raised if a client is denied the ability to create a session with IceGrid.

### *Used By*

- `IceGrid::Registry::createAdminSessionFromSecureConnection`
- `IceGrid::Registry::createAdminSession`
- `IceGrid::Registry::createSessionFromSecureConnection`
- `IceGrid::Registry::createSession`

### Data Member Index

`reason` — The reason why permission was denied.

### Data Members

`string reason;`

The reason why permission was denied.

---



# IceGrid-PropertyDescriptor

---

## IceGrid::PropertyDescriptor

### Overview

**struct** PropertyDescriptor

Property descriptor.

### *Used By*

- [IceGrid::PropertyDescriptorSeq](#)

### Data Member Index

[name](#) — The name of the property.

[value](#) — The value of the property.

### Data Members

**string** name;

The name of the property.

**string** value;

The value of the property.

---

# IceGrid-PropertySetDescriptor

---

## IceGrid::PropertySetDescriptor

### Overview

[ "cpp:comparable" ] struct PropertySetDescriptor

A property set descriptor.

### Used By

- IceGrid::CommunicatorDescriptor::propertySet
- IceGrid::PropertySetDescriptorDict
- IceGrid::ServerInstanceDescriptor::propertySet
- IceGrid::ServiceInstanceDescriptor::propertySet

### Data Member Index

[references](#) — References to named property sets.

[properties](#) — The property set properties.

### Data Members

**Ice::StringSeq** references;

References to named property sets.

**IceGrid::PropertyDescriptorSeq** properties;

The property set properties.

---

# IceGrid-Query

---

## IceGrid::Query

### Overview

#### interface Query

The IceGrid query interface. This interface is accessible to Ice clients who wish to look up well-known objects.

### Operation Index

`findObjectById` — Find a well-known object by identity.

`findObjectByType` — Find a well-known object by type.

`findObjectByTypeOnLeastLoadedNode` — Find a well-known object by type on the least-loaded node.

`findAllObjectsByType` — Find all the well-known objects with the given type.

`findAllReplicas` — Find all the object replicas associated with the given proxy.

### Operations

#### [ "nonmutating" ] Object\* findObjectById(Ice::Identity id)

Find a well-known object by identity.

##### Parameters

`id` — The identity.

##### Return Value

The proxy or null if no such object has been found.

#### [ "nonmutating" ] Object\* findObjectByType(string type)

Find a well-known object by type. If there are several objects registered for the given type, the object is randomly selected.

##### Parameters

`type` — The object type.

##### Return Value

The proxy or null, if no such object has been found.

#### [ "nonmutating" ] Object\* findObjectByTypeOnLeastLoadedNode(string type, IceGrid::LoadSample sample)

Find a well-known object by type on the least-loaded node. If the registry does not know which node hosts the object (for example, because the object was registered with a direct proxy), the registry assumes the object is hosted on a node that has a load average of 1.0.

##### Parameters

`type` — The object type.

`sample` — The sampling interval.

##### Return Value

The proxy or null, if no such object has been found.

#### [ "nonmutating" ] Ice::ObjectProxySeq findAllObjectsByType(string type)

Find all the well-known objects with the given type.

**Parameters**

`type` — The object type.

**Return Value**

The proxies or an empty sequence, if no such objects have been found.

**Ice::ObjectProxySeq findAllReplicas(Object\* proxy)**

Find all the object replicas associated with the given proxy. If the given proxy is not an indirect proxy from a replica group, an empty sequence is returned.

**Parameters**

`proxy` — The object proxy.

**Return Value**

The proxies of each object replica or an empty sequence, if the given proxy is not from a replica group.

---

## IceGrid-RandomLoadBalancingPolicy

---

### IceGrid::RandomLoadBalancingPolicy

#### Overview

class `RandomLoadBalancingPolicy` extends `IceGrid::LoadBalancingPolicy`

Random load balancing policy.

---

# IceGrid-Registry

---

## IceGrid::Registry

### Overview

#### interface Registry

The IceGrid registry allows clients create sessions directly with the registry.

#### See Also

- [IceGrid::Session](#)
- [IceGrid::AdminSession](#)

### Operation Index

[createSession](#) — Create a client session.

[createAdminSession](#) — Create an administrative session.

[createSessionFromSecureConnection](#) — Create a client session from a secure connection.

[createAdminSessionFromSecureConnection](#) — Create an administrative session from a secure connection.

[getSessionTimeout](#) — Get the session timeout.

### Operations

#### **IceGrid::Session\*** [createSession\(string userId, string password\)](#) throws **IceGrid::PermissionDeniedException**

Create a client session.

#### **Parameters**

`userId` — The user id.

`password` — The password for the given user id.

#### **Return Value**

A proxy for the newly created session.

#### **Exceptions**

**IceGrid::PermissionDeniedException** — Raised if the password for the given user id is not correct, or if the user is not allowed access.

#### See Also

- [IceGrid::Session](#)
- [Glacier2::PermissionsVerifier](#)

#### **IceGrid::AdminSession\*** [createAdminSession\(string userId, string password\)](#) throws **IceGrid::PermissionDeniedException**

Create an administrative session.

#### **Parameters**

`userId` — The user id.

`password` — The password for the given user id.

#### **Return Value**

A proxy for the newly created session.

**Exceptions**

[IceGrid::PermissionDeniedException](#) — Raised if the password for the given user id is not correct, or if the user is not allowed access.

**See Also**

- [IceGrid::Session](#)
- [Glacier2::PermissionsVerifier](#)

**IceGrid::Session\* createSessionFromSecureConnection() throws IceGrid::PermissionDeniedException**

Create a client session from a secure connection.

**Return Value**

A proxy for the newly created session.

**Exceptions**

[IceGrid::PermissionDeniedException](#) — Raised if the password for the given user id is not correct, or if the user is not allowed access.

**See Also**

- [IceGrid::Session](#)
- [Glacier2::SSLPermissionsVerifier](#)

**IceGrid::AdminSession\* createAdminSessionFromSecureConnection() throws IceGrid::PermissionDeniedException**

Create an administrative session from a secure connection.

**Return Value**

A proxy for the newly created session.

**Exceptions**

[IceGrid::PermissionDeniedException](#) — Raised if the password for the given user id is not correct, or if the user is not allowed access.

**See Also**

- [IceGrid::Session](#)
- [Glacier2::SSLPermissionsVerifier](#)

**[ "nonmutating" ] int getSessionTimeout()**

Get the session timeout. If a client or administrative client doesn't call the session keepAlive method in the time interval defined by this timeout, IceGrid might reap the session.

**Return Value**

The timeout (in seconds).

**See Also**

- [IceGrid::Session::keepAlive](#)
- [IceGrid::AdminSession::keepAlive](#)

# IceGrid-RegistryInfo

---

## IceGrid::RegistryInfo

### Overview

#### struct RegistryInfo

Information about an IceGrid registry replica.

#### *Used By*

- [IceGrid::Admin::getRegistryInfo](#)
- [IceGrid::RegistryInfoSeq](#)
- [IceGrid::RegistryObserver::registryUp](#)

### Data Member Index

[name](#) — The name of the registry.

[hostname](#) — The network name of the host running this registry (as defined in `uname()`).

### Data Members

**string name;**

The name of the registry.

**string hostname;**

The network name of the host running this registry (as defined in `uname()`).

---



# IceGrid-RegistryNotExistException

---

## IceGrid::RegistryNotExistException

### Overview

exception RegistryNotExistException

This exception is raised if a registry does not exist.

### Used By

- IceGrid::Admin::getRegistryInfo
- IceGrid::Admin::pingRegistry
- IceGrid::Admin::shutdownRegistry
- IceGrid::AdminSession::openRegistryStdErr
- IceGrid::AdminSession::openRegistryStdOut

### Data Member Index

`name` — The registry name.

### Data Members

`string name;`

The registry name.

---

# IceGrid-RegistryObserver

---

## IceGrid::RegistryObserver

### Overview

#### interface RegistryObserver

This interface allows applications to monitor changes the state of the registry.

### Operation Index

`registryInit` — The `registryInit` operation is called after registration of an observer to indicate the state of the registries.

`registryUp` — The `nodeUp` operation is called to notify an observer that a node came up.

`registryDown` — The `nodeDown` operation is called to notify an observer that a node went down.

### Operations

#### void registryInit(IceGrid::RegistryInfoSeq registries)

The `registryInit` operation is called after registration of an observer to indicate the state of the registries.

##### *Parameters*

`registries` — The current state of the registries.

#### void registryUp(IceGrid::RegistryInfo node)

The `nodeUp` operation is called to notify an observer that a node came up.

##### *Parameters*

`node` — The node state.

#### void registryDown(string name)

The `nodeDown` operation is called to notify an observer that a node went down.

##### *Parameters*

`name` — The node name.

---

# IceGrid-RegistryUnreachableException

---

## IceGrid::RegistryUnreachableException

### Overview

exception RegistryUnreachableException

This exception is raised if a registry could not be reached.

### Used By

- IceGrid::Admin::getRegistryInfo
- IceGrid::Admin::shutdownRegistry
- IceGrid::AdminSession::openRegistryStdErr
- IceGrid::AdminSession::openRegistryStdOut

### Data Member Index

[name](#) — The name of the registry that is not reachable.

[reason](#) — The reason why the registry couldn't be reached.

### Data Members

**string name;**

The name of the registry that is not reachable.

**string reason;**

The reason why the registry couldn't be reached.

---

# IceGrid-ReplicaGroupDescriptor

---

## IceGrid::ReplicaGroupDescriptor

### Overview

#### **struct ReplicaGroupDescriptor**

A replica group descriptor.

#### **Used By**

- [IceGrid::ReplicaGroupDescriptorSeq](#)

### Data Member Index

[id](#) — The id of the replica group.

[loadBalancing](#) — The load balancing policy.

[proxyOptions](#) — Default options for proxies created for the replica group.

[objects](#) — The object descriptors associated with this object adapter.

[description](#) — The description of this replica group.

### Data Members

#### **string id;**

The id of the replica group.

#### **IceGrid::LoadBalancingPolicy loadBalancing;**

The load balancing policy.

#### **string proxyOptions;**

Default options for proxies created for the replica group.

#### **IceGrid::ObjectDescriptorSeq objects;**

The object descriptors associated with this object adapter.

#### **string description;**

The description of this replica group.

---

## IceGrid-RoundRobinLoadBalancingPolicy

---

### IceGrid::RoundRobinLoadBalancingPolicy

#### Overview

class RoundRobinLoadBalancingPolicy extends [IceGrid::LoadBalancingPolicy](#)

Round robin load balancing policy.

---

# IceGrid-ServerDescriptor

---

## IceGrid::ServerDescriptor

### Overview

class `ServerDescriptor` extends `IceGrid::CommunicatorDescriptor`

An Ice server descriptor.

#### Derived Classes and Interfaces

- `IceGrid::IceBoxDescriptor`

#### Used By

- `IceGrid::ServerDescriptorSeq`
- `IceGrid::ServerInfo::descriptor`

### Data Member Index

`id` — The server id.

`exe` — The path of the server executable.

`iceVersion` — The Ice version used by this server.

`pwd` — The path to the server working directory.

`options` — The command line options to pass to the server executable.

`envs` — The server environment variables.

`activation` — The server activation mode (possible values are "on-demand" or "manual").

`activationTimeout` — The activation timeout (an integer value representing the number of seconds to wait for activation).

`deactivationTimeout` — The deactivation timeout (an integer value representing the number of seconds to wait for deactivation).

`applicationDistrib` — Specifies if the server depends on the application distribution.

`distrib` — The distribution descriptor.

`allocatable` — Specifies if the server is allocatable.

`user` — The user account used to run the server.

### Data Members

**string** `id`;

The server id.

**string** `exe`;

The path of the server executable.

**string** `iceVersion`;

The Ice version used by this server. This is only required if backward compatibility with servers using old Ice versions is needed (otherwise the registry will assume the server is using the same Ice version). For example "3.1.1", "3.2", "3.3.0".

**string** `pwd`;

The path to the server working directory.

[ "java:type:java.util.LinkedList<String>" ] **Ice::StringSeq** `options`;

The command line options to pass to the server executable.

[ "java:type:java.util.LinkedList<String>" ] **Ice::StringSeq** envs;

The server environment variables.

**string activation;**

The server activation mode (possible values are "on-demand" or "manual").

**string activationTimeout;**

The activation timeout (an integer value representing the number of seconds to wait for activation).

**string deactivationTimeout;**

The deactivation timeout (an integer value representing the number of seconds to wait for deactivation).

**bool applicationDistrib;**

Specifies if the server depends on the application distribution.

**IceGrid::DistributionDescriptor distrib;**

The distribution descriptor.

**bool allocatable;**

Specifies if the server is allocatable.

**string user;**

The user account used to run the server.

---

# IceGrid-ServerDynamicInfo

---

## IceGrid::ServerDynamicInfo

### Overview

#### struct ServerDynamicInfo

Dynamic information about the state of a server.

#### Used By

- [IceGrid::NodeObserver::updateServer](#)
- [IceGrid::ServerDynamicInfoSeq](#)

### Data Member Index

[id](#) — The id of the server.

[state](#) — The state of the server.

[pid](#) — The process id of the server.

[enabled](#) — Indicates whether the server is enabled.

### Data Members

#### string id;

The id of the server.

#### IceGrid::ServerState state;

The state of the server.

#### int pid;

The process id of the server.

#### bool enabled;

Indicates whether the server is enabled.

---



# IceGrid-ServerInfo

---

## IceGrid::ServerInfo

### Overview

#### struct ServerInfo

Information about a server managed by an IceGrid node.

#### Used By

- [IceGrid::Admin::getServerInfo](#)

### Data Member Index

[application](#) — The server application.

[uuid](#) — The application uuid.

[revision](#) — The application revision.

[node](#) — The server node.

[descriptor](#) — The server descriptor.

[sessionId](#) — The id of the session which allocated the server.

### Data Members

#### string application;

The server application.

#### string uuid;

The application uuid.

#### int revision;

The application revision.

#### string node;

The server node.

#### IceGrid::ServerDescriptor descriptor;

The server descriptor.

#### string sessionId;

The id of the session which allocated the server.

---

# IceGrid-ServerInstanceDescriptor

---

## IceGrid::ServerInstanceDescriptor

### Overview

[ "cpp:comparable" ] struct ServerInstanceDescriptor

A server template instance descriptor.

### Used By

- IceGrid::Admin::instantiateServer
- IceGrid::ServerInstanceDescriptorSeq

### Data Member Index

[template](#) — The template used by this instance.

[parameterValues](#) — The template parameter values.

[propertySet](#) — The property set.

[servicePropertySets](#) — The services property sets.

### Data Members

**string** [template](#);

The template used by this instance.

**IceGrid::StringStringDict** [parameterValues](#);

The template parameter values.

**IceGrid::PropertyDescriptor** [propertySet](#);

The property set.

**IceGrid::PropertyDescriptorDict** [servicePropertySets](#);

The services property sets. It's only valid to set these property sets if the template is an IceBox server template.

---

# IceGrid-ServerNotExistException

---

## IceGrid::ServerNotExistException

### Overview

#### exception ServerNotExistException

This exception is raised if a server does not exist.

#### *Used By*

- IceGrid::Admin::enableServer
- IceGrid::Admin::getServerAdmin
- IceGrid::Admin::getServerInfo
- IceGrid::Admin::getServerPid
- IceGrid::Admin::getServerState
- IceGrid::Admin::isServerEnabled
- IceGrid::Admin::patchServer
- IceGrid::Admin::sendSignal
- IceGrid::Admin::startServer
- IceGrid::Admin::stopServer
- IceGrid::Admin::writeMessage
- IceGrid::AdminSession::openServerLog
- IceGrid::AdminSession::openServerStdErr
- IceGrid::AdminSession::openServerStdOut

### Data Member Index

`id` — The identifier of the server.

### Data Members

`string id;`

The identifier of the server.

---

# IceGrid-ServerStartException

---

## IceGrid::ServerStartException

### Overview

exception `ServerStartException`

This exception is raised if a server failed to start.

### Used By

- `IceGrid::Admin::startServer`

### Data Member Index

`id` — The identifier of the server.

`reason` — The reason for the failure.

### Data Members

`string id;`

The identifier of the server.

`string reason;`

The reason for the failure.

---

# IceGrid-ServerState

---

## IceGrid::ServerState

### Overview

#### enum ServerState

An enumeration representing the state of the server.

#### Used By

- [Admin::getServerState](#)
- [ServerDynamicInfo::state](#)

### Enumerator Index

[Inactive](#) — The server is not running.

[Activating](#) — The server is being activated and will change to the active state when the registered server object adapters are activated or to the activation timed out state if the activation timeout expires.

[ActivationTimedOut](#) — The activation timed out state indicates that the server activation timed out.

[Active](#) — The server is running.

[Deactivating](#) — The server is being deactivated.

[Destroying](#) — The server is being destroyed.

[Destroyed](#) — The server is destroyed.

### Enumerators

#### Inactive

The server is not running.

#### Activating

The server is being activated and will change to the active state when the registered server object adapters are activated or to the activation timed out state if the activation timeout expires.

#### ActivationTimedOut

The activation timed out state indicates that the server activation timed out.

#### Active

The server is running.

#### Deactivating

The server is being deactivated.

#### Destroying

The server is being destroyed.

#### Destroyed

The server is destroyed.

---

# IceGrid-ServerStopException

---

## IceGrid::ServerStopException

### Overview

exception `ServerStopException`

This exception is raised if a server failed to stop.

### Used By

- `IceGrid::Admin::stopServer`

### Data Member Index

`id` — The identifier of the server.

`reason` — The reason for the failure.

### Data Members

`string id;`

The identifier of the server.

`string reason;`

The reason for the failure.

---

## IceGrid-ServerUnreachableException

---

### IceGrid::ServerUnreachableException

#### Overview

exception `ServerUnreachableException`

This exception is raised if a server could not be reached.

#### Data Member Index

`name` — The id of the server that is not reachable.

`reason` — The reason why the server couldn't be reached.

#### Data Members

**string name;**

The id of the server that is not reachable.

**string reason;**

The reason why the server couldn't be reached.

---

# IceGrid-ServiceDescriptor

---

## IceGrid::ServiceDescriptor

### Overview

class `ServiceDescriptor` extends `IceGrid::CommunicatorDescriptor`

An IceBox service descriptor.

### Used By

- `IceGrid::ServiceDescriptorSeq`
- `IceGrid::ServiceInstanceDescriptor::descriptor`

### Data Member Index

`name` — The service name.

`entry` — The entry point of the IceBox service.

### Data Members

`string name;`

The service name.

`string entry;`

The entry point of the IceBox service.

---



# IceGrid-ServiceInstanceDescriptor

---

## IceGrid::ServiceInstanceDescriptor

### Overview

**struct ServiceInstanceDescriptor**

A service template instance descriptor.

### Used By

- [IceGrid::ServiceInstanceDescriptorSeq](#)

### Data Member Index

[template](#) — The template used by this instance.

[parameterValues](#) — The template parameter values.

[descriptor](#) — The service definition if the instance isn't a template instance (i.e.: if the template attribute is empty).

[propertySet](#) — The property set.

### Data Members

**string** [template](#);

The template used by this instance.

**IceGrid::StringStringDict** [parameterValues](#);

The template parameter values.

**IceGrid::ServiceDescriptor** [descriptor](#);

The service definition if the instance isn't a template instance (i.e.: if the template attribute is empty).

**IceGrid::PropertySetDescriptor** [propertySet](#);

The property set.

---

# IceGrid-Session

---

## IceGrid::Session

### Overview

interface `Session` extends `Glacier2::Session`

A session object is used by IceGrid clients to allocate and release objects. Client sessions are either created with the `IceGrid::Registry` object or the registry client `Glacier2::SessionManager` object.

#### See Also

- `IceGrid::Registry`
- `Glacier2::SessionManager`

### Operation Index

`keepAlive` — Keep the session alive.

`allocateObjectById` — Allocate an object.

`allocateObjectByType` — Allocate an object with the given type.

`releaseObject` — Release an object.

`setAllocationTimeout` — Set the allocation timeout.

### Operations

#### `void keepAlive()`

Keep the session alive. Clients should call this operation regularly to prevent the server from reaping the session.

#### See Also

- `IceGrid::Registry::getSessionTimeout`

[ "amd" ] `Object*` `allocateObjectById(Ice::Identity id)` throws `IceGrid::ObjectNotRegisteredException`, `IceGrid::AllocationException`

Allocate an object. Depending on the allocation timeout, this operation might hang until the object is available or until the timeout is reached.

#### Parameters

`id` — The identity of the object to allocate.

#### Return Value

The proxy of the allocated object.

#### Exceptions

`IceGrid::ObjectNotRegisteredException` — Raised if the object with the given identity is not registered with the registry.

`IceGrid::AllocationException` — Raised if the object can't be allocated.

#### See Also

- `setAllocationTimeout`
- `releaseObject`

[ "amd" ] `Object*` `allocateObjectByType(string type)` throws `IceGrid::AllocationException`

Allocate an object with the given type. Depending on the allocation timeout, this operation can block until an object becomes available or until the timeout is reached.

**Parameters**

`type` — The type of the object.

**Return Value**

The proxy of the allocated object.

**Exceptions**

[IceGrid::ObjectNotRegisteredException](#) — Raised if no objects with the given type can be allocated.

[IceGrid::AllocationException](#) — Raised if the object could not be allocated.

**See Also**

- [setAllocationTimeout](#)
- [releaseObject](#)

**`void releaseObject(Ice::Identity id)` throws [IceGrid::ObjectNotRegisteredException](#), [IceGrid::AllocationException](#)**

Release an object.

**Parameters**

`id` — The identity of the object to release.

**Exceptions**

[IceGrid::ObjectNotRegisteredException](#) — Raised if the object with the given identity is not registered with the registry.

[IceGrid::AllocationException](#) — Raised if the given object can't be released. This might happen if the object isn't allocatable or isn't allocated by the session.

**See Also**

- [allocateObjectById](#)
- [allocateObjectByType](#)

**`void setAllocationTimeout(int timeout)`**

Set the allocation timeout. If no objects are available for an allocation request, the request will hang for the duration of this timeout.

**Parameters**

`timeout` — The timeout in milliseconds.

**See Also**

- [allocateObjectById](#)
- [allocateObjectByType](#)

# IceGrid-TemplateDescriptor

---

## IceGrid::TemplateDescriptor

### Overview

#### struct TemplateDescriptor

A template descriptor for server or service templates.

#### Used By

- [IceGrid::TemplateDescriptorDict](#)

### Data Member Index

[descriptor](#) — The template.

[parameters](#) — The parameters required to instantiate the template.

[parameterDefaults](#) — The parameters default values.

### Data Members

#### [IceGrid::CommunicatorDescriptor](#) descriptor;

The template.

#### [ "java:type:java.util.LinkedList<String>" ] [Ice::StringSeq](#) parameters;

The parameters required to instantiate the template.

#### [IceGrid::StringStringDict](#) parameterDefaults;

The parameters default values.

---

## IceGrid-UserAccountMapper

---

### IceGrid::UserAccountMapper

#### Overview

#### interface `UserAccountMapper`

A user account mapper object is used by IceGrid nodes to map session identifiers to user accounts.

#### Operation Index

`getUserAccount` — Get the name of the user account for the given user.

#### Operations

`string getUserAccount(string user)` throws `IceGrid::UserAccountNotFoundException`

Get the name of the user account for the given user. This is used by IceGrid nodes to figure out the user account to use to run servers.

#### *Parameters*

`user` — The value of the server descriptor's `user` attribute. If this attribute is not defined, and the server's activation mode is `session`, the default value of `user` is the session identifier.

#### *Return Value*

The user account name.

#### *Exceptions*

`IceGrid::UserAccountNotFoundException` — Raised if no user account is found for the given user.

---

## IceGrid-UserAccountNotFoundException

---

### IceGrid::UserAccountNotFoundException

#### Overview

exception `UserAccountNotFoundException`

This exception is raised if a user account for a given session identifier can't be found.

#### *Used By*

- `IceGrid::UserAccountMapper::getUserAccount`
-

# IceGrid-LoadSample

---

## IceGrid::LoadSample

### Overview

#### enum LoadSample

Determines which load sampling interval to use.

#### *Used By*

- [Query::findObjectByTypeOnLeastLoadedNode](#)

### Enumerator Index

[LoadSample1](#) — Sample every minute.

[LoadSample5](#) — Sample every five minutes.

[LoadSample15](#) — Sample every fifteen minutes.

### Enumerators

#### LoadSample1

Sample every minute.

#### LoadSample5

Sample every five minutes.

#### LoadSample15

Sample every fifteen minutes.

---

# Freeze Slice API

---

## Freeze

### Overview

#### module Freeze

Freeze provides automatic persistence for Ice servants.

### Interface Index

[BackgroundSaveEvictor](#) — A background-save evictor is an evictor that saves updates asynchronously in a background thread.

[Connection](#) — A connection to a database (database environment with Berkeley DB).

[Evictor](#) — An automatic Ice object persistence manager, based on the evictor pattern.

[EvictorIterator](#) — An iterator for the objects managed by the evictor.

[ServantInitializer](#) — A servant initializer provides the application with an opportunity to perform custom servant initialization.

[Transaction](#) — A transaction.

[TransactionalEvictor](#) — A transactional evictor is an evictor that performs every single read-write operation within its own transaction.

### Exception Index

[DatabaseException](#) — A Freeze database exception.

[DeadlockException](#) — A Freeze database deadlock exception.

[EvictorDeactivatedException](#) — This exception is raised if the evictor has been deactivated.

[IndexNotFoundException](#) — Exception raised when Freeze fails to locate an index.

[InvalidPositionException](#) — This Freeze Iterator is not on a valid position, for example this position has been erased.

[NoSuchElementException](#) — This exception is raised if there are no further elements in the iteration.

[NotFoundException](#) — A Freeze database exception, indicating that a database record could not be found.

[TransactionAlreadyInProgressException](#) — An attempt was made to start a transaction while a previous transaction has not yet been committed or rolled back.

### Structure Index

[CatalogData](#) — The catalog keeps information about Freeze Maps and Freeze evictors in a Berkeley Db environment.

[ObjectRecord](#) — ObjectRecord is the value-type for the persistent maps maintained by evictors when using Ice encoding version is 1.0.

[Statistics](#) — Evictors maintain statistics about each object, when using Ice encoding version 1.0.

### Sequence Index

[Key](#) — A database key, represented as a sequence of bytes.

[Value](#) — A database value, represented as a sequence of bytes.

### Sequences

#### sequence<byte> Key

A database key, represented as a sequence of bytes.

#### sequence<byte> Value

A database value, represented as a sequence of bytes.

---



# Freeze-BackgroundSaveEvictor

---

## Freeze::BackgroundSaveEvictor

### Overview

local interface `BackgroundSaveEvictor` extends `Freeze::Evictor`

A background-save evictor is an evictor that saves updates asynchronously in a background thread.

### Operation Index

`keep` — Lock this object in the evictor cache.

`keepFacet` — Like `keep`, but with a facet.

`release` — Release a lock acquired by `keep`.

`releaseFacet` — Like `release`, but with a facet.

### Operations

#### `void keep(Ice::Identity id)`

Lock this object in the evictor cache. This lock can be released by `release` or `remove`. `release` releases only one lock, while `remove` releases all the locks.

#### *Parameters*

`id` — The identity of the Ice object.

#### *Exceptions*

`Ice::NotRegisteredException` — Raised if this identity was not registered with the evictor.

`Freeze::DatabaseException` — Raised if a database failure occurred.

#### *See Also*

- `keepFacet`
- `release`
- `remove`

#### `void keepFacet(Ice::Identity id, string facet)`

Like `keep`, but with a facet. Calling `keep(id)` is equivalent to calling `keepFacet` with an empty facet.

#### *Parameters*

`id` — The identity of the Ice object.

`facet` — The facet. An empty facet means the default facet.

#### *Exceptions*

`Ice::NotRegisteredException` — Raised if this identity was not registered with the evictor.

`Freeze::DatabaseException` — Raised if a database failure occurred.

#### *See Also*

- `keep`
- `releaseFacet`
- `removeFacet`

**void release(Ice::Identity id)**

Release a lock acquired by [keep](#). Once all the locks on an object have been released, the object is again subject to the normal eviction strategy.

**Parameters**

`id` — The identity of the Ice object.

**Exceptions**

[Ice::NotRegisteredException](#) — Raised if this object was not locked with [keep](#) or [keepFacet](#).

**See Also**

- [keepFacet](#)
- [release](#)

**void releaseFacet(Ice::Identity id, string facet)**

Like [release](#), but with a facet. Calling `release(id)` is equivalent to calling [releaseFacet](#) with an empty facet.

**Parameters**

`id` — The identity of the Ice object.

`facet` — The facet. An empty facet means the default facet.

**Exceptions**

[Ice::NotRegisteredException](#) — Raised if this object was not locked with [keep](#) or [keepFacet](#).

**See Also**

- [keep](#)
  - [releaseFacet](#)
-

## Freeze-CatalogData

---

### Freeze::CatalogData

#### Overview

#### `struct CatalogData`

The catalog keeps information about Freeze Maps and Freeze evictors in a Berkeley Db environment. It is used by FreezeScript.

#### Data Member Index

`evictor` — True if this entry describes an evictor database, false if it describes a map database.

`key` — The Slice type for the database key.

`value` — The Slice type for the database value.

#### Data Members

##### `bool evictor;`

True if this entry describes an evictor database, false if it describes a map database.

##### `string key;`

The Slice type for the database key.

##### `string value;`

The Slice type for the database value.

---

# Freeze-Connection

---

## Freeze::Connection

### Overview

#### local interface Connection

A connection to a database (database environment with Berkeley DB). If you want to use a connection concurrently in multiple threads, you need to serialize access to this connection.

#### Used By

- [Freeze::Transaction::getConnection](#)

### Operation Index

[beginTransaction](#) — Create a new transaction.

[currentTransaction](#) — Returns the transaction associated with this connection.

[removeMapIndex](#) — Remove an old unused Freeze Map index @throws IndexNotFoundException Raised if this index does not exist

[close](#) — Closes this connection.

[getCommunicator](#) — Returns the communicator associated with this connection.

[getEncoding](#) — Returns the encoding version used to encode the data.

[getName](#) — The name of the connected system (for example, the Berkeley DB environment).

### Operations

#### Freeze::Transaction beginTransaction()

Create a new transaction. Only one transaction at a time can be associated with a connection.

#### Return Value

The new transaction.

#### Exceptions

[Freeze::TransactionAlreadyInProgressException](#) — Raised if a transaction is already associated with this connection.

#### Freeze::Transaction currentTransaction()

Returns the transaction associated with this connection.

#### Return Value

The current transaction if there is one, null otherwise.

#### void removeMapIndex(string mapName, string indexName)

Remove an old unused Freeze Map index

#### Exceptions

[Freeze::IndexNotFoundException](#) — Raised if this index does not exist

#### void close()

Closes this connection. If there is an associated transaction, it is rolled back.

**Ice::Communicator** `getCommunicator()`

Returns the communicator associated with this connection.

**Ice::EncodingVersion** `getEncoding()`

Returns the encoding version used to encode the data.

**string** `getName()`

The name of the connected system (for example, the Berkeley DB environment).

---

# Freeze-DatabaseException

---

## Freeze::DatabaseException

### Overview

local exception DatabaseException

A Freeze database exception.

#### *Derived Exceptions*

- [Freeze::DeadlockException](#)
- [Freeze::NotFoundException](#)

#### *See Also*

- [Freeze::Evictor](#)
- [Freeze::Connection](#)

### Data Member Index

[message](#) — A message describing the reason for the exception.

### Data Members

**string message;**

A message describing the reason for the exception.

---

## Freeze-DeadlockException

---

### Freeze::DeadlockException

#### Overview

local exception `DeadlockException` extends [Freeze::DatabaseException](#)

A Freeze database deadlock exception. Applications can react to this exception by aborting and trying the transaction again.

#### Data Member Index

`tx` — The transaction in which the deadlock occurred.

#### Data Members

[Freeze::Transaction](#) `tx`;

The transaction in which the deadlock occurred.

---

# Freeze-Evictor

---

## Freeze::Evictor

### Overview

local interface `Evictor` extends `Ice::ServantLocator`

An automatic Ice object persistence manager, based on the evictor pattern. The evictor is a servant locator implementation that stores the persistent state of its objects in a database. Any number of objects can be registered with an evictor, but only a configurable number of servants are active at a time. These active servants reside in a queue; the least recently used servant in the queue is the first to be evicted when a new servant is activated.

#### Derived Classes and Interfaces

- [Freeze::BackgroundSaveEvictor](#)
- [Freeze::TransactionalEvictor](#)

#### See Also

- [Freeze::ServantInitializer](#)

### Operation Index

`setSize` — Set the size of the evictor's servant queue.  
`getSize` — Get the size of the evictor's servant queue.  
`add` — Add a servant to this evictor.  
`addFacet` — Like `add`, but with a facet.  
`remove` — Permanently destroy an Ice object.  
`removeFacet` — Like `remove`, but with a facet.  
`hasObject` — Returns true if the given identity is managed by the evictor with the default facet.  
`hasFacet` — Like `hasObject`, but with a facet.  
`getIterator` — Get an iterator for the identities managed by the evictor.

### Operations

#### `void setSize(int sz)`

Set the size of the evictor's servant queue. This is the maximum number of servants the evictor keeps active. Requests to set the queue size to a value smaller than zero are ignored.

#### Parameters

`sz` — The size of the servant queue. If the evictor currently holds more than `sz` servants in its queue, it evicts enough servants to match the new size. Note that this operation can block if the new queue size is smaller than the current number of servants that are servicing requests. In this case, the operation waits until a sufficient number of servants complete their requests.

#### Exceptions

`Freeze::EvictorDeactivatedException` — Raised if a the evictor has been deactivated.

#### See Also

- `getSize`

#### `int getSize()`

Get the size of the evictor's servant queue.



**Return Value**

The size of the servant queue.

**Exceptions**

[Freeze::EvictorDeactivatedException](#) — Raised if a the evictor has been deactivated.

**See Also**

- [setSize](#)

**Object\* add(Object servant, Ice::Identity id)**

Add a servant to this evictor. The state of the servant passed to this operation will be saved in the evictor's persistent store.

**Parameters**

`servant` — The servant to add.

`id` — The identity of the Ice object that is implemented by the servant.

**Return Value**

A proxy that matches the given identity and this evictor's object adapter.

**Exceptions**

[Ice::AlreadyRegisteredException](#) — Raised if the evictor already has an object with this identity.

[Freeze::DatabaseException](#) — Raised if a database failure occurred.

[Freeze::EvictorDeactivatedException](#) — Raised if the evictor has been deactivated.

**See Also**

- [addFacet](#)
- [remove](#)
- [removeFacet](#)

**Object\* addFacet(Object servant, Ice::Identity id, string facet)**

Like [add](#), but with a facet. Calling `add(servant, id)` is equivalent to calling [addFacet](#) with an empty facet.

**Parameters**

`servant` — The servant to add.

`id` — The identity of the Ice object that is implemented by the servant.

`facet` — The facet. An empty facet means the default facet.

**Return Value**

A proxy that matches the given identity and this evictor's object adapter.

**Exceptions**

[Ice::AlreadyRegisteredException](#) — Raised if the evictor already has an object with this identity.

[Freeze::DatabaseException](#) — Raised if a database failure occurred.

[Freeze::EvictorDeactivatedException](#) — Raised if the evictor has been deactivated.

**See Also**

- [add](#)
- [remove](#)

- [removeFacet](#)

### Object `remove(Ice::Identity id)`

Permanently destroy an Ice object.

#### **Parameters**

`id` — The identity of the Ice object.

#### **Return Value**

The removed servant.

#### **Exceptions**

[Ice::NotRegisteredException](#) — Raised if this identity was not registered with the evictor.

[Freeze::DatabaseException](#) — Raised if a database failure occurred.

[Freeze::EvictorDeactivatedException](#) — Raised if the evictor has been deactivated.

#### **See Also**

- [add](#)
- [removeFacet](#)

### Object `removeFacet(Ice::Identity id, string facet)`

Like [remove](#), but with a facet. Calling `remove(id)` is equivalent to calling [removeFacet](#) with an empty facet.

#### **Parameters**

`id` — The identity of the Ice object.

`facet` — The facet. An empty facet means the default facet.

#### **Return Value**

The removed servant.

#### **Exceptions**

[Ice::NotRegisteredException](#) — Raised if this identity was not registered with the evictor.

[Freeze::DatabaseException](#) — Raised if a database failure occurred.

[Freeze::EvictorDeactivatedException](#) — Raised if the evictor has been deactivated.

#### **See Also**

- [remove](#)
- [addFacet](#)

### bool `hasObject(Ice::Identity id)`

Returns true if the given identity is managed by the evictor with the default facet.

#### **Return Value**

true if the identity is managed by the evictor, false otherwise.

#### **Exceptions**

[Freeze::DatabaseException](#) — Raised if a database failure occurred.

[Freeze::EvictorDeactivatedException](#) — Raised if a the evictor has been deactivated.

**bool hasFacet(Ice::Identity id, string facet)**

Like `hasObject`, but with a facet. Calling `hasObject(id)` is equivalent to calling `hasFacet` with an empty facet.

**Return Value**

true if the identity is managed by the evictor for the given facet, false otherwise.

**Exceptions**

`Freeze::DatabaseException` — Raised if a database failure occurred.

`Freeze::EvictorDeactivatedException` — Raised if a the evictor has been deactivated.

**Freeze::EvictorIterator getIterator(string facet, int batchSize)**

Get an iterator for the identities managed by the evictor.

**Parameters**

`facet` — The facet. An empty facet means the default facet.

`batchSize` — Internally, the Iterator retrieves the identities in batches of size `batchSize`. Selecting a small `batchSize` can have an adverse effect on performance.

**Return Value**

A new iterator.

**Exceptions**

`Freeze::EvictorDeactivatedException` — Raised if a the evictor has been deactivated.

---

## Freeze-EvictorDeactivatedException

---

### Freeze::EvictorDeactivatedException

#### Overview

local exception `EvictorDeactivatedException`

This exception is raised if the evictor has been deactivated.

---

# Freeze-EvictorIterator

---

## Freeze::EvictorIterator

### Overview

#### local interface EvictorIterator

An iterator for the objects managed by the evictor. Note that an EvictorIterator is not thread-safe: the application needs to serialize access to a given EvictorIterator, for example by using it in just one thread.

#### Used By

- [Freeze::Evictor::getIterator](#)

#### See Also

- [Freeze::Evictor](#)

### Operation Index

[hasNext](#) — Determines if the iteration has more elements.

[next](#) — Obtains the next identity in the iteration.

### Operations

#### bool hasNext()

Determines if the iteration has more elements.

#### Return Value

True if the iterator has more elements, false otherwise.

#### Exceptions

[Freeze::DatabaseException](#) — Raised if a database failure occurs while retrieving a batch of objects.

#### Ice::Identity next()

Obtains the next identity in the iteration.

#### Return Value

The next identity in the iteration.

#### Exceptions

[Freeze::NoSuchElementException](#) — Raised if there is no further elements in the iteration.

[Freeze::DatabaseException](#) — Raised if a database failure occurs while retrieving a batch of objects.

---

## Freeze-IndexNotFoundException

---

### Freeze::IndexNotFoundException

#### Overview

local exception `IndexNotFoundException`

Exception raised when Freeze fails to locate an index.

#### Data Member Index

`mapName` — The name of the map in which the index could not be found.

`indexName` — The name of the index.

#### Data Members

`string mapName;`

The name of the map in which the index could not be found.

`string indexName;`

The name of the index.

---

## Freeze-InvalidPositionException

---

### Freeze::InvalidPositionException

#### Overview

local exception `InvalidPositionException`

This Freeze Iterator is not on a valid position, for example this position has been erased.

---

## Freeze-NoSuchElementException

---

### Freeze::NoSuchElementException

#### Overview

local exception `NoSuchElementException`

This exception is raised if there are no further elements in the iteration.

---



## Freeze-NotFoundException

---

### Freeze::NotFoundException

#### Overview

local exception `NotFoundException` extends [Freeze::DatabaseException](#)

A Freeze database exception, indicating that a database record could not be found.

---

## Freeze-ObjectRecord

---

### Freeze::ObjectRecord

#### Overview

#### `struct ObjectRecord`

ObjectRecord is the value-type for the persistent maps maintained by evictors when using Ice encoding version is 1.0.

#### Data Member Index

`servant` — The servant implementing the object.

`stats` — The statistics for the object.

#### Data Members

##### Object servant;

The servant implementing the object.

##### Freeze::Statistics stats;

The statistics for the object.

---

# Freeze-ServantInitializer

---

## Freeze::ServantInitializer

### Overview

#### local interface `ServantInitializer`

A servant initializer provides the application with an opportunity to perform custom servant initialization.

#### See Also

- [Freeze::Evictor](#)

### Operation Index

`initialize` — Called whenever the evictor creates a new servant.

### Operations

`void initialize(Ice::ObjectAdapter adapter, Ice::Identity identity, string facet, Object servant)`

Called whenever the evictor creates a new servant. This operation allows application code to perform custom servant initialization after the servant has been created by the evictor and its persistent state has been restored.

#### Parameters

`adapter` — The object adapter in which the evictor is installed.

`identity` — The identity of the Ice object for which the servant was created.

`facet` — The facet. An empty facet means the default facet.

`servant` — The servant to initialize.

#### See Also

- [Ice::Identity](#)
-

## Freeze-Statistics

---

### Freeze::Statistics

#### Overview

#### struct Statistics

Evictors maintain statistics about each object, when using Ice encoding version 1.0.

#### Used By

- [Freeze::ObjectRecord::stats](#)

#### Data Member Index

[creationTime](#) — The time the object was created, in milliseconds since Jan 1, 1970 0:00.  
[lastSaveTime](#) — The time the object was last saved, in milliseconds relative to [creationTime](#).  
[avgSaveTime](#) — The average time between saves, in milliseconds.

#### Data Members

##### long creationTime;

The time the object was created, in milliseconds since Jan 1, 1970 0:00.

##### long lastSaveTime;

The time the object was last saved, in milliseconds relative to [creationTime](#).

##### long avgSaveTime;

The average time between saves, in milliseconds.

---

# Freeze-Transaction

---

## Freeze::Transaction

### Overview

#### local interface Transaction

A transaction. If you want to use a transaction concurrently in multiple threads, you need to serialize access to this transaction.

#### *Used By*

- [Freeze::Connection::beginTransaction](#)
- [Freeze::Connection::currentTransaction](#)
- [Freeze::DeadlockException::tx](#)
- [Freeze::TransactionalEvictor::getCurrentTransaction](#)
- [Freeze::TransactionalEvictor::setCurrentTransaction](#)

### Operation Index

[commit](#) — Commit this transaction.

[rollback](#) — Roll back this transaction.

[getConnection](#) — Get the connection associated with this Transaction

### Operations

#### **void commit()**

Commit this transaction.

#### *Exceptions*

[Freeze::DatabaseException](#) — Raised if a database failure occurred.

#### **void rollback()**

Roll back this transaction.

#### *Exceptions*

[Freeze::DatabaseException](#) — Raised if a database failure occurred.

#### **Freeze::Connection getConnection()**

Get the connection associated with this Transaction

---

## Freeze-TransactionalEvictor

---

### Freeze::TransactionalEvictor

#### Overview

local interface `TransactionalEvictor` extends `Freeze::Evictor`

A transactional evictor is an evictor that performs every single read-write operation within its own transaction.

#### Operation Index

`getCurrentTransaction` — Get the transaction associated with the calling thread.

`setCurrentTransaction` — Associate a transaction with the calling thread.

#### Operations

##### `Freeze::Transaction` `getCurrentTransaction()`

Get the transaction associated with the calling thread.

##### *Return Value*

The transaction associated with the calling thread.

##### `void` `setCurrentTransaction(Freeze::Transaction tx)`

Associate a transaction with the calling thread.

##### *Parameters*

`tx` — The transaction to associate with the calling thread.

---

## Freeze-TransactionAlreadyInProgressException

---

### Freeze::TransactionAlreadyInProgressException

#### Overview

local exception `TransactionAlreadyInProgressException`

An attempt was made to start a transaction while a previous transaction has not yet been committed or rolled back.

---

# IceSSL Slice API

---

## IceSSL

### Overview

#### module IceSSL

IceSSL provides a secure transport for Ice.

### Class Index

[ConnectionInfo](#) — Provides access to the connection details of an SSL connection

[EndpointInfo](#) — Provides access to an SSL endpoint information.

### Constant Index

[EndpointType](#) — Uniquely identifies SSL endpoints.

### Constants

**const short EndpointType = 2;**

Uniquely identifies SSL endpoints.

---



## IceSSL-ConnectionInfo

---

### IceSSL::ConnectionInfo

#### Overview

local class `ConnectionInfo` extends `Ice::IPConnectionInfo`

Provides access to the connection details of an SSL connection

#### Data Member Index

`cipher` — The negotiated cipher suite.

`certs` — The certificate chain.

#### Data Members

`string cipher;`

The negotiated cipher suite.

`Ice::StringSeq certs;`

The certificate chain.

---

## IceSSL-EndpointInfo

---

### IceSSL::EndpointInfo

#### Overview

local class `EndpointInfo` extends `Ice::IPEndpointInfo`

Provides access to an SSL endpoint information.

---

# Glacier2 Slice API

---

## Glacier2

### Overview

#### module Glacier2

Glacier2 is a firewall solution for Ice. Glacier2 authenticates and filters client requests and allows callbacks to the client in a secure fashion. In combination with IceSSL, Glacier2 provides a security solution that is both non-intrusive and easy to configure.

### Interface Index

[IdentitySet](#) — An object for managing the set of object identity constraints on a [Session](#).

[PermissionsVerifier](#) — The Glacier2 permissions verifier.

[Router](#) — The Glacier2 specialization of the [Ice::Router](#) interface.

[SSLPermissionsVerifier](#) — The SSL Glacier2 permissions verifier.

[SSLSessionManager](#) — The session manager for SSL authenticated users that is responsible for managing [Session](#) objects.

[Session](#) — A client-visible session object, which is tied to the lifecycle of a [Router](#).

[SessionControl](#) — An administrative session control object, which is tied to the lifecycle of a [Session](#).

[SessionManager](#) — The session manager for username/password authenticated users that is responsible for managing [Session](#) objects.

[StringSet](#) — An object for managing the set of identity constraints for specific parts of object identity on a [Session](#).

### Exception Index

[CannotCreateSessionException](#) — This exception is raised if an attempt to create a new session failed.

[PermissionDeniedException](#) — This exception is raised if a client is denied the ability to create a session with the router.

[SessionNotExistException](#) — This exception is raised if a client tries to destroy a session with a router, but no session exists for the client.

### Structure Index

[SSLInfo](#) — Information taken from an SSL connection used for permissions verification.

---

## Glacier2-Admin

---

### Glacier2::Admin

#### Overview

#### interface Admin

The Glacier2 administrative interface. This must only be accessible from inside the firewall.

#### Operation Index

`shutdown` — Shut down the Glacier2 router.

#### Operations

#### `void shutdown()`

Shut down the Glacier2 router.

---

## Glacier2-CannotCreateSessionException

---

### Glacier2::CannotCreateSessionException

#### Overview

[ "preserve-slice" ] exception `CannotCreateSessionException`

This exception is raised if an attempt to create a new session failed.

#### *Used By*

- `Glacier2::Router::createSessionFromSecureConnection`
- `Glacier2::Router::createSession`
- `Glacier2::SSLSessionManager::create`
- `Glacier2::SessionManager::create`

#### *See Also*

- `Glacier2::Router::createSession`
- `Glacier2::Router::createSessionFromSecureConnection`
- `Glacier2::SessionManager::create`
- `Glacier2::SSLSessionManager::create`

#### Data Member Index

`reason` — The reason why session creation has failed.

#### Data Members

`string reason;`

The reason why session creation has failed.

---

# Glacier2-SSLSessionManager

---

## Glacier2::SSLSessionManager

### Overview

#### interface SSLSessionManager

The session manager for SSL authenticated users that is responsible for managing [Glacier2::Session](#) objects. New session objects are created by the [Glacier2::Router](#) object calling on an application-provided session manager. If no session manager is provided by the application, no client-visible sessions are passed to the client.

#### See Also

- [Glacier2::Router](#)
- [Glacier2::Session](#)

### Operation Index

[create](#) — Create a new session.

### Operations

[ "format:sliced" ] [Glacier2::Session\\*](#) [create](#)([Glacier2::SSLInfo](#) info, [Glacier2::SessionControl\\*](#) control) throws [Glacier2::CannotCreateSessionException](#)

Create a new session.

#### Parameters

`info` — The SSL info.

`control` — A proxy to the session control object.

#### Return Value

A proxy to the newly created session.

#### Exceptions

[Glacier2::CannotCreateSessionException](#) — Raised if the session cannot be created.

---

# Glacier2-IdentitySet

---

## Glacier2::IdentitySet

### Overview

#### interface IdentitySet

An object for managing the set of object identity constraints on a [Glacier2::Session](#).

#### See Also

- [Glacier2::Session](#)
- [Glacier2::SessionControl](#)

### Operation Index

[add](#) — Add a sequence of Ice identities to this set of constraints.

[remove](#) — Remove a sequence of identities from this set of constraints.

[get](#) — Returns a sequence of identities describing the constraints in this set.

### Operations

#### void add(Ice::IdentitySeq additions)

Add a sequence of Ice identities to this set of constraints. Order is not preserved and duplicates are implicitly removed.

#### Parameters

`additions` — The sequence of Ice identities to be added.

#### void remove(Ice::IdentitySeq deletions)

Remove a sequence of identities from this set of constraints. No errors are returned if an entry is not found.

#### Parameters

`deletions` — The sequence of Ice identities to be removed.

#### Ice::IdentitySeq get()

Returns a sequence of identities describing the constraints in this set.

#### Return Value

The sequence of Ice identities for this set.

---

# Glacier2-PermissionDeniedException

---

## Glacier2::PermissionDeniedException

### Overview

[ "preserve-slice" ] exception `PermissionDeniedException`

This exception is raised if a client is denied the ability to create a session with the router.

### Used By

- `Glacier2::PermissionsVerifier::checkPermissions`
- `Glacier2::Router::createSessionFromSecureConnection`
- `Glacier2::Router::createSession`
- `Glacier2::SSLPermissionsVerifier::authorize`

### See Also

- `Glacier2::Router::createSession`
- `Glacier2::Router::createSessionFromSecureConnection`

### Data Member Index

`reason` — The reason why permission was denied.

### Data Members

`string reason;`

The reason why permission was denied.

---



# Glacier2-PermissionsVerifier

---

## Glacier2::PermissionsVerifier

### Overview

#### interface PermissionsVerifier

The Glacier2 permissions verifier. This is called through the process of establishing a session.

#### See Also

- [Glacier2::Router](#)

### Operation Index

[checkPermissions](#) — Check whether a user has permission to access the router.

### Operations

[ "nonmutating", "format:sliced" ] bool [checkPermissions](#)(string userId, string password, out string reason) throws [Glacier2::PermissionDeniedException](#)

Check whether a user has permission to access the router.

#### Parameters

`userId` — The user id for which to check permission.

`password` — The user's password.

`reason` — The reason why access was denied.

#### Return Value

True if access is granted, or false otherwise.

#### Exceptions

[Glacier2::PermissionDeniedException](#) — Raised if the user access is denied. This can be raised in place of returning false with a reason set in the reason out parameter.

---

# Glacier2-Router

---

## Glacier2::Router

### Overview

interface Router extends [Ice::Router](#)

The Glacier2 specialization of the [Ice::Router](#) interface.

### Operation Index

[getCategoryForClient](#) — This category must be used in the identities of all of the client's callback objects.

[createSession](#) — Create a per-client session with the router.

[createSessionFromSecureConnection](#) — Create a per-client session with the router.

[refreshSession](#) — Keep the calling client's session with this router alive.

[destroySession](#) — Destroy the calling client's session with this router.

[getSessionTimeout](#) — Get the value of the session timeout.

### Operations

[ "nonmutating" ] string [getCategoryForClient\(\)](#)

This category must be used in the identities of all of the client's callback objects. This is necessary in order for the router to forward callback requests to the intended client. If the Glacier2 server endpoints are not set, the returned category is an empty string.

#### Return Value

The category.

[ "amd", "format:sliced" ] [Glacier2::Session\\*](#) [createSession\(string userId, string password\)](#) throws [Glacier2::PermissionDeniedException](#), [Glacier2::CannotCreateSessionException](#)

Create a per-client session with the router. If a [Glacier2::SessionManager](#) has been installed, a proxy to a [Glacier2::Session](#) object is returned to the client. Otherwise, null is returned and only an internal session (i.e., not visible to the client) is created. If a session proxy is returned, it must be configured to route through the router that created it. This will happen automatically if the router is configured as the client's default router at the time the session proxy is created in the client process, otherwise the client must configure the session proxy explicitly.

#### Parameters

`userId` — The user id for which to check the password.

`password` — The password for the given user id.

#### Return Value

A proxy for the newly created session, or null if no [Glacier2::SessionManager](#) has been installed.

#### Exceptions

[Glacier2::PermissionDeniedException](#) — Raised if the password for the given user id is not correct, or if the user is not allowed access.

[Glacier2::CannotCreateSessionException](#) — Raised if the session cannot be created.

#### See Also

- [Glacier2::Session](#)
- [Glacier2::SessionManager](#)
- [Glacier2::PermissionsVerifier](#)

[ "amd", "format:sliced" ] **Glacier2::Session\*** `createSessionFromSecureConnection()` throws **Glacier2::PermissionDeniedException**, **Glacier2::CannotCreateSessionException**

Create a per-client session with the router. The user is authenticated through the SSL certificates that have been associated with the connection. If a `Glacier2::SessionManager` has been installed, a proxy to a `Glacier2::Session` object is returned to the client. Otherwise, null is returned and only an internal session (i.e., not visible to the client) is created. If a session proxy is returned, it must be configured to route through the router that created it. This will happen automatically if the router is configured as the client's default router at the time the session proxy is created in the client process, otherwise the client must configure the session proxy explicitly.

**Return Value**

A proxy for the newly created session, or null if no `Glacier2::SessionManager` has been installed.

**Exceptions**

`Glacier2::PermissionDeniedException` — Raised if the user cannot be authenticated or if the user is not allowed access.  
`Glacier2::CannotCreateSessionException` — Raised if the session cannot be created.

**See Also**

- `Glacier2::Session`
- `Glacier2::SessionManager`
- `Glacier2::PermissionsVerifier`

**void refreshSession() throws Glacier2::SessionNotExistException**

Keep the calling client's session with this router alive.

**Exceptions**

`Glacier2::SessionNotExistException` — Raised if no session exists for the calling client.

**void destroySession() throws Glacier2::SessionNotExistException**

Destroy the calling client's session with this router.

**Exceptions**

`Glacier2::SessionNotExistException` — Raised if no session exists for the calling client.

[ "nonmutating" ] **long getSessionTimeout()**

Get the value of the session timeout. Sessions are destroyed if they see no activity for this period of time.

**Return Value**

The timeout (in seconds).

---

# Glacier2-Session

---

## Glacier2::Session

### Overview

#### interface Session

A client-visible session object, which is tied to the lifecycle of a [Glacier2::Router](#).

#### *Derived Classes and Interfaces*

- [IceGrid::AdminSession](#)
- [IceGrid::Session](#)

#### *See Also*

- [Glacier2::Router](#)
- [Glacier2::SessionManager](#)

### Operation Index

[destroy](#) — Destroy the session.

### Operations

#### void [destroy\(\)](#)

Destroy the session. This is called automatically when the [Glacier2::Router](#) is destroyed.

---

# Glacier2-SessionControl

---

## Glacier2::SessionControl

### Overview

#### interface SessionControl

An administrative session control object, which is tied to the lifecycle of a [Glacier2::Session](#).

#### See Also

- [Glacier2::Session](#)

### Operation Index

[categories](#) — Access the object that manages the allowable categories for object identities for this session.

[adapterIds](#) — Access the object that manages the allowable adapter identities for objects for this session.

[identities](#) — Access the object that manages the allowable object identities for this session.

[getSessionTimeout](#) — Get the session timeout.

[destroy](#) — Destroy the associated session.

### Operations

#### **Glacier2::StringSet\*** categories()

Access the object that manages the allowable categories for object identities for this session.

#### **Return Value**

A StringSet object.

#### **Glacier2::StringSet\*** adapterIds()

Access the object that manages the allowable adapter identities for objects for this session.

#### **Return Value**

A StringSet object.

#### **Glacier2::IdentitySet\*** identities()

Access the object that manages the allowable object identities for this session.

#### **Return Value**

An IdentitySet object.

#### **int** getSessionTimeout()

Get the session timeout.

#### **Return Value**

The timeout.

#### **void** destroy()

Destroy the associated session.



# Glacier2-SessionManager

---

## Glacier2::SessionManager

### Overview

#### interface SessionManager

The session manager for username/password authenticated users that is responsible for managing [Glacier2::Session](#) objects. New session objects are created by the [Glacier2::Router](#) object calling on an application-provided session manager. If no session manager is provided by the application, no client-visible sessions are passed to the client.

#### See Also

- [Glacier2::Router](#)
- [Glacier2::Session](#)

### Operation Index

[create](#) — Create a new session.

### Operations

[ "format:sliced" ] [Glacier2::Session](#)\* [create](#)(string [userId](#), [Glacier2::SessionControl](#)\* [control](#)) throws [Glacier2::CannotCreateSessionException](#)

Create a new session.

#### Parameters

[userId](#) — The user id for the session.

[control](#) — A proxy to the session control object.

#### Return Value

A proxy to the newly created session.

#### Exceptions

[Glacier2::CannotCreateSessionException](#) — Raised if the session cannot be created.

---

## Glacier2-SessionNotExistException

---

### Glacier2::SessionNotExistException

#### Overview

exception `SessionNotExistException`

This exception is raised if a client tries to destroy a session with a router, but no session exists for the client.

#### *Used By*

- [Glacier2::Router::destroySession](#)
- [Glacier2::Router::refreshSession](#)

#### *See Also*

- [Glacier2::Router::destroySession](#)
-



## Glacier2-SSLInfo

---

### Glacier2::SSLInfo

#### Overview

#### struct SSLInfo

Information taken from an SSL connection used for permissions verification.

#### Used By

- [Glacier2::SSLPermissionsVerifier::authorize](#)
- [Glacier2::SSLSessionManager::create](#)

#### See Also

- [Glacier2::PermissionsVerifier](#)

#### Data Member Index

[remoteHost](#) — The remote host.

[remotePort](#) — The remote port.

[localHost](#) — The router's host.

[localPort](#) — The router's port.

[cipher](#) — The negotiated cipher suite.

[certs](#) — The certificate chain.

#### Data Members

**string remoteHost;**

The remote host.

**int remotePort;**

The remote port.

**string localHost;**

The router's host.

**int localPort;**

The router's port.

**string cipher;**

The negotiated cipher suite.

**Ice::StringSeq certs;**

The certificate chain.

---

# Glacier2-SSLPermissionsVerifier

---

## Glacier2::SSLPermissionsVerifier

### Overview

#### interface SSLPermissionsVerifier

The SSL Glacier2 permissions verifier. This is called through the process of establishing a session.

#### See Also

- [Glacier2::Router](#)

### Operation Index

`authorize` — Check whether a user has permission to access the router.

### Operations

[ "nonmutating", "format:sliced" ] bool `authorize(Glacier2::SSLInfo info, out string reason)` throws [Glacier2::PermissionDeniedException](#)

Check whether a user has permission to access the router.

#### Parameters

`info` — The SSL information.

`reason` — The reason why access was denied.

#### Return Value

True if access is granted, or false otherwise.

#### Exceptions

[Glacier2::PermissionDeniedException](#) — Raised if the user access is denied. This can be raised in place of returning false with a reason set in the reason out parameter.

#### See Also

- [Glacier2::SSLInfo](#)
-

# Glacier2-StringSet

---

## Glacier2::StringSet

### Overview

#### interface StringSet

An object for managing the set of identity constraints for specific parts of object identity on a [Glacier2::Session](#).

#### See Also

- [Glacier2::Session](#)
- [Glacier2::SessionControl](#)

### Operation Index

[add](#) — Add a sequence of strings to this set of constraints.

[remove](#) — Remove a sequence of strings from this set of constraints.

[get](#) — Returns a sequence of strings describing the constraints in this set.

### Operations

#### void add(Ice::StringSeq additions)

Add a sequence of strings to this set of constraints. Order is not preserved and duplicates are implicitly removed.

#### Parameters

`additions` — The sequence of strings to be added.

#### void remove(Ice::StringSeq deletions)

Remove a sequence of strings from this set of constraints. No errors are returned if an entry is not found.

#### Parameters

`deletions` — The sequence of strings to be removed.

#### Ice::StringSeq get()

Returns a sequence of strings describing the constraints in this set.

#### Return Value

The sequence of strings for this set.

---

# IceBox Slice API

---

## IceBox

### Overview

#### module IceBox

IceBox is an application server specifically for Ice applications. IceBox can easily run and administer Ice services that are dynamically loaded as a DLL, shared library, or Java class.

### Interface Index

[Service](#) — An application service managed by a [ServiceManager](#).

[ServiceManager](#) — Administers a set of [Service](#) instances.

[ServiceObserver](#) — An Observer interface implemented by admin clients interested in the status of services @see [ServiceManager](#)

### Exception Index

[AlreadyStartedException](#) — This exception is thrown if an attempt is made to start an already-started service.

[AlreadyStoppedException](#) — This exception is thrown if an attempt is made to stop an already-stopped service.

[FailureException](#) — This exception is a general failure notification.

[NoSuchServiceException](#) — This exception is thrown if a service name does not refer to an existing service.

---

## IceBox-AlreadyStoppedException

---

### IceBox::AlreadyStoppedException

#### Overview

exception `AlreadyStoppedException`

This exception is thrown if an attempt is made to stop an already-stopped service.

#### *Used By*

- `IceBox::ServiceManager::stopService`
-

## IceBox-AlreadyStartedException

---

### IceBox::AlreadyStartedException

#### Overview

exception `AlreadyStartedException`

This exception is thrown if an attempt is made to start an already-started service.

#### *Used By*

- `IceBox::ServiceManager::startService`
-

# IceBox-ServiceManager

---

## IceBox::ServiceManager

### Overview

#### interface ServiceManager

Administers a set of [IceBox::Service](#) instances.

#### See Also

- [IceBox::Service](#)

### Operation Index

[getSliceChecksums](#) — Returns the checksums for the IceBox Slice definitions.

[startService](#) — Start an individual service.

[stopService](#) — Stop an individual service.

[addObserver](#) — Registers a new observer with the ServiceManager.

[shutdown](#) — Shut down all services.

### Operations

#### [ "nonmutating" ] [Ice::SliceChecksumDict](#) [getSliceChecksums\(\)](#)

Returns the checksums for the IceBox Slice definitions.

#### Return Value

A dictionary mapping Slice type ids to their checksums.

#### **void startService(string service) throws [IceBox::AlreadyStartedException](#), [IceBox::NoSuchServiceException](#)**

Start an individual service.

#### Parameters

`service` — The service name.

#### **void stopService(string service) throws [IceBox::AlreadyStoppedException](#), [IceBox::NoSuchServiceException](#)**

Stop an individual service.

#### Parameters

`service` — The service name.

#### **void addObserver([IceBox::ServiceObserver](#)\* observer)**

Registers a new observer with the ServiceManager.

#### Parameters

`observer` — The new observer

#### **void shutdown()**

Shut down all services. This causes [IceBox::Service::stop](#) to be invoked on all configured services.





# IceBox-FailureException

---

## IceBox::FailureException

### Overview

#### local exception FailureException

This exception is a general failure notification. It is thrown for errors such as a service encountering an error during initialization, or the service manager being unable to load a service executable.

### Data Member Index

`reason` — The reason for the failure.

### Data Members

`string reason;`

The reason for the failure.

---

## IceBox-NoSuchServiceException

---

### IceBox::NoSuchServiceException

#### Overview

#### exception NoSuchServiceException

This exception is thrown if a service name does not refer to an existing service.

#### *Used By*

- [IceBox::ServiceManager::startService](#)
  - [IceBox::ServiceManager::stopService](#)
-

# IceBox-Service

---

## IceBox::Service

### Overview

#### local interface Service

An application service managed by a [IceBox::ServiceManager](#).

### Operation Index

`start` — Start the service.

`stop` — Stop the service.

### Operations

**void start(string name, [Ice::Communicator](#) communicator, [Ice::StringSeq](#) args)**

Start the service. The given communicator is created by the [IceBox::ServiceManager](#) for use by the service. This communicator may also be used by other services, depending on the service configuration.

*The [IceBox::ServiceManager](#) owns this communicator, and is responsible for destroying it.*

#### Parameters

`name` — The service's name, as determined by the configuration.

`communicator` — A communicator for use by the service.

`args` — The service arguments that were not converted into properties.

#### Exceptions

[IceBox::FailureException](#) — Raised if `start` failed.

**void stop()**

Stop the service.

---

## IceBox-ServiceObserver

---

### IceBox::ServiceObserver

#### Overview

#### interface ServiceObserver

An Observer interface implemented by admin clients interested in the status of services

#### See Also

- [IceBox::ServiceManager](#)

#### Operation Index

[servicesStarted](#)  
[servicesStopped](#)

#### Operations

**void servicesStarted(Ice::StringSeq services)**

**void servicesStopped(Ice::StringSeq services)**

---

# IceStorm Slice API

---

## IceStorm

### Overview

#### module IceStorm

A messaging service with support for federation. In contrast to most other messaging or event services, IceStorm supports typed events, meaning that broadcasting a message over a federation is as easy as invoking a method on an interface.

### Interface Index

[Topic](#) — Publishers publish information on a particular topic.

[TopicManager](#) — A topic manager manages topics, and subscribers to topics.

### Exception Index

[AlreadySubscribed](#) — This exception indicates that an attempt was made to subscribe a proxy for which a subscription already exists.

[BadQoS](#) — This exception indicates that a subscription failed due to an invalid QoS.

[LinkExists](#) — This exception indicates that an attempt was made to create a link that already exists.

[NoSuchLink](#) — This exception indicates that an attempt was made to remove a link that does not exist.

[NoSuchTopic](#) — This exception indicates that an attempt was made to retrieve a topic that does not exist.

[TopicExists](#) — This exception indicates that an attempt was made to create a topic that already exists.

### Structure Index

[LinkInfo](#) — Information on the topic links.

### Sequence Index

[LinkInfoSeq](#) — A sequence of [LinkInfo](#) objects.

### Dictionary Index

[QoS](#) — This dictionary represents quality of service parameters.

[TopicDict](#) — Mapping of topic name to topic proxy.

### Sequences

#### sequence<[LinkInfo](#)> [LinkInfoSeq](#)

A sequence of [LinkInfo](#) objects.

#### Used By

- [Topic::getLinkInfoSeq](#)

### Dictionaries

#### dictionary<string, string> [QoS](#)

This dictionary represents quality of service parameters.

**Used By**

- `Topic::subscribeAndGetPublisher`
- `Topic::subscribe`

**See Also**

- `Topic::subscribe`

**dictionary<string, Topic\*> TopicDict**

Mapping of topic name to topic proxy.

**Used By**

- `TopicManager::retrieveAll`
-

## IceStorm-BadQoS

---

### IceStorm::BadQoS

#### Overview

#### exception BadQoS

This exception indicates that a subscription failed due to an invalid QoS.

#### *Used By*

- [IceStorm::Topic::subscribeAndGetPublisher](#)

#### Data Member Index

`reason` — The reason for the failure.

#### Data Members

`string reason;`

The reason for the failure.

---

## IceStorm-AlreadySubscribed

---

### IceStorm::AlreadySubscribed

#### Overview

#### exception AlreadySubscribed

This exception indicates that an attempt was made to subscribe a proxy for which a subscription already exists.

#### *Used By*

- [IceStorm::Topic::subscribeAndGetPublisher](#)
-



## IceStorm-LinkExists

---

### IceStorm::LinkExists

#### Overview

#### exception LinkExists

This exception indicates that an attempt was made to create a link that already exists.

#### *Used By*

- [IceStorm::Topic::link](#)

#### Data Member Index

`name` — The name of the linked topic.

#### Data Members

`string name;`

The name of the linked topic.

---

## IceStorm-LinkInfo

---

### IceStorm::LinkInfo

#### Overview

#### struct LinkInfo

Information on the topic links.

#### Used By

- [IceStorm::LinkInfoSeq](#)

#### Data Member Index

[theTopic](#) — The linked topic.

[name](#) — The name of the linked topic.

[cost](#) — The cost of traversing this link.

#### Data Members

**IceStorm::Topic\*** [theTopic](#);

The linked topic.

**string** [name](#);

The name of the linked topic.

**int** [cost](#);

The cost of traversing this link.

---

## IceStorm-NoSuchTopic

---

### IceStorm::NoSuchTopic

#### Overview

#### exception NoSuchTopic

This exception indicates that an attempt was made to retrieve a topic that does not exist.

#### *Used By*

- [IceStorm::TopicManager::retrieve](#)

#### Data Member Index

`name` — The name of the topic that does not exist.

#### Data Members

`string name;`

The name of the topic that does not exist.

---

# IceStorm-Topic

---

## IceStorm::Topic

### Overview

#### interface Topic

Publishers publish information on a particular topic. A topic logically represents a type.

#### See Also

- [IceStorm::TopicManager](#)

### Operation Index

[getName](#) — Get the name of this topic.

[getPublisher](#) — Get a proxy to a publisher object for this topic.

[getNonReplicatedPublisher](#) — Get a non-replicated proxy to a publisher object for this topic.

[subscribe](#) — Subscribe with the given `qos` to this topic. (*Deprecated*)

[subscribeAndGetPublisher](#) — Subscribe with the given `qos` to this topic.

[unsubscribe](#) — Unsubscribe the given `subscriber`.

[link](#) — Create a link to the given topic.

[unlink](#) — Destroy the link from this topic to the given topic `linkTo`.

[getLinkInfoSeq](#) — Retrieve information on the current links.

[getSubscribers](#) — Retrieve the list of subscribers for this topic.

[destroy](#) — Destroy the topic.

### Operations

#### [ "nonmutating" ] string getName()

Get the name of this topic.

#### Return Value

The name of the topic.

#### See Also

- [IceStorm::TopicManager::create](#)

#### [ "nonmutating" ] Object\* getPublisher()

Get a proxy to a publisher object for this topic. To publish data to a topic, the publisher calls [getPublisher](#) and then casts to the topic type. An unchecked cast must be used on this proxy. If a replicated IceStorm deployment is used this call may return a replicated proxy.

#### Return Value

A proxy to publish data on this topic.

#### [ "nonmutating" ] Object\* getNonReplicatedPublisher()

Get a non-replicated proxy to a publisher object for this topic. To publish data to a topic, the publisher calls [getPublisher](#) and then casts to the topic type. An unchecked cast must be used on this proxy.

#### Return Value

A proxy to publish data on this topic.

**void subscribe(IceStorm::QoS theQoS, Object\* subscriber)**

Subscribe with the given `qos` to this topic. If the given `subscriber` proxy has already been registered, it will be replaced. Note that this can cause a loss of events to the subscribed object.

*This operation is deprecated as of version 3.2.*

*subscribe is deprecated, use subscribeAndGetPublisher instead*

**Parameters**

`theQoS` — The quality of service parameters for this subscription.  
`subscriber` — The subscriber's proxy.

**Return Value**

The per-subscriber publisher object.

**See Also**

- [unsubscribe](#)

**Object\* subscribeAndGetPublisher(IceStorm::QoS theQoS, Object\* subscriber) throws IceStorm::AlreadySubscribed, IceStorm::BadQoS**

Subscribe with the given `qos` to this topic. A per-subscriber publisher object is returned.

**Parameters**

`theQoS` — The quality of service parameters for this subscription.  
`subscriber` — The subscriber's proxy.

**Return Value**

The per-subscriber publisher object.

**Exceptions**

[IceStorm::AlreadySubscribed](#) — Raised if the subscriber object is already subscribed.  
[IceStorm::BadQoS](#) — Raised if the requested quality of service is unavailable or invalid.

**See Also**

- [unsubscribe](#)

**void unsubscribe(Object\* subscriber)**

Unsubscribe the given `subscriber`.

**Parameters**

`subscriber` — The proxy of an existing subscriber.

**See Also**

- [subscribe](#)

**void link(IceStorm::Topic\* linkTo, int cost) throws IceStorm::LinkExists**

Create a link to the given topic. All events originating on this topic will also be sent to `linkTo`.

**Parameters**

`linkTo` — The topic to link to.

`cost` — The cost to the linked topic.

**Exceptions**

`IceStorm::LinkExists` — Raised if a link to the same topic already exists.

**`void unlink(IceStorm::Topic* linkTo)` throws `IceStorm::NoSuchLink`**

Destroy the link from this topic to the given topic `linkTo`.

**Parameters**

`linkTo` — The topic to destroy the link to.

**Exceptions**

`IceStorm::NoSuchLink` — Raised if a link to the topic does not exist.

**[ "nonmutating" ] `IceStorm::LinkInfoSeq` `getLinkInfoSeq()`**

Retrieve information on the current links.

**Return Value**

A sequence of `LinkInfo` objects.

**[ "nonmutating" ] `Ice::IdentitySeq` `getSubscribers()`**

Retrieve the list of subscribers for this topic.

**Return Value**

The sequence of Ice identities for the subscriber objects.

**`void destroy()`**

Destroy the topic.

---

## IceStorm-NoSuchLink

---

### IceStorm::NoSuchLink

#### Overview

#### exception NoSuchLink

This exception indicates that an attempt was made to remove a link that does not exist.

#### *Used By*

- [IceStorm::Topic::unlink](#)

#### Data Member Index

`name` — The name of the link that does not exist.

#### Data Members

`string name;`

The name of the link that does not exist.

---

## IceStorm-TopicExists

---

### IceStorm::TopicExists

#### Overview

#### exception TopicExists

This exception indicates that an attempt was made to create a topic that already exists.

#### *Used By*

- [IceStorm::TopicManager::create](#)

#### Data Member Index

`name` — The name of the topic that already exists.

#### Data Members

`string name;`

The name of the topic that already exists.

---



# IceStorm-TopicManager

---

## IceStorm::TopicManager

### Overview

#### interface TopicManager

A topic manager manages topics, and subscribers to topics.

#### See Also

- [IceStorm::Topic](#)

### Operation Index

[create](#) — Create a new topic.

[retrieve](#) — Retrieve a topic by name.

[retrieveAll](#) — Retrieve all topics managed by this topic manager.

[getSliceChecksums](#) — Returns the checksums for the IceStorm Slice definitions.

### Operations

#### **IceStorm::Topic\*** [create](#)(string name) throws **IceStorm::TopicExists**

Create a new topic. The topic name must be unique, otherwise [IceStorm::TopicExists](#) is raised.

#### **Parameters**

name — The name of the topic.

#### **Return Value**

A proxy to the topic instance.

#### **Exceptions**

[IceStorm::TopicExists](#) — Raised if a topic with the same name already exists.

#### [ "nonmutating" ] **IceStorm::Topic\*** [retrieve](#)(string name) throws **IceStorm::NoSuchTopic**

Retrieve a topic by name.

#### **Parameters**

name — The name of the topic.

#### **Return Value**

A proxy to the topic instance.

#### **Exceptions**

[IceStorm::NoSuchTopic](#) — Raised if the topic does not exist.

#### [ "nonmutating" ] **IceStorm::TopicDict** [retrieveAll](#)()

Retrieve all topics managed by this topic manager.

***Return Value***

A dictionary of string, topic proxy pairs.

[ "nonmutating" ] **Ice::SliceChecksumDict** `getSliceChecksums()`

Returns the checksums for the IceStorm Slice definitions.

***Return Value***

A dictionary mapping Slice type ids to their checksums.

---

# IcePatch2 Slice API

---

## IcePatch2

### Overview

#### module IcePatch2

IcePatch can be used to update file hierarchies in a simple and efficient manner. Checksums ensure file integrity, and data is compressed before download.

### Interface Index

[FileServer](#) — The interface that provides access to files.

### Exception Index

[FileAccessException](#) — This exception is raised if [FileServer::getFileCompressed](#) cannot read the contents of a file.

[PartitionOutOfRangeException](#) — The `partition` argument for [FileServer::getFileInfoSeq](#) was not in the range 0-255.

### Structure Index

[FileInfo](#) — Basic information about a single file.

### Sequence Index

[ByteSeqSeq](#) — A sequence of byte sequences.

[FileInfoSeq](#) — A sequence with information about many files.

## Sequences

### sequence<[Ice::ByteSeq](#)> ByteSeqSeq

A sequence of byte sequences. Each element is the checksum for a partition.

#### Used By

- [FileServer::getChecksumSeq](#)

### sequence<[FileInfo](#)> FileInfoSeq

A sequence with information about many files.

#### Used By

- [FileServer::getFileInfoSeq](#)
-

## IcePatch2-Admin

---

### IcePatch2::Admin

#### Overview

#### interface Admin

The IcePatch administrative interface. This must only be accessible from inside the firewall.

#### Operation Index

[shutdown](#) — Shut down the IcePatch server.

#### Operations

#### void shutdown()

Shut down the IcePatch server.

---

## IcePatch2-FileAccessException

---

### IcePatch2::FileAccessException

#### Overview

exception `FileAccessException`

This exception is raised if `IcePatch2::FileServer::getFileCompressed` cannot read the contents of a file.

#### *Used By*

- `IcePatch2::FileServer::getFileCompressed`

#### Data Member Index

`reason` — An explanation of the reason for the failure.

#### Data Members

`string reason;`

An explanation of the reason for the failure.

---

# IcePatch2-FileInfo

---

## IcePatch2::FileInfo

### Overview

#### struct FileInfo

Basic information about a single file.

#### Used By

- [IcePatch2::FileInfoSeq](#)

### Data Member Index

[path](#) — The pathname.

[checksum](#) — The SHA-1 checksum of the file.

[size](#) — The size of the compressed file in number of bytes.

[executable](#) — The executable flag.

### Data Members

#### string path;

The pathname.

#### Ice::ByteSeq checksum;

The SHA-1 checksum of the file.

#### int size;

The size of the compressed file in number of bytes.

#### bool executable;

The executable flag.

---

# IcePatch2-FileServer

---

## IcePatch2::FileServer

### Overview

#### interface FileServer

The interface that provides access to files.

### Operation Index

`getFileInfoSeq` — Return the `IcePatch2::FileInfoSeq` for the specified partition.

`getChecksumSeq` — Return the checksums for all partitions.

`getChecksum` — Return the master checksum for all partitions.

`getFileCompressed` — Read the specified file.

### Operations

[ "nonmutating" ] `IcePatch2::FileInfoSeq` `getFileInfoSeq(int partition)` throws `IcePatch2::PartitionOutOfRangeException`

Return the `IcePatch2::FileInfoSeq` for the specified partition. If the partition number is out of range, the operation throws `PartitionOutOfRangeException`.

#### Parameters

`partition` — The partition number in the range 0-255.

#### Return Value

A sequence containing the `IcePatch2::FileInfo` structures for files in the specified partition.

[ "nonmutating" ] `IcePatch2::ByteSeqSeq` `getChecksumSeq()`

Return the checksums for all partitions.

#### Return Value

A sequence containing 256 checksums. Partitions with a checksum that differs from the previous checksum for the same partition contain updated files. Partitions with a checksum that is identical to the previous checksum do not contain updated files.

[ "nonmutating" ] `Ice::ByteSeq` `getChecksum()`

Return the master checksum for all partitions. If this checksum is the same as for a previous run, the entire file set is up-to-date.

#### Return Value

The master checksum for the file set.

[ "amd", "nonmutating", "cpp:array" ] `Ice::ByteSeq` `getFileCompressed(string path, int pos, int num)` throws `IcePatch2::FileAccessException`

Read the specified file. If the read operation fails, the operation throws `IcePatch2::FileAccessException`. This operation may only return fewer bytes than requested in case there was an end-of-file condition.

#### Parameters

`path` — The pathname (relative to the data directory) for the file to be read.

`pos` — The file offset at which to begin reading.  
`num` — The number of bytes to be read.

***Return Value***

A sequence containing the compressed file contents.

---



## IcePatch2-PartitionOutOfRangeException

---

### IcePatch2::PartitionOutOfRangeException

#### Overview

exception `PartitionOutOfRangeException`

The `partition` argument for `IcePatch2::FileServer::getFileInfoSeq` was not in the range 0-255.

#### Used By

- `IcePatch2::FileServer::getFileInfoSeq`
-

# IceMX Slice API

---

## IceMX

### Overview

#### module IceMX

The Ice Management eXtension facility. It provides the [MetricsAdmin](#) interface for management clients to retrieve metrics from Ice applications.

### Class Index

[ConnectionMetrics](#) — Provides information on the data sent and received over Ice connections.

[DispatchMetrics](#) — Provides information on servant dispatch.

[InvocationMetrics](#) — Provide measurements for proxy invocations.

[Metrics](#) — The base class for metrics.

[RemoteMetrics](#) — Provides information on invocations that are specifically sent over Ice connections.

[SessionMetrics](#) — Provides information on Glacier2 sessions.

[SubscriberMetrics](#) — Provides information on IceStorm subscribers.

[ThreadMetrics](#) — Provides information on the number of threads currently in use and their activity.

[TopicMetrics](#) — Provides information on IceStorm topics.

### Interface Index

[MetricsAdmin](#) — The metrics administrative facet interface.

### Exception Index

[UnknownMetricsView](#) — Raised if a metrics view cannot be found.

### Structure Index

[MetricsFailures](#) — A structure to keep track of failures associated with a given metrics.

### Sequence Index

[MetricsFailuresSeq](#) — A sequence of [MetricsFailures](#).

[MetricsMap](#) — A metrics map is a sequence of metrics.

### Dictionary Index

[MetricsView](#) — A metrics view is a dictionary of metrics map.

[StringIntDict](#) — A dictionary of strings to integers.

### Sequences

#### sequence<[MetricsFailures](#)> [MetricsFailuresSeq](#)

A sequence of [MetricsFailures](#).

#### Used By

- [MetricsAdmin::getMapMetricsFailures](#)

### **sequence<Metrics> MetricsMap**

A metrics map is a sequence of metrics. We use a sequence here instead of a map because the ID of the metrics is already included in the Metrics class and using sequences of metrics objects is more efficient than using dictionaries since lookup is not necessary.

#### **Used By**

- [InvocationMetrics::remotes](#)
- [MetricsView](#)

## **Dictionaries**

### **dictionary<string, MetricsMap> MetricsView**

A metrics view is a dictionary of metrics map. The key of the dictionary is the name of the metrics map.

#### **Used By**

- [MetricsAdmin::getMetricsView](#)

### **dictionary<string, int> StringIntDict**

A dictionary of strings to integers.

#### **Used By**

- [MetricsFailures::failures](#)
-

## IceMX-ConnectionMetrics

---

### IceMX::ConnectionMetrics

#### Overview

class `ConnectionMetrics` extends `IceMX::Metrics`

Provides information on the data sent and received over Ice connections.

#### Data Member Index

`receivedBytes` — The number of bytes received by the connection.

`sentBytes` — The number of bytes sent by the connection.

#### Data Members

`long receivedBytes;`

The number of bytes received by the connection.

`long sentBytes;`

The number of bytes sent by the connection.

---

## IceMX-DispatchMetrics

---

### IceMX::DispatchMetrics

#### Overview

class `DispatchMetrics` extends `IceMX::Metrics`

Provides information on servant dispatch.

#### Data Member Index

`userException` — The number of dispatch that failed with a user exception.

`size` — The size of the dispatch.

`replySize` — The size of the dispatch reply.

#### Data Members

`int userException;`

The number of dispatch that failed with a user exception.

`long size;`

The size of the dispatch. This corresponds to the size of the marshalled input parameters.

`long replySize;`

The size of the dispatch reply. This corresponds to the size of the marshalled output and return parameters.

---

# IceMX-InvocationMetrics

---

## IceMX::InvocationMetrics

### Overview

class `InvocationMetrics` extends `IceMX::Metrics`

Provide measurements for proxy invocations. Proxy invocations can either be sent over the wire or be collocated. The metrics for invocations sent over the wire are specifically measured with `IceMX::RemoteMetrics`.

### Data Member Index

`retry` — The number of retries for the invocation(s).  
`userException` — The number of invocations that failed with a user exception.  
`remotes` — The remote invocation metrics map.

### Data Members

`int retry;`

The number of retries for the invocation(s).

`int userException;`

The number of invocations that failed with a user exception.

`IceMX::MetricsMap remotes;`

The remote invocation metrics map.

### See Also

- `IceMX::RemoteMetrics`
-

# IceMX-Metrics

---

## IceMX::Metrics

### Overview

#### class Metrics

The base class for metrics. A metrics object represents a collection of measurements associated to a given a system.

#### *Derived Classes and Interfaces*

- [IceMX::ConnectionMetrics](#)
- [IceMX::DispatchMetrics](#)
- [IceMX::InvocationMetrics](#)
- [IceMX::RemoteMetrics](#)
- [IceMX::SessionMetrics](#)
- [IceMX::SubscriberMetrics](#)
- [IceMX::ThreadMetrics](#)
- [IceMX::TopicMetrics](#)

#### *Used By*

- [IceMX::MetricsMap](#)

### Data Member Index

[id](#) — The metrics identifier.

[total](#) — The total number of objects that were observed by this metrics.

[current](#) — The current number of objects observed by this metrics.

[totalLifetime](#) — The sum of the lifetime of each observed objects.

[failures](#) — The number of failures observed.

### Data Members

**string id;**

The metrics identifier.

**long total;**

The total number of objects that were observed by this metrics.

**int current;**

The current number of objects observed by this metrics.

**long totalLifetime;**

The sum of the lifetime of each observed objects. This does not include the lifetime of objects which are currently observed.

**int failures;**

The number of failures observed.

---

# IceMX-MetricsAdmin

---

## IceMX::MetricsAdmin

### Overview

[ "format:sliced" ] interface **MetricsAdmin**

The metrics administrative facet interface. This interface allows remote administrative clients to access metrics of an application that enabled the Ice administrative facility and configured some metrics views.

### Operation Index

[getMetricsViewNames](#) — Get the names of enabled and disabled metrics.

[enableMetricsView](#) — Enables a metrics view.

[disableMetricsView](#) — Disable a metrics view.

[getMetricsView](#) — Get the metrics objects for the given metrics view.

[getMapMetricsFailures](#) — Get the metrics failures associated with the given view and map.

[getMetricsFailures](#) — Get the metrics failure associated for the given metrics.

### Operations

**Ice::StringSeq** [getMetricsViewNames](#)(out **Ice::StringSeq** disabledViews)

Get the names of enabled and disabled metrics.

#### Parameters

disabledViews — The names of the disabled views.

#### Return Value

The name of the enabled views.

**void** [enableMetricsView](#)(string name) throws **IceMX::UnknownMetricsView**

Enables a metrics view.

#### Parameters

name — The metrics view name.

#### Exceptions

**IceMX::UnknownMetricsView** — Raised if the metrics view cannot be found.

**void** [disableMetricsView](#)(string name) throws **IceMX::UnknownMetricsView**

Disable a metrics view.

#### Parameters

name — The metrics view name.

#### Exceptions

**IceMX::UnknownMetricsView** — Raised if the metrics view cannot be found.

**IceMX::MetricsView** [getMetricsView](#)(string view, out long timestamp) throws **IceMX::UnknownMetricsView**



Get the metrics objects for the given metrics view. This returns a dictionary of metric maps for each metrics class configured with the view. The timestamp allows the client to compute averages which are not dependent of the invocation latency for this operation.

**Parameters**

`view` — The name of the metrics view.

`timestamp` — The local time of the process when the metrics object were retrieved.

**Return Value**

The metrics view data.

**Exceptions**

`IceMX::UnknownMetricsView` — Raised if the metrics view cannot be found.

**IceMX::MetricsFailuresSeq** `getMapMetricsFailures(string view, string map)` throws `IceMX::UnknownMetricsView`

Get the metrics failures associated with the given view and map.

**Parameters**

`view` — The name of the metrics view.

`map` — The name of the metrics map.

**Return Value**

The metrics failures associated with the map.

**Exceptions**

`IceMX::UnknownMetricsView` — Raised if the metrics view cannot be found.

**IceMX::MetricsFailures** `getMetricsFailures(string view, string map, string id)` throws `IceMX::UnknownMetricsView`

Get the metrics failure associated for the given metrics.

**Parameters**

`view` — The name of the metrics view.

`map` — The name of the metrics map.

`id` — The ID of the metrics.

**Return Value**

The metrics failures associated with the metrics.

**Exceptions**

`IceMX::UnknownMetricsView` — Raised if the metrics view cannot be found.

## IceMX-MetricsFailures

---

### IceMX::MetricsFailures

#### Overview

#### struct MetricsFailures

A structure to keep track of failures associated with a given metrics.

#### Used By

- [IceMX::MetricsAdmin::getMetricsFailures](#)
- [IceMX::MetricsFailuresSeq](#)

#### Data Member Index

[id](#) — The identifier of the metrics object associated to the failures.

[failures](#) — The failures observed for this metrics.

#### Data Members

**string id;**

The identifier of the metrics object associated to the failures.

**IceMX::StringIntDict failures;**

The failures observed for this metrics.

---

## IceMX-RemoteMetrics

---

### IceMX::RemoteMetrics

#### Overview

class `RemoteMetrics` extends `IceMX::Metrics`

Provides information on invocations that are specifically sent over Ice connections. Remote metrics are embedded within `IceMX::InvocationMetrics`.

#### Data Member Index

`size` — The size of the invocation.

`replySize` — The size of the invocation reply.

#### Data Members

`long size;`

The size of the invocation. This corresponds to the size of the marshalled input parameters.

`long replySize;`

The size of the invocation reply. This corresponds to the size of the marshalled output and return parameters.

---

## IceMX-SessionMetrics

---

### IceMX::SessionMetrics

#### Overview

class `SessionMetrics` extends `IceMX::Metrics`

Provides information on Glacier2 sessions.

#### Data Member Index

`forwardedClient` — Number of client requests forwarded.  
`forwardedServer` — Number of server requests forwarded.  
`routingTableSize` — The size of the routing table.  
`queuedClient` — Number of client requests queued.  
`queuedServer` — Number of server requests queued.  
`overriddenClient` — Number of client requests overridden.  
`overriddenServer` — Number of server requests overridden.

#### Data Members

**int forwardedClient;**

Number of client requests forwarded.

**int forwardedServer;**

Number of server requests forwarded.

**int routingTableSize;**

The size of the routing table.

**int queuedClient;**

Number of client requests queued.

**int queuedServer;**

Number of server requests queued.

**int overriddenClient;**

Number of client requests overridden.

**int overriddenServer;**

Number of server requests overridden.

---

## IceMX-SubscriberMetrics

---

### IceMX::SubscriberMetrics

#### Overview

class `SubscriberMetrics` extends `IceMX::Metrics`

Provides information on IceStorm subscribers.

#### Data Member Index

`queued` — Number of queued events.

`outstanding` — Number of outstanding events.

`delivered` — Number of forwarded events.

#### Data Members

**int** `queued`;

Number of queued events.

**int** `outstanding`;

Number of outstanding events.

**long** `delivered`;

Number of forwarded events.

---

## IceMX-ThreadMetrics

---

### IceMX::ThreadMetrics

#### Overview

class `ThreadMetrics` extends `IceMX::Metrics`

Provides information on the number of threads currently in use and their activity.

#### Data Member Index

`inUseForIO` — The number of threads which are currently performing socket read or writes.

`inUseForUser` — The number of threads which are currently calling user code (servant dispatch, AMI callbacks, etc).

`inUseForOther` — The number of threads which are currently performing other activities.

#### Data Members

`int inUseForIO;`

The number of threads which are currently performing socket read or writes.

`int inUseForUser;`

The number of threads which are currently calling user code (servant dispatch, AMI callbacks, etc).

`int inUseForOther;`

The number of threads which are currently performing other activities. These are all other that are not counted with `inUseForUser` or `inUseForIO`, such as DNS lookups, garbage collection).

---

## IceMX-TopicMetrics

---

### IceMX::TopicMetrics

#### Overview

class `TopicMetrics` extends `IceMX::Metrics`

Provides information on IceStorm topics.

#### Data Member Index

`published` — Number of events published on the topic by publishers.

`forwarded` — Number of events forwarded on the topic by IceStorm topic links.

#### Data Members

`long published;`

Number of events published on the topic by publishers.

`long forwarded;`

Number of events forwarded on the topic by IceStorm topic links.

---

## IceMX-UnknownMetricsView

---

### IceMX::UnknownMetricsView

#### Overview

exception `UnknownMetricsView`

Raised if a metrics view cannot be found.

#### *Used By*

- `IceMX::MetricsAdmin::disableMetricsView`
  - `IceMX::MetricsAdmin::enableMetricsView`
  - `IceMX::MetricsAdmin::getMapMetricsFailures`
  - `IceMX::MetricsAdmin::getMetricsFailures`
  - `IceMX::MetricsAdmin::getMetricsView`
-



# Release Notes

The release notes provide information about an Ice release, including descriptions of significant new features and changes, instructions for upgrading from an earlier release, and important platform-specific details.

## Topics

- [New Features in Ice 3.5](#)
- [Encoding Changes in Ice 3.5](#)
- [Upgrading your Application from Ice 3.5.0](#)
- [Upgrading your Application from Ice 3.4](#)
- [Upgrading your Application from Ice 3.3](#)
- [Upgrading your Application from Ice 3.2 or Earlier Releases](#)
- [Platform Notes for Ice 3.5](#)
- [Known Problems in Ice 3.5](#)
- [Using the Windows Binary Distribution](#)
- [Using the Linux Binary Distributions](#)
- [Using the OS X Binary Distribution](#)
- [Using the Solaris Binary Distribution](#)
- [Sample Programs](#)
- [Building Ice from Source](#)

## New Features in Ice 3.5

This page describes significant changes and improvements in Ice 3.5 that may affect the operation of your applications or have an impact on your source code. For a detailed list of the changes in this release, please refer to the `CHANGES` file included in your Ice distribution.

On this page:

- [SOCKS v4 proxies](#)
- [Improved IceGrid database replication](#)
- [New encoding version](#)
- [Metrics facility](#)
- [Optional data members and parameters](#)
- [Compact encoding for classes and exceptions](#)
- [Compact type IDs](#)
- [Preserved slices](#)
- [Custom enumerator values](#)
- [C++11 lambda functions](#)
- [Remote Update of Server Properties](#)
- [IPv6 now enabled by default](#)
- [Windows 8 and Windows RT](#)
- [Silverlight](#)
- [Python 3](#)
- [Ruby 1.9](#)

### SOCKS v4 proxies

Ice 3.5.1 adds support for SOCKS v4 proxies, which allows outgoing Ice connections to be routed through your organization's SOCKS v4-compatible proxy service. This feature is supported in C++, Java, .NET, and the scripting languages, but is not supported under WinRT. The new properties `Ice.SOCKSProxyHost` and `Ice.SOCKSProxyPort` identify the host and port of the proxy service, respectively.

### Improved IceGrid database replication

As of Ice 3.5.1, IceGrid now performs a check when a slave registry connects to the master to prevent the slave's database from being overwritten if it contains more recent updates than the master database. For example, this situation could occur if you promote a slave with an out-of-date database to be the new master, if you restart a master with a database from an old backup, or if you restart a master with an empty database. In all of these cases, the slave's connection to the master will now be rejected and its database preserved. This check only works if both the IceGrid master and slave use Ice 3.5.1.

To correct the situation and allow the slave to connect successfully with the master, you can either update the master database to match the slave or, if you choose to discard the more recent updates recorded by the slave, you can update the slave database to match the master.

The new command-line option `--initdb-from-replica=<replica>` allows you to initialize a registry database from a given replica.

### New encoding version

Ice 3.5 introduces version 1.1 of the [Ice encoding](#), which is necessary to support several of the new features in this release.



The encoding from Ice 3.5b is not compatible with the 1.1 encoding from Ice 3.5.0. If you are still using Ice 3.5b, you should upgrade all your applications to Ice 3.5.0; a client or server using 3.5b will not interoperate with Ice 3.5.0 when using the 1.1 encoding.

### Metrics facility

Ice applications can now be [instrumented](#) to give remote administrative tools access to detailed metrics about the application's activity, including request success and failure rates, thread utilization, connection establishment, DNS lookups, and throughput.

Administrators can define custom views to monitor specific metrics of interest and minimize impact on the target application. A filtering and grouping mechanism enables easily monitoring specific Ice components and specify the level of detail for monitoring those objects. It is for example possible to only monitor the connections of a given object adapter. You can also decide to monitor the connections of this object adapter individually or group them based on some attributes of the connection such as the remote host of the connection or its protocol.

Using the IceGrid graphical administrative client, you can dynamically inspect deployed applications and create graphs of their activity in real time.

The Metrics facility is also supported by the Glacier2 and IceStorm services enabling monitoring Glacier2 sessions, IceStorm topics and subscribers.

## Optional data members and parameters

To simplify the task of enhancing an Ice application over time, Slice classes and exceptions can now declare [optional data members](#), and Slice interfaces can now define operations with [optional parameters](#). The new syntax for this feature is quite simple:

Slice
<pre>class Account {     string accountNo;     ...     optional(1) string guardian;     optional(2) string linkedAccountNo; };  interface Bank {     Account createAccount(string name, optional(3) string guardian,     ...); };</pre>

Each optional member or parameter must be assigned a unique integer identifier. Ice only marshals an optional member or parameter if a value is supplied, and the receiver can test to determine whether a value is set.

Despite the simple changes in syntax, the [implications for application developers](#) are significant. It is now possible to add or remove optional data members and parameters and deploy a new version of an application without affecting backward compatibility with existing deployments.

## Compact encoding for classes and exceptions

The [marshaled format](#) of Slice classes and exceptions now uses a new *compact* format by default that consumes much less space than in previous releases. The *sliced* format, which provides similar functionality to the original encoding, can still be enabled using a configuration property or metadata directive. When using the compact format, the receiver must know the most-derived type of the value; this new encoding does not include the information necessary for the receiver to "slice" the value to a known less-derived type. If your application requires this feature, you must use the sliced format instead.

## Compact type IDs

You can now optionally associate a numeric identifier with a class. The Ice run time substitutes this value, known as a *compact type ID*, in place of its equivalent [string type ID](#) during marshaling to conserve space. The compact type ID follows immediately after the class name, enclosed in parentheses:

Slice
<pre>class CompactExample(4) {     // ... };</pre>

## Preserved slices

A limitation in version 1.0 of the Ice encoding makes it cumbersome for an intermediary server to forward an instance of a Slice class or exception from one peer to another. The intermediary must know all of the derived types that it could potentially encounter, otherwise the Ice run time in the intermediary would "slice" the value to a known less-derived type and consequently interfere with the data exchange. Ideally, the intermediary should only be required to know the base types, while still being capable of forwarding unknown derived types between the peers without slicing.

Version 1.1 of the Ice encoding adds the ability to transfer classes and exceptions with [all of their slices intact](#) using the new metadata tag `preserve-slice`. This feature can only be used with the new sliced encoding format.

## Custom enumerator values

The Slice syntax for enumerations now allows you to specify [custom values](#) for enumerators:

Slice
<pre>enum Color {     red = 10,     green, // Automatically assigned value 11     blue = 15 };</pre>

## C++11 lambda functions

With a supported compiler, Ice 3.5 allows you to use C++11 lambda functions for [AMI](#) and [dispatcher](#) callbacks. This feature is enabled by default for Visual Studio 2010 SP1 and Visual Studio 2012 in the Ice installer for Windows and for the C++11 libraries in the Ice installer for OS X. For all other platforms and compilers, Ice must be recompiled with C++11 support enabled.

## Remote Update of Server Properties

You can now use the Ice.Admin [Properties facet](#) to update a server's Ice properties remotely. IceGrid leverages this new feature by allowing you to update a server's properties *without restart*: the server gets the new properties from IceGrid and you decide if or when to restart your server.

## IPv6 now enabled by default

The support for IPv6 is now enabled by default. A server listening on the [wildcard address](#) will accept both IPv4 and IPv6 TCP/IP connections by default (except for Windows XP and Windows 2003 which do not support a dual stack IP implementation). When resolving hostnames, for backward compatibility, Ice will still prefer using the IPv4 address when the hostname resolves to both an IPv4 and an IPv6 address. This behavior can be changed with the new [Ice.PreferIPv6Address](#) property.

## Windows 8 and Windows RT

Windows 8 and Windows RT are now fully supported platforms.

In addition, Ice 3.5 supports the WinRT API to enable building Windows Store applications.

Ice 3.5 compiled to target the WinRT API has some limitations compared to the regular Windows version. The following features are not available:

- Protocol compression
- Per-thread implicit contexts
- Server-side SSL
- Client SSL certificates
- IceBox server
- IcePatch2 client library
- `Ice::Service`, `Ice::Application` and `Glacier2::Application` classes
- Accessing properties from Windows registry
- `ICE_CONFIG` environment variable

The Ice installer for Windows includes a Visual Studio SDK for WinRT (with static libraries for the x86, x86\_64 and ARM architectures). The Ice Visual Studio Add-in automatically references this SDK for WinRT projects.

## Silverlight

Ice 3.5 includes support for Silverlight, which was previously offered as a ZeroC Labs project. Limitations in the Silverlight API mean that some features of Ice for .NET are unavailable when using [Ice for Silverlight](#).

## Python 3

The Ice extension for Python adds support for Python 3.x while still maintaining compatibility with 2.x. The minimum supported version is now Python 2.6.

The Ice extension included in the Ice installer for Windows requires Python 3.3.

The binary distributions for Linux and Mac include a Python extension that was built against (and requires) the default Python version for that platform. To use the Ice extension with a different Python version, you will need to obtain the Ice source code and compile a new version of the extension.

If you are migrating an Ice application from Python 2.x to Python 3.x, please refer to the [upgrade instructions](#) for more information.

## Ruby 1.9

The Ice extension for Ruby adds support for Ruby 1.9 while still maintaining source compatibility with 1.8.x.

For compatibility with the [Ruby Installer for Windows](#), the Ice extension included in the Ice installer for Windows is compiled with MinGW and requires Ruby 1.9.x.

The binary distributions for Linux and Mac include a Ruby extension that was built against (and requires) the default Ruby version for that platform. To use the Ice extension with a different Ruby version, you will need to download the Ice source code and compile a new version of

the extension.

## Encoding Changes in Ice 3.5

The Ice [message format](#) is governed by two sets of rules: the protocol rules and the encoding rules. The protocol rules define the number of message types as well as the format of the message headers. The encoding rules specify how Slice types are marshaled. Ice maintains separate versions for the protocol and encoding, which makes it possible for them to evolve independently.

Several of the new features in Ice 3.5 require changes to the way that Slice classes and exceptions are marshaled. These changes make the encoding incompatible with previous releases, therefore Ice 3.5 also introduces version 1.1 of the Ice encoding. The protocol remains unchanged at version 1.0.

The following improvements to the encoding for classes and exceptions necessitated the new version:

- [Optional data members and parameters](#)
- [Preserved slices](#)
- [Compact encoding format](#)

Changing the protocol or encoding format can be disruptive and does not happen often. (In fact, this is the first change since Ice's initial release.) We took advantage of this opportunity to make some other minor improvements that have been on our "wish list" for some time.

Naturally, these changes raise the issue of backward compatibility with applications that use earlier versions of Ice, and more specifically, applications that use version 1.0 of the Ice encoding. Ice 3.5 uses the following semantics:

- Encoding version 1.1 is the default for Ice 3.5. You can change this default using the [Ice.Default.EncodingVersion](#) property.
- A proxy is marshaled with an embedded encoding version representing the highest version supported by the target object, so the receiver of a proxy always knows the encoding version(s) it is allowed to use when invoking operations on that proxy. A proxy created locally uses the default encoding version, which can be inspected and changed using proxy methods.
- The results of an operation are encoded using the same version as the incoming request.
- As you would expect, the features provided by the 1.1 encoding are unavailable when an Ice 3.5 application is forced to use the 1.0 encoding.

### See Also

- [New in Ice 3.5: Encoding Version 1.1](#)
- [The Ice Protocol](#)

## Upgrading your Application from Ice 3.5.0



Ice 3.5.1 maintains binary compatibility with Ice 3.5.0, therefore it is not necessary for you to recompile your Slice files or your program code, nor is it necessary to relink your application. (Custom transports are an exception to this rule.) The database formats used by Ice services such as IceGrid and IceStorm have not changed, therefore no database migration is required. Finally, this release has not removed any APIs. Generally speaking, you are free to use any combination of Ice 3.5.0 and Ice 3.5.1 applications and Ice services.

The subsections below provide additional information about upgrading to Ice 3.5.1, including administrative procedures for the supported platforms.

On this page:

- [Custom Transport Plug-ins](#)
- [Upgrading from Ice 3.5.0 on Linux](#)
- [Upgrading from Ice 3.5.0 on Windows](#)
- [Upgrading from Ice 3.5.0 on OS X](#)
- [Upgrading from Ice 3.5.0 on Solaris](#)
- [Upgrading from Ice 3.5.0 with a Source Distribution \(Linux, OS X, Solaris\)](#)
- [Deprecated APIs in Ice 3.5.1](#)

### Custom Transport Plug-ins

Changes to the internal Ice transport API in Ice 3.5.1 break binary and source compatibility for custom transport plug-ins that used Ice 3.5.0. ZeroC does not guarantee backward compatibility for internal APIs, therefore transport developers will need to modify their plug-ins and recompile them with Ice 3.5.1.

### Upgrading from Ice 3.5.0 on Linux

For RPM and Ubuntu installations, you can use the Ice 3.5.1 packages to upgrade an existing installation of Ice 3.5.0.

For a Java application, no additional steps are necessary if your `CLASSPATH` refers to `/usr/share/java/Ice.jar`, which is a symbolic link that points to the actual version-specific JAR file.

For a Mono application, the Mono package for Ice 3.5.1 installs the updated Ice run time assemblies into the Global Assembly Cache (GAC) along with policy assemblies that enable backward compatibility with Ice 3.5.0.

### Upgrading from Ice 3.5.0 on Windows

The file names of the Ice for C++ run time DLLs do not contain the patch number of a release. For example, the core Ice DLL uses the same name (`ice35.dll`) for Ice 3.5.0 and 3.5.1. As a result, you can simply substitute the 3.5.1 DLLs for the 3.5.0 DLLs. If you install the 3.5.1 DLLs in a different directory, you will typically need to adjust the `PATH` setting of a C++ application so that it can locate the new libraries. This also applies to Python, Ruby, and PHP applications because they use the Ice for C++ DLLs.

For a Java application, you can replace the existing `Ice.jar` file with the one from Ice 3.5.1, or you can adjust the `CLASSPATH` setting to point to the new JAR file.

For a .NET application, Ice for .NET includes policy assemblies that supply the .NET run time with the required compatibility information. Policy assemblies have names of the form `policy.3.5.package.dll`. For example, the policy assembly for IceBox is `policy.3.5.IceBox.dll`. One way to upgrade an existing .NET application to a new patch release while maintaining binary compatibility is to install the policy assemblies into the Global Assembly Cache (GAC) using one of the following methods:

- Open Windows Explorer and navigate to the directory `C:\WINDOWS\assembly`. Next, drag and drop (or copy and paste) the assemblies into the right-hand pane to install them in the GAC.



- Use `gacutil` from the command line:

```
> gacutil -i <policy.dll>
```

Another option is to modify the `.config` file of your application to add `bindingRedirect` directives, as explained in the links below:

<http://msdn.microsoft.com/en-us/library/7wd6ex19.aspx>

<http://msdn.microsoft.com/en-us/library/yx7xezcf.aspx>

For example, in the `.config` file of an application you can modify the configuration of the `Ice` and `IceBox` assemblies as follows:

XML
<pre>&lt;?xml version="1.0" encoding="utf-8" ?&gt; &lt;configuration&gt;   &lt;runtime&gt;     &lt;assemblyBinding xmlns="urn:schemas-microsoft-com:asm.v1"&gt;        &lt;dependentAssembly&gt;         &lt;assemblyIdentity name="Ice" culture="neutral"           publicKeyToken="cdd571ade22f2f16"/&gt;         &lt;bindingRedirect oldVersion="3.5.0.0" newVersion="3.5.1.0"/&gt;       &lt;/dependentAssembly&gt;        &lt;dependentAssembly&gt;         &lt;assemblyIdentity name="IceBox" culture="neutral"           publicKeyToken="cdd571ade22f2f16"/&gt;         &lt;bindingRedirect oldVersion="3.5.0.0" newVersion="3.5.1.0"/&gt;       &lt;/dependentAssembly&gt;      &lt;/assemblyBinding&gt;   &lt;/runtime&gt; &lt;/configuration&gt;</pre>

This `.config` file can be used for `iceboxnet.exe` (as `iceboxnet.exe.config`), to load a simple `IceBox` service built with `Ice 3.5.0` with `iceboxnet 3.5.1`.

Note that `cdd571ade22f2f16` is the token corresponding to ZeroC's public key for signing the assemblies in binary distributions. If you built `Ice` from sources, your assemblies were signed using the development key instead, which you can find in `config/IceDevKey.snk`. The token for the development key is `1f998c50fec78381`.

The advantage of installing the policy assemblies into the GAC is that they establish binary compatibility for all `Ice` applications, whereas modifying a `.config` file must be done for each application individually.

On a development system, it is not necessary to remove your existing `Ice` installation prior to installing `Ice 3.5.1` unless you intend to install `Ice 3.5.1` in the same directory as your existing installation. You may need to update your `PATH` setting and modify your Visual C++ directory configurations to reflect the installation directory for `Ice 3.5.1`.

## Upgrading from Ice 3.5.0 on OS X

The `Ice` installer installs `Ice` in `/Library/Developer/Ice-3.5.1` and updates the `/Library/Developer/Ice-3.5` symbolic link to point to the `Ice 3.5.1` installation. If your binaries were built with an `RPATH` set to `/Library/Developer/Ice-3.5/lib`, no additional

steps are necessary to use Ice 3.5.1. If they were built without an RPATH or if the RPATH is set to the Ice 3.5.0 installation directory, you will need to re-build them or you will need to set the `DYLD_LIBRARY_PATH` environment variable:

```
export DYLD_LIBRARY_PATH=/Library/Developer/Ice-3.5.1/lib
```

No additional steps are necessary for a Java application if its `CLASSPATH` refers to the JAR file via the symbolic link:

```
export CLASSPATH=/Library/Developer/Ice-3.5/lib/Ice.jar
```

For Python no additional steps are necessary, the Ice installer replaced the Ice for Python files from `/Library/Python/2.7/site-packages` with the Ice 3.5.1 version.

## Upgrading from Ice 3.5.0 on Solaris

The [Using the Solaris Binary Distribution](#) page describes how to configure your environment so that the embedded path names in the Ice for C++ shared libraries are resolved correctly. For example, if you extracted the binary distribution for Ice 3.5.0 into `/opt/Ice-3.5.0`, it instructs you to create the following symbolic link:

```
/opt/Ice-3.5 -> /opt/Ice-3.5.0
```

To upgrade to Ice 3.5.1, you simply extract the binary distribution archive into `/opt/Ice-3.5.1` and reset the symbolic link to point to the new installation:

```
/opt/Ice-3.5 -> /opt/Ice-3.5.1
```

No additional steps are necessary for a Java application if its `CLASSPATH` refers to the JAR file via the symbolic link:

```
export CLASSPATH=/opt/Ice-3.5/lib/Ice.jar
```

This also applies for Python and Ruby applications:

```
export PYTHONPATH=/opt/Ice-3.5/python
export RUBYLIB=/opt/Ice-3.5/ruby
```

## Upgrading from Ice 3.5.0 with a Source Distribution (Linux, OS X, Solaris)

If you compiled an Ice 3.5.0 source distribution and installed it via `make install`, the default installation directory uses a version-specific name such as `/opt/Ice-3.5.0`. Consequently, you can build and install the Ice 3.5.1 source distribution without affecting your existing Ice 3.5.0 installation.

You may need to update your application's build settings to use the new installation directory for locating include and library files. You may also need to update your shared library search path.

The relevant environment variables for each language mapping are detailed below.

- C++, Ruby, Python, PHP

```
export LD_LIBRARY_PATH=/opt/Ice-3.5.1/lib (32-bit Linux & 32-bit Solaris)
export LD_LIBRARY_PATH=/opt/Ice-3.5.1/lib64 (64-bit Linux)
export LD_LIBRARY_PATH_64=/opt/Ice-3.5.1/lib/amd64 (64-bit Solaris Intel)
export LD_LIBRARY_PATH_64=/opt/Ice-3.5.1/lib/sparcv9 (64-bit Solaris SPARC)
export DYLD_LIBRARY_PATH=/opt/Ice-3.5.1/lib (OS X)
```

- Python

```
export PYTHONPATH=/opt/Ice-3.5.1/python
```

- Ruby

```
export RUBYLIB=/opt/Ice-3.5.1/ruby
```

- Java

```
export CLASSPATH=/opt/Ice-3.5.1/lib/Ice.jar:/opt/Ice-3.5.1/lib/Freeze.jar
```

- Mono

```
export MONO_PATH=/opt/Ice-3.5.1/bin
```

## Deprecated APIs in Ice 3.5.1

No APIs were deprecated in Ice 3.5.1.

## Upgrading your Application from Ice 3.4

The subsections below provide additional information about upgrading to Ice 3.5, including administrative procedures for the supported platforms.

On this page:

- [Backward compatibility of Ice versions](#)
  - [Source-code compatibility](#)
  - [Binary compatibility](#)
  - [On-the-wire compatibility](#)
  - [Database compatibility](#)
  - [Interface compatibility](#)
    - [IceGrid](#)
    - [IceStorm](#)
- [Slicing behavior in Ice 3.5](#)
- [Slice language changes in Ice 3.5](#)
- [C++ changes in Ice 3.5](#)
- [Java changes in Ice 3.5](#)
- [Python changes in Ice 3.5](#)
- [PHP changes in Ice 3.5](#)
- [IPv6 changes in Ice 3.5](#)
- [Migrating IceGrid databases from Ice 3.4](#)
- [Migrating IceStorm databases from Ice 3.4](#)
- [Migrating Freeze databases from Ice 3.4](#)
  - [Upgrading to the Berkeley DB 5.3 format](#)
  - [Freeze maps and the 1.1 encoding](#)
- [Migrating Android applications from Ice 3.4](#)
- [Changed APIs in Ice 3.5](#)
- [Removed APIs in Ice 3.5](#)
- [Deprecated APIs in Ice 3.5](#)

## Backward compatibility of Ice versions

A discussion of backward compatibility in Ice involves many factors.

### Source-code compatibility

Ice maintains source-code compatibility between a patch release (e.g., 3.4.2) and the most recent minor release (e.g., 3.4.0), but does not guarantee source-code compatibility between minor releases (e.g., between 3.4 and 3.5).

The subsections below describe the significant API changes in this release that may impact source-code compatibility. Furthermore, the subsections [Removed APIs in Ice 3.5](#) and [Deprecated APIs in Ice 3.5](#) summarize additional changes to Ice APIs that could affect your application.

### Binary compatibility

As for source-code compatibility, Ice maintains backward binary compatibility between a patch release and the most recent minor release, but does not guarantee binary compatibility between minor releases.

The requirements for upgrading depend on the language mapping used by your application:

- For statically-typed languages (C++, Java, .NET), the application must be recompiled.
- For scripting languages that use static translation, your Slice files must be recompiled.
- No action is necessary for a Python or Ruby script that loads its Slice files dynamically.

## On-the-wire compatibility

Ice always maintains protocol ("on the wire") compatibility with prior releases. A client using Ice version *x* can communicate with a server using Ice version *y* and vice versa.

Several features introduced in Ice 3.5 require a new version of the Ice encoding, encoding version 1.1. Older versions of Ice do not understand this encoding: you need to use Ice encoding version 1.0 for communications between clients or servers using Ice 3.5 and clients and servers using older Ice versions. See [New in Ice 3.5: Encoding Version 1.1](#) for details.

## Database compatibility

Upgrading to a new minor release of Ice often includes an upgrade to the supported version of Berkeley DB. In turn, this may require an application to migrate its databases, either because the format of Berkeley DB's database files has changed, or due to a change in the schema of the data stored in those databases.

For example, if your application uses Freeze, it may be necessary for you to migrate your databases even if your schema has not changed.

Certain Ice services also use Freeze in their implementation. If your application uses these services (IceGrid and IceStorm), it may be necessary for you to migrate their databases as well.

Please refer to the relevant subsections below for migration instructions.

## Interface compatibility

Although Ice always maintains compatibility at the protocol level, changing Slice definitions can also lead to incompatibilities. As a result, Ice maintains interface compatibility between a patch release and the most recent minor release, but does not guarantee compatibility between minor releases.

This issue is particularly relevant if your application uses Ice services such as IceGrid or IceStorm, as a change to an interface in one of these services may adversely affect your application.

Interface changes in an Ice service can also impact compatibility with its administrative tools, which means it may not be possible to administer an Ice 3.5.x service using a tool from a previous minor release (or vice-versa).

### IceGrid

Starting with Ice 3.2.0, IceGrid registries and nodes are interface-compatible. For example, you can use an IceGrid node from Ice 3.2 with a registry from Ice 3.4.

IceGrid registry replication is only supported between registries using Ice 3.3 or later. With Ice 3.5, since the database format changed, an IceGrid slave from Ice 3.4 or 3.3 will not be able to synchronize with an IceGrid master from Ice 3.5. You need to upgrade all your IceGrid registries to Ice 3.5 to ensure replication between the registries work.

An IceGrid node using Ice 3.5 or later is able to activate a server that uses Ice < 3.5.

Regarding the IceGrid graphical and command-line administrative tools, you must use the 3.5 administrative tools to administer an IceGrid 3.5 registry; you cannot use an administrative tool from an earlier Ice version. The reverse is also true: you cannot administer an IceGrid 3.4 registry with an IceGrid 3.5 administration tool.

### IceStorm

Topic linking is supported between all IceStorm versions released after 3.0.0.

## Slicing behavior in Ice 3.5

In version 1.0 of the Ice encoding, Slice classes and user exceptions are always marshaled in a format that allows a receiver to "slice" an unknown derived type to a known base type. An application that uses Ice 3.4 or earlier may depend on this behavior. For example, the slicing feature makes it possible for a sender to evolve independently of a receiver, adding more derived types that the receiver does not understand without causing the receiver to fail should it encounter one of these new types.

Version 1.1 of the Ice encoding introduces two [formats](#) for classes and exceptions. The compact format, which is used by default, does not support the slicing feature, meaning an application that relies on this feature may begin to receive `NoObjectFactoryException` or `UnknownUserException` errors after upgrading to Ice 3.5. There are several possible solutions:

- Continue using version 1.0 of the Ice encoding by setting `Ice.Default.EncodingVersion` to 1.0 in all senders and receivers.
- If you wish to take advantage of other features offered by encoding version 1.1, you can make the sliced format the default by setting `Ice.Default.SlicedFormat` to 1 in all senders and receivers.
- Annotate your interfaces or operations with [metadata](#) so that the sliced format is only used where necessary.

## Slice language changes in Ice 3.5

The term `optional` is now a Slice keyword in Ice 3.5, which means existing Slice definitions that use this term as an identifier will generate an error. To continue using `optional` as an identifier, you can use the Slice syntax for escaping keywords:

Slice
<pre>struct Example {     bool \optional; };</pre>

## C++ changes in Ice 3.5

The `slice2cpp` translator no longer generates C++ comparison operators for all Slice structures. Comparison operators are only generated for structures that qualify as a [legal dictionary key type](#). To generate a comparison operator for a Slice structure that doesn't qualify as such, you can prefix the `[ "cpp:comparable" ]` metadata to your Slice struct definition.

## Java changes in Ice 3.5

The generated code and supporting classes for the various Ice services are now provided as separate JAR files:

JAR File	Description
Freeze.jar	Freeze classes
Glacier2.jar	Glacier2 generated code and helper classes
Ice.jar	The core Ice run time, including the IceSSL plugin
IceBox.jar	IceBox server, generated code, admin utility
IceGrid.jar	IceGrid generated code
IcePatch2.jar	IcePatch2 generated code
IceStorm.jar	IceStorm generated code

Also note that the manifest in `Freeze.jar` no longer contains a reference to `db.jar`, so you may need to update your class path to include `db.jar`.

The [Eclipse Plug-in](#) still includes only `Ice.jar` by default, but you can easily include additional JAR files by changing the `Slice2Java` properties for your project.

## Python changes in Ice 3.5

Ice 3.5 adds support for Python 3. Developers who are migrating existing Ice applications from Python 2 to Python 3 should be aware of the following changes that affect the Python language mapping:

- One of the most significant changes in Python 3 is its unification of the unicode and string types into just one type, `str`. Python developers must convert any existing unicode literals and variables into their string equivalents. For Ice developers, a benefit of this unification is that all string values sent "over the wire" are now sent and received as unicode strings. With Python 2.x, the Ice run time behavior remains unchanged: string and unicode values are both accepted as inputs, but only string values are returned as outputs.
- The Python 3 mapping for the Slice type `sequence<byte>` now defaults to the new Python type `bytes`. A string value is no longer accepted as a legal value for `sequence<byte>` with Python 3.

## PHP changes in Ice 3.5

For compatibility with newer PHP releases, the Ice extension no longer supports "call-time" reference arguments when calling `Ice_initialize` and `Ice_createProperties`. For example, existing applications may invoke `Ice_initialize` with an explicit reference argument as follows:

```

PHP
$communicator = Ice_initialize(&$argv);
```

The proper way to call this function using Ice 3.5 is shown below:

```

PHP
$communicator = Ice_initialize($argv);
```

Ice-specific arguments are now removed from the given argument vector.

## IPv6 changes in Ice 3.5

IPv6 is now enabled by default on all platforms. You can disable the use of IPv6 in Ice by setting the `Ice.IPv6` property to 0, which may be necessary in environments that lack IPv6 support or on older platforms such as [Windows XP](#). The new property `Ice.PreferIPv6Address` determines whether IPv4 or IPv6 addresses take precedence when resolving host names.

## Migrating IceGrid databases from Ice 3.4

Ice 3.5 supports the migration of IceGrid databases from Ice 3.3 and from Ice 3.4. To migrate from earlier Ice versions, you will first need to migrate the databases to the Ice 3.3 format. If you require assistance with such migration, please contact [support@zeroc.com](mailto:support@zeroc.com).

To migrate, first stop the IceGrid registry you wish to upgrade.

Next, copy the IceGrid database environment to a second location:

```
$ cp -r db recovered.db
```

Locate the correct version of the Berkeley DB recovery tool (usually named `db_recover`). It is essential that you use the `db_recover` executable that matches the Berkeley DB version of your existing Ice release. For Ice 3.3, use `db_recover` from Berkeley DB 4.6. For Ice 3.4, use `db_recover` from Berkeley DB 4.8. You can verify the version of your `db_recover` tool by running it with the `-v` option:

```
$ db_recover -v
```

Now run the utility on your copy of the database environment:

```
$ db_recover -h recovered.db
```

Change to the location where you will store the database environments for IceGrid 3.5:

```
$ cd <new-location>
```

Next, run the `upgradeicegrid35.py` utility located in the `config` directory of your Ice distribution (or in `/usr/share/Ice-3.5` if using an RPM installation). The first argument is the path to the old database environment. The second argument is the path to the new database environment.

In this example we'll create a new directory `db` in which to store the migrated database environment:

```
$ mkdir db
$ upgradeicegrid35.py <path-to-recovered.db> db
```

Upon completion, the `db` directory contains the migrated IceGrid databases.

By default, the migration utility assumes that the servers deployed with IceGrid also use Ice 3.5. If your servers still use an older Ice version, you need to specify the `--server-version` command-line option when running `upgradeicegrid35.py`:

```
$ upgradeicegrid.py --server-version 3.4.2 <path-to-recovered.db> db
```

The migration utility will set the `server descriptor` attribute `ice-version` to the specified version and the IceGrid registry will generate configuration files compatible with the given version.

If you are upgrading the master IceGrid registry in a replicated environment and the slaves are still running, you should first restart the master registry in read-only mode using the `--readonly` option, for example:

```
$ icegridregistry --Ice.Config=config.master --readonly
```

Next, you can connect to the master registry with `icegridadmin` or the IceGrid administrative GUI from Ice 3.5 to ensure that the database is correct. If everything looks fine, you can shutdown and restart the master registry without the `--readonly` option.

IceGrid slaves from Ice 3.3 or 3.4 won't interoperate with the IceGrid 3.5 master. You can leave them running during the upgrade of the master to not interrupt your applications. Once the master upgrade is done, you should upgrade the IceGrid slaves to Ice 3.5 using the instruction above.

## Migrating IceStorm databases from Ice 3.4

No changes were made to the database schema for IceStorm in this release. However, you still need to update your databases as described [below](#).

## Migrating Freeze databases from Ice 3.4

No changes were made that would affect the content of your [Freeze](#) databases. However, we upgraded the version of Berkeley DB and the new 1.1 encoding may require that you re-create your indices or set some additional configuration if you use Freeze maps. If you only use Freeze evictors, you only need to upgrade your databases to the new Berkeley DB format. See [New in Ice 3.5: Encoding Version 1.1](#).

## Upgrading to the Berkeley DB 5.3 format

When upgrading to Ice 3.5, you must upgrade your database to the Berkeley DB 5.3 format. The only change that affects Freeze is the format of Berkeley DB's log file.

The instructions below assume that the database environment to be upgraded resides in a directory named `db` in the current working directory. For a more detailed discussion of database migration, please refer to the [Berkeley DB Upgrade Process](#).

To migrate your database:

1. Shut down the old version of the application.
2. Make a backup copy of the database environment:



```
> cp -r db backup.db (Unix)
> xcopy /E db backup.db (Windows)
```

3. Locate the correct version of the Berkeley DB recovery tool (usually named `db_recover`). It is essential that you use the `db_recover` executable that matches the Berkeley DB version of your existing Ice release. For Ice 3.4, use `db_recover` from Berkeley DB 4.8. You can verify the version of your `db_recover` tool by running it with the `-V` option:

```
> db_recover -V
```

4. Use the `db_recover` tool to run recovery on the database environment:

```
> db_recover -h db
```

5. Recompile and install the new version of the application.
6. Force a checkpoint using the `db_checkpoint` utility. Note that you must use the `db_checkpoint` utility from Berkeley DB 5.3 when performing this step.

```
> db_checkpoint -l -h db
```

7. Restart the application.

## Freeze maps and the 1.1 encoding

The majority of Freeze maps will work out of the box with the new 1.1 encoding and without additional configuration. However there are a few cases where you will be required to take special action or add some configuration:

- If your Freeze maps use keys with Slice enumerations having more than 127 elements, the encoding of those keys will be incompatible with the 1.1 encoding. You will need to set the `Freeze.DbEnv.<env-name>.EncodingVersion` property to 1.0 to ensure that you decode the keys with the 1.0 encoding and not with the default 1.1 encoding.
- If your Freeze maps use indices and those indices use Slice classes, or use Slice enumerations having more than 127 elements, you have two options:
  1. Re-create the indices with the 1.1 encoding. To recreate your indices, you have to recreate the Freeze maps using the `recreate` method generated on the Freeze map classes by `slice2freezej`. See the [Freeze Maps](#) documentation for more information.
  2. Set the `Freeze.DbEnv.<env-name>.EncodingVersion` property to 1.0 to ensure that Freeze still uses the 1.0 encoding for your indices.
- If you use indices with Java Freeze maps and the map value uses classes, you have to recreate the indices because of a bug in the encoding of the Ice 3.4 indices. This only affects Java Freeze maps; C++ Freeze maps are not affected by this issue.



If you configure your Freeze database environment to use the 1.0 encoding, you will not be able to take advantage of the new features provided with the 1.1 encoding, such as optional values and the new formats for classes.

## Migrating Android applications from Ice 3.4

Prior versions of the Ice plug-in for Eclipse (including the version released for Ice 3.5b) created a workspace variable named `ICE_HOME` that referred to the Ice installation directory configured in Eclipse's *Preferences* dialog. After adding the Slice2Java builder to a project, the builder

updated the project's build path to include Ice JAR files relative to `ICE_HOME`. For example, `Ice.jar` was configured as the library reference `ICE_HOME/lib/Ice.jar`.

As of Ice 3.5.0, the Eclipse plug-in no longer uses the `ICE_HOME` variable. Instead, it now uses the workspace variable `ICE_JAR_HOME` to refer to the subdirectory containing `Ice.jar`, equivalent to the previous setting of `ICE_HOME/lib`. Consequently, a new project's build path now includes the library reference `ICE_JAR_HOME/Ice.jar`.

The plug-in does not attempt to modify the build path of an existing Ice for Android project to use `ICE_JAR_HOME`, nor does it remove `ICE_HOME` from the workspace. An existing project can continue to use the `ICE_HOME` variable in its build path, but moving or copying the project to a new workspace where `ICE_HOME` is no longer defined means the project's build path must be updated.

## Changed APIs in Ice 3.5

This section describes APIs whose semantics have changed, potentially in ways that are incompatible with previous releases.

The following APIs were changed in Ice 3.5:

- The [dynamic invocation and dispatch](#) API now requires encapsulations for input parameters and output results. For example, when calling `ice_invoke`, the value for `inParams` must be an encapsulation of the input parameters:

```

C++

Ice::OutputStreamPtr out = Ice::createOutputStream();
out->startEncapsulation();
// marshal parameters
out->endEncapsulation();
Ice::ByteSeq inParams;
out->finished(inParams);
// invoke operation...
```

Similarly, the byte sequence containing the results must also be an encapsulation:

```

C++

Ice::ByteSeq results;
// invoke operation...
Ice::InputStreamPtr in = Ice::wrapInputStream(results);
in->startEncapsulation();
// unmarshal results
in->endEncapsulation();
```

- The [streaming](#) API uses new methods to mark the beginning and end of objects and exceptions: `startObject/endObject` and `startException/endException`.

## Removed APIs in Ice 3.5

This section describes APIs that were deprecated in a previous release and have now been removed. Your application may no longer compile successfully if it relies on one of these APIs.

The following APIs were removed in Ice 3.5:

- `Ice.Default.CollocationOptimization`

Use `Ice.Default.CollocationOptimized` instead.

- `proxy.CollocationOptimization`  
Use `proxy.CollocationOptimized` instead.
- `adapter.RegisterProcess`  
This property caused the Ice run time to register a proxy with the locator registry that allowed the process to be shut down remotely. The new `administrative facility` has replaced this functionality.
- `Ice.ServerId`  
As with `adapter.RegisterProcess`, this property was used primarily for IceGrid integration and has been replaced by a similar mechanism in the `administrative facility`.
- `Ice.Trace.Location`  
This property has been replaced by `Ice.Trace.Locator`.
- `Glacier2.Admin` and `IcePatch2.Admin`  
These are the names of administrative object adapters in `Glacier2` and `IcePatch2`, respectively. The functionality offered by these object adapters has been replaced by that of the `administrative facility`, therefore these adapters (and their associated configuration properties) are no longer necessary.
- `Ice.Util.generateUUID()`  
In Java use `java.util.UUID.randomUUID().toString()`. In C# use `System.Guid.NewGuid.ToString()`.
- `Object.ice_hash()`  
`ObjectPrx.ice_getHash()`  
`ObjectPrx.ice_toString()`  
Ice no longer defines hash methods for objects and proxies. To convert a proxy into a string, use the standard platform methods: `toString` in Java, `ToString` in C#.

## Deprecated APIs in Ice 3.5

This section discusses APIs and components that are now deprecated. These APIs will be removed in a future Ice release, therefore we encourage you to update your applications and eliminate the use of these APIs as soon as possible.

The following APIs were deprecated in Ice 3.5:

- `Stats facility`  
This functionality is now provided by the `Instrumentation facility` and the `Metrics facet`.

The following components were deprecated in Ice 3.5:

- Qt SQL database plug-ins for IceGrid and IceStorm  
Freeze is now the only supported persistence mechanism for these services.

## Upgrading your Application from Ice 3.3

In addition to the information provided in [Upgrading your Application from Ice 3.4](#), users who are upgrading from Ice 3.3 should also review this page.

On this page:

- [Backward compatibility of Ice versions](#)
  - [Source-code compatibility](#)
  - [Binary compatibility](#)
  - [On-the-wire compatibility](#)
  - [Database compatibility](#)
  - [Interface compatibility](#)
    - [IceGrid](#)
    - [IceStorm](#)
- [Java language mapping changes in Ice 3.4](#)
  - [Metadata](#)
  - [Dictionaries](#)
  - [Request Contexts](#)
  - [Enumerations](#)
- [Changes to the Java API for Freeze maps in Ice 3.4](#)
  - [General changes to Freeze maps in Java](#)
  - [Enhancements to Freeze maps in Java](#)
  - [Backward compatibility for Freeze maps in Java](#)
  - [Finalizers in Freeze](#)
- [Freeze packaging changes in Ice 3.4](#)
- [PHP changes in Ice 3.4](#)
  - [Static translation in PHP](#)
  - [Deploying a PHP application](#)
  - [Using communicators in PHP](#)
  - [Using registered communicators in PHP](#)
  - [PHP configuration](#)
  - [PHP namespaces](#)
  - [Run-time exceptions in PHP](#)
  - [Downcasting in PHP](#)
  - [Other API changes for PHP](#)
- [Thread pool changes in Ice 3.4](#)
- [IceSSL changes in Ice 3.4](#)
- [Migrating IceStorm and IceGrid databases from Ice 3.3](#)
- [Migrating Freeze databases from Ice 3.3](#)
- [Removed APIs in Ice 3.4.0](#)
- [Deprecated APIs in Ice 3.4.0](#)

## Backward compatibility of Ice versions

A discussion of backward compatibility in Ice involves many factors.

### Source-code compatibility

Ice maintains source-code compatibility between a patch release (e.g., 3.4.2) and the most recent minor release (e.g., 3.4.0), but does not guarantee source-code compatibility between minor releases (e.g., between 3.4 and 3.5).

The subsections below describe the significant API changes in this release that may impact source-code compatibility. Furthermore, the subsections [Removed APIs in Ice 3.4.0](#) and [Deprecated APIs in Ice 3.4.0](#) summarize additional changes to Ice APIs that could affect your application.

## Binary compatibility

As for source-code compatibility, Ice maintains backward binary compatibility between a patch release and the most recent minor release, but does not guarantee binary compatibility between minor releases.

The requirements for upgrading depend on the language mapping used by your application:

- For statically-typed languages (C++, Java, .NET), the application must be recompiled.
- For scripting languages that use static translation, your Slice files must be recompiled.
- No action is necessary for a Python or Ruby script that loads its Slice files dynamically.

## On-the-wire compatibility

Ice always maintains protocol ("on the wire") compatibility with prior releases. A client using Ice version *x* can communicate with a server using Ice version *y* and vice versa.

Several features introduced in Ice 3.5 require a new version of the Ice encoding, encoding version 1.1. Older versions of Ice do not understand this encoding: you need to use Ice encoding version 1.0 for communications between clients or servers using Ice 3.5 and clients and servers using older Ice versions. See [New in Ice 3.5: Encoding Version 1.1](#) for details.

## Database compatibility

Upgrading to a new minor release of Ice often includes an upgrade to the supported version of Berkeley DB. In turn, this may require an application to migrate its databases, either because the format of Berkeley DB's database files has changed, or due to a change in the schema of the data stored in those databases.

For example, if your application uses Freeze, it may be necessary for you to migrate your databases even if your schema has not changed.

Certain Ice services also use Freeze in their implementation. If your application uses these services (IceGrid and IceStorm), it may be necessary for you to migrate their databases as well.

Please refer to the relevant subsections below for migration instructions.

## Interface compatibility

Although Ice always maintains compatibility at the protocol level, changing Slice definitions can also lead to incompatibilities. As a result, Ice maintains interface compatibility between a patch release and the most recent minor release, but does not guarantee compatibility between minor releases.

This issue is particularly relevant if your application uses Ice services such as IceGrid or IceStorm, as a change to an interface in one of these services may adversely affect your application.

Interface changes in an Ice service can also impact compatibility with its administrative tools, which means it may not be possible to administer an Ice 3.4.x service using a tool from a previous minor release (or vice-versa).

### IceGrid

Starting with Ice 3.2.0, IceGrid registries and nodes are interface-compatible. For example, you can use an IceGrid node from Ice 3.2 with a registry from Ice 3.4.

IceGrid registry replication is only supported between registries using Ice 3.3 or later.

An IceGrid node using Ice 3.3 or later is able to activate a server that uses Ice 3.2. The reverse is also true: an IceGrid node from Ice 3.2 is able to activate a server built with Ice 3.3 or later, but only if the server's configuration properties do not rely on features added after Ice 3.2 (such as the ability to escape characters in property names and values).

### IceStorm

Topic linking is supported between all IceStorm versions released after 3.0.0.

## Java language mapping changes in Ice 3.4

The Java2 language mapping, which was deprecated in Ice 3.3, is no longer supported. The Slice compiler and Ice API now use the Java5 language mapping exclusively, therefore upgrading to Ice 3.4 may require modifications to your application's source code. The subsections below discuss the language mapping features that are affected by this change and describe how to modify your application accordingly.

### Metadata

The global metadata directives `java:java2` and `java:java5` are no longer supported and should be removed from your Slice files. The Slice compiler now emits a warning about these directives.

Support for the portable metadata syntax has also been removed. This syntax allowed Slice definitions to define custom type metadata that the Slice compiler would translate to match the desired target mapping. For example:

```

Slice

["java:type:{java.util.ArrayList}"] sequence<String> StringList;
```

The braces surrounding the custom type `java.util.ArrayList` directed the Slice compiler to use `java.util.ArrayList<String>` in the Java5 mapping and `java.util.ArrayList` in the Java2 mapping.

All uses of the portable metadata syntax must be changed to use the corresponding Java5 equivalent.

### Dictionaries

Now that Slice dictionary types use the Java5 mapping, recompiling your Slice files and your application may cause the Java compiler to emit "unchecked" warnings. This occurs when your code attempts to assign an untyped collection class such as `java.util.Map` to a generic type such as `java.util.Map<String, String>`. Consider the following example:

```

Slice

dictionary<string, int> ValueMap;

interface Table
{
 void setValues(ValueMap m);
};
```

A Java2 application might have used these Slice definitions as shown below:

```

Java

java.util.Map values = new java.util.HashMap();
values.put(...);

TablePrx proxy = ...;
proxy.setValues(values); // Warning
```

The call to `setValues` is an example of an unchecked conversion. We recommend that you compile your application using the compiler

option shown below:

```
javac -Xlint:unchecked ...
```

This option causes the compiler to generate descriptive warnings about occurrences of unchecked conversions to help you find and correct the offending code.

## Request Contexts

The Slice type for [request contexts](#), `Ice::Context`, is defined as follows:

```

Slice
module Ice
{
 dictionary<string, string> Context;
};

```

As a dictionary, the `Context` type is subject to the same issues regarding unchecked conversions described for [#Dictionaries](#). For example, each proxy operation maps to two overloaded methods, one that omits the trailing `Context` parameter and one that includes it:

```

Java
interface TablePrx
{
 void setValues(java.util.Map<String, Integer> m); // No context

 void setValues(java.util.Map<String, Integer> m,
 java.util.Map<String, String> ctx);
}

```

If your proxy invocations make use of this parameter, you will need to change your code to use the generic type shown above in order to eliminate unchecked conversion warnings.

## Enumerations

The Java2 language mapping for a Slice enumeration generated a class whose API differed in several ways from the standard Java5 enum type. Consider the following enumeration:

```

Slice
enum Color { red, green, blue };

```

The Java2 language mapping for `Color` is shown below:

### Java

```
public final class Color
{
 // Integer constants
 public static final int _red = 0;
 public static final int _green = 1;
 public static final int _blue = 2;

 // Enumerators
 public static final Color red = ...;
 public static final Color green = ...;
 public static final Color blue = ...;

 // Helpers
 public static Color convert(int val);
 public static Color convert(String val);
 public int value();

 ...
}
```

The first step in migrating to the Java5 mapping for enumerations is to modify all `switch` statements that use an enumerator. Before Java added native support for enumerations, the `switch` statement could only use the integer value of the enumerator and therefore the Java2 mapping supplied integer constants for use in `case` statements. For example, here is a `switch` statement that uses the Java2 mapping:

### Java

```
Color col = ...;
switch(col.value())
{
case Color._red:
 ...
 break;
case Color._green:
 ...
 break;
case Color._blue:
 ...
 break;
}
```

The Java5 mapping eliminates the integer constants because Java5 allows enumerators to be used in `case` statements. The resulting code becomes much easier to read and write:



### Java

```
Color col = ...;
switch(col)
{
case red:
 ...
 break;
case green:
 ...
 break;
case blue:
 ...
 break;
}
```

The next step is to replace any uses of the `value` or `convert` methods with their Java5 equivalents. The base class for all Java5 enumerations (`java.lang.Enum`) supplies methods with similar functionality:

### Java

```
static Color[] values() // replaces convert(int)
static Color valueOf(String val) // replaces convert(String)
int ordinal() // replaces value()
```

For example, here is the Java5 code to convert an integer into its equivalent enumerator:

### Java

```
Color r = Color.values()[0]; // red
```

Note however that the `convert(String)` method in the Java2 mapping returned null for an invalid argument, whereas the Java5 enum method `valueOf(String)` raises `IllegalArgumentException` instead.

Refer to the [manual](#) for more details on the mapping for enumerations.

## Changes to the Java API for Freeze maps in Ice 3.4

The Java API for [Freeze maps](#) has been revised to use Java5 generic types and enhanced to provide additional functionality. This section describes these changes in detail and explains how to migrate your Freeze application to the API in Ice 3.4.

### General changes to Freeze maps in Java

The Freeze API is now entirely type-safe, which means compiling your application against Ice 3.4 is likely to generate unchecked conversion warnings. The generated class for a Freeze map now implements the `java.util.SortedMap<K, V>` interface, where `K` is the key type and `V` is the value type. As a result, applications that relied on the untyped `SortedMap` API (where all keys and values were treated as instances of `java.lang.Object`) will encounter compiler warnings in Ice 3.4.

For example, an application might have iterated over the entries in a map as follows:

### Java

```
// Old API
Object key = new Integer(5);
Object value = new Address(...);
myMap.put(key, value);
java.util.Iterator i = myMap.entrySet().iterator();
while (i.hasNext())
{
 java.util.Map.Entry e = (java.util.Map.Entry)i.next();
 Integer myKey = (Integer)e.getKey();
 Address myValue = (Address)e.getValue();
 ...
}
```

This code will continue to work, but the new API is both type-safe and self-documenting:

### Java

```
// New API
int key = 5;
Address value = new Address(...);
myMap.put(key, value); // The key is autoboxed to Integer.
for (java.util.Map.Entry<Integer, Address> e : myMap.entrySet())
{
 Integer myKey = e.getKey();
 Address myValue = e.getValue();
 ...
}
```

Although migrating to the new API may require some effort, the benefits are worthwhile because your code will be easier to read and less prone to defects. You can also take advantage of the "autoboxing" features in Java5 that automatically convert values of primitive types (such as `int`) into their object equivalents (such as `Integer`).

Please refer to the [manual](#) for complete details on the new API.

## Enhancements to Freeze maps in Java

Java6 introduced the `java.util.NavigableMap` interface, which extends `java.util.SortedMap` to add some useful new methods. Although the Freeze map API cannot implement `java.util.NavigableMap` directly because Freeze must remain compatible with Java5, we have added the `Freeze.NavigableMap` interface to provide much of the same functionality. A generated Freeze map class implements `NavigableMap`, as do the sub map views returned by map methods such as `headMap`. The `NavigableMap` interface is described in the [manual](#), and you can also refer to the Java6 API documentation.

## Backward compatibility for Freeze maps in Java

The Freeze Map API related to indices underwent some significant changes in order to improve type safety and avoid unchecked conversion warnings. These changes may cause compilation failures in a Freeze application.

In the previous API, index comparator objects were supplied to the Freeze map constructor in a map (in Java5 syntax, this comparators map

would have the type `java.util.Map<String, java.util.Comparator>` in which the index name was the key. As part of our efforts to improve type safety, we also wanted to use the fully-specified type for each index comparator (such as `java.util.Comparator<Integer>`). However, given that each index could potentially use a different key type, it is not possible to retain the previous API while remaining type-safe.

Consequently, the index comparators are now supplied as data members of a static nested class of the Freeze map named `IndexComparators`. If your application supplied custom comparators for indices, you will need to revise your code to use `IndexComparators` instead. For example:

```

Java

```

// Old API
java.util.Map indexComparators = new java.util.HashMap();
indexComparators.put("index", new MyComparator());
MyMap map = new MyMap(..., indexComparators);

// New API
MyMap.IndexComparators indexComparators = new MyMap.IndexComparators();
indexComparators.valueComparator = new MyComparator();
MyMap map = new MyMap(..., indexComparators);

```

```

We also encourage you to modify the definition of your comparator classes to use the Java5 syntax, as shown in the example below:

```

Java

```

// Old comparator
class IntComparator implements java.util.Comparator
{
    public int compare(Object o1, Object o2)
    {
        return ((Integer)o1).compareTo(o2);
    }
}

// New comparator
class IntComparator implements java.util.Comparator<Integer>
{
    public int compare(Integer i1, Integer i2)
    {
        return i1.compareTo(i2);
    }
}

```

```

The second API change that might cause compilation failures is the removal of the following methods:

### Java

```
java.util.SortedMap headMapForIndex(String name, Object key);
java.util.SortedMap tailMapForIndex(String name, Object key);
java.util.SortedMap subMapForIndex(String name, Object from, Object to);
java.util.SortedMap mapForIndex(String name);
```

Again, this API cannot be retained in a type-safe fashion, therefore `slice2freezej` now generates equivalent (and type-safe) methods for each index in the Freeze map class.

Please refer to the [manual](#) for complete details on the new API.

## Finalizers in Freeze

In previous releases, Freeze for Java used finalizers to close objects such as maps and connections that the application neglected to close. Most of these finalizers have been removed in Ice 3.4, and the only remaining finalizers simply log warning messages to alert you to the fact that connections and iterators are not being closed explicitly. Note that, given the uncertain nature of Java finalizers, it is quite likely that the remaining finalizers will not be executed.

## Freeze packaging changes in Ice 3.4

All Freeze-related classes are now stored in a separate JAR file named `Freeze.jar`. As a result, you may need to update your build scripts, deployment configuration, and run-time environment to include this additional JAR file.

## PHP changes in Ice 3.4

The Ice extension for PHP has undergone many changes in this release. The subsections below describe these changes in detail. Refer to the [PHP Mapping](#) for more information about the language mapping.

### Static translation in PHP

In prior releases, Slice files were deployed with the application and loaded at Web server startup by the Ice extension. Before each page request, the extension directed the PHP interpreter to parse the code that was generated from the Slice definitions.

In this release, Slice files must be translated using the new compiler `slice2php`. This change offers several advantages:

- Applications may have more opportunities to improve performance through the use of opcode caching.
- It is no longer necessary to restart the Web server when you make changes to your Slice definitions, which is especially useful during development.
- Errors in your Slice files can now be discovered in your development environment, rather than waiting until the Web server reports a failure and then reviewing the server log to determine the problem.
- The development process becomes simpler because you can easily examine the generated code if you have questions about the API or language mapping rules.
- PHP scripts can now use all of the Ice local exceptions. In prior releases, only a subset of the local exception types were available, and all others were mapped to `Ice_UnknownLocalException`. See the section [Run-time exceptions in PHP](#) below for more information.

All of the Slice files for Ice and Ice services are translated during an Ice build and available for inclusion in your application. At a minimum, you must include the file `Ice.php`:

**PHP**

```
require 'Ice.php';
```

`Ice.php` contains definitions for core Ice types and includes a minimal set of generated files. To use an Ice service such as `IceStorm`, include the appropriate generated file:

**PHP**

```
require 'Ice.php';
require 'IceStorm/IceStorm.php';
```

## Deploying a PHP application

With the transition to static code generation, you no longer need to deploy Slice files with your application. Instead, you will need to deploy the PHP code generated from your Slice definitions, along with `Ice.php`, the generated code for the Ice core, and the generated code for any Ice services your application might use.

## Using communicators in PHP

In prior releases, each PHP page request could access a single Ice communicator via the `$ICE` global variable. The configuration of this communicator was derived from the profile that the script loaded via the `Ice_loadProfile` function. The communicator was created on demand when `$ICE` was first used and destroyed automatically at the end of the page request.

In this release, a PHP script must create its own communicator using an API that is similar to other Ice language mappings:

**PHP**

```
function Ice_initialize()
function Ice_initialize($args)
function Ice_initialize($initData)
function Ice_initialize($args, $initData)
```

`Ice_initialize` creates a new communicator using the configuration provided in the optional arguments. `$args` is an array of strings representing command-line options, and `$initData` is an instance of `Ice_InitializationData`.

An application that requires no configuration can initialize a communicator as follows:

**PHP**

```
$communicator = Ice_initialize();
```

More elaborate configuration scenarios are described in the section [#PHP configuration](#) below.

A script may optionally destroy its communicator:

## PHP

```
$communicator->destroy();
```

At the completion of a page request, Ice by default automatically destroys any communicator that was not explicitly destroyed.

## Using registered communicators in PHP

PHP applications may benefit from the ability to use a communicator instance in multiple page requests. Reusing a communicator allows the application to minimize the overhead associated with the communicator lifecycle, including such activities as opening and closing connections to Ice servers.

This release includes new APIs for registering a communicator in order to prevent Ice from destroying it automatically at the completion of a page request. For example, a session-based application can create a communicator, establish a [Glacier2](#) session, and register the communicator. In subsequent page requests, the PHP session can retrieve its communicator instance and continue using the Glacier2 session.

The [manual](#) provides more information on this feature, and a new sample program can be found in `Glacier2/hello`.

## PHP configuration

Prior releases supported four INI settings in PHP's configuration file:

- `ice.config`
- `ice.options`
- `ice.profiles`
- `ice.slice`

The `ice.slice` directive is no longer supported since Slice definitions are now compiled statically. The remaining options are still supported but their semantics are slightly different. They no longer represent the configuration of a communicator; instead, they define property sets that a script can retrieve and use to initialize a communicator.

The global INI directives `ice.config` and `ice.options` configure the default property set. The `ice.profiles` directive can optionally nominate a separate file that defines any number of named profiles, each of which configures a property set.

As before, the profiles use an INI file syntax:

```
[Name1]
config=file1
options="--Ice.Trace.Network=2 ... "

[Name2]
config=file2
options="--Ice.Trace Locator=1 ... "
```

A new directive, `ice.hide_profiles`, overwrites the value of the `ice.profiles` directive as a security measure. This directive has a default value of 1, meaning it is enabled by default.

A script can obtain a property set using the new function `Ice_getProperties`. Called without an argument (or with an empty string), the function returns the default property set:

**PHP**

```
$props = Ice_getProperties();
```

Alternatively, you can pass the name of the desired profile:

**PHP**

```
$props = Ice_getProperties("Name1");
```

The returned object is an instance of `Ice_Properties`, which supports the standard Ice API.

For users migrating from an earlier release, you can replace a call to `Ice_loadProfile` as follows:

**PHP**

```
// PHP - Old API
Ice_loadProfile('Name1');

// PHP - New API
$initData = new Ice_InitializationData;
$initData->properties = Ice_getProperties('Name1');
$ICE = Ice_initialize($initData);
```

(Note that it is not necessary to use the symbol `$ICE` for your communicator. However, using this symbol may ease your migration to this release.)

`Ice_loadProfile` also installed the PHP definitions corresponding to your Slice types. In this release you will need to add `require` statements to include your generated code.

Finally, if you wish to manually configure a communicator, you can create a property set using `Ice_createProperties`:

**PHP**

```
function Ice_createProperties($args=null, $defaultProperties=null)
```

`$args` is an array of strings representing command-line options, and `$defaultProperties` is an instance of `Ice_Properties` that supplies default values for properties.

As an example, an application can configure a communicator as shown below:

**PHP**

```

$initData = new Ice_InitializationData;
$initData->properties = Ice_createProperties();
$initData->properties->setProperty("Ice.Trace.Network", "1");
...
$ICE = Ice_initialize($initData);

```

**PHP namespaces**

This release includes optional support for PHP namespaces, which was introduced in PHP 5.3. Support for PHP namespaces is disabled by default; to enable it, you must build the Ice extension from source code with `USE_NAMESPACES=yes` (see `Make.rules` or `Make.rules.mk` in the `php/config` subdirectory). Note that the extension only supports one mapping style at a time; installing a namespace-enabled version of the extension requires all Ice applications on the target Web server to use namespaces.

With namespace support enabled, you must modify your script to include a different version of the core Ice types:

**PHP**

```
require 'Ice_ns.php'; // Namespace version of Ice.php
```

You must also recompile your Slice files using the `-n` option to generate namespace-compatible code:

```
% slice2php -n MySliceFile.ice
```

This mapping translates Slice modules into PHP namespaces instead of using the "flattened" (underscore) naming scheme. For example, `Ice_Properties` becomes `\Ice\Properties` in the namespace mapping. However, applications can still refer to global Ice functions by their traditional names (such as `Ice_initialize`) or by their namespace equivalents (`\Ice\initialize`).

**Run-time exceptions in PHP**

As mentioned earlier, prior releases of Ice for PHP only supported a limited subset of the standard [run-time exceptions](#). An occurrence of an unsupported local exception was mapped to `Ice_UnknownLocalException`.

This release adds support for all local exceptions, which allows an application to more easily react to certain types of errors:



### PHP

```
try
{
 $proxy->sayHello();
}
catch(Ice_ConnectionLostException $ex)
{
 // Handle connection loss
}
catch(Ice_LocalException $ex)
{
 // Handle other errors
}
```

This change represents a potential backward compatibility issue: applications that previously caught `Ice_UnknownLocalException` may need to be modified to catch the intended exception instead.

## Downcasting in PHP

In prior releases, to downcast a proxy you had to invoke the `ice_checkedCast` or `ice_uncheckedCast` method on a proxy and supply a type ID:

### PHP

```
$hello = $proxy->ice_checkedCast("::Demo::Hello");
```

This API is susceptible to run-time errors because no validation is performed on the type ID string. For example, renaming the `Hello` interface to `Greeting` requires that you not only change all occurrences of `Demo_Hello` to `Demo_Greeting`, but also fix any type ID strings that your code might have embedded. The PHP interpreter does not provide any assistance if you forget to make this change, and you will only discover it when that particular line of code is executed and fails.

To improve this situation, a minimal class is now generated for each proxy type. The purpose of this class is to supply `checkedCast` and `uncheckedCast` static methods:

### PHP

```
class Demo_HelloPrx
{
 public static function checkedCast($proxy, $facetOrCtx=null,
 $ctx=null);

 public static function uncheckedCast($proxy, $facet=null);
}
```

Now your application can downcast a proxy as follows:

**PHP**

```
$hello = Demo_HelloPrx::checkedCast($proxy);
```

You can continue to use `ice_checkedCast` and `ice_uncheckedCast` but we recommend migrating your application to the new methods.

## Other API changes for PHP

This section describes additional changes to the Ice API in this release:

- The global variable `$ICE` is no longer defined. An application must now initialize its own communicator as [described above](#).
- Removed the following communicator methods:

**PHP**

```
$ICE->setProperty()
$ICE->getProperty()
```

The equivalent methods are:

**PHP**

```
$communicator->getProperties()->setProperty()
$communicator->getProperties()->getProperty()
```

- Removed the following global functions:

**PHP**

```
Ice_stringToIdentity()
Ice_identityToString()
```

The equivalent methods are:

**PHP**

```
$communicator->stringToIdentity()
$communicator->identityToString()
```

- These functions have also been removed:

**PHP**

```
Ice_loadProfile()
Ice_loadProfileWithArgs()
Ice_dumpProfile()
```

Refer to [PHP configuration](#) for more information.

## Thread pool changes in Ice 3.4

A [thread pool](#) supports the ability to automatically grow and shrink as the demand for threads changes, within the limits set by the thread pool's configuration. In prior releases, the rate at which a thread pool shrinks was not configurable, but Ice 3.4.0 introduces the [ThreadIdleTime](#) property to allow you to specify how long a thread pool thread must remain idle before it terminates to conserve resources.

## IceSSL changes in Ice 3.4

With the addition of the `ConnectionInfo` classes in this release, the `IceSSL::ConnectionInfo` structure has changed from a native type to a Slice class. This change has several implications for existing applications:

- As a Slice class, `IceSSL::ConnectionInfo` cannot provide the X509 certificate chain in its native form, therefore the chain is provided as a sequence of strings representing the encoded form of each certificate. You can use language-specific facilities to convert these strings back to certificate objects.
- For your convenience, we have added a native subclass of `IceSSL::ConnectionInfo` called `IceSSL::NativeConnectionInfo`. This class provides the certificate chain as certificate objects.
- The `CertificateVerifier` interface now uses `NativeConnectionInfo` instead of `ConnectionInfo`. If your application configures a custom certificate verifier, you will need to modify your implementation accordingly.
- In C++, also note that `NativeConnectionInfo`s are now managed by a smart pointer, therefore the signature of the certificate verifier method becomes the following:

**C++**

```
virtual bool verify(const IceSSL::NativeConnectionInfoPtr&) = 0;
```

- The `getConnectionInfo` helper function has been removed because its functionality has been replaced by the `Connection::getConnectionInfoOperation`. For example, in prior releases a C++ application would do the following:

**C++**

```
Ice::ConnectionPtr con = ...
IceSSL::ConnectionInfo info = IceSSL::getConnectionInfo(con);
```

Now the application should do this:

**C++**

```
Ice::ConnectionPtr con = ...
IceSSL::ConnectionInfoPtr info =
IceSSL::ConnectionInfoPtr::dynamicCast(con->getInfo());
```

Alternatively, the application can downcast to the native class:

**C++**

```
Ice::ConnectionPtr con = ...
IceSSL::NativeConnectionInfoPtr info =
IceSSL::NativeConnectionInfoPtr::dynamicCast(con->getInfo());
```

## Migrating IceStorm and IceGrid databases from Ice 3.3

No changes were made to the database schema for IceStorm or IceGrid in this release. However, you still need to update your databases as described [below](#).

## Migrating Freeze databases from Ice 3.3

No changes were made that would affect the content of your [Freeze](#) databases. However, we upgraded the version of Berkeley DB, therefore when upgrading to Ice 3.4 you must also upgrade your database to the Berkeley DB 4.8 format. The only change that affects Freeze is the format of Berkeley DB's log file.

The instructions below assume that the database environment to be upgraded resides in a directory named `db` in the current working directory. For a more detailed discussion of database migration, please refer to the [Berkeley DB Upgrade Process](#).

To migrate your database:

1. Shut down the old version of the application.
2. Make a backup copy of the database environment:

```
> cp -r db backup.db (Unix)
> xcopy /E db backup.db (Windows)
```

3. Locate the correct version of the Berkeley DB recovery tool (usually named `db_recover`). It is essential that you use the `db_recover` executable that matches the Berkeley DB version of your existing Ice release. For Ice 3.3, use `db_recover` from Berkeley DB 4.6. You can verify the version of your `db_recover` tool by running it with the `-v` option:

```
> db_recover -v
```

4. Use the `db_recover` tool to run recovery on the database environment:

```
> db_recover -h db
```

5. Recompile and install the new version of the application.
6. Force a checkpoint using the `db_checkpoint` utility. Note that you must use the `db_checkpoint` utility from Berkeley DB 4.8 when performing this step.

```
> db_checkpoint -l -h db
```

7. Restart the application.

## Removed APIs in Ice 3.4.0

This section describes APIs that were deprecated in a previous release and have now been removed. Your application may no longer compile successfully if it relies on one of these APIs.

The following APIs were removed in Ice 3.4.0:

- `Glacier2.AddUserToAllowCategories`  
Use `Glacier2.Filter.Category.AcceptUser` instead.
- `Glacier2.AllowCategories`  
Use `Glacier2.Filter.Category.Accept` instead.
- `Ice.UseEventLog`  
Ice services (applications that use the C++ class `Ice::Service`) always use the Windows event log by default.
- `Communicator::setDefaultContext`
- `Communicator::getDefaultContext`
- `ObjectPrx:ice_defaultContext`  
Use the communicator's [implicit request context](#) instead.
- `nonmutating` keyword  
This keyword is no longer supported.
- `Freeze.UseNonmutating`  
Support for this property was removed along with the `nonmutating` keyword.
- `Ice::NegativeSizeException`  
The run time now throws `UnmarshalOutOfBoundsException` or `MarshalException` instead.
- `slice2docbook`  
This utility is no longer included in Ice.
- `Ice::AMD_Array_Object_ice_invoke`  
A new overloading of `ice_response` in the `AMD_Object_ice_invoke` class makes `AMD_Array_Object_ice_invoke` obsolete.
- Java2 mapping  
The Java2 mapping is no longer supported. Refer to [Java language mapping changes in Ice 3.4](#) for more information.

## Deprecated APIs in Ice 3.4.0

This section discusses APIs and components that are now deprecated. These APIs will be removed in a future Ice release, therefore we encourage you to update your applications and eliminate the use of these APIs as soon as possible.

The following APIs were deprecated in Ice 3.4.0:

- Asynchronous Method Invocation (AMI) interface  
The AMI interface in Ice 3.3 and earlier is now deprecated for C++, Java, and C#.

- `Glacier2.AddSSLContext`  
Replaced by `Glacier2.AddConnectionContext`.

- Standard platform methods should be used instead of the following:

Java	
<code>Ice.Object.ice_hash()</code>	<code>// Use hashCode</code>
<code>Ice.ObjectPrx.ice_getHash()</code>	<code>// Use hashCode</code>
<code>Ice.ObjectPrx.ice_toString()</code>	<code>// Use toString</code>

In Java, use `hashCode` and `toString`. In C#, use `GetHashCode` and `ToString`. In Ruby, use `hash` instead of `ice_getHash`.

- `Ice.Util.generateUUID()`  
In Java use `java.util.UUID.randomUUID().toString()`. In C# use `System.Guid.NewGuid().ToString()`.

## Upgrading your Application from Ice 3.2 or Earlier Releases

In addition to the information provided in [Upgrading your Application from Ice 3.3](#), users who are upgrading from Ice 3.2 or earlier should also review this page.

On this page:

- [Migrating IceStorm databases from Ice 3.2](#)
- [Migrating IceGrid databases from Ice 3.2](#)
- [Migrating Freeze databases from Ice 3.2](#)
- [Removed APIs in Ice 3.3](#)
  - [Thread per connection](#)
  - [.NET metadata](#)
  - [C++](#)
  - [Java](#)
  - [.NET](#)
  - [Python](#)
  - [General](#)
  - [Ice.LoggerPlugin](#)
- [Deprecated APIs in Ice 3.3](#)
  - [Sequences as dictionary keys](#)
  - [LocalObject](#)
  - [Ice.Trace.Location](#)
  - [Ice.Default.CollocationOptimization](#)
  - [<Adapter>.RegisterProcess](#)
  - [Ice.ServerId](#)
  - [Glacier2.Admin and IcePatch2.Admin](#)

### Migrating IceStorm databases from Ice 3.2

Ice 3.4 supports the migration of IceStorm databases from Ice 3.1 and from Ice 3.2. Migration from earlier Ice versions may work, but is not officially supported. If you require assistance with such migration, please contact [support@zeroc.com](mailto:support@zeroc.com).

To migrate, first stop your IceStorm servers.

Next, copy the IceStorm database environment to a second location:

```
$ cp -r db recovered.db
```

Locate the correct version of the Berkeley DB recovery tool (usually named `db_recover`). It is essential that you use the `db_recover` executable that matches the Berkeley DB version of your existing Ice release. For Ice 3.1, use `db_recover` from Berkeley DB 4.3.29. For Ice 3.2, use `db_recover` from Berkeley DB 4.5. You can verify the version of your `db_recover` tool by running it with the `-v` option:

```
$ db_recover -v
```

Now run the utility on your copy of the database environment:

```
$ db_recover -h recovered.db
```

Change to the location where you will store the database environments for IceStorm 3.4:

```
$ cd <new-location>
```

Next, run the `icestormmigrate` utility. The first argument is the path to the old database environment. The second argument is the path to the new database environment.

In this example we'll create a new directory `db` in which to store the migrated database environment:

```
$ mkdir db
$ icestormmigrate <path-to-recovered.db> db
```

Upon completion, the `db` directory contains the migrated IceStorm databases.

## Migrating IceGrid databases from Ice 3.2

Ice 3.4 supports the migration of IceGrid databases from Ice 3.1 and from Ice 3.2. Migration from earlier Ice versions may work, but is not officially supported. If you require assistance with such migration, please contact [support@zeroc.com](mailto:support@zeroc.com).

To migrate, first stop the IceGrid registry you wish to upgrade.

Next, copy the IceGrid database environment to a second location:

```
$ cp -r db recovered.db
```

Locate the correct version of the Berkeley DB recovery tool (usually named `db_recover`). It is essential that you use the `db_recover` executable that matches the Berkeley DB version of your existing Ice release. For Ice 3.1, use `db_recover` from Berkeley DB 4.3.29. For Ice 3.2, use `db_recover` from Berkeley DB 4.5. You can verify the version of your `db_recover` tool by running it with the `-v` option:

```
$ db_recover -v
```

Now run the utility on your copy of the database environment:

```
$ db_recover -h recovered.db
```

Change to the location where you will store the database environments for IceGrid 3.4:

```
$ cd <new-location>
```

Next, run the `upgradeicegrid.py` utility located in the `config` directory of your Ice distribution (or in `/usr/share/Ice-3.4.1` if using an RPM installation). The first argument is the path to the old database environment. The second argument is the path to the new database environment.

In this example we'll create a new directory `db` in which to store the migrated database environment:



```
$ mkdir db
$ upgradeicegrid.py <path-to-recovered.db> db
```

Upon completion, the `db` directory contains the migrated IceGrid databases.

By default, the migration utility assumes that the servers deployed with IceGrid also use Ice 3.4. If your servers still use an older Ice version, you need to specify the `--server-version` command-line option when running `upgradeicegrid.py`:

```
$ upgradeicegrid.py --server-version 3.2.1 <path-to-recovered.db> db
```

The migration utility will set the `server descriptor` attribute `ice-version` to the specified version and the IceGrid registry will generate configuration files compatible with the given version.

If you are upgrading the master IceGrid registry in a replicated environment and the slaves are still running, you should first restart the master registry in read-only mode using the `--readonly` option, for example:

```
$ icegridregistry --Ice.Config=config.master --readonly
```

Next, you can connect to the master registry with `icegridadmin` or the IceGrid administrative GUI to ensure that the database is correct. If everything looks fine, you can shutdown and restart the master registry without the `--readonly` option.

## Migrating Freeze databases from Ice 3.2

No changes were made that would affect the content of your `Freeze` databases. However, we upgraded the version of Berkeley DB, therefore when upgrading to Ice 3.4 you must also upgrade your database to the Berkeley DB 4.8 format. The only change that affects Freeze is the format of Berkeley DB's log file.

The instructions below assume that the database environment to be upgraded resides in a directory named `db` in the current working directory. For a more detailed discussion of database migration, please refer to the [Berkeley DB Upgrade Process](#).

To migrate your database:

1. Shut down the old version of the application.
2. Make a backup copy of the database environment:

```
> cp -r db backup.db (Unix)
> xcopy /E db backup.db (Windows)
```

3. Locate the correct version of the Berkeley DB recovery tool (usually named `db_recover`). It is essential that you use the `db_recover` executable that matches the Berkeley DB version of your existing Ice release. For Ice 3.1, use `db_recover` from Berkeley DB 4.3.29. For Ice 3.2, use `db_recover` from Berkeley DB 4.5. You can verify the version of your `db_recover` tool by running it with the `-v` option:

```
> db_recover -V
```

4. Use the `db_recover` tool to run recovery on the database environment:

```
> db_recover -h db
```

5. Recompile and install the new version of the application.
6. Force a checkpoint using the `db_checkpoint` utility. Note that you must use the `db_checkpoint` utility from Berkeley DB 4.8 when performing this step.

```
> db_checkpoint -l -h db
```

7. Restart the application.

## Removed APIs in Ice 3.3

This section describes APIs that were deprecated in a previous release and have been removed in Ice 3.3. Your application may no longer compile successfully if it relies on one of these APIs.

Please refer to [Removed APIs in Ice 3.4.0](#) for information on APIs that were removed in Ice 3.4.

## Thread per connection

The primary purpose of this concurrency model was to serialize the requests received over a connection, either because the application needed to ensure that requests are dispatched in the order they are received, or because the application did not want to implement the synchronization that might be required when using the [thread pool](#) concurrency model.

Another reason for using the thread-per-connection concurrency model is that it was required by the [IceSSL](#) plug-ins for Java and C#. This requirement has been eliminated.

The ability to serialize requests is now provided by the thread pool and enabled via a new configuration property:

```
<threadpool>.Serialize=1
```

Please refer to the [manual](#) for more details on this feature.

Aside from the potential semantic changes involved in migrating your application to the thread pool concurrency model, other artifacts of thread-per-connection may be present in your application and must be removed:

- The configuration properties `Ice.ThreadPerConnection` and `<proxy>.ThreadPerConnection`
- The proxy methods `ice_threadPerConnection` and `ice_isThreadPerConnection`

## .NET metadata

The metadata directive `cs:collection` is no longer valid. Use `[ "clr:collection" ]` instead.

## C++

The following C++ methods have been removed:

- `Application::main(int, char*[], const char*, const Ice::LoggerPtr&)`

Use `Application::main(int, char*[], const InitializationData&)` instead.

- `initializeWithLogger`
- `initializeWithProperties`

- `initializeWithPropertiesAndLogger`

Use `initialize(int, char*[], const InitializationData&)` instead.

- `stringToIdentity`
- `identityToString`

Use the equivalent [operations](#) on `Communicator`.

## Java

The following methods have been removed:

- `Application.main(String, String[], String, Logger)`

Use `Application.main(String, String[], InitializationData)` instead.

- `initializeWithLogger`
- `initializeWithProperties`
- `initializeWithPropertiesAndLogger`

Use `initialize(String[], InitializationData)` instead.

## .NET

The following methods have been removed:

- `Application.main(string, string[], string, Logger)`

Use `Application.main(string, string[], InitializationData)` instead.

- `initializeWithLogger`
- `initializeWithProperties`
- `initializeWithPropertiesAndLogger`

Use `initialize(ref string[], InitializationData)` instead.

## Python

The following methods have been removed:

- `initializeWithLogger`
- `initializeWithProperties`
- `initializeWithPropertiesAndLogger`

Use `initialize(args, initializationData)` instead.

- `stringToIdentity`
- `identityToString`

Use the equivalent [operations](#) on `Communicator`.

## General

The following methods have been removed:

- `ice_hash`
- `ice_communicator`
- `ice_collocationOptimization`

- `ice_connection`  
These proxy methods were replaced by ones of the form `ice_get...`, such as `ice_getCommunicator`. `ice_collocationOptimization` is now `ice_getCollocationOptimized`.
- `ice_newIdentity`
- `ice_newContext`
- `ice_newFacet`
- `ice_newAdapterId`
- `ice_newEndpoints`  
These proxy methods were replaced by ones that do not use `new` in their names. For example, `ice_newIdentity` was replaced by `ice_identity`.

## Ice.LoggerPlugin

This property provided a way to install a custom logger implementation. It has been replaced by a more [generalized facility](#) for installing custom loggers.

## Deprecated APIs in Ice 3.3

This section discusses APIs and components that are deprecated in Ice 3.3. These APIs will be removed in a future Ice release, therefore we encourage you to update your applications and eliminate the use of these APIs as soon as possible.

Please refer to [Deprecated APIs in Ice 3.4.0](#) for information on APIs that were deprecated in Ice 3.4.

## Sequences as dictionary keys

The use of sequences, and structures containing sequences, as the key type of a Slice dictionary is now deprecated.

## LocalObject

The mappings for the `LocalObject` type have changed in Java, .NET, and Python. The new mappings are shown below:

Java	<code>java.lang.Object</code>
.NET	<code>System.Object</code>
Python	<code>object</code>

The types `Ice.LocalObject` and `Ice.LocalObjectImpl` are deprecated.

## Ice.Trace.Location

This property has been replaced by `Ice.Trace.Locator`.

## Ice.Default.CollocationOptimization

This property, as well as the corresponding proxy property, have been replaced by `Ice.Default.CollocationOptimized` and `<proxy>.CollocationOptimized`, respectively.

## <Adapter>.RegisterProcess

This property caused the Ice run time to register a proxy with the locator registry (e.g., `IceGrid`) that allowed the process to be shut down remotely. The new [administrative facility](#) has replaced this functionality.

## Ice.ServerId

As with `<Adapter>.RegisterProcess`, this property was used primarily for IceGrid integration and has been replaced by a similar mechanism in the [administrative facility](#).

### **Glacier2.Admin and IcePatch2.Admin**

These are the names of administrative object adapters in [Glacier2](#) and [IcePatch2](#), respectively. The functionality offered by these object adapters has been replaced by that of the [administrative facility](#), therefore these adapters (and their associated configuration properties) are deprecated.

## Platform Notes for Ice 3.5

This page provides platform-specific notes for Ice 3.5.

On this page:

- [Supported platforms for Ice 3.5](#)
- [IceGrid Admin GUI requirements for Ice 3.5](#)
- [Linux notes for Ice 3.5](#)
  - [Mono host names](#)
  - [IBM JDK jurisdiction policy files](#)
- [Windows notes for Ice 3.5](#)
  - [Relocated .NET assemblies](#)
  - [Visual Studio compiler warnings](#)
  - [IPv6 not supported in Java 6](#)
  - [Monotonic clock](#)

### Supported platforms for Ice 3.5

This release supports the operating systems, compilers, and run-time environments listed on the [ZeroC web site](#).

### IceGrid Admin GUI requirements for Ice 3.5

As of Ice 3.5.1, the [IceGrid graphical administrative utility](#) can be used with Java6 or Java7, however the [metrics graph](#) feature is only available when running with Java7 and JavaFX.

With Ice 3.5.0, the utility requires Java7 and JavaFX.

 JavaFX is included in recent releases of Java7.

### Linux notes for Ice 3.5

Linux users should be aware of the following issues.

#### Mono host names

Mono requires that a system's host name be correctly configured and that it resolves to an IP address. Otherwise, Mono is unable to determine the local IP addresses, which causes the creation of object adapters that listen on INADDR\_ANY/0.0.0.0 to fail with an `Ice.DNSException`.

#### IBM JDK jurisdiction policy files

The IBM JDK ships with limited jurisdiction policy files for the cryptographic libraries. More information, including a link to download unrestricted jurisdiction policy files, are available at the [DeveloperWorks](#) site.

Once you have downloaded the policy files, unpack them into this directory:

```
/usr/lib/jvm-private/java-1_6_0-ibm/jce/vanilla
```

### Windows notes for Ice 3.5

Windows users should be aware of the following issues.

## Relocated .NET assemblies

In previous releases, the .NET assemblies (*Ice.dll*, *IceSSL.dll*, etc.) were located in the `bin` subdirectory of the Ice installation directory, such as

```
C:\Program Files\ZeroC\Ice-3.4.2\bin
```

As of Ice 3.5, the .NET assemblies are stored in a separate subdirectory named `Assemblies`, as in

```
C:\Program Files\ZeroC\Ice-3.5.1\Assemblies
```

The Ice assembly for .NET Compact Framework can be found in `Assemblies\cf`.

The Ice Visual Studio Add-in automatically adds or updates the appropriate assembly references in your projects. If you do not use the Ice Visual Studio Add-in, you must update your project references to use the new location of the Ice assemblies.

Also note that this change means the `iceboxnet` executable, which still resides in `bin`, is no longer in the same directory as the Ice assemblies. For example, if your IceBox server configuration uses the IceSSL plug-in and relies on the fact that `iceboxnet.exe` and `IceSSL.dll` are in the same directory, you may need to update your configuration. Suppose your `iceboxnet` configuration included the following property:

```
Ice.Plugin.IceSSL=IceSSL:IceSSL.PluginFactory
```

Since `IceSSL.dll` was in the same directory as the executable, no additional information was necessary to assist Ice in locating the plug-in's assembly. Now, however, you will need to do one of the following:

- Use a path name for the IceSSL assembly:

```
Ice.Plugin.IceSSL="C:\Program Files\ZeroC\Ice-3.5.1\Assemblies\IceSSL.dll":IceSSL.PluginFactory
```

- Use a strong name for the IceSSL assembly:

```
Ice.Plugin.IceSSL="IceSSL,Version=3.5.1.0":IceSSL.PluginFactory
```

- Install the IceSSL assembly in the Global Assembly Cache (GAC)

## Visual Studio compiler warnings

In previous releases, public Ice header files disabled many Visual Studio compiler warnings. Now the header files disable only a minimal set of warnings, which means compiling your Ice application may produce compiler warnings that were not reported before. To eliminate these warnings, you can modify your source code, add `pragmas` or [disable these warnings](#) in your Visual Studio projects.

## IPv6 not supported in Java 6

IPv6 is not currently supported in Java 6 on Windows due to a [JVM bug](#).

## Monotonic clock

Ice uses the `QueryPerformanceCounter` Windows API function to measure time with a monotonic clock. If you are experiencing timing or performance issues, there are two knowledgebase articles that may be relevant for your system:

<http://support.microsoft.com/?id=896256>

<http://support.microsoft.com/?id=895980>

## Known Problems in Ice 3.5

This page describes the known problems Ice 3.5.

On this page:

- [Parameter limit for C++11 lambda functions with Visual C++](#)
- [Drag and drop failures in IceGrid Admin GUI](#)
- [Socket connection issue in Android emulator](#)
- [SSL issues in Java](#)
- [SSL issues in Android](#)
- [Visual Studio Add-in issues with Visual Studio 2010](#)
- [Solaris Java 7 issue](#)
- [SSL certificate issues with .NET on Windows XP](#)
- [IPv6 on Windows XP](#)
- [IPv6 hang in Java](#)

### Parameter limit for C++11 lambda functions with Visual C++

Ice 3.5 supports the use of [lambda functions as AMI callbacks](#) for C++11 compilers, including Visual Studio 2010 and 2012. However, neither compiler supports [variadic templates](#), and the macros the compilers use to simulate this feature are limited to at most ten parameters. (Visual Studio 2012 actually has a default limit of five parameters, but this can be increased to as many as ten by defining `_VARIADIC_MAX`.) As a result, you can only use the type-safe callback API for Slice operations containing ten or fewer output parameters, including a non-void return value; operations that exceed this limit cause a compilation error. The generic callback API is not affected by this issue. The next Ice release will include a work-around that disables the type-safe callback API for operations with more than ten output parameters. Support for true variadic templates will only be included in Visual Studio 2013.

### Drag and drop failures in IceGrid Admin GUI

A JavaFX bug can generate `NullPointerException` errors when using drag & drop in the [IceGrid graphical administration tool](#). This bug is fixed in Java7u10.

### Socket connection issue in Android emulator

An Ice application that attempts to connect to an invalid address can generate "spurious wakeup" messages in logcat when running under an emulator for Android 4.0 or later. This issue does not occur on hardware devices, however you can still experience lengthy delays before receiving an exception. As a defensive measure, it is a good idea to always set reasonable timeouts on your proxies to avoid unexpected delays.

### SSL issues in Java

When using the Ice for Java SSL plug-in (IceSSL), you may experience occasional hangs. The most likely reason is that your system's entropy pool is empty. If you have sufficient system privileges, you can solve this issue by editing the file `java.home/jre/lib/security/java.security` and changing it to use `/dev/urandom` instead of `/dev/random`. If you do not have permission to modify the security file, you can also use the command-line option shown below:

```
java -Djava.security.egd=file:/dev/urandom MyClass ...
```

### SSL issues in Android

Ice for Android supports the use of SSL on Android 2.3 or later.

A limitation in Android 2.3 prevents the use of client certificates. Ice servers that support Android 2.3 clients must set `IceSSL.VerifyPeer=0` to allow an incoming connection to succeed without requiring the client to supply a certificate. The [property reference](#) discusses this



setting in more detail.

## Visual Studio Add-in issues with Visual Studio 2010

If you perform a custom Visual Studio 2010 installation selecting only "Visual C++" development tools, the Visual Studio Add-in will fail to load with an exception trying to load `stdole` assembly. The recommended workaround is to add "Visual C#" development tools in the Visual Studio 2010 installer.

## Solaris Java 7 issue

On Solaris with Java 7, an Ice application might print "spurious selector wake up" warnings. This is caused by the Java selector API not behaving as expected and can impact the performance of your Ice application. If you experience performance issues but do not see these warnings, it is also possible that you are affected by this issue as the warning only shows up after multiple spurious wake ups. Upgrading to Java 7u10 fixes this problem.

## SSL certificate issues with .NET on Windows XP

The SSL certificates included in the Ice source and demo distributions use the SHA256 hash algorithm for compatibility with iOS. Unfortunately, this algorithm is not supported when using .NET on Windows XP, so you will not be able to use the SSL-related .NET demos on this platform.

## IPv6 on Windows XP

Ice enables IPv6 by default on all platforms. On Windows XP, where IPv6 might not be enabled or supported (Java does not support IPv6 on Windows XP), this will cause an `Ice::SocketException` when Ice tries to create an IPv6 socket. To workaround this issue, you should explicitly disable IPv6 by setting the `Ice.IPv6` property to 0.

## IPv6 hang in Java

On systems with IPv6 enabled, you may experience [occasional hangs](#) the first time an Ice object adapter is activated within a JVM. A work-around is to disable IPv6 support by setting the Java property `java.net.preferIPv4Stack` to true. For example:

```
java -Djava.net.preferIPv4Stack=true MyClass ...
```

## Using the Windows Binary Distribution

This page provides important information for users of the Ice binary distribution on Windows platforms.

On this page:

- [Overview of the Windows binary distribution](#)
- [Setting up your Windows environment to use Ice](#)
  - [C++](#)
  - [.NET](#)
  - [.NET Compact Framework](#)
  - [Silverlight](#)
  - [Java](#)
  - [Android](#)
  - [Python](#)
  - [Ruby](#)
  - [PHP](#)
- [Managed code in Ice for .NET](#)
- [Using the sample programs on Windows](#)
- [Configuration files for IceGrid and Glacier2 services](#)
- [Starting the IceGrid Administrative Console on Windows](#)
- [Ice Visual Studio Add-In installation notes](#)
- [Ice installer registry key](#)
- [Third-party packages for Windows](#)

## Overview of the Windows binary distribution

The Ice binary distribution for Windows provides all Ice run time services and development tools to build Ice applications on Windows:

- for C++, using Visual Studio 2010 SP1 or Visual Studio 2012
- for .NET, using Visual Studio 2010 SP1 or Visual Studio 2012
- for .NET Compact Framework, using Visual Studio 2008 SP1
- for Silverlight, using Visual Studio 2010 SP1 or Visual Studio 2012
- for Java, using Java 6 or Java 7
- for Android, using Android 2.3 or later
- for Python, using Python 3.3
- for Ruby, using Ruby 1.9.3
- for PHP, using PHP 5.4

You only need the development environment for your target programming language to use this distribution. For example, if you want to build Ice applications in Java, you need to install a JDK, but do not need to install Visual Studio or Python.

## Setting up your Windows environment to use Ice

After installing Ice, read the relevant language-specific sections below to learn how to configure your environment and start programming with Ice.

### C++

To use Ice for C++ you need to add one or more of the Ice `bin` directories to your `PATH`. The changes you must make depend on your compiler and architecture, as listed below:

- Visual Studio 2010SP1, 32-bit

```
> set PATH=<Ice installation root directory>\bin;%PATH%
```

- Visual Studio 2010SP1, 64-bit

```
> set PATH=<Ice installation root directory>\bin;%PATH%
> set PATH=<Ice installation root directory>\bin\x64;%PATH%
```

The x64 directory must come first in your PATH.

- Visual Studio 2012, 32-bit

```
> set PATH=<Ice installation root directory>\bin\vc110;%PATH%
```

- Visual Studio 2012, 64-bit

```
> set PATH=<Ice installation root directory>\bin\vc110;%PATH%
> set PATH=<Ice installation root directory>\bin\vc110\x64;%PATH%
```

The x64 directory must come first in your PATH.

If you don't want to rely on the PATH environment variable to locate the Ice for C++ DLLs, you can also copy the DLLs into the same directory as your executable.

To compile Ice for C++ applications with Visual C++, you should use the [Ice Visual Studio Add-In](#).

To compile with Visual C++ Express where the Ice Visual Studio Add-in is not available, you need to configure Visual Studio manually. This involves adding the locations of the Ice header files, libraries, and executables to Visual Studio's configuration. Follow these steps:

1. Open a Windows command prompt
2. Change to your project directory: `cd Documents\My Project`
3. Copy `Ice.props` to your project directory: `copy $(ALLUSERSPROFILE)\ZeroC\Ice.props`
4. In Visual Studio, choose *View / Other Windows / Property Manager*
5. In the Property Manager window, select *Add Existing Property Sheet*
6. Add `Ice.props`

## Compiler Flags

The Release versions of the Ice libraries are compiled with `/MD` to select the multi-threaded Visual C++ run-time library, while the Debug versions use `/MDd` to select the debug multi-threaded run-time library. Both versions of the Ice libraries are compiled with `/EHsc` to select an [exception handling model](#).

Your application must be compiled with the same flags as the Ice libraries:

- Release: `/MD /EHsc`
- Debug: `/MDd /EHsc`

## .NET

### Locating the .NET assemblies

To use Ice for .NET, you can either copy the .NET assemblies to the directory of your executable or add the .NET assemblies to the Global Assembly Cache (GAC).

Copying the Ice for .NET assemblies to the executable directory is the simplest solution. You can set up your Visual Studio projects to copy the assemblies by setting the `Copy Local` property to `True`. To access this property in the Solution Explorer, open the `References` folder

of your project and click on the assembly to access its properties in the *Properties* panel.

You can also add the Ice for .NET assemblies to the GAC. To do this, open a command prompt window with Administrator privileges and use `gacutil`:

```
> gacutil /i <library.dll>
```

The `gacutil` tool is included with your Visual C# installation. For example, if you have installed Visual Studio 2010 in `C:\Program Files`, the path to `gacutil` is

```
C:\Program Files\Microsoft SDKs\Windows\v7.0A\bin\gacutil.exe
```

Once installed in the GAC, the assemblies will always be located correctly without having to set environment variables or copy them into the same directory as an executable.

### Line numbers for stack traces

If you want line numbers for stack traces, you must also install the PDB (.pdb) files in the GAC. Unfortunately, you cannot do this using Explorer, so you have to do it from the command line. Open a command shell window and navigate to `C:\Windows\Microsoft.NET\assembly\GAC_MSIL\Ice` (assuming `C:\Windows` is your system root). Doing a directory listing there, you will find a directory named `v4.0_3.5.1.0__<UUID>`, for example:

```
v4.0_3.5.1.0__cdd571ade22f2f16
```

Change to that directory (making sure that you use the correct version number for this release of Ice). In this directory, you will see the `Ice.dll` you installed into the GAC in the preceding step. Now copy the `Ice.pdb` file into this directory:

```
> copy <Ice installation root directory>\Assemblies\Ice.pdb
```

### Using protocol compression

The Ice for .NET run time implements protocol compression by dynamically loading the native library `bzip2.dll` from a directory in your `PATH`. Ice disables the protocol compression feature if it is unable to load the `bzip2` library successfully.

This DLL is included in your Ice distribution, therefore the Ice `bin` directory must be added to your `PATH`:

```
> set PATH=<Ice installation root directory>\bin;%PATH%
```

On 64-bit Windows, use the following setting instead:

```
> set PATH=<Ice installation root directory>\bin\x64;%PATH%
```

If the wrong `PATH` is set, the Ice run time prints a warning to the console when it detects a `bzip2.dll` format mismatch during start-up.

## .NET Compact Framework

The Ice assembly for the .NET Compact Framework is installed as `<Ice installation root directory>\Assemblies\cf\Ice.dll`. The [Visual Studio Add-in](#) detects a Smart Device project and automatically configures it to use the .NET CF version of the Ice assembly.

## Silverlight

The Ice assembly for Silverlight is installed as `<Ice installation root directory>\Assemblies\sl\Ice.dll`. The Visual Studio Add-in detects a Silverlight project and automatically configures it to use the Silverlight version of the Ice assembly.

## Java

To use Ice for Java, you must add `Ice.jar` to your CLASSPATH, as shown below:

```
> set CLASSPATH=<Ice installation root
directory>\lib\Ice.jar;%CLASSPATH%
```

If you intend to use Freeze for Java, you must include `Freeze.jar` in your CLASSPATH along with `Ice.jar`:

```
> set CLASSPATH=<Ice installation root
directory>\lib\Freeze.jar;%CLASSPATH%
```

Classes for the other Ice services are provided in separate JAR files:

- `Glacier2.jar`
- `IceBox.jar`
- `IceGrid.jar`
- `IcePatch2.jar`
- `IceStorm.jar`

If your application uses any of these services, add the appropriate JAR files to your CLASSPATH as shown above.

To use a Freeze demo, the JVM requires that the directory containing Berkeley DB's native libraries be included in `java.library.path`, therefore you must add this directory to your PATH:

```
> set PATH=<Ice installation root directory>\bin;%PATH%
```

For a 64-bit JVM, use the following setting instead:

```
> set PATH=<Ice installation root directory>\bin\x64;%PATH%
```

Ice for Java supports protocol compression using the `bzip2` classes included with `ant`. Compression is automatically enabled if these classes are present in your CLASSPATH. You can either add `ant.jar` to your CLASSPATH, or download only the `bzip2` classes from

<http://www.kohsuke.org/bzip2/>

Note that these classes are a pure Java implementation of the `bzip2` algorithm and therefore add significant latency to Ice requests.

## Eclipse Development

ZeroC has created a [Slice2Java plug-in](#) for Eclipse that automates the translation of your Slice files. If you use Eclipse, we strongly recommend using this plug-in for your own development.



The Slice2Java plug-in is required if you intend to build any of the Android sample projects included in this distribution.

For installation instructions, please refer to the [ZeroC web site](#). The manual provides more information about configuring the plug-in and using it in your projects.

## Android

Ice requires Android 2.3 or later. Aside from that, there are no other special requirements for using Ice in an Android application. We strongly recommend installing our [Slice2Java plug-in for Eclipse](#) to automate the compilation of your Slice definitions.

## Python

To use Ice for Python, you must add the Ice `bin` directory to your `PATH` and set `PYTHONPATH` so that the Python interpreter is able to load the Ice extension. For a 32-bit Python installation, use these settings:

```
> set PATH=<Ice installation root directory>\bin;%PATH%
> set PYTHONPATH=<Ice installation root directory>\python
```

For a 64-bit Python installation, use these settings instead:

```
> set PATH=<Ice installation root directory>\bin\x64;%PATH%
> set PYTHONPATH=<Ice installation root directory>\python\x64
```

## Ruby

To use Ice for Ruby, you must add the Ice `bin` directory to your `PATH`:

```
> set PATH=<Ice installation root directory>\bin;%PATH%
```

You must also set `RUBYLIB` so that the Ruby interpreter is able to load the Ice extension:

```
> set RUBYLIB=<Ice installation root directory>\ruby;%RUBYLIB%
```

## PHP

The binary distribution of PHP 5.4 for Windows is compiled with Visual Studio 2008 (Visual C++ 9) and therefore is not compatible with the Apache binaries provided by the Apache Software Foundation, which are compiled with Visual C++ 6.

The Ice extension for PHP included in this installer is also compiled with VC9 for compatibility with the PHP binary distribution. To use this extension, you will need a compatible PHP binary distribution as well as a compatible Web server. If you wish to use Apache, you can obtain a VC9 build of Apache from alternate sources.

If you require a version of the Ice extension for a different environment, you will need to compile the extension from source. Download the Ice source distribution and review the `php/INSTALL` file for details.

The PHP documentation describes how to configure the Apache servers for PHP, and the PHP installer may have already performed the necessary steps. We provide instructions below for configuring PHP to use the Ice extension. These instructions make several assumptions:

- Apache 2.2 is installed and configured to load PHP
- PHP is installed in `C:\Program Files\PHP`
- Ice is installed in `C:\Ice`

If you have a different installation, you will need to make the appropriate changes as you follow the instructions.

## 1. Verify your PHP installation

With Apache running, verify that PHP has been loaded successfully by creating a file in Apache's document directory (`htdocs`) called `phpinfo.php` that contains the following line:

```

PHP
<?php phpInfo();?>
```

Open the file in your browser using a URL such as

```
http://127.0.0.1/phpinfo.php
```

If you have configured PHP correctly, you should see a long page of PHP configuration information. If you do not see this page, or an error occurs, check Apache's error log as well as the Windows event log for more information. Also note that you may need to restart Apache if it was running at the time you installed PHP.

## 2. Determine the location of your PHP configuration file

Review the settings on the browser page for an entry titled `Loaded Configuration File`. It will have a value such as

```
C:\Program Files\PHP\php.ini
```

As an administrator, open this file in a text editor and append the following line:

```
extension = php_ice.dll
```

The file `php_ice.dll` contains the Ice extension for PHP.

## 3. Install the Ice extension DLL

Look for the `extension_dir` setting in the browser page or in PHP's configuration file. It typically has the following value by default:

```
extension_dir = "C:\Program Files\PHP\ext"
```

If instead the `extension_dir` setting contains a relative path, it is resolved relative to the working directory of the Apache process (Apache's working directory is usually its installation directory).

Copy the DLL for the Ice extension to PHP's extension directory:

```
> copy C:\Ice\bin\php_ice.dll "C:\Program Files\PHP\ext"
```

## 4. Verify that Apache can load dependent libraries

Regardless of the location of PHP's extension directory, the Ice extension's dependent libraries must be located in Apache's executable search path.

The Ice extension depends on the following libraries:

- `bzip2_vc90.dll`
- `ice35_vc90.dll`
- `iceutil35_vc90.dll`
- `slice35_vc90.dll`

All of these files can be found in the `bin` subdirectory of your Ice installation (e.g., `C:\Ice\bin`). Apache must be able to locate these DLLs during startup, and several alternatives are available:

- Add the Ice installation directory to the system `PATH`. Using the `System` control panel, change the system `PATH` to include `C:\Ice\`

bin. Note that Windows must be restarted for this change to take effect.

- Copy the dependent libraries to Apache's installation directory.
- Copy the dependent libraries to the Windows system directory (C:\WINDOWS\system32). We do not recommend this option.

If Apache cannot find or access a DLL, Apache startup may fail with an access violation, or the PHP module may ignore the Ice extension and continue its initialization. Consequently, a successful Apache startup does not necessarily mean that the Ice extension has been loaded. Unfortunately, the message reported by PHP in Apache's error log is not very helpful; the error might imply that it cannot find `php_ice.dll` when in fact it was able to open `php_ice.dll` but a dependent DLL was missing or inaccessible.

## 5. Review access rights

Review the access rights on PHP's extension directory, the Ice extension DLL, and its dependent libraries. When running as a Windows service, Apache runs in the `Local System` account (also known as `NT Authority\SYSTEM`). You can use the `cacls` utility in a command window to view and modify access rights. For example, run the following commands to review the current access rights of the Ice extension:

```
> cd \Program Files\PHP\ext
> cacls php_ice.dll
```

## 6. Restart Apache

Restart Apache and verify that the PHP module and the Ice extension have been loaded successfully. After reloading the `phpinfo.php` page in your browser, scan the entries for a section titled `ice`. The presence of this section indicates that the extension was loaded.

If Apache does not start, check the Windows Event Viewer as well as Apache's log files for more information. The most likely reasons for Apache to fail at startup are missing DLLs (see step 4) or insufficient access rights (see step 5).

## 7. Locate the Ice run time files

Your application will also need to include at least some of the Ice for PHP run-time source files (installed in `C:\Ice\php`). To make these files available to your application, you can either modify PHP's include path or copy the necessary files to a directory that is already in the interpreter's include path. You can determine the current include path by loading the `phpinfo.php` page in your browser and searching for an entry named `include_path`.

If you want to make the Ice run-time files available to all PHP applications on the host, you can modify the `include_path` setting in `php.ini` to add the installation directory:

```
include_path = C:\Ice\php;...
```

Another option is to modify the include path from within your script prior to including any Ice run-time file:

```
PHP
ini_set('include_path', ini_get('include_path') . PATH_SEPARATOR .
'C:/Ice/php')
require 'Ice.php'; // Load the core Ice run time definitions.
```

## Managed code in Ice for .NET

The main Ice for .NET assembly (`Ice.dll`) included in the Windows binary distribution uses unmanaged code. If you require only managed



code then you can download the Ice source distribution and build Ice for .NET in a purely managed version. Note that the managed version of Ice for .NET omits support for protocol compression and for signal handling in the `Ice.Application` class.

You can download the source distribution at the [ZeroC web site](#).

## Using the sample programs on Windows

During installation, [sample programs](#) for all supported programming languages are installed by default in a sub-folder of the `Documents` or `My Documents` folder of the user who performed this installation. You'll find a shortcut to this directory in your Start menu. You can also [download](#) a ZIP archive of these sample programs and extract the archive in a folder of your choice.

## Configuration files for IceGrid and Glacier2 services

The `config` subdirectory of your Ice installation includes sample configuration files for the Glacier2 router, IceGrid node, and IceGrid registry. These files provide a good starting point on which to base your own configurations, and they contain comments that describe the settings in detail.

If you intend to edit one of the configuration files but you have installed your distribution into `\Program Files` or `\Program Files (x86)` on Windows Vista or later, be aware that Windows makes it difficult to make permanent modifications to files in these directories. We recommend copying the files to the location of your choice. For more information on this topic, refer to the [Virtualization](#) section of [New UAC Technologies for Windows Vista](#).

The [Ice manual](#) provides more information on installing and running the IceGrid registry, IceGrid node, and Glacier2 router as Windows services.

## Starting the IceGrid Administrative Console on Windows

You can launch the IceGrid Administrative Console using the shortcut that the Ice installer created in your Start menu as **IceGrid Admin**. The console is a Java program and requires JRE 7u6 or later.

## Ice Visual Studio Add-In installation notes

The Ice binary distribution includes an add-in for Visual Studio that helps to create and manage projects with Slice files. The [Ice Visual Studio Add-In](#) supports C++, .NET, .NET Compact Framework, and Silverlight projects.



The add-in does not support Visual Studio Express editions because Microsoft does not permit add-ins to be written for Express editions of Visual Studio.

The installer for the Ice binary distribution detects if Visual Studio 2008, Visual Studio 2010, or Visual Studio 2012 is installed on the target computer and configures the corresponding Ice add-in for all users. If you install Visual Studio *after* installing Ice, you will have to re-run the Ice installer and choose **Repair** to install the add-in.

## Ice installer registry key

The Ice installer adds information to the Windows registry to indicate where it was installed. Developers can use this information to locate the Ice files in their applications.

The registration key used by this installer is:

```
HKEY_LOCAL_MACHINE\Software\ZeroC\Ice 3.5.1
```

The install location is stored as a string value named `InstallDir`.

## Third-party packages for Windows

The binary distribution for Windows includes the following third-party packages as separate binary libraries:

- Berkeley DB 5.3.21 (C/C++ and Java run time)
- Bzip2 1.0.6 (C run time)
- Expat 2.1.0 (C run time)
- OpenSSL 1.0.1e (C run time)

## Using the Linux Binary Distributions

This page provides important information for users of the Ice binary distributions on Linux platforms. You can obtain these distributions at the [ZeroC web site](#).

On this page:

- [Overview of the Ice Binary Distributions for Linux](#)
  - [RPM Packages](#)
  - [DEB Packages](#)
- [Setting up your Linux environment to use Ice](#)
  - [C++](#)
  - [Java](#)
  - [Android](#)
  - [Python](#)
  - [Mono](#)
  - [Ruby](#)
  - [PHP](#)
- [Using the sample programs on Linux](#)
- [Startup scripts for IceGrid and Glacier2 services](#)

## Overview of the Ice Binary Distributions for Linux

### RPM Packages

ZeroC provides the following RPMs for Red Hat Enterprise Linux, SuSE Linux Enterprise Server, and Amazon Linux:

RPM	Description
<code>ice</code>	Slice files and related documentation
<code>ice-c++-devel</code>	C++ header files, libraries, and Slice compilers
<code>ice-java</code>	Java run time JAR files
<code>ice-java-devel</code>	Slice compilers and Ant tasks for Java development
<code>ice-libs</code>	C++ run-time libraries
<code>ice-mono</code>	Mono run-time assemblies
<code>ice-mono-devel</code>	Slice compiler and libraries for Mono development
<code>ice-php</code>	PHP extension and run time files
<code>ice-php-devel</code>	Slice compiler for PHP development
<code>ice-python</code>	Python extension and run time files
<code>ice-python-devel</code>	Slice compiler for Python development
<code>ice-ruby</code>	Ruby extension and run time files
<code>ice-ruby-devel</code>	Slice compiler for Ruby development
<code>ice-servers</code>	Server executables and sample <code>init.d</code> scripts
<code>ice-utils</code>	Utilities necessary for administering an Ice installation



The Mono RPMs are currently available only for SuSE Enterprise Linux Server.

ZeroC also supplies RPMs for the following third-party packages:

RPM	Description
db53	Berkeley DB 5.3.21 C and C++ run time libraries
db53-devel	C++ development files for Berkeley DB 5.3.21
db53-java	Berkeley DB 5.3.21 Java run time
db53-utils	Berkeley DB 5.3.21 command-line utilities
mcpp-devel	MCP C++ preprocessor library

The `db53-devel` and the `mcpp-devel` RPMs are only necessary for building Ice from source.

## DEB Packages

ZeroC provides the following DEB packages for Ubuntu 13.04:

Package	Description
ice	Meta package that installs all run-time packages, servers and utilities
ice-dev	Meta package that installs all development packages
ice3.5-common	Slice files and related documentation
libice3.5++	C++ run-time libraries
libice++-dev	C++ header files, libraries, and Slice compiler
libice3.5-java	Java run-time libraries
libice-java-dev	Slice compilers and Ant tasks for Java development
libice3.5-cil	Mono run-time assemblies
libice-cil-dev	Slice compiler and libraries for Mono development
libice3.5-php	PHP extension and run time files
libice-php-dev	Slice compiler for PHP development
libice3.5-python	Python extension and run time files
libice-python-dev	Slice compiler for Python development
libice3.5-ruby	Ruby extension and run time files
libice-ruby-dev	Slice compiler for Ruby development
ice-utils	Utilities necessary for administering an Ice installation
icebox	IceBox server for C++
icebox-cil	IceBox server for Mono
icegrid	IceGrid service
libicestorm3.5	IceStorm service

<code>glacier2</code>	Glacier2 service
<code>icepatch2</code>	IcePatch2 service
<code>libfreeze3.5++</code>	Freeze for C++ run-time libraries
<code>libfreeze3.5-java</code>	Freeze for Java run-time library
<code>libfreeze++-dev</code>	Freeze for C++ Slice compiler
<code>libfreeze-java-dev</code>	Freeze for Java Slice compiler

ZeroC also supplies the following third-party packages:

Package	Description
<code>libdb5.3</code>	Berkeley DB 5.3.21 C run-time libraries
<code>libdb5.3-dev</code>	C development files for Berkeley DB 5.3.21
<code>libdb5.3++</code>	Berkeley DB 5.3.21 C++ run-time libraries
<code>libdb5.3++-dev</code>	C++ development files for Berkeley DB 5.3.21
<code>libdb5.3-java</code>	Berkeley DB 5.3.21 Java run-time libraries
<code>db5.3-utils</code>	Berkeley DB 5.3.21 command-line utilities

The `libdb5.3-dev` and `libdb5.3++-dev` packages are only necessary for building Ice from source.

## Setting up your Linux environment to use Ice

After installing Ice, read the relevant language-specific sections below to learn how to configure your environment and start programming with Ice.

### C++

A C++ program needs to link with at least `libIce` and `libIceUtil`, so a typical link command would look like this:

```
$ CC -o myprogram myprogram.o -pthread -lIce -lIceUtil
```

Additional libraries are necessary if you are using an Ice service such as IceGrid or Glacier2.

 Always use the `-pthread` option when compiling and linking your Ice applications.

### Java

To use Ice for Java, you must add `Ice.jar` to your `CLASSPATH`, as shown below:

```
$ export CLASSPATH=/usr/share/java/Ice.jar:$CLASSPATH
```

If you intend to use Freeze for Java, you must include `Freeze.jar` and `db-5.3.21.jar` in your `CLASSPATH` along with `Ice.jar`:

```
$ export CLASSPATH=/usr/share/java/Freeze.jar:$CLASSPATH
$ export CLASSPATH=/usr/share/java/db-5.3.21.jar:$CLASSPATH
```

Classes for the other Ice services are provided in separate JAR files:

- Glacier2.jar
- IceBox.jar
- IceGrid.jar
- IcePatch2.jar
- IceStorm.jar

If your application uses any of these services, add the appropriate JAR files to your `CLASSPATH` as shown above.

The JVM also requires that the directory containing Berkeley DB's native libraries be listed in `java.library.path`, therefore you must add this directory to your `LD_LIBRARY_PATH`. Assuming you are using ZeroC's distribution of Berkeley DB, the bash command is shown below:

```
$ export LD_LIBRARY_PATH=/usr/lib:$LD_LIBRARY_PATH
(RHEL, SLES, Amazon)
$ export LD_LIBRARY_PATH=/usr/lib/i386-linux-gnu:$LD_LIBRARY_PATH
(Ubuntu)
```

On an `x86_64` system with a 64-bit JVM, the 64-bit Berkeley DB libraries are installed in a different directory:

```
$ export LD_LIBRARY_PATH=/usr/lib64:$LD_LIBRARY_PATH
(RHEL, SLES, Amazon)
$ export LD_LIBRARY_PATH=/usr/lib/x86_64-linux-gnu:$LD_LIBRARY_PATH
(Ubuntu)
```

Ice for Java supports protocol compression using the `bzip2` classes included with `ant`. Compression is automatically enabled if these classes are present in your `CLASSPATH`. You can either add `ant.jar` to your `CLASSPATH`, or download only the `bzip2` classes from

<http://www.kohsuke.org/bzip2/>

Note that these classes are a pure Java implementation of the `bzip2` algorithm and therefore add significant latency to Ice requests.

When using the Ice for Java SSL plugin (IceSSL), you may experience occasional hangs. The most likely reason is that your system's entropy pool is empty. If you have sufficient system privileges, you can solve this issue by editing the file

```
<java.home>/jre/lib/security/java.security
```

and changing it to use `/dev/urandom` instead of `/dev/random`. If you do not have permission to modify the security file, you can also use the command-line option shown below:

```
$ java -Djava.security.egd=file:/dev/urandom MyClass ...
```

On Linux systems with IPv6 enabled, you may experience occasional hangs the first time an Ice object adapter is activated within a JVM. A work-around is to disable IPv6 support by setting the Java property `java.net.preferIPv4Stack` to `true`. For example:

```
$ java -Djava.net.preferIPv4Stack=true MyClass ...
```

For more information on this issue, refer to the relevant [Java bug](#).

## Eclipse Development

ZeroC has created a [Slice2Java plug-in](#) for Eclipse that automates the translation of your Slice files. If you use Eclipse, we strongly recommend using this plug-in for your own development.

 The Slice2Java plug-in is required if you intend to build any of the Android projects included in the [sample programs](#).

For installation instructions, please refer to the [ZeroC web site](#). The [manual](#) provides more information about configuring the plug-in and using it in your projects.

## Android

Ice requires Android 2.3 or later. Aside from that, there are no other special requirements for using Ice in an Android application. We strongly recommend installing our [Slice2Java plug-in for Eclipse](#) to automate the compilation of your Slice definitions.

## Python

The Ice for Python run-time package installs the Ice extension and its associated Python files into the system packages directory. The installation also includes a `.pth` file that enables you to import the various Ice modules without requiring any additional configuration.

## Mono

ZeroC's run-time package adds the .NET run-time libraries to the global assembly cache (GAC), so that no changes to your environment are necessary to locate the assemblies.

The instructions for running the demos assume that you have configured your kernel to automatically execute the Mono interpreter. Visit the [Mono Project](#) for a description of how to configure your kernel to register Mono's .exe files as non-native binaries. If you don't want to configure your kernel, you will need to run executables with `mono`. For example,

```
$ mono server.exe
```

## Managed code

The main Ice for .NET assembly (`Ice.dll`) included in the distribution uses unmanaged code. If you require only managed code then you can download the Ice source distribution and build Ice for Mono in a purely managed version. Note that the managed version of Ice for Mono omits support for protocol compression.

You can download the source distribution at the [ZeroC web site](#).

## Ruby

The Ice for Ruby run-time package installs the Ice extension and its associated Ruby files into the `site_ruby` directory. No additional configuration is necessary to use Ice in your Ruby programs.

## PHP

The Ice extension for PHP is loaded automatically when the interpreter loads the contents of the file `/etc/php.d/ice.ini` (on Red Hat Enterprise Linux and Amazon Linux) or `/etc/php5/conf.d/ice.ini` (on SuSE Linux Enterprise Server and Ubuntu). This file contains the line shown below:

```
extension=IcePHP.so
```

You can modify this file to include additional [configuration directives](#).

At run time, the PHP interpreter requires the Ice shared libraries.

You can verify that the Ice extension is installed properly by examining the output of the `php -m` command, or by calling the `phpinfo()` function from a script.

Your application will also need to include at least some of the Ice for PHP run-time source files (installed in `/usr/share/php` on RHEL, Amazon Linux, and Ubuntu, and in `/usr/share/php5` on SLES). This installation directory is included in PHP's default include path, which you can verify by executing the following command:

```
% php -i | grep include_path
```

If the installation directory is listed, no further action is necessary to make the run-time source files available to your application. Otherwise, you can modify the `include_path` setting in `php.ini` to add the installation directory:

```
include_path = /usr/share/php:...
```

Another option is to modify the include path from within your script prior to including any Ice run-time file:

```
PHP
ini_set('include_path', ini_get('include_path') . PATH_SEPARATOR .
'/usr/share/php');
require 'Ice.php'; // Load the core Ice run time definitions.
```

## SELinux Notes (for Red Hat Enterprise Linux users)

SELinux augments the traditional Unix permissions with a number of new features. In particular, SELinux can prevent the `httpd` daemon from opening network connections and reading files without the proper SELinux types.

If you suspect that your PHP application does not work due to SELinux restrictions, we recommend that you first try it with SELinux disabled. As root, run:

```
setenforce 0
```

to disable SELinux until the next reboot of your computer.

If you want to run `httpd` with the Ice extension and SELinux enabled, you must do the following:

1. Allow `httpd` to open network connections:



```
setsebool httpd_can_network_connect=1
```

You can add the `-P` option to make this setting persistent across reboots.

1. Make sure any `.ice` file used by your PHP scripts can be read by `httpd`. The enclosing directory also needs to be accessible. For example:

```
chcon -R -t httpd_sys_content_t /opt/MyApp/slice
```

For more information on SELinux in Red Hat Enterprise Linux, refer to this [Red Hat document](#).

## Using the sample programs on Linux

Sample programs are provided in a separate archive, which can be downloaded from the [ZeroC web site](#).

## Startup scripts for IceGrid and Glacier2 services

The distributions include the following sample `/etc/init.d` scripts and associated configuration files:

- `/etc/init.d/icegridregistry` and `/etc/icegridregistry.conf`
- `/etc/init.d/icegridnode` and `/etc/icegridnode.conf`
- `/etc/init.d/glacier2router` and `/etc/glacier2router.conf`

The installation also creates a user account and group for running these services (account `ice` and group `ice`), and data directories for `icegridregistry` and `icegridnode` (`/var/lib/ice/icegrid/registry` and `/var/lib/ice/icegrid/node1`).

By default, all these services are off at all runlevels. You need to manually switch on one or more runlevels, for example:

```
#
On a Red Hat Enterprise Linux system, configure the icegridregistry
to start at runlevel 3 and 5:
#
chkconfig --level 35 icegridregistry on

#
On a SuSE Linux Enterprise Server system, configure the
icegridregistry to start at runlevel 3 and 5:
#
chkconfig icegridregistry 35

#
On an Ubuntu system, configure the icegridregistry to start at the
default run levels:
#
sudo update-rc.d icegridregistry defaults
```

Before doing so, please review the script itself and its associated configuration file.

## Using the OS X Binary Distribution

This page provides important information for users of the Ice binary distribution for OS X. You can obtain this distribution at the [ZeroC web site](#).

On this page:

- [Overview of the OS X binary distribution](#)
- [Setting up your OS X environment to use Ice](#)
  - [General requirements](#)
  - [C++](#)
  - [Java](#)
  - [Android](#)
  - [Python](#)
- [Using the sample programs on OS X](#)
- [Third-party packages for OS X](#)

### Overview of the OS X binary distribution

The binary distribution of Ice for OS X includes the following components:

- The Ice run time, including executables for the Ice services, and Slice files.
- Run time libraries for C++, Java, and Python. These libraries enable you to execute Ice applications.
- Tools and libraries for developing Ice applications.

The binary distribution was compiled on OS X 10.8 using Xcode 4.6. The binaries in this distribution are fat binaries with support for both Intel 32-bit and Intel 64-bit architectures.

The Ice extension for Python included in this distribution requires Python 2.7.2, installed with OS X 10.8.

The binaries are installed at the following locations:

- Ice in `/Library/Developer/Ice-3.5.1`
- IceGrid Administrative Console in `/Applications`
- Ice for Python in `/Library/Python/2.7/site-packages`

### Setting up your OS X environment to use Ice

After installing Ice, read the relevant language-specific sections below to learn how to configure your environment and start programming with Ice.

#### General requirements

In order to use Ice services and tools such as Slice translators, you need to add the location of the Ice binaries to your `PATH` as shown in the bash command below:

```
$ export PATH=<Ice installation directory>/bin:$PATH
```

If you run applications that load the IceSSL plug-in, you have to do one of the following in order to correctly load IceSSL:

- Set the `DYLD_LIBRARY_PATH` environment variable:

```
$ export DYLD_LIBRARY_PATH=<Ice installation
directory>/lib:$DYLD_LIBRARY_PATH
```

- Use a relative or absolute path for the IceSSL library in the IceSSL configuration:

```
Ice.Plugin.IceSSL=<Ice installation
directory>/lib/IceSSL:createIceSSL
```

 For C++11 builds you must use <Ice installation directory>/lib/c++11 instead of <Ice installation directory>/lib.

## C++

The Ice binary distribution for OS X includes two sets of libraries built with and without C++11 support. C++11 enabled libraries are installed in <Ice installation directory>/lib/c++11 and use LLVM libc++, while the libraries in <Ice installation directory>/lib use libstdc++ and do not support C++11 features.

When compiling Ice for C++ programs, you must pass the `-pthread` option and a `-I` option specifying the Ice include directory. A typical compile command would look like this:

```
$ c++ -I <Ice installation directory>/include -c -pthread myprogram.cpp
```

When linking a program you must pass the Ice library directory with the `-L` option and set the program run path using the `-rpath` linker option. Furthermore, a C++ program needs to link with at least `libIce` and `libIceUtil`. A typical link command would look like this:

```
$ c++ -o myprogram myprogram.o -Wl,-rpath,<Ice installation
directory>/lib -L<Ice installation directory>/lib -lIce -lIceUtil
```

Additional libraries are necessary if you are using an Ice service such as IceGrid or Glacier2.

To build fat binaries or binaries using an architecture that differs from the default architecture, you can specify the Clang `-arch` compiler flag. For example, use `-arch i386 -arch x86_64` to build Intel 32-bit and 64-bit fat binaries.

As shown in the previous example, we need to set the application run path when we link the application. This is required because Ice libraries use `@rpath` as the prefix in their install names, which allows the application developer to relocate the Ice libraries without needing to rebuild them. You should use the `/Library/Developer/Ice-3.5` symbolic link for the run path if you want your executables to automatically use new Ice patch releases. This symbolic link is updated by the Ice installer to point to the latest installed Ice version.

If you want to include Ice in your application bundle, you will need to copy the necessary Ice libraries to the `Contents/Frameworks` subdirectory of your bundle and use `@loader_path/./Frameworks` as the run path when linking the application.

Please refer to the `dyld` man page on your OS X system to learn more about `@rpath` and `@loader_path`.

 For C++11 builds you must use <Ice installation directory>/lib/c++11 instead of <Ice installation directory>/lib.

## Java

To use Ice for Java, you must add `Ice.jar` to your `CLASSPATH`, as shown below:

```
$ export CLASSPATH=<Ice installation directory>/lib/Ice.jar:$CLASSPATH
```

If you intend to use Freeze for Java, you must include `Freeze.jar` and `db.jar` in your `CLASSPATH` along with `Ice.jar`:

```
$ export CLASSPATH=<Ice installation
directory>/lib/Freeze.jar:$CLASSPATH
$ export CLASSPATH=<Ice installation directory>/lib/db.jar:$CLASSPATH
```

Classes for the other Ice services are provided in separate JAR files:

- `Glacier2.jar`
- `IceBox.jar`
- `IceGrid.jar`
- `IcePatch2.jar`
- `IceStorm.jar`

If your application uses any of these services, add the appropriate JAR files to your `CLASSPATH` as shown above.

The JVM also requires that the directory containing Berkeley DB's native libraries be listed in `java.library.path`, therefore you must add this directory to your `DYLD_LIBRARY_PATH`.

Ice includes ant tasks for translating Slice to Java. The ant tasks allow `slice2java` and `slice2freezej` to be invoked from the ant build system. These tasks require one of the following:

- Specify the location of the Ice installation containing the translators with the `ice.home` property:

```
$ ant -Dice.home=<Ice installation directory>
```

- Set the `ICE_HOME` environment variable to specify the location of the Ice installation containing the translators:

```
$ export ICE_HOME=<Ice installation directory>
```

- If neither `ice.home` nor `ICE_HOME` is available, the ant tasks will simply invoke the translator without an absolute path, relying on the translators being in a directory in your `PATH` for successful execution.

Ice for Java supports protocol compression using the `bzip2` classes included with ant. Compression is automatically enabled if these classes are present in your `CLASSPATH`. You can either add `ant.jar` to your `CLASSPATH`, or download only the `bzip2` classes from:

<http://www.kohsuke.org/bzip2/>

Note that these classes are a pure Java implementation of the `bzip2` algorithm and therefore add significant latency to Ice requests.

## Eclipse Development

ZeroC has created a [Slice2Java plug-in](#) for Eclipse that automates the translation of your Slice files. If you use Eclipse, we strongly recommend using this plug-in for your own development.



The Slice2Java plug-in is required if you intend to build any of the Android projects included in the [sample programs](#).

---

For installation instructions, please refer to the [ZeroC web site](#). The [manual](#) provides more information about configuring the plug-in and using it in your projects.

## Android

Ice requires Android 2.3 or later. Aside from that, there are no other special requirements for using Ice in an Android application. We strongly recommend installing our [Slice2Java plug-in for Eclipse](#) to automate the compilation of your Slice definitions.

## Python

The Ice for Python run-time installs the Ice extension and its associated Python files into the `site-packages` directory (`/Library/Python/2.7/site-packages`).

## Using the sample programs on OS X

[Sample programs](#) are provided in a separate archive, which can be downloaded from the [ZeroC web site](#).

## Third-party packages for OS X

The binary distribution for OS X includes the following third-party packages as separate binary libraries:

- Berkeley DB 5.3.21 (C/C++ and Java run time)

## Using the Solaris Binary Distribution

This page provides important information for users of the Ice binary distribution for Solaris. You can obtain this distribution at the [ZeroC web site](#).

On this page:

- [Overview of the Solaris binary distribution](#)
- [Setting up your Solaris environment to use Ice](#)
  - [General requirements](#)
  - [C++](#)
  - [Java](#)
- [Using the sample programs on Solaris](#)
- [Third-party packages for Solaris](#)

### Overview of the Solaris binary distribution

The binary distribution of Ice for Solaris 11 on SPARC includes the following components:

- The Ice run time, including executables for the Ice services and Slice files.
- Run-time libraries for C++ and Java. These libraries enable you to execute Ice applications.
- Tools and libraries for developing Ice applications.

The distribution contain executables and libraries in both 32-bit and 64-bit format. The 32-bit executables are in the `bin` directory and the 32-bit libraries are in the `lib` directory. The 64-bit executables are located in `bin/sparcv9`, and the 64-bit libraries are in `lib/64`.

The C++ binaries were created using Sun Studio 12.3 and its default standard library.

The following Solaris 11 binary packages are required to use this distribution:

- `compress/bzip2`
- `library/expat`
- `library/security/openssl`

Ice for Java requires J2SE 1.6.0 or later; Java binary packages can be obtained from [Oracle](#). The IceGrid Admin graphical tool is included in the distribution but the [metrics graph](#) feature is not supported because JavaFX is not available on this platform.

 If you are using Java 7, see this [Solaris Java 7 issue](#).

### Setting up your Solaris environment to use Ice

After installing Ice, read the relevant language-specific sections below to learn how to configure your environment and start programming with Ice.

#### General requirements

In order to use Ice services and tools such as Slice translators, you need to add the location of the Ice binaries to your `PATH` as shown in the bash command below:

```
$ export PATH=<Ice installation directory>/bin:$PATH
```

To use the 64-bit version of these services and tools, add the `sparcv9` subdirectory to `PATH`, making sure it appears before `bin`:

```
$ export PATH=<Ice installation directory>/bin:$PATH
$ export PATH=<Ice installation directory>/bin/sparcv9:$PATH
```

Ice shared libraries and executables in this distribution contain `/opt/Ice-3.5/lib` as the embedded runpath (the runpath for 64-bit libraries and executables is `/opt/Ice-3.5/lib/64`). In order to run Ice services and tools, you can do one of the following:

- Create a symbolic link `/opt/Ice-3.5` that points to your Ice installation:

```
$ ln -s <Ice installation directory> /opt/Ice-3.5
```

- Add the Ice lib directory to your `LD_LIBRARY_PATH` and `LD_LIBRARY_PATH_64` environment variables. For example:

```
$ export LD_LIBRARY_PATH=<Ice installation
directory>/lib:$LD_LIBRARY_PATH
$ export LD_LIBRARY_PATH_64=<Ice installation
directory>/lib/64:$LD_LIBRARY_PATH_64
```

## C++

When compiling Ice for C++ programs, you must pass a `-I` option specifying the Ice include directory, along with several other options:

```
CC -I <Ice installation directory>/include -c -mt +p -errtags
-erroff=wvarhidenmem,wvarhidemem,notemsource -m32 myprogram.cpp
```

Replace `-m32` with `-m64` to build 64-bit binaries.

A C++ program needs to link with at least `libIce` and `libIceUtil`, so a typical link command would look like this:

```
$ CC -mt -m32 -o myprogram myprogram.o -L<Ice installation
directory>/lib -lIce -lIceUtil -lpthread
```

Additional libraries are necessary if you are using an Ice service such as IceGrid or Glacier2.

## Java

To use Ice for Java, you must add `Ice.jar` to your `CLASSPATH`, as shown below:

```
$ export CLASSPATH=<Ice installation directory>/lib/Ice.jar:$CLASSPATH
```

If you intend to use Freeze for Java, you must include `Freeze.jar` and `db.jar` in your `CLASSPATH` along with `Ice.jar`:

```
$ export CLASSPATH=<Ice installation
directory>/lib/Freeze.jar:$CLASSPATH
$ export CLASSPATH=/usr/lib/db.jar:$CLASSPATH
```

Classes for the other Ice services are provided in separate JAR files:

- Glacier2.jar
- IceBox.jar
- IceGrid.jar
- IcePatch2.jar
- IceStorm.jar

If your application uses any of these services, add the appropriate JAR files to your `CLASSPATH` as shown above.

Ice includes ant tasks for translating Slice to Java. The ant tasks allow `slice2java` and `slice2freezej` to be invoked from the ant build system. These tasks require one of the following:

- Specify the location of the Ice installation containing the translators with the `ice.home` property:

```
ant -Dice.home=/home/bill/Ice-3.5.1
```

- Set the `ICE_HOME` environment variable to specify the location of the Ice installation containing the translators:

```
$ export ICE_HOME=/home/bill/Ice-3.5.1
```

- If neither `ice.home` nor `ICE_HOME` is available, the ant tasks will simply invoke the translator without an absolute path, relying on the translators being in a directory in your `PATH` for successful execution.

Ice for Java supports protocol compression using the `bzip2` classes included with ant. Compression is automatically enabled if these classes are present in your `CLASSPATH`. You can either add `ant.jar` to your `CLASSPATH`, or download only the `bzip2` classes from:

<http://www.kohsuke.org/bzip2/>

Note that these classes are a pure Java implementation of the `bzip2` algorithm and therefore add significant latency to Ice requests.

## Using the sample programs on Solaris

Sample programs are provided in a separate archive, which can be downloaded from the [ZeroC web site](#).

## Third-party packages for Solaris

The binary distribution for OS X includes the following third-party packages as separate binary libraries:

- Berkeley DB 5.3.21 (C/C++ and Java run time)



# Sample Programs

## Topics

- [Using the Sample Programs](#)
- [Using the Sample Programs on Windows](#)

## Using the Sample Programs

Sample programs are available for download for C++, Java, Android, C#, Visual Basic, Ruby, Python and PHP. Below you will find instructions for building and running these programs. The instructions assume that you have configured your platform according to the instructions in the [release notes](#).

On this page:

- [Building the Demos](#)
  - [Demo Prerequisites](#)
  - [Demo Build Instructions](#)
  - [Demo Build Instructions for Android](#)
- [Running the Ice Demos](#)
  - [Running the C++ demos](#)
  - [Running the Java demos](#)
  - [Running the Android demos](#)
  - [Running the C# demos](#)
  - [Running the Python demos](#)
  - [Running the Ruby demos](#)
  - [Running the PHP demos](#)

## Building the Demos

This section describes how to build the demos included in the Ice demo distribution.

The demo archive contains sample programs for each language mapping that Ice supports. Not all demos will build against all Ice distributions. Distributions for specific platform/tool combinations may not support every Ice language mapping.

Depending on the language mapping, various build tools are required for building the demos. The C++, C#, and PHP demos use makefiles, the Java demos use the Apache Foundation's ant build tool, and the Android demos require Eclipse and the [Slice2Java plug-in](#).



The Ruby and Python demos do not need to be built.

### Demo Prerequisites

The makefiles for C++, C#, and PHP require GNU make 3.80 or later. If your system does not come with GNU make, you can find information on how to acquire it at the following link:

<http://www.gnu.org/software/make/>

The Ice for Java demos require Ant 1.7.0, but we recommend using the most recent release available. Ant can be obtained at:

<http://ant.apache.org/bindownload.cgi>

The Ice for Android demos require Eclipse and the [Slice2Java plug-in](#). The demos were tested with Eclipse Helios (3.6).

<http://www.zeroc.com/eclipse.html>

### Demo Build Instructions

To build the demos you need to:

- Configure your system according to the directions in the [release notes](#) (for binary distributions) or the platform-specific `INSTALL` file (if you built Ice from sources).
- If you are using a non-RPM installation and you did not install Ice in its default location (`/opt/Ice-3.5.1`), set the environment variable `ICE_HOME` to point to your Ice installation root directory. For example, in a Bash shell:

```
$ export ICE_HOME=$HOME/testing/Ice-3.5.1
```

With a non-RPM installation, you also need to either create an `/opt/Ice-3.5` symbolic link (as described in the [release notes](#)), or add the Ice library directory to your shared library search path. For example, on Linux x86:

```
$ export LD_LIBRARY_PATH=$ICE_HOME/lib:$LD_LIBRARY_PATH
```

The Ice library directory is `$ICE_HOME/lib64` on Linux `x86_64` and `$ICE_HOME/lib/sparcv9` on Solaris for SPARC 64-bit.

- Review the build settings found in `config/Make.rules (C++)`, `config/Make.rules.cs (C#)`, `config/Make.rules.php (PHP)` and `config/build.properties (Java)` and adjust any you want changed. For example, for C++ and C#, set `OPTIMIZE=yes` in order to build with optimization, or for C++ set `LP64=yes` if you are building against a 64-bit Ice installation (on OS X, set `CXXARC_HFLAGS` to build 32-bit and 64-bit FAT binaries).
- Build the demos. For example:

```
C++ demos
$ cd Ice-3.5.1-demos/demo
$ make
C# demos
$ cd Ice-3.5.1-demos/democs
$ make
PHP demos
$ cd Ice-3.5.1-demos/demophp
$ make
Java demos
$ cd Ice-3.5.1-demos/demoj
$ ant
```

## Demo Build Instructions for Android

Several sample Android projects are provided in the `demoj/android` subdirectory. You must use Eclipse and the [Slice2Java plug-in](#) to build these projects.

In Eclipse, you can open a sample project by choosing **File->Import...**; in the "General" group, select "Existing Project into Workspace", then open one of the subdirectories of `demoj/android`.

The sample projects are configured to locate the Ice run time JAR file (`Ice.jar`) via the `ICE_JAR_HOME` classpath variable.

If you installed `Ice.jar` in a different location, you will need to add it as an external JAR file in each sample project:

1. Open the project's properties and select Java Build Path
2. Click on the Libraries tab
3. Click Add External JARs... and navigate to `Ice.jar`
4. Click OK to save your settings

## Running the Ice Demos

Most demos consist of a single server and client. The instructions to run a demo depend on the programming language. Instructions for

each language are included below. Some demo directories contain a `README` file if additional steps are necessary.

## Running the C++ demos

C++ demos are provided in the `demo` directory.

To run a demo, open a terminal window, change to the desired demo directory, and enter the following command to run the server:

```
$./server
```

To run the client, open another terminal window, change to the same demo directory, and run:

```
$./client
```

## Running the Java demos

Java demos are provided in the `demoj` directory.

After a successful build, the compiled classes are stored in a subdirectory named `classes` in each demo directory. You need to add this subdirectory to your `CLASSPATH`. For example, with a bash shell:

```
$ export CLASSPATH=classes:$CLASSPATH
```

Your `CLASSPATH` should also include `Ice.jar`, `Freeze.jar`, and other service-specific JAR files, as per the [Release Notes](#) instructions.

To run a demo, open a terminal window, change to the desired demo directory, and enter the following command to run the server:

```
$ java Server
```

To run the client, open another terminal window, change to the same demo directory, and run:

```
$ java Client
```

## Running the Android demos

After successfully building an Android project, deploy it onto a suitable emulator or device and review the `README` file in the project subdirectory for further instructions.

## Running the C# demos

C# demos are provided in the `democs` directory.

The C# demos are only supported on SuSE Enterprise Linux Server and Ubuntu but may work on other platforms. Note however that the Ice for .NET run time is included only in the binary distributions for SuSE Enterprise Linux Server and Ubuntu.

To run a demo, open a terminal window, change to the desired demo directory, and enter the following command to run the server:

```
$ mono server.exe
```

To run the client, open another terminal window, change to the same demo directory, and run:

```
$ mono client.exe
```

## Running the Python demos

Python demos are provided in the `demopy` directory.

To run a demo, open a terminal window, change to the desired demo directory, and enter the following command to run the server:

```
$ python Server.py
```

To run the client, open another terminal window, change to the same demo directory, and run:

```
$ python Client.py
```

## Running the Ruby demos

Ruby demos are provided in the `demorb` directory.

Ice provides only client demos in Ruby since Ice for Ruby does not support server-side activities. In order to run a sample client, you must first start its corresponding server from another Ice language mapping. For example, start the C++ hello server:

```
$ cd $HOME/testing/Ice-3.5.1-demos/demo/Ice/hello
$./server
```

To run the client, open another terminal window, change to the corresponding demo directory, and run:

```
$ cd $HOME/testing/Ice-3.5.1-demos/demorb/Ice/hello
$ ruby Client.rb
```

## Running the PHP demos

PHP demos are provided in the `demophp` directory.

The Ice extension for PHP is provided as a dynamically-loadable shared library in Linux RPM distributions. On all other Unix platforms, you will need to build PHP and the Ice extension from source code. Please refer to the `php/INSTALL` file included in the Ice source distribution for more information.

The examples in `demophp/Ice/hello` and `demophp/Glacier2/hello` demonstrate the use of the Ice extension for PHP in a dynamic Web page, whereas the example in `demophp/Ice/value` requires PHP's command line interpreter. All examples require that an Ice server be available; a matching server from any of the other language mappings can be used. A `README` file is provided in each of the example directories.

Note that you may need to modify the `php.ini` files in each demo directory to match your PHP installation and ensure that the Ice extension is loaded properly.

## Using the Sample Programs on Windows

The Ice installer for Windows optionally allows you to install a collection of sample programs in the directory of your choosing. Sample programs are provided for C++, Java, Android, C#, Visual Basic, Ruby, Python and PHP. Below you will find build instructions for languages, compilers, and target platforms. These instructions assume that you have configured your system according to the instructions in the [release notes](#).

On this page:

- [Building and running the C++ demos \(Visual Studio 2010SP1 or 2012\)](#)
- [Building and running the C++ demos \(Visual C++ 2010SP1 or 2012 Express\)](#)
- [Building and running the C++ WinRT demos \(Visual Studio 2012\)](#)
- [Building and running the .NET demos](#)
  - [Building the C# demos](#)
  - [Building the Visual Basic demos](#)
  - [Running the .NET demos](#)
  - [SSL notes for the .NET demos](#)
- [Building and running the .NET Compact Framework demos \(Visual Studio 2008\)](#)
- [Building and running the Silverlight demos \(Visual Studio 2010SP1\)](#)
- [Building and running the Java demos](#)
- [Building and running the Android demos](#)
- [Running the Python demos](#)
- [Running the Ruby demos](#)
- [Building and running the PHP demos](#)

### Building and running the C++ demos (Visual Studio 2010SP1 or 2012)

 The Visual Studio project files require the [Ice Visual Studio Add-In](#), which is installed with the Ice binary distribution.

The C++ demos are in the `demo` directory.

To build the C++ demos, start Visual Studio and open the solution `demo\demo.sln`. If you are using Visual Studio 2012 the demo projects will be converted first to Visual Studio 2012.

Select your target configuration: Debug or Release, Win32 or x64 (on supported x64 platforms). Right click on the desired demo in the Solution Explorer window and select "Build".

To run a demo, open a command window and change to the desired demo subdirectory. Review the `README` file if one is present. Type `server` to start the server. In another command window, type `client` to start the client.

This distribution also includes a few demos for integrating Ice with Oracle. Open the solution `demo\demo-oracle.sln` in Visual Studio 2010SP1 to build the corresponding projects.

### Building and running the C++ demos (Visual C++ 2010SP1 or 2012 Express)

 Visual C++ Express does not support the the [Ice Visual Studio Add-In](#), therefore you must use `NMAKE` to build the C++ demos.

The C++ demos are in the `demo` directory.

To build the C++ demos, open a "Visual Studio Command Prompt" window. If you installed Ice in a non-default location, set `ICE_HOME` as shown below:

```
> set ICE_HOME=<Ice installation root directory>
```

Change to the `demo` directory and run the following commands to build the demos:

```
> set CPP_COMPILER=VC100_EXPRESS # (For Visual C++ 2010SP1)
> set CPP_COMPILER=VC110_EXPRESS # (For Visual C++ 2012)
> nmake /f Makefile.mak
```

To run a demo, change to the desired demo subdirectory and review the `README` file if one is present. Type `server` to start the server. In another command window, type `client` to start the client.

 Two of the Ice demos require the Microsoft Foundation Classes (MFC). These demos will not compile because the Express edition does not include MFC support. The demos are located in `demo\Ice\MFC` and `demo\IcePatch2\MFC`.

## Building and running the C++ WinRT demos (Visual Studio 2012)

 The Visual Studio project files require the [Ice Visual Studio Add-In](#), which is installed with the Ice binary distribution.

The C++ demos are in the `demo` directory.

WinRT requires Windows 8 with Visual Studio 2012.

To build the C++ WinRT demos, start Visual Studio 2012 and open the solution `demo\demo-winrt.sln`.

Select your target configuration: Debug or Release, Win32 or x64 (on supported x64 platforms). Right click on the desired demo in the Solution Explorer window and select "Build".

To run a demo, review the `README` file in the desired demo subdirectory.

To run the demos with a device such as Surface, you will also need to re-create the server certificate to try out SSL. The Windows RT SSL implementation requires the certificate's common name to match the IP address or DNS name of the target server. We provide a `makewinrtcerts.py` Python script to re-generate the server certificate in the `certs` directory at the root of the Ice demo distribution. To run the script:

```
C:\Users\acme\Documents\ZeroC\Ice-3.5.1-demos> cd certs
C:\Users\acme\Documents\ZeroC\Ice-3.5.1-demos\certs> makewinrtcerts.py 192.168.1.50
```

In the example above, the server certificate's common name will be set to `192.168.1.50`. The certificate is generated in the `certs\winrt` directory. You should specify the IP address of the machine running the SSL server here.

## Building and running the .NET demos

Sample programs are provided for C# and Visual Basic.

### Building the C# demos

 The Visual Studio project files require the [Ice Visual Studio Add-In](#), which is installed with the Ice binary distribution.

The C# demos are in the `democs` directory.

To build a C# demo, start Visual Studio and open the solution `democs\demo.sln`. Right click on the desired demo in the Solution Explorer window and select "Build".



## Building the Visual Basic demos

 The Visual Studio project files require the [Ice Visual Studio Add-In](#), which is installed with the Ice binary distribution.

The Visual Basic demos are in the `demovb` directory.

To build a Visual Basic demo, start Visual Studio and open the solution `demovb\demo.sln`. Right click on the desired demo in the Solution Explorer window and select "Build".

## Running the .NET demos

To run a demo, open a command window, change to the desired demo subdirectory and review the `README` file if one is present. Type `server` to start the server. In another command window, type `client` to start the client.

## SSL notes for the .NET demos

In order to use SSL with the sample programs, an SSL certificate must be installed on your system. The configuration files handle this for you, but you will be presented with a confirmation dialog the first time you run a sample program that uses SSL.

Once you are finished with the sample programs, follow these steps to remove the certificate:

1. Start Internet Explorer.
2. Select Internet Options from the Tools menu.
3. Select the Content tab and click the "Certificates" button.
4. Select the Trusted Root Certification Authorities tab.
5. Select the entry for "ZeroC Test CA", click the Remove button, and confirm that you want to remove this certificate.

## Building and running the .NET Compact Framework demos (Visual Studio 2008)

 The Visual Studio project files require the [Ice Visual Studio Add-In](#), which is installed with the Ice binary distribution.

The demos for the .NET Compact Framework are located in the `democs\Ice\compact` subdirectory.

To build the demo, start Visual Studio 2008 and open the solution `democs\democf.sln`. Right click on the demo in the Solution Explorer window and select "Build".

Review the `README.txt` file in the demo project for instructions on starting a device emulator and deploying the program.

## Building and running the Silverlight demos (Visual Studio 2010SP1)

 The Visual Studio project files require the [Ice Visual Studio Add-In](#), which is installed with the Ice binary distribution.

The demos for Silverlight are located in `democs\Ice\s1` and `democs\Glacier2\s1` subdirectories.

To build the demo, start Visual Studio 2010 and open the solution `democs\demosl.sln`. Right click on the demo in the Solution Explorer window and select "Build".

To run a demo review the `README.txt` file in the demo project.

## Building and running the Java demos

The Java demos are in the `demoj` directory.

To build the Java demos, you need J2SE SDK 1.6.0 or later, and Ant 1.7.0 or later. They can be downloaded from:

<http://www.oracle.com/technetwork/java/javase/overview/index.html>

<http://ant.apache.org/bindownload.cgi>

The ant `bin` directory must be added to your `PATH`, and the following environment variables need to be defined:

```
> set JAVA_HOME=<Java SDK installation root directory>
> set PATH=<Ice installation root directory>\bin;%PATH%
```

If you installed Ice in a non-default location, set `ICE_HOME` as shown below:

```
> set ICE_HOME=<Ice installation root directory>
```

You can build all of the demos by running `ant` in the `demoj` directory, or you can build individual demos by changing to the desired subdirectory and then running `ant`.

Before running the demos you must modify your `CLASSPATH` as follows:

```
> set CLASSPATH=classes;%CLASSPATH%
```

Your `CLASSPATH` should also include `Ice.jar`, `Freeze.jar`, and other service-specific JAR files, as per the [Release Notes](#) instructions.

To run a demo, open a command window, change to the desired demo directory, and type `java Server` to run the server. In a separate command window, type `java Client` to run the client.

Some demo directories contain `README` files if additional requirements are necessary.

## Building and running the Android demos

Several sample Android projects are provided in the `demoj/android` subdirectory. You must use Eclipse and the [Slice2Java plug-in](#) to build these projects.

In Eclipse, you can open a sample project by choosing **File->Import...**; in the "General" group, select "Existing Project into Workspace", then open one of the subdirectories of `demoj/android`.

The sample projects are configured to locate the Ice run time JAR file (`Ice.jar`) via the `ICE_HOME` classpath variable.

If you installed `Ice.jar` in a different location, you will need to add it as an external JAR file in each sample project:

1. Open the project's properties and select Java Build Path
2. Click on the Libraries tab
3. Click Add External JARs... and navigate to `Ice.jar`
4. Click OK to save your settings

After successfully building an Android project, deploy it onto a suitable emulator or device and review the `README` file in the project subdirectory for further instructions.

## Running the Python demos

The Python demos are in the `demopy` directory.

You need Python 3.3 to run the demos. A binary installer for Python can be downloaded from:

<http://www.python.org/download>

To run a demo, open a command window, change to the desired demo directory, and type `python Server.py` to start the server. In

a separate command window, type `python Client.py` to run the client.

## Running the Ruby demos

The Ruby demos are in the `demorb` directory.

You need Ruby 1.9.3 to run the demos. A binary installer for Ruby can be downloaded from:

<http://rubyinstaller.org/downloads/>

Since Ice for Ruby does not support server-side activities, only clients are provided in the demos. In order to run the demos you must use the corresponding C++ server.

For example, to run the hello application in `demo\Ice\hello`, we begin by starting the C++ server:

```
> cd <Ice demo root directory>\demo\Ice\hello
> server
```

Then in a separate command window, start the Ruby client:

```
> cd <Ice demo root directory>\demorb\Ice\hello
> ruby Client.rb
```

## Building and running the PHP demos

PHP demos are provided in the `demophp` directory.

You will need PHP 5.4 to run the demos. It can be downloaded from:

<http://www.php.net/downloads.php>

Building the demos requires Microsoft NMAKE. If you do not already have NMAKE installed, you can download it as part of the Windows Platform SDK:

<http://www.microsoft.com/downloads/details.aspx?FamilyId=E6E1C3DF-A74F-4207-8586-711EBE331CDC&displaylang=en>

Open a command window. If you installed Ice in a non-default location, set `ICE_HOME` as shown below:

```
> set ICE_HOME=<Ice installation root directory>
```

Change to the `demophp` directory and run the following command to build the demos:

```
> nmake /f Makefile.mak
```

The examples in `demophp\Ice\hello` and `demophp\Glacier2\hello` demonstrate using the Ice extension for PHP in a dynamic Web page, whereas the example in `demophp\Ice\value` requires PHP's command-line interpreter. A `README` file is provided in each of the example directories.

## Building Ice from Source

The complete Ice source code is [available for download](#). Build instructions are provided below for the Ice language mappings and supported platforms.

### Topics

- [Building Ice for C++ on Linux](#)
- [Building Ice for C++ on OS X](#)
- [Building Ice for C++ on Solaris](#)
- [Building Ice for C++ on Windows](#)
- [Building Ice for Java](#)
- [Building Ice for .NET with Visual Studio](#)
- [Building Ice for .NET with Mono](#)
- [Building Ice for PHP](#)
- [Building Ice for Python](#)
- [Building Ice for Ruby](#)
- [Building the Visual Studio Add-in](#)

## Building Ice for C++ on Linux

This page describes the Ice source distribution, including information about compiler requirements, third-party dependencies, and instructions for building and testing the distribution. If you prefer, you can download [binary packages](#) for supported platforms that contain pre-compiled libraries, executables, and everything else necessary to build Ice applications on Linux.

On this page:

- [C++ Build Requirements for Linux](#)
  - [Third-party Libraries](#)
- [Compiling and Testing Ice for C++ on Linux](#)
  - [64-bit Source Builds on Linux x86\\_64](#)
  - [32-bit Source Builds on Linux x86\\_64](#)
- [Installing a C++ Source Build on Linux](#)

## C++ Build Requirements for Linux

Ice is expected to build and run properly on any recent Linux distribution for x86 and x86\_64, and was extensively tested using the operating systems and compiler versions listed on our [platforms page](#).

### Third-party Libraries

Ice has dependencies on a number of third-party libraries:

- [Berkeley DB 5.3](#)
- [expat 2.0](#)
- [OpenSSL 0.9.8 or later](#)
- [bzip2 1.0](#)
- [mcpp 2.7.2 \(with patches\)](#)

Some of these packages may have been included in your Linux distribution. For those packages that are not installed or have an older version than what is listed above, we recommend downloading the [Ice third-party source archive](#). This archive contains the source distributions for each of the third-party dependencies, as well as required source patches and configuration instructions.

ZeroC also supplies RPMs at the link above for Berkeley DB on RHEL 6, AMZN and SLES 11, as well as packages for Ubuntu 13.04.

## Compiling and Testing Ice for C++ on Linux

Extract the Ice archive in any directory you like (for example, in your home directory):

```
$ tar xvfz Ice-3.5.1.tar.gz
```

Change the working directory to `Ice-3.5.1/cpp`:

```
$ cd Ice-3.5.1/cpp
```

Edit `config/Make.rules` to establish your build configuration. The comments in the file provide more information. Pay particular attention to the variables that define the locations of the third-party libraries.

Now you're ready to build Ice:

```
$ make
```

This will build the Ice core libraries, services, tests and examples.

[Python](#) is required to run the test suite. After a successful build, you can run the tests as follows:

```
$ make test
```

This command is equivalent to:

```
$ python allTests.py
```

If everything worked out, you should see lots of "ok" messages. In case of a failure, the tests abort with "failed".

If you want to try out any of the demos, make sure to update your `PATH` environment variable to add the `bin` directory, and your `LD_LIBRARY_PATH` environment variable to add the `lib` directory:

```
$ export PATH=`pwd`/bin:$PATH
$ export LD_LIBRARY_PATH=`pwd`/lib:$LD_LIBRARY_PATH
```

### 64-bit Source Builds on Linux x86\_64

To build Ice in 64-bit mode, you need to do the following:

- Obtain or build all the third-party dependencies, and put the 64-bit libraries in the `lib64` directories. For example, put Berkeley DB 64-bit libraries in `$DB_HOME/lib64`.
- Build and test as described above (with `gcc`).

### 32-bit Source Builds on Linux x86\_64

By default, builds on `x86_64` are 64-bit. To perform a 32-bit build on a `x86_64` Linux system, set the environment variable `LP64` to `no`, as shown below:

```
$ export LP64=no
```

## Installing a C++ Source Build on Linux

Simply run `make install`. This will install Ice in the directory specified by the `prefix` variable in `config/Make.rules`.

After installation, make sure that the `prefix/bin` directory is in your `PATH`.

If you choose to not embed a runpath into executables at build time (see your build settings in `cpp/config/Make.rules`) or did not create a symbolic link from the `runpath` directory to the installation directory, you also need to add the `prefix/lib` directory to your `LD_LIBRARY_PATH`.

When compiling Ice programs, you must pass the location of the `prefix/include` directory to the compiler with the `-I` option, and the location of the `prefix/lib` directory with the `-L` option.

On an `x86_64` system, the libraries are installed in `prefix/lib64` unless `LP64` is set to `no`. No other changes are necessary.

## Building Ice for C++ on OS X

This page describes the Ice source distribution, including information about compiler requirements, third-party dependencies, and instructions for building and testing the distribution. If you prefer, you can download a [binary package](#) that contains pre-compiled libraries, executables, and everything else necessary to build Ice applications on OS X.

On this page:

- [C++ Build Requirements for OS X](#)
  - [Third-party Libraries](#)
- [Compiling and Testing Ice for C++ on OS X](#)
- [Installing a C++ Source Build on OS X](#)

## C++ Build Requirements for OS X

Ice for C++ was extensively tested using the operating systems and compiler versions listed on our [platforms page](#).

### Third-party Libraries

Ice has dependencies on a number of third-party libraries:

- [Berkeley DB 5.3](#)
- [expat 2.0](#)
- [OpenSSL 0.9.8 or later](#)
- [bzip2 1.0](#)
- [mcpp 2.7.2 \(with patches\)](#)

Some of these packages may have been included with your system. For those packages that are not installed or have an older version than what is listed above, we recommend downloading the [Ice third-party source archive](#). This archive contains the source distributions for each of the third-party dependencies, as well as required source patches and configuration instructions.

## Compiling and Testing Ice for C++ on OS X

Extract the Ice archive in any directory you like (for example, in your home directory):

```
$ tar xvfz Ice-3.5.1.tar.gz
```

Change the working directory to `Ice-3.5.1/cpp`:

```
$ cd Ice-3.5.1/cpp
```

Edit `config/Make.rules` to establish your build configuration. The comments in the file provide more information. Pay particular attention to the variables that define the locations of the third-party libraries.

Now you're ready to build Ice:

```
$ make
```

This will build the Ice core libraries, services, tests and examples.

[Python](#) is required to run the test suite. After a successful build, you can run the tests as follows:

```
$ make test
```

This command is equivalent to:

```
$ python allTests.py
```

If everything worked out, you should see lots of "ok" messages. In case of a failure, the tests abort with "failed".

If you want to try out any of the demos, make sure to update your `PATH` environment variable to add the `bin` directory, and your `DYLD_LIBRARY_PATH` environment variable to add the `lib` directory:

```
$ export PATH=`pwd`/bin:$PATH
$ export DYLD_LIBRARY_PATH=`pwd`/lib:$DYLD_LIBRARY_PATH
```

## Installing a C++ Source Build on OS X

Simply run `make install`. This will install Ice in the directory specified by the `prefix` variable in `config/Make.rules`.

After installation, make sure that the `prefix/bin` directory is in your `PATH`. For C++11 builds, binaries are installed in `prefix/bin/c++11`.

If you choose to not embed a runpath into executables at build time (see your build settings in `cpp/config/Make.rules`) or did not create a symbolic link from the runpath directory to the installation directory, you also need to add the `prefix/lib` directory to your `DYLD_LIBRARY_PATH`. For C++11 builds, use `prefix/lib/c++11` instead of `prefix/lib`.

When compiling Ice programs, you must pass the location of the `prefix/include` directory to the compiler with the `-I` option, and the location of the `prefix/lib` directory with the `-L` option. If you are using C++11, use `prefix/lib/c++11` instead of `prefix/lib` for the `-L` option.



## Building Ice for C++ on Solaris

This page describes the Ice source distribution, including information about compiler requirements, third-party dependencies, and instructions for building and testing the distribution. If you prefer, you can download a [binary package](#) that contains pre-compiled libraries, executables, and everything else necessary to build Ice applications on Solaris.

On this page:

- [C++ Build Requirements for Solaris](#)
  - [Third-party Libraries](#)
  - [Build Tools](#)
- [Compiling and Testing Ice for C++ on Solaris](#)
  - [64-bit Source Builds on Solaris](#)
- [Installing a C++ Source Build on Solaris](#)

## C++ Build Requirements for Solaris

Ice for C++ was extensively tested using the operating systems and compiler versions listed on our [platforms page](#).

### Third-party Libraries

Ice has dependencies on a number of third-party libraries:

- [Berkeley DB 5.3](#)
- [expat 2.0](#)
- [OpenSSL 0.9.8 or later](#)
- [bzip2 1.0](#)
- [mcpp 2.7.2 \(with patches\)](#)

All these libraries, with the exception of Berkeley DB and mcpp, are available from [pkg.oracle.com](#).

### Build Tools

GNU Make 3.81 is required to build Ice on Solaris. It can be installed using [pkg.oracle.com](#) (package name: gnu-make).

## Compiling and Testing Ice for C++ on Solaris

Extract the Ice archive in any directory you like (for example, in your home directory):

```
$ gtar xvfz Ice-3.5.1.tar.gz
```

Change the working directory to `Ice-3.5.1/cpp`:

```
$ cd Ice-3.5.1/cpp
```

Edit `config/Make.rules` to establish your build configuration. The comments in the file provide more information. Pay particular attention to the variables that define the locations of the third-party libraries.

Now you're ready to build Ice:

```
$ gmake
```

This will build the Ice core libraries, services, tests and examples.

[Python](#) is required to run the test suite. After a successful build, you can run the tests as follows:

```
$ gmake test
```

This command is equivalent to:

```
$ python allTests.py
```

If everything worked out, you should see lots of "ok" messages. In case of a failure, the tests abort with "failed".

If you want to try out any of the demos, make sure to update your `PATH` environment variable to add the `bin` directory, and your `LD_LIBRARY_PATH` environment variable to add the `lib` directory. For 64-bit builds, add `lib` to `LD_LIBRARY_PATH_64`:

```
$ export PATH=`pwd`/bin:$PATH
$ export LD_LIBRARY_PATH=`pwd`/lib:$LD_LIBRARY_PATH
$ export LD_LIBRARY_PATH_64=`pwd`/lib:$LD_LIBRARY_PATH_64
```

### 64-bit Source Builds on Solaris

To build Ice in 64-bit mode, you need to do the following:

- Obtain or build all the third-party dependencies, and put the 64-bit libraries in the appropriate `lib` subdirectory (`lib/64` on SPARC, `lib/amd64` on x86).
- Set the environment variable `LP64` to yes, as shown below:

```
$ export LP64=yes
```

- Build and test as described above.

## Installing a C++ Source Build on Solaris

Simply run `gmake install`. This will install Ice in the directory specified by the `prefix` variable in `config/Make.rules`.

After installation, make sure that the `prefix/bin` directory is in your `PATH`.

If you choose to not embed a runpath into executables at build time (see your build settings in `cpp/config/Make.rules`) or did not create a symbolic link from the `runpath` directory to the installation directory, you also need to add the `prefix/lib` directory to your `LD_LIBRARY_PATH`.

When compiling Ice programs, you must pass the location of the `prefix/include` directory to the compiler with the `-I` option, and the location of the `prefix/lib` directory with the `-L` option.

If you built in 64-bit mode, the libraries are installed in `prefix/lib/64` or `prefix/lib/amd64`, depending on your system's architecture. Executables are installed in `prefix/bin/sparcv9` or `prefix/bin/amd64`. No other changes are necessary.

## Building Ice for C++ on Windows

Ice for C++ can be built for three distinct targets:

- [Ice for Windows](#)
- [Ice for WinRT](#)
- [Ice for Ruby support with the MinGW compiler](#)

### Topics

- [Building Ice for C++ for Windows Applications](#)
- [Building Ice for C++ for WinRT Applications](#)
- [Building Ice for C++ with MinGW](#)

## Building Ice for C++ for Windows Applications

This page describes the Ice source distribution, including information about compiler requirements, third-party dependencies, and instructions for building and testing the distribution. If you prefer, you can download a [Windows installer](#) that contains pre-compiled debug and release libraries, executables, and everything else necessary to build Ice applications on Windows.

On this page:

- [Windows Build Requirements](#)
  - [Third-party Libraries](#)
  - [Monotonic Clock](#)
- [Compiling and Testing Ice for C++ on Windows](#)
  - [Building Ice](#)
  - [Running the Test Suite](#)
  - [x64 Platform](#)
- [Installing a C++ Source Build on Windows](#)

### Windows Build Requirements

Ice for C++ was extensively tested using the operating systems and compiler versions listed on our [platforms page](#).

#### ***Third-party Libraries***

Ice has dependencies on a number of third-party libraries:

- [Berkeley DB 5.3](#)
- [expat 2.0](#)
- [OpenSSL 0.9.8](#) or later (OpenSSL 1.0 or later recommended)
- [bzip2 1.0](#)
- [mcpp 2.7.2](#) (with patches)

You do not need to build these packages yourself, as ZeroC supplies a [Windows installer](#) that contains release and debug libraries for all of the third-party dependencies.

If you intend to build the third-party dependencies from source, we recommend downloading the [Ice third-party source archive](#). This archive contains the source distributions for each of the third-party dependencies, as well as required source patches and configuration instructions.

#### ***Monotonic Clock***

Ice uses the QueryPerformanceCounter Windows API function to measure time with a monotonic clock. If you are experiencing timing or performance issues, there are two knowledgebase articles that may be relevant for your system:

- [KB 896256](#)
- [KB 895980](#)

### Compiling and Testing Ice for C++ on Windows

#### ***Building Ice***

Using your favorite Zip tool, unzip the Ice source archive anywhere you like.

Open a command prompt that is configured for your target architecture. For example, when using Visual Studio 2010 or Visual Studio 2012, you have several alternatives:

- Visual Studio Command Prompt
- Visual Studio x64 Win64 Command Prompt
- Visual Studio x64 Cross Tools Command Prompt

Using the first configuration produces 32-bit binaries, while the second produces 64-bit binaries.

 You must be using a Windows x64 platform when compiling a 64-bit version of Ice.

Change the working directory to `Ice-3.5.1`. For example:

```
> cd C:\Ice-3.5.1\cpp
```

Edit `config\Make.rules.mak` to establish your build configuration. The comments in the file provide more information.

Now you're ready to build Ice:

```
> nmake /f Makefile.mak
```

### **Running the Test Suite**

Python is required to run the test suite.

Open a command prompt and change to the top-level Ice directory.

Add the `bin` directory of the third-party libraries to your `PATH`.

For x86 builds:

```
> set PATH=ThirdPartyHome\bin;%PATH%
```

For x64 builds:

```
> set PATH=ThirdPartyHome\bin\x64;%PATH%
```

You can now run the test suite. At the command prompt, execute:

```
> python allTests.py
```

If everything worked out, you should see lots of "ok" messages. In case of a failure, the tests abort with "failed".

If you want to try out any of the demos, make sure to update your `PATH` environment variable to add the `bin` directory, which contains the Ice DLLs and executables.

### **x64 Platform**

Building Ice on x64 with the Visual Studio 2010 or Visual Studio 2012 C++ compiler is like building Ice on x86. You just need to perform the build in a "Visual Studio x64 Win64 Command Prompt", and not in a regular "Visual Studio 2010/2012 Command Prompt".

 You must be using a Windows x64 platform when compiling a 64-bit version of Ice.

### **Installing a C++ Source Build on Windows**

Simply run `nmake /f Makefile.mak install`. This will install Ice in the directory specified by the `prefix` variable in `config\Make.rules.mak`.

After installation, if you plan to use the Visual Studio IDE for your Ice project, make sure to add the `bin` directory to the Visual C++ "Executable files", the `include` directory to the "Include files" and the `lib` directory to the "Library files" in the IDE.

If you built a 64-bit version of Ice, the binaries are installed in the `bin\x64` directory and the libraries are installed in the `lib\x64` directory.

## Building Ice for C++ for WinRT Applications

This page describes the Ice source distribution, including information about compiler requirements, third-party dependencies, and instructions for building and testing the distribution.

If you prefer, you can download a [Windows installer](#) that contains pre-compiled debug and release libraries, executables, and everything else necessary to build Ice applications for WinRT.

On this page:

- [C++ Build Requirements for WinRT](#)
- [Compiling and Testing Ice for WinRT](#)
  - [Building Ice](#)
- [Installing a C++ Source Build for WinRT](#)

### C++ Build Requirements for WinRT

Ice for C++ was extensively tested using the operating systems and compiler versions listed on our [platforms page](#).

### Compiling and Testing Ice for WinRT

#### **Building Ice**

Using your favorite Zip tool, unzip the Ice source archive anywhere you like.

To build Ice for WinRT you first need to [build Ice for Windows](#). The build of Ice for Windows is necessary to create the Slice translators that we need to build Ice for WinRT.

Open a command prompt that is configured for your target architecture. For example, Visual Studio 2012 gives you several alternatives:

- Visual Studio Command Prompt
- Visual Studio x64 Win64 Command Prompt
- Visual Studio x64 Cross Tools Command Prompt
- Visual Studio ARM Cross Tools Command Prompt

Using the first configuration produces 32-bit binaries, while the second and third produce 64-bit binaries and the fourth produces ARM binaries.

Change the working directory:

```
> cd C:\Ice-3.5.0\cpp
```

Edit config\Make.rules.mak to establish your build configuration. The comments in the file provide more information. In particular, you must set WINRT to yes in Make.rules.mak or in your environment:

```
> set WINRT=yes
```

Now you're ready to build Ice:

```
> nmake /f Makefile.mak
```

After the build has completed, you must register the Ice SDK in the Windows registry:

```
> nmake /f Makefile.mak register-sdk
```



This command must be executed in a command prompt that has administrative privileges because it requires write access to the registry.

### Running the Test Suite

The WinRT test suite is composed of a set of dynamic libraries (one for each client/server test) and a GUI application that loads and runs the tests in the dynamic libraries.

You need to build the dynamic libraries first. Change the working directory:

```
> cd C:\Ice-3.5.1\cpp\test
```

Run `nmake` to build the test libraries:

```
> nmake /f Makefile.mak
```

In Visual Studio 2012, open this project file:

```
cpp/test/WinRT/TestSuite.sln
```

You must select the configuration that matches your settings in `config\Make.rules.mak` used to build the dynamic libraries. For example, if you built the test libraries for x86 and debug, you must select Win32 Debug.

After selecting the appropriate configuration, build the solution by choosing "Build Solution" in the "Build" menu.

After the build completes, you can deploy the application using "Deploy Solution" in the "Build" menu. Once deployed, you can start the application from the WinRT Desktop by clicking the "Ice Test Suite" icon.

If you want to run the tests with SSL enabled, you must use servers from another language mapping as WinRT does not support server-side SSL.

To run a test with SSL, open a command window and change to the test directory. At the command prompt, execute:

```
> python run.py --winrt --protocol=ssl
```

Then open the "Ice Test Suite" Windows Store application, check "Enable SSL", and click the "Run" button.

To run the tests on a remote device such as the Surface, you will need to install the [Remote Debugger Tools](#).



Some tests might fail if you run the tests with the debugger attached. You should choose "Start without Debugging" from the Debug menu to run the tests.

## Installing a C++ Source Build for WinRT

Simply run `nmake /f Makefile.mak install`. This will install the Ice SDK in the directory specified by the `prefix` variable in `config\Make.rules.mak`.



This command must be executed in a command prompt that has administrative privileges because it requires write access to the registry.

## Building Ice for C++ with MinGW

This page describes the Ice source distribution, including information about compiler requirements, third-party dependencies, and instructions for building and testing the distribution.

 MinGW is only supported for building the Ice extension for Ruby. It is not supported for general application development. If you prefer, you can download a [Windows installer](#) that contains a complete Ice for Ruby run-time.

On this page:

- [C++ Build Requirements for MinGW](#)
  - [MinGW Compiler](#)
  - [Third-party Libraries](#)
- [Compiling and Testing Ice for C++ with MinGW](#)
  - [Building Ice](#)
  - [Running the Test Suite](#)
- [Installing a C++ Source Build for MinGW](#)

### C++ Build Requirements for MinGW

Ice for C++ was extensively tested using the operating systems and compiler versions listed on our [platforms page](#).

#### **MinGW Compiler**

The only supported MinGW version is the one included in the [Ruby Development Kit 4.5.2](#). You must download the file `DevKit-tdm-32-4.5.2-20111229-1559-sfx.exe`, which is a self-extracting archive.

#### **Third-party Libraries**

Ice has dependencies on a number of third-party libraries:

- [OpenSSL 1.0](#) or later
- [bzip2 1.0](#)
- [mcpp 2.7.2](#) (with patches)

You do not need to build these packages yourself, as ZeroC supplies a [Windows installer](#) that contains release and debug libraries for all of the third-party dependencies.

If you intend to build the third-party dependencies from source, we recommend downloading the [Ice third-party source archive](#). This archive contains the source distributions for each of the third-party dependencies, as well as required source patches and configuration instructions.

### Compiling and Testing Ice for C++ with MinGW

#### **Building Ice**

Using your favorite Zip tool, unzip the Ice source archive anywhere you like.

Open a Windows command prompt and change the working directory to the location of the extracted source archive. For example:

```
> cd C:\Ice-3.5.1\cpp
```

Run the `devkitvars.bat` batch file from the Ruby development kit to setup your environment. For example, if you installed the development kit in `C:\RubyDevKit-4.5.2`, run the following:

```
> C:\RubyDevKit-4.5.2\devkitvars.bat
```

Edit `config\Make.rules` to establish your build configuration. The comments in the file provide more information. In particular, if Ice third-party packages are not installed in the default location, set `THIRDPARTY_HOME` to the Ice third-party installation directory.

Now you are ready to build Ice:



```
> make
```

This will build the C++ and Ruby slice translators, the Ice core, IceSSL and C++ tests.

### ***Running the Test Suite***

Python is required to run the test suite. After a successful build, you can run the tests as follows:

```
> python allTests.py
```

If everything worked out, you should see lots of "ok" messages. In case of a failure, the tests abort with "failed".

### **Installing a C++ Source Build for MinGW**

Simply run `make install` from a command prompt. This will install Ice in the directory specified by the `prefix` variable in `config\Make.rules`.

## Building Ice for Java

This page describes how to build and install Ice for Java from source code. If you prefer, you can also download [binary distributions](#) for the supported platforms.

On this page:

- [Java Build Requirements](#)
  - [Operating Systems](#)
  - [Java Version](#)
  - [Slice to Java Translator](#)
  - [Berkeley DB](#)
  - [Bzip2 Compression](#)
  - [JGoodies](#)
  - [ProGuard](#)
  - [Java Application Bundler](#)
  - [Android](#)
- [Compiling Ice for Java](#)
  - [Preparing to Build](#)
  - [Building Ice for Java](#)
  - [Ant Tasks](#)
- [Installing Ice for Java](#)
- [Eclipse Development](#)
- [Using Ice in Android](#)
  - [Android Sample Projects](#)
  - [Android Tests](#)
- [Running Java Tests and Demos](#)
- [IceGrid Administrative Console](#)

## Java Build Requirements

### Operating Systems

Ice for Java is expected to build and run properly on Windows, OS X, Solaris, and any recent Linux distribution for x86 and x86\_64, and was extensively tested using the operating systems and Java versions listed on our [platforms page](#). Due to the portability of Java, it is very likely that it will also work on other platforms for which a suitable Java implementation is available.

Note, however, that you will need the [Slice to Java translator](#). ZeroC provides translator binaries for our supported platforms. For other platforms, you will have to either port Ice for C++ (which contains the Slice to Java translator), or you will have to translate your Slice files to Java on a supported platform, and copy the generated Java files to your target platform.

### Java Version

Ice for Java requires [J2SE 1.6.0](#) or later.

The Metrics Graph feature of the graphical [IceGrid administrative tool](#) requires J2SE 7u6 or later with JavaFX support. This feature will not be available if you build the source with a JVM that lacks support for JavaFX. Alternatively, building the source using J2SE 7u6 or later with JavaFX produces a JAR file that can be used in JVMs with or without JavaFX support, as the Metrics Graph feature is enabled dynamically.

Make sure that the `javac` and `java` commands are present in your `PATH`.

### Slice to Java Translator

You will need the Slice to Java translator and supporting executables and libraries. You can download a [binary distribution](#) from the ZeroC web site, or you can build Ice for C++ yourself.

### Berkeley DB

"Freeze" is an optional Ice component that provides a persistence facility for Ice applications. Freeze uses Berkeley DB as its underlying database and currently requires Berkeley DB version 5.3 (the recommended version is 5.3.21).

ZeroC includes Berkeley DB in the [binary distributions](#) for all supported platforms. If you would rather build Berkeley DB yourself, a [source distribution](#) with build instructions is also available.

In order to run an application that uses Freeze, you must add `db.jar` to your `CLASSPATH` and verify that the Berkeley DB shared libraries are in your `java.library.path`. On Linux, this can be achieved by adding `Berkeley DB home/lib` to your `LD_LIBRARY_PATH`, for example:

```
$ export LD_LIBRARY_PATH=/opt/db53/lib:$LD_LIBRARY_PATH
```

## Bzip2 Compression

Ice for Java supports protocol compression using the bzip2 classes included with [Apache Ant](#) or available separately from [kohsuke.org](#).

Compression is automatically enabled if the classes are present in the `CLASSPATH`. To use the classes included with Ant, simply add `ant.jar` to your `CLASSPATH`.



These classes are a pure Java implementation of the bzip2 algorithm and therefore add significant latency to Ice requests.

## JGoodies

The graphical [IceGrid administrative tool](#) uses the JGoodies libraries Common, Forms, and Looks. The following versions were tested:

- JGoodies Common 1.4.0
- JGoodies Forms 1.6.0
- JGoodies Looks 2.5.2

## ProGuard

[ProGuard](#) is used to create the standalone JAR file for the graphical [IceGrid administrative tool](#).

Ice for Java has been tested with ProGuard 4.8.

## Java Application Bundler

The [Java Application Bundler](#) is used to create the OS X application bundle for the graphical [IceGrid administrative tool](#).

## Android

The Ice run time (`lib/Ice.jar`) is fully compatible with Android 2.3 or later. Refer to the sections that discuss [Eclipse](#) and [Android](#) for additional details.

# Compiling Ice for Java

## Preparing to Build

The Ice for Java build system requires [Apache Ant](#) 1.7.0 or later.

This source distribution cannot be compiled successfully without the Berkeley DB run time for Java (`db.jar`). On Unix platforms, the build system searches for this file in two locations:

- `/usr/share/java/db-5.3.21.jar`
- `/opt/Ice-3.5.1/lib/db.jar`

If neither of these files is present on your system, or if you are not using a Unix platform, you must add `db.jar` to your `CLASSPATH`.

The build system also requires the Slice translators from Ice for C++. If you have not built Ice for C++ in this source distribution, you must set the `ICE_HOME` environment variable with the path name of your Ice installation. For example:

```
On Unix
$ export ICE_HOME=/opt/Ice-3.5.1 (For local build)
$ export ICE_HOME=/usr (For RPM installation)

On Windows
> set ICE_HOME=C:\Ice-3.5.1
```

Before building Ice for Java, review the settings in the file `config/build.properties` and edit as necessary.

If you intend to build the [IceGrid Administrative Console](#), you have two options:

1. Build it as a standalone JAR file. In this case, confirm the locations of the JGoodies libraries in `config/build.properties` and add ProGuard to your `CLASSPATH`.
2. Build it as a regular JAR file. The JGoodies libraries must either be present in your `CLASSPATH` or available at the locations defined in `config/build.properties`.

In OS X you also have the option to create an Application Bundle. The Java Application Bundler must be present in your `CLASSPATH`. After the build completes, the application bundle can be found in `lib/IceGrid Admin.app`. During installation the bundle is copied to the `Ice-3.5.1/bin` subdirectory.

## Building Ice for Java

To build only the Ice run time (`Ice.jar`), use the following command:

```
ant ice-jar
```

To build the Ice run time along with Freeze, IceBox, IceGrid, IceStorm, IcePatch2 services and the IceGrid administrative console, use this command:

```
ant jar
```

Finally, to build the entire source distribution, including tests and sample programs, use this command:

```
ant
```

Upon completion, the JAR files can be found in the `lib` subdirectory.

If at any time you wish to discard the current build and start a new one, use these commands:

```
ant clean
ant
```

## Ant Tasks

The build system uses some Ice-specific Ant tasks for executing the Slice translators that you may find useful in your own Ant projects. The Java classes for the tasks are supplied in `lib/ant-ice.jar`. You can use an Ant project file from any of the sample programs as a guide for using the tasks, or you can review the source code in the `src/ant` subdirectory.

## Installing Ice for Java

Run `ant install` to install Ice for Java in the directory specified by the `prefix` variable in `config/build.properties`.



It is not necessary to rebuild the source after changing the value of the `prefix` variable.

After installation, add `Ice.jar` to your `CLASSPATH`. If you plan to use other Ice services, you must also add the appropriate JAR files to your `CLASSPATH`:

- `Freeze.jar`

- Glacier2.jar
- IceBox.jar
- IceStorm.jar
- IcePatch2.jar
- IceGrid.jar

## Eclipse Development

ZeroC has created a [Slice2Java plug-in](#) for Eclipse that automates the translation of your Slice files. If you use Eclipse, we strongly recommend [installing this plug-in](#) to simplify your Ice projects.



The Slice2Java plug-in is required if you intend to build any of the Android sample projects included in this distribution.

## Using Ice in Android

Ice requires Android 2.3 or later. Aside from that, there are no other special requirements for using Ice in an Android application. We strongly recommend [installing our Slice2Java plug-in](#) for Eclipse to automate the compilation of your Slice definitions.

### Android Sample Projects

Several sample Android projects are provided in the `demo/android` subdirectory. You must use Eclipse and the [Slice2Java plug-in](#) to build these projects.

In Eclipse, you can open a sample project by choosing **File->Import...**; in the "General" group, select "Existing Project into Workspace", then open one of the subdirectories of `demo/android`.

The sample projects are configured to locate the Ice run time JAR file (`Ice.jar`) via the [ICE\\_JAR\\_HOME classpath variable](#).

If you installed `Ice.jar` in a different location, you will need to add it as an external JAR file in each sample project:

1. Open the project's properties and select Java Build Path
2. Click on the Libraries tab
3. Click Add External JARs... and navigate to `Ice.jar`
4. Click OK to save your settings

### Android Tests

The Ice test suite for Android consists of a JAR file containing the individual test cases and an Android app that loads and runs these tests.

You must first build the test JAR file:

```
ant test-android-jar
```

This produces `IceAndroidTest.jar`. Next, you must use Eclipse and the [Slice2Java plug-in](#) to build the test app. In Eclipse, open the test project by choosing **File->Import...**; in the "General" group, select "Existing Project into Workspace", then navigate to the `test/android` directory.

The test project is configured to locate the Ice run time JAR file (`Ice.jar`) and `IceAndroidTest.jar` via the [ICE\\_JAR\\_HOME classpath variable](#). The [Slice2Java plug-in](#) configures this variable automatically based on your setting for the SDK location in the Eclipse preferences.

After successfully building the project, deploy it onto a suitable emulator or device.

## Running Java Tests and Demos

Some of the Ice for Java tests employ applications that are part of the Ice for C++ distribution. If you have not built Ice for C++ in this source distribution then you must set the `ICE_HOME` environment variable with the path name of your Ice installation:

```
On Unix
$ export ICE_HOME=/opt/Ice-3.5.0 (For local build)
$ export ICE_HOME=/usr (For RPM installation)

On Windows
> set ICE_HOME=c:\Ice-3.5.0
```

Python is required to run the test suite. To run the tests, open a command window and change to the top-level directory. At the command prompt, execute:

```
python allTests.py
```

You can also run tests individually by changing to the test directory and running this command:

```
python run.py
```

If everything worked out, you should see lots of "ok" messages. In case of a failure, the tests abort with "failed".



The Glacier2/router test will fail if it is run with the `--compress` option but the bzip2 classes are not present in your CLASSPATH.

If you want to try out any of the demos, make sure to add `lib/Ice.jar` and classes to your CLASSPATH.

For demos that use Ice services, you must also add the appropriate service JAR files to your CLASSPATH:

- Freeze.jar
- Glacier2.jar
- IceBox.jar
- IceStorm.jar
- IceGrid.jar

Change to the desired demo directory and follow the instructions in the README file. If no README file is present, the demo can be run by entering the following command to start the server:

```
java Server
```

Then in a separate window enter this command to start the client:

```
java Client
```

## IceGrid Administrative Console

Ice for Java includes a graphical administrative console for IceGrid. If you elected to build the console, it can be found in the file `lib/IceGridGUI.jar`.

If you built this JAR file using ProGuard, it is completely self-contained and has no external dependencies, in which case you can start the console with the following command:

```
java -jar IceGridGUI.jar
```

If you compiled the console without ProGuard, you will need to add `IceGridGUI.jar` to your CLASSPATH. You can start the console with this command:

```
java IceGridGUI.Main
```

In OS X there is also an application bundle named *IceGrid Admin*. You can start the IceGrid Administrative Console by double-clicking the *IceGrid Admin* icon in Finder.

## Building Ice for .NET with Visual Studio

This page describes how to build and install Ice for .NET from source code using Visual Studio. If you prefer, you can also download [binary distributions](#) for the supported platforms.

On this page:

- [.NET Build Requirements](#)
- [Compiling Ice for .NET with Visual Studio](#)
- [Running the .NET Tests](#)
- [Running the .NET Demos](#)
- [SSL Notes for .NET Tests and Demos](#)
- [Protocol Compression with .NET](#)
- [Installing Ice for .NET on Windows](#)
  - [GAC Installation](#)
- [Targeting Managed Code](#)
- [Targeting .NET Compact Framework](#)
  - [.NET Compact Framework Build Requirements](#)
  - [Building Ice for .NET Compact Framework](#)
  - [Running the .NET Compact Framework Tests](#)
  - [Building the .NET Compact Framework Demos](#)
- [Targeting Silverlight](#)
  - [Silverlight Build Requirements](#)
  - [Building Ice for Silverlight](#)
  - [Installing Ice for Silverlight](#)
  - [Running the Silverlight Tests and Demos](#)
- [Targeting Unity](#)

### .NET Build Requirements

Ice for .NET has been extensively tested using the operating systems and compilers listed on our [platforms page](#).

### Compiling Ice for .NET with Visual Studio

Unpack the archive. The .NET sources will be located in the `Ice-3.5.1\cs` subdirectory.

You will need the Slice to C# translator (`slice2cs`) and supporting executables and libraries from Ice for C++. You can download a [binary distribution](#) from the ZeroC web site, or you can build Ice for C++ yourself.

If you have not built Ice for C++ in the `cpp` subdirectory, set `ICE_HOME` to the directory of your Ice for C++ installation. For example:

```
> set ICE_HOME=C:\Ice-3.5.1
```

Change to the `cs` subdirectory of the Ice source distribution:

```
> cd Ice-3.5.1\cs
```

Open `config\Make.rules.mak.cs` and review the comments that describe the settings you can modify. For example, you may wish to enable optimization.

Run `nmake`:

```
> nmake /f Makefile.mak
```

The tests and sample programs are built automatically. If you modify the source code of a sample program, you can rebuild it using `nmake`.

You can also build the demos using the Visual Studio solution located in `demo\demo.sln`.



The demo projects require the [Ice Visual Studio Add-In](#). The add-in is installed automatically when you use the Ice installer, or you can install the add-in manually by following the instructions in `..\vsaddin\INSTALL.txt`.

## Running the .NET Tests

Some of the Ice for .NET tests employ applications that are part of Ice for C++. If you have not built Ice for C++ from the `cpp` subdirectory, then you need to set the `ICE_HOME` environment variable to the path where these applications are installed for the tests to run properly:

```
> set ICE_HOME=c:\Ice-3.5.1
```

Python is required to run the test suite. To run the tests, open a command window and change to the top-level directory. At the command prompt, execute:

```
> python allTests.py
```

You can also run tests individually by changing to the test directory and running this command:

```
> python run.py
```

If everything worked out, you should see lots of "ok" messages. In case of a failure, the tests abort with "failed".

## Running the .NET Demos

To run the demos, you need to have the `cpp\bin` directory in your `PATH` and the `cs\Assemblies` directory in your `DEVPATH`. See the `README` file in each demo directory for a description of the demo.

Note that for demos that use IceSSL, the IceSSL plug-in configuration does not contain the fully-qualified name (FQN) for the IceSSL assembly. Instead it just contains the partial name:

```
Ice.Plugin.IceSSL=IceSSL:IceSSL.PluginFactory
```

The IceSSL assembly is found through the use of `DEVPATH`, which is enabled in the `*.exe.config` files. If you want to run an application using the IceSSL assembly installed in the GAC without the use of the `*.exe.config` files, you must add the FQN to the IceSSL plug-in configuration, as shown below:

```
Ice.Plugin.IceSSL=IceSSL, Version=3.5.1.0, Culture=neutral,
PublicKeyToken=cdd571ade22f2f16:IceSSL.PluginFactory
```

Note that `cdd571ade22f2f16` is the token corresponding to ZeroC's public key for signing the assemblies in binary distributions. If you built Ice from sources, your assemblies were signed using the development key instead, which you can find in `config/IceDevKey.snk`. The token for the development key is `1f998c50fec78381`.

## SSL Notes for .NET Tests and Demos

In order to use SSL with the tests and sample programs, an SSL certificate must be installed on your system. The configuration files handle this for you, but you will be presented with a confirmation dialog the first time you run a test or sample program.

Once you are finished with the tests and sample programs, follow these steps to remove the certificate:

1. Start Internet Explorer.
2. Select Internet Options from the Tools menu.
3. Select the Content tab and click the "Certificates" button.
4. Select the Trusted Root Certification Authorities tab.
5. Select the entry for "ZeroC Test CA", click the Remove button, and confirm that you want to remove this certificate.

Note that under Windows Vista, the IceSSL configuration test is disabled due to an apparent bug with the .NET framework in which obsolete SSL session ids are reused and cause server authentication to fail. This bug manifests itself in those applications that initialize and destroy multiple IceSSL plug-ins in the same process. As this is an unusual use case, we do not believe it will affect most Ice applications.

## Protocol Compression with .NET



Ice for .NET attempts to dynamically load `bzip2.dll` to support protocol compression, therefore this DLL must be present in your `PATH`. Ice automatically disables protocol compression if the DLL cannot be found.

On 64-bit Windows, you must ensure that Ice finds the 64-bit version of `bzip2.dll` before the 32-bit version. The 64-bit and 32-bit `bzip2` libraries are installed in `prefix\bin\x64` and `prefix\bin`, respectively. For 64-bit Windows, the `prefix\bin\x64` directory must appear before `prefix\bin` in your application's `PATH`. (The Ice run time prints a warning to the console if it detects a `bzip2.dll` format mismatch during start-up.)

## Installing Ice for .NET on Windows

Run `nmake /f Makefile.mak install` to install Ice for .NET in the directory specified by the `prefix` variable in `config\Make.rules.mak.cs`. After installation, the `prefix\bin` directory contains executables (such as `iceboxnet.exe`), and the `prefix\Assemblies` directory contains the .NET assemblies.

### GAC Installation

You can add the assemblies to the Global Assembly Cache (GAC). To do this, open Windows Explorer and navigate to the directory `C:\WINDOWS\assembly`. Next, drag and drop (or copy and paste) the assemblies from `Ice-3.5.1\Assemblies` into the right-hand pane to install them in the cache.

You can also use `gacutil` from the command line to achieve the same result:

```
> gacutil /i library.dll
```

The `gacutil` tool is included with your Visual C# installation. For example, if you have installed Visual Studio 2010 in `C:\Program Files`, the path to `gacutil` is

```
C:\Program Files\Microsoft SDKs\Windows\v7.0A\bin\gacutil.exe
```

Once installed in the cache, the assemblies will always be located correctly without having to set environment variables or copy them into the same directory as an executable.

If you want line numbers for stack traces, you must also install the PDB (`.pdb`) files in the GAC. Unfortunately, you cannot do this using Explorer, so you have to do it from the command line. Open a command shell window and navigate to `C:\WINDOWS\assembly\Microsoft.NET\GAC_MSIL\Ice` (assuming `C:\WINDOWS` is your system root). Doing a directory listing there, you will find a directory named `v4.0_3.5.0.0__UUUD`, for example:

```
v4.0_3.5.0.0__cdd571ade22f2f16
```

Change to that directory (making sure that you use the correct version number for this release of Ice). In this directory, you will see the `Ice.dll` you installed into the GAC in the preceding step. Now copy the `Ice.pdb` file into this directory:

```
> copy path_to_ice.pdb .
```

## Targeting Managed Code

By default, Ice for .NET uses unmanaged code for performing protocol compression and for handling signals in the `Ice.Application` class. You can build a managed version of Ice for .NET that lacks the aforementioned features by editing `config/Make.rules.mak.cs` and uncommenting the `MANAGED=yes` line before you build.

## Targeting .NET Compact Framework

### .NET Compact Framework Build Requirements

Ice for .NET Compact Framework requires Microsoft Visual Studio 2008 SP1 and the .NET Compact Framework Version 3.5 SP1.

The default configuration in `config\Make.rules.mak.cs` produces Ice assemblies for use with .NET. If you wish to use Ice with the .NET Compact Framework, you must re-build the sources.

### Building Ice for .NET Compact Framework

To build Ice for .NET Compact Framework, open `config\Make.rules.mak.cs` and set `COMPACT=yes`. Run `nmake` as before:

```
> nmake /f Makefile.mak
```

The .NET Compact Framework assemblies and binaries are generated into the `Assemblies\cf` and `bin\cf` directories, respectively.

### Running the .NET Compact Framework Tests

To run the tests, open a command window and change to the top-level directory. At the command prompt, execute:

```
> python allTests.py --compact
```

### Building the .NET Compact Framework Demos

To build the demos, you must first install the [Ice Visual Studio Add-In](#). You can install the Add-in using the Windows MSI installer; for manual installation instructions, refer to the file `..\vsaddin\INSTALL.txt`.

Use the Visual Studio solution located in `demo\democf.sln` to build the demos.

## Targeting Silverlight

### Silverlight Build Requirements

Ice for Silverlight requires Microsoft Visual Studio 2010 SP1 and .NET Silverlight 5.0. There are two additional prerequisites:

- [Microsoft Silverlight 5.0 SDK](#)
- [Microsoft Silverlight 5 Tools](#)

The default configuration in `config\Make.rules.mak.cs` produces Ice assemblies for use with .NET. If you wish to use Ice with Silverlight, you must re-build the sources.

### Building Ice for Silverlight

To build Ice for Silverlight, open `config\Make.rules.mak.cs` and set `SILVERLIGHT=yes`. Run `nmake` as before:

```
> nmake /f Makefile.mak
```

The Silverlight assemblies are generated into the `Assemblies\sl` directory.

### Installing Ice for Silverlight

To install Ice for Silverlight run

```
> nmake /f Makefile.mak install
```

This will install Ice for Silverlight in the directory specified by the `prefix` variable in `config\Make.rules.mak.cs`. The Ice assemblies will be located in the `prefix\Assemblies\sl` directory.

### Running the Silverlight Tests and Demos

To build the tests and demos, you must first install the [Ice Visual Studio Add-In](#). You can install the Add-in using the Windows MSI installer; for manual installation instructions, refer to the file `..\vsaddin\INSTALL.txt`.

Use the Visual Studio solutions located in `test\testsl.sln` and `demo\demosl.sln` to build the tests and demos, respectively.

Silverlight has no server-side support; you must build the servers from .NET:

```
> cd Ice-3.5.1\cs
> nmake /f Makefile.mak SILVERLIGHT=no
```

To run the tests, open a command window and change to the top-level directory. At the command prompt, execute:

```
> python allTests.py --silverlight
```

If everything worked out, you should see lots of "ok" messages. In case of a failure, the tests abort with "failed".

To run the demos, open the solution `demo\demos1.sln` and follow the instructions in the `README.txt` file of each demo.

## Targeting Unity

Ice for .NET can also be compiled to target the Unity 3 API. To build Ice for the Unity API, open `config\Make.rules.mak.cs` and set `UNITY=yes`. Run `nmake` as before:

```
> nmake /f Makefile.mak
```

## Building Ice for .NET with Mono

This page describes how to build and install Ice for .NET from source code with Mono. If you prefer, you can also download [binary distributions](#) for the supported platforms.

On this page:

- [Mono Build Requirements](#)
- [Compiling Ice for .NET with Mono](#)
- [Running the .NET Tests](#)
- [Running the .NET Demos](#)
- [Targeting Managed Code](#)
- [Configuring the bzip2 Library](#)
- [Running Mono Applications on Linux](#)
- [Installing Ice for .NET on Linux](#)

### Mono Build Requirements

Ice for .NET requires Mono version 2.0.1 or later and is expected to build and run properly on any recent Linux distribution for x86 and x86\_64 that supports Mono. Ice for .NET has been extensively tested using the operating systems and Mono versions listed on our [platforms page](#).

You need to install the `mono-core` and the `mono-devel` RPMs to build Ice for .NET on SuSE Linux Enterprise Server.

 IceSSL is not currently supported for Mono.

### Compiling Ice for .NET with Mono

Unpack the source archive. The .NET sources will be located in the `Ice-3.5.1/cs` subdirectory.

You will need the Slice to C# translator (`slice2cs`) and supporting executables and libraries. You can download a [binary distribution](#) from the ZeroC web site, or you can build Ice for C++ yourself.

If you have not built Ice for C++ in the `cpp` subdirectory, set `ICE_HOME` to the directory of your Ice for C++ installation. For example:

```
$ export ICE_HOME=/opt/Ice-3.5.1
```

Change to the `cs` subdirectory of the Ice source distribution:

```
$ cd Ice-3.5.1/cs
```

Open `config/Make.rules.cs` and review the comments that describe the settings you can modify. For example, you may wish to enable optimization.

Run make:

```
$ make
```

The tests and sample programs are built automatically. If you modify the source code of a sample program, you can rebuild it using make.

### Running the .NET Tests

Some of the Ice for .NET tests employ applications that are part of Ice for C++. If you have not built Ice for C++ from the `cpp` subdirectory, then you need to set the `ICE_HOME` environment variable to the path where these applications are installed for the tests to run properly:

```
$ export ICE_HOME=/opt/Ice-3.5.1
```

[Python](#) is required to run the test suite. To run the tests, open a command window and change to the top-level directory. At the command prompt, execute:

```
$ python allTests.py
```

You can also run tests individually by changing to the test directory and running this command:

```
$ python run.py
```

If everything worked out, you should see lots of "ok" messages. In case of a failure, the tests abort with "failed".

## Running the .NET Demos

To run the demos, you need to have the `cpp/bin` directory in your `PATH` and the `cs/Assemblies` directory in your `MONO_PATH`. See the `README` file in each demo directory for a description of the demo.

## Targeting Managed Code

By default, Ice for .NET uses unmanaged code for performing protocol compression and for handling signals in the `Ice.Application` class on Windows. You can build a managed version of Ice for .NET that lacks the aforementioned features by editing `config/Make.rules.cs` and uncommenting the `MANAGED=yes` line before you build.

## Configuring the bzip2 Library

The `bin` directory contains a file `Ice.dll.config` that configures the bzip2 library. You need to check that the library name specified for the `target` attribute matches the name of the bzip2 library on your machine. If the `target` attribute does not specify the correct name or if bzip2 is not installed, the Ice run time silently runs without protocol compression.

To test whether you have set the attribute correctly, run the server in `demo/Ice/minimal` as follows:

```
$ MONO_LOG_LEVEL=info MONO_LOG_MASK=dll mono --debug server.exe
```

This produces trace output that shows whether the bzip2 library could be located at run time. If the library could be found, you will see a line of trace as follows:

```
Mono-INFO: Found as 'BZ2_bzlibVersion'.
```

## Running Mono Applications on Linux

Mono binaries are interpreted so, given a binary called `server.exe`, you have to run the Mono interpreter with an argument `server.exe` to execute that binary:

```
$ mono server.exe
```

If you want to avoid having to explicitly invoke the Mono interpreter, please refer to [Registering .exe as non-native binaries](#).

## Installing Ice for .NET on Linux

Open `config/Make.rules.cs` and change the `prefix` variable to hold the top-level installation directory. This directory will be created automatically if necessary. Also review the comments for the `GACINSTALL` variable and decide whether to enable it. Next, run

```
$ make install
```

After installation, add the directory containing the libraries to your `MONO_PATH`. When building applications, you need to reference the libraries with the `-r` option to `mcs`.

Alternatively, you can add the libraries to the global assembly cache. To do this, either set `GACINSTALL` before building the libraries, or use

```
$ gacutil -i <library.dll>
```

Once installed in the cache, the assemblies will always be located correctly without having to set environment variables. Finally, you could also copy the necessary libraries into the directory that contains the `.exe` for your application.

## Building Ice for PHP

This page describes how to build and install Ice for PHP from source code. If you prefer, you can also download [binary distributions](#) for the supported platforms.

On this page:

- [PHP Build Requirements](#)
- [Building the PHP Extension](#)
  - [Building Ice for PHP on Linux and OS X](#)
  - [Building Ice for PHP on Windows](#)
- [Installing the PHP Extension](#)
  - [Installing Ice for PHP on Linux & OS X](#)
  - [Installing Ice for PHP on Windows](#)
- [PHP Dependencies](#)
- [PHP Source Files](#)
- [Running the PHP Tests](#)
- [Web Server Permissions](#)
- [SELinux Notes for PHP](#)

## PHP Build Requirements

Ice for PHP is expected to build and run properly on Windows and any recent Linux distribution for x86 and x86\_64, and was extensively tested using the operating systems and PHP versions listed on our [platforms page](#).

You will also need the Ice 3.5.1 development kit for C++, which you can install as a binary distribution or compile from source yourself.

## Building the PHP Extension

### Building Ice for PHP on Linux and OS X

This source distribution only supports building Ice for PHP as a dynamic PHP extension; the product of the build is a shared library that you must configure PHP to load.

First, change to Ice for PHP source subdirectory:

```
$ cd Ice-3.5.1/php
```

Edit `config/Make.rules` and review the build settings. For example, you may want to enable `OPTIMIZE`. If your PHP installation resides in a non-standard location, modify the `PHP_HOME` setting to contain the installation directory. If you are using PHP 5.3 or later and wish to use PHP namespaces, set `USE_NAMESPACES=yes`.

If you have not built Ice for C++ from the `cpp` subdirectory, then set the `ICE_HOME` environment variable to the directory containing your Ice installation. For example, if Ice is installed in `/opt/Ice-3.5.1`, set `ICE_HOME` as follows:

```
$ export ICE_HOME=/opt/Ice-3.5.1
```

If you installed Ice using RPMs, set `ICE_HOME` as shown below:

```
$ export ICE_HOME=/usr
```

Run `make` to build the extension.

### Building Ice for PHP on Windows

The Ice installer for Windows includes a precompiled extension for PHP 5.4.8 built with Visual Studio 2008 (Visual C++ 9) and compatible with the "Thread-safe VC9" distribution of PHP available on [php.net](#). We encourage you to use this extension if possible, together with a compatible Web server.





The Apache binaries provided by the Apache Software Foundation are compiled with Visual C++ 6 and therefore are **not** compatible with the Ice for PHP extension included in our Windows installer. A VC9 build of Apache is available from alternate sources.

The most common motivation for compiling the Ice extension yourself is to create an extension that is compatible with your existing environment, such as when your Web server or PHP interpreter is built with a different compiler.

To build the Ice extension, first download the PHP5 binary archive or Windows installer and install the distribution.

You will also need to download and extract the PHP5 sources (Ice for PHP requires the PHP header files). If you are using PHP 5.4, change to the PHP5 source directory and run the following commands:

```
> buildconf
> configure
```

You do not need to actually build PHP from source, but these two steps are necessary to generate header files that are required by the Ice extension.

If you have not built Ice for C++ from the `cpp` subdirectory then you need to set the `ICE_HOME` environment variable to the location of your Ice for C++ installation. For example:

```
> set ICE_HOME=C:\Program Files\ZeroC\Ice-3.5.1
```

Change to the Ice for PHP source directory:

```
> cd Ice-3.5.1\php
```

Open `config\Make.rules.mak.php`, review the comments, and make any necessary changes. In particular, you may need to change the values of `PHP_HOME` and `PHP_BIN_HOME` to refer to your PHP source and binary installations, respectively. If you compiled PHP from source, you should also review the setting of `PHP_LIBDIR`. If you are using PHP 5.3 or later and wish to use PHP namespaces, set `USE_NAMESPACES=yes`. Finally, if you are using a non-thread-safe PHP installation, set `PHP_ZTS=no`.

Run `NMAKE` to build the extension:

```
> nmake /f Makefile.mak
```

Upon successful completion, the Ice for PHP extension is created as `lib\php_ice.dll` (Release) or `lib\php_iced.dll` (Debug).

## Installing the PHP Extension

### Installing Ice for PHP on Linux & OS X

To install the Ice extension, you must move the extension's shared library into PHP's extension directory. This directory is determined by the PHP configuration directive `extension_dir`. You can determine the default value for this directive by running the command-line version of PHP with the `-i` option:

```
$ php -i
```

Review the output for a line like this:

```
extension_dir => /usr/lib/php/modules => /usr/lib/php/modules
```

Once you've copied the extension to PHP's extension directory, you will need to enable the extension in your PHP configuration. Your PHP installation likely supports the `/etc/php.d` configuration directory, which you can verify by examining the output of `php -i` and looking for the presence of `--with-config-file-scan-dir` in the "Configure Command" entry. If present, you can create a file in `/etc/php.d` that contains the directive to load the Ice extension. For example, create the file `/etc/php.d/ice.ini` containing the following line on Linux:

```
extension = IcePHP.so
```

Or on OS X:

```
extension = IcePHP.dylib
```

If PHP does not support the `/etc/php.d` directory, determine the path name of PHP's configuration file as reported by the `php -i` comma



nd:

Configuration File (php.ini) Path => /etc/php.ini

Open the configuration file and append the following line on Linux:

```
extension = IcePHP.so
```

Or on OS X:

```
extension = IcePHP.dylib
```

You can verify that PHP is loading the Ice extension by running the command shown below:

```
$ php -m
```

Look for `ice` among the installed modules. Note that your library search path (`LD_LIBRARY_PATH` on Linux or `DYLD_LIBRARY_PATH` on OS X) must include the directory containing the Ice shared libraries.

Read the [PHP Dependencies](#) and [PHP Source Files](#) sections below for more information about installing the Ice extension.

### Installing Ice for PHP on Windows

To install the Ice extension, you must move the extension's shared library into PHP's extension directory. This directory is determined by the PHP configuration directive `extension_dir`. You can determine the default value for this directive by running the command-line version of PHP with the `-i` option:

```
> php -i
```

Review the output for a line like this:

```
extension_dir => C:\php5 => C:\php5
```

The directive may also be set to a relative path, such as:

```
extension_dir => ./ => ./
```

In the case of a relative path, the value is relative to the current working directory of the process. As a result, the working directory when running the command-line version of PHP will likely differ from the working directory when PHP is running as a Web server module. Using a typical installation of Apache as an example, the working directory is Apache's installation directory, therefore the extension must be copied to

```
\Program Files\Apache Software Foundation\Apache2.2
```

Once you've copied the extension to the appropriate directory, you will need to enable the extension in your PHP configuration. First you must discover the location of PHP's configuration file (`php.ini`), which is also displayed by the `-i` option. Look for the following line:

```
Loaded Configuration File => C:\Program Files\PHP\php.ini
```

If you used the Windows installer for PHP, your Web server's configuration may have already been modified to load PHP. You can also review your Web server's settings to discover the location of `php.ini`. For example, PHP's Windows installer modifies Apache's configuration to add the following directives:

```
PHPIniDir "C:/Program Files/PHP/"
LoadModule php5_module "C:/Program Files/PHP/php5apache2_2.dll"
```

The `PHPIniDir` directive specifies the directory containing the `php.ini` file.

Open `php.ini` and append this directive:

```
extension = php_ice.dll
```

Read the [PHP Dependencies](#) and [PHP Source Files](#) sections below for more information about installing the Ice extension.

## PHP Dependencies

PHP will need to be able to locate the libraries for the Ice run-time libraries and its third-party dependencies. On Unix-style platforms, these libraries are named as follows:

```
libIce
libIceUtil
libSlice
libbz2
```

On Windows, these DLLs are required:

```
icevc90_35.dll
iceutilvc90_35.dll
slicevc90_35.dll
bzip2_vc90.dll
```

In general, these libraries must reside in a directory of the user's `PATH`. For Web servers, the libraries may need to reside in a system directory. For example, on Linux you can add the directory containing the Ice run-time libraries to `/etc/ld.so.conf` and run `ldconfig`. On Windows, you can copy the DLLs to the `C:\WINDOWS\system32` directory, or to the Apache installation directory.

You can verify that the Ice extension is installed properly by examining the output of the `php -m` command, or by calling the `phpInfo()` function from a script. For example, you can create a file in the Web server's document directory containing the following PHP script:

```
<?php
phpInfo();
?>
```

Then start a browser window and open the URL corresponding to this script. If the Ice extension is successfully installed, you will see an `ice` section among the configuration information.

Note that if you want to use IceSSL from the Ice extension, then PHP will also need access to the shared libraries for IceSSL and OpenSSL.

## PHP Source Files

In addition to the binary Ice extension module and its library dependencies, you will also need to make the Ice for PHP source files available to your scripts. These files are located in the `lib` subdirectory and consist of the Ice run time definitions (`Ice.php` or `Ice_ns.php`) along with PHP source files generated from the Slice files included in the Ice distribution.

The Ice extension makes no assumptions about the location of these files, so you can install them anywhere you like. For example, you can simply include them in the same directory as your application scripts. Alternatively, if you prefer to install them in a common directory, you may need to modify PHP's `include_path` directive so that the PHP interpreter is able to locate these files. Another option is to modify the include path from within your script prior to including any Ice run-time file. Here is an example that assumes Ice is installed in `/opt`:

```
// PHP
ini_set('include_path',
ini_get('include_path') . PATH_SEPARATOR . '/opt/Ice-3.5.1/php');
require 'Ice.php'; // Load the core Ice run time definitions.
```

## Running the PHP Tests

The `test` subdirectory contains PHP implementations of the core Ice test suite. [Python](#) is required to run the test suite.

The test suites require that the Ice for C++ tests be built in the `cpp` subdirectory of this source distribution. In addition, the scripts require that the CLI version of the PHP interpreter be available in your `PATH`.

To run all of the tests, do the following:

```
> python allTests.py
```

You can also run tests individually by changing to the test directory and running this command:

```
> python run.py
```

If everything worked out, you should see lots of "ok" messages. In case of a failure, the tests abort with "failed".

## Web Server Permissions

The Web server normally runs in a special user account that may not necessarily have access to the Ice extension, its dependent libraries and PHP source files, and other resources such as Ice configuration and your application scripts. It is very important that you review the permissions of these files and verify that the Web server has sufficient access.

For example, on Windows the Apache server typically runs as a service in the "Local System" account. You will need to modify the access rights of the aforementioned files to grant access to this account. In a command window, you can use the `cacls` utility to establish the appropriate access rights. Assuming that you have copied the Ice extension and dependent DLLs to Apache's installation directory, you can modify the access rights as shown below:

```
cd \Program Files\Apache Software Foundation\Apache2.2
cacls php_ice.dll /G SYSTEM:F Administrators:F
cacls bzip2.dll /G SYSTEM:F Administrators:F
...
```

On Linux, Apache typically runs in the `apache` account, so you will either need to change the owner or group of the libraries and other resources, or modify their permissions to make them sufficiently accessible.

## SELinux Notes for PHP

[SELinux](#) augments the traditional Unix permissions with a number of new features. In particular, SELinux can prevent the `httpd` daemon from opening network connections and reading files without the proper SELinux types.

If you suspect that your Ice for PHP application does not work due to SELinux restrictions, we recommend that you first try it with SELinux disabled. As root, run:

```
setenforce 0
```

to disable SELinux until the next reboot of your computer.

If you want to run `httpd` with Ice for PHP and SELinux enabled, there are two steps you need to take. First, allow `httpd` to open network connections:

```
setsebool httpd_can_network_connect=1
```

Add the `-P` option to make this setting persistent across reboots.

Second, make sure any `.ice` file used by your PHP scripts can be read by `httpd`. The enclosing directory also needs to be accessible. For example:

```
chcon -R -t httpd_sys_content_t /opt/MyApp/slice
```

## Building Ice for Python

This page describes how to build and install Ice for Python from source code. If you prefer, you can also download [binary distributions](#) for the supported platforms.

On this page:

- [Python Build Requirements](#)
- [Building Ice for Python on Linux/Solaris/OS X](#)
- [Building Ice for Python on Windows](#)
- [Configuring your Environment for Python](#)
- [Running the Python Tests](#)
- [Solaris Notes for Python](#)

### Python Build Requirements

Ice for Python is expected to build and run properly on Windows, OS X, Solaris, and any recent Linux distribution for x86 and x86\_64, and was extensively tested using the operating systems and Python versions listed on our [platforms page](#).

Ice for Python supports Python versions 2.6, 2.7, or 3.3. Note however that your Python installation must have been built with a C++ compiler that is compatible with the one used to build Ice for C++.

You will also need the Ice 3.5.1 development kit for C++, which you can install as a binary distribution or compile from source yourself.

Depending on your platform, you may need to download the [Python source distribution](#) and make your own Python build.

### Building Ice for Python on Linux/Solaris/OS X

Follow the steps below to build the Ice extension for Python.

Change to Ice for Python source subdirectory:

```
$ cd Ice-3.5.1/py
```

If you have not built Ice for C++ in the `cpp` subdirectory, set `ICE_HOME` to the directory of your Ice for C++ installation. For example:

```
$ export ICE_HOME=/opt/Ice-3.5.1
```

Edit `config/Make.rules`, modify the installation prefix (if necessary), and review the comments describing the `PYTHON_VERSION` variable.

Execute `python -v` to verify that the correct Python interpreter is in your executable search path.

Run `make` to build the extension.

Upon successful completion, run `make install`. You may need additional user privileges to install in the directory specified by `config/Make.rules`.

Refer to [Configuring your Environment for Python](#) for more information.

### Building Ice for Python on Windows

The [Python](#) interpreter is readily available on Windows platforms. You can build it yourself using Microsoft Visual C++, or obtain a binary distribution from the Python web site. The Python 3.3.x binary distribution is compiled with Visual C++ 10.0, and you should use this binary distribution if you want to compile the Ice extension with Visual C++ 10.0.

Follow the steps below to build the Ice extension for Python.

Open a command prompt that supports command-line compilation with Visual C++. For example, you can execute the Visual C++ batch file `vcvars32.bat` to configure your environment. Alternatively, you can start a *Visual Studio Command Prompt* by selecting the appropriate entry from the Visual Studio program group in your Start menu.

Change to the Ice for Python source subdirectory:

```
> cd Ice-3.5.1\py
```

If you have not built Ice for C++ from the `cpp` subdirectory, set `ICE_HOME` to the directory of your Ice for C++ installation. For example:

```
> set ICE_HOME=C:\Ice-3.5.1
```

Edit `config\Make.rules.mak` and review the settings. In particular you must set `CPP_COMPILER` to the appropriate compiler.

Run `nmake`:

```
> nmake /f Makefile.mak
```

Upon completion, the Ice extension is created as `python\IcePy.pyd`.



Normally you should build with `OPTIMIZE=yes`. If you wish to build a debug version of the Ice extension, set `OPTIMIZE=no`. In this case, you will also need to build a debug version of the Python interpreter from sources.

## Configuring your Environment for Python

On Unix, modify your `PYTHONPATH` environment variable to include the Ice extension for Python. Assuming you installed the extension in the default directory (`/opt/Ice-3.5.1`), you would modify your environment as shown below:

```
$ export ICEPY_HOME=/opt/Ice-3.5.1
$ export PYTHONPATH=$ICEPY_HOME/python:$PYTHONPATH
```

On Windows, modify your environment to allow Python to find the Ice extension for Python. The interpreter must be able to locate the extension DLL as well as the Python source files in the `python` subdirectory. This is normally accomplished by setting the `PYTHONPATH` environment variable to contain the necessary subdirectory. For example, if the Ice for Python extension is installed in `C:\Ice-3.5.1`, you could configure your environment as follows:

```
> set ICEPY_HOME=C:\Ice-3.5.1
> set PYTHONPATH=%ICEPY_HOME%\python
```

## Running the Python Tests

To run the tests, open a command window and change to the top-level directory. At the command prompt, execute:

```
> python allTests.py
```

You can also run tests individually by changing to the test directory and running this command:

```
> python run.py
```

If everything worked out, you should see lots of "ok" messages. In case of a failure, the tests abort with "failed".

## Solaris Notes for Python

Python needs to be configured and built with the following options in order to successfully load the Ice extension:

```
$./configure --enable-shared --with-cxx-main=CC --without-gcc ...
```

After running `configure`, edit the generated `makefile` to comment out the following line:

```
BASECFLAGS= -OPT:Olimit=0
```

## Building Ice for Ruby

This page describes how to build and install Ice for Ruby from source code. If you prefer, you can also download [binary distributions](#) for the supported platforms.

On this page:

- [Ruby Build Requirements](#)
  - [Ruby Prerequisites for Linux](#)
  - [Ruby Prerequisites for Windows](#)
- [Building the Ruby Extension](#)
  - [Building Ice for Ruby on Linux](#)
  - [Building Ice for Ruby on Windows](#)
- [Installing the Ruby Extension](#)
  - [Installing Ice for Ruby on Linux](#)
  - [Installing Ice for Ruby on Windows](#)
- [Configuring your Environment for Ruby](#)
  - [Using Ice for Ruby on Linux](#)
  - [Using Ice for Ruby on Windows](#)
- [Running the Ruby Tests](#)
- [Running the Ruby Demos](#)
- [SELinux Notes for Ruby](#)

## Ruby Build Requirements

Ice for Ruby is expected to build and run properly on Windows and any recent Linux distribution for x86 and x86\_64, and was extensively tested using the operating systems and Ruby versions listed on our [platforms page](#).



Ruby currently does not implement server-side functionality, therefore Ice for Ruby can only be used in client applications. If you have a need for this feature and wish to sponsor its development, please contact us at [info@zeroc.com](mailto:info@zeroc.com).

### Ruby Prerequisites for Linux

To build Ice for Ruby you must have the following:

- Ice 3.5.1 development kit for C++
- Ruby 1.8.1 or later

You can use a source or binary installation of Ruby. If you use an RPM installation, the following packages are required:

```
ruby
ruby-devel
ruby-libs (RHEL)
```

### Ruby Prerequisites for Windows

To build Ice for Ruby you must have the following:

- Ice 3.5.1 development kit for C++
- Ruby 1.9.3
- Ruby Development Kit 4.5.2

The Ruby distribution for Windows uses the MinGW compiler, therefore MinGW is the only compiler supported by Ice for Ruby.

The instructions in this file make the following assumptions about your build environment:

1. You have installed the Ice 3.5.1 distribution using the [ZeroC installer](#). The default installation directory is `C:\Program Files\ZeroC\Ice-3.5.1`.
2. You have installed [Ruby 1.9.3](#) using the Windows installer. The default installation directory is `C:\Ruby193`.

3. You have installed the [Ruby Development Kit 4.5.2](#).

If you selected different installation directories, you will need to modify the relevant path names in the steps below to match your configuration.

## Building the Ruby Extension

### Building Ice for Ruby on Linux

The instructions for compiling the Ice extension assume that you have already installed Ruby.

If you installed Ruby in a non-standard location, set the `RUBY_HOME` environment variable to the installation directory. For example:

```
$ export RUBY_HOME=/opt/ruby-1.8.6
```

If you have not built Ice for C++ from the `cpp` subdirectory or if you have installed the Ice for C++ development kit in a non-standard location, set the `ICE_HOME` environment variable to the installation directory. For example:

```
$ export ICE_HOME=/opt/Ice-3.5.1
```

Review the settings in `config/Make.rules` and adjust as necessary. For example, you may wish to enable `OPTIMIZE`.

Run `make` to build the extension.

### Building Ice for Ruby on Windows

Follow the steps below to build the Ice extension for Ruby.

Open a Windows command prompt and add Ruby to your environment:

```
> C:\Ruby193\bin\setrbvars.bat
```

Add MinGW from the Ruby Development Kit to your `PATH`:

```
> C:\RubyDevKit-4.5.2\devkitvars.bat
```

Change to the Ice for Ruby source directory:

```
> cd Ice-3.5.1/rb
```

If you have not [built Ice for C++](#) from the `cpp` subdirectory or if you have installed the Ice for C++ development kit in a non-standard location, set the `ICE_HOME` environment variable to the installation directory. For example:

```
> set ICE_HOME=C:\Ice-3.5.1
```

Run `make` to build the extension:

```
> make
```

## Installing the Ruby Extension

### Installing Ice for Ruby on Linux

You can perform an automated installation with the following command:

```
$ make install
```

This process uses the `prefix` variable in `config/Make.rules` as the installation's root directory. The subdirectory `prefix/ruby` is created as a copy of the local `ruby` directory and contains the Ice for Ruby extension library (`IceRuby.so`) as well as Ruby source code. Using this installation method requires that you modify your environment as described in "Using Ice for Ruby" below.

Another option is to copy the contents of the local `ruby` directory to your Ruby installation's `site_ruby` directory. For example, if you installed Ruby via RPM, you can use the steps below:

```
cd <Ice source directory>/rb/ruby
sudo tar cf - * | (cd /usr/lib/ruby/site_ruby/1.8/i386-linux; tar xvf -)
```

On x86\_64 systems, change the last command to:

```
sudo tar cf - * | (cd /usr/lib64/ruby/site_ruby/1.8/x86_64-linux; tar xvf -)
```

There is no need to modify your environment if you use this approach.

### Installing Ice for Ruby on Windows

You can perform an automated installation with the following command:

```
> make install
```

This process uses the `prefix` variable in `config\Make.rules` as the installation's root directory. The subdirectory `prefix\ruby` is created as a copy of the local `ruby` directory and contains the Ice for Ruby extension library (`IceRuby.so`) as well as Ruby source code. Using this installation method requires that you modify your environment as described below.

## Configuring your Environment for Ruby

### Using Ice for Ruby on Linux

The Ruby interpreter must be able to locate the Ice extension. If you used the automated installation described above, you need to define the `RUBYLIB` environment variable as follows:

```
$ export RUBYLIB=/opt/Ice-3.5.1/ruby:$RUBYLIB
```

This example assumes that your Ice for Ruby installation is located in the `/opt/Ice-3.5.1` directory.

You must also modify `LD_LIBRARY_PATH` to include the directory `/opt/Ice-3.5.1/lib`:

```
$ export LD_LIBRARY_PATH=/opt/Ice-3.5.1/lib:LD_LIBRARY_PATH
```

To verify that Ruby can load the Ice extension successfully, open a command window and start the interpreter using `irb`:

```
> irb
irb(main):001:0>
```

At the prompt, enter

```
require "Ice"
```

If the interpreter responds with the value `true`, the Ice extension was loaded successfully. Enter `exit` to quit the interpreter.

### Using Ice for Ruby on Windows

The Ruby interpreter must be able to locate the Ice extension. One way to configure the interpreter is to define the `RUBYLIB` environment variable as follows:

```
> set RUBYLIB=C:\Ice-3.5.1\ruby
```

This example assumes your Ice for Ruby installation is located in the `C:\Ice-3.5.1` directory.

In addition, you must modify your `PATH` environment variable to include the following directories:

```
C:\Program Files\ZeroC\Ice-3.5.1\bin
C:\Ice-3.5.1\bin
```

At a command prompt, you can set your `PATH` as shown below:

```
> set PATH=C:\Program Files\ZeroC\Ice-3.5.1\bin;C:\Ice-3.5.1\bin;%PATH%
```



## Running the Ruby Tests

The test subdirectory contains Ruby implementations of the core Ice test suite. [Python](#) is required to run the test suite.

The test suites require that the Ice for C++ tests be built in the `cpp` subdirectory of this source distribution.

Open a command window and change to the top-level directory. At the command prompt, execute:

```
> python allTests.py
```

You can also run tests individually by changing to the test directory and running this command:

```
> python run.py
```

If everything worked out, you should see lots of "ok" messages. In case of a failure, the tests abort with "failed".

## Running the Ruby Demos

The demo directory contains Ruby versions of the Ice sample programs. Note that only clients are provided, since Ice for Ruby does not support server-side activities. In order to run a sample client, you must first start its corresponding server from another Ice language mapping, such as C++.

As an example, let's run the hello application in `demo/ice/hello` using the C++ server. Assuming that you have already compiled the sample C++ programs in the `cpp` subdirectory, we begin by starting the server:

```
> cd Ice-3.5.1/cpp/demo/ice/hello
> server
```

In a separate window, start the client:

```
> cd Ice-3.5.1/rb/demo/ice/hello
> ruby Client.rb
```

Some demo directories contain `README` files if additional requirements are necessary.

## SELinux Notes for Ruby

If [SELinux](#) is enabled on your RHEL system, you may encounter this error message when Ruby attempts to load the Ice extension:

```
cannot restore segment prot after reloc: Permission denied
```

There are two ways to solve this problem:

- Change the default security context for the Ice extension using the following command:

```
$ chcon -t texrel_shlib_t /opt/Ice-3.5.0/ruby/IceRuby.so
```

Replace `/opt/Ice-3.5.1` with your installation directory.

- Disable SELinux completely by adding the following line to your `/etc/sysconfig/selinux` file:

```
SELINUX=disabled
```

## Building the Visual Studio Add-in

This page describes how to build and install the [Ice Visual Studio Add-in](#) from source code. If you would rather not compile the Add-in yourself, the [Ice installer for Windows](#) automatically installs the Add-in.

On this page:

- [Add-in Build Requirements](#)
- [Building the Add-in](#)
- [Installing the Add-in](#)

### Add-in Build Requirements

The Ice Visual Studio Add-in was extensively tested using the operating systems and Visual Studio versions listed on our [platforms page](#).

Building the Ice Visual Studio Add-in requires one of the following compilers:

- Microsoft Visual Studio 2008 SP1 and Visual Studio 2008 SDK
- Microsoft Visual Studio 2010 SP1 and Visual Studio 2010 SDK SP1
- Microsoft Visual Studio 2012 and Visual Studio 2012 SDK

 Visual Studio 2008 is only supported for building .NET Compact Framework applications.

### Building the Add-in

Unpack the archive. The sources are contained in the `Ice-3.5.1\vsaddin` subdirectory.

In a Visual Studio command prompt, change to the distribution directory:

```
> cd Ice-3.5.1\vsaddin
```

Open `config\Make.rules.mak` and review the comments that describe the settings you can modify.

Run `nmake` to build the add-in:

```
> nmake /f Makefile.mak
```

Upon completion, the add-in DLL is placed into the `Ice-3.5.1\vsaddin\bin` directory. Depending on your Visual Studio version, the library name is one of the following:

- `IceVisualStudioAddin-VS2008.dll`
- `IceVisualStudioAddin-VS2010.dll`
- `IceVisualStudioAddin-VS2012.dll`

### Installing the Add-in

Run `nmake install` to install the Ice Visual Studio Add-in in the directory specified by the `prefix` variable in `config\Make.rules.mak`:

```
> nmake /f Makefile.mak install
```