

## ROOT User's Guide

# ROOT

**An Object-Oriented  
Data Analysis Framework**



May 2013



# Contents

<b>Preface</b>	<b>21</b>
<b>1 Introduction</b>	<b>23</b>
1.1 The ROOT Mailing Lists . . . . .	23
1.2 Contact Information . . . . .	24
1.3 Conventions Used in This Book . . . . .	24
1.4 The Framework . . . . .	24
1.4.1 What Is a Framework? . . . . .	24
1.4.2 Why Object-Oriented? . . . . .	25
1.5 Installing ROOT . . . . .	25
1.6 The Organization of the ROOT Framework . . . . .	26
1.6.1 \$ROOTSYS/bin . . . . .	26
1.6.2 \$ROOTSYS/lib . . . . .	27
1.6.3 \$ROOTSYS/tutorials . . . . .	31
1.6.4 \$ROOTSYS/test . . . . .	32
1.6.5 \$ROOTSYS/include . . . . .	32
1.6.6 \$ROOTSYS/<library> . . . . .	32
1.7 How to Find More Information . . . . .	32
1.7.1 Class Reference Guide . . . . .	32
<b>2 Getting Started</b>	<b>35</b>
2.1 Setting the Environment Variables . . . . .	35
2.2 Start and Quit a ROOT Session . . . . .	36
2.3 Using the GUI . . . . .	37
2.3.1 Main Menus and Toolbar . . . . .	38
2.3.2 The Editor Frame . . . . .	43
2.3.3 Classes, Methods and Constructors . . . . .	43
2.3.4 User Interaction . . . . .	45
2.3.5 Building a Multi-pad Canvas . . . . .	45
2.3.6 Saving the Canvas . . . . .	47
2.3.7 Printing the Canvas . . . . .	47
2.4 The ROOT Command Line . . . . .	48

2.4.1	Multi-line Commands . . . . .	48
2.4.2	CINT Extensions . . . . .	49
2.4.3	Helpful Hints for Command Line Typing . . . . .	49
2.4.4	Regular Expression . . . . .	49
2.5	Conventions . . . . .	50
2.5.1	Coding Conventions . . . . .	50
2.5.2	Machine Independent Types . . . . .	51
2.5.3	TObject . . . . .	51
2.6	Global Variables . . . . .	52
2.6.1	gROOT . . . . .	52
2.6.2	gFile . . . . .	52
2.6.3	gDirectory . . . . .	52
2.6.4	gPad . . . . .	52
2.6.5	gRandom . . . . .	53
2.6.6	gEnv . . . . .	53
2.7	Environment Setup . . . . .	53
2.7.1	Logon and Logoff Scripts . . . . .	54
2.7.2	History File . . . . .	54
2.7.3	Tracking Memory Leaks . . . . .	54
2.7.4	Memory Checker . . . . .	55
2.8	Converting from PAW to ROOT . . . . .	55
2.8.1	Converting HBOOK/PAW Files . . . . .	55
<b>3</b>	<b>Histograms</b>	<b>57</b>
3.1	The Histogram Classes . . . . .	57
3.2	Creating Histograms . . . . .	58
3.2.1	Constant or Variable Bin Width . . . . .	58
3.3	Bin Numbering . . . . .	59
3.3.1	Convention . . . . .	59
3.3.2	Re-binning . . . . .	60
3.4	Filling Histograms . . . . .	60
3.4.1	Automatic Re-binning Option . . . . .	60
3.5	Random Numbers and Histograms . . . . .	60
3.6	Adding, Dividing, and Multiplying . . . . .	61
3.7	Projections . . . . .	62
3.8	Drawing Histograms . . . . .	62
3.8.1	Setting the Style . . . . .	63
3.8.2	Draw Options . . . . .	63
3.8.3	Drawing a Sub-range of a 2-D Histogram . . . . .	78
3.8.4	Superimposing Histograms with Different Scales . . . . .	81



3.8.5	Statistics Display . . . . .	82
3.8.6	Setting Line, Fill, Marker, and Text Attributes . . . . .	83
3.8.7	Setting Tick Marks on the Axis . . . . .	83
3.8.8	Giving Titles to the X, Y and Z Axis . . . . .	83
3.9	Making a Copy of an Histogram . . . . .	84
3.10	Normalizing Histograms . . . . .	84
3.11	Saving/Reading Histograms to/from a File . . . . .	84
3.12	Miscellaneous Operations . . . . .	85
3.13	Alphanumeric Bin Labels . . . . .	85
3.13.1	Option 1: SetBinLabel . . . . .	86
3.13.2	Option 2: Fill . . . . .	86
3.13.3	Option 3: TTree::Draw . . . . .	86
3.13.4	Sort Options . . . . .	88
3.14	Histogram Stacks . . . . .	88
3.15	TH2Poly . . . . .	89
3.16	Profile Histograms . . . . .	90
3.16.1	Build Options . . . . .	91
3.16.2	Drawing a Profile without Error Bars . . . . .	92
3.16.3	Create a Profile from a 2D Histogram . . . . .	92
3.16.4	Create a Histogram from a Profile . . . . .	92
3.16.5	Generating a Profile from a TTree . . . . .	92
3.16.6	2D Profiles . . . . .	94
3.17	Iso Surfaces . . . . .	95
3.18	3D Implicit Functions . . . . .	95
3.19	TPie . . . . .	95
3.20	The User Interface for Histograms . . . . .	98
3.20.1	TH1Editor . . . . .	98
3.20.2	TH2Editor . . . . .	101
<b>4</b>	<b>Graphs</b> . . . . .	<b>107</b>
4.1	TGraph . . . . .	107
4.1.1	Graph Draw Options . . . . .	107
4.2	Superimposing Two Graphs . . . . .	111
4.3	Graphs with Error Bars . . . . .	113
4.4	Graphs with Asymmetric Error Bars . . . . .	114
4.5	Graphs with Asymmetric Bent Errors . . . . .	115
4.6	TGraphPolar . . . . .	117
4.7	TGraph Exclusion Zone . . . . .	117
4.8	TGraphQQ . . . . .	120
4.8.1	Two Datasets . . . . .	120

4.8.2	One Dataset . . . . .	121
4.9	TMultiGraph . . . . .	121
4.10	TGraph2D . . . . .	123
4.11	TGraph2DErrors . . . . .	127
4.12	Fitting a Graph . . . . .	127
4.13	Setting the Graph's Axis Title . . . . .	127
4.14	Zooming a Graph . . . . .	127
4.15	The User Interface for Graphs . . . . .	130
<b>5</b>	<b>Fitting Histograms</b>	<b>131</b>
5.1	The Fit Method . . . . .	131
5.2	Fit with a Predefined Function . . . . .	132
5.3	Fit with a User-Defined Function . . . . .	132
5.3.1	Creating a TF1 with a Formula . . . . .	132
5.3.2	Creating a TF1 with Parameters . . . . .	134
5.3.3	Creating a TF1 with a User Function . . . . .	134
5.4	Fixing and Setting Parameters' Bounds . . . . .	135
5.5	Fitting Sub Ranges . . . . .	135
5.6	The Fit Panel . . . . .	136
5.6.1	Function Choice and Settings . . . . .	136
5.6.2	Fitter Settings . . . . .	136
5.6.3	Draw Options . . . . .	138
5.6.4	Print Options . . . . .	138
5.6.5	Command Buttons . . . . .	138
5.7	Fitting Multiple Sub Ranges . . . . .	138
5.8	Adding Functions to the List . . . . .	140
5.9	Combining Functions . . . . .	140
5.10	Associated Function . . . . .	141
5.11	Access to the Fit Parameters and Results . . . . .	141
5.12	Associated Errors . . . . .	143
5.13	Fit Statistics . . . . .	143
5.14	The Minimization Package . . . . .	143
5.14.1	Basic Concepts of Minuit . . . . .	144
5.14.2	The Transformation of Limited Parameters . . . . .	144
5.14.3	How to Get the Right Answer from Minuit . . . . .	145
5.14.4	Reliability of Minuit Error Estimates . . . . .	145
5.15	FUMILI Minimization Package . . . . .	147
5.16	Neural Networks . . . . .	148
5.16.1	Introduction . . . . .	148
5.16.2	The MLP . . . . .	148

5.16.3	Learning Methods . . . . .	149
5.16.4	Using the Network . . . . .	150
5.16.5	Examples . . . . .	151
<b>6</b>	<b>A Little C++</b>	<b>155</b>
6.1	Classes, Methods and Constructors . . . . .	155
6.2	Inheritance and Data Encapsulation . . . . .	156
6.2.1	Method Overriding . . . . .	156
6.2.2	Data Encapsulation . . . . .	156
6.3	Creating Objects on the Stack and Heap . . . . .	157
<b>7</b>	<b>CINT the C++ Interpreter</b>	<b>161</b>
7.1	What is CINT? . . . . .	161
7.2	The ROOT Command Line Interface . . . . .	162
7.3	The ROOT Script Processor . . . . .	164
7.3.1	Un-named Scripts . . . . .	164
7.3.2	Named Scripts . . . . .	165
7.3.3	Executing a Script from a Script . . . . .	166
7.4	Resetting the Interpreter Environment . . . . .	166
7.5	A Script Containing a Class Definition . . . . .	167
7.6	Debugging Scripts . . . . .	168
7.7	Inspecting Objects . . . . .	169
7.8	ROOT/CINT Extensions to C++ . . . . .	169
7.9	ACLIC - The Automatic Compiler of Libraries for CINT . . . . .	172
7.9.1	Usage . . . . .	172
7.9.2	Setting the Include Path . . . . .	174
7.9.3	Dictionary Generation . . . . .	174
7.9.4	Intermediate Steps and Files . . . . .	175
7.9.5	Moving between Interpreter and Compiler . . . . .	176
7.10	Reflex . . . . .	177
7.10.1	Overview . . . . .	177
7.10.2	Selecting Types And Members . . . . .	177
7.10.3	Genreflex and Templates . . . . .	178
7.10.4	GCCXML Installation . . . . .	179
7.10.5	Reflex API . . . . .	179
7.10.6	Cintex . . . . .	181

<b>8</b>	<b>Object Ownership</b>	<b>183</b>
8.1	Ownership by Current Directory (gDirectory) . . . . .	183
8.2	Ownership by the Master TROOT Object (gROOT) . . . . .	184
8.2.1	The Collection of Specials . . . . .	184
8.2.2	Access to the Collection Contents . . . . .	184
8.3	Ownership by Other Objects . . . . .	184
8.4	Ownership by the User . . . . .	185
8.4.1	The kCanDelete Bit . . . . .	185
8.4.2	The kMustCleanup Bit . . . . .	186
<b>9</b>	<b>Graphics and the Graphical User Interface</b>	<b>187</b>
9.1	Drawing Objects . . . . .	187
9.2	Interacting with Graphical Objects . . . . .	187
9.2.1	Moving, Resizing and Modifying Objects . . . . .	188
9.2.2	Selecting Objects . . . . .	189
9.2.3	Context Menus: the Right Mouse Button . . . . .	189
9.2.4	Executing Events when a Cursor Passes on Top of an Object . . . . .	192
9.3	Graphical Containers: Canvas and Pad . . . . .	193
9.3.1	The Global Pad: gPad . . . . .	193
9.3.2	The Coordinate Systems of a Pad . . . . .	195
9.3.3	Converting between Coordinate Systems . . . . .	196
9.3.4	Dividing a Pad into Sub-pads . . . . .	196
9.3.5	Updating the Pad . . . . .	198
9.3.6	Making a Pad Transparent . . . . .	198
9.3.7	Setting the Log Scale . . . . .	199
9.3.8	WaitPrimitive method . . . . .	199
9.3.9	Locking the Pad . . . . .	200
9.4	Graphical Objects . . . . .	200
9.4.1	Lines, Arrows and Polylines . . . . .	200
9.4.2	Circles and Ellipses . . . . .	201
9.4.3	Rectangles . . . . .	202
9.4.4	Markers . . . . .	203
9.4.5	Curly and Wavy Lines for Feynman Diagrams . . . . .	205
9.4.6	Text and Latex Mathematical Expressions . . . . .	205
9.4.7	Greek Letters . . . . .	207
9.4.8	Mathematical Symbols . . . . .	207
9.4.9	Text in a Pad . . . . .	212
9.4.10	The TeX Processor TMathText . . . . .	213
9.5	Axis . . . . .	213
9.5.1	Axis Title . . . . .	216

9.5.2	Axis Options and Characteristics . . . . .	216
9.5.3	Setting the Number of Divisions . . . . .	216
9.5.4	Zooming the Axis . . . . .	217
9.5.5	Drawing Axis Independently of Graphs or Histograms . . . . .	217
9.5.6	Orientation of Tick Marks on Axis . . . . .	217
9.5.7	Labels . . . . .	218
9.5.8	Axis with Time Units . . . . .	220
9.5.9	Axis Examples . . . . .	224
9.6	Graphical Objects Attributes . . . . .	229
9.6.1	Text Attributes . . . . .	229
9.6.2	Line Attributes . . . . .	233
9.6.3	Fill Attributes . . . . .	233
9.6.4	Color and Color Palettes . . . . .	235
9.7	The Graphics Editor . . . . .	237
9.7.1	TAxisEditor . . . . .	237
9.7.2	TPadEditor . . . . .	237
9.8	Copy and Paste . . . . .	238
9.8.1	Using the GUI . . . . .	238
9.8.2	Programmatically . . . . .	240
9.9	Legends . . . . .	240
9.10	The PostScript Interface . . . . .	243
9.10.1	Special Characters . . . . .	244
9.10.2	Writing Several Canvases to the Same PostScript File . . . . .	244
9.10.3	The Color Models . . . . .	246
9.11	The PDF Interface . . . . .	247
9.12	Create or Modify a Style . . . . .	247
9.13	3D Viewers . . . . .	249
9.13.1	Invoking a 3D viewer . . . . .	249
9.13.2	The GL Viewer . . . . .	250
9.13.3	The X3D Viewer . . . . .	259
9.13.4	Common 3D Viewer Architecture . . . . .	259
<b>10</b>	<b>Folders and Tasks</b>	<b>269</b>
10.1	Folders . . . . .	269
10.2	Why Use Folders? . . . . .	269
10.3	How to Use Folders . . . . .	269
10.3.1	Creating a Folder Hierarchy . . . . .	271
10.3.2	Posting Data to a Folder (Producer) . . . . .	273
10.3.3	Reading Data from a Folder (Consumer) . . . . .	273
10.4	Tasks . . . . .	273
10.5	Execute and Debug Tasks . . . . .	276

<b>11 Input/Output</b>	<b>277</b>
11.1 The Physical Layout of ROOT Files	277
11.1.1 The File Header	279
11.1.2 The Top Directory Description	279
11.1.3 The Histogram Records	279
11.1.4 The Class Description List (StreamerInfo List)	280
11.1.5 The List of Keys and the List of Free Blocks	281
11.1.6 File Recovery	282
11.2 The Logical ROOT File: TFile and TKey	282
11.2.1 Viewing the Logical File Contents	283
11.2.2 The Current Directory	285
11.2.3 Objects in Memory and Objects on Disk	286
11.2.4 Saving Histograms to Disk	288
11.2.5 Histograms and the Current Directory	290
11.2.6 Saving Objects to Disk	290
11.2.7 Saving Collections to Disk	291
11.2.8 A TFile Object Going Out of Scope	291
11.2.9 Retrieving Objects from Disk	292
11.2.10 Subdirectories and Navigation	292
11.3 Streamers	294
11.3.1 Automatically Generated Streamers	294
11.3.2 Transient Data Members (//!) )	295
11.3.3 The Pointer to Objects (//->) )	295
11.3.4 Variable Length Array	296
11.3.5 Double32_t	296
11.3.6 Prevent Splitting (//   )	296
11.3.7 Streamers with Special Additions	298
11.3.8 Writing Objects	298
11.3.9 Ignore Object Streamers	299
11.3.10 Streaming a TClonesArray	299
11.4 Pointers and References in Persistency	300
11.4.1 Streaming C++ Pointers	300
11.4.2 Motivation for the TRef Class	300
11.4.3 Using TRef	300
11.4.4 How Does It Work?	301
11.4.5 Action on Demand	302
11.4.6 Array of TRef	303
11.5 Schema Evolution	304
11.5.1 The TStreamerInfo Class	305
11.5.2 The TStreamerElement Class	305

11.5.3	Example: TH1 StreamerInfo . . . . .	305
11.5.4	Optimized StreamerInfo . . . . .	306
11.5.5	Automatic Schema Evolution . . . . .	306
11.5.6	Manual Data Model Evolution Capabilities . . . . .	307
11.5.7	Manual Schema Evolution . . . . .	309
11.5.8	Building Class Definitions with the StreamerInfo . . . . .	310
11.5.9	Example: MakeProject . . . . .	310
11.6	Migrating to ROOT 3 . . . . .	312
11.7	Compression and Performance . . . . .	313
11.8	Remotely Access to ROOT Files via a rootd . . . . .	314
11.8.1	TNetFile URL . . . . .	314
11.8.2	Remote Authentication . . . . .	314
11.8.3	A Simple Session . . . . .	314
11.8.4	The rootd Daemon . . . . .	315
11.8.5	Starting rootd via inetd . . . . .	315
11.8.6	Command Line Arguments for rootd . . . . .	315
11.9	Reading ROOT Files via Apache Web Server . . . . .	316
11.9.1	Using the General Open Function of TFile . . . . .	316
11.10	XML Interface . . . . .	317
<b>12</b>	<b>Trees</b>	<b>319</b>
12.1	Why Should You Use a Tree? . . . . .	319
12.2	A Simple TTree . . . . .	319
12.3	Show an Entry with TTree::Show . . . . .	321
12.4	Print the Tree Structure with TTree::Print . . . . .	321
12.5	Scan a Variable the Tree with TTree::Scan . . . . .	321
12.6	The Tree Viewer . . . . .	322
12.7	Creating and Saving Trees . . . . .	324
12.7.1	Creating a Tree from a Folder Hierarchy . . . . .	324
12.7.2	Tree and TRef Objects . . . . .	324
12.7.3	Autosave . . . . .	324
12.7.4	Trees with Circular Buffers . . . . .	324
12.7.5	Size of TTree in the File . . . . .	326
12.7.6	User Info Attached to a TTree Object . . . . .	326
12.7.7	Indexing a Tree . . . . .	326
12.8	Branches . . . . .	327
12.9	Adding a Branch to Hold a List of Variables . . . . .	327
12.10	Adding a TBranch to Hold an Object . . . . .	329
12.10.1	Setting the Split-level . . . . .	329
12.10.2	Exempt a Data Member from Splitting . . . . .	331

12.10.3 Adding a Branch to Hold a TClonesArray . . . . .	331
12.10.4 Identical Branch Names . . . . .	331
12.11 Adding a Branch with a Folder . . . . .	331
12.12 Adding a Branch with a Collection . . . . .	331
12.13 Examples for Writing and Reading Trees . . . . .	332
12.14 Example 1: A Tree with Simple Variables . . . . .	332
12.14.1 Writing the Tree . . . . .	333
12.14.2 Viewing the Tree . . . . .	334
12.14.3 Reading the Tree . . . . .	334
12.15 Example 2: A Tree with a C Structure . . . . .	336
12.15.1 Writing the Tree . . . . .	338
12.15.2 Analysis . . . . .	339
12.16 Example 3: Adding Friends to Trees . . . . .	341
12.16.1 Adding a Branch to an Existing Tree . . . . .	341
12.16.2 TTree::AddFriend . . . . .	341
12.17 Example 4: A Tree with an Event Class . . . . .	344
12.17.1 The Event Class . . . . .	344
12.17.2 The EventHeader Class . . . . .	345
12.17.3 The Track Class . . . . .	345
12.17.4 Writing the Tree . . . . .	346
12.17.5 Reading the Tree . . . . .	347
12.18 Example 5: Import an ASCII File into a TTree . . . . .	349
12.19 Trees in Analysis . . . . .	349
12.20 Simple Analysis Using TTree::Draw . . . . .	350
12.20.1 Using Selection with TTree::Draw . . . . .	351
12.20.2 Using TCut Objects in TTree::Draw . . . . .	351
12.20.3 Accessing the Histogram in Batch Mode . . . . .	352
12.20.4 Using Draw Options in TTree::Draw . . . . .	352
12.20.5 Superimposing Two Histograms . . . . .	352
12.20.6 Setting the Range in TTree::Draw . . . . .	354
12.20.7 TTree::Draw Examples . . . . .	354
12.20.8 Multiple variables visualisation . . . . .	362
12.20.9 Using TTree::Scan . . . . .	371
12.20.10 TEventList and TEntryList . . . . .	372
12.20.11 Filling a Histogram . . . . .	376
12.21 Using TTree::MakeClass . . . . .	378
12.21.1 Creating a Class with MakeClass . . . . .	379
12.21.2 MyClass.h . . . . .	379
12.21.3 MyClass.C . . . . .	380
12.21.4 Modifying MyClass::Loop . . . . .	381



12.21.5 Loading MyClass . . . . .	381
12.22 Using TTree::MakeSelector . . . . .	382
12.22.1 Performance Benchmarks . . . . .	384
12.23 Impact of Compression on I/O . . . . .	384
12.24 Chains . . . . .	385
12.24.1 TChain::AddFriend . . . . .	386
<b>13 Math Libraries in ROOT</b>	<b>389</b>
13.1 TMath . . . . .	389
13.2 Random Numbers . . . . .	390
13.2.1 TRandom . . . . .	390
13.2.2 TRandom1 . . . . .	390
13.2.3 TRandom2 . . . . .	390
13.2.4 TRandom3 . . . . .	391
13.2.5 Seeding the Generators . . . . .	391
13.2.6 Examples of Using the Generators . . . . .	391
13.2.7 Random Number Distributions . . . . .	391
13.2.8 UNURAN . . . . .	392
13.2.9 Performances of Random Numbers . . . . .	394
13.3 MathCore Library . . . . .	394
13.4 Generic Vectors for 2, 3 and 4 Dimensions (GenVector) . . . . .	394
13.4.1 Main Characteristics . . . . .	395
13.4.2 Example: 3D Vector Classes . . . . .	397
13.4.3 Example: 3D Point Classes . . . . .	400
13.4.4 Example: LorentzVector Classes . . . . .	401
13.4.5 Example: Vector Transformations . . . . .	403
13.4.6 Example with External Packages . . . . .	406
13.5 MathMore Library . . . . .	406
13.6 Mathematical Functions . . . . .	407
13.6.1 Special Functions in MathCore . . . . .	407
13.6.2 Special Functions in MathMore . . . . .	408
13.6.3 Probability Density Functions (PDF) . . . . .	409
13.6.4 Cumulative Distribution Functions (CDF) . . . . .	410
13.7 Linear Algebra: SMatrix Package . . . . .	411
13.7.1 Example: Vector Class (SVector) . . . . .	411
13.7.2 Example: Matrix Class (SMatrix) . . . . .	413
13.7.3 Example: Matrix and Vector Functions and Operators . . . . .	416
13.7.4 Matrix and Vector Functions . . . . .	417
13.8 Minuit2 Package . . . . .	417
13.9 ROOT Statistics Classes . . . . .	418

13.9.1	Classes for Computing Limits and Confidence Levels . . . . .	418
13.9.2	Specialized Classes for Fitting . . . . .	418
13.9.3	Multi-variate Analysis Classes . . . . .	419
<b>14</b>	<b>Linear Algebra in ROOT</b>	<b>421</b>
14.1	Overview of Matrix Classes . . . . .	421
14.2	Matrix Properties . . . . .	423
14.2.1	Accessing Properties . . . . .	423
14.2.2	Setting Properties . . . . .	424
14.3	Creating and Filling a Matrix . . . . .	424
14.4	Matrix Operators and Methods . . . . .	426
14.4.1	Arithmetic Operations between Matrices . . . . .	426
14.4.2	Arithmetic Operations between Matrices and Real Numbers . . . . .	426
14.4.3	Comparisons and Boolean Operations . . . . .	427
14.4.4	Matrix Norms . . . . .	427
14.4.5	Miscellaneous Operators . . . . .	428
14.5	Matrix Views . . . . .	428
14.5.1	View Operators . . . . .	429
14.5.2	View Examples . . . . .	430
14.6	Matrix Decompositions . . . . .	431
14.6.1	Tolerances and Scaling . . . . .	432
14.6.2	Condition number . . . . .	433
14.6.3	LU . . . . .	434
14.6.4	Bunch-Kaufman . . . . .	434
14.6.5	Cholesky . . . . .	434
14.6.6	QRH . . . . .	435
14.6.7	SVD . . . . .	435
14.7	Matrix Eigen Analysis . . . . .	435
14.8	Speed Comparisons . . . . .	436
<b>15</b>	<b>Adding a Class</b>	<b>439</b>
15.1	The Role of TObject . . . . .	439
15.1.1	Introspection, Reflection and Run Time Type Identification . . . . .	439
15.1.2	Collections . . . . .	439
15.1.3	Input/Output . . . . .	440
15.1.4	Paint/Draw . . . . .	440
15.1.5	Clone/DrawClone . . . . .	440
15.1.6	Browse . . . . .	440
15.1.7	SavePrimitive . . . . .	440
15.1.8	GetObjectInfo . . . . .	440
15.1.9	IsFolder . . . . .	440

15.1.10 Bit Masks and Unique ID . . . . .	440
15.2 Motivation . . . . .	441
15.2.1 Template Support . . . . .	442
15.3 The Default Constructor . . . . .	443
15.4 rootcint: The CINT Dictionary Generator . . . . .	444
15.4.1 Dictionaries for STL . . . . .	446
15.5 Adding a Class with a Shared Library . . . . .	446
15.5.1 The LinkDef.h File . . . . .	447
15.6 Adding a Class with ACLiC . . . . .	453
<b>16 Collection Classes</b>	<b>455</b>
16.1 Understanding Collections . . . . .	455
16.1.1 General Characteristics . . . . .	455
16.1.2 Determining the Class of Contained Objects . . . . .	456
16.1.3 Types of Collections . . . . .	456
16.1.4 Ordered Collections (Sequences) . . . . .	457
16.2 Iterators: Processing a Collection . . . . .	457
16.3 Foundation Classes . . . . .	457
16.4 A Collectable Class . . . . .	458
16.5 The TIter Generic Iterator . . . . .	459
16.6 The TList Collection . . . . .	460
16.6.1 Iterating Over a TList . . . . .	461
16.7 The TObjArray Collection . . . . .	462
16.8 TClonesArray An Array of Identical Objects . . . . .	462
16.8.1 The Idea Behind TClonesArray . . . . .	463
16.9 Template Containers and STL . . . . .	463
<b>17 Physics Vectors</b>	<b>465</b>
17.1 The Physics Vector Classes . . . . .	465
17.2 TVector3 . . . . .	465
17.2.1 Declaration / Access to the Components . . . . .	466
17.2.2 Other Coordinates . . . . .	466
17.2.3 Arithmetic / Comparison . . . . .	467
17.2.4 Related Vectors . . . . .	467
17.2.5 Scalar and Vector Products . . . . .	467
17.2.6 Angle between Two Vectors . . . . .	467
17.2.7 Rotation around Axes . . . . .	467
17.2.8 Rotation around a Vector . . . . .	467
17.2.9 Rotation by TRotation Class . . . . .	468
17.2.10 Transformation from Rotated Frame . . . . .	468
17.3 TRotation . . . . .	468

17.3.1	Declaration, Access, Comparisons . . . . .	468
17.3.2	Rotation around Axes . . . . .	468
17.3.3	Rotation around Arbitrary Axis . . . . .	469
17.3.4	Rotation of Local Axes . . . . .	469
17.3.5	Inverse Rotation . . . . .	469
17.3.6	Compound Rotations . . . . .	469
17.3.7	Rotation of TVector3 . . . . .	469
17.4	TLorentzVector . . . . .	470
17.4.1	Declaration . . . . .	470
17.4.2	Access to Components . . . . .	470
17.4.3	Vector Components in Non-Cartesian Coordinates . . . . .	471
17.4.4	Arithmetic and Comparison Operators . . . . .	471
17.4.5	Magnitude/Invariant mass, beta, gamma, scalar product . . . . .	471
17.4.6	Lorentz Boost . . . . .	472
17.4.7	Rotations . . . . .	472
17.4.8	Miscellaneous . . . . .	473
17.5	TLorentzRotation . . . . .	473
17.5.1	Declaration . . . . .	473
17.5.2	Access to the Matrix Components/Comparisons . . . . .	474
17.5.3	Transformations of a Lorentz Rotation . . . . .	474
17.5.4	Transformation of a TLorentzVector . . . . .	474
17.5.5	Physics Vector Example . . . . .	475
<b>18</b>	<b>The Geometry Package</b>	<b>477</b>
18.1	Quick Start: Creating the “world” . . . . .	477
18.1.1	Example 1: Creating the World . . . . .	477
18.1.2	Example 2: A Geometrical Hierarchy Look and Feel . . . . .	478
18.2	Materials and Tracking Media . . . . .	480
18.2.1	Elements, Materials and Mixtures . . . . .	481
18.2.2	Radionuclides . . . . .	482
18.2.3	Tracking Media . . . . .	486
18.2.4	User Interface for Handling Materials and Media . . . . .	486
18.3	Shapes . . . . .	486
18.3.1	Units . . . . .	488
18.3.2	Primitive Shapes . . . . .	488
18.3.3	Composite Shapes . . . . .	502
18.3.4	Navigation Methods Performed By Shapes . . . . .	506
18.3.5	Creating Shapes . . . . .	507
18.3.6	Dividing Shapes . . . . .	508
18.3.7	Parametric Shapes . . . . .	508

18.4	Geometry Creation . . . . .	508
18.4.1	The Volume Hierarchy . . . . .	509
18.4.2	Creating and Positioning Volumes . . . . .	511
18.4.3	Geometrical Transformations . . . . .	518
18.4.4	Ownership of Geometry Objects . . . . .	521
18.5	Navigation and Tracking . . . . .	521
18.5.1	TGeoNavigator Class . . . . .	522
18.5.2	Initializing the Starting Point . . . . .	522
18.5.3	Initializing the Direction . . . . .	522
18.5.4	Initializing the State . . . . .	523
18.5.5	Checking the Current State . . . . .	523
18.5.6	Saving and Restoring the Current State . . . . .	525
18.5.7	Navigation Queries . . . . .	525
18.5.8	Creating and Visualizing Tracks . . . . .	528
18.6	Checking the Geometry . . . . .	530
18.6.1	The Overlap Checker . . . . .	530
18.6.2	Graphical Checking Methods . . . . .	533
18.7	The Drawing Package . . . . .	535
18.7.1	Drawing Volumes and Hierarchies of Volumes . . . . .	535
18.7.2	Visualization Settings and Attributes . . . . .	536
18.7.3	Ray Tracing . . . . .	537
18.8	Representing Misalignments of the Ideal Geometry . . . . .	538
18.8.1	Physical Nodes . . . . .	538
18.9	Geometry I/O . . . . .	540
18.9.1	GDML . . . . .	542
18.10	Navigation Algorithms . . . . .	542
18.10.1	Finding the State Corresponding to a Location (x,y,z) . . . . .	542
18.10.2	Finding the Distance to Next Crossed Boundary . . . . .	543
18.11	Geometry Graphical User Interface . . . . .	547
18.11.1	Editing a Geometry . . . . .	547
18.11.2	The Geometry Manager Editor . . . . .	550
18.11.3	Editing Existing Objects . . . . .	551
18.11.4	Creation of New Objects . . . . .	554
18.11.5	Editing Volumes . . . . .	554
18.11.6	How to Create a Valid Geometry with Geometry Editors . . . . .	558

<b>19 Python and Ruby Interfaces</b>	<b>559</b>
19.1 PyROOT Overview . . . . .	559
19.1.1 Glue-ing Applications . . . . .	559
19.1.2 Access to ROOT from Python . . . . .	560
19.1.3 Access to Python from ROOT . . . . .	560
19.1.4 Installation . . . . .	561
19.1.5 Using PyROOT . . . . .	562
19.1.6 Memory Handling . . . . .	566
19.1.7 Performance . . . . .	567
19.1.8 Use of Python Functions . . . . .	567
19.1.9 Working with Trees . . . . .	569
19.1.10 Using Your Own Classes . . . . .	571
19.2 How to Use ROOT with Ruby . . . . .	572
19.2.1 Building and Installing the Ruby Module . . . . .	572
<b>20 The Tutorials and Tests</b>	<b>575</b>
20.1 \$ROOTSYS/tutorials . . . . .	575
20.2 \$ROOTSYS/test . . . . .	577
20.2.1 Event - An Example of a ROOT Application . . . . .	578
20.2.2 stress - Test and Benchmark . . . . .	581
20.2.3 guitest - A Graphical User Interface . . . . .	583
<b>21 Example Analysis</b>	<b>585</b>
21.1 Explanation . . . . .	585
21.2 Script . . . . .	588
<b>22 Networking</b>	<b>593</b>
22.1 Setting-up a Connection . . . . .	593
22.2 Sending Objects over the Network . . . . .	593
22.3 Closing the Connection . . . . .	594
22.4 A Server with Multiple Sockets . . . . .	594
<b>23 Threads</b>	<b>597</b>
23.1 Threads and Processes . . . . .	597
23.1.1 Process Properties . . . . .	597
23.1.2 Thread Properties . . . . .	597
23.1.3 The Initial Thread . . . . .	598
23.2 Implementation of Threads in ROOT . . . . .	598
23.2.1 Installation . . . . .	598
23.2.2 Classes . . . . .	598
23.2.3 TThread for Pedestrians . . . . .	599

23.2.4 TThread in More Details . . . . .	600
23.3 Advanced TThread: Launching a Method in a Thread . . . . .	602
23.3.1 Known Problems . . . . .	603
23.4 The Signals of ROOT . . . . .	603
23.5 Glossary . . . . .	604
<b>24 PROOF: Parallel Processing</b>	<b>607</b>
<b>25 Writing a Graphical User Interface</b>	<b>609</b>
25.1 The ROOT GUI Classes . . . . .	609
25.2 Widgets and Frames . . . . .	609
25.3 TVirtualX . . . . .	610
25.4 A Simple Example . . . . .	610
25.4.1 A Standalone Version . . . . .	615
25.5 Widgets Overview . . . . .	617
25.5.1 TQObject . . . . .	617
25.5.2 TGWidget . . . . .	617
25.5.3 TGWindow . . . . .	618
25.5.4 Frames . . . . .	618
25.6 Layout Management . . . . .	621
25.7 Event Processing: Signals and Slots . . . . .	623
25.8 Widgets in Detail . . . . .	629
25.8.1 Buttons . . . . .	629
25.8.2 Text Entries . . . . .	632
25.8.3 Number Entries . . . . .	633
25.8.4 Menus . . . . .	635
25.8.5 Toolbar . . . . .	636
25.8.6 List Boxes . . . . .	638
25.8.7 Combo Boxes . . . . .	639
25.8.8 Sliders . . . . .	640
25.8.9 Triple Slider . . . . .	641
25.8.10 Progress Bars . . . . .	641
25.8.11 Static Widgets . . . . .	642
25.8.12 Status Bar . . . . .	643
25.8.13 Splitters . . . . .	643
25.8.14 TGCanvas, ViewPort and Container . . . . .	645
25.8.15 Embedded Canvas . . . . .	646
25.9 The ROOT Graphics Editor (GED) . . . . .	646
25.9.1 Object Editors . . . . .	647
25.9.2 Editor Design Elements . . . . .	647
25.10 Drag and Drop . . . . .	649

25.10.1 Drag and Drop Data Class . . . . .	649
25.10.2 Handling Drag and Drop Events . . . . .	650
<b>26 ROOT/Qt Integration Interfaces</b>	<b>653</b>
26.1 Qt-ROOT Implementation of TVirtualX Interface (BNL) . . . . .	653
26.1.1 Installation . . . . .	653
26.1.2 Applications . . . . .	655
26.1.3 TQtWidget Class, Qt Signals / Slots and TCanvas Interface . . . . .	662
26.2 GSI QtROOT . . . . .	663
26.2.1 Create a New Project in the Designer . . . . .	664
26.2.2 main() . . . . .	666
<b>27 Automatic HTML Documentation</b>	<b>669</b>
27.1 Reference Guide . . . . .	669
27.1.1 Product and Module Documentation . . . . .	670
27.2 Converting Sources (and Other Files) to HTML . . . . .	670
27.3 Special Documentation Elements: Directives . . . . .	670
27.3.1 Latex Directive . . . . .	671
27.3.2 Macro Directive . . . . .	671
27.4 Customizing HTML . . . . .	672
27.4.1 Referencing Documentation for other Libraries . . . . .	672
27.4.2 Search Engine . . . . .	672
27.4.3 ViewCVS . . . . .	672
27.4.4 Wiki Pages . . . . .	672
27.5 Tutorial . . . . .	672
<b>28 Appendix A: Install and Build ROOT</b>	<b>673</b>
28.1 License . . . . .	673
28.2 Installing ROOT . . . . .	673
28.3 Choosing a Version . . . . .	673
28.4 Installing Precompiled Binaries . . . . .	673
28.5 Installing the Source . . . . .	674
28.5.1 Installing and Building the Source from a Compressed File . . . . .	674
28.5.2 More Build Options . . . . .	675
28.6 File system.rootrc . . . . .	675
28.6.1 TCanvas Specific Settings . . . . .	677
28.6.2 THtml Specific Settings . . . . .	678
28.6.3 GUI Specific Settings . . . . .	680
28.6.4 TBrowser Settings . . . . .	681
28.6.5 TRint Specific Settings . . . . .	681
28.6.6 ACLiC Specific Settings . . . . .	681
28.6.7 PROOF Related Variables . . . . .	682
28.7 Documentation to Download . . . . .	686



# Preface

Draft, November 2000 - version 0.6.2 In late 1994, we decided to learn and investigate Object Oriented programming and C++ to better judge the suitability of these relatively new techniques for scientific programming. We knew that there is no better way to learn a new programming environment than to use it to write a program that can solve a real problem. After a few weeks, we had our first histogramming package in C++. A few weeks later we had a rewrite of the same package using the, at that time, very new template features of C++. Again, a few weeks later we had another rewrite of the package without templates since we could only compile the version with templates on one single platform using a specific compiler. Finally, after about four months we had a histogramming package that was faster and more efficient than the well-known FORTRAN based HBOOK histogramming package. This gave us enough confidence in the new technologies to decide to continue the development. Thus was born ROOT. Since its first public release at the end of 1995, ROOT has enjoyed an ever-increasing popularity. Currently it is being used in all major High Energy and Nuclear Physics laboratories around the world to monitor, to store and to analyse data. In the other sciences as well as the medical and financial industries, many people are using ROOT. We estimate the current user base to be around several thousand people. In 1997, Eric Raymond analysed in his paper “The Cathedral and the Bazaar” the development method that makes Linux such a success. The essence of that method is: “release early, release often and listen to your customers”. This is precisely how ROOT is being developed. Over the last five years, many of our “customers” became co-developers. Here we would like to thank our main co-developers and contributors:

**Masaharu Goto** wrote the CINT C++ interpreter that became an essential part of ROOT. Despite being 8 time zones ahead of us, we have the feeling he has been sitting in the room next door since 1995.

**Andrei and Mihaela Gheata** (Alice collaboration) are co-authors of the ROOT geometry classes and Virtual Monte-Carlo. They have been working with the ROOT team since 2000.

**Olivier Couet**, who after a successful development and maintenance of PAW, has joined the ROOT team in 2000 and has been working on the graphics sub-system.

**Ilika Antcheva** has been working on the Graphical User Interface classes. She is also responsible for this latest edition of the Users Guide with a better style, improved index and several new chapters (since 2002).

**Bertrand Bellenot** has been developing and maintaining the Win32GDK version of ROOT. Bertrand has also many other contributions like the nice RootShower example (since 2001).

**Valeriy Onouchin** has been working on several ROOT packages, in particular the graphics sub-system for Windows and the GUI Builder (since 2000).

**Gerri Ganis** has been working on the authentication procedures to be used by the root daemons and the PROOF system (since 2002).

**Maarten Ballintijn** (MIT) is one of the main developers of the PROOF sub-system (since 1995).

**Valeri Fine** (now at BNL) ported ROOT to Windows and contributed largely to the 3-D graphics. He is currently working on the Qt layer of ROOT (since 1995).

**Victor Perevoztchikov** (BNL) worked on key elements of the I/O system, in particular the improved support for STL collections (1997-2001).

**Nenad Buncic** developed the HTML documentation generation system and integrated the X3D viewer inside ROOT (1995-1997).

**Suzanne Panacek** was the author of the first version of this User’s Guide and very active in preparing tutorials and giving lectures about ROOT (1999-2002).

**Axel Naumann** has been developing further the HTML Reference Guide and helps in porting ROOT under Windows (cygwin/gcc implementation) (since 2000).

**Anna Kreshuk** has developed the Linear Fitter and Robust Fitter classes as well as many functions in TMath, TF1, TGraph (since 2005).

**Richard Maunder** has contributed to the GL viewer classes (since 2004).

**Timur Pocheptsov** has contributed to the GL viewer classes and GL in pad classes (since 2004).

**Sergei Linev** has developed the XML driver and the TSQLFile classes (since 2003).

**Stefan Roiser** has been contributing to the reflex and cintex packages (since 2005).

**Lorenzo Moneta** has been contributing the MathCore, MathMore, Smatrix & Minuit2 packages (since 2005).

**Wim Lavrijsen** is the author of the PyRoot package (since 2004).

Further we would like to thank all the people mentioned in the \$ROOTSYS/README/CREDITS file for their contributions, and finally, everybody who gave comments, reported bugs and provided fixes.

Happy ROOTing!

Rene Brun & Fons Rademakers

Geneva, July 2007

# Chapter 1

## Introduction

In the mid 1990's, René Brun and Fons Rademakers had many years of experience developing interactive tools and simulation packages. They had lead successful projects such as PAW, PIAF, and GEANT, and they knew PAW the twenty-year-old FORTRAN libraries had reached their limits. Although still very popular, these tools could not scale up to the challenges offered by the Large Hadron Collider, where the data is a few orders of magnitude larger than anything seen before.

At the same time, computer science had made leaps of progress especially in the area of Object Oriented Design, and René and Fons were ready to take advantage of it.

ROOT was developed in the context of the NA49 experiment at CERN. NA49 has generated an impressive amount of data, around 10 Terabytes per run. This rate provided the ideal environment to develop and test the next generation data analysis.

One cannot mention ROOT without mentioning CINT, its C++ interpreter. CINT was created by Masa Goto in Japan. It is an independent product, which ROOT is using for the command line and script processor.

ROOT was, and still is, developed in the “Bazaar style”, a term from the book “The Cathedral and the Bazaar” by Eric S. Raymond. It means a liberal, informal development style that heavily relies on the diverse and deep talent of the user community. The result is that physicists developed ROOT for themselves; this made it specific, appropriate, useful, and over time refined and very powerful. The development of ROOT is a continuous conversation between users and developers with the line between the two blurring at times and the users becoming co-developers.

When it comes to storing and mining large amount of data, physics plows the way with its Terabytes, but other fields and industry follow close behind as they acquiring more and more data over time. They are ready to use the true and tested technologies physics has invented. In this way, other fields and industries have found ROOT useful and they have started to use it also.

In the bazaar view, software is released early and frequently to expose it to thousands of eager co-developers to pound on, report bugs, and contribute possible fixes. More users find more bugs, because they stress the program in different ways. By now, after ten years, the age of ROOT is quite mature. Most likely, you will find the features you are looking for, and if you have found a hole, you are encouraged to participate in the dialog and post your suggestion or even implementation on `roottalk`, the ROOT mailing list.

### 1.1 The ROOT Mailing Lists

The `roottalk` was the very first active ROOT mailing list. People can subscribe to it by registering at the ROOT web site: <http://root.cern.ch/root/Registration.phtml>. The RootTalk Forum <http://root.cern.ch/phpBB3/> has been gradually replaced this mailing list since September 2003. The RootTalk Forum is a web-based news group with about 10 discussion sub-units.

If you have a question, it is likely that it has been asked, answered, and stored in the `roottalk` or RootTalk Forum archives. Please use the search engine to see if your question has already been answered before sending a mail to the `roottalk` list or post a topic in the Forum.

You can browse the `roottalk` archives at: <http://root.cern.ch/root/roottalk/AboutRootTalk.html>. You can send your question without subscribing to: `roottalk@cern.ch`

## 1.2 Contact Information

Several authors wrote this book and you may see a “change of voice” from one chapter to the next. We felt we could accept this in order to have the expert explain what they know best. If you would like to contribute a chapter or add to a section, please contact [rootdoc@cern.ch](mailto:rootdoc@cern.ch). We count on you to send us suggestions on additional topics or on the topics that need more documentation. Please send your comments, corrections, questions, and suggestions to the `rootdoc` list: [rootdoc@cern.ch](mailto:rootdoc@cern.ch)

We attempt to give the user insight into the many capabilities of ROOT. The book begins with the elementary functionality and progresses in complexity reaching the specialized topics at the end. The experienced user looking for special topics may find these chapters useful: see “Networking”, “Writing a Graphical User Interface”, “Threads”, and “PROOF: Parallel Processing”.

## 1.3 Conventions Used in This Book

We tried to follow a style convention for the sake of clarity. The styles in used are described below.

To show source code in scripts or source files:

```
{
  cout << " Hello" << endl;
  float x = 3.;
  float y = 5.;
  int i = 101;
  cout <<" x = "<<x<<" y = "<<y<<" i = "<<i<< endl;
}
```

To show the ROOT command line, we show the ROOT prompt without numbers. In the interactive system, the ROOT prompt has a line number (`root[12]`); for the sake of simplicity, the line numbers are left off.

```
root[] TLine l
root[] l.Print()
TLine X1=0.000000 Y1=0.000000 X2=0.000000 Y2=0.000000
```

Italic bold monospace font indicates a global variable, for example ***gDirectory***.

When a variable term is used, it is shown between angled brackets. In the example below the variable term `<library>` can be replaced with any library in the `$ROOTSYS` directory: `$ROOTSYS/<library>/inc`.

## 1.4 The Framework

ROOT is an object-oriented framework aimed at solving the data analysis challenges of high-energy physics. There are two key words in this definition, object oriented and framework. First, we explain what we mean by a framework and then why it is an object-oriented framework.

### 1.4.1 What Is a Framework?

Programming inside a framework is a little like living in a city. Plumbing, electricity, telephone, and transportation are services provided by the city. In your house, you have interfaces to the services such as light switches, electrical outlets, and telephones. The details, for example, the routing algorithm of the phone switching system, are transparent to you as the user. You do not care; you are only interested in using the phone to communicate with your collaborators to solve your domain specific problems.

Programming outside of a framework may be compared to living in the country. In order to have transportation and water, you will have to build a road and dig a well. To have services like telephone and electricity you will need to route the wires to your home. In addition, you cannot build some things yourself. For example, you cannot build a commercial airport

on your patch of land. From a global perspective, it would make no sense for everyone to build his or her own airport. You see you will be very busy building the infrastructure (or framework) before you can use the phone to communicate with your collaborators and have a drink of water at the same time. In software engineering, it is much the same way. In a framework, the basic utilities and services, such as I/O and graphics, are provided. In addition, ROOT being a HEP analysis framework, it provides a large selection of HEP specific utilities such as histograms and fitting. The drawback of a framework is that you are constrained to it, as you are constraint to use the routing algorithm provided by your telephone service. You also have to learn the framework interfaces, which in this analogy is the same as learning how to use a telephone.

If you are interested in doing physics, a good HEP framework will save you much work. Next is a list of the more commonly used components of ROOT: Command Line Interpreter, Histograms and Fitting, Writing a Graphical User Interface, 2D Graphics, Input/Output , Collection Classes, Script Processor.

There are also less commonly used components, as: 3D Graphics, Parallel Processing (PROOF), Run Time Type Identification (RTTI), Socket and Network Communication, Threads.

#### 1.4.1.1 Advantages of Frameworks

The benefits of frameworks can be summarized as follows:

- Less code to write - the programmer should be able to use and reuse the majority of the existing code. Basic functionality, such as fitting and histogramming are implemented and ready to use and customize.
- More reliable and robust code - the code inherited from a framework has already been tested and integrated with the rest of the framework.
- More consistent and modular code - the code reuse provides consistency and common capabilities between programs, no matter who writes them. Frameworks make it easier to break programs into smaller pieces.
- More focus on areas of expertise - users can concentrate on their particular problem domain. They do not have to be experts at writing user interfaces, graphics, or networking to use the frameworks that provide those services.

#### 1.4.2 Why Object-Oriented?

Object-Oriented Programming offers considerable benefits compared to Procedure-Oriented Programming:

- Encapsulation enforces data abstraction and increases opportunity for reuse.
- Sub classing and inheritance make it possible to extend and modify objects.
- Class hierarchies and containment hierarchies provide a flexible mechanism for modeling real-world objects and the relationships among them.
- Complexity is reduced because there is little growth of the global state, the state is contained within each object, rather than scattered through the program in the form of global variables.
- Objects may come and go, but the basic structure of the program remains relatively static, increases opportunity for reuse of design.

## 1.5 Installing ROOT

To install ROOT you will need to go to the ROOT website at: <http://root.cern.ch/root/Availability.html>. You have a choice to download the binaries or the source. The source is quicker to transfer since it is only ~22 MB, but you will need to compile and link it. The binaries compiled with no debug information range from ~35 MB to ~45 MB depending on the target platform.

The installation and building of ROOT is described in Appendix A: Install and Build ROOT. You can download the binaries, or the source. The GNU g++ compiler on most UNIX platforms can compile ROOT.

Before downloading a binary version make sure your machine contains the right run-time environment. In most cases it is not possible to run a version compiled with, e.g., gcc4.0 on a platform where only gcc 3.2 is installed. In such cases you'll have to install ROOT from source.

ROOT is currently running on the following platforms: supported platforms

- GNU/Linux x86-32 (IA32) and x86-64 (AMD64) (GCC, Intel/icc, Portland/PGCC, KAI/KCC)
- Intel Itanium (IA64) GNU/Linux (GCC, Intel/ecc, SGI/CC)
- FreeBSD and OpenBSD (GCC)
- GNU/Hurd (GCC)
- HP HP-UX 10.x (IA32) and 11 (IA64) (HP CC, aCC, GCC)
- IBM AIX 4.1 (xlc compiler, GCC)
- Sun Solaris for SPARC (SUN C++ compiler, GCC)
- Sun Solaris for x86 (SUN C++ compiler, KAI/KCC)
- Compaq Alpha (GCC, KAI/KCC, DEC/CXX)
- SGI Irix 32 and 64 bits (GCC, KAI/KCC, SGI C++ compiler)
- Windows >= 95 (Microsoft Visual C++ compiler, Cygwin/GCC)
- MacOS X PPC, x86-32, x86-64 (GCC, Intel/ICC, IBM/xl)
- PowerPC with GNU/Linux and GCC, Debian v2
- PowerPC64 with GNU/Linux and GCC
- ARM with GNU/Linux and GCC
- LynxOS

## 1.6 The Organization of the ROOT Framework

Now after we know in abstract terms what the ROOT framework is, let us look at the physical directories and files that come with the ROOT installation. You may work on a platform where your system administrator has already installed ROOT. You will need to follow the specific development environment for your setup and you may not have write access to the directories. In any case, you will need an environment variable called `ROOTSYS`, which holds the path of the top ROOT directory.

```
> echo $ROOTSYS
/opt/root
```

In the `ROOTSYS` directory are examples, executables, tutorials, header tutorials files, and, if you opted to download it, the source is here. The directories of special interest to us are `bin`, `tutorials`, `lib`, `test`, and `include`. The next figure shows the contents of these directories.

### 1.6.1 \$ROOTSYS/bin

The `bin` directory contains several executables.

---

---

<code>root</code>	shows the ROOT splash screen and calls <code>root.exe</code>
<code>root.exe</code>	the executable that <code>root</code> calls, if you use a debugger such as <code>gdb</code> , you will need to run <code>root.exe</code> directly CINTdebugger
<code>rootcint</code>	is the utility ROOT uses to create a class dictionary for CINT
<code>rmkdepend</code>	a modified version of <code>makedepend</code> that is used by the ROOT build system
<code>root-config</code>	a script returning the needed compile flags and libraries for projects that compile and link with ROOT
<code>cint</code>	the C++ interpreter executable that is independent of ROOT
<code>makecint</code>	the pure CINT version of <code>rootcint</code> , used to generate a dictionary; It is used by some of CINT install scripts to generate dictionaries for external system libraries
<code>proofd</code>	a small daemon used to authenticate a user of ROOT parallel processing capability (PROOF)
<code>proofserv</code>	the actual PROOF process, which is started by <code>proofd</code> after a user, has successfully been authenticated
<code>rootd</code>	is the daemon for remote ROOT file access (see the <b>TNetFile</b> )

---

### 1.6.2 \$ROOTSYS/lib

There are several ways to use ROOT, one way is to run the executable by typing `root` at the system prompt another way is to link with the ROOT libraries and make the ROOT classes available in your own program.

Here is a short description of the most relevant libraries, the ones marked with a \* are only installed when the options specified them.

- `libAsImage` is the image manipulation library
- `libCint` is the C++ interpreter (CINT)
- `libCore` is the Base classes
- `libEG` is the abstract event generator interface classes
- `*libEGPythia` is the Pythia5 event generator interface
- `*libEGPythia6` is the Pythia6 event generator interface
- `libFitPanel` contains the GUI used for fitting
- `libGed` contains the GUI used for editing the properties of histograms, graphs, etc.
- `libGeom` is the geometry package (with builder and painter)
- `libGpad` is the pad and canvas classes which depend on low level graphics
- `libGraf` is the 2D graphics primitives (can be used independent of `libGpad`)
- `libGraf3d` is the 3D graphics primitives
- `libGui` is the GUI classes (depend on low level graphics)
- `libGuiBld` is the GUI designer
- `libGuiHtml` contains the embedded HTML browser
- `libGX11` is the low level graphics interface to the X11 system
- `*libGX11TTF` is an add-on library to `libGX11` providing TrueType fonts
- `libHbook` is for interface ROOT - HBOOK

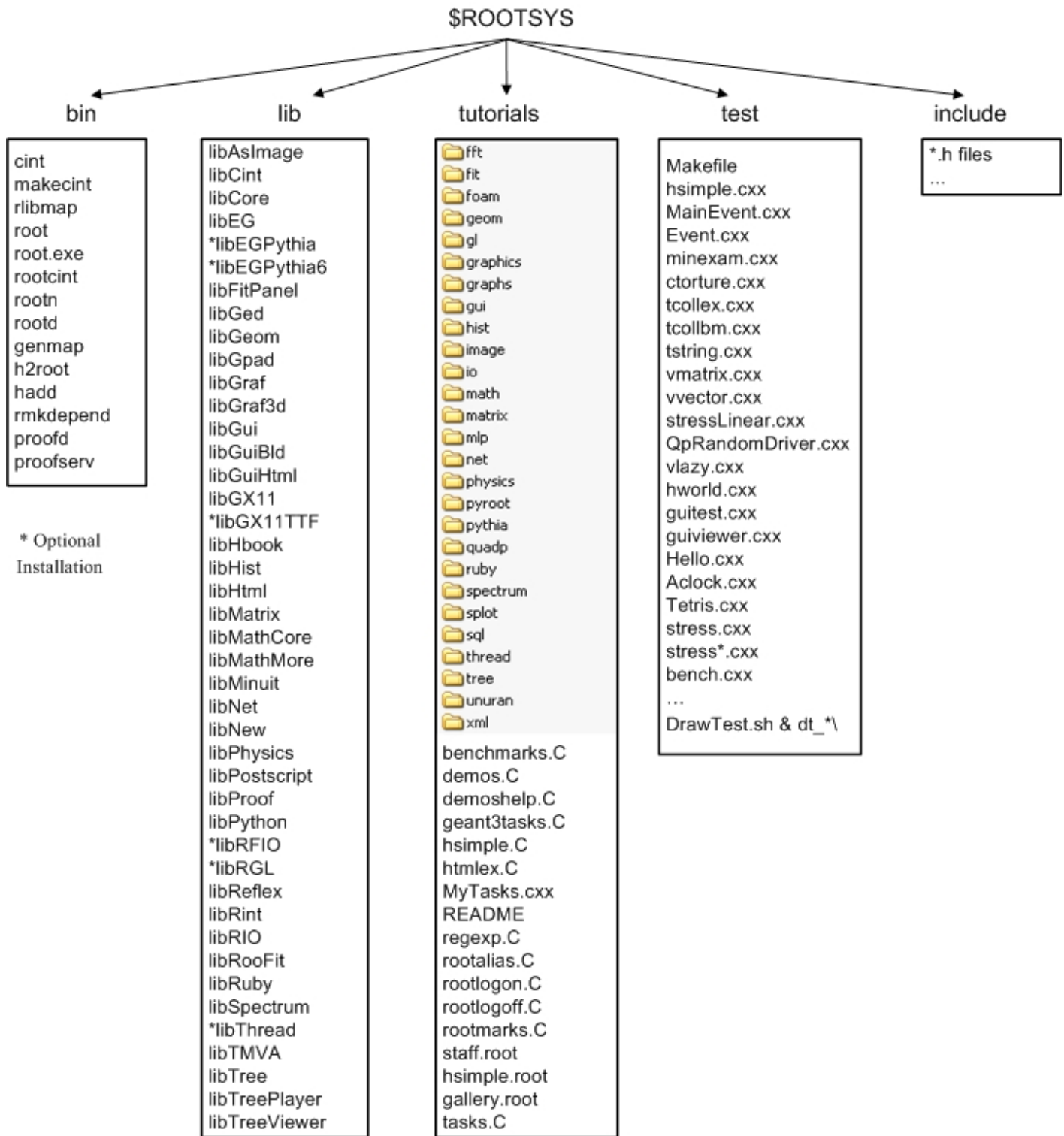

Figure 1.1: ROOT framework directories



- `libHist` is the histogram classes (with accompanying painter library)
- `libHtml` is the HTML documentation generation system
- `libMatrix` is the matrix and vector manipulation
- `libMathCore` contains the core mathematics and physics vector classes
- `libMathMore` contains additional functions, interfacing the GSL math library
- `libMinuit` is the MINUIT fitter
- `libNet` contains functionality related to network transfer
- `libNew` is the special global new/delete, provides extra memory checking and interface for shared memory (optional)
- `libPhysics` contains the legacy physics classes (TLorentzVector, etc.)
- `libPostscript` is the PostScript interface
- `libProof` is the parallel ROOT Facility classes
- `libPython` provides the interface to Python
- `*libRFIO` is the interface to CERN RFIO remote I/O system.
- `*libRGL` is the interface to OpenGL.
- `libReflex` is the runtime type database library used by CINT
- `libRint` is the interactive interface to ROOT (provides command prompt)
- `libRIO` provides the functionality to write and read objects to and from ROOT files
- `libRooFit` is the RooFit fitting framework
- `libRuby` is the interface to Ruby
- `libSpectrum` provides functionality for spectral analysis
- `*libThread` is the interface to TThread classes
- `libTMVA` contains the multivariate analysis toolkit
- `libTree` is the TTree object container system
- `libTreePlayer` is the TTree drawing classes
- `libTreeViewer` is the graphical TTree query interface

### 1.6.2.1 Library Dependencies

The libraries are designed and organized to minimize dependencies, such that you can load just enough code for the task at hand rather than having to load all libraries or one monolithic chunk. The core library (`libCore.so`) contains the essentials; it is a part of all ROOT applications. In the Figure 1-2 you see that `libCore.so` is made up of base classes, container classes, meta information classes, operating system specific classes, and the ZIP algorithm used for compression of the ROOT files.

The CINT library (`libCint.so`) is also needed in all ROOT applications, and even by `libCore`. It can be used independently of `libCore`, in case you only need the C++ interpreter and not ROOT. A program referencing only `TObject` only needs `libCore` and `libCint`. To add the ability to read and write ROOT objects one also has to load `libRIO`. As one would expect, none of that depends on graphics or the GUI.

Library dependencies have different consequences; depending on whether you try to build a binary, or you just try to access a class that is defined in a library.

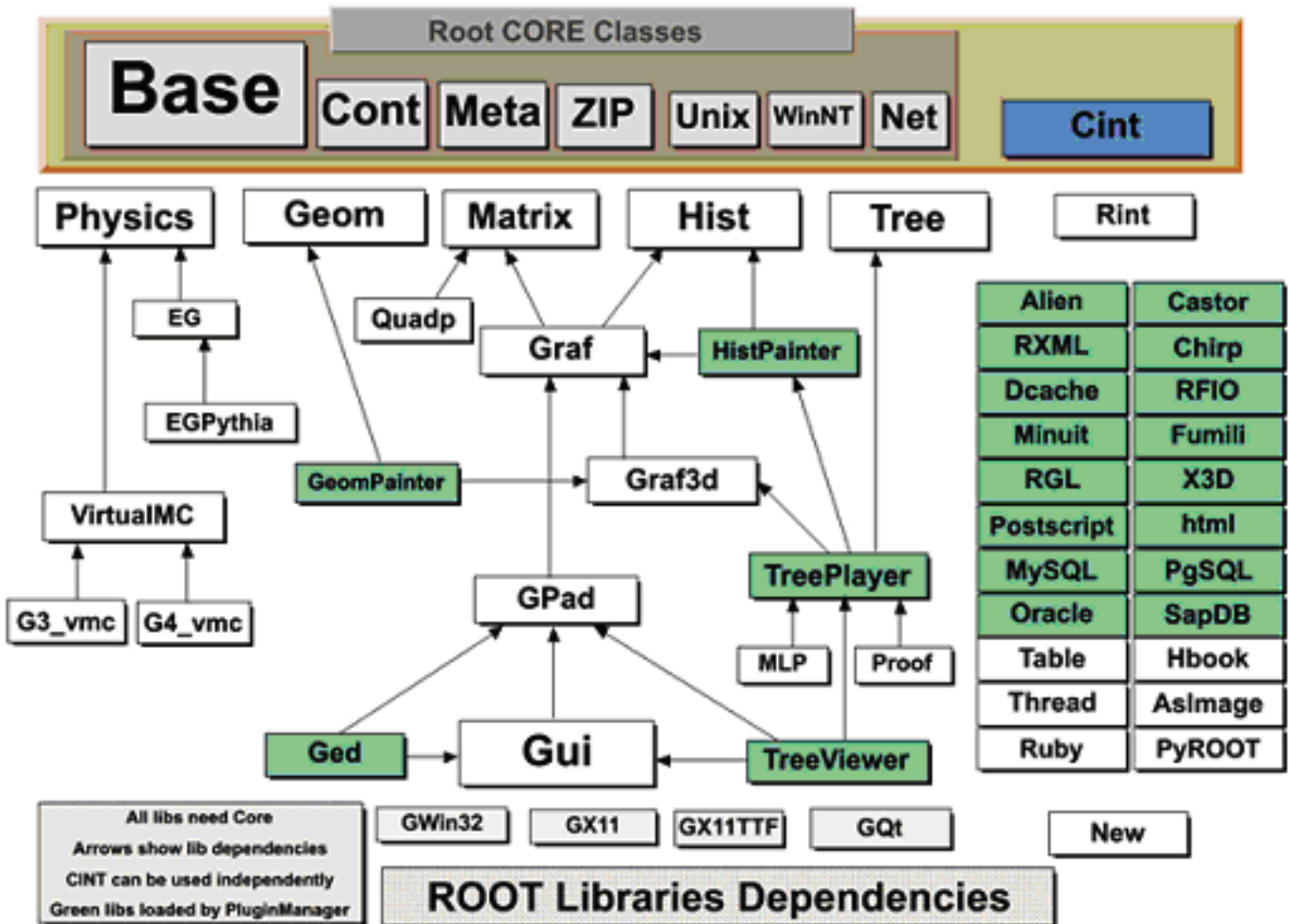

Figure 1.2: ROOT libraries dependencies

### 1.6.2.2 Linktime Library Dependencies

When building your own executable you will have to link against the libraries that contain the classes you use. The ROOT reference guide states the library a class is reference guide defined in. Almost all relevant classes can be found in libraries returned by `root-config -glibs`; the graphics libraries are returned by `root-config --libs`. These commands are commonly used in Makefiles. Using `root-config` instead of enumerating the libraries by hand allows you to link them in a platform independent way. Also, if ROOT library names change you will not need to change your Makefile.

A batch program that does not have a graphic display, which creates, fills, and saves histograms and trees, only needs to link the core libraries (`libCore`, `libCint`, `libRIO`), `libHist` and `libTree`. If ROOT needs access to other libraries, it loads them dynamically. For example, if the `TreeViewer` is used, `libTreePlayer` and all libraries `libTreePlayer` depends on are loaded also. The dependent libraries are shown in the ROOT reference guide's library dependency graph. The difference between reference guide `libHist` and `libHistPainter` is that the former needs to be explicitly linked and the latter will be loaded automatically at runtime when ROOT needs it, by means of the Plugin Manager. plugin manager

In the Figure 1-2, the libraries represented by green boxes outside of the core are loaded via the plugin manager plugin manager or equivalent techniques, while the white ones are not. Of course, if one wants to access a plugin library directly, it has to be explicitly linked. An example of a plugin library is `libMinuit`. To create and fill histograms you need to link `libHist.so`. If the code has a call to fit the histogram, the "fitter" will dynamically load `libMinuit` if it is not yet loaded.

### 1.6.2.3 Plugins: Runtime Library Dependencies for Linking

plugin manager The Plugin Manager `TPluginManager` allows postponing library dependencies to runtime: a plugin library will only be loaded when it is needed. Non-plugins will need to be linked, and are thus loaded at start-up. Plugins are defined by a base class (e.g. `TFile`) that will be implemented in a plugin, a tag used to identify the plugin (e.g. `~rfio:` as part of the protocol string), the plugin class of which an object will be created (e.g. `TRFIOFile`), the library to be loaded (in short `libRFIO.so` to `RFIO`), and the constructor to be called (e.g. `"TRFIOFile()"`). This can be specified in the `.rootrc` which already contains many plugin definitions, or by calls to `gROOT->GetPluginManager()->AddHandler()`.

### 1.6.2.4 Library Autoloading

When using a class in CINT, e.g. in an interpreted source file, ROOT will automatically load the library that defines this class. On start-up, ROOT parses all files ending on `.rootmap` `rootmap` that are in one of the `$LD_LIBRARY_PATH` (or `$DYLD_LIBRARY_PATH` for MacOS, or `$PATH` for Windows). They contain class names and the library names that the class depends on. After reading them, ROOT knows which classes are available, and which libraries to load for them.

When `TSystem::Load("ALib")` is called, ROOT uses this information to determine which libraries `libALib.so` depends on. It will load these libraries first. Otherwise, loading the requested library could cause a system (dynamic loader) error due to unresolved symbols.

## 1.6.3 \$ROOTSYS/tutorials

tutorials The tutorials directory contains many example example scripts. They assume some basic knowledge of ROOT, and for the new user we recommend reading the chapters: "Histograms" and "Input/Output" before trying the examples. The more experienced user can jump to chapter "The Tutorials and Tests" to find more explicit and specific information about how to build and run the examples.

The `$ROOTSYS/tutorials/` directory include the following sub-directories:

`fft`: Fast Fourier Transform with the `fftw` package `fit`: Several examples illustrating minimization/fitting `foam`: Random generator in multidimensional space `geom`: Examples of use of the geometry package (`TGeo` classes) `gl`: Visualisation with OpenGL `graphics`: Basic graphics `graphs`: Use of `TGraph`, `TGraphErrors`, etc. `gui`: Scripts to create Graphical User Interface `hist`: Histogramming `image`: Image Processing `io`: Input/Output `math`: Maths and Statistics functions `matrix`: Matrices (`TMatrix`) examples `mlp`: Neural networks with `TMultiLayerPerceptron` `net`: Network classes (client/server examples) `physics`: LorentzVectors, phase space `pyroot`: Python tutorials `pythia`: Example with `pythia6` `quadrp`: Quadratic Programming `ruby`: ruby tutorials `smatrix`: Matrices with a templated package `spectrum`: Peak finder, background, deconvolutions `splot`: Example of the `TSplot` class (signal/background estimator) `sql`: Interfaces to SQL (mysql, oracle, etc) `thread`: Using Threads `tmva`: Examples of the MultiVariate Analysis classes `tree`: Creating Trees, Playing with Trees `unuran`: Interface with the `unuran` random generator library `xml`: Writing/Reading xml files

You can execute the scripts in `$ROOTSYS/tutorials` (or sub-directories) by setting your current directory in the script directory or from any user directory with write access. Several tutorials create new files. If you have write access to the tutorials directory, the new files will be created in the tutorials directory, otherwise they will be created in the user directory.

### 1.6.4 `$ROOTSYS/test`

The test directory contains a set of examples example that represent all areas of the framework. When a new release is cut, the examples in this directory are compiled and run to test the new release's backward compatibility. The list of source files is described in chapter "The Tutorials and Tests".

The `$ROOTSYS/test` directory is a gold mine of ROOT-wisdom nuggets, and we encourage you to explore and exploit it. We recommend the new users to read the chapter "Getting Started". The chapter "The Tutorials and Tests" has instructions on how to build all the programs and it goes over the examples `Event` and `stress`.

### 1.6.5 `$ROOTSYS/include`

The `include` directory contains all header files. It is especially important because the header files contain the class definitions.

### 1.6.6 `$ROOTSYS/<library>`

The directories we explored above are available when downloading the binaries. When downloading the source you also get a directory for each library with the corresponding header and source files, located in the `inc` and `src` subdirectories. To see what classes are in a library, you can check the `<library>/inc` directory for the list of class definitions. For example, the physics library `libPhysics.so` contains these class definitions:

```
> ls -m $ROOTSYS/math/physics/inc/
LinkDef.h, TFeldmanCousins.h, TGenPhaseSpace.h, TLorentzRotation.h,
TLorentzVector.h, TQuaternion.h, TRobustEstimator.h, TRolke.h,
TRotation.h, TVector2.h, TVector3.h
```

## 1.7 How to Find More Information

website The ROOT web site has up to date documentation. The ROOT source code automatically generates this documentation, so each class is explicitly documented on its own web page, which is always up to date with the latest official release of ROOT.

The ROOT Reference Guide web pages can be found at class index reference guide <http://root.cern.ch/root/html/ClassIndex.html>. Each page contains a class description, and an explanation of each method. It shows the class inheritance tree and lets you jump to the parent class page by clicking on the class name. If you want more details, you can even see the source. There is a help page available in the little box on the upper right hand side of each class documentation page. You can see on the next page what a typical class documentation web page looks like. The ROOT web site also contains in addition to this Reference Guide, "How To's", a list of publications and example applications.

### 1.7.1 Class Reference Guide

The top of any class reference page lets you jump to different parts of the documentation. The first line links to the class index and the index for the current module (a group of classes, often a library). The second line links to the ROOT homepage and the class overviews. The third line links the source information - a HTML version of the source and header file as well as the CVS (the source management system used for the ROOT development) information of the files. The last line links the different parts of the current pages.

<b>Location:</b>	<a href="#">ROOT</a> » <a href="#">BASE</a> » <a href="#">TAttText</a>
<b>Quick Links:</b>	<a href="#">ROOT</a>   <a href="#">Class Index</a>   <a href="#">Class Hierarchy</a>
<b>Source:</b>	<a href="#">header file</a>   <a href="#">source file</a>   <a href="#">viewCVS header</a>   <a href="#">viewCVS source</a>
<b>Sections:</b>	<a href="#">class description</a>   <a href="#">function members</a>   <a href="#">data members</a>   <a href="#">class charts</a>

### `Int_t GetQuantiles (Int_t nprobSum, Double_t* q, const Double_t* probSum)`

Compute Quantiles for density distribution of this function  
 Quantile  $x_q$  of a probability distribution Function  $F$  is defined as

$$F(x_q) = \int_{x_{\min}}^{x_q} f dx = q \text{ with } 0 \leq q \leq 1.$$

Figure 1.3: Example of function documentation, with automatically generated LaTeX-like graphics

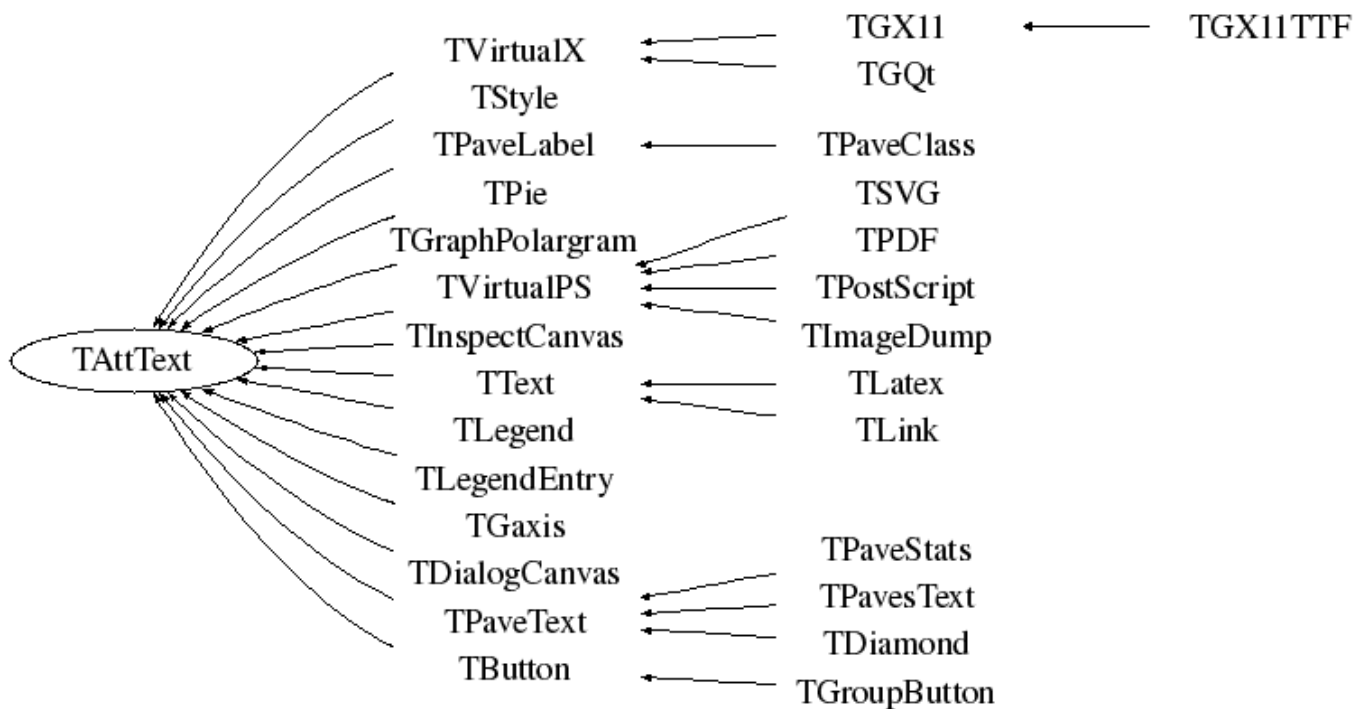

Figure 1.4: Inheritance tree, showing what the current class derives from, and which classes inherit from it

```
//  
void TList::AddLast(TObject *obj)  
{  
    // Add object at the end of the list.  
  
    if (IsArgNull("AddLast", obj)) return;  
  
    if (!fFirst) {  
        fFirst = NewLink(obj);  
        fLast = fFirst;  
    } else  
        TObjLink* TList::NewLink(TObject* obj, TObjLink* prev=0)  
        fLast = NewLink(obj, fLast);  
    fSize++;  
    Changed();  
}
```

Figure 1.5: HTML version of the source file linking all types and most functions

# Chapter 2

## Getting Started

We begin by showing you how to use ROOT interactively. There are two examples to click through and learn how to use the GUI. We continue by using the command line, and explaining the coding conventions, global variables and the environment setup. If you have not installed ROOT, you can do so by following the instructions in the appendix, or on the ROOT web site: <http://root.cern.ch/root/Availability.html>

### 2.1 Setting the Environment Variables

Before you can run ROOT you need to set the environment variable `ROOTSYS` and change your path to include `root/bin` and library path variables to include `root/lib`. Please note: the syntax is for `bash`, if you are running `tcsh` you will have to use `setenv` instead of `export`.

1. Define the variable `$ROOTSYS` to the directory where you unpacked the ROOT:

```
$ export ROOTSYS=$HOME/root
```

2. Add `ROOTSYS/bin` to your `PATH`:

```
$ export PATH=$PATH:$ROOTSYS/bin
```

3. Setting the Library Path

On HP-UX, before executing the interactive module, you must set the library path:

```
$ export SHLIB_PATH=$SHLIB_PATH:$ROOTSYS/lib
```

On AIX, before executing the interactive module, you must set the library path:

```
$ [ -z "$LIBPATH" ] && export LIBPATH=/lib:/usr/lib  
$ export LIBPATH=$LIBPATH:$ROOTSYS/lib
```

On Linux, Solaris, Alpha OSF and SGI, before executing the interactive module, you must set the library path:

```
$ export LD_LIBRARY_PATH=$LD_LIBRARY_PATH:$ROOTSYS/lib
```

On Solaris, in case your `LD_LIBRARY_PATH` is empty, you should set it:

```
$ export LD_LIBRARY_PATH=$LD_LIBRARY_PATH:$ROOTSYS/lib:/usr/dt/lib
```

If you use the `afs` version you should set (*vers* = version number, *arch* = architecture):

```
$ export ROOTSYS=/afs/cern.ch/sw/lcg/external/root/vers/arch/root
```

If ROOT was installed in `$HOME/myroot` directory on a local machine, one can do:

```
cd $HOME/myroot
. bin/thisroot.sh      // or source bin/thisroot.sh
```

The new `$ROOTSYS/bin/thisroot.[c]sh` scripts will set correctly the `ROOTSYS`, `LD_LIBRARY_PATH` or other paths depending on the platform and the `MANPATH`. To run the program just type: `root`.

## 2.2 Start and Quit a ROOT Session

```
% root
*****
*                                     *
*           W E L C O M E  to  R O O T           *
*                                     *
*   Version   5.34/07      26 April 2013   *
*                                     *
*   You are welcome to visit our Web site *
*           http://root.cern.ch           *
*                                     *
*****
```

```
ROOT 5.34/07 (v5-34-07@c1f030b, May 13 2013, 16:42:38 on macosx64)
```

```
CINT/ROOT C/C++ Interpreter version 5.18.00, July 2, 2010
```

```
Type ? for help. Commands must be C++ statements.
```

```
Enclose multiple statements between { }.
```

```
root [0]
```

To start ROOT you can type `root` at the system prompt. This starts up CINT, the ROOT command line C/C++ interpreter, and it gives you the ROOT prompt (`root[0]`).

It is possible to launch ROOT with some command line options, as shown below:

```
% root -?
Usage: root [-l] [-b] [-n] [-q] [dir] [[file:]data.root]
                                           [file1.C ... fileN.C]
```

Options:

```
-b : run in batch mode without graphics
-n : do not execute logon and logoff macros as specified in .rootrc
-q : exit after processing command line macro files
-l : do not show splash screen
-x : exit on exception
dir : if dir is a valid directory cd to it before executing
```

```
-?      : print usage
-h      : print usage
--help  : print usage
-config : print ./configure options
-memstat : run with memory usage monitoring
```

- `-b` ROOT session runs in batch mode, without graphics display. This mode is useful in case one does not want to set the `DISPLAY` or cannot do it for some reason.



- -n usually, launching a ROOT session will execute a logon script and quitting will execute a logoff script. This option prevents the execution of these two scripts.
- it is also possible to execute a script without entering a ROOT session. One simply adds the name of the script(s) after the ROOT command. Be warned: after finishing the execution of the script, ROOT will normally enter a new session.
- -q process command line script files and exit.

For example if you would like to run a script `myMacro.C` in the background, redirect the output into a file `myMacro.log`, and exit after the script execution, use the following syntax:

```
root -b -q myMacro.C > myMacro.log
```

If you need to pass a parameter to the script use:

```
root -b -q 'myMacro.C(3)' > myMacro.log
```

Be mindful of the quotes, i.e. if you need to pass a string as a parameter, the syntax is:

```
root -b -q 'myMacro.C("text")' > myMacro.log
```

You can build a shared library with ACLiC and then use this shared library on the command line for a quicker execution (i.e. the compiled speed rather than the interpreted speed). See also “CINT the C++ Interpreter”.

```
root -b -q myMacro.so > myMacro.log
```

ROOT has a powerful C/C++ interpreter giving you access to all available ROOT classes, global variables, and functions via the command line. By typing C++ statements at the prompt, you can create objects, call functions, execute scripts, etc. For example:

```
root[] 1+sqrt(9)
(const double)4.0000000000000000e+00
root[] for (int i = 0; i<4; i++) cout << "Hello" << i << endl
Hello 0
Hello 1
Hello 2
Hello 3
root[] .q
```

To exit the ROOT session, type `.q`.

```
root[] .q
```

## 2.3 Using the GUI

The basic whiteboard on which an object is drawn in ROOT is called a canvas (defined by the class `TCanvas`). Every object in the canvas is a graphical object in the sense that you can grab it, resize it, and change some characteristics using the mouse. The canvas area can be divided in several sub areas, so-called pads (the class `TPad`). A pad is a canvas sub area that can contain other pads or graphical objects. At any one time, just one pad is the so-called active pad. Any object at the moment of drawing will be drawn in the active pad. The obvious question is: what is the relation between a canvas and a pad? In fact, a canvas is a pad that spans through an entire window. This is nothing else than the notion of inheritance. The `TPad` class is the parent of the `TCanvas` class. In ROOT, most objects derive from a base class `TObject`. This class has a virtual method `Draw()` such as all objects are supposed to be able to be “drawn”. If several canvases are defined, there is only one active at a time. One draws an object in the active canvas by using the statement:

```
object.Draw()
```

This instructs the object “object” to draw itself. If no canvas is opened, a default one (named “c1”) is created. In the next example, the first statement defines a function and the second one draws it. A default canvas is created since there was no opened one. You should see the picture as shown in the next figure.

```
root[] TF1 f1("func1","sin(x)/x",0,10)
root[] f1.Draw()
<TCanvas::MakeDefCanvas>: created default TCanvas with name c1
```

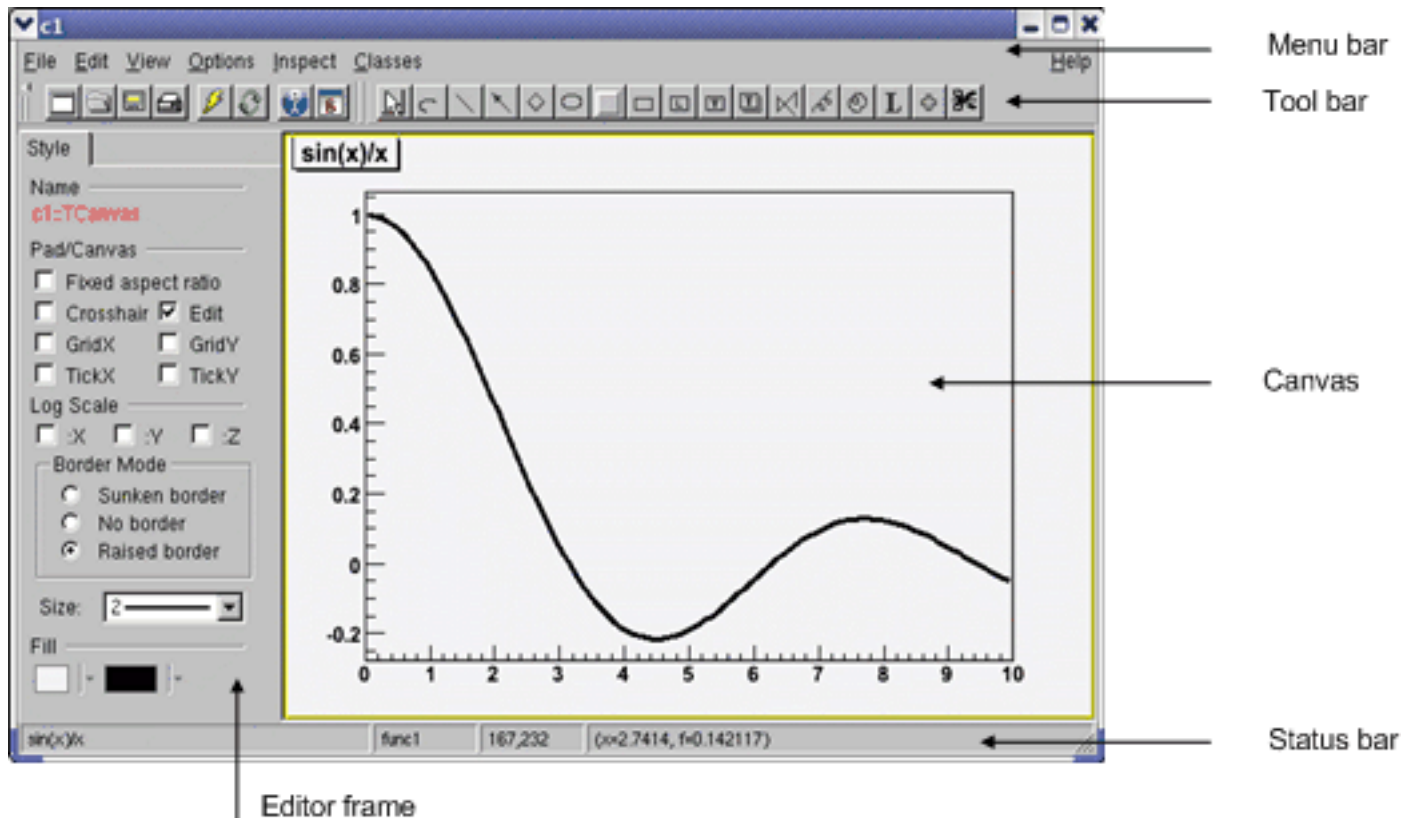

Figure 2.1: A canvas with drawing

The following components comprise the canvas window:

- Menu bar - contains main menus for global operations with files, print, clear canvas, inspect, etc.
- Tool bar - has buttons for global and drawing operations; such as arrow, ellipse, latex, pad, etc.
- Canvas - an area to draw objects.
- Status bar - displays descriptive messages about the selected object.
- Editor frame - responds dynamically and presents the user interface according to the selected object in the canvas.

### 2.3.1 Main Menus and Toolbar

At the top of the canvas window are File, Edit, View, Options, Inspect, Classes and Help menus.

### 2.3.1.1 File Menu

- *New Canvas*: creates a new canvas window in the current ROOT session.
- *Open. . .*: popup a dialog to open a file.
- *Close Canvas*: close the canvas window.
- *Save*: save the drawing of the current canvas in a format selectable from the submenu. The current canvas name is used as a file name for various formats such as PostScript, GIF, JPEG, C macro file, root file.
- *Save As. . .*: popup a dialog for saving the current canvas drawing in a new filename.
- *Print*: popup a dialog to print the current canvas drawing
- *Quit ROOT*: exit the ROOT session

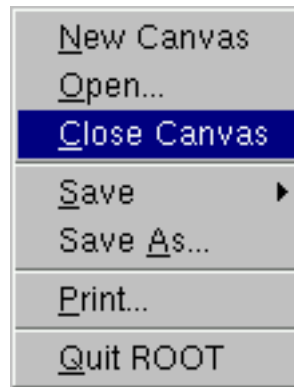

### 2.3.1.2 Edit Menu

There is only one active menu entry in the Edit menu. The others menu entries will be implemented and will become active in the near future.

- *Clear*: delete all objects in the canvas or in the selected pad according to the selected entry in the submenu.

### 2.3.1.3 View Menu

- *Editor*: toggles the view of the editor. If it is selected activates and shows up the editor on the left side of the canvas window. According to the selected object, the editor loads the corresponding user interface for easy change of the object's attributes.
- *Toolbar*: toggles the view of the toolbar. If it is selected activates and shows up the toolbar. It contains buttons for easy and fast access to most frequently used commands and for graphics primitive drawing. Tool tips are provided for helping users.
- *Status Bar*: toggles the view of the status bar. If it is selected, the status bar below the canvas window shows up. There the identification of the objects is displayed when moving the mouse (such as the object's name, the object's type, its coordinates, etc.).
- *Colors*: creates a new canvas showing the color palette.
- *Markers*: creates a new canvas showing the various marker styles.
- *Iconify*: create the canvas window icon, does not close the canvas
- *View With. . .*: If the last selected pad contains a 3-d structure, a new canvas is created with a 3-D picture according to the selection made from the cascaded menu: X3D or OpenGL. The 3-D image can be interactively rotated, zoomed in wire-frame, solid, hidden line or stereo mode.



#### 2.3.1.4 Options Menu

- *Auto Resize Canvas*: turns auto-resize of the canvas *on/off*:
  - *on* - the canvas fits to the window when changing the window size;
  - *off* - the canvas stays fixed when changing the window size.
- *Resize Canvas*: resizes and fits the canvas to the window size.
- *Move Opaque*: if selected, graphics objects are moved in opaque mode; otherwise, only the outline of objects is drawn when moving them. The option opaque produces the best effect but it requires a reasonably fast workstation or response time.
- *Resize Opaque*: if selected, graphics objects are resized in opaque mode; otherwise, only the outline of objects is drawn when resizing them.
- *Interrupt*: interrupts the current drawing process.
- *Refresh*: redraws the canvas contents.
- *Pad Auto Exec*: executes the list of **TExecs** in the current pad.
- *Statistics*: toggles the display of the histogram statistics box.
- *Histogram Title*: toggles the display of the histogram title.
- *Fit Parameters*: toggles the display of the histogram or graph fit parameters.
- *Can Edit Histogram*: enables/disables the possibility to edit histogram bin contents.

#### 2.3.1.5 Inspect Menu

- *ROOT*: inspects the top-level **gROOT** object (in a new canvas).
- *Start Browser*: starts a new object browser (in a separate window).
- *GUI Builder*: starts the GUI builder application (in a separate window).

#### 2.3.1.6 Help Menu

- *Canvas*: help on canvas as a whiteboard area for drawing.
- *Menus*: help on canvas menus.
- *Graphics Editor*: help on primitives' drawing and objects' editor.
- *Browser*: help on the ROOT objects' and files' browser.

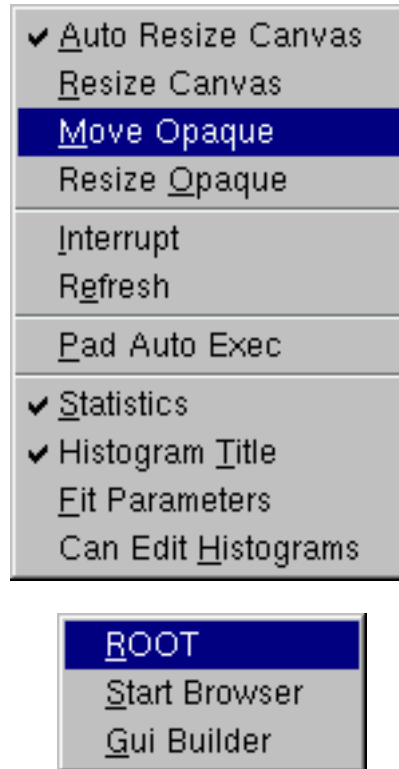

- *Objects*: help on DrawClass, Inspect and Dump context menu items.
- *PostScript*: help on how to print a canvas to a PostScript file format.
- *About ROOT*: pops up the ROOT Logo with the version number.

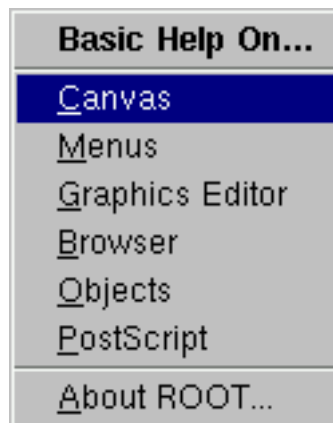

### 2.3.1.7 Classes Menu

- *Classes*: starts the ClassTree viewer that draws inheritance tree for a list of classes.

### 2.3.1.8 Toolbar

The following menu shortcuts and utilities are available from the toolbar:

 Create a new canvas window.

 Popup the Open File dialog.

 Popup the Save As... dialog.

 Popup the Print dialog.

 Interrupts the current drawing process.

 Redraw the canvas.

 Inspect the *gROOT* object.

 Create a new objects' browser.

You can create the following graphical objects using the toolbar buttons for primitive drawing. Tool tips are provided for helping your choice.

 **An Arc or circle:** Click on the center of the arc, and then move the mouse. A rubber band circle is shown. Click again with the left button to freeze the arc.

 **A Line:** Click with the left button at the point where you want to start the line, then move the mouse and click again with the left button to freeze the line.

 **An Arrow:** Click with the left button at the point where you want to start the arrow, then move the mouse and click again with the left button to freeze the arrow.

 **A Diamond:** Click with the left button and freeze again with the left button. The editor draws a rubber band box to suggest the outline of the diamond.

 **An Ellipse:** Proceed like for an arc. You can grow/shrink the ellipse by pointing to the sensitive points. They are highlighted. You can move the ellipse by clicking on the ellipse, but not on the sensitive points. If, with the ellipse context menu, you have selected a fill area color, you can move a filled-ellipse by pointing inside the ellipse and dragging it to its new position.

 **A Pad:** Click with the left button and freeze again with the left button. The editor draws a rubber band box to suggest the outline of the pad.

 **A PaveLabel:** Proceed like for a pad. Type the text of label and finish with a carriage return. The text will appear in the box.

 **A Pave Text:** Proceed like for a pad. You can then click on the **TPaveText** object with the right mouse button and select the option **InsertText**.

 **Paves Text:** Proceed like for a **TPaveText**.

 **A Poly Line:** Click with the left button for the first point, move the mouse, click again with the left button for a new point. Close the poly-line with a double click. To edit one vertex point, pick it with the left button and drag to the new point position.

 **A Curly Line:** Proceed as for the arrow or line. Once done, click with the third button to change the characteristics of the curly line, like transform it to wave, change the wavelength, etc.

 **A Curly Arc:** Proceed like for an ellipse. The first click is located at the position of the center, the second click at the position of the arc beginning. Once done, one obtains a curly ellipse, for which one can click with the third button to change the characteristics, like transform it to wavy, change the wavelength, set the minimum and maximum angle to make an arc that is not closed, etc.

 **A Text/Latex string:** Click with the left button where you want to draw the text and then type in the text terminated by carriage return. All **TLatex** expressions are valid. To move the text or formula, point on it keeping the left mouse button pressed and drag the text to its new position. You can grow/shrink the text if you position the mouse to the

first top-third part of the string, then move the mouse up or down to grow or shrink the text respectively. If you position the mouse near the bottom-end of the text, you can rotate it.

 **A Marker:** Click with the left button where to place the marker. The marker can be modified by using the method `SetMarkerStyle()` of `TSystem`.

 **A Graphical Cut:** Click with the left button on each point of a polygon delimiting the selected area. Close the cut by double clicking on the last point. A `TCutG` object is created. It can be used as a selection for a `TTree::Draw`. You can get a pointer to this object with:

```
TCutG cut = (TCutG*)gPad->GetPrimitive("CUTG")
```

Once you are happy with your picture, you can select the `Save as canvas.C` item in the canvas File menu. This will automatically generate a script with the C++ statements corresponding to the picture. This facility also works if you have other objects not drawn with the graphics editor (histograms for example).

### 2.3.2 The Editor Frame

The ROOT graphics editor loads the corresponding object editor `objEditor` according to the selected object `obj` in the canvas respecting the class inheritance. An object in the canvas is selected after the left mouse click on it. For example, if the selected object is `TAxis`, the `TAxisEditor` will show up in the editor frame giving the possibility for changing different axis attributes. The graphics editor can be:

Embedded - connected only with the canvas in the application window that appears on the left of the canvas window after been activated via View menu / Editor. It appears on the left side of the canvas window allowing users to edit the attributes of the selected object via provided user interface. The name of the selected object is displayed on the top of the editor frame in red color. If the user interface needs more space than the height of the canvas window, a vertical scroll bar appears for easier navigation.

Global - has own application window and can be connected to any created canvas in a ROOT session. It can be activated via the context menu entries for setting line, fill, text and marker attributes for backward compatibility, but there will be a unique entry in the near future.

The user interface for the following classes is available since ROOT v.4.04: `TAttLine`, `TAttFill`, `TAttMarker`, `TAttText`, `TArrow`, `TAxis`, `TCurlyArc`, `TCurlyLine`, `TFrame`, `TH1`, `TH2`, `TGraph`, `TPad`, `TCanvas`, `TPaveStats`. For more details, see “The Graphics Editor”, “The User Interface for Histograms”, “The User Interface for Graphs”.

### 2.3.3 Classes, Methods and Constructors

Object oriented programming introduces objects, which have data members and methods. The next line creates an object named `f1` of the class `TF1` that is a one-dimensional function. The type of an object is called a class. The object itself is called an instance of a class. When a method builds an object, it is called a constructor.

```
TF1 f1("func1","sin(x)/x",0,10)
```

In our constructor the function  $\sin(x)/x$  is defined for use, and 0 and 10 are the limits. The first parameter, `func1` is the name of the object `f1`. Most objects in ROOT have a name. ROOT maintains a list of objects that can be searched to find any object by its given name (in our example `func1`).

The syntax to call an object’s method, or if one prefers, to make an object to do something is:

```
object.method_name(parameters)
```

The dot can be replaced by “->” if `object` is a pointer. In compiled code, the dot MUST be replaced by a “->” if `object` is a pointer.

```
object_ptr->method_name(parameters)
```



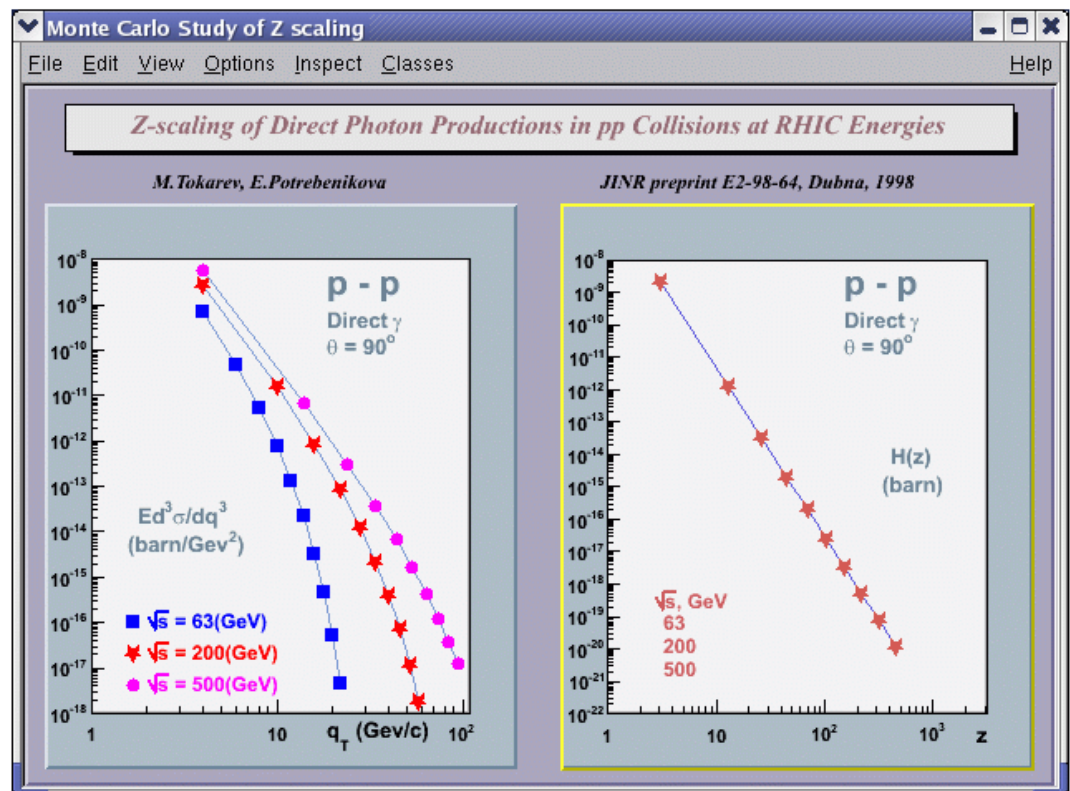
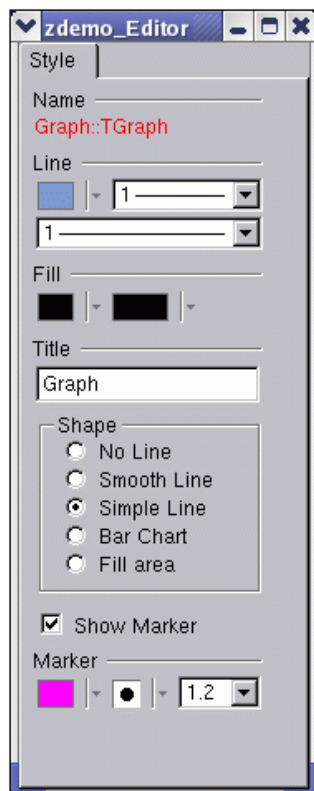
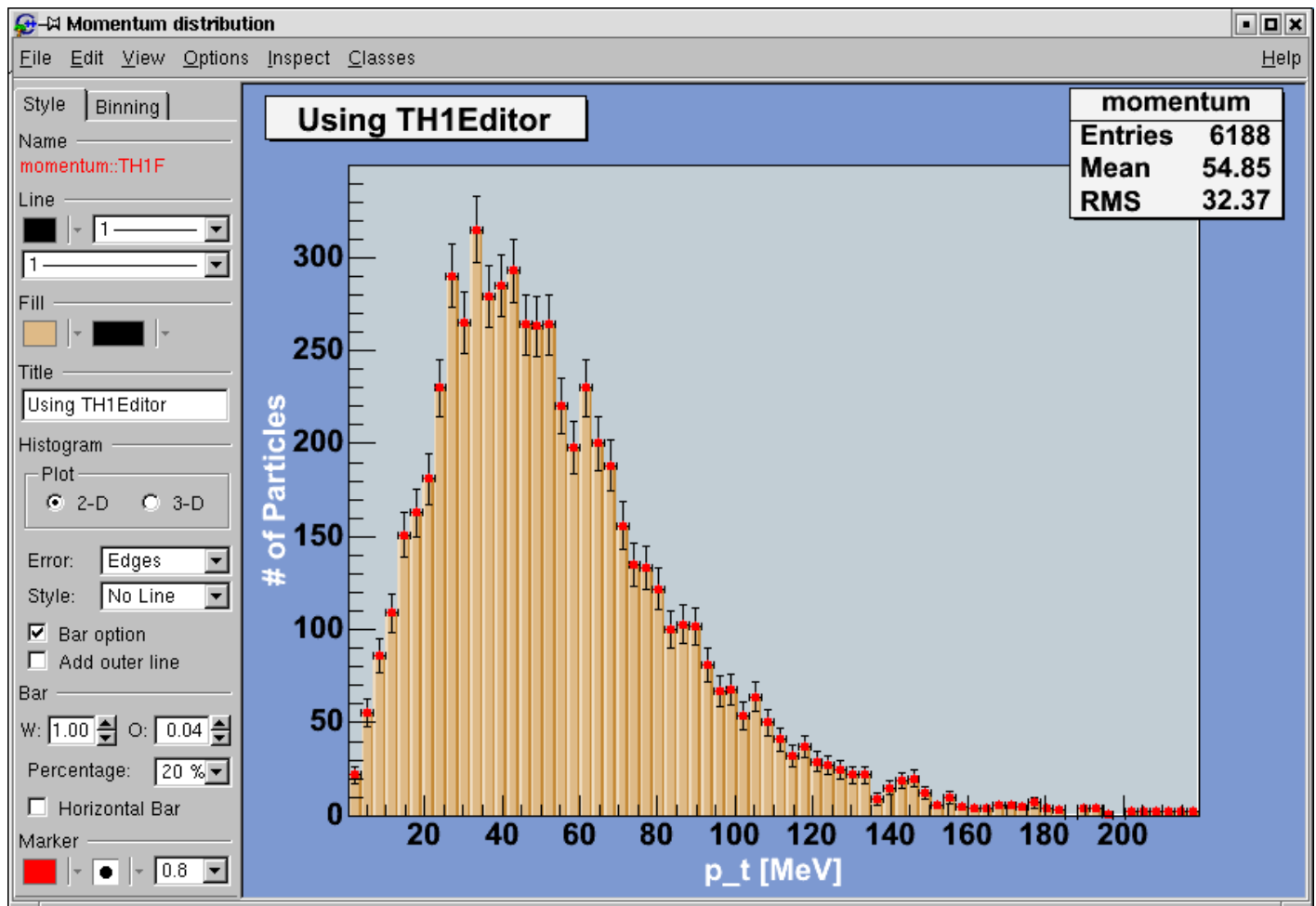



So now, we understand the two lines of code that allowed us to draw our function. `f1.Draw()` stands for “call the method `Draw()` associated with the object `f1` of the class `TF1`”. Other methods can be applied to the object `f1` of the class `TF1`. For example, the evaluating and calculating the derivative and the integral are what one would expect from a function.

```
root [] f1.Eval(3)
(Double_t)4.70400026866224020e-02
root [] f1.Derivative(3)
(Double_t)(-3.45675056671992330e-01)
root [] f1.Integral(0,3)
(Double_t)1.84865252799946810e+00
root [] f1.Draw()
```

By default the method `TF1::Paint()`, that draws the function, computes 100 equidistant points to draw it. The number of points can be set to a higher value with:

```
root [] f1.SetNpx(2000);
```

Note that while the ROOT framework is an object-oriented framework, this does not prevent the user from calling plain functions.

### 2.3.4 User Interaction

Now we will look at some interactive capabilities. Try to draw the function  $\sin(x)/x$  again. Every object in a window (which is called a canvas) is, in fact, a graphical object in the sense that you can grab it, resize it, and change its characteristics with a mouse click. For example, bring the cursor over the x-axis. The cursor changes to a hand with a pointing finger when it is over the axis. Now, left click and drag the mouse along the axis to the right. You have a very simple zoom.

When you move the mouse over any object, you can get access to selected methods by pressing the right mouse button and obtaining a context menu. If you try this on the function `TF1`, you will get a menu showing available methods. The other objects on this canvas are the title, a `TPaveText` object; the x and y-axis, `TAxis` objects, the frame, a `TFrame` object, and the canvas a `TCanvas` object. Try clicking on these and observe the context menu with their methods.

For example try selecting the `SetRange()` method and putting `-10, 10` in the dialog box fields. This is equivalent to executing `f1.SetRange(-10,10)` from the command line, followed by `f1.Draw()`. Here are some other options you can try.

Once the picture suits your wishes, you may want to see the code you should put in a script to obtain the same result. To do that, choose `Save / canvas.C` entry of the File menu. This will generate a script showing the options set in the current canvas. Notice that you can also save the picture into various file formats such as PostScript, GIF, etc. Another interesting possibility is to save your canvas into the native ROOT format (`.rootfile`). This will enable you to open it again and to change whatever you like. All objects associated to the canvas (histograms, graphs) are saved at the same time.

### 2.3.5 Building a Multi-pad Canvas

Let us now try to build a canvas with several pads.

```
root [] TCanvas *MyC = new TCanvas("MyC","Test canvas",1)
root [] MyC->Divide(2,2)
```

Once again, we call the constructor of a class, this time the class `TCanvas`. The difference between this and the previous constructor call (`TF1`) is that here we are creating a pointer to an object. Next, we call the method `Divide()` of the `TCanvas` class (that is `TCanvas::Divide()`), which divides the canvas into four zones and sets up a pad in each of them. We set the first pad as the active one and then draw the function `f1` there.

```
root [] MyC->cd(1)
root [] f1->Draw()
```

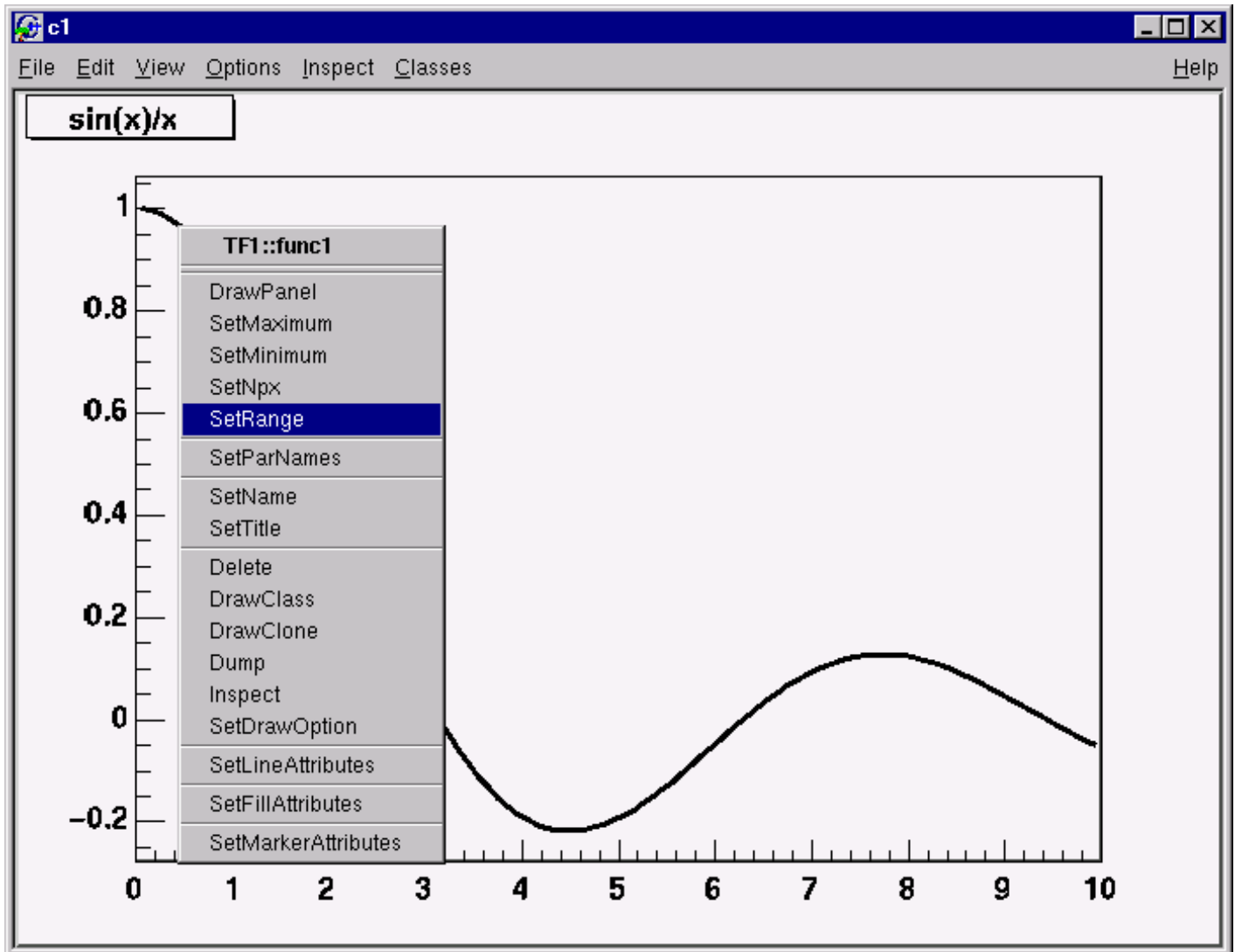

Figure 2.2: A context menu

All objects will be drawn in that pad because it is the active one. The ways for changing the active pad are:

- Click the middle mouse button on a pad will set this pad as the active one.
- Use the method `TCanvas::cd()` with the pad number, as was done in the example above:

```
root [] MyC->cd(3)
```

Pads are numbered from left to right and from top to bottom. Each new pad created by `TCanvas::Divide()` has a name, which is the name of the canvas followed by `_1`, `_2`, etc. To apply the method `cd()` to the third pad, you would write:

```
root [] MyC_3->cd()
```

- Third pad will be selected since you called `TPad::cd()` for the object `MyC_3`. ROOT will find the pad that was named `MyC_3` when you typed it on the command line (see `ROOT/CINT Extensions to C++`).

### 2.3.6 Saving the Canvas

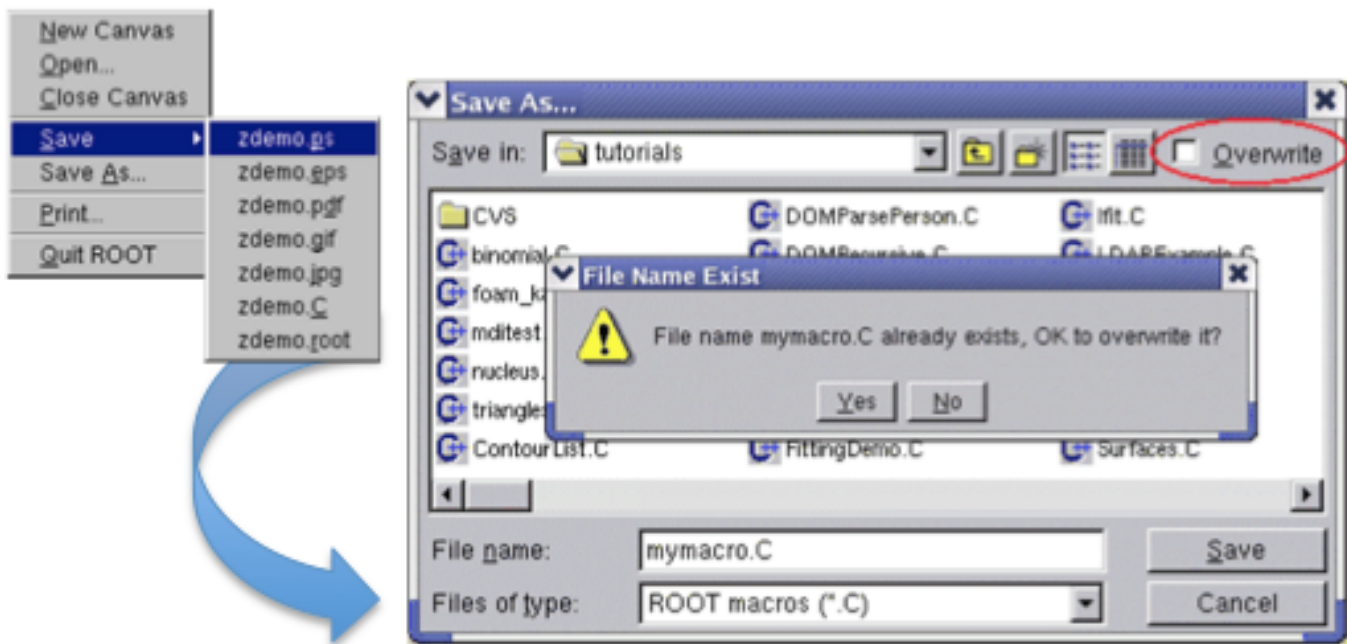

Figure 2.3: The SaveAs... dialog

Using the File menu / Save cascade menu users can save the canvas as one of the files from the list. Please note that saving the canvas this way will overwrite the file with the same name without a warning.

All supported file types can be saved via File menu / SaveAs... This dialog gives a choice to show or suppress the confirmation message for overwriting an existing file.

If the Overwrite check box is not selected, a message dialog appears asking the user to overwrite the file (Yes/No). The user choice is saved for the next time the Save As... dialog shows up.

### 2.3.7 Printing the Canvas

The Print command in the canvas File menu pops-up a print dialog where the user can specify a preferred print command and the printer name.

Both print parameters can be set via the new `Print.Command` and `Print.Printer` rootrc resources as follows:

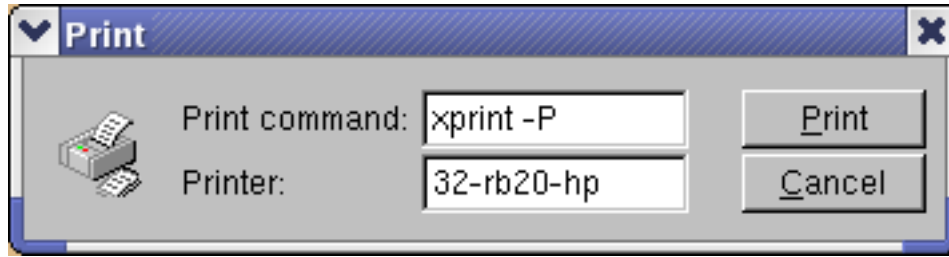

```
# Printer settings.
WinNT.*.Print.Command:   AcroRd32.exe
Unix.*.Print.Command:    xprint -P%p %f
Print.Printer:           32-rb205-hp
Print.Directory:         .
```

If the %p and %f are specified as a part of the print command, they will be replaced by the specified printer name and the file name. All other parameters will be kept as they are written. A print button is available in the canvas toolbar (activated via View menu/Toolbar).

## 2.4 The ROOT Command Line

We have briefly touched on how to use the command line. There are different types of commands.

1. CINT commands start with “.”

```
root[] .? //this command will list all the CINT commands
root[] .L <filename> //load [filename]
root[] .x <filename> //load and execute [filename]
```

2. SHELL commands start with “.!” for example:

```
root[] .! ls
```

3. C++ commands follow C++ syntax (almost)

```
root[] TBrowser *b = new TBrowser()
```

### 2.4.1 Multi-line Commands

You can use the command line to execute multi-line commands. To begin a multi-line command you must type a single left curly bracket {, and to end it you must type a single right curly bracket }. For example:

```
root[] {
end with '}'> Int_t j = 0;
end with '}'> for (Int_t i = 0; i < 3; i++)
end with '}'> {
end with '}'> j= j + i;
end with '}'> cout << "i = " << i << ", j = " << j << endl;
end with '}'> }
end with '}'> }
i = 0, j = 0
i = 1, j = 1
i = 2, j = 3
```

It is more convenient to edit a script than the command line, and if your multi line commands are getting unmanageable, you may want to start with a script instead.

## 2.4.2 CINT Extensions

We should say that some things are not standard C++. The CINT interpreter has several extensions. See “ROOT/CINT Extensions to C++”.

## 2.4.3 Helpful Hints for Command Line Typing

The interpreter knows all the classes, functions, variables, and user defined types. This enables ROOT to help users to complete the command line. For example, if we do not know anything about the **TLine** class, the Tab feature helps us to get a list of all classes starting with **TL**(where <TAB> means type the Tab key).

```
root[] l = new TLi<TAB>
TList
TListIter
TLink
TLine
TLimitDataSource
TLimit
```

To list the different constructors and parameters for **TLine** use the <TAB> key as follows:

```
root[] l = new TLine(<TAB>
TLine TLine()
TLine TLine(Double_t x1,Double_t y1,Double_t x2,Double_t y2)
TLine TLine(const TLine& line)
```

## 2.4.4 Regular Expression

The meta-characters below can be used in a regular expression:

- ‘^’ start-of-line anchor
- ‘\$’ end-of-line anchor
- ‘.’ matches any character
- ‘[’ start a character class
- ‘]’ end a character class
- ‘^’negates character class if first character
- ‘\*’Kleene closure (matches 0 or more)
- ‘+’Positive closure (1 or more)
- ‘?’ Optional closure (0 or 1)

When using wildcards the regular expression is assumed to be preceded by a ‘^’ (BOL) and terminated by ‘\$’ (EOL). All ‘\*’ (closures) are assumed to be preceded by a ‘.’, i.e. any character, except slash `_/`. Its special treatment allows the easy matching of pathnames. For example, `*.root_` will match `_aap.root_`, but not `_pipo/aap.root_`.

The escape characters are:

- \ backslash
- b backspace
- f form feed

- **n** new line
- **r** carriage return
- **s** space
- **t** tab
- **e** ASCII ESC character ('033')
- **DDD** number formed of 1-3 octal digits
- **xDD** number formed of 1-2 hex digits
- **^C C** = any letter. Control code

The class **TRegexp** can be used to create a regular expression from an input string. If **wildcard** is true then the input string contains a wildcard expression.

```
TRegexp(const char *re, Bool_t wildcard)
```

Regular expression and wildcards can be easily used in methods like:

```
Ssiz_t Index(const TString& string, Ssiz_t* len, Ssiz_t i) const
```

The method finds the first occurrence of the regular expression in the **string** and returns its position.

## 2.5 Conventions

In this paragraph, we will explain some of the conventions used in ROOT source and examples.

### 2.5.1 Coding Conventions

From the first days of ROOT development, it was decided to use a set of coding conventions. This allows a consistency throughout the source code. Learning these will help you identify what type of information you are dealing with and enable you to understand the code better and quicker. Of course, you can use whatever convention you want but if you are going to submit some code for inclusion into the ROOT sources, you will need to use these.

These are the coding conventions:

- Classes begin with **T**: **TLine**, **TTree**
- Non-class types end with **\_t**: **Int\_t**
- Data members begin with **f**: **fTree**
- Member functions begin with a capital: **Loop()**
- Constants begin with **k**: **kInitialSize**, **kRed**
- Global variables begin with **g**: **gEnv**
- Static data members begin with **fg**: **fgTokenClient**
- Enumeration types begin with **E**: **EColorLevel**
- Locals and parameters begin with a lower case: **nbytes**
- Getters and setters begin with **Get** and **Set**: **SetLast()**, **GetFirst()**

## 2.5.2 Machine Independent Types

Different machines may have different lengths for the same type. The most famous example is the `int` type. It may be 16 bits on some old machines and 32 bits on some newer ones. To ensure the size of your variables, use these pre defined types in ROOT:

- `Char_t` Signed Character 1 byte
- `UChar_t` Unsigned Character 1 byte
- `Short_t` Signed Short integer 2 bytes
- `UShort_t` Unsigned Short integer 2 bytes
- `Int_t` Signed integer 4 bytes
- `UInt_t` Unsigned integer 4 bytes
- `Long64_t` Portable signed long integer 8 bytes
- `ULong64_t` Portable unsigned long integer 8 bytes
- `Float_t` Float 4 bytes
- `Double_t` Double 8 bytes
- `Double32_t` Double 8 bytes in memory, written as a Float 4 bytes
- `Bool_t` Boolean (0=false, 1=true)

If you do not want to save a variable on disk, you can use `int` or `Int_t`, the result will be the same and the interpreter or the compiler will treat them in exactly the same way.

## 2.5.3 TObject

In ROOT, almost all classes inherit from a common base class called `TObject`. This kind of architecture is also used in the Java language. The `TObject` class provides default behavior and protocol for all objects in the ROOT system. The main advantage of this approach is that it enforces the common behavior of the derived classes and consequently it ensures the consistency of the whole system. See “The Role of TObject”.

`TObject` provides protocol, i.e. (abstract) member functions, for:

- Object I/O (`Read()`, `Write()`)
- Error handling (`Warning()`, `Error()`, `SysError()`, `Fatal()`)
- Sorting (`IsSortable()`, `Compare()`, `IsEqual()`, `Hash()`)
- Inspection (`Dump()`, `Inspect()`)
- Printing (`Print()`)
- Drawing (`Draw()`, `Paint()`, `ExecuteEvent()`)
- Bit handling (`SetBit()`, `TestBit()`)
- Memory allocation (`operatornew` and `delete`, `IsOnHeap()`)
- Access to meta information (`IsA()`, `InheritsFrom()`)
- Object browsing (`Browse()`, `IsFolder()`)

## 2.6 Global Variables

ROOT has a set of global variables that apply to the session. For example, *gDirectory\** *always holds the current directory*, and *gStyle\** holds the current style.

All global variables begin with “g” followed by a capital letter.

### 2.6.1 gROOT

The single instance of **TROOT** is accessible via the global *gROOT* and holds information relative to the current session. By using the *gROOT* pointer, you get the access to every object created in a ROOT program. The **TROOT** object has several lists pointing to the main ROOT objects. During a ROOT session, the *gROOT* keeps a series of collections to manage objects. They can be accessed via *gROOT::GetListOf...* methods.

```
gROOT->GetListOfClasses()
gROOT->GetListOfColors()
gROOT->GetListOfTypes()
gROOT->GetListOfGlobals()
gROOT->GetListOfGlobalFunctions()
gROOT->GetListOfFiles()
gROOT->GetListOfMappedFiles()
gROOT->GetListOfSockets()
gROOT->GetListOfCanvases()
gROOT->GetListOfStyles()
gROOT->GetListOfFunctions()
gROOT->GetListOfSpecials()
gROOT->GetListOfGeometries()
gROOT->GetListOfBrowsers()
gROOT->GetListOfMessageHandlers()
```

These methods return a **TSeqCollection**, meaning a collection of objects, and they can be used to do list operations such as finding an object, or traversing the list and calling a method for each of the members. See the **TCollection** class description for the full set of methods supported for a collection. For example, to find a canvas called *c1* you can do:

```
root [] gROOT->GetListOfCanvases()->FindObject("c1")
```

This returns a pointer to a **TObject**, and before you can use it as a canvas you need to cast it to a **TCanvas\***.

### 2.6.2 gFile

*gFile* is the pointer to the current opened file in the ROOT session.

### 2.6.3 gDirectory

*gDirectory* is a pointer to the current directory. The concept and role of a directory is explained in the chapter “Input/Output”.

### 2.6.4 gPad

A graphic object is always drawn on the active pad. It is convenient to access the active pad, no matter what it is. For that, we have *gPad* that is always pointing to the active pad. For example, if you want to change the fill color of the active pad to blue, but you do not know its name, you can use *gPad*.

```
root [] gPad->SetFillColor(38)
```

To get the list of colors, if you have an open canvas, click in the “View” menu, selecting the “Colors” entry.



### 2.6.5 gRandom

**gRandom** is a pointer to the current random number generator. By default, it points to a **TRandom3** object, based on the “Mersenne-Twister” generator. This generator is very fast and has very good random proprieties (a very long period of  $10^{600}$ ). Setting the seed to 0 implies that the seed will be uniquely generated using the **TUUID**. Any other value will be used as a constant. The following basic random distributions are provided: **Rndm()** or **Uniform(min,max)**, **Gaus(mean,sigma)**, **Exp(tau)**, **BreitWigner(mean,sigma)**, **Landau(mean,sigma)**, **Poisson(mean)**, **Binomial(ntot,prob)**. You can customize your ROOT session by replacing the random number generator. You can delete **gRandom** and recreate it with your own. For example:

```
root[] delete gRandom;
root[] gRandom = new TRandom2(0); //seed=0
```

**TRandom2** is another generator, which is also very fast and uses only three words for its state.

### 2.6.6 gEnv

**gEnv** is the global variable (of type **TEnv**) with all the environment settings for the current session. This variable is set by reading the contents of a **.rootrc** file (or **\$ROOTSYS/etc/system.rootrc**) at the beginning of the root session. See Environment Setup below for more information.

## 2.7 Environment Setup

The behavior of a ROOT session can be tailored with the options in the **.rootrc** file. At start-up, ROOT looks for a **.rootrc** file in the following order:

- *./rootrc //local directory*
- *\$HOME/.rootrc //user directory*
- *\$ROOTSYS/etc/system.rootrc //global ROOT directory*

If more than one **.rootrc** files are found in the search paths above, the options are merged, with precedence local, user, global. While in a session, to see current settings, you can do:

```
root[] gEnv->Print()
```

The **rootrc** file typically looks like:

```
# Path used by dynamic loader to find shared libraries
Unix.*.Root.DynamicPath:  ~/.rootlibs:$(ROOTSYS)/lib
Unix.*.Root.MacroPath:    ~/.rootmacros:$(ROOTSYS)/macros

# Path where to look for TrueType fonts
Unix.*.Root.UseTTFonts:   true
Unix.*.Root.TTFontPath:
...
# Activate memory statistics
Rint.Root.MemStat:        1
Rint.Load:                 rootalias.C
Rint.Logon:                rootlogon.C
Rint.Logoff:               rootlogoff.C
...
Rint.Canvas.MoveOpaque:   false
Rint.Canvas.HighLightColor: 5
```

The various options are explained in `$ROOTSYS/etc/system.rootrc`. The `.rootrc` file contents are combined. For example, if the flag to use true type fonts is set to true in the `system.rootrc` file, you have to set explicitly it false in your local `.rootrc` file if you do not want to use true type fonts. Removing the `UseTTFonts` statement in the local `.rootrc` file will not disable true fonts. The value of the environment variable `ROOTDEBUG` overrides the value in the `.rootrc` file at startup. Its value is used to set `gDebug` and helps for quick turn on debug mode in `TROOT` startup.

`ROOT` looks for scripts in the path specified in the `.rootrc` file in the `Root.Macro.Path` variable. You can expand this path to hold your own directories.

### 2.7.1 Logon and Logoff Scripts

The `rootlogon.C` and `rootlogoff.C` files are scripts loaded and executed at start-up and shutdown. The `rootalias.C` file is loaded but not executed. It typically contains small utility functions. For example, the `rootalias.C` script that comes with the `ROOT` distributions (located in `$ROOTSYS/tutorials`) defines the function `edit(char *file)`. This allows the user to call the editor from the command line. This particular function will start the VI editor if the environment variable `EDITOR` is not set.

```
root[0] edit("c1.C")
```

For more details, see `$ROOTSYS/tutorials/rootalias.C`.

### 2.7.2 History File

You can use the up and down arrow at the command line, to access the previous and next command. The commands are recorded in the history file `$HOME/.root_hist`. It is a text file, and you can edit, cut, and paste from it. You can specify the history file in the `system.rootrc` file, by setting the `Rint.History` option. You can also turn off the command logging in the `system.rootrc` file with the option: `Rint.History: -`

The number of history lines to be kept can be set also in `.rootrc` by:

```
Rint.HistSize:      500
Rint.HistSave:     400
```

The first value defines the maximum of lines kept; once it is reached all, the last `HistSave` lines will be removed. One can set `HistSize` to 0 to disable history line management. There is also implemented an environment variable called `ROOT_HIST`. By setting `ROOT_HIST=300:200` the above values can be overridden - the first value corresponds to `HistSize`, the (optional) second one to `HistSave`. You can set `ROOT_HIST=0` to disable the history.

### 2.7.3 Tracking Memory Leaks

You can track memory usage and detect leaks by monitoring the number of objects that are created and deleted (see `TObjectTable`). To use this facility, edit the file `$ROOTSYS/etc/system.rootrc` or `.rootrc` if you have this file and add the two following lines:

```
Root.MemStat:      1
Root.ObjectStat:   1
```

In your code or on the command line you can type the line:

```
gObjectTable->Print();
```

This line will print the list of all active classes and the number of instances for each class. By comparing consecutive print outs, you can see objects that you forgot to delete. Note that this method cannot show leaks coming from the allocation of non-objects or classes unknown to `ROOT`.

### 2.7.4 Memory Checker

A memory checking system was developed by D.Bertini and M.Ivanov and added in ROOT version 3.02.07. To activate the memory checker you can set the resource `Root.MemCheck` to 1 (e.g.: `Root.MemCheck: 1` in the `.rootrc` file). You also have to link with `libNew.so` (e.g. use `root-config --new --libs`) or to use `rootn.exe`. When these settings are in place, you will find a file “`memcheck.out`” in the directory where you started your ROOT program after the completion of the program execution. You can also set the resource `Root.MemCheckFile` to the name of a file. The memory information will be written to that file. The contents of this `memcheck.out` can be analyzed and transformed into printable text via the `memprobe` program (in `$ROOTSYS/bin`).

## 2.8 Converting from PAW to ROOT

The web page at: <http://root.cern.ch/root/HowtoConvertFromPAW.html#TABLE> gives the “translation” table of some commonly used PAW commands into ROOT. If you move the mouse cursor over the picture at: <http://root.cern.ch/root/HowtoConvertFromPAW.html#SET>, you will get the corresponding ROOT commands as tooltips.

### 2.8.1 Converting HBOOK/PAW Files

ROOT has a utility called `h2root` that you can use to convert your HBOOK/PAW histograms or ntuple files into ROOT files. To use this program, you type the shell script command:

```
h2root <hbookfile> <rootfile>
```

If you do not specify the second parameter, a file name is automatically generated for you. If `hbookfile` is of the form `file.hbook`, then the ROOT file will be called `file.root`. This utility converts HBOOK histograms into ROOT histograms of the class `TH1F`. HBOOK profile histograms are converted into ROOT profile histograms (see class `TProfile`). HBOOK row-wise and column-wise ntuples are automatically converted to ROOT Trees. See “Trees”. Some HBOOK column-wise ntuples may not be fully converted if the columns are an array of fixed dimension (e.g. `var[6]`) or if they are a multi-dimensional array.

HBOOK integer identifiers are converted into ROOT named objects by prefixing the integer identifier with the letter “h” if the identifier is a positive integer and by “h\_” if it is a negative integer identifier. In case of row-wise or column-wise ntuples, each column is converted to a branch of a tree. Note that `h2root` is able to convert HBOOK files containing several levels of sub-directories. Once you have converted your file, you can look at it and draw histograms or process ntuples using the ROOT command line. An example of session is shown below:

```
// this connects the file hbookconverted.root
root[] TFile f("hbookconverted.root");

// display histogram named h10 (was HBOOK id 10)
root[] h10.Draw();

// display column "var" from ntuple h30
root[] h30.Draw("var");
```

You can also use the ROOT browser (see `TBrowser`) to inspect this file.

The chapter on trees explains how to read a tree. ROOT includes a function `TTree::MakeClass` to generate automatically the code for a skeleton analysis function. See “Example Analysis”.

In case one of the ntuple columns has a variable length (e.g. `px(ntrack)`), `h.Draw("px")` will histogram the `px` column for all tracks in the same histogram. Use the script quoted above to generate the skeleton function and create/fill the relevant histogram yourself.



## Chapter 3

# Histograms

This chapter covers the functionality of the histogram classes. We begin with an overview of the histogram classes, after which we provide instructions and examples on the histogram features.

We have put this chapter ahead of the graphics chapter so that you can begin working with histograms as soon as possible. Some of the examples have graphics commands that may look unfamiliar to you. These are covered in the chapter “Input/Output”.

### 3.1 The Histogram Classes

ROOT supports histograms up to three dimensions. Separate concrete classes are provided for one-dimensional, two-dimensional and three-dimensional classes. The histogram classes are split into further categories, depending on the set of possible bin values:

- **TH1C**, **TH2C** and **TH3C** contain one byte per bin (maximum bin content = 255)
- **TH1S**, **TH2S** and **TH3S** contain one short per bin (maximum bin content = 65 535).
- **TH1I**, **TH2I** and **TH3I** contain one integer per bin (maximum bin content = 2 147 483 647).
- **TH1F**, **TH2F** and **TH3F** contain one float per bin (maximum precision = 7 digits).
- **TH1D**, **TH2D** and **TH3D** contain one double per bin (maximum precision = 14 digits).

ROOT also supports profile histograms, which constitute an elegant replacement of two-dimensional histograms in many cases. The inter-relation of two measured quantities X and Y can always be visualized with a two-dimensional histogram or scatter-plot. Profile histograms, on the other hand, are used to display the mean value of Y and its RMS for each bin in X. If Y is an unknown but single-valued approximate function of X, it will have greater precision in a profile histogram than in a scatter plot.

- **TProfile** : one dimensional profiles
- **TProfile2D** : two dimensional profiles

All ROOT histogram classes are derived from the base class **TH1** (see figure above). This means that two-dimensional and three-dimensional histograms are seen as a type of a one-dimensional histogram, in the same way in which multidimensional C arrays are just an abstraction of a one-dimensional contiguous block of memory.

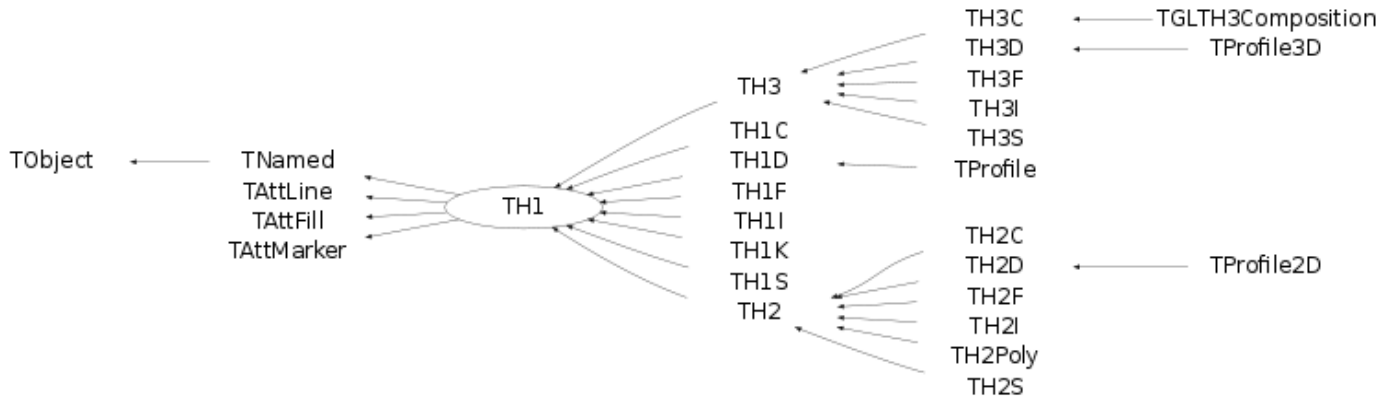

Figure 3.1: The class hierarchy of histogram classes

## 3.2 Creating Histograms

There are several ways in which you can create a histogram object in ROOT. The straightforward method is to use one of the several constructors provided for each concrete class in the histogram hierarchy. For more details on the constructor parameters, see the subsection “Constant or Variable Bin Width” below. Histograms may also be created by:

- Calling the Clone() method of an existing histogram
- Making a projection from a 2-D or 3-D histogram
- Reading a histogram from a file (see Input/Output chapter)

```

// using various constructors
TH1* h1 = new TH1I("h1", "h1 title", 100, 0.0, 4.0);
TH2* h2 = new TH2F("h2", "h2 title", 40, 0.0, 2.0, 30, -1.5, 3.5);
TH3* h3 = new TH3D("h3", "h3 title", 80, 0.0, 1.0, 100, -2.0, 2.0,
                  50, 0.0, 3.0);

// cloning a histogram
TH1* hc = (TH1*)h1->Clone();

// projecting histograms
// the projections always contain double values !
TH1* hx = h2->ProjectionX(); // ! TH1D, not TH1F
TH1* hy = h2->ProjectionY(); // ! TH1D, not TH1F
  
```

### 3.2.1 Constant or Variable Bin Width

The histogram classes provide a variety of ways to construct a histogram, but the most common way is to provide the name and title of histogram and for each dimension: the number of bins, the minimum x (lower edge of the first bin) and the maximum x (upper edge of the last bin).

```

TH2* h = new TH2D(
    /* name */ "h2",
    /* title */ "Hist with constant bin width",
    /* X-dimension */ 100, 0.0, 4.0,
    /* Y-dimension */ 200, -3.0, 1.5);
  
```

When employing this constructor, you will create a histogram with constant (fixed) bin width on each axis. For the example above, the interval  $[0.0, 4.0]$  is divided into 100 bins of the same width  $w_X = 4.0 - 0.0 / 100 = 0.04$  for the X axis (dimension). Likewise, for the Y axis (dimension), we have bins of equal width  $w_Y = 1.5 - (-3.0) / 200 = 0.0225$ .

If you want to create histograms with variable bin widths, ROOT provides another constructor suited for this purpose. Instead of passing the data interval and the number of bins, you have to pass an array (single or double precision) of bin edges. When the histogram has  $n$  bins, then there are  $n+1$  distinct edges, so the array you pass must be of size  $n+1$ .

```
const Int_t NBINS = 5;
Double_t edges[NBINS + 1] = {0.0, 0.2, 0.3, 0.6, 0.8, 1.0};
// Bin 1 corresponds to range [0.0, 0.2]
// Bin 2 corresponds to range [0.2, 0.3] etc...

TH1* h = new TH1D(
    /* name */ "h1",
    /* title */ "Hist with variable bin width",
    /* number of bins */ NBINS,
    /* edge array */ edges
);
```

Each histogram object contains three **TAxis** objects: **fXaxis**, **fYaxis**, and **fZaxis**, but for one-dimensional histograms only the X-axis is relevant, while for two-dimensional histograms the X-axis and Y-axis are relevant. See the class **TAxis** for a description of all the access methods. The bin edges are always stored internally in double precision.

You can examine the actual edges / limits of the histogram bins by accessing the axis parameters, like in the example below:

```
const Int_t XBINS = 5; const Int_t YBINS = 5;
Double_t xEdges[XBINS + 1] = {0.0, 0.2, 0.3, 0.6, 0.8, 1.0};
Double_t yEdges[YBINS + 1] = {-1.0, -0.4, -0.2, 0.5, 0.7, 1.0};

TH2* h = new TH2D("h2", "h2", XBINS, xEdges, YBINS, yEdges);
TAxis* xAxis = h->GetXaxis(); TAxis* yAxis = h->GetYaxis();

cout << "Third bin on Y-dimension: " << endl; // corresponds to
// [-0.2, 0.5]
cout << "\tLower edge: " << yAxis->GetBinLowEdge(3) << endl;
cout << "\tCenter: " << yAxis->GetBinCenter(3) << endl;
cout << "\tUpper edge: " << yAxis->GetBinUpEdge(3) << endl;
```

## 3.3 Bin Numbering

All histogram types support fixed or variable bin sizes. 2-D histograms may have fixed size bins along X and variable size bins along Y or vice-versa. The functions to fill, manipulate, draw, or access histograms are identical in both cases.

### 3.3.1 Convention

For all histogram types: **nbins**, **xlow**, **xup**

Bin# 0 contains the underflow.

Bin# 1 contains the first bin with low-edge (**xlow** INCLUDED).

The second to last bin (bin# **nbins**) contains the upper-edge (**xup** EXCLUDED).

The Last bin (bin# **nbins+1**) contains the overflow.

In case of 2-D or 3-D histograms, a “global bin” number is defined. For example, assuming a 3-D histogram **h** with **binx**, **biny**, **binz**, the function returns a global/linear bin number.

```
Int_t bin = h->GetBin(binx, biny, binz);
```

This global bin is useful to access the bin information independently of the dimension.

### 3.3.2 Re-binning

At any time, a histogram can be re-binned via the `TH1::Rebin()` method. It returns a new histogram with the re-binned contents. If bin errors were stored, they are recomputed during the re-binning.

## 3.4 Filling Histograms

A histogram is typically filled with statements like:

```
h1->Fill(x);
h1->Fill(x,w); // with weight
h2->Fill(x,y);
h2->Fill(x,y,w);
h3->Fill(x,y,z);
h3->Fill(x,y,z,w);
```

The `Fill` method computes the bin number corresponding to the given `x`, `y` or `z` argument and increments this bin by the given weight. The `Fill()` method returns the bin number for 1-D histograms or global bin number for 2-D and 3-D histograms. If `TH1::Sumw2()` has been called before filling, the sum of squares is also stored. One can increment a bin number directly by calling `TH1::AddBinContent()`, replace the existing content via `TH1::SetBinContent()`, and access the bin content of a given bin via `TH1::GetBinContent()`.

```
Double_t binContent = h->GetBinContent(bin);
```

### 3.4.1 Automatic Re-binning Option

By default, the number of bins is computed using the range of the axis. You can change this to re-bin automatically by setting the automatic re-binning option:

```
h->SetBit(TH1::kCanRebin);
```

Once this is set, the `Fill()` method will automatically extend the axis range to accommodate the new value specified in the `Fill()` argument. The used method is to double the bin size until the new value fits in the range, merging bins two by two. The `TTree::Draw()` method extensively uses this automatic binning option when drawing histograms of variables in `TTree` with an unknown range. The automatic binning option is supported for 1-D, 2-D and 3-D histograms. During filling, some statistics parameters are incremented to compute the mean value and root mean square with the maximum precision. In case of histograms of type `TH1C`, `TH1S`, `TH2C`, `TH2S`, `TH3C`, `TH3S` a check is made that the bin contents do not exceed the maximum positive capacity (127 or 65 535). Histograms of all types may have positive or/and negative bin contents.

## 3.5 Random Numbers and Histograms

`TH1::FillRandom()` can be used to randomly fill a histogram using the contents of an existing `TF1` function or another `TH1` histogram (for all dimensions). For example, the following two statements create and fill a histogram 10 000 times with a default Gaussian distribution of `mean 0` and `sigma 1`:

```
root[] TH1F h1("h1", "Histo from a Gaussian", 100, -3, 3);
root[] h1.FillRandom("gaus", 10000);
```

`TH1::GetRandom()` can be used to get a random number distributed according the contents of a histogram. To fill a histogram following the distribution in an existing histogram you can use the second signature of `TH1::FillRandom()`. Next code snippet assumes that `h` is an existing histogram (`TH1`).

```
root[] TH1F h2("h2", "Histo from existing histo", 100, -3, 3);
root[] h2.FillRandom(&h1, 1000);
```



The distribution contained in the histogram `h1` (`TH1`) is integrated over the channel contents. It is normalized to one. The second parameter (1000) indicates how many random numbers are generated.

Getting 1 random number implies:

- Generating a random number between 0 and 1 (say `r1`)
- Find the bin in the normalized integral for `r1`
- Fill histogram channel

You can see below an example of the `TH1::GetRandom()` method which can be used to get a random number distributed according the contents of a histogram.

```
void getrandomh() {
    TH1F *source = new TH1F("source", "source hist", 100, -3, 3);
    source->FillRandom("gaus", 1000);
    TH1F *final = new TH1F("final", "final hist", 100, -3, 3);

        // continued...

    for (Int_t i=0; i<10000; i++) {
        final->Fill(source->GetRandom());
    }
    TCanvas *c1 = new TCanvas("c1", "c1", 800, 1000);
    c1->Divide(1, 2);
    c1->cd(1);
    source->Draw();
    c1->cd(2);
    final->Draw();
    c1->cd();
}
}
```

## 3.6 Adding, Dividing, and Multiplying

Many types of operations are supported on histograms or between histograms:

- Addition of a histogram to the current histogram
- Additions of two histograms with coefficients and storage into the current histogram
- Multiplications and divisions are supported in the same way as additions.
- The `Add`, `Divide` and `Multiply` methods also exist to add, divide or multiply a histogram by a function.

Histograms objects (not pointers) `TH1F h1` can be multiplied by a constant using:

```
h1.Scale(const)
```

A new histogram can be created without changing the original one by doing:

```
TH1F h3 = 8*h1;
```

To multiply two histogram objects and put the result in a 3rd one do:

```
TH1F h3 = h1*h2;
```

The same operations can be done with histogram pointers **TH1F \*h1, \*h2** following way:

```
h1->Scale(const) TH1F h3 = 8*(h1); TH1F h3 = (h1)*(h2);
```

Of course, the **TH1** methods **Add**, **Multiply** and **Divide** can be used instead of these operators.

If a histogram has associated error bars (**TH1::Sumw2()** has been called), the resulting error bars are also computed assuming independent histograms. In case of divisions, binomial errors are also supported.

## 3.7 Projections

One can make:

- a 1-D projection of a 2-D histogram or profile. See **TH2::ProfileX**, **TH2::ProfileY**, **TProfile::ProjectionX**, **TProfile2D::ProjectionXY**, **TH2::ProjectionX**, **TH2::ProjectionY**.
- a 1-D, 2-D or profile out of a 3-D histogram see **TH3::ProjectionZ**, **TH3::Project3D**.

These projections can be fit via: **TH2::FitSlicesX**, **TH2::FitSlicesY**, **TH3::FitSlicesZ**.

## 3.8 Drawing Histograms

When you call the **Draw** method of a histogram (**TH1::Draw**) for the first time, it creates a **THistPainter** object and saves a pointer to painter as a data member of the histogram. The **THistPainter** class specializes in the drawing of histograms. It allows logarithmic axes (x, y, z) when the **CONT** drawing option is using. The **THistPainter** class is separated from the histogram so that one can have histograms without the graphics overhead, for example in a batch program. The choice to give each histogram has its own painter rather than a central singleton painter, allows two histograms to be drawn in two threads without overwriting the painter's values. When a displayed histogram is filled again, you do not have to call the **Draw** method again. The image is refreshed the next time the pad is updated. A pad is updated after one of these three actions:

- A carriage control on the **ROOT** command line
- A click inside the pad
- A call to **TPad::Update()**

By default, the **TH1::Draw** clears the pad before drawing the new image of the histogram. You can use the **"SAME"** option to leave the previous display in tact and superimpose the new histogram. The same histogram can be drawn with different graphics options in different pads. When a displayed histogram is deleted, its image is automatically removed from the pad. To create a copy of the histogram when drawing it, you can use **TH1::DrawClone()**. This will clone the histogram and allow you to change and delete the original one without affecting the clone. You can use **TH1::DrawNormalized()** to draw a normalized copy of a histogram.

```
TH1 *TH1::DrawNormalized(Option_t *option, Double_t norm) const
```

A clone of this histogram is normalized to **norm** and drawn with **option**. A pointer to the normalized histogram is returned. The contents of the histogram copy are scaled such that the new sum of weights (excluding under and overflow) is equal to **norm**.

Note that the returned normalized histogram is not added to the list of histograms in the current directory in memory. It is the user's responsibility to delete this histogram. The **kCanDelete** bit is set for the returned object. If a pad containing this copy is cleared, the histogram will be automatically deleted. See "Draw Options" for the list of options.

### 3.8.1 Setting the Style

Histograms use the current style `gStyle`, which is the global object of class `TStyle`. To change the current style for histograms, the `TStyle` class provides a multitude of methods ranging from setting the fill color to the axis tick marks. Here are a few examples:

```
void SetHistFillColor(Color_t color = 1)
void SetHistFillStyle(Style_t styl = 0)
void SetHistLineColor(Color_t color = 1)
void SetHistLineStyle(Style_t styl = 0)
void SetHistLineWidth(Width_t width = 1)
```

When you change the current style and would like to propagate the change to a previously created histogram you can call `TH1::UseCurrentStyle()`. You will need to call `UseCurrentStyle()` on each histogram. When reading many histograms from a file and you wish to update them to the current style, you can use `gROOT::ForceStyle` and all histograms read after this call will be updated to use the current style. See “Graphics and the Graphical User Interface”. When a histogram is automatically created as a result of a `TTree::Draw`, the style of the histogram is inherited from the tree attributes and the current style is ignored. The tree attributes are the ones set in the current `TStyle` at the time the tree was created. You can change the existing tree to use the current style, by calling `TTree::UseCurrentStyle()`.

### 3.8.2 Draw Options

The following draw options are supported on all histogram classes:

- “AXIS”: Draw only the axis.
- “HIST”: When a histogram has errors, it is visualized by default with error bars. To visualize it without errors use HIST together with the required option (e.g. “HIST SAME C”).
- “SAME”: Superimpose on previous picture in the same pad.
- “CYL”: Use cylindrical coordinates.
- “POL”: Use polar coordinates.
- “SPH”: Use spherical coordinates.
- “PSR”: Use pseudo-rapidity/phi coordinates.
- “LEGO”: Draw a lego plot with hidden line removal.
- “LEGO1”: Draw a lego plot with hidden surface removal.
- “LEGO2”: Draw a lego plot using colors to show the cell contents.
- “SURF”: Draw a surface plot with hidden line removal.
- “SURF1”: Draw a surface plot with hidden surface removal.
- “SURF2”: Draw a surface plot using colors to show the cell contents.
- “SURF3”: Same as SURF with a contour view on the top.
- “SURF4”: Draw a surface plot using Gouraud shading.
- “SURF5”: Same as SURF3 but only the colored contour is drawn. Used with option CYL, SPH or PSR it allows to draw colored contours on a sphere, a cylinder or in a pseudo rapidly space. In Cartesian or polar coordinates, option SURF3 is used.

The following options are supported for 1-D histogram classes:

- “AH”: Draw the histogram, but not the axis labels and tick marks

- “B”: Draw a bar chart
- “C”: Draw a smooth curve through the histogram bins
- “E”: Draw the error bars
- “E0”: Draw the error bars including bins with 0 contents
- “E1”: Draw the error bars with perpendicular lines at the edges
- “E2”: Draw the error bars with rectangles
- “E3”: Draw a fill area through the end points of the vertical error bars
- “E4”: Draw a smoothed filled area through the end points of the error bars
- “L”: Draw a line through the bin contents
- “P”: Draw a (poly)marker at each bin using the histogram’s current marker style
- “P0”: Draw current marker at each bin including empty bins
- “PIE”: Draw a Pie Chart
- “\*H”: Draw histogram with a \* at each bin
- “LF2”: Draw histogram as with option “L” but with a fill area. Note that “L” also draws a fill area if the histogram fill color is set but the fill area corresponds to the histogram contour.
- “9”: Force histogram to be drawn in high resolution mode. By default, the histogram is drawn in low resolution in case the number of bins is greater than the number of pixels in the current pad
- “[ ]”: Draw histogram without the vertical lines for the first and the last bin. Use it when superposing many histograms on the same picture.

The following options are supported for 2-D histogram classes:

- “ARR”: Arrow mode. Shows gradient between adjacent cells
- “BOX”: Draw a box for each cell with surface proportional to contents
- “BOX1”: A sunken button is drawn for negative values, a raised one for positive values
- “COL”: Draw a box for each cell with a color scale varying with contents
- “COLZ”: Same as “COL” with a drawn color palette
- “CONT”: Draw a contour plot (same as `CONT0` )
- “CONTZ”: Same as “CONT” with a drawn color palette
- “CONT0”: Draw a contour plot using surface colors to distinguish contours
- “CONT1”: Draw a contour plot using line styles to distinguish contours
- “CONT2”: Draw a contour plot using the same line style for all contours
- “CONT3”: Draw a contour plot using fill area colors
- “CONT4”: Draw a contour plot using surface colors (`SURF2` option at  $\theta = 0$ )
- “CONT5”: Use Delaunay triangles to compute the contours
- “LIST”: Generate a list of `TGraph` objects for each contour
- “FB”: To be used with `LEGO` or `SURFACE` , suppress the Front-Box
- “BB”: To be used with `LEGO` or `SURFACE` , suppress the Back-Box
- “A”: To be used with `LEGO` or `SURFACE` , suppress the axis

- “SCAT”: Draw a scatter-plot (default)
- “SPEC”: Use `TSpectrum2Painter` tool for drawing
- “TEXT”: Draw bin contents as text (format set via `gStyle->SetPaintTextFormat`) .
- “TEXTnn”: Draw bin contents as text at angle `nn` (  $0 < nn < 90$  ).
- “[cutg]”: Draw only the sub-range selected by the `TCutG` name “cutg”.
- “Z”: The “Z” option can be specified with the options: BOX, COL, CONT, SURF, and LEGO to display the color palette with an axis indicating the value of the corresponding color on the right side of the picture.

The following options are supported for 3-D histogram classes:

- " " : Draw a 3D scatter plot.
- “BOX”: Draw a box for each cell with volume proportional to contents
- “LEGO”: Same as “BOX”
- “ISO”: Draw an iso surface
- “FB”: Suppress the Front-Box
- “BB”: Suppress the Back-Box
- “A”: Suppress the axis

Most options can be concatenated without spaces or commas, for example, if `h` is a histogram pointer:

```
h->Draw("E1SAME");
h->Draw("e1same");
```

The options are not case sensitive. The options BOX , COL and COLZ use the color palette defined in the current style (see `TStyle::SetPalette`). The options CONT , SURF , and LEGO have by default 20 equidistant contour levels, you can change the number of levels with `TH1::SetContour`. You can also set the default drawing option with `TH1::SetOption` . To see the current option use `TH1::GetOption` . For example:

```
h->SetOption("lego");
h->Draw(); // will use the lego option
h->Draw("scat") // will use the scatter plot option
```

### 3.8.2.1 The SCATter Plot Option

By default, 2D histograms are drawn as scatter plots. For each cell (`i,j`) a number of points proportional to the cell content are drawn. A maximum of 500 points per cell are drawn. If the maximum is above 500 contents are normalized to 500.

### 3.8.2.2 The ARRow Option

The ARR option shows the gradient between adjacent cells. For each cell (`i,j`) an arrow is drawn. The orientation of the arrow follows the cell gradient.

### 3.8.2.3 The BOX Option

For each cell (`i,j`) a box is drawn with surface proportional to contents. The size of the box is proportional to the absolute value of the cell contents. The cells with negative contents are drawn with an X on top of the boxes. With option BOX1 a button is drawn for each cell with surface proportional to contents' absolute value. A sunken button is drawn for negative values, a raised one for positive values.

### 3.8.2.4 The ERRor Bars Options

- "E" Default. Draw only error bars, without markers
- "E0" Draw also bins with 0 contents (turn off the symbols clipping).
- "E1" Draw small lines at the end of error bars
- "E2" Draw error rectangles
- "E3" Draw a fill area through the end points of vertical error bars
- "E4" Draw a smoothed filled area through the end points of error bars

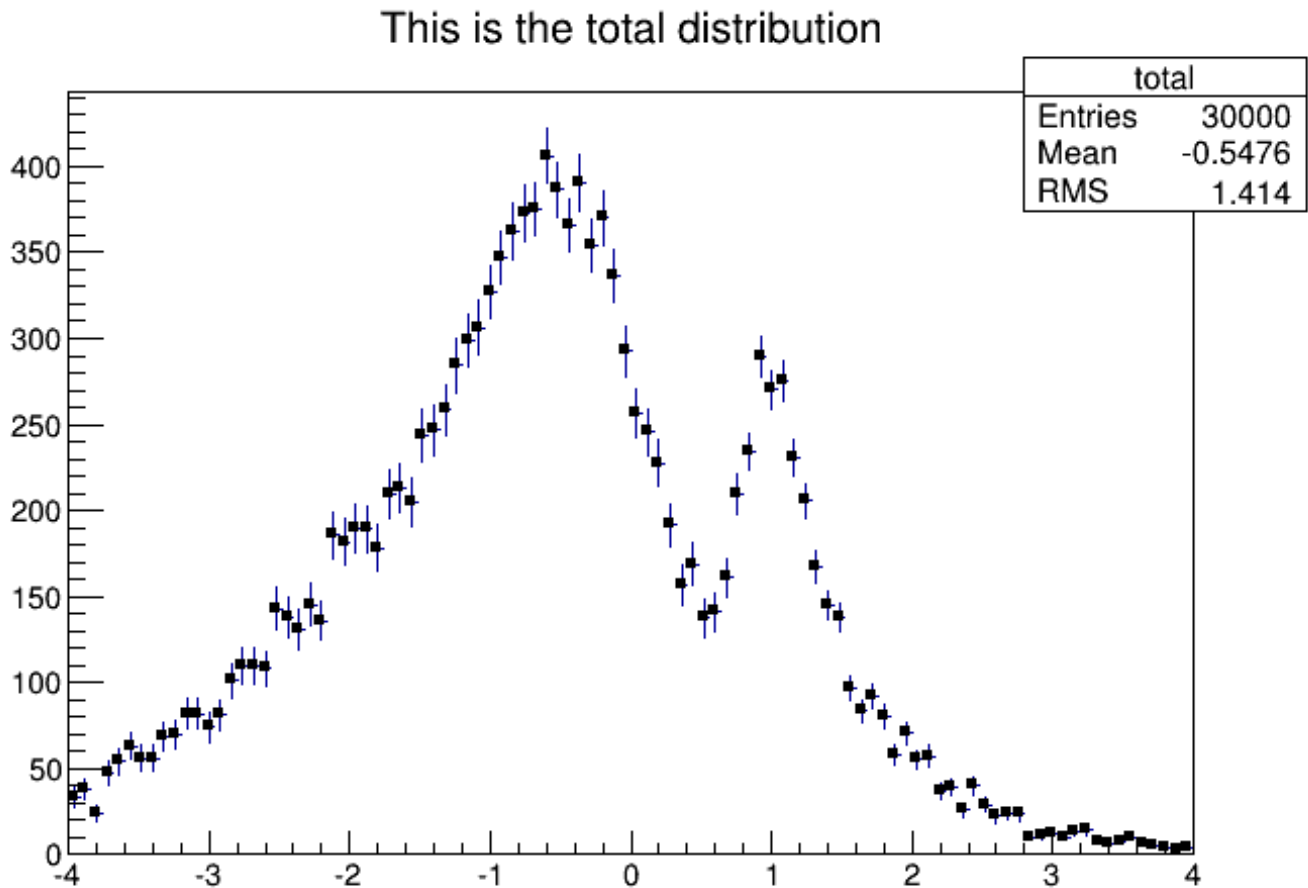

Figure 3.2: The “E1” bars’ option

Note that for all options, the line and fill attributes of the histogram are used for the errors or errors contours. Use `gStyle->SetErrorX(dx)` to control the size of the error along x. The parameter `dx` is a percentage of bin width for errors along X. Set `dx=0` to suppress the error along X. Use `gStyle->SetEndErrorSize(np)` to control the size of the lines at the end of the error bars (when option 1 is used). By default `np=1` (`np` represents the number of pixels).

### 3.8.2.5 The Color Option

For each cell  $(i, j)$  a box is drawn with a color proportional to the cell content. The color table used is defined in the current style (`gStyle`). The color palette in `TStyle` can be modified with `TStyle::SetPalette`.

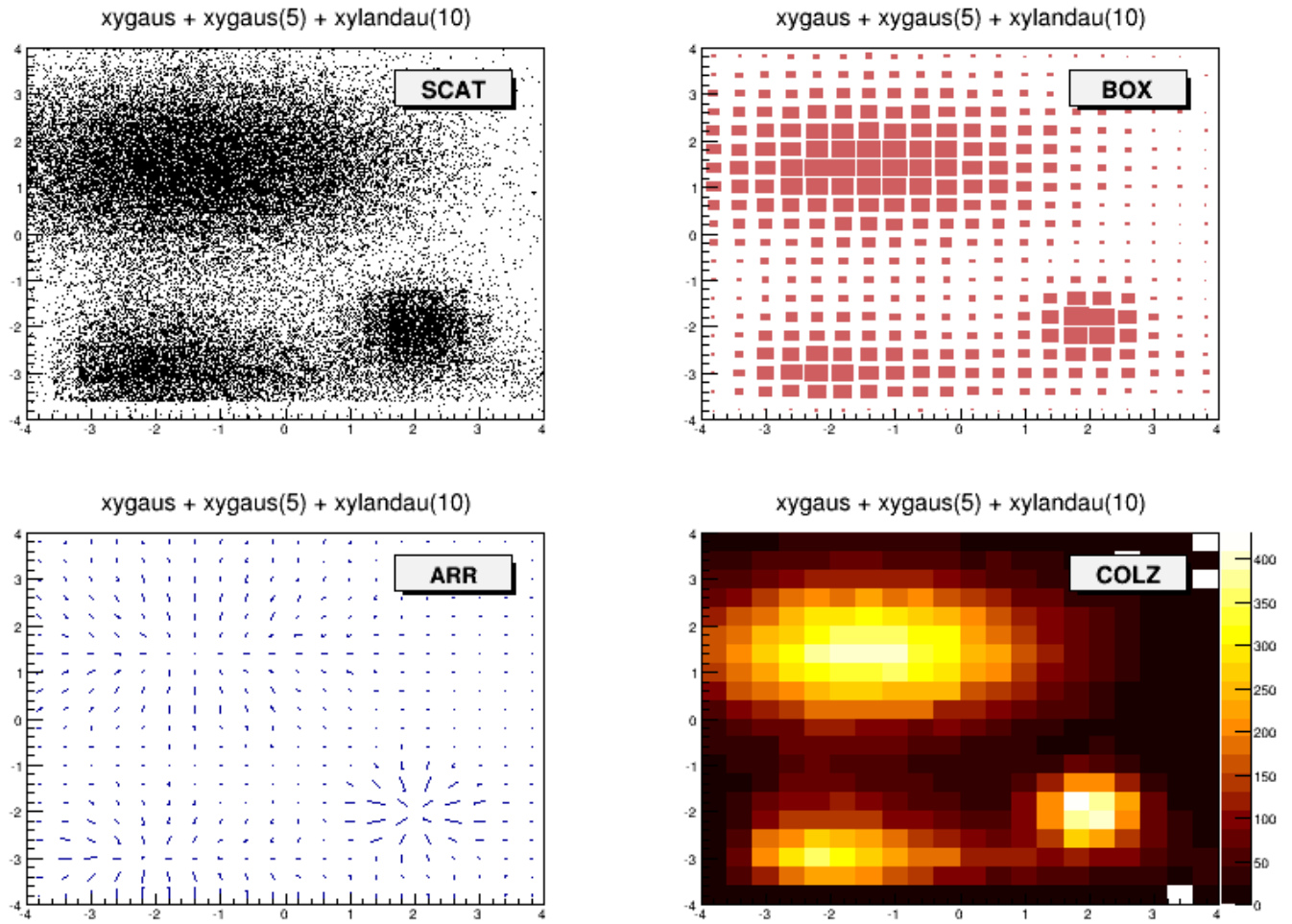

Figure 3.3: Different draw options

### 3.8.2.6 The TEXT Option

For each cell  $(i, j)$  the cell content is printed. The text attributes are:

- Text font = current font set by `TStyle`
- Text size=  $0.02 * \text{pad-height} * \text{marker-size}$
- Text color= marker color

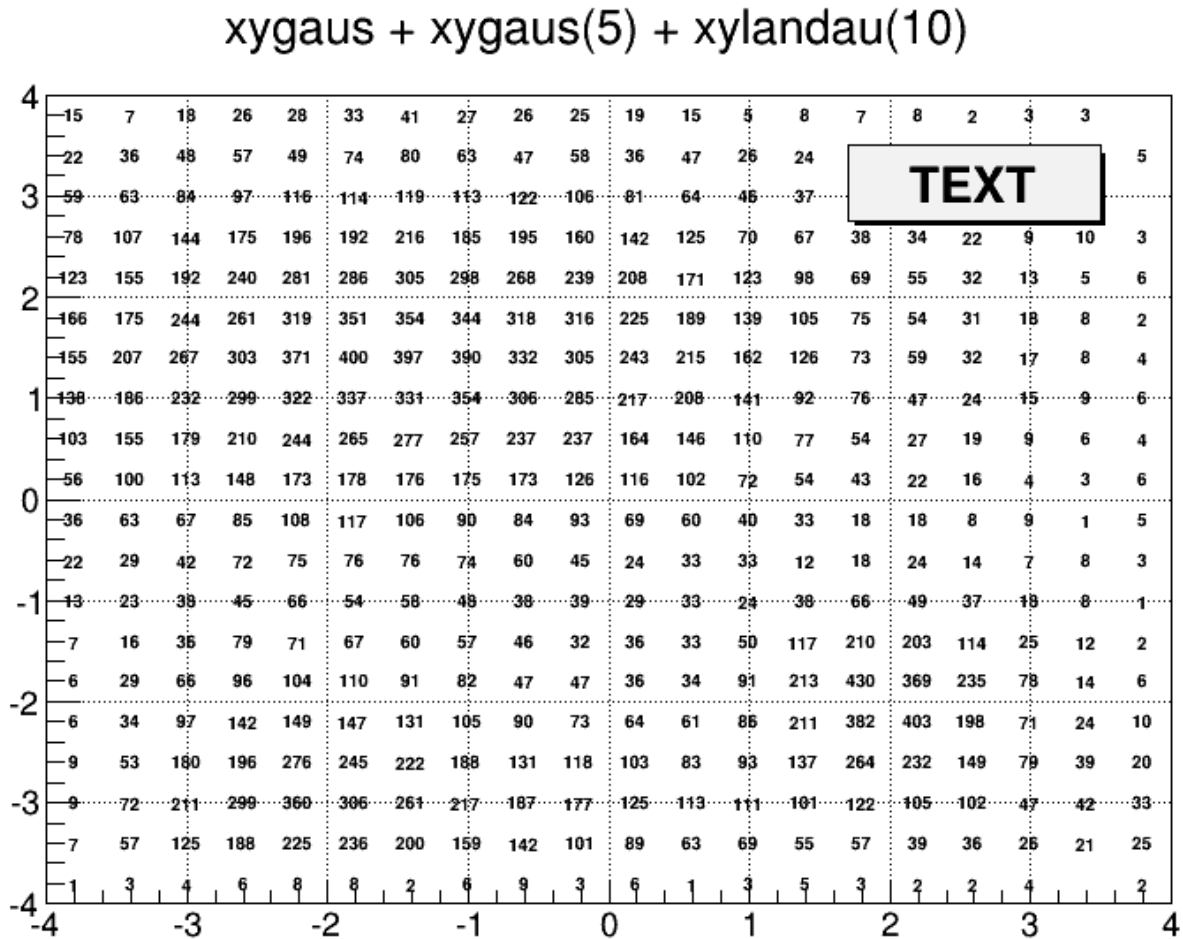

Figure 3.4: The TEXT option

### 3.8.2.7 The CONTOur Options

The following contour options are supported:

- "CONT": Draw a contour plot (same as CONTO)
- "CONTO": Draw a contour plot using surface colors to distinguish contours
- "CONT1": Draw a contour plot using line styles to distinguish contours
- "CONT2": Draw a contour plot using the same line style for all contours
- "CONT3": Draw a contour plot using fill area colors



- "CONT4": Draw a contour plot using surface colors (SURF2 option at theta = 0); see also options "AITOFF", "MERCATOR", etc. below
- "CONT5": Use Delaunay triangles to compute the contours

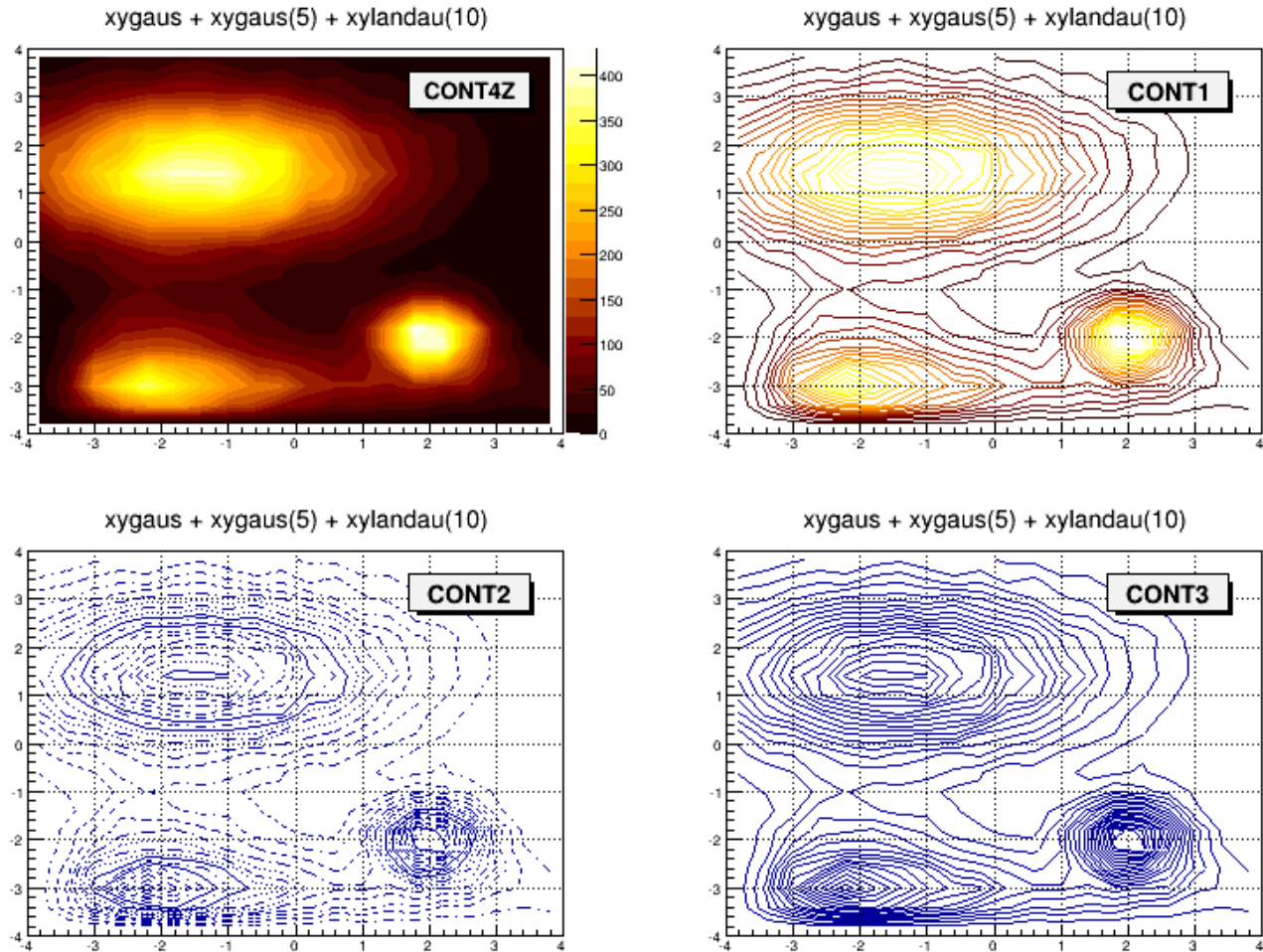

Figure 3.5: Different contour options

The default number of contour levels is 20 equidistant levels. It can be changed with `TH1::SetContour`. When option "LIST" is specified together with option "CONT", all points used for contour drawing, are saved in the `TGraph` object and are accessible in the following way:

```
TObjArray *contours =
  gROOT->GetListOfSpecials()->FindObject("contours");
Int_t ncontours = contours->GetSize(); TList *list =
(TList*)contours->At(i);
```

Where "i" is a contour number and list contains a list of `TGraph` objects. For one given contour, more than one disjoint poly-line may be generated. The `TGraph` numbers per contour are given by `list->GetSize()`. Here we show how to access the first graph in the list.

```
TGraph *gr1 = (TGraph*)list->First();
```

- "AITOFF": Draw a contour via an AITOFF projection
- "MERCATOR": Draw a contour via a Mercator projection

- “SINUSOIDAL”: Draw a contour via a Sinusoidal projection
- “PARABOLIC”: Draw a contour via a Parabolic projection

The tutorial macro `earth.C` uses these four options and produces the following picture:

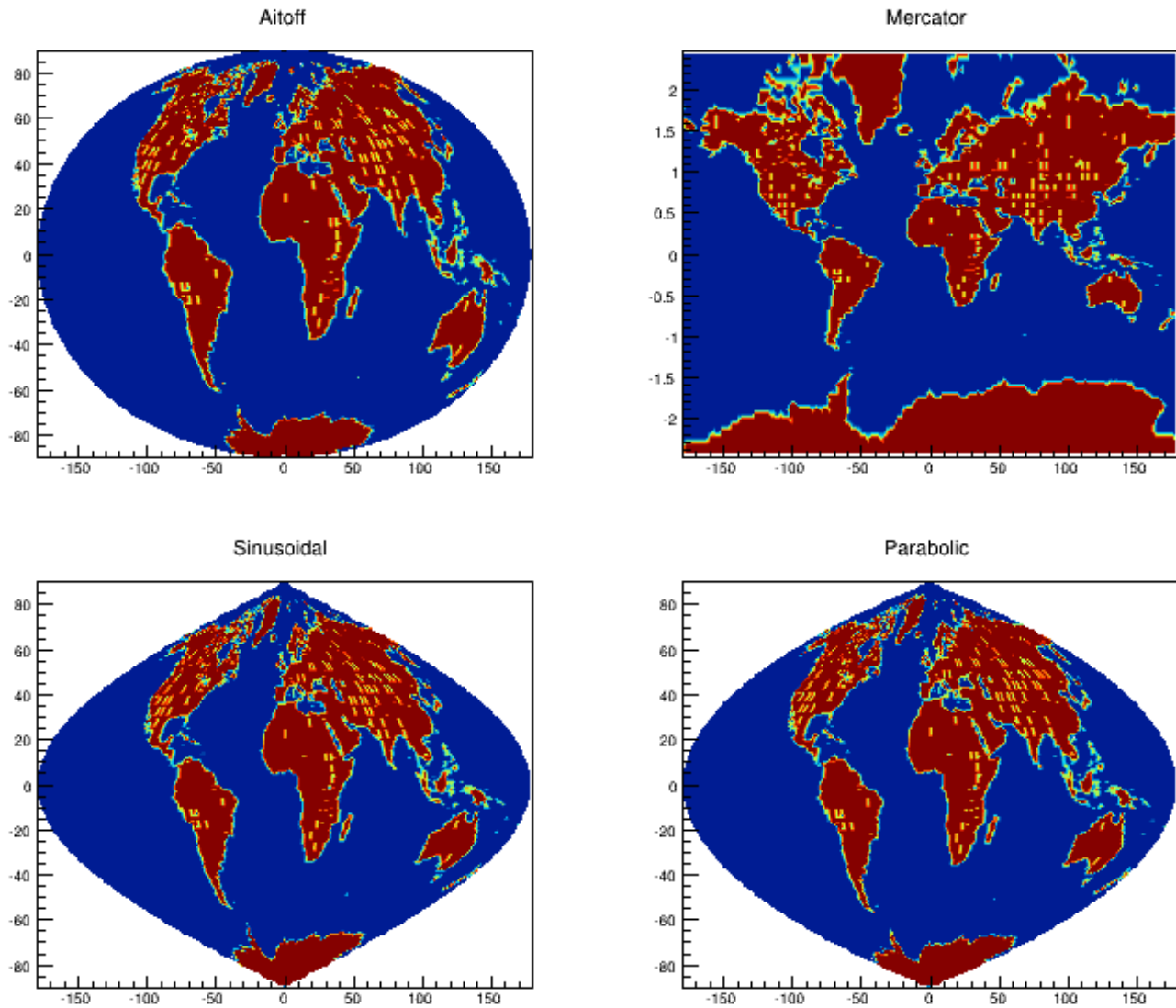

Figure 3.6: The `earth.C` macro output

### 3.8.2.8 The LEGO Options

In a lego plot, the cell contents are drawn as 3D boxes, with the height of the box proportional to the cell content.

- “LEGO”: Draw a lego plot with hidden line removal
- “LEGO1”: Draw a lego plot with hidden surface removal
- “LEGO2”: Draw a lego plot using colors to show the cell contents

A lego plot can be represented in several coordinate systems; the default system is Cartesian coordinates. Other possible coordinate systems are `CYL`, `POL`, `SPH`, and `PSR`.

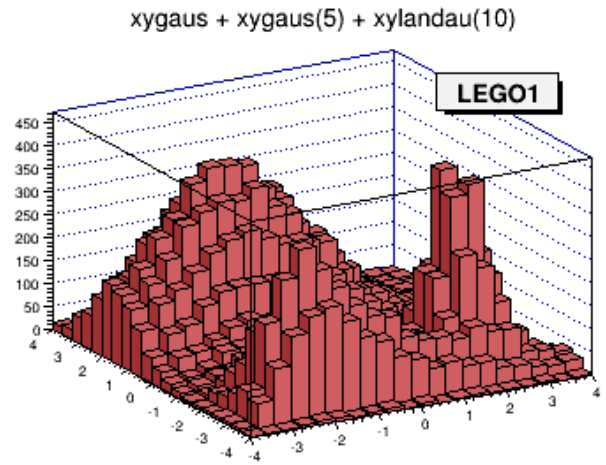
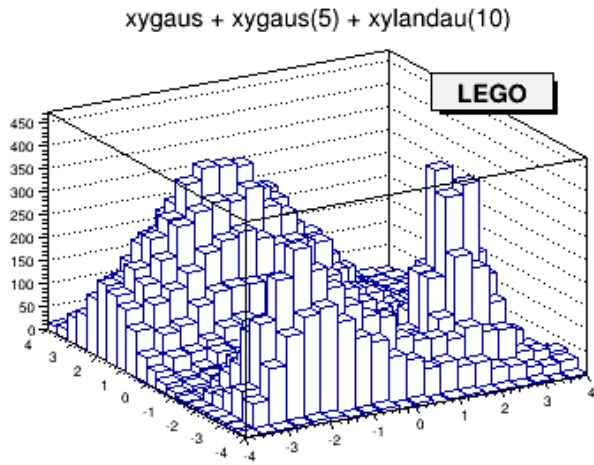

xygaus + xygaus(5) + xylandau(10)

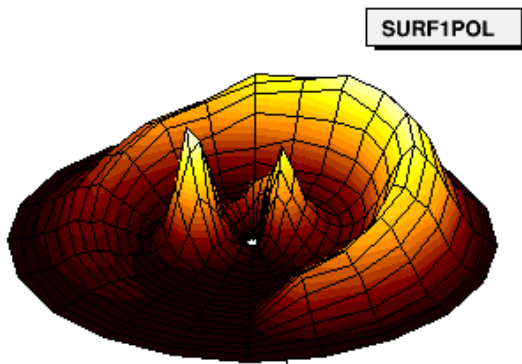

xygaus + xygaus(5) + xylandau(10)

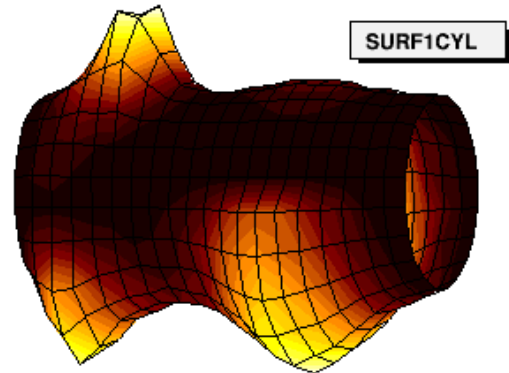

Figure 3.7: “LEGO” and “SURF” options

- “CYL”: Cylindrical coordinates: x-coordinate is mapped on the angle; y-coordinate - on the cylinder length.
- “POL”: Polar coordinates: x-coordinate is mapped on the angle; y-coordinate - on the radius.
- “SPH”: Spherical coordinates: x-coordinate is mapped on the latitude; y-coordinate - on the longitude.
- “PSR”: PseudoRapidity/Phi coordinates: x-coordinate is mapped on Phi.

With `TStyle::SetPalette` the color palette can be changed. We suggest you use palette 1 with the call:

```
gStyle->SetPalette(1);
```

### 3.8.2.9 The SURFace Options

In a surface plot, cell contents are represented as a mesh. The height of the mesh is proportional to the cell content. A surface plot can be represented in several coordinate systems. The default is Cartesian coordinates, and the other possible systems are CYL, POL, SPH, and PSR . The following picture uses SURF1 . With `TStyle::SetPalette` the color palette can be changed. We suggest you use palette 1 with the call:

```
gStyle->SetPalette(1);
```

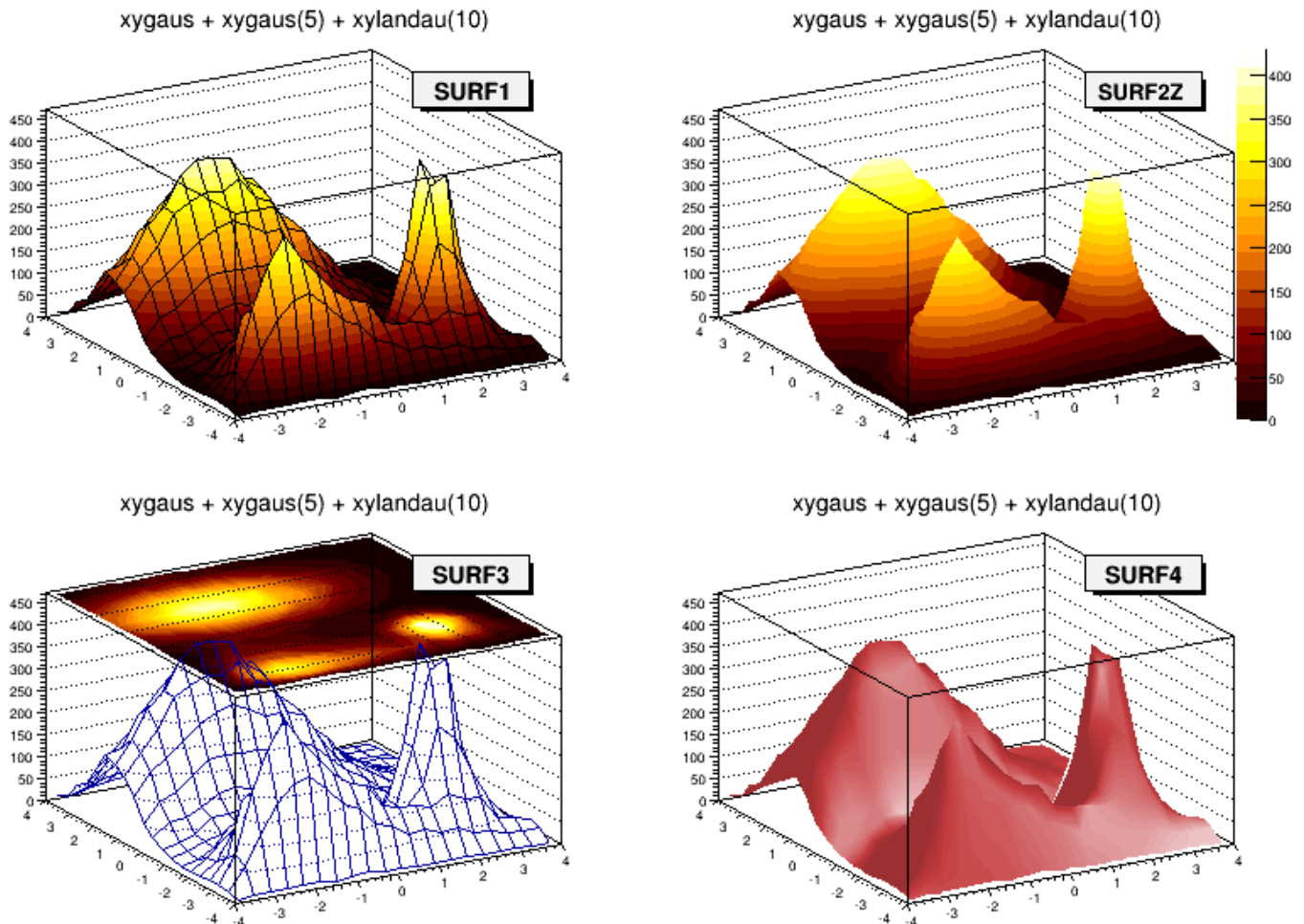

Figure 3.8: Different surface options

- “SURF”: Draw a surface plot with hidden line removal

- “SURF1”: Draw a surface plot with hidden surface removal
- “SURF2”: Draw a surface plot using colors to show the cell contents
- “SURF3”: Same as SURF with a contour view on the top
- “SURF4”: Draw a surface plot using Gouraud shading
- “SURF5”: Same as SURF3 but only the colored contour is drawn. Used with options CYL , SPH or PSR it allows to draw colored contours on a sphere, a cylinder or in a pseudo rapidly space. In Cartesian or polar coordinates, option SURF3 is used.

### 3.8.2.10 The BAR Options

When the option “bar” or “hbar” is specified, a bar chart is drawn.

The options for vertical bar chart are “bar”, “bar0”, “bar1”, “bar2”, “bar3”, “bar4”.

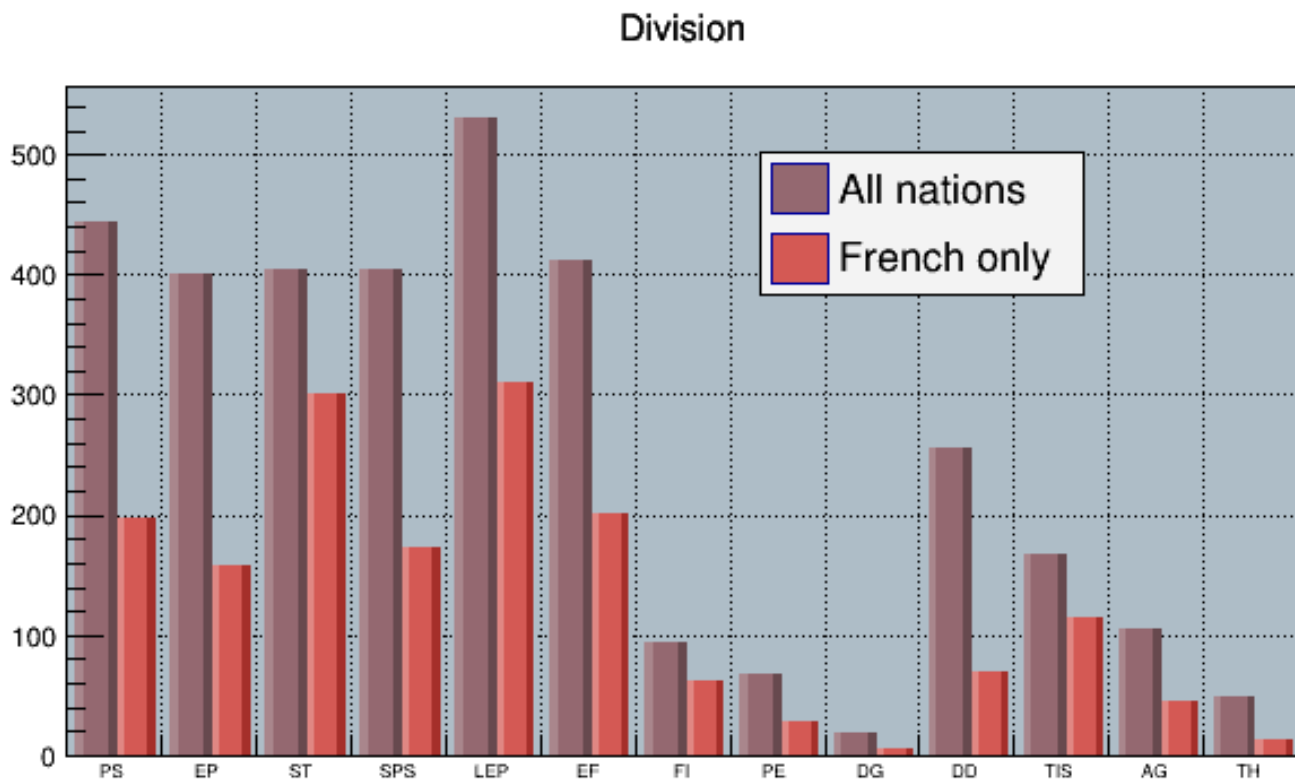

Figure 3.9: Vertical bar charts

- The bar is filled with the histogram fill color.
- The left side of the bar is drawn with a light fill color.
- The right side of the bar is drawn with a dark fill color.
- The percentage of the bar drawn with either the light or dark color is:
  - 0 per cent for option “bar” or “bar0”
  - 10 per cent for option “bar1”
  - 20 per cent for option “bar2”
  - 30 per cent for option “bar3”
  - 40 per cent for option “bar4”

Use `TH1::SetBarWidth()` to control the bar width (default is the bin width). Use `TH1::SetBarOffset` to control the bar offset (default is 0). See the example `$ROOTSYS/tutorials/hist/hbars.C`

The options for the horizontal bar chart are “hbar”, “hbar0”, “hbar1”, “hbar2”, “hbar3”, and “hbar4”.

- A horizontal bar is drawn for each bin.
- The bar is filled with the histogram fill color.
- The bottom side of the bar is drawn with a light fill color.
- The top side of the bar is drawn with a dark fill color.
- The percentage of the bar drawn with either the light or dark color is:
  - 0 per cent for option “hbar” or “hbar0”
  - 10 per cent for option “hbar1”
  - 20 per cent for option “hbar2”
  - 30 per cent for option “hbar3”
  - 40 per cent for option “hbar4”

Use `TH1::SetBarWidth` to control the bar width (default is the bin width). Use `TH1::SetBarOffset` to control the bar offset (default is 0). See the example `$ROOTSYS/tutorials/hist/hbars.C`

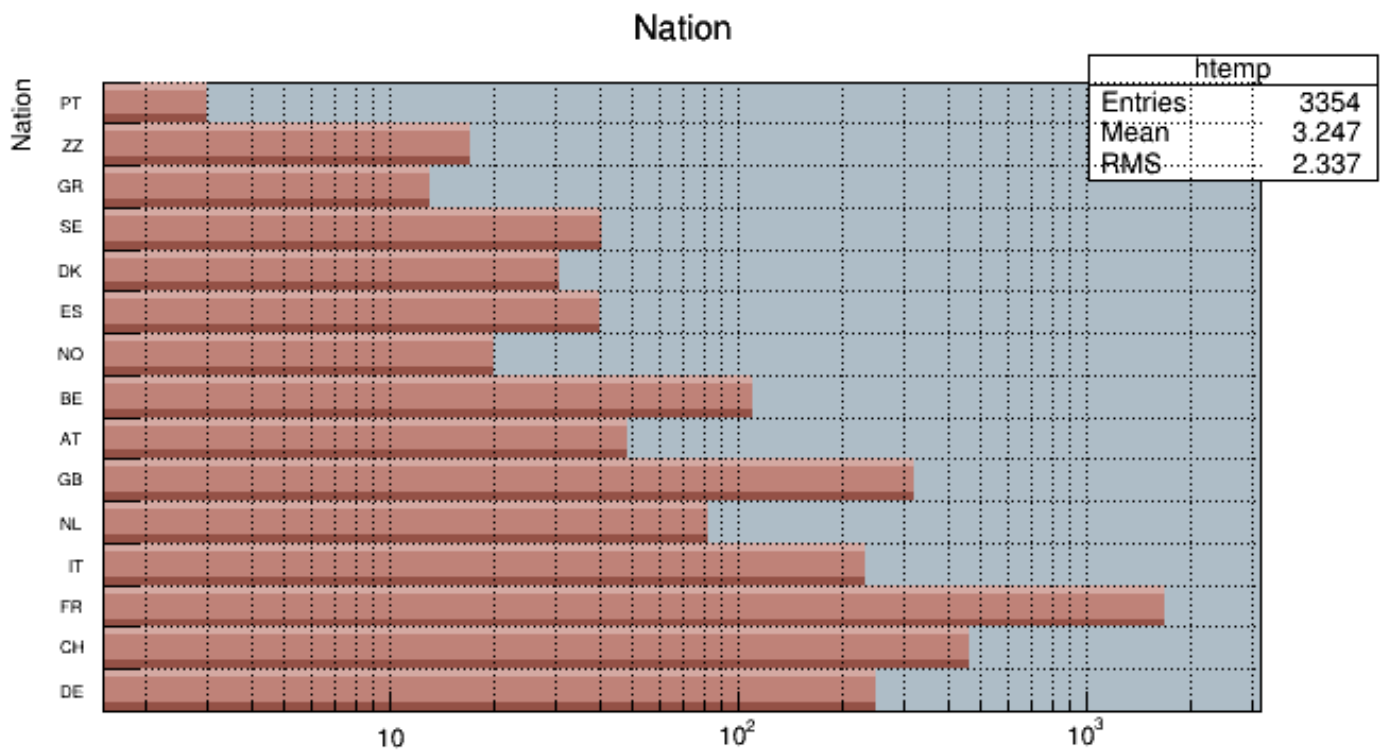

Figure 3.10: Horizontal bar charts

### 3.8.2.11 The Z Option: Display the Color Palette on the Pad

The “Z” option can be specified with the options: COL, CONT, SURF, and LEGO to display the color palette with an axis indicating the value of the corresponding color on the right side of the picture. If there is not enough space on the right side, you can increase the size of the right margin by calling `TPad::SetRightMargin()`. The attributes used to display the palette axis values are taken from the Z axis of the object. For example, you can set the labels size on the palette axis with:

```
hist->GetZaxis()->SetLabelSize();
```

### 3.8.2.12 Setting the Color Palette

You can set the color palette with `TStyle::SetPalette`, e.g.

```
gStyle->SetPalette(ncolors,colors);
```

For example, the option COL draws a 2-D histogram with cells represented by a box filled with a color index, which is a function of the cell content. If the cell content is N, the color index used will be the color number in `colors[N]`. If the maximum cell content is greater than `ncolors`, all cell contents are scaled to `ncolors`. If `ncolors<=0`, a default palette of 50 colors is defined. This palette is recommended for pads, labels. It defines:

- Index 0 to 9: shades of gray
- Index 10 to 19:shades of brown
- Index 20 to 29:shades of blue
- Index 30 to 39: shades of red
- Index 40 to 49:basic colors

The color numbers specified in this palette can be viewed by selecting the menu entry Colors in the View menu of the canvas menu bar. The color's red, green, and blue values can be changed via `TColor::SetRGB`.

If `ncolors == 1` && `colors == 0`, then a Pretty Palette with a spectrum violet to red is created with 50 colors. That's the default rain bow palette.

Other predefined palettes with 255 colors are available when `colors == 0`. The following value of `ncolors` (with `colors = 0`) give access to:

- `ncolors = 51` : Deep Sea palette.
- `ncolors = 52` : Grey Scale palette.
- `ncolors = 53` : Dark Body Radiator palette.
- `ncolors = 54` : Two-color hue palette palette. (dark blue through neutral gray to bright yellow)
- `ncolors = 55` : Rain Bow palette.
- `ncolors = 56` : Inverted Dark Body Radiator palette.

The color numbers specified in the palette can be viewed by selecting the item "colors" in the "VIEW" menu of the canvas toolbar. The color parameters can be changed via `TColor::SetRGB`.

Note that when drawing a 2D histogram `h2` with the option "COL" or "COLZ" or with any "CONT" options using the color map, the number of colors used is defined by the number of contours `n` specified with: `h2->SetContour(n)`

### 3.8.2.13 TPaletteAxis

A `TPaletteAxis` object is used to display the color palette when drawing 2D histograms. The object is automatically created when drawing a 2D histogram when the option "z" is specified. It is added to the histogram list of functions. It can be retrieved and its attributes can be changed with:

```
TPaletteAxis *palette=(TPaletteAxis*)h->FindObject("palette");
```

The palette can be interactively moved and resized. The context menu can be used to set the axis attributes. It is possible to select a range on the axis, to set the min/max in z.

### 3.8.2.14 The SPEC Option

The "SPEC" option offers a large set of options/attributes to visualize 2D histograms thanks to "operators" following the "SPEC" keyword. For example, to draw the 2-D histogram `h2` using all default attributes except the viewing angles, one can do:

```
h2->Draw("SPEC a(30,30,0)");
```



The operators' names are case insensitive (i.e. one can use "a" or "A") and their parameters are separated by coma ",". Operators can be put in any order in the option and must be separated by a space " ". No space characters should be put in an operator. All the available operators are described below.

The way how a 2D histogram will be painted is controled by two parameters: the "Display modes groups" and the "Display Modes". "Display modes groups" can take the following values:

- 0 = Simple - simple display modes using one color only
- 1 = Light - the shading is carried out according to the position of the fictive light source
- 2 = Height - the shading is carried out according to the channel contents
- 3 = LightHeight - combination of two previous shading algorithms (one can control the weight between both algorithms).

"Display modes" can take the following values:

- 1 = Points
- 2 = Grid
- 3 = Contours
- 4 = Bars
- 5 = LinesX
- 6 = LinesY
- 7 = BarsX
- 8 = BarsY
- 9 = Needles
- 10 = Surface
- 11 = Triangles

These parameters can be set by using the "dm" operator in the option.

```
h2->Draw("SPEC dm(1,2)");
```

The above example draws the histogram using the "Light Display mode group" and the "Grid Display mode". The following tables summarize all the possible combinations of both groups:

	Points	Grid	Contours	Bars	LinesX	LinesY
Simple	x	x	x	x	x	x
Light	x	x	-	-	x	x
Height	x	x	x	x	x	x
LightHeight	x	x	-	-	x	x

	BarsX	BarsY	Needles	Surface	Triangles
Simple	x	x	x	-	x
Light	-	-	-	x	x
Height	x	x	-	x	x
LightHeight	-	-	-	x	x

The "Pen Attributes" can be changed using `pa(color,style,width)`. Next example sets line color to 2, line type to 1 and line width to 2. Note that if `pa()` is not specified, the histogram line attributes are used:



```
h2->Draw("SPEC dm(1,2) pa(2,1,2)");
```

The number of “Nodes” can be changed with `n(nodesx,nodesy)`. Example:

```
h2->Draw("SPEC n(40,40)");
```

Sometimes the displayed region is rather large. When displaying all channels the pictures become very dense and complicated. It is very difficult to understand the overall shape of data. “`n(nx,ny)`” allows to change the density of displayed channels. Only the channels coinciding with given nodes are displayed.

The visualization “Angles” can be changed with “`a(alpha,beta,view)`”: “`alpha`” is the angle between the bottom horizontal screen line and the displayed space on the right side of the picture and “`beta`” on the left side, respectively. One can rotate the 3-d space around the vertical axis using the “`view`” parameter. Allowed values are 0, 90, 180 and 270 degrees.

```
h2->Draw("SPEC n(40,40) dm(0,1) a(30,30,0)");
```

The operator “`zs(scale)`” changes the scale of the Z-axis. The possible values are:

- 0 = Linear (default),
- 1 = Log,
- 2 = Sqrt.

If `gPad->SetLogz()` has been set, the log scale on Z-axis is set automatically, i.e. there is no need for using the `zs()` operator. Note that the X and Y axis are always linear.

The operator “`ci(r,g,b)`” defines the colors increments (`r`, `g` and `b` are floats). For sophisticated shading (Light, Height and LightHeight Display Modes Groups) the color palette starts from the basic pen color (see `pa()` function). There is a predefined number of color levels (256). Color in every level is calculated by adding the increments of the `r`, `g`, `b` components to the previous level. Using this function one can change the color increments between two neighboring color levels. The function does not apply on the Simple Display Modes Group. The default values are: (1,1,1).

The operator “`ca(color_algorithm)`” allows to choose the Color Algorithm. To define the colors one can use one of the following color algorithms (RGB, CMY, CIE, YIQ, HVS models). When the level of a component reaches the limit value one can choose either smooth transition (by decreasing the limit value) or a sharp modulo transition (continuing with 0 value). This allows various visual effects. One can choose from the following set of the algorithms:

- 0 = RGB Smooth,
- 1 = RGB Modulo,
- 2 = CMY Smooth,
- 3 = CMY Modulo,
- 4 = CIE Smooth
- 5 = CIE Modulo,
- 6 = YIQ Smooth,
- 7 = YIQ Modulo,
- 8 = HVS Smooth,
- 9 = HVS Modulo

This function does not apply on Simple display modes group. Default value is 0. Example choosing CMY Modulo to paint the 2D histogram:

```
h2->Draw("SPEC c1(3) dm(0,1) a(30,30,0)");
```

The operator “`lp(x,y,z)`” sets the light position. In Light and LightHeight display modes groups the color palette is calculated according to the fictive light source position in 3-d space. Using this function one can change the source’s position and thus achieve various graphical effects. This function does not apply for Simple and Height display modes groups. Default is: `lp(1000,1000,100)` .

The operator “`s(shading,shadow)`” allows to set the shading. The surface picture is composed of triangles. The edges of the neighboring triangles can be smoothed (shaded). The shadow can be painted as well. The function does not apply on Simple display modes group. The possible values for shading are:

- 0 = Not Shaded,
- 1 = Shaded.

The possible values for shadow are:

- 0 = Shadows are not painted,
- 1 = Shadows are painted.

Default values: `s(1,0)` .

The operator “`b(bezier)`” sets the Bezier smoothing. For Simple display modes group and for Grid, LinesX and LinesY display modes one can smooth data using Bezier smoothing algorithm. The function does not apply on other display modes groups and display modes. Possible values are: 0 = No bezier smoothing, 1 = Bezier smoothing. Default value is: `b(0)`.

The operator “`cw(width)`” sets the contour width. This function applies only on for the Contours display mode. One can change the width between horizontal slices and thus their density. Default value: `cw(50)` .

The operator “`lhw(weight)`” sets the light height weight. For LightHeight display modes group one can change the weight between both shading algorithms. The function does not apply on other display modes groups. Default value is `lhw(0.5)` .

The operator “`cm(enable,color,width,height,style)`” allows to draw a marker on each node. In addition to the surface drawn using any above given algorithm one can display channel marks. One can control the color as well as the width, height (in pixels) and the style of the marks. The parameter `enable` can be set to 0 = Channel marks are not drawn or 1 = Channel marks drawn. The possible styles are:

- 1 = Dot,
- 2 = Cross,
- 3 = Star,
- 4 = Rectangle,
- 5 = X,
- 6 = Diamond,
- 7 = Triangle.

The operator “`cg(enable,color)`” channel grid. In addition to the surface drawn using any above given algorithm one can display grid using the color parameter. The parameter `enable` can be set to:

- 0 = Grid not drawn,
- 1 = Grid drawn.

See the example in `$ROOTSYS/tutorials/spectrum/spectrumpainter.C` .

### 3.8.2.15 3-D Histograms

By default a 3D scatter plot is drawn. If the “BOX” option is specified, a 3D box with a volume proportional to the cell content is drawn.

## 3.8.3 Drawing a Sub-range of a 2-D Histogram

Using a `TCutG` object, it is possible to draw a 2D histogram sub-range. One must create a graphical cut (mouse or C++) and specify the name of the cut between “[” and “]” in the Draw option.

For example, with a `TCutG` named “`cutg`”, one can call:

```
myhist->Draw("surf1 [cutg]");
```

Or, assuming two graphical cuts with name “`cut1`” and “`cut2`”, one can do:

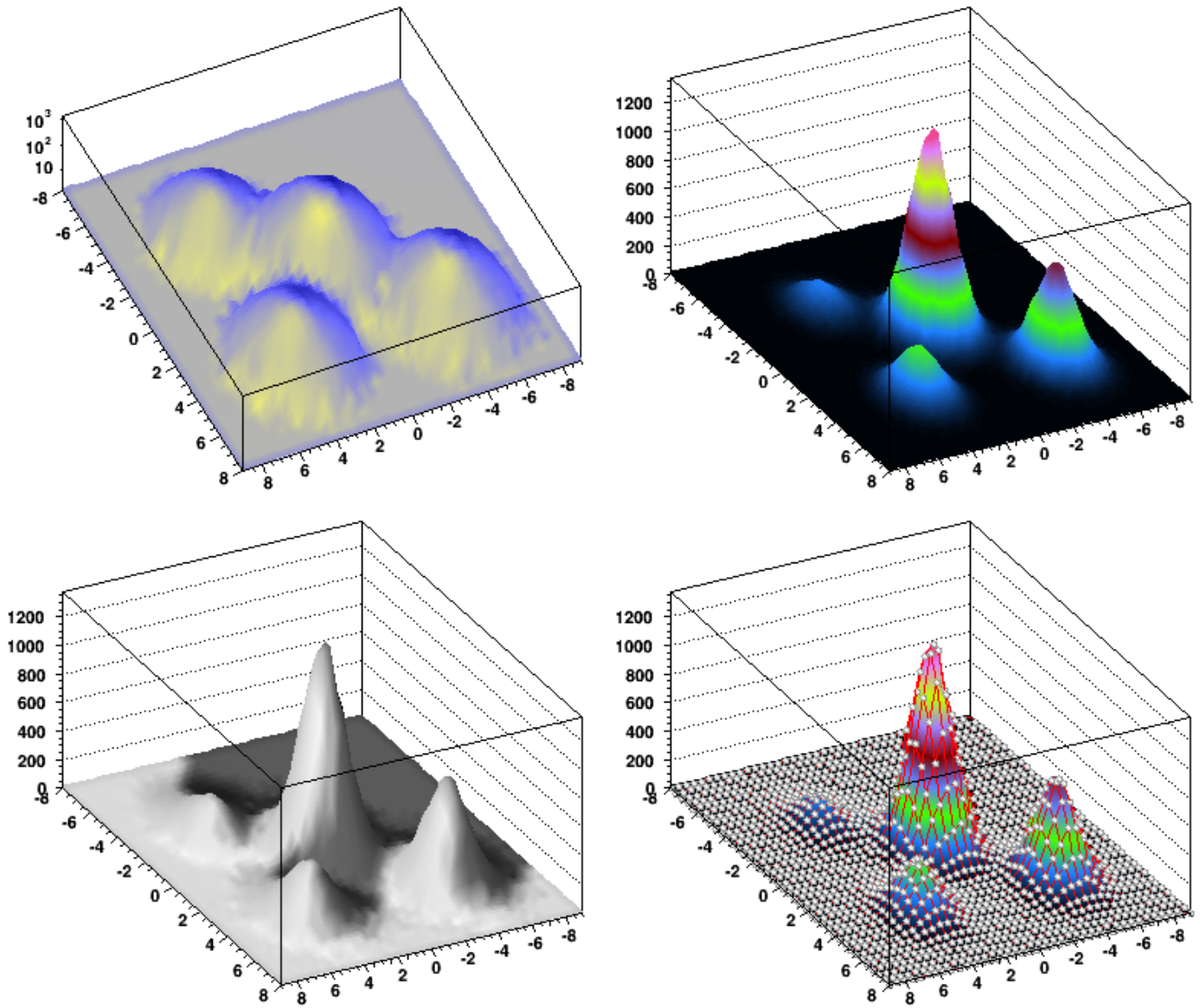

Figure 3.11: The picture produced by spectrumpainter.C macro

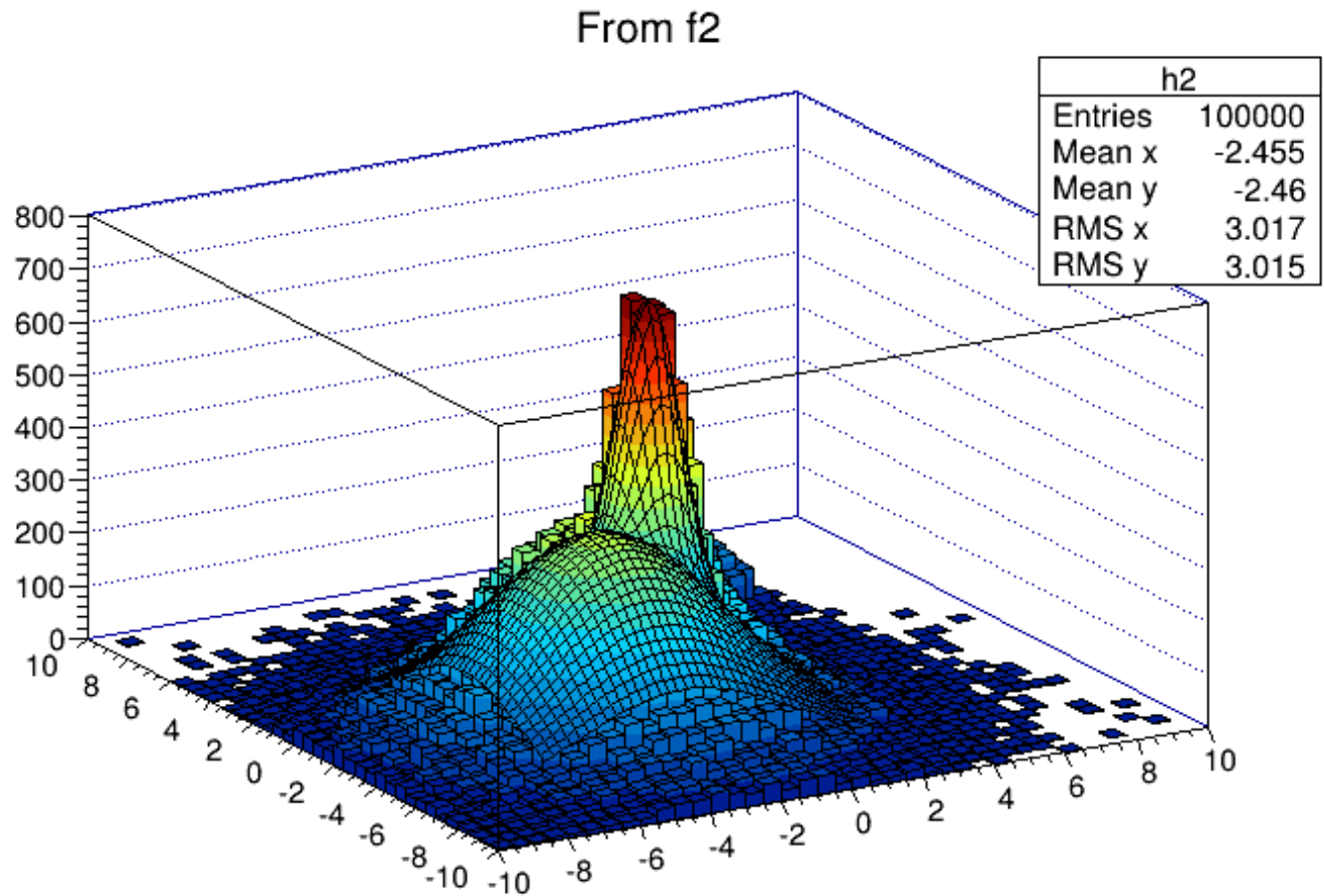

Figure 3.12: The picture produced by fit2a.C macro

```
h1.Draw("lego");
h2.Draw("[cut1,-cut2],surf,same");
```

The second Draw will superimpose on top of the first lego plot a subset of h2 using the “surf” option with:

- all the bins inside cut1
- all the bins outside cut2

Up to 16 cuts may be specified in the cut string delimited by “[.]”. Currently only the following drawing options are sensitive to the cuts option: col , box , scat , hist , lego , surf and cartesian coordinates only. See a complete example in the tutorial \$ROOTSYS/tutorials/fit/fit2a.C .

### 3.8.4 Superimposing Histograms with Different Scales

The following script creates two histograms; the second histogram is the bins integral of the first one. It shows a procedure to draw the two histograms in the same pad and it draws the scale of the second histogram using a new vertical axis on the right side.

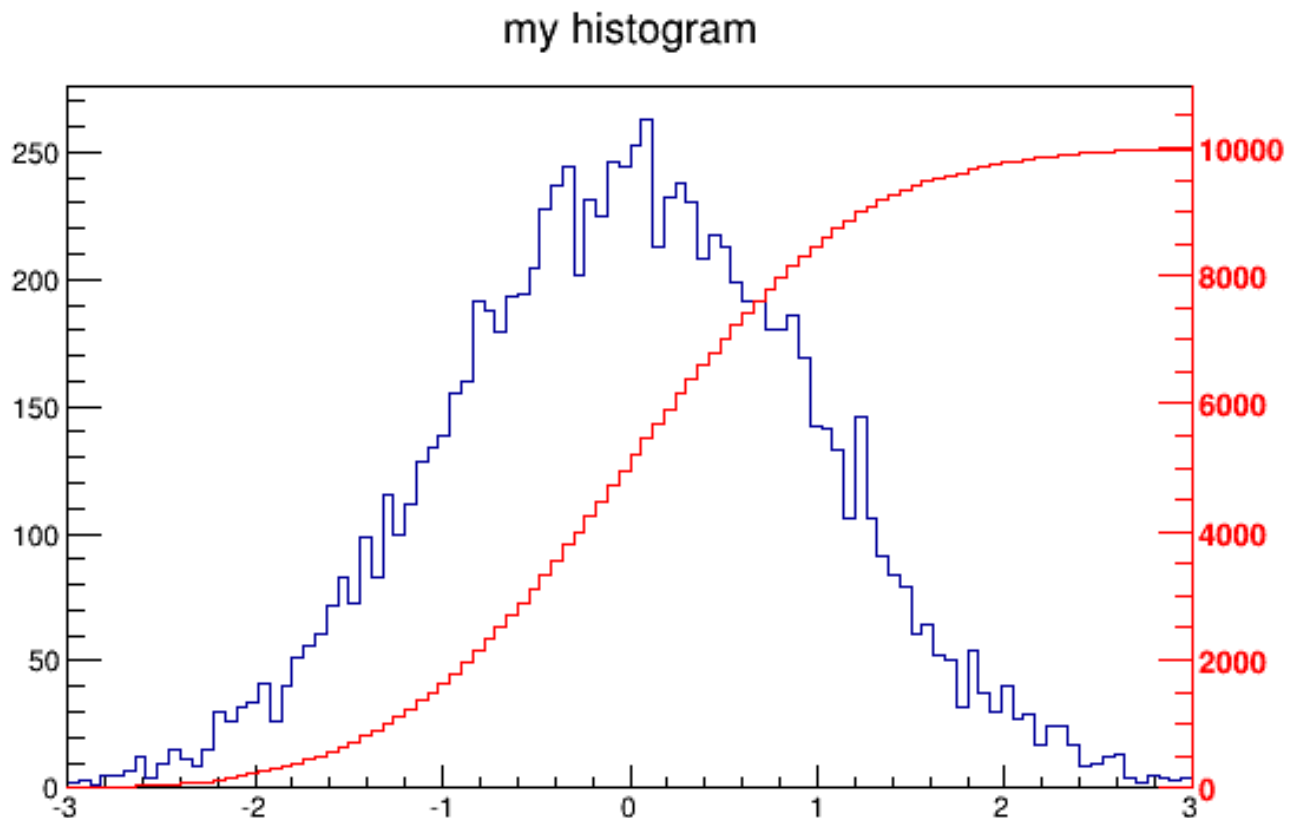

Figure 3.13: Superimposed histograms with different scales

```
void twoscales() {
    TCanvas *c1 = new TCanvas("c1","different scales hists",600,400);
    //create, fill and draw h1
    gStyle->SetOptStat(kFALSE);
    TH1F *h1 = new TH1F("h1","my histogram",100,-3,3);
    for (Int_t i=0;i<10000;i++) h1->Fill(gRandom->Gaus(0,1));
    h1->Draw();
    c1->Update();
}
```

```

//create hint1 filled with the bins integral of h1
TH1F *hint1 = new TH1F("hint1","h1 bins integral",100,-3,3);
Float_t sum = 0;
for (Int_t i=1;i<=100;i++) {
    sum += h1->GetBinContent(i);
    hint1->SetBinContent(i,sum);
}
//scale hint1 to the pad coordinates
Float_t rightmax = 1.1*hint1->GetMaximum();
Float_t scale    = gPad->GetYmax()/rightmax;
hint1->SetLineColor(kRed);
hint1->Scale(scale);
hint1->Draw("same");
//draw an axis on the right side
TGaxis*axis = new TGaxis(gPad->GetXmax(),gPad->GetYmin(),
                        gPad->GetXmax(),gPad->GetYmax(),
                        0,rightmax,510,"+L");
axis->SetLineColor(kRed);
axis->SetLabelColor(kRed);
axis->Draw();
}

```

### 3.8.5 Statistics Display

By default, a histogram drawing includes the statistics box. Use `TH1::SetStats(kFALSE)` to eliminate the statistics box. If the statistics box is drawn, `gStyle->SetOptStat(mode)` allow you to select the type of displayed information . The parameter `mode` has up to nine digits that can be set OFF (0) or ON as follows:

`mode = ksiourmen (default =000001111)`

- `n = 1` the name of histogram is printed
- `e = 1` the number of entries
- `m = 1` the mean value
- `m = 2` the mean and mean error values
- `r = 1` the root mean square (RMS)
- `r = 2` the RMS and RMS error
- `u = 1` the number of underflows
- `o = 1` the number of overflows
- `i = 1` the integral of bins
- `s = 1` the skewness
- `s = 2` the skewness and the skewness error
- `k = 1` the kurtosis
- `k = 2` the kurtosis and the kurtosis error

Never call `SetOptStat(0001111)` , but `SetOptStat(1111)` , because 0001111 will be taken as an octal number.

The method `TStyle::SetOptStat(Option_t*option)` can also be called with a character string as a parameter. The parameter `option` can contain:

- `n` for printing the name of histogram
- `e` the number of entries
- `m` the mean value
- `M` the mean and mean error values
- `r` the root mean square (RMS)
- `R` the RMS and RMS error
- `u` the number of underflows
- `o` the number of overflows

- *i* the integral of bins
- *s* the skewness
- *S* the skewness and the skewness error
- *k* the kurtosis
- *K* the kurtosis and the kurtosis error

```
gStyle->SetOptStat("ne"); // prints the histogram name and number
                          // of entries
gStyle->SetOptStat("n"); // prints the histogram name
gStyle->SetOptStat("nemr"); // the default value
```

With the option "same", the statistic box is not redrawn. With the option "sames", it is re-drawn. If it hides the previous statistics box, you can change its position with the next lines (where *h* is the histogram pointer):

```
root[] TPaveStats *s =
      (TPaveStats*)h->GetListOfFunctions()->FindObject("stats");
root[] s->SetX1NDC (newx1); // new x start position
root[] s->SetX2NDC (newx2); // new x end position
```

### 3.8.6 Setting Line, Fill, Marker, and Text Attributes

The histogram classes inherit from the attribute classes: **TAttLine**, **TAttFill**, **TAttMarker** and **TAttText**. See the description of these classes for the list of options.

### 3.8.7 Setting Tick Marks on the Axis

The **TPad::SetTicks()** method specifies the type of tick marks on the axis. Let *tx*=*gPad->GetTickx()* and *ty*=*gPad->GetTicky()*.

- *tx* = 1; tick marks on top side are drawn (inside)
- *tx* = 2; tick marks and labels on top side are drawn
- *ty* = 1; tick marks on right side are drawn (inside)
- *ty* = 2; tick marks and labels on right side are drawn
- *tx=ty=0* by default only the left Y axis and X bottom axis are drawn

Use **TPad::SetTicks(tx,ty)** to set these options. See also the methods of **TAxis** that set specific axis attributes. If multiple color-filled histograms are drawn on the same pad, the fill area may hide the axis tick marks. One can force the axis redrawing over all the histograms by calling:

```
gPad->RedrawAxis();
```

### 3.8.8 Giving Titles to the X, Y and Z Axis

Because the axis title is an attribute of the axis, you have to get the axis first and then call **TAxis::SetTitle**.

```
h->GetXaxis()->SetTitle("X axis title");
h->GetYaxis()->SetTitle("Y axis title");
h->GetZaxis()->SetTitle("Z axis title");
```

The histogram title and the axis titles can be any **TLatex** string. The titles are part of the persistent histogram. For example if you wanted to write E with a subscript (T) you could use this:

```
h->GetXaxis()->SetTitle("E_{T}");
```

For a complete explanation of the Latex mathematical expressions, see “Graphics and the Graphical User Interface”. It is also possible to specify the histogram title and the axis titles at creation time. These titles can be given in the “title” parameter. They must be separated by “;”:

```
TH1F* h=new TH1F("h","Histogram title;X Axis;Y Axis;Z Axis",
                100,0,1);
```

Any title can be omitted:

```
TH1F* h=new TH1F("h","Histogram title;;Y Axis",100,0,1);
TH1F* h=new TH1F("h",";;Y Axis",100,0,1);
```

The method `SetTitle` has the same syntax:

```
h->SetTitle("Histogram title;An other X title Axis");
```

### 3.9 Making a Copy of an Histogram

Like for any other ROOT object derived from `TObject`, the `Clone` method can be used. This makes an identical copy of the original histogram including all associated errors and functions:

```
TH1F *hnew = (TH1F*)h->Clone(); // renaming is recommended,
hnew->SetName("hnew");         // because otherwise you will have
                               // two histograms with the same
                               // name
```

### 3.10 Normalizing Histograms

You can scale a histogram ( `TH1 *h` ) such that the bins integral is equal to the normalization parameter `norm`:

```
Double_t scale = norm/h->Integral();
h->Scale(scale);
```

### 3.11 Saving/Reading Histograms to/from a File

The following statements create a ROOT file and store a histogram on the file. Because `TH1` derives from `TNamed`, the key identifier on the file is the histogram name:

```
TFile f("histos.root","new");
TH1F h1("hgaus","histo from a gaussian",100,-3,3);
h1.FillRandom("gaus",10000);
h1->Write();
```

To read this histogram in another ROOT session, do:

```
TFile f("histos.root");
TH1F *h = (TH1F*)f.Get("hgaus");
```

One can save all histograms in memory to the file by:

```
file->Write();
```

For a more detailed explanation, see “Input/Output”.



## 3.12 Miscellaneous Operations

- `TH1::KolmogorovTest( TH1* h2,Option_t *option)` is statistical test of compatibility in shape between two histograms. The parameter `option` is a character string that specifies:
  - “U” include Underflows in test (also for 2-dim)
  - “O” include Overflows (also valid for 2-dim)
  - “N” include comparison of normalizations
  - “D” put out a line of “Debug” printout
  - “M” return the maximum Kolmogorov distance instead of `prob`
  - “X” run the pseudo experiments post-processor with the following procedure: it makes pseudo experiments based on random values from the parent distribution and compare the KS distance of the pseudo experiment to the parent distribution. Bin the KS distances in a histogram, and then take the integral of all the KS values above the value obtained from the original data to Monte Carlo distribution. The number of pseudo-experiments NEXPT is currently fixed at 1000. The function returns the integral. Note that this option “X” is much slower.
- `TH1::Smooth` - smoothes the bin contents of a 1D histogram.
- `TH1::Integral(Option_t *opt)`-returns the integral of bin contents in a given bin range. If the option “width” is specified, the integral is the sum of the bin contents multiplied by the bin width in `x`.
- `TH1::GetMean(int axis)` - returns the mean value along axis.
- `TH1::GetRMS(int axis)` - returns the Root Mean Square along axis.
- `TH1::GetEntries()` - returns the number of entries.
- `TH1::GetAsymmetry(TH1 *h2,Double_t c2,Double_t dc2)`

– returns an histogram containing the asymmetry of this histogram with `h2`, where the asymmetry is defined as:

```
Asymmetry = (h1 - h2)/(h1 + h2); //where h1 = this
```

- It works for 1D , 2D , etc. histograms. The parameter `c2` is an optional argument that gives a relative weight between the two histograms, and `dc 2` is the error on this weight. This is useful, for example, when forming an asymmetry between two histograms from two different data sets that need to be normalized to each other in some way. The function calculates the errors assuming Poisson statistics on `h1` and `h2` (that is,  $dh = \sqrt{h}$ ). In the next example we assume that `h1` and `h2` are already filled:

```
h3 = h1->GetAsymmetry(h2);
```

- Then `h3` is created and filled with the asymmetry between `h1` and `h2` ; `h1` and `h2` are left intact.
- Note that the user’s responsibility is to manage the created histograms.
- `TH1::Reset()` - resets the bin contents and errors of a histogram

## 3.13 Alphanumeric Bin Labels

By default, a histogram axis is drawn with its numeric bin labels. One can specify alphanumeric labels instead.

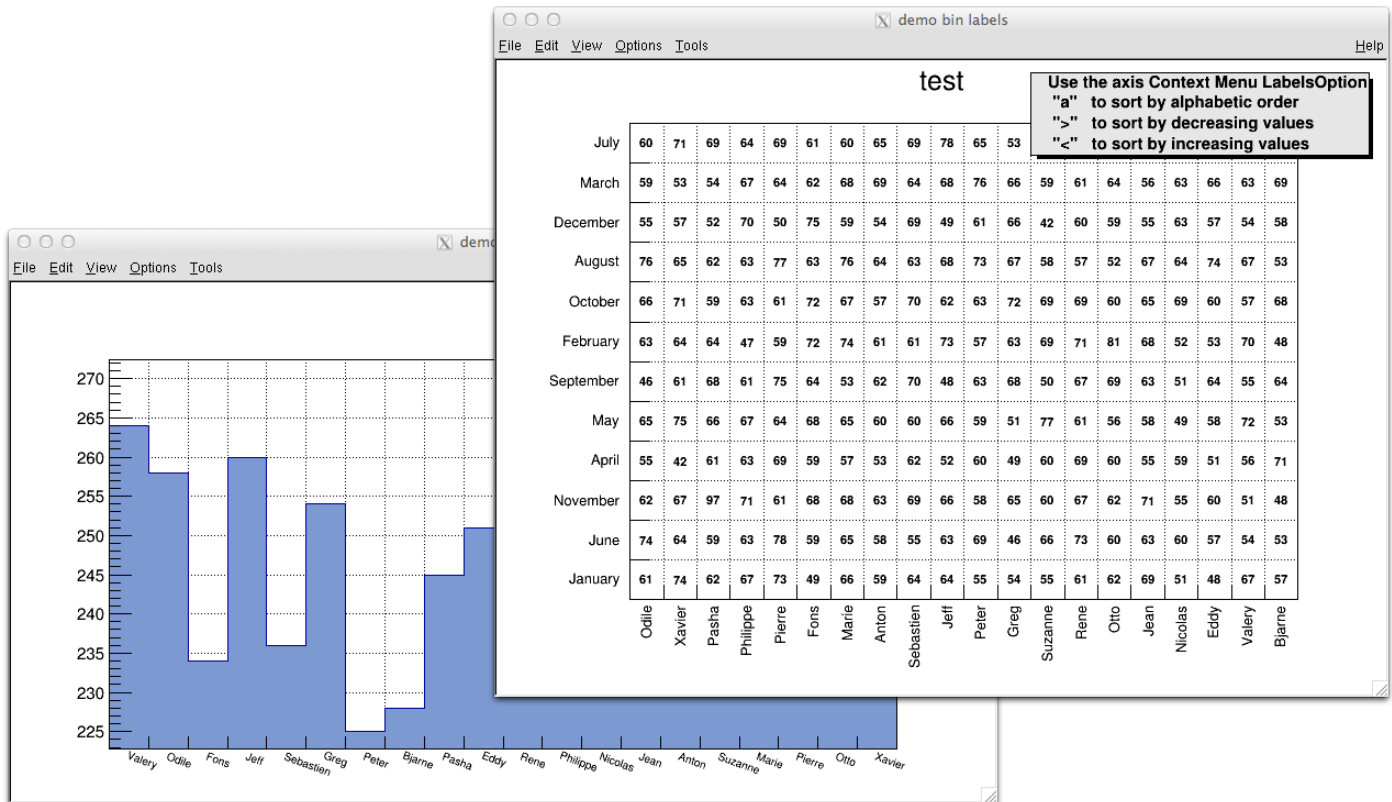

Figure 3.14: Histograms with alphanumeric bin labels

### 3.13.1 Option 1: SetBinLabel

To set an alphanumeric bin label call:

```
TAxis::SetBinLabel(bin,label);
```

This can always be done before or after filling. Bin labels will be automatically drawn with the histogram.

See example in `$ROOTSYS/tutorials/hist/hlabels1.C`, `hlabels2.C`

### 3.13.2 Option 2: Fill

You can also call a `Fill()` function with one of the arguments being a string:

```
hist1->Fill(somename,weight);
hist2->Fill(x,somename,weight);
hist2->Fill(somename,y,weight);
hist2->Fill(somename,somenamey,weight);
```

### 3.13.3 Option 3: TTree::Draw

You can use a `char*` variable type to histogram strings with `TTree::Draw()`.

```
// here "Nation" and "Division" are two char* branches of a Tree
tree.Draw("Nation::Division", "", "text");
```

Nation:Division

			1	1										hN	
PT			1	1										Entries	3354
ZZ	2	9	1					1	1	1	1			Mean x	4.53
GR	2	4		1		1	1				3			Mean y	3.247
SE	4	10	1	7	5	1	1				6	1		RMS x	3.237
DK	5	3		3	7	2	1	2			5	3		RMS y	2.337
ES	2	6	3	2	8	7		1	1	5	1	1	3		
NO		4		7	3	2	1		1	1	1				
BE	17	8	6	23	20	3	5	3	1	14	10				
AT	8	8	1	10	9	7		1		2	1		1		
GB	45	35	7	40	37	27	5	11	3	66	12	24	8		
NL	13	12		23	3	9		5		9	4	1	3		
IT	35	42	23	23	33	31	4	2	4	24	5	1	6		
FR	197	158	301	173	311	202	63	28	5	70	115	46	13		
CH	74	47	53	57	68	76	11	9	2	30	7	25	6		
DE	40	55	7	34	27	43	2	5	1	20	7	6	2		
	PS	EP	ST	SPS	LEP	EF	FI	PE	DG	DD	TIS	AG	TH		

Figure 3.15: Using a \*char variable type in TTree::Draw

There is an example in `$ROOTSYS/tutorials/tree/cernstaff.C`.

If a variable is defined as `char*` it is drawn as a string by default. You change that and draw the value of `char[0]` as an integer by adding an arithmetic operation to the expression as shown below.

```
// draw the integer value of MyChar[0] where "MyChar" is char[5]
tree.Draw("MyChar + 0");
```

### 3.13.4 Sort Options

When using the options 2 or 3 above, the labels are automatically added to the list (`THashList`) of labels for a given axis. By default, an axis is drawn with the order of bins corresponding to the filling sequence. It is possible to reorder the axis alphabetically or by increasing or decreasing values. The reordering can be triggered via the `TAxis` context menu by selecting the menu item “LabelsOption” or by calling directly.

```
TH1::LabelsOption(option,axis);
```

Here `axis` may be X, Y, or Z. The parameter `option` may be:

- “a” sort by alphabetic order
- “>” sort by decreasing values
- “<” sort by increasing values
- “h” draw labels horizontal
- “v” draw labels vertical
- “u” draw labels up (end of label right adjusted)
- “d” draw labels down (start of label left adjusted)

When using the option second above, new labels are added by doubling the current number of bins in case one label does not exist yet. When the filling is terminated, it is possible to trim the number of bins to match the number of active labels by calling:

```
TH1::LabelsDeflate(axis);
```

Here `axis` may be X, Y, or Z. This operation is automatic when using `TTree::Draw`. Once bin labels have been created, they become persistent if the histogram is written to a file or when generating the C++ code via `SavePrimitive`.

## 3.14 Histogram Stacks

A `THStack` is a collection of `TH1` (or derived) objects. Use `THStack::Add( TH1 *h)` to add a histogram to the stack. The `THStack` does not own the objects in the list.

By default, `THStack::Draw` draws the histograms stacked as shown in the left pad in the picture above. If the option “nostack” is used, the histograms are superimposed as if they were drawn one at a time using the “same” draw option. The right pad in this picture illustrates the `THStack` drawn with the “nostack” option.

```
hs->Draw("nostack");
```

Next is a simple example, for a more complex one see `$ROOTSYS/tutorials/hist/hstack.C`.

```
{
  THStack hs("hs","test stacked histograms");
  TH1F *h1 = new TH1F("h1","test hstack",100,-4,4);
  h1->FillRandom("gaus",20000);
  h1->SetFillColor(kRed);
}
```

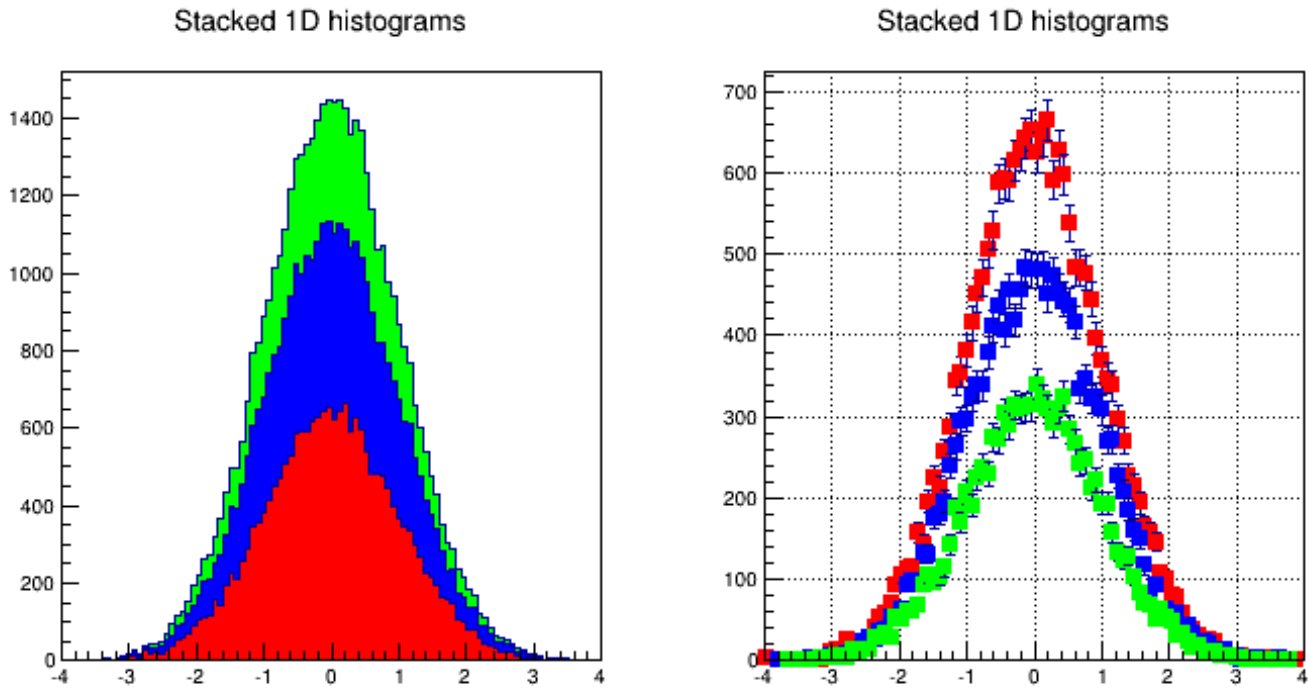

Figure 3.16: Stacked histograms

```

hs.Add(h1);
TH1F *h2 = new TH1F("h2","test hstack",100,-4,4);
h2->FillRandom("gaus",15000);
h2->SetFillColor(kBlue);
hs.Add(h2);
TH1F *h3 = new TH1F("h3","test hstack",100,-4,4);
h3->FillRandom("gaus",10000);
h3->SetFillColor(kGreen);
hs.Add(h3);
TCanvas c1("c1","stacked hists",10,10,700,900);
c1.Divide(1,2);
c1.cd(1);
hs.Draw();
c1.cd(2);
hs->Draw("nostack");
}

```

## 3.15 TH2Poly

TH2Poly is a 2D Histogram class allowing to define polygonal bins of arbitrary shape.

Each bin in the TH2Poly histogram is a TH2PolyBin object. TH2PolyBin is a very simple class containing the vertices and contents of the polygonal bin as well as several related functions.

Bins are defined using one of the AddBin() methods. The bin definition should be done before filling.

The following very simple macro shows how to build and fill a TH2Poly:

```

{
  TH2Poly *h2p = new TH2Poly();
  Double_t x1[] = {0, 5, 5};
  Double_t y1[] = {0, 0, 5};

```

```

Double_t x2[] = {0, -1, -1, 0};
Double_t y2[] = {0, 0, -1, -1};
Double_t x3[] = {4, 3, 0, 1, 2.4};
Double_t y3[] = {4, 3.7, 1, 4.7, 3.5};
h2p->AddBin(3, x1, y1);
h2p->AddBin(3, x2, y2);
h2p->AddBin(3, x3, y3);
h2p->Fill( 3, 1, 3);      // fill bin 1
h2p->Fill(-0.5, -0.5, 7); // fill bin 2
h2p->Fill(-0.7, -0.5, 1); // fill bin 2
h2p->Fill( 1, 3, 5);      // fill bin 3
}

```

More examples can be found in `$ROOTSYS/tutorials/hist/th2poly*.C`

Europe (bin contents are normalized to the surfaces in km<sup>2</sup>)

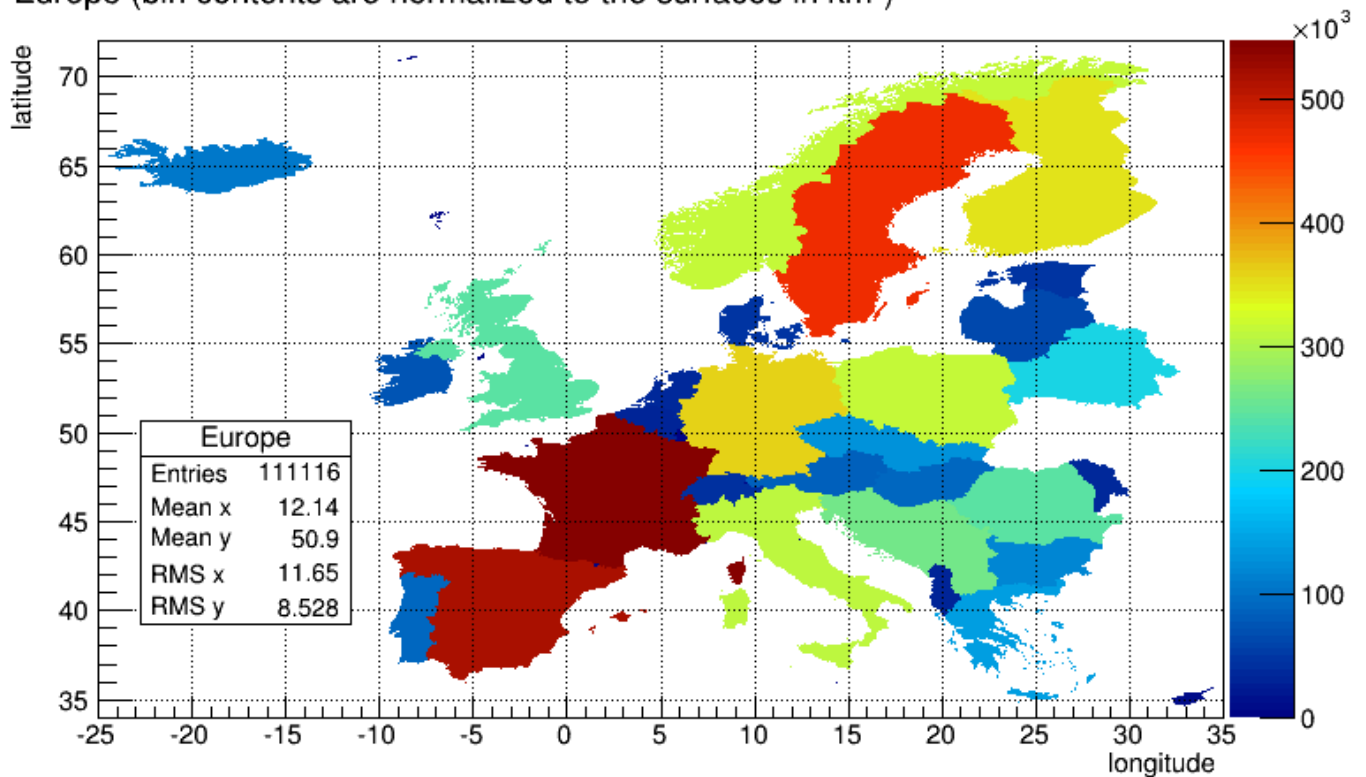

Figure 3.17: A TH2Poly histogram example

### 3.16 Profile Histograms

Profile histograms are in many cases an elegant replacement of two-dimensional histograms. The relationship of two quantities  $X$  and  $Y$  can be visualized by a two-dimensional histogram or a scatter-plot; its representation is not particularly satisfactory, except for sparse data. If  $Y$  is an unknown [but single-valued] function of  $X$ , it can be displayed by a profile histogram with much better precision than by a scatter-plot. Profile histograms display the mean value of  $Y$  and its RMS for each bin in  $X$ . The following shows the contents [capital letters] and the values shown in the graphics [small letters] of the elements for bin  $j$ . When you fill a profile histogram with `TProfile.Fill(x,y)` :

- $H[j]$  will contain for each bin  $j$  the sum of the  $y$  values for this bin
- $L[j]$  contains the number of entries in the bin  $j$

- $e[j]$  or  $s[j]$  will be the resulting error depending on the selected option. See “Build Options”.

```

E[j] = sum Y**2
L[j] = number of entries in bin J
H[j] = sum Y
h[j] = H[j] / L[j]
s[j] = sqrt[E[j] / L[j] - h[j]**2]
e[j] = s[j] / sqrt[L[j]]

```

In the special case where  $s[j]$  is zero, when there is only one entry per bin,  $e[j]$  is computed from the average of the  $s[j]$  for all bins. This approximation is used to keep the bin during a fit operation. The `TProfile` constructor takes up to eight arguments. The first five parameters are similar to `TH1D` constructor.

```

TProfile(const char *name, const char *title, Int_t nbinsx,
         Double_t xlow, Double_t xup, Double_t ylow, Double_t yup,
         Option_t *option)

```

All values of  $y$  are accepted at filling time. To fill a profile histogram, you must use `TProfile::Fill` function. Note that when filling the profile histogram the method `TProfile::Fill` checks if the variable  $y$  is between `fYmin` and `fYmax`. If a minimum or maximum value is set for the  $Y$  scale before filling, then all values below `ylow` or above `yup` will be discarded. Setting the minimum or maximum value for the  $Y$  scale before filling has the same effect as calling the special `TProfile` constructor above where `ylow` and `yup` are specified.

### 3.16.1 Build Options

The last parameter is the build option. If a bin has  $N$  data points all with the same value  $Y$ , which is the case when dealing with integers, the spread in  $Y$  for that bin is zero, and the uncertainty assigned is also zero, and the bin is ignored in making subsequent fits. If  $\text{SQRT}(Y)$  was the correct error in the case above, then  $\text{SQRT}(Y)/\text{SQRT}(N)$  would be the correct error here. In fact, any bin with non-zero number of entries  $N$  but with zero spread (`spread = s[j]`) should have an uncertainty  $\text{SQRT}(Y)/\text{SQRT}(N)$ . Now, is  $\text{SQRT}(Y)/\text{SQRT}(N)$  really the correct uncertainty? That it is only in the case where the  $Y$  variable is some sort of counting statistics, following a Poisson distribution. This is the default case. However,  $Y$  can be any variable from an original `NTUPLE`, and does not necessarily follow a Poisson distribution. The computation of errors is based on  $Y =$  values of data points;  $N =$  number of data points.

- ' ' - the default is blank, the errors are:
  - $\text{spread}/\text{SQRT}(N)$  for a non-zero spread
  - $\text{SQRT}(Y)/\text{SQRT}(N)$  for a spread of zero and some data points
  - 0 for no data points
- 's' - errors are:
  - $\text{spread}$  for a non-zero spread
  - $\text{SQRT}(Y)$  for a Spread of zero and some data points
  - 0 for no data points
- 'i' - errors are:
  - $\text{spread}/\text{SQRT}(N)$  for a non-zero spread
  - $1/\text{SQRT}(12*N)$  for a Spread of zero and some data points
  - 0 for no data points
- 'G' - errors are:
  - $\text{spread}/\text{SQRT}(N)$  for a non-zero spread

- $\sigma/\sqrt{N}$  for a spread of zero and some data points
- 0 for no data points

The option ‘i’ is used for integer Y values with the uncertainty of  $\pm 0.5$ , assuming the probability that Y takes any value between Y-0.5 and Y+0.5 is uniform (the same argument for Y uniformly distributed between Y and Y+1). An example is an ADC measurement. The ‘G’ option is useful, if all Y variables are distributed according to some known Gaussian of standard deviation Sigma. For example when all Y’s are experimental quantities measured with the same instrument with precision Sigma. The next figure shows the graphic output of this simple example of a profile histogram.

```
{
// Create a canvas giving the coordinates and the size
TCanvas *c1 = new TCanvas("c1", "Profile example",200,10,700,500);

// Create a profile with the name, title, the number of bins,
// the low and high limit of the x-axis and the low and high
// limit of the y-axis.
// No option is given so the default is used.
hprof = new TProfile("hprof",
                    "Profile of pz versus px",100,-4,4,0,20);

// Fill the profile 25000 times with random numbers
Float_t px, py, pz;
for ( Int_t i=0; i<25000; i++) {
    // Use the random number generator to get two numbers following
    // a gaussian distribution with mean=0 and sigma=1
    gRandom->Rannor(px,py);
    pz = px*px + py*py;
    hprof->Fill(px,pz,1);
}
hprof->Draw();
}
```

### 3.16.2 Drawing a Profile without Error Bars

To draw a profile histogram and not show the error bars use the “HIST” option in the `TProfile::Draw` method. This will draw the outline of the `TProfile`.

### 3.16.3 Create a Profile from a 2D Histogram

You can make a profile from a histogram using the methods `TH2::ProfileX` and `TH2::ProfileY`.

### 3.16.4 Create a Histogram from a Profile

To create a regular histogram from a profile histogram, use the method `TProfile::ProjectionX`. This example instantiates a `TH1D` object by copying the `TH1D` piece of `TProfile`.

```
TH1D *sum = myProfile.ProjectionX();
```

You can do the same with a 2D profile using the method `TProfile2D::ProjectionXY`.

### 3.16.5 Generating a Profile from a TTree

The ‘prof’ and ‘profs’ options in the `TTree::Draw` method generate a profile histogram (`TProfile`), given a two dimensional expression in the tree, or a `TProfile2D` given a three dimensional expression. See “Trees”. Note that you can specify ‘prof’ or ‘profs’: ‘prof’ generates a `TProfile` with error on the mean, ‘profs’ generates a `TProfile` with error on the spread.



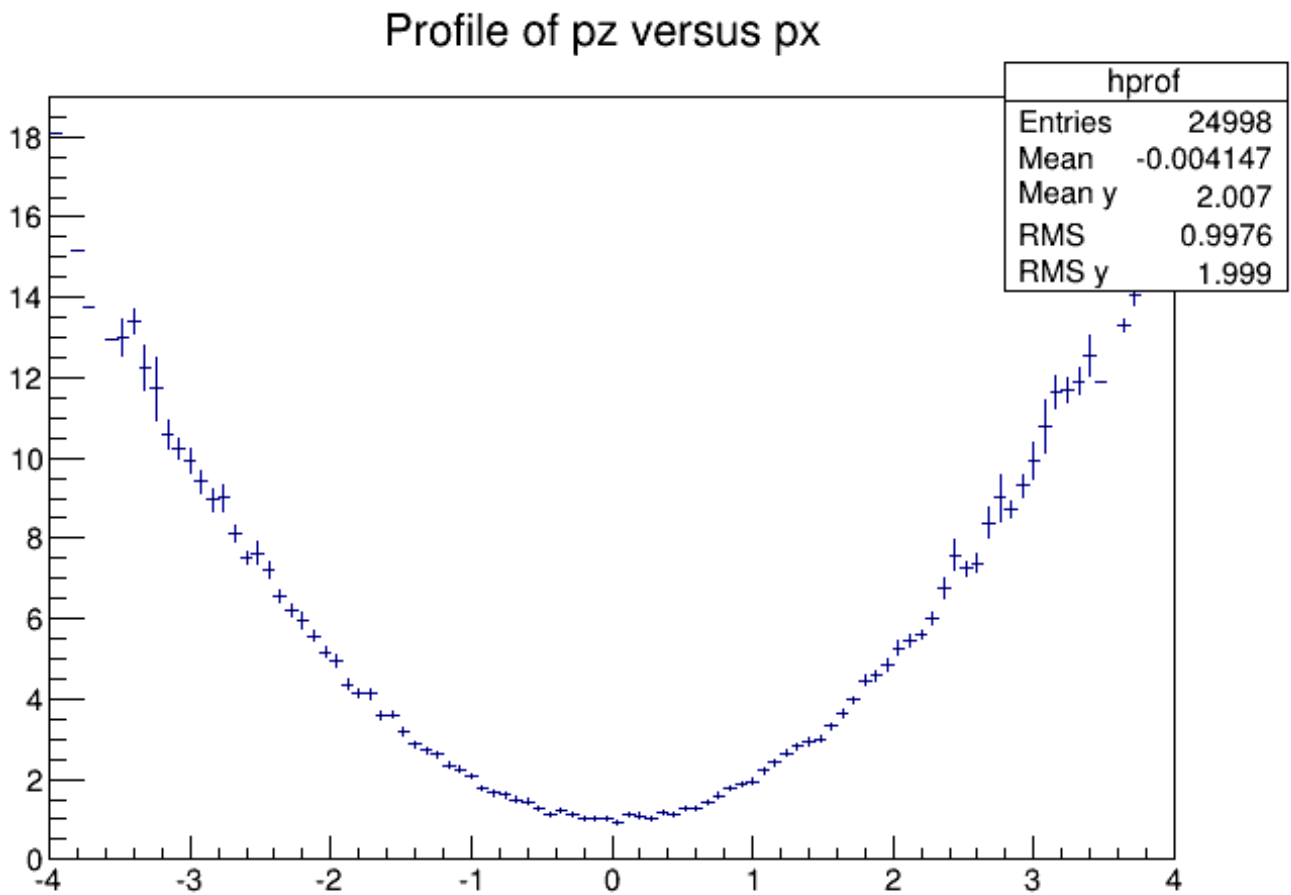

Figure 3.18: A profile histogram example

### 3.16.6 2D Profiles

The class for a 2D Profile is called `TProfile2D`. It is in many cases an elegant replacement of a three-dimensional histogram. The relationship of three measured quantities X, Y and Z can be visualized by a three-dimensional histogram or scatter-plot; its representation is not particularly satisfactory, except for sparse data. If Z is an unknown (but single-valued) function of (X,Y), it can be displayed with a `TProfile2D` with better precision than by a scatter-plot. A `TProfile2D` displays the mean value of Z and its RMS for each cell in X, Y. The following shows the cumulated contents (capital letters) and the values displayed (small letters) of the elements for cell  $i, j$ .

When you fill a profile histogram with `TProfile2D.Fill(x,y,z)`:

- $E[i, j]$  contains for each bin  $i, j$  the sum of the  $z$  values for this bin
- $L[i, j]$  contains the number of entries in the bin  $j$
- $e[j]$  or  $s[j]$  will be the resulting error depending on the selected option. See “Build Options”.

```
E[i, j] = sum z
L[i, j] = sum l
h[i, j] = H[i, j] / L[i, j]
s[i, j] = sqrt[E[i, j] / L[i, j] - h[i, j]**2]
e[i, j] = s[i, j] / sqrt[L[i, j]]
```

In the special case where  $s[i, j]$  is zero, when there is only one entry per cell,  $e[i, j]$  is computed from the average of the  $s[i, j]$  for all cells. This approximation is used to keep the cell during a fit operation.

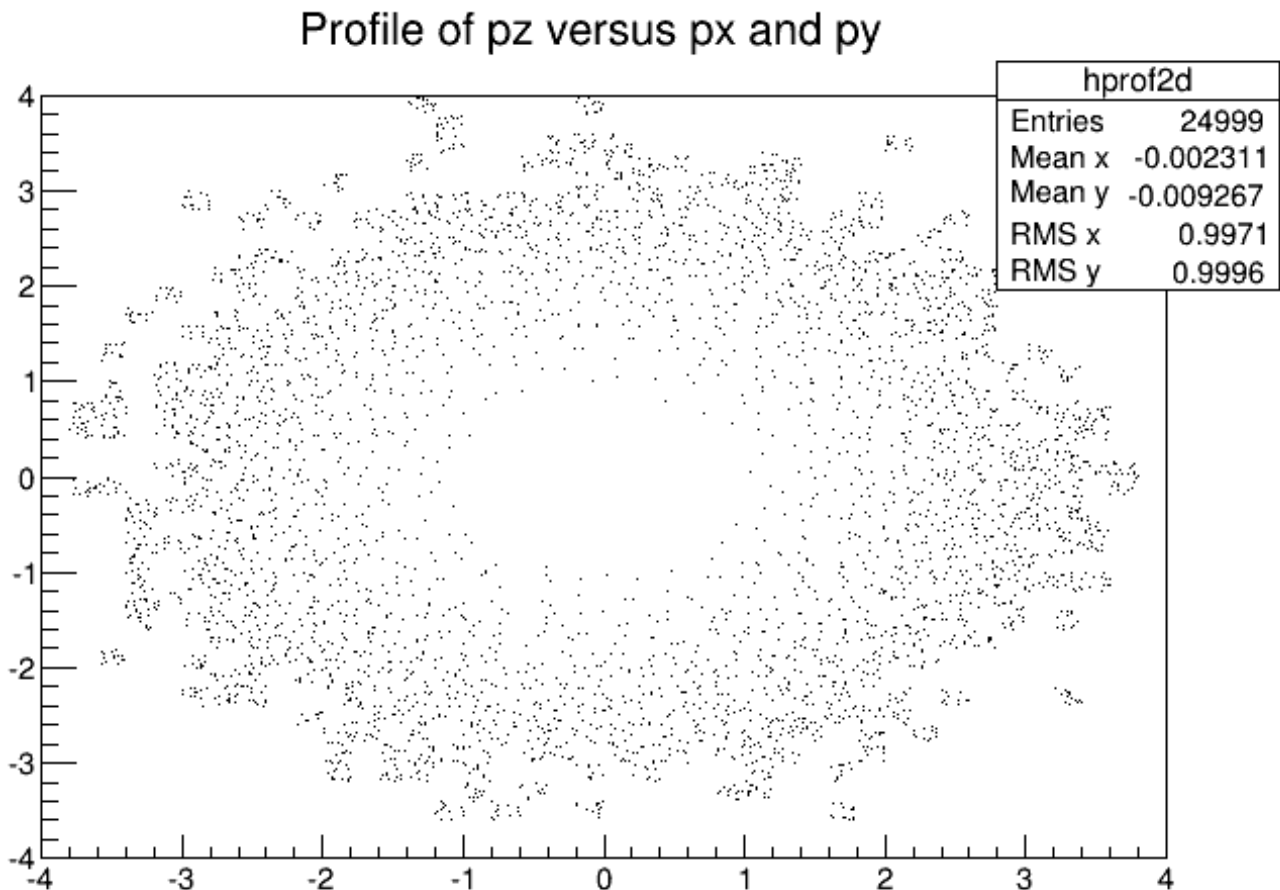

Figure 3.19: A `TProfile2D` histogram example

```

{
  // Creating a Canvas and a TProfile2D
  TCanvas *c1 = new TCanvas("c1",
                          "Profile histogram example",
                          200, 10,700,500);
  hprof2d = new TProfile2D("hprof2d",
                          "Profile of pz versus px and py",
                          40,-4,4,40,-4,4,0,20);

  // Filling the TProfile2D with 25000 points
  Float_t px, py, pz;
  for (Int_t i=0; i<25000; i++) {
    gRandom->Rannor(px,py);
    pz = px*px + py*py;
    hprof2d->Fill(px,py,pz,1);
  }
  hprof2d->Draw();
}

```

### 3.17 Iso Surfaces

Paint one Gouraud shaded 3d iso surface though a 3d histogram at the value computed as follow:  $\text{SumOfWeights}/(\text{NbinsX}*\text{NbinsY}*\text{NbinsZ})$

```

void hist3d() {
  TH3D *h3 = new TH3D("h3", "h3", 20, -2, 2, 20, -2, 2, 20, 0, 4);
  Double_t x,y,z;
  for (Int_t i=0; i<10000; i++) {
    gRandom->
    Rannor(x,y);
    z=x*x+y*y;
    h3->Fill(x,y,z);
  }
  h3->Draw("iso");
}

```

### 3.18 3D Implicit Functions

```

TF3 *fun3 = new TF3("fun3","sin(x*x+y*y+z*z-36)",-2,2,-2,2,-2,2);
fun3->Draw();

```

### 3.19 TPie

The **TPie** class allows to create a Pie Chart representation of a one dimensional data set. The data can come from an array of `Double_t` (or `Float_t`) or from a 1D-histogram. The possible options to draw a **TPie** are:

- “R” Paint the labels along the central “R”adius of slices.
- “T” Paint the labels in a direction “T”angent to circle that describes the **TPie**.
- “3D” Draw the pie-chart with a pseudo 3D effect.
- “NOL” No OutLine: do not draw the slices’ outlines; any property over the slices’ line is ignored.

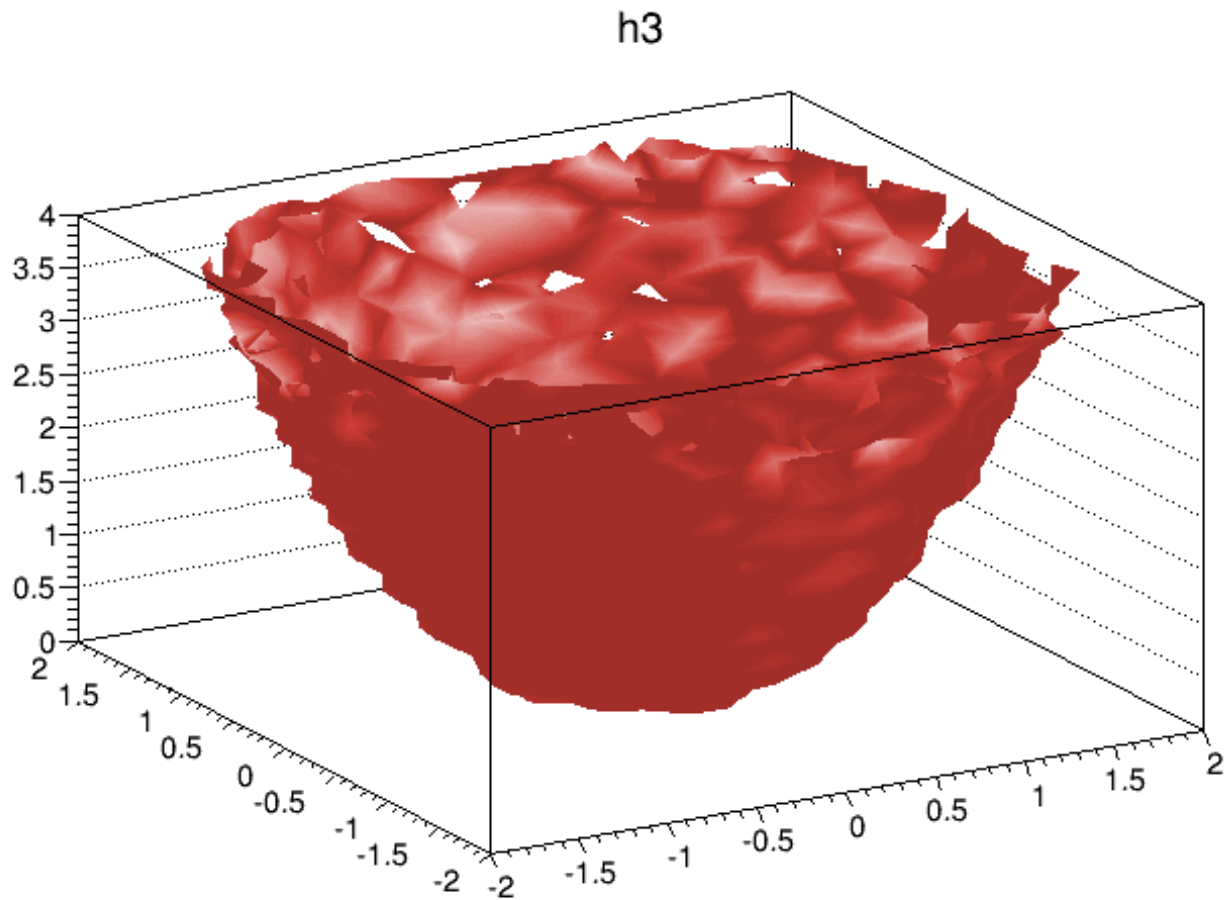

Figure 3.20: Iso surfaces

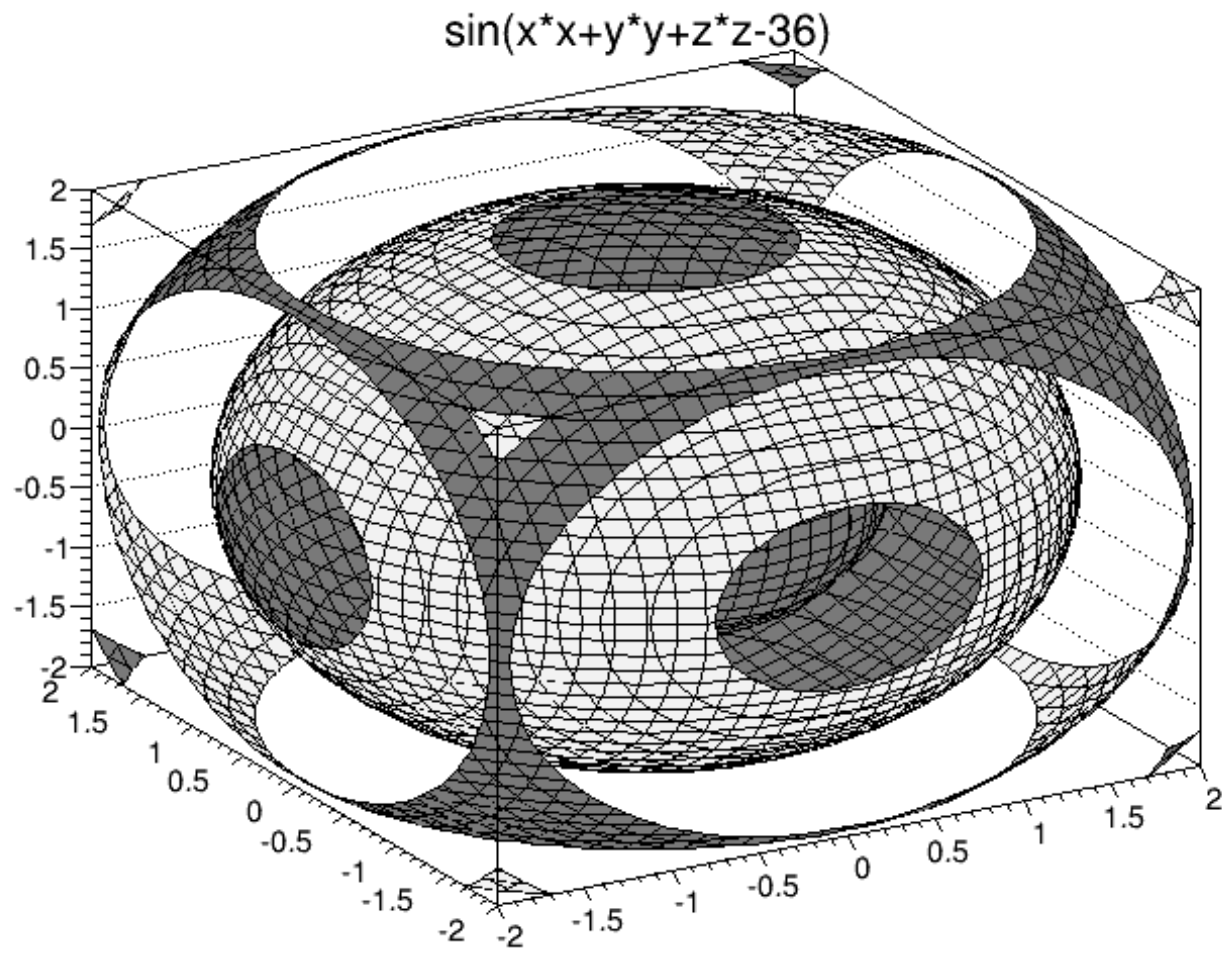

Figure 3.21: 3D implicit function

The method `SetLabelFormat()` is used to customize the label format. The format string must contain one of these modifiers:

- – `%txt` : to print the text label associated with the slice
- – `%val` : to print the numeric value of the slice
- – `%frac` : to print the relative fraction of this slice
- – `%perc` : to print the % of this slice

```
myPie->SetLabelFormat("%txt (%frac)");
```

See the macro `$ROOTSYS/tutorials/graphics/piechart.C`.

## 3.20 The User Interface for Histograms

The classes `TH1Editor` and `TH2Editor` provides the user interface for setting histogram's attributes and rebinning interactively.

### 3.20.1 TH1Editor

#### 3.20.1.1 The Style Tab

**3.20.1.1.1 Title** sets the title of the histogram.

**3.20.1.1.2 Plot** draw a 2D or 3D plot; according to the dimension, different drawing possibilities can be set.

**3.20.1.1.3 Error** add different error bars to the histogram (no errors, simple, etc.).

**3.20.1.1.4 Add** further things which can be added to the histogram (None, simple/smooth line, fill area, etc.)

#### 3.20.1.2 2-D Plot

**3.20.1.2.1 Simple Drawing** draw a simple histogram without errors (= "HIST" draw option). In combination with some other draw options an outer line is drawn on top of the histogram

**3.20.1.2.2 Show markers** draw a marker on top of each bin (= "P" draw option).

**3.20.1.2.3 Draw bar chart** draw a bar chart (= "B" draw option).

**3.20.1.2.4 Bar option** draw a bar chart (= "BAR" draw option); if selected, it will show an additional interface elements for bars: width, offset, percentage and the possibility to draw horizontal bars.

#### 3.20.1.3 3-D Plot

**3.20.1.3.1 Add** set histogram type Lego-Plot or Surface draw (Lego, Lego1.2, Surf, Surf1...5).

**3.20.1.3.2 Coords** set the coordinate system (Cartesian, Spheric, etc.).

**3.20.1.3.3 Error** same as for 2D plot.

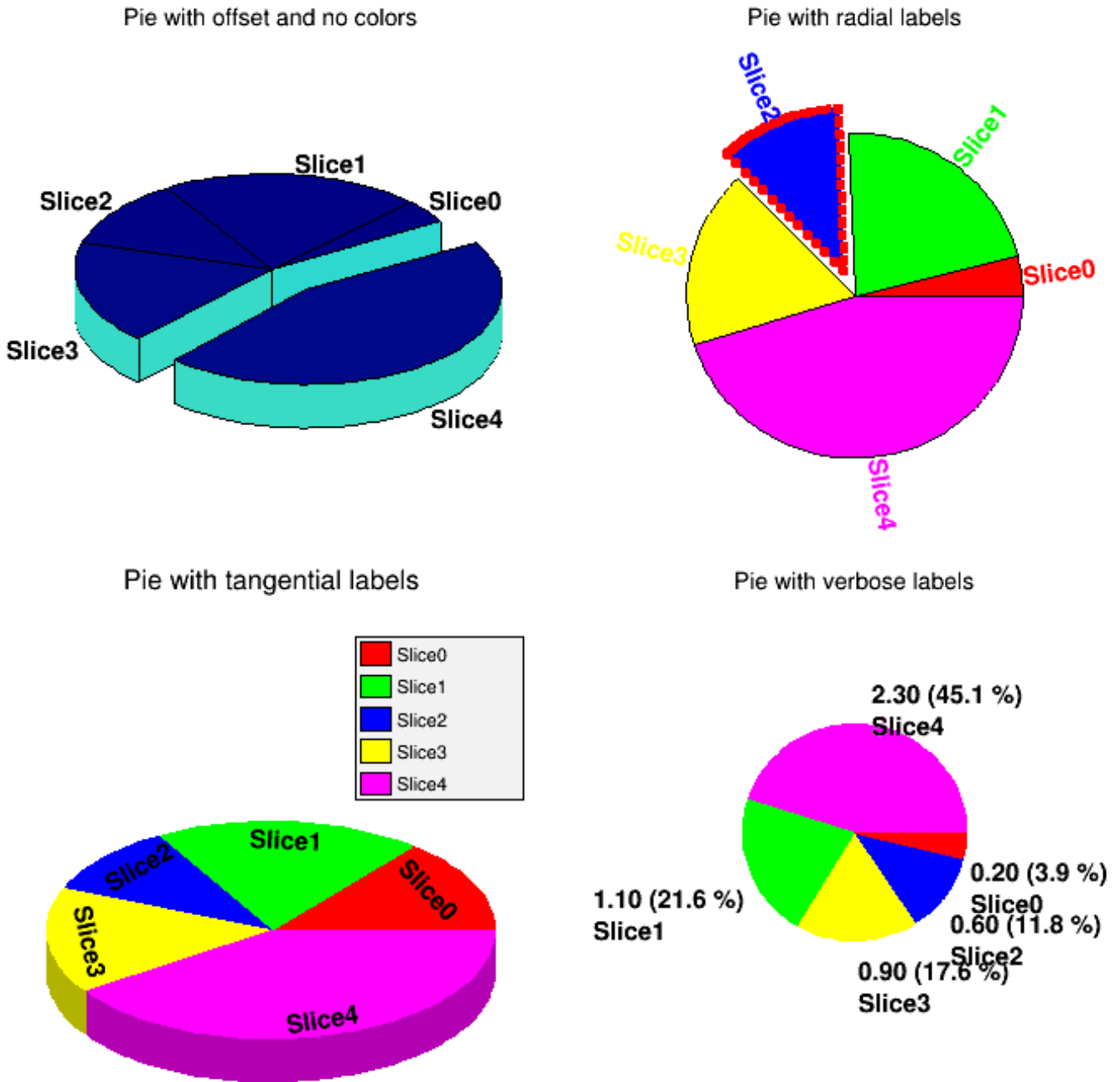
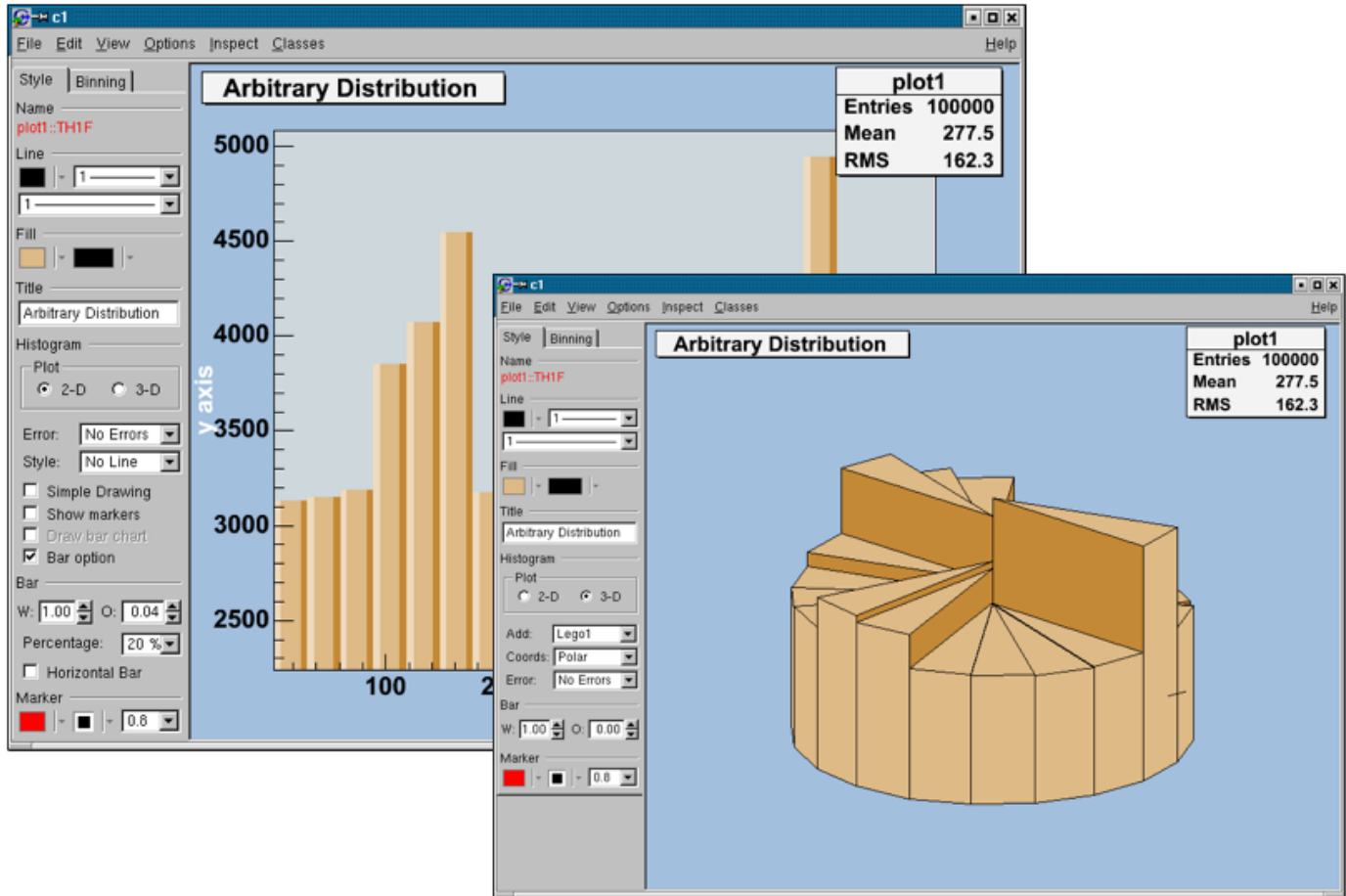

Figure 3.22: The picture generated by tutorial macro piechart.C



**3.20.1.3.4 Bar** set the bar attributes: width and offset.

**3.20.1.3.5 Horizontal Bar** draw a horizontal bar chart.

### 3.20.1.4 The Binning tab

The binning tab has two different layouts. One is for a histogram, which is not drawn from an ntuple. The other one is available for a histogram, which is drawn from an ntuple. In this case, the rebin algorithm can create a rebinned histogram from the original data i.e. the ntuple.

To see the differences do:

```
TFile f("hsimple.root");
hpx->Draw("BAR1"); // non ntuple histogram
ntuple->Draw("px");// ntuple histogram
```

### 3.20.1.5 Non ntuple histogram

Rebin with a slider and the number of bins (shown in the field below the slider). The number of bins can be changed to any number, which divides the number of bins of the original histogram. A click on the Apply button will delete the origin histogram and will replace it by the rebinned one on the screen. A click on the Ignore button will restore the origin histogram.

### 3.20.1.6 Histogram drawn from an ntuple

**3.20.1.6.1 Rebin** with the slider, the number of bins can be enlarged by a factor of 2, 3, 4, 5 (moving to the right) or reduced by a factor of  $\frac{1}{2}$ ,  $\frac{1}{3}$ ,  $\frac{1}{4}$ ,  $\frac{1}{5}$ .



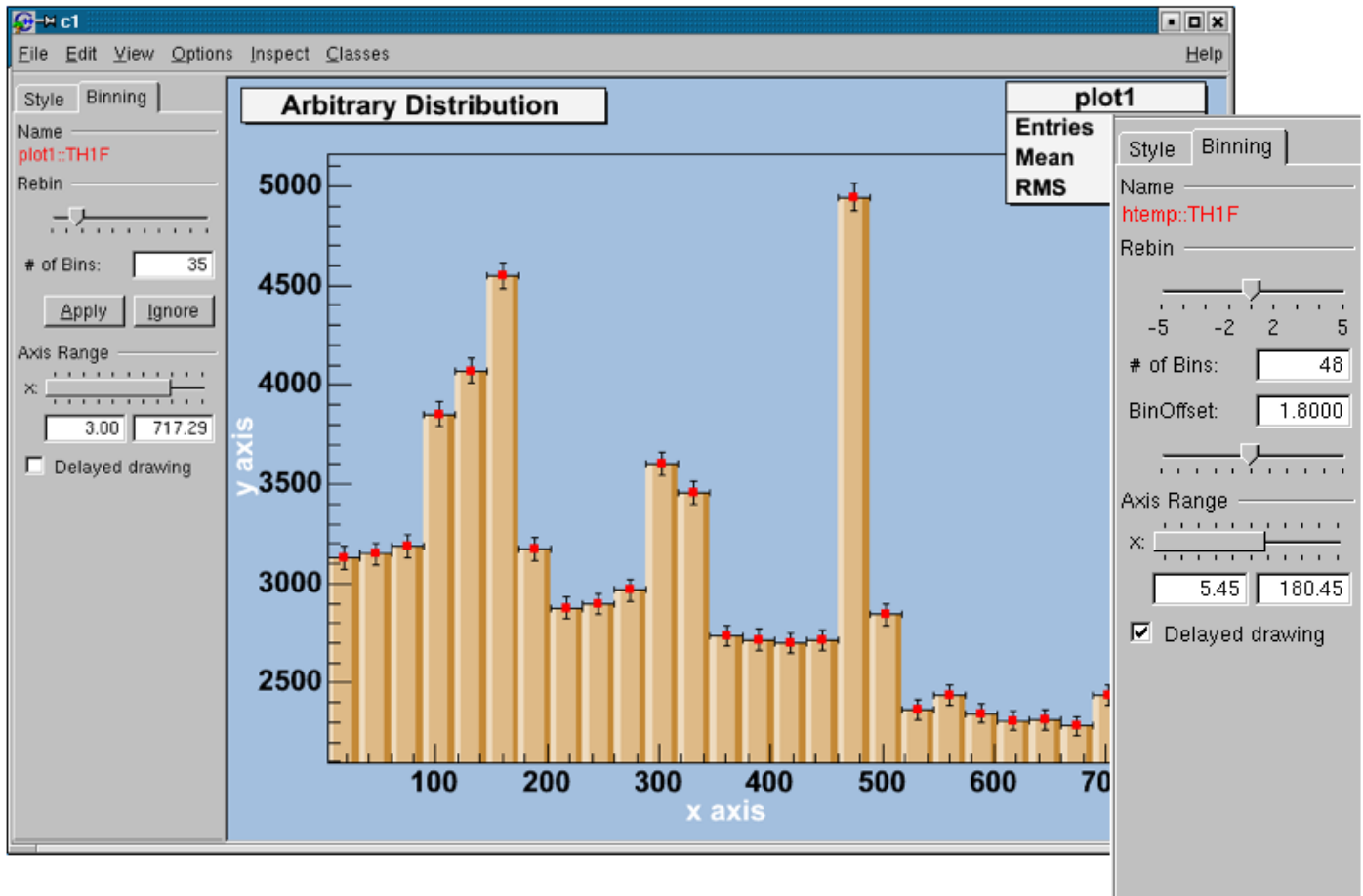

**3.20.1.6.2 BinOffset with a BinOffset slider** the origin of the histogram can be changed within one binwidth. Using this slider the effect of binning the data into bins can be made visible (statistical fluctuations).

**3.20.1.6.3 Axis Range** with a double slider it is possible to zoom into the specified axis range. It is also possible to set the upper and lower limit in fields below the slider.

**3.20.1.6.4 Delayed drawing** all the Binning sliders can be set to delay draw mode. Then the changes on the histogram are only updated, when the Slider is released. This should be activated if the redrawing of the histogram is time consuming.

## 3.20.2 TH2Editor

### 3.20.2.1 Style Tab:

**3.20.2.1.1 Title** set the title of the histogram

**3.20.2.1.2 Histogram** change the draw options of the histogram.

**3.20.2.1.3 Plot** draw a 2D or 3D plot of the histogram; according to the dimension, the drawing possibilities are different.

### 3.20.2.2 2-D Plot

**3.20.2.2.1 Contour** draw a contour plot (None, Cont0...5)

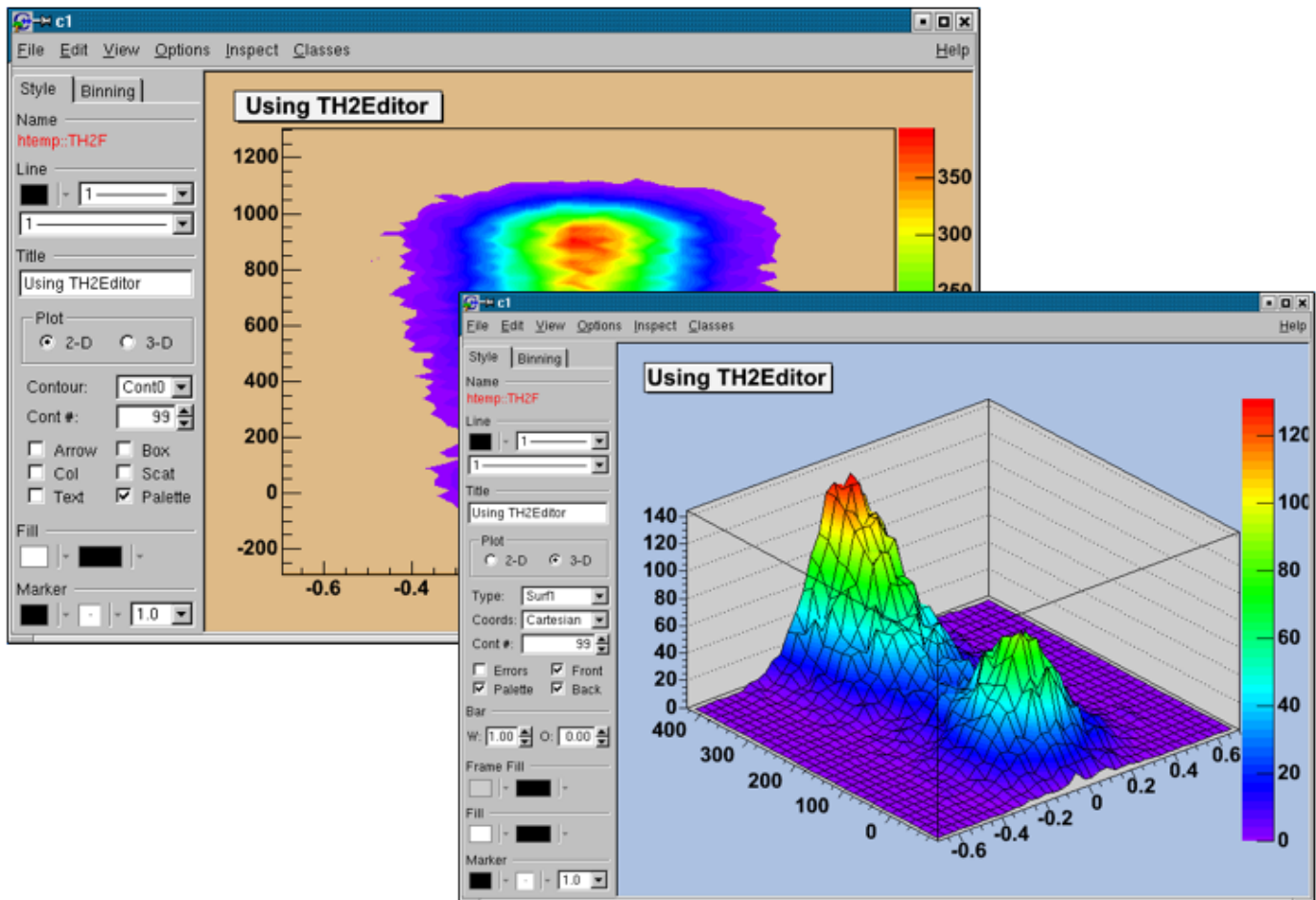

**3.20.2.2.2 Cont #** set the number of Contours;

**3.20.2.2.3 Arrow** set the arrow mode and shows the gradient between adjacent cells;

**3.20.2.2.4 Col** a box is drawn for each cell with a color scale varying with contents;

**3.20.2.2.5 Text** draw bin contents as text;

**3.20.2.2.6 Box** a box is drawn for each cell with surface proportional to contents;

**3.20.2.2.7 Scat** draw a scatter-plot (default);

**3.20.2.2.8 Palette** the color palette is drawn.

### 3.20.2.3 3-D Plot

**3.20.2.3.1 Type** set histogram type to Lego or surface plot; draw (Lego, Lego1.2, Surf, Surf1...5)

**3.20.2.3.2 Coords** set the coordinate system (Cartesian, Spheric, etc.);

**3.20.2.3.3 Cont #** set the number of Contours (for e.g. Lego2 draw option);

**3.20.2.3.4 Errors** draw errors in a Cartesian lego plot;

**3.20.2.3.5 Palette** draw the color palette;

**3.20.2.3.6 Front** draw the front box of a Cartesian lego plot;

**3.20.2.3.7 Back** draw the back box of a Cartesian lego plot;

**3.20.2.3.8 Bar** change the bar attributes: the width and offset.

### 3.20.2.4 Rebinning Tab

The Rebinning tab has two different layouts. One is for a histogram that is not drawn from an ntuple; the other one is available for a histogram, which is drawn from an ntuple. In this case, the rebin algorithm can create a rebinned histogram from the original data i.e. the ntuple. To see the differences do for example:

```
TFile f ("hsimple.root");
hpxpy->Draw("Lego2"); // non ntuple histogram
ntuple->Draw("px:py","", "Lego2"); // ntuple histogram
```

### 3.20.2.5 Non-ntuple histogram:

Rebin with sliders (one for the x, one for the y-axis) and the number of bins (shown in the field below them can be changed to any number, which divides the number of bins of the original histogram. Selecting the Apply button will delete the origin histogram and will replace it by the rebinned one on the screen. Selecting the Ignore the origin histogram will be restored.

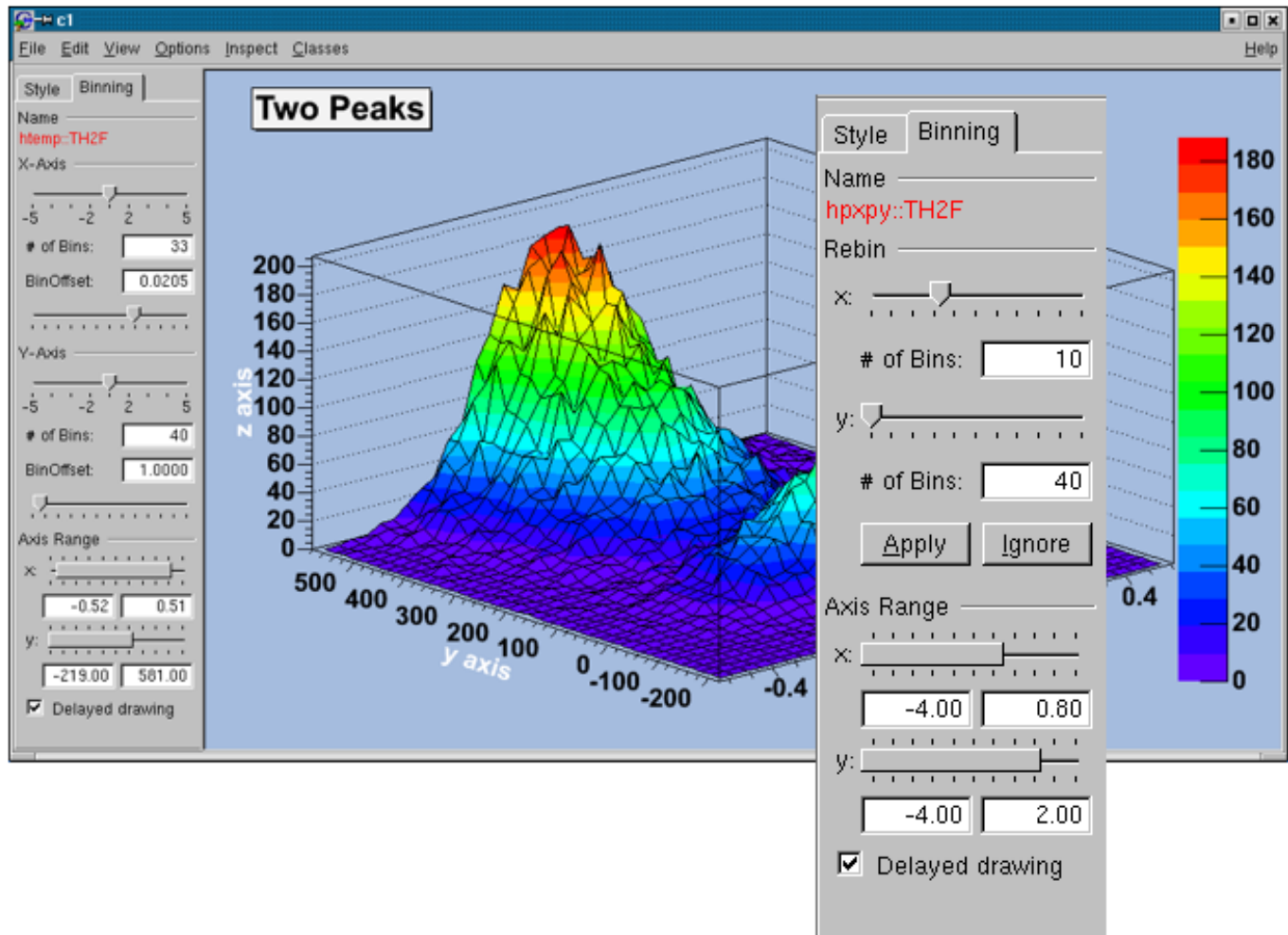

### 3.20.2.6 Histogram drawn from an ntuple

**3.20.2.6.1 Rebin** with the sliders the number of bins can be enlarged by a factor of 2,3,4,5 (moving to the right) or reduced by a factor of  $\frac{1}{2}$ ,  $\frac{1}{3}$ ,  $\frac{1}{4}$ ,  $\frac{1}{5}$ .

**3.20.2.6.2 BinOffset** with the BinOffset slider the origin of the histogram can be changed within one binwidth. Using this slider the effect of binning the data into bins can be made visible (=> statistical fluctuations).

**3.20.2.6.3 Axis Range** with a double slider that gives the possibility for zooming. It is also possible to set the upper and lower limit in fields below the slider.

**3.20.2.6.4 Delayed drawing** all the binning sliders can be set to delay draw mode. Then the changes on the histogram are only updated, when the Slider is released. This should be activated if the redrawing of the histogram is too time consuming.



# Chapter 4

## Graphs

A graph is a graphics object made of two arrays X and Y, holding the x,y coordinates of **n** points. There are several graph classes; they are **TGraph**, **TGraphErrors**, **TGraphAsymmErrors**, and **TMultiGraph**.

### 4.1 TGraph

The **TGraph** class supports the general case with non-equidistant points, and the special case with equidistant points. Graphs are created with the **TGraph** constructor. First, we define the arrays of coordinates and then create the graph. The coordinates can be arrays of doubles or floats.

```
Int_t n = 20;
Double_t x[n], y[n];
for (Int_t i=0; i<n; i++) {
    x[i] = i*0.1;
    y[i] = 10*sin(x[i]+0.2);
}
TGraph *gr1 = new TGraph (n, x, y);
```

An alternative constructor takes only the number of points **n**. It is expected that the coordinates will be set later.

```
TGraph *gr2 = new TGraph(n);
```

The default constructor can also be used. Further calls to **SetPoint()** will extend the internal vectors.

```
TGraph *gr3 = new TGraph();
```

#### 4.1.1 Graph Draw Options

The various drawing options for a graph are explained in **TGraph::PaintGraph**. They are:

- “L” A simple poly-line between every points is drawn
- “F” A fill area is drawn
- “F1” Idem as “F” but fill area is no more repartee around X=0 or Y=0
- “F2” draw a fill area poly line connecting the center of bins
- “A” Axis are drawn around the graph
- “C” A smooth curve is drawn

- “\*” A star is plotted at each point
- “P” The current marker of the graph is plotted at each point
- “B” A bar chart is drawn at each point
- “[ ]” Only the end vertical/horizontal lines of the error bars are drawn. This option only applies to the `TGraphAsymmErrors`.
- “1” `ylo = rwymin`

The options are not case sensitive and they can be concatenated in most cases. Let us look at some examples.

#### 4.1.1.1 Continuous Line, Axis and Stars (AC\*)

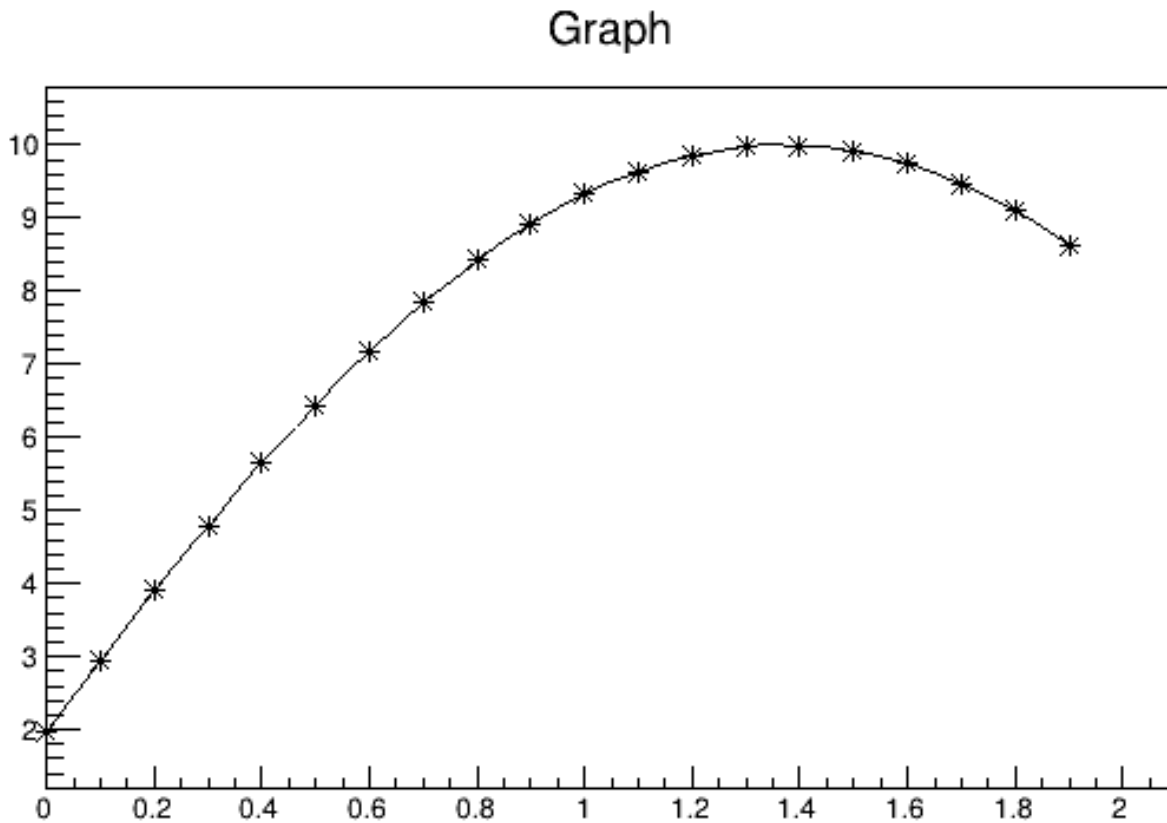

Figure 4.1: A graph drawn with axis, \* markers and continuous line (option AC\*)

```
{
  Int_t n = 20;
  Double_t x[n], y[n];
  for (Int_t i=0;i<n;i++) {
    x[i] = i*0.1;
    y[i] = 10*sin(x[i]+0.2);
  }

  // create graph
  TGraph *gr = new TGraph(n,x,y);
  TCanvas *c1 = new TCanvas("c1","Graph Draw Options",
                           200,10,600,400);
```



```

// draw the graph with axis, continuous line, and put
// a * at each point
gr->Draw("AC*");
}

```

#### 4.1.1.2 Bar Graphs (AB)

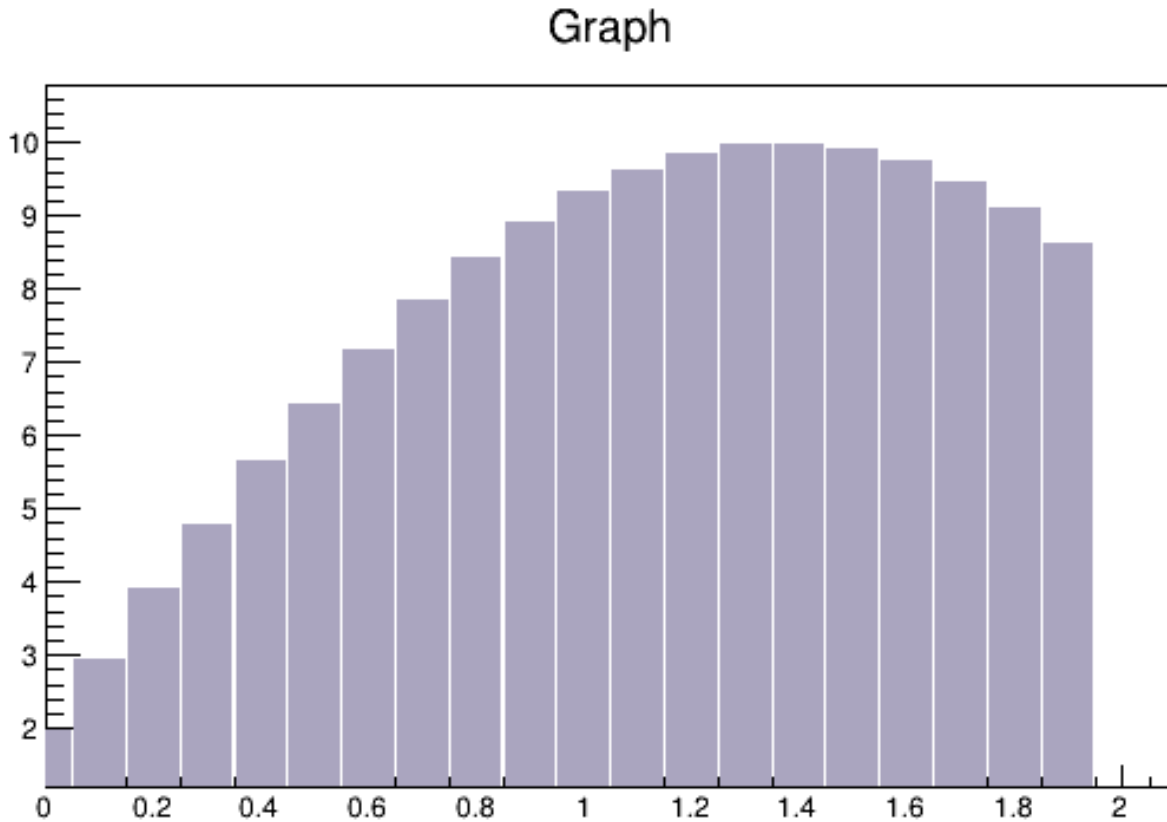

Figure 4.2: A graph drawn with axis and bar (option AB)

```

root[] TGraph *gr1 = new TGraph(n,x,y);
root[] gr1->SetFillColor(40);
root[] gr1->Draw("AB");

```

This code will only work if  $n$ ,  $x$ , and  $y$  is defined. The previous example defines these. You need to set the fill color, because by default the fill color is white and will not be visible on a white canvas. You also need to give it an axis, or the bar chart will not be displayed properly.

#### 4.1.1.3 Filled Graphs (AF)

```

root[] TGraph *gr3 = new TGraph(n,x,y);
root[] gr3->SetFillColor(45);
root[] gr3->Draw("AF")

```

This code will only work if  $n$ ,  $x$ , and  $y$  are defined. The first example defines them. You need to set the fill color, because by default the fill color is white and will not be visible on a white canvas. You also need to give it an axis, or the filled polygon will not be displayed properly.

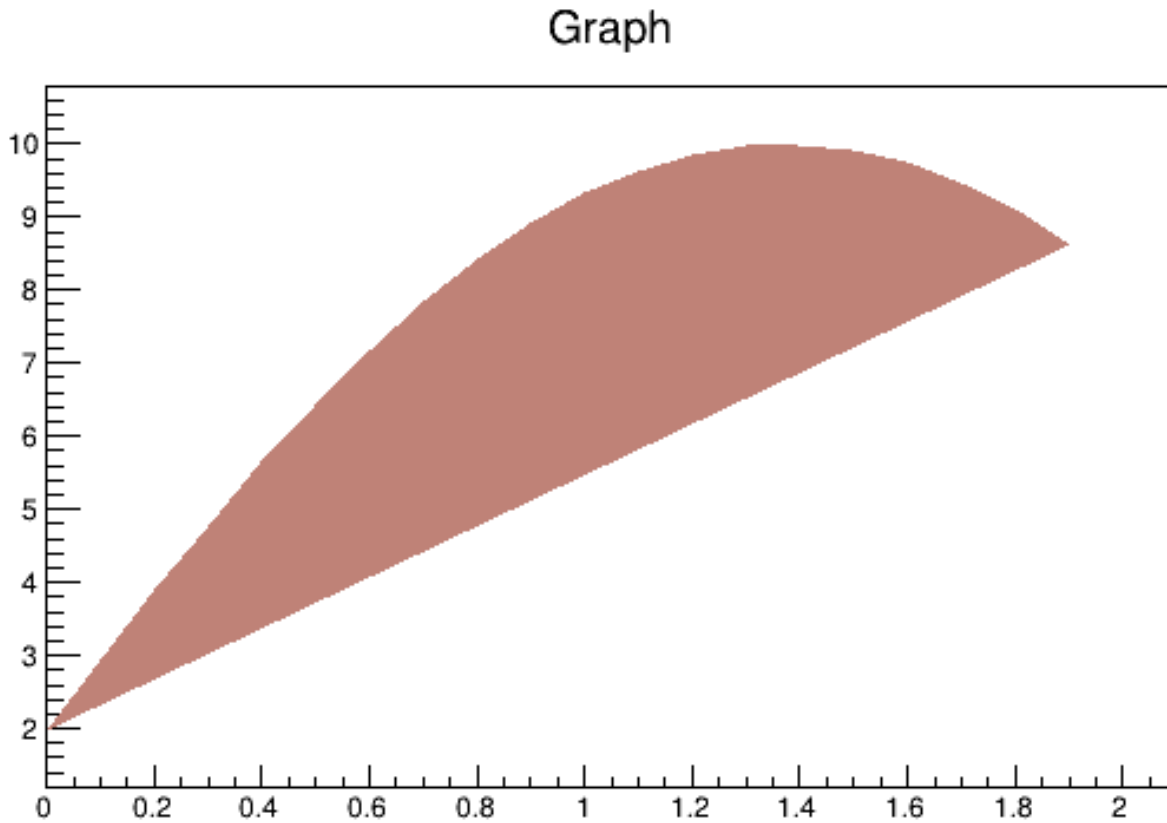

Figure 4.3: A graph drawn with axis and fill (option AF)

#### 4.1.1.4 Marker Options

```
{
  Int_t n = 20;
  Double_t x[n], y[n];

  // build the arrays with the coordinate of points
  for (Int_t i=0; i<n; i++) {
    x[i] = i*0.1;
    y[i] = 10*sin(x[i]+0.2);
  }

  // create graphs
  TGraph *gr3 = new TGraph(n,x,y);
  TCanvas *c1 = new TCanvas ("c1","Graph Draw Options",
                             200,10,600,400);

  // draw the graph with the axis,contineous line, and put
  // a marker using the graph's marker style at each point
  gr3->SetMarkerStyle(21);
  c1->cd(4);
  gr3->Draw("APL");

  // get the points in the graph and put them into an array
  Double_t *nx = gr3->GetX();
  Double_t *ny = gr3->GetY();

  // create markers of different colors
```

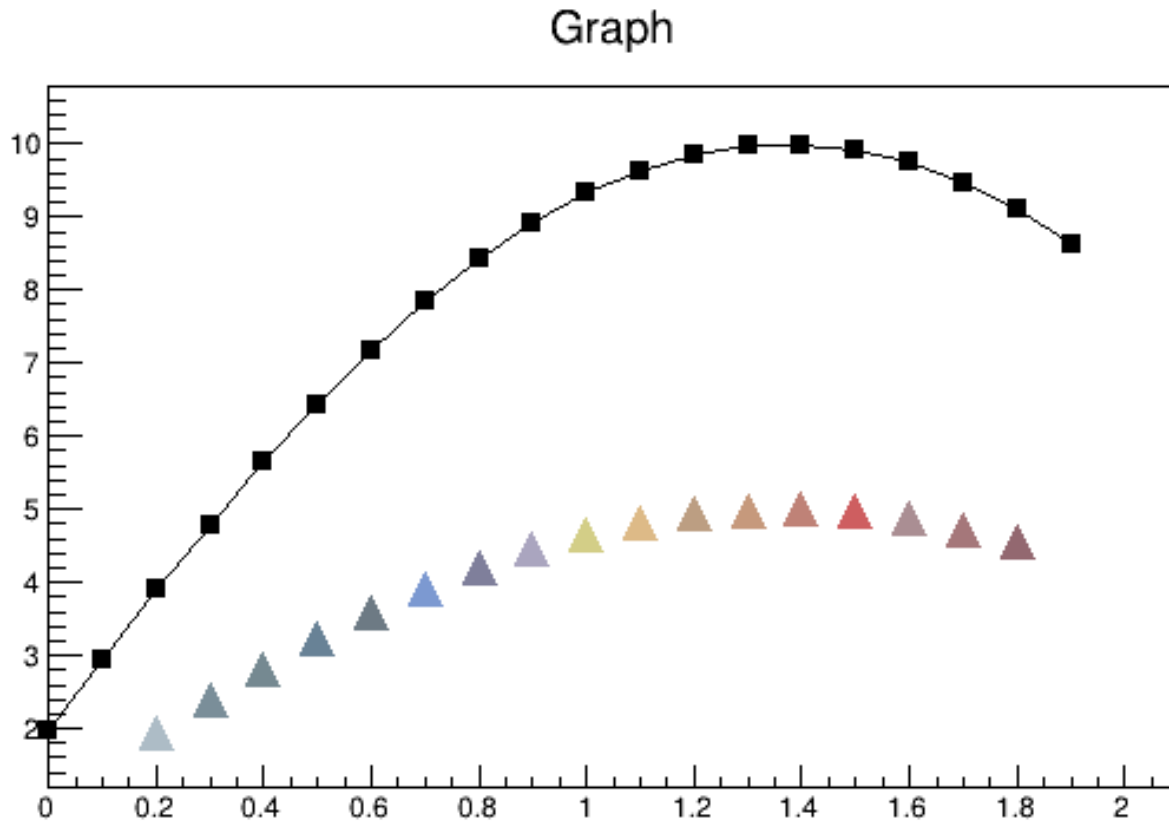

Figure 4.4: Graph markers created in different ways

```

for (Int_t j=2; j<n-1; j++) {
  TMarker *m = new TMarker(nx[j], 0.5*ny[j], 22);
  m->SetMarkerSize(2);
  m->SetMarkerColor(31+j);
  m->Draw();
}
}

```

## 4.2 Superimposing Two Graphs

To super impose two graphs you need to draw the axis only once, and leave out the “A” in the draw options for the second graph. Next is an example:

```

{
  Int_t n = 20;
  Double_t x[n], y[n], x1[n], y1[n];

  // create a blue graph with a cos function
  gr1->SetLineColor(4);
  gr1->Draw("AC*");

  // superimpose the second graph by leaving out the axis option "A"
  gr2->SetLineWidth(3);
  gr2->SetMarkerStyle(21);
  gr2->SetLineColor(2);
}

```

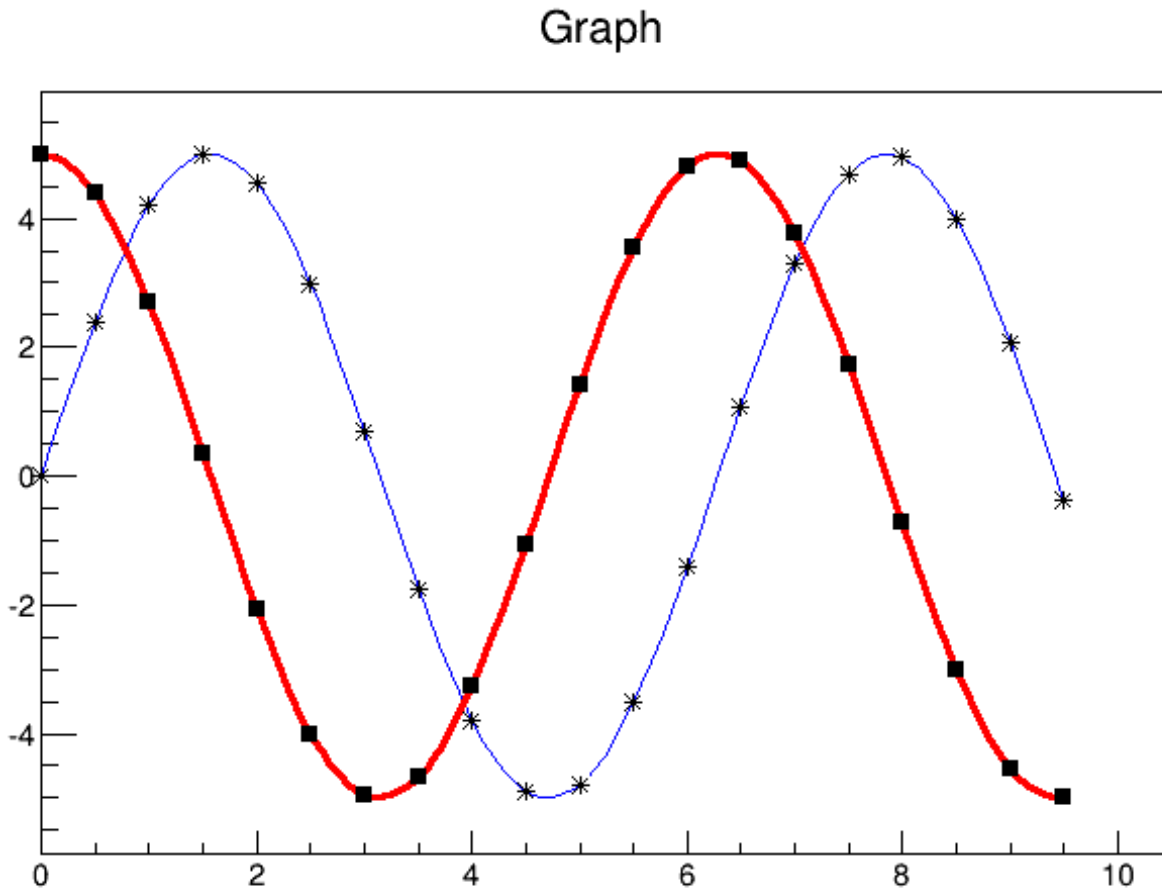

Figure 4.5: Superimposing two graphs

```
gr2->Draw("CP");
}
```

### 4.3 Graphs with Error Bars

A `TGraphErrors` is a `TGraph` with error bars. The various draw format options of `TGraphErrors::Paint()` are derived from `TGraph`.

```
void TGraphErrors::Paint(Option_t *option)
```

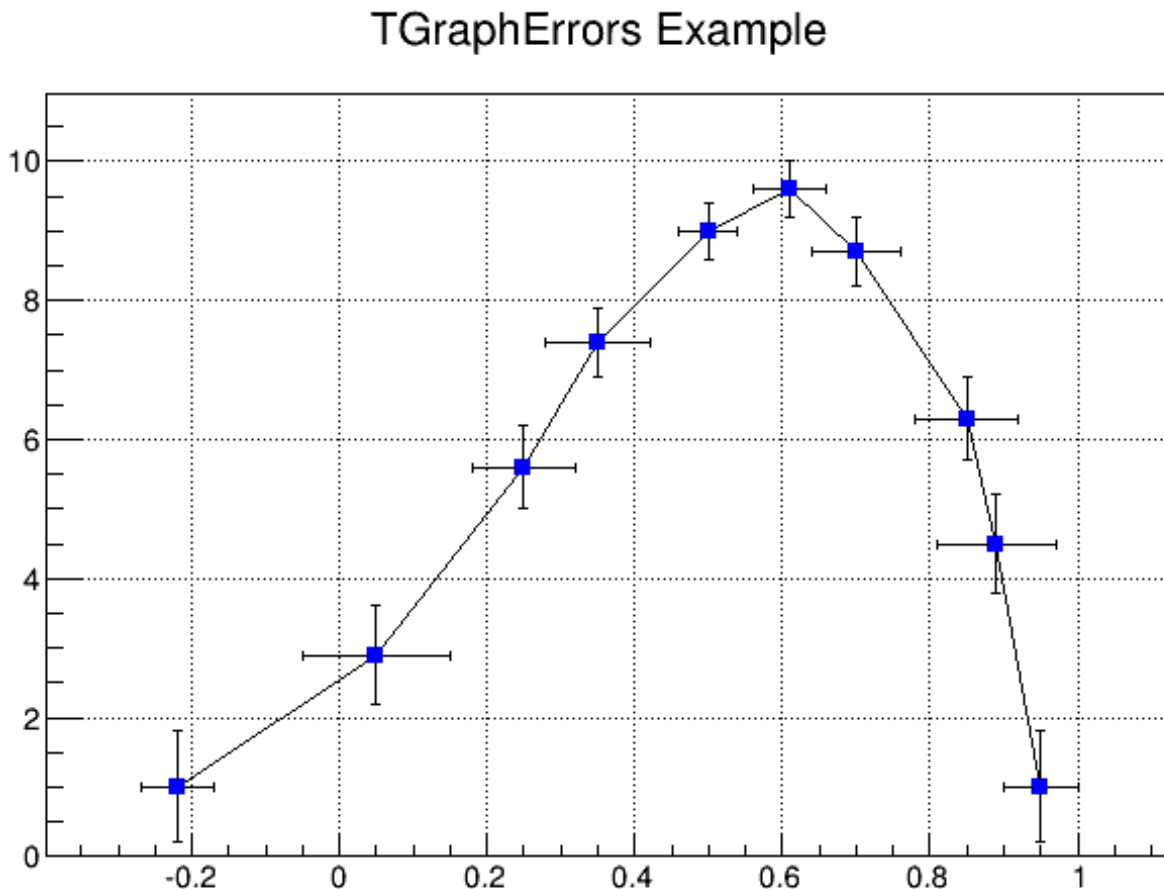

Figure 4.6: Graphs with different draw options of error bars

In addition, it can be drawn with the “Z” option to leave off the small lines at the end of the error bars. If option contains “>”, an arrow is drawn at the end of the error bars. If option contains “|>”, a full arrow is drawn at the end of the error bars. The size of the arrow is set to 2/3 of the marker size.

The option “[” is interesting to superimpose systematic errors on top of the graph with the statistical errors. When it is specified, only the end vertical/horizontal lines of the error bars are drawn.

To control the size of the lines at the end of the error bars (when option 1 is chosen) use `SetEndErrorSize(np)`. By default `np=1`; `np` represents the number of pixels.

```
gStyle->SetEndErrorSize(np);
```

The four parameters of `TGraphErrors` are: `X`, `Y` (as in `TGraph`), `X-errors`, and `Y-errors` - the size of the errors in the `x` and `y` direction. Next example is `$ROOTSYS/tutorials/graphs/gerrors.C`.

```

{
  c1 = new TCanvas("c1","A Simple Graph with error bars",200,10,700,500);
  c1->SetGrid();

  // create the coordinate arrays
  Int_t n = 10;
  Float_t x[n] = {-.22,.05,.25,.35,.5,.61,.7,.85,.89,.95};
  Float_t y[n] = {1,2.9,5.6,7.4,9,9.6,8.7,6.3,4.5,1};

  // create the error arrays
  Float_t ex[n] = {.05,.1,.07,.07,.04,.05,.06,.07,.08,.05};
  Float_t ey[n] = {.8,.7,.6,.5,.4,.4,.5,.6,.7,.8};

  // create the TGraphErrors and draw it
  gr = new TGraphErrors(n,x,y,ex,ey);
  gr->SetTitle("TGraphErrors Example");
  gr->SetMarkerColor(4);
  gr->SetMarkerStyle(21);
  gr->Draw("ALP");
  c1->Update();
}

```

#### 4.4 Graphs with Asymmetric Error Bars

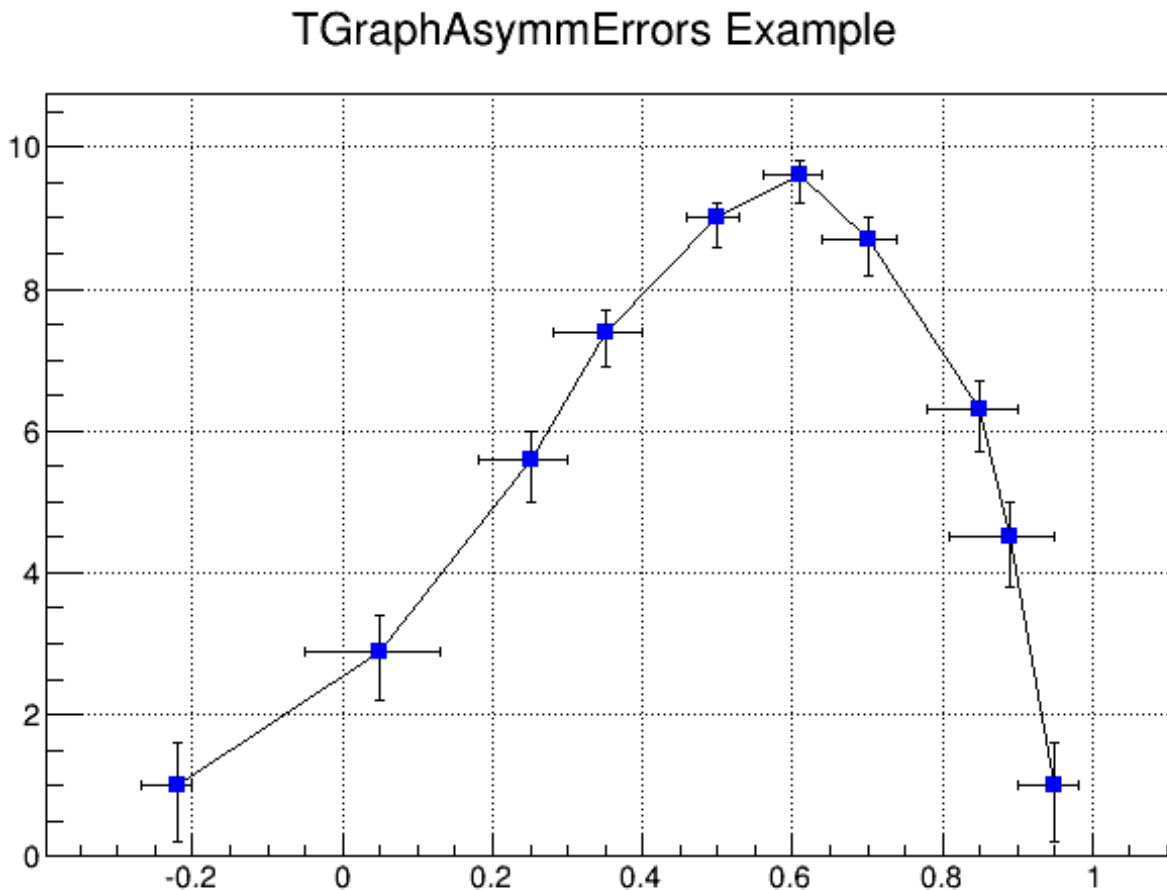

Figure 4.7: A graph with asymmetric error bars

A **TGraphAsymmErrors** is a **TGraph** with asymmetric error bars. It inherits the various draw format options from **TGraph**. Its method `Paint(Option_t *option)` paints the **TGraphAsymmErrors** with the current attributes. You can set the following additional options for drawing:

- “z” or “Z” the horizontal and vertical small lines are not drawn at the end of error bars
- “>” an arrow is drawn at the end of the error bars
- “|>” a full arrow is drawn at the end of the error bar; its size is  $\frac{2}{3}$  of the marker size
- “[ ]” only the end vertical/horizontal lines of the error bars are drawn; this option is interesting to superimpose systematic errors on top of a graph with statistical errors.

The constructor has six arrays as parameters: X and Y as **TGraph** and low X-errors and high X-errors, low Y-errors and high Y-errors. The low value is the length of the error bar to the left and down, the high value is the length of the error bar to the right and up.

```
{
  c1 = new TCanvas("c1","A Simple Graph with error bars",
                  200,10,700,500);
  c1->SetGrid();

  // create the arrays for the points
  Int_t n = 10;
  Double_t x[n] = {-0.22,.05,.25,.35,.5, .61,.7,.85,.89,.95};
  Double_t y[n] = {1,2.9,5.6,7.4,9,9.6,8.7,6.3,4.5,1};

  // create the arrays with high and low errors
  Double_t exl[n] = {.05,.1,.07,.07,.04,.05,.06,.07,.08,.05};
  Double_t eyl[n] = {.8,.7,.6,.5,.4,.4,.5,.6,.7,.8};
  Double_t exh[n] = {.02,.08,.05,.05,.03,.03,.04,.05,.06,.03};
  Double_t eyh[n] = {.6,.5,.4,.3,.2,.2,.3,.4,.5,.6};

  // create TGraphAsymmErrors with the arrays
  gr = new TGraphAsymmErrors(n,x,y,exl,exh,eyl,eyh);
  gr->SetTitle("TGraphAsymmErrors Example");
  gr->SetMarkerColor(4);
  gr->SetMarkerStyle(21);
  gr->Draw("ALP");
}
```

## 4.5 Graphs with Asymmetric Bent Errors

A **TGraphBentErrors** is a **TGraph** with bent, asymmetric error bars. The various format options to draw a **TGraphBentErrors** are explained in **TGraphBentErrors::Paint** method. The **TGraphBentErrors** is drawn by default with error bars and small horizontal and vertical lines at the end of the error bars. If option “z” or “Z” is specified, these small lines are not drawn. If the option “X” is specified, the errors are not drawn (the **TGraph::Paint** method equivalent).

- if option contains “>”, an arrow is drawn at the end of the error bars
- if option contains “|>”, a full arrow is drawn at the end of the error bars
- the size of the arrow is set to  $\frac{2}{3}$  of the marker size
- if option “[ ]” is specified, only the end vertical/horizontal lines of the error bars are drawn. This option is interesting to superimpose systematic errors on top of a graph with statistical errors.

This figure has been generated by the following macro:

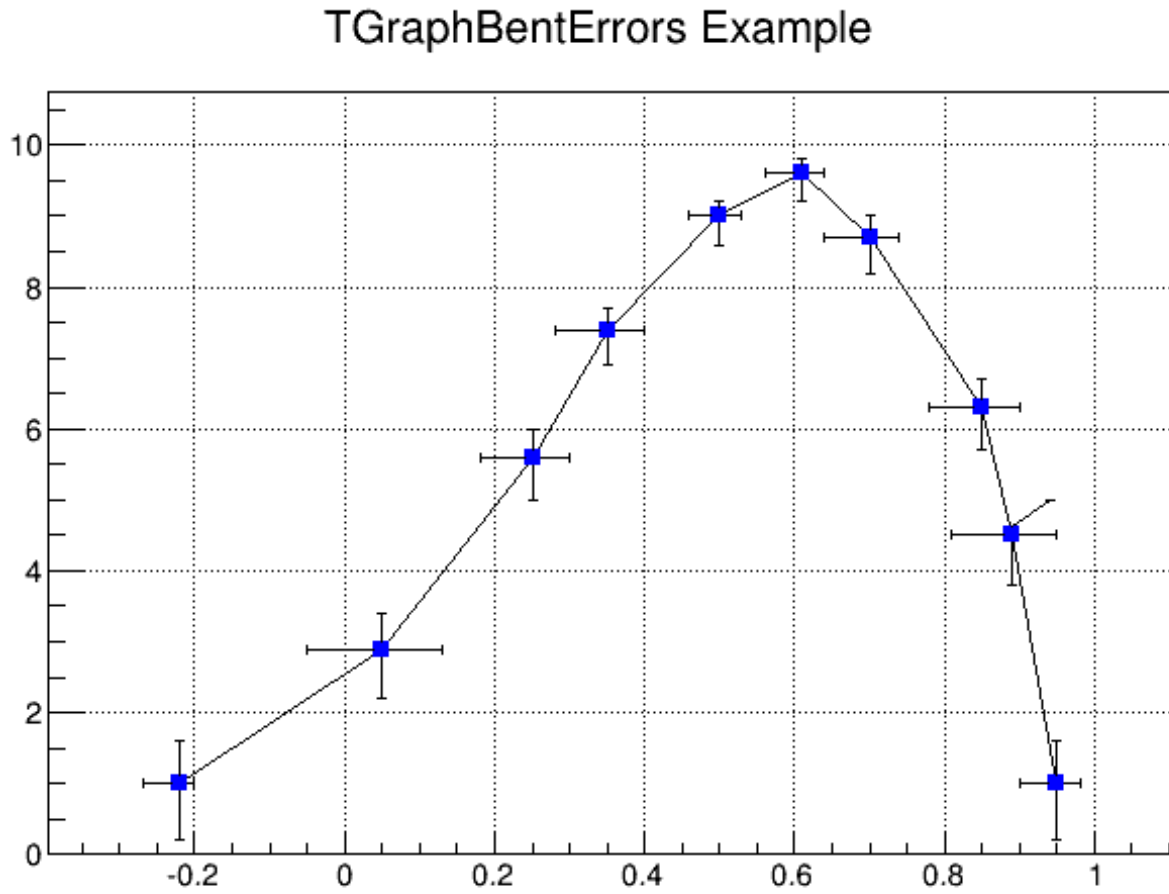

Figure 4.8: A graph with asymmetric bent error bars



```

{
  Int_t n = 10;
  Double_t x[n] = {-0.22,0.05,0.25,0.35,0.5,0.61,0.7,0.85,0.89,0.95};
  Double_t y[n] = {1,2.9,5.6,7.4,9,9.6,8.7,6.3,4.5,1};
  Double_t exl[n] = {.05,.1,.07,.07,.04,.05,.06,.07,.08,.05};
  Double_t eyl[n] = {.8,.7,.6,.5,.4,.4,.5,.6,.7,.8};
  Double_t exh[n] = {.02,.08,.05,.05,.03,.03,.04,.05,.06,.03};
  Double_t eyh[n] = {.6,.5,.4,.3,.2,.2,.3,.4,.5,.6};
  Double_t exld[n] = {.0,.0,.0,.0,.0,.0,.0,.0,.0,.0};
  Double_t eyld[n] = {.0,.0,.0,.0,.0,.0,.0,.0,.0,.0};
  Double_t exhd[n] = {.0,.0,.0,.0,.0,.0,.0,.0,.0,.0};
  Double_t eyhd[n] = {.0,.0,.0,.0,.0,.0,.0,.0,.05,.0};
  gr = new TGraphBentErrors(n,x,y,
                           exl,exh,eyl,eyh,exld,exhd,eyld,eyhd);
  gr->SetTitle("TGraphBentErrors Example");
  gr->SetMarkerColor(4);
  gr->SetMarkerStyle(21);
  gr->Draw("ALP");
}

```

## 4.6 TGraphPolar

The **TGraphPolar** class creates a polar graph (including error bars). A **TGraphPolar** is a **TGraphErrors** represented in polar coordinates. It uses the class **TGraphPolargram** to draw the polar axis.

```

{
  TCanvas *CPol = new TCanvas("CPol","TGraphPolar Examples",700,700);
  Double_t rmin=0;
  Double_t rmax=TMath::Pi()*2;
  Double_t r[1000];
  Double_t theta[1000];
  TF1 * fp1 = new TF1("fplot","cos(x)",rmin,rmax);
  for (Int_t ipt = 0; ipt < 1000; ipt++) {
    r[ipt] = ipt*(rmax-rmin)/1000+rmin;
    theta[ipt] = fp1->Eval(r[ipt]);
  }
  TGraphPolar * grP1 = new TGraphPolar(1000,r,theta);
  grP1->SetLineColor(2);
  grP1->Draw("AOL");
}

```

The **TGraphPolar** drawing options are:

“O” Polar labels are paint orthogonally to the polargram radius.

“P” Polymarker are paint at each point position.

“E” Paint error bars.

“F” Paint fill area (closed polygon).

“A” Force axis redrawing even if a polargram already exists.

## 4.7 TGraph Exclusion Zone

When a graph is painted with the option “C” or “L”, it is possible to draw a filled area on one side of the line. This is useful to show exclusion zones. This drawing mode is activated when the absolute value of the graph line width (set thanks to **SetLineWidth**) is greater than 99. In that case the line width number is interpreted as  $100*ff+ll = ffll$ . The two-digit

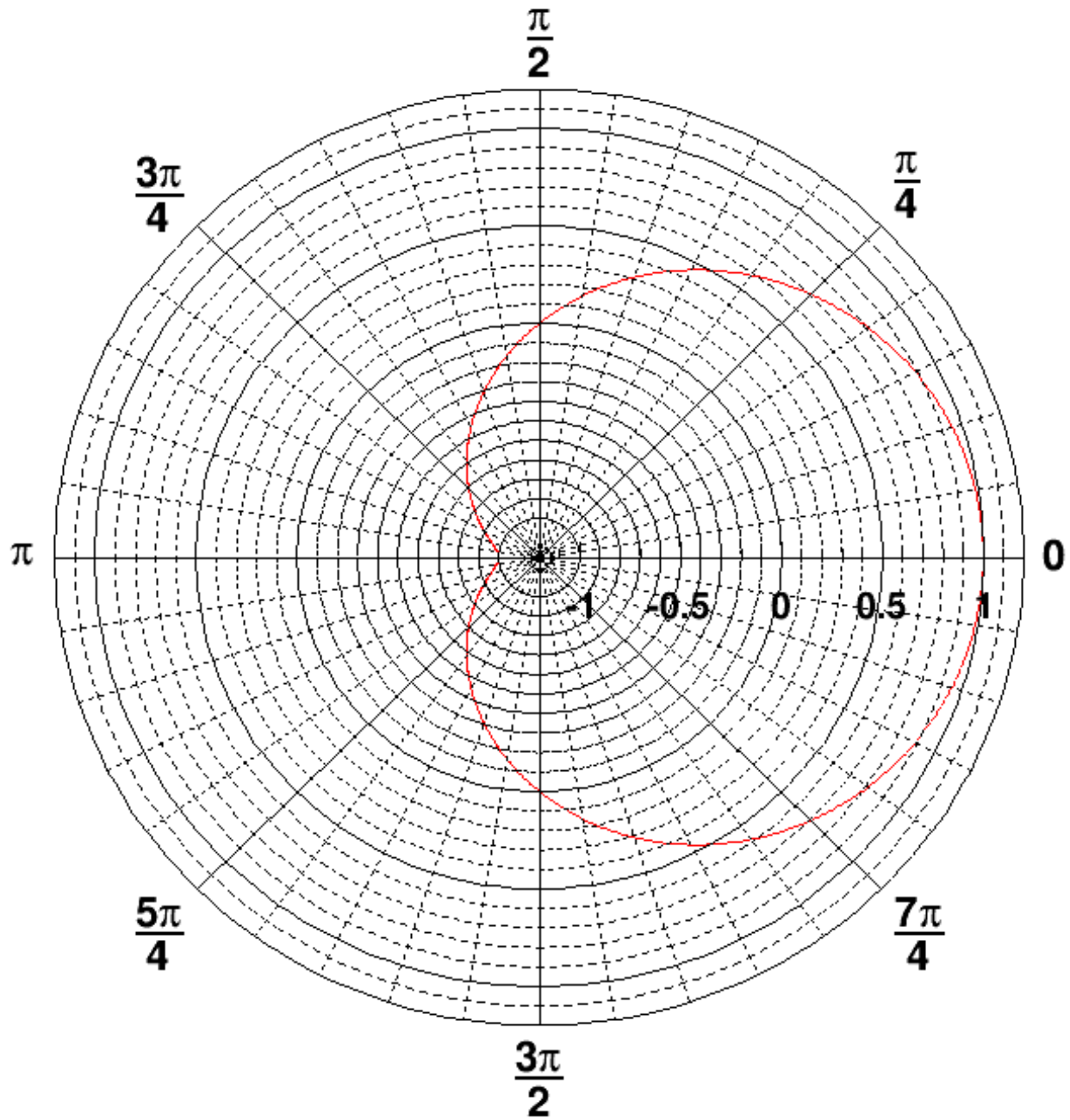

Figure 4.9: A polar graph

numbers “11” represent the normal line width whereas “ff” is the filled area width. The sign of “ff11” allows flipping the filled area from one side of the line to the other. The current fill area attributes are used to draw the hatched zone.

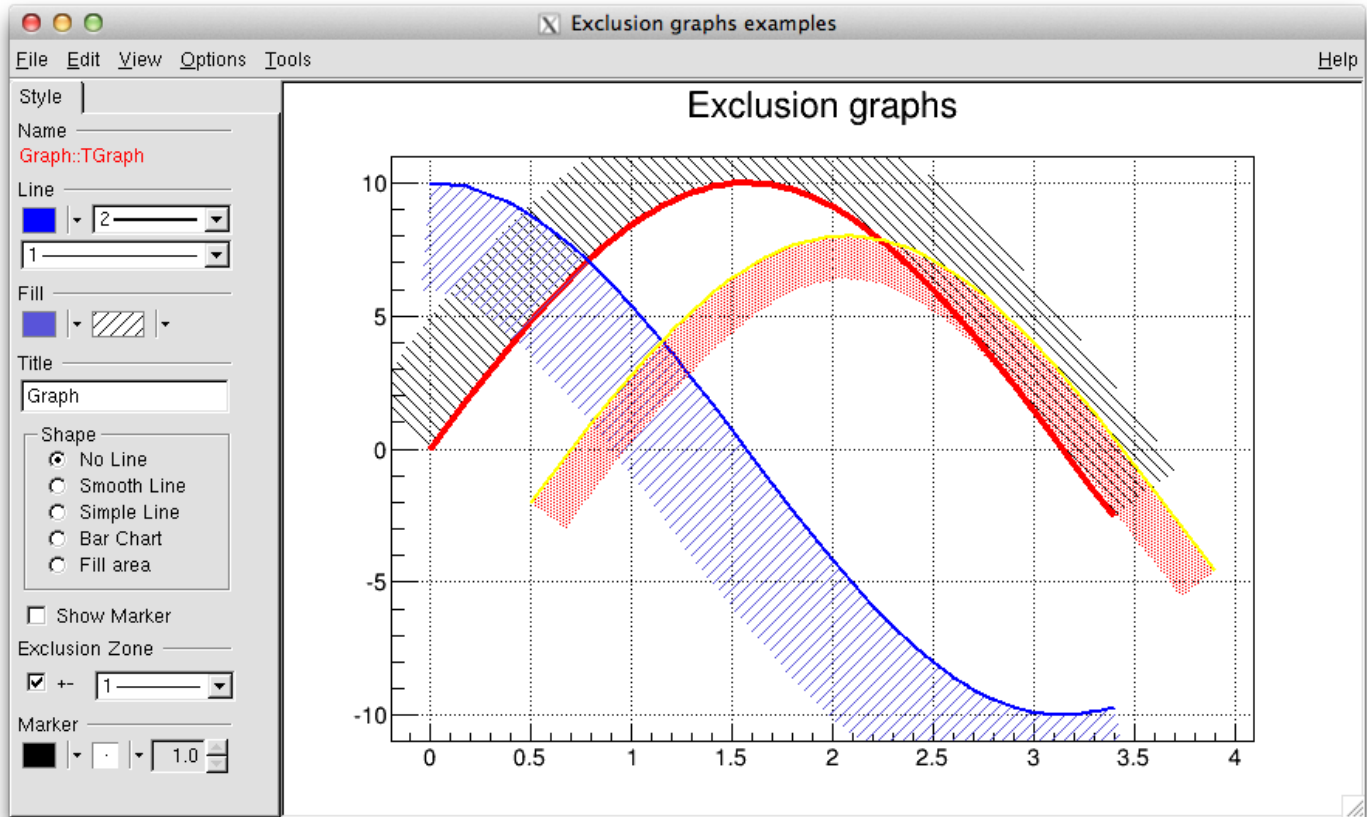

Figure 4.10: Graphs with exclusion zones

```
{
  c1 = new TCanvas("c1","Exclusion graphs examples",200,10,700,500);
  c1->SetGrid();

  // create the multigraph
  TMultiGraph *mg = new TMultiGraph();
  mg->SetTitle("Exclusion graphs");

  // create the graphs points
  const Int_t n = 35;
  Double_t x1[n], x2[n], x3[n], y1[n], y2[n], y3[n];
  for (Int_t i=0;i<n;i++) {
    x1[i] = i*0.1; y1[i] = 10*sin(x1[i]);
    x2[i] = x1[i]; y2[i] = 10*cos(x1[i]);
    x3[i] = x1[i]+.5; y3[i] = 10*sin(x1[i])-2;
  }

  // create the 1st TGraph
  TGraph *gr1 = new TGraph(n,x1,y1);
  gr1->SetLineColor(2);
  gr1->SetLineWidth(1504);
  gr1->SetFillStyle(3005);

  // create the 2nd TGraph
  TGraph *gr2 = new TGraph(n,x2,y2);
  gr2->SetLineColor(4);
}
```

```

gr2->SetLineWidth(-2002);
gr2->SetFillStyle(3004);
gr2->SetFillColor(9);

// create the 3rd TGraph
gr3 = new TGraph(n,x3,y3);
gr3->SetLineColor(5);
gr3->SetLineWidth(-802);
gr3->SetFillStyle(3002);
gr3->SetFillColor(2);

// put the graphs in the multigraph
mg->Add(gr1);
mg->Add(gr2);
mg->Add(gr3);

// draw the multigraph
mg->Draw("AC");
}

```

## 4.8 TGraphQQ

A **TGraphQQ** allows drawing quantile-quantile plots. Such plots can be drawn for two datasets, or for one dataset and a theoretical distribution function.

### 4.8.1 Two Datasets

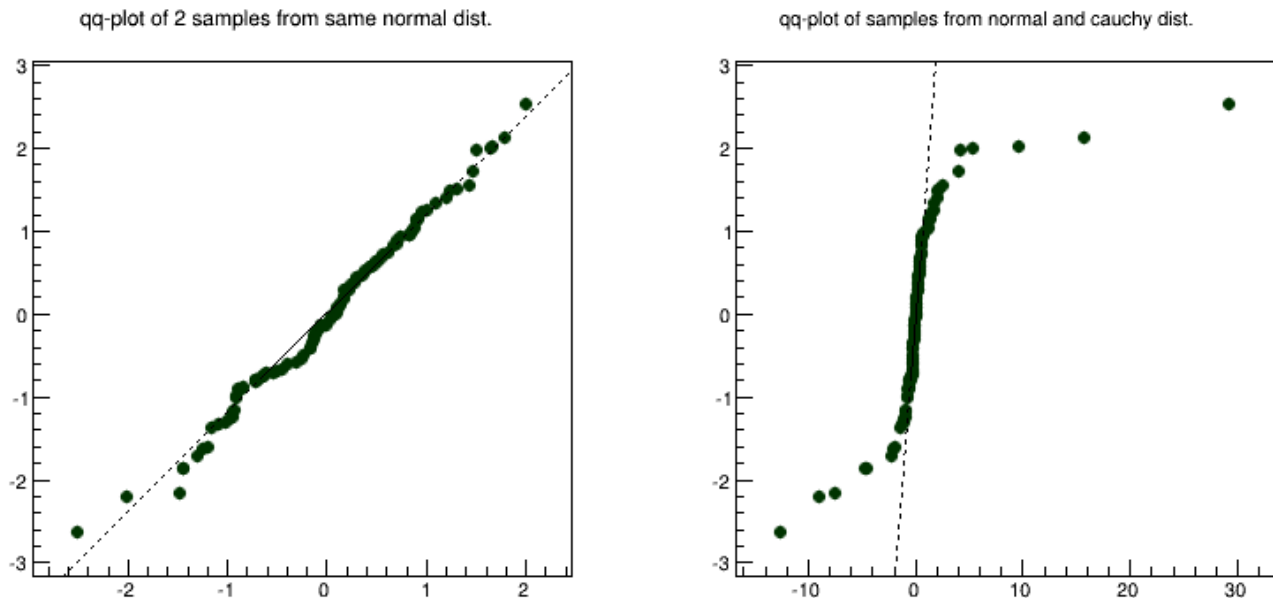

Figure 4.11: Examples of qq-plots of 2 datasets

Quantile-quantile plots are used to determine whether two samples come from the same distribution. A qq-plot draws the quantiles of one dataset against the quantile of the other. The quantiles of the dataset with fewer entries are on Y-axis, with more entries - on X-axis. A straight line, going through 0.25 and 0.75 quantiles is also plotted for reference. It represents a robust linear fit, not sensitive to the extremes of the datasets. If the datasets come from the same distribution, points of the plot should fall approximately on the 45 degrees line. If they have the same distribution function, but different parameters of location or scale, they should still fall on the straight line, but not the 45 degrees one.

The greater their departure from the straight line, the more evidence there is that the datasets come from different distributions. The advantage of qq-plot is that it not only shows that the underlying distributions are different, but, unlike the analytical methods, it also gives information on the nature of this difference: heavier tails, different location/scale, different shape, etc.

#### 4.8.2 One Dataset

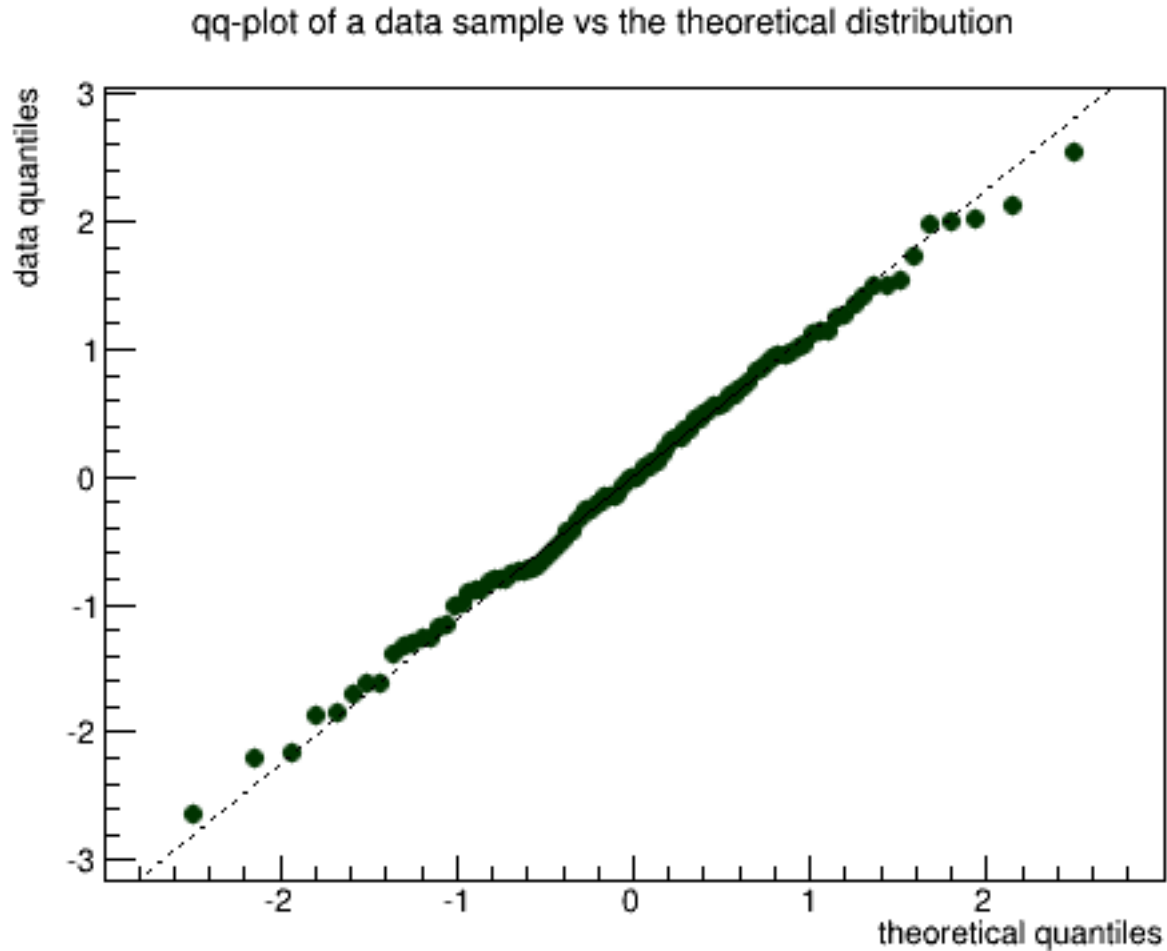

Figure 4.12: Examples of qq-plots of 1 dataset

Quantile-quantile plots are used to determine if the dataset comes from the specified theoretical distribution, such as normal. A qq-plot draws quantiles of the dataset against quantiles of the specified theoretical distribution. Note, that density, not CDF should be specified a straight line, going through 0.25 and 0.75 quantiles could also be plotted for reference. It represents a robust linear fit, not sensitive to the extremes of the dataset. As in the two datasets case, departures from straight line indicate departures from the specified distribution. Next picture shows an example of a qq-plot of a dataset from  $N(3, 2)$  distribution and  $\text{TMath::Gaus}(0, 1)$  theoretical function. Fitting parameters are estimates of the distribution mean and sigma.

## 4.9 TMultiGraph

A **TMultiGraph** is a collection of **TGraph** (or derived) objects. Use **TMultiGraph::Add** to add a new graph to the list. The **TMultiGraph** owns the objects in the list. The drawing and fitting options are the same as for **TGraph**.

```
{
  // create the points
```

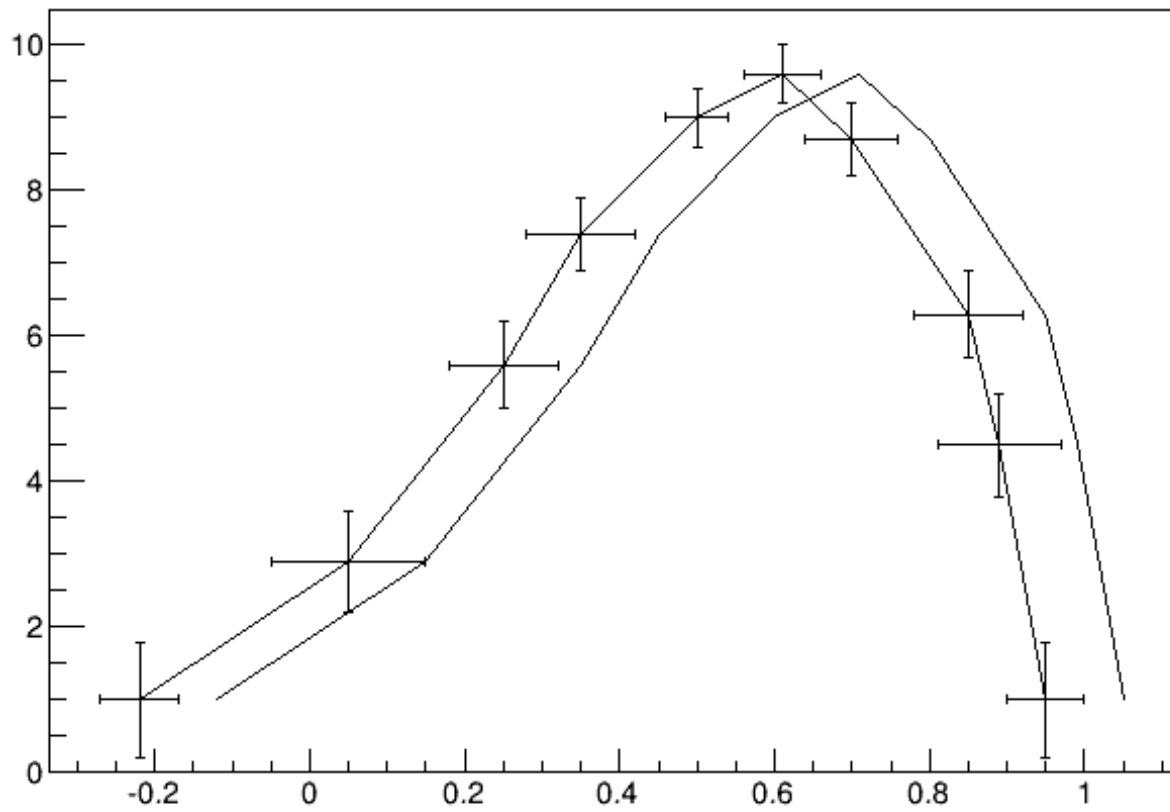

Figure 4.13: A multigraph example

```

Int_t n = 10;
Double_t x[n] = {-.22,.05,.25,.35,.5,.61,.7,.85,.89,.95};
Double_t y[n] = {1,2.9,5.6,7.4,9,9.6,8.7,6.3,4.5,1};
Double_t x2[n] = {-.12,.15,.35,.45,.6,.71,.8,.95,.99,1.05};
Double_t y2[n] = {1,2.9,5.6,7.4,9,9.6,8.7,6.3,4.5,1};

// create the width of errors in x and y direction
Double_t ex[n] = {.05,.1,.07,.07,.04,.05,.06,.07,.08,.05};
Double_t ey[n] = {.8,.7,.6,.5,.4,.4,.5,.6,.7,.8};

// create two graphs
TGraph *gr1 = new TGraph(n,x2,y2);
TGraphErrors *gr2 = new TGraphErrors(n,x,y,ex,ey);

// create a multigraph and draw it
TMultiGraph *mg = new TMultiGraph();
mg->Add(gr1);
mg->Add(gr2);
mg->Draw("ALP");
}

```

## 4.10 TGraph2D

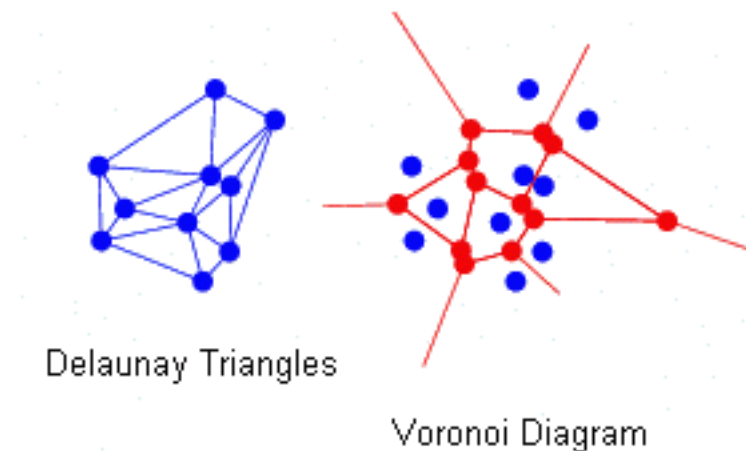

Figure 4.14: Delaunay triangles and Voronoi diagram

This class is a set of  $N$  points  $x[i]$ ,  $y[i]$ ,  $z[i]$  in a non-uniform grid. Several visualization techniques are implemented, including Delaunay triangulation. Delaunay triangulation is defined as follow: ‘for a set  $S$  of points in the Euclidean plane, the unique triangulation  $DT(S)$  of  $S$  such that no point in  $S$  is inside the circum-circle of any triangle in  $DT(S)$ .  $DT(S)$  is the dual of the Voronoi diagram of  $S$ . If  $n$  is the number of points in  $S$ , the Voronoi diagram of  $S$  is the partitioning of the plane containing  $S$  points into  $n$  convex polygons such that each polygon contains exactly one point and every point in a given polygon is closer to its central point than to any other. A Voronoi diagram is sometimes also known as a Dirichlet tessellation.

The **TGraph2D** class has the following constructors:

- With an arrays’ dimension  $n$  and three arrays  $x$ ,  $y$ , and  $z$  (can be arrays of doubles, floats, or integers):

```
TGraph2D *g = new TGraph2D(n,x,y,z);
```

- With an array dimension only:

```
TGraph2D *g = new TGraph2D(n);
```

- Internal arrays are filled with the method `SetPoint` at the position “i” with the values x, y, z:

```
g->SetPoint(i,x,y,z);
```

- Without parameters; the method `SetPoint` must be used to fill the internal arrays.

```
TGraph2D *g = new TGraph2D();
```

- From a file:

```
TGraph2D *g = new TGraph2D("graph.dat");
```

The arrays are read from the ASCII file “graph.dat” according to a specified format. The format’s default value is “%lg %lg %lg”. Note that in any of last three cases, the `SetPoint` method can be used to change a data point or to add a new one. If the data point index (i) is greater than the size of the internal arrays, they are automatically extended.

Specific drawing options can be used to paint a `TGraph2D`:

- “TRI” the Delaunay triangles are drawn using filled area. A hidden surface drawing technique is used. The surface is painted with the current fill area color. The edges of the triangles are painted with the current line color;
- “TRIW” the Delaunay triangles are drawn as wire frame;
- “TRI1” the Delaunay triangles are painted with color levels. The edges of the triangles are painted with the current line color;
- “TRI2” the Delaunay triangles are painted with color levels;
- “P” draws a marker at each vertex;
- “P0” draws a circle at each vertex. Each circle background is white.

A `TGraph2D` can be also drawn with ANY options valid for 2D histogram drawing. In this case, an intermediate 2D histogram is filled using the Delaunay triangles technique to interpolate the data set. `TGraph2D` linearly interpolate a Z value for any (X,Y) point given some existing (X,Y,Z) points. The existing (X,Y,Z) points can be randomly scattered. The algorithm works by joining the existing points to make Delaunay triangles in (X,Y). These are then used to define flat planes in (X,Y,Z) over which to interpolate. The interpolated surface thus takes the form of tessellating triangles at various angles. Output can take the form of a 2D histogram or a vector. The triangles found can be drawn in 3D. This software cannot be guaranteed to work under all circumstances. It was originally written to work with a few hundred points in anXY space with similar X and Y ranges.

```
{
  TCanvas *c = new TCanvas("c","Graph2D example",0,0,700,600);
  Double_t x, y, z, P = 6.;
  Int_t np = 200;
  TGraph2D *dt = new TGraph2D();
  TRandom *r = new TRandom();

  for (Int_t N=0; N<np; N++) {
    x = 2*P*(r->Rndm(N))-P;
    y = 2*P*(r->Rndm(N))-P;
    z = (sin(x)/x)*(sin(y)/y)+0.2;
    dt->SetPoint(N,x,y,z);
  }
  gStyle->SetPalette(55);
  dt->Draw("surf1");          // use "surf1" to generate the left picture
}                             // use "tri1 p0" to generate the right one
```

A more complete example is `$ROOTSYS/tutorials/fit/graph2dfit.C` that produces the next figure.



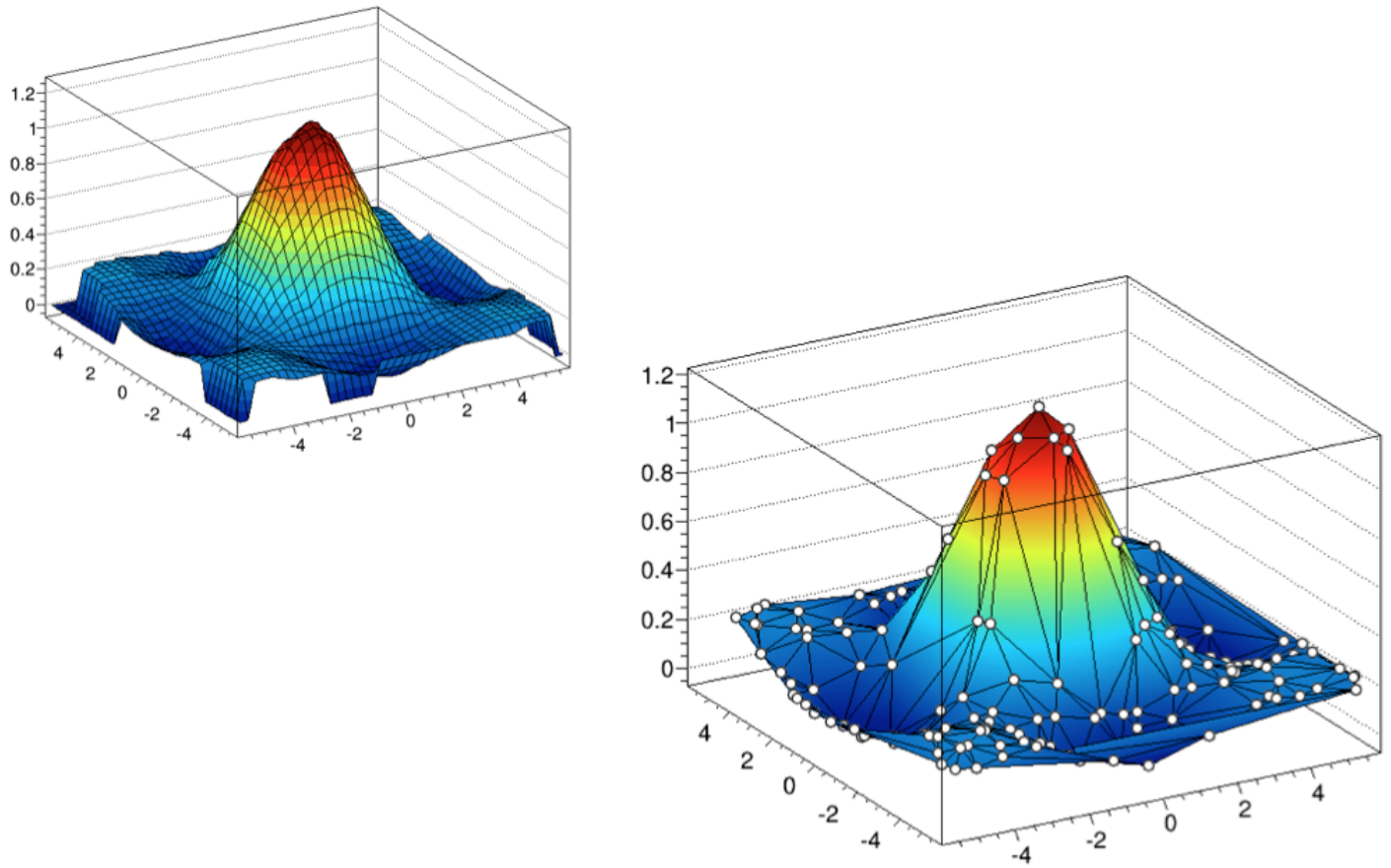

Figure 4.15: Graph2D drawn with option “surf1” and “tri1 p0”

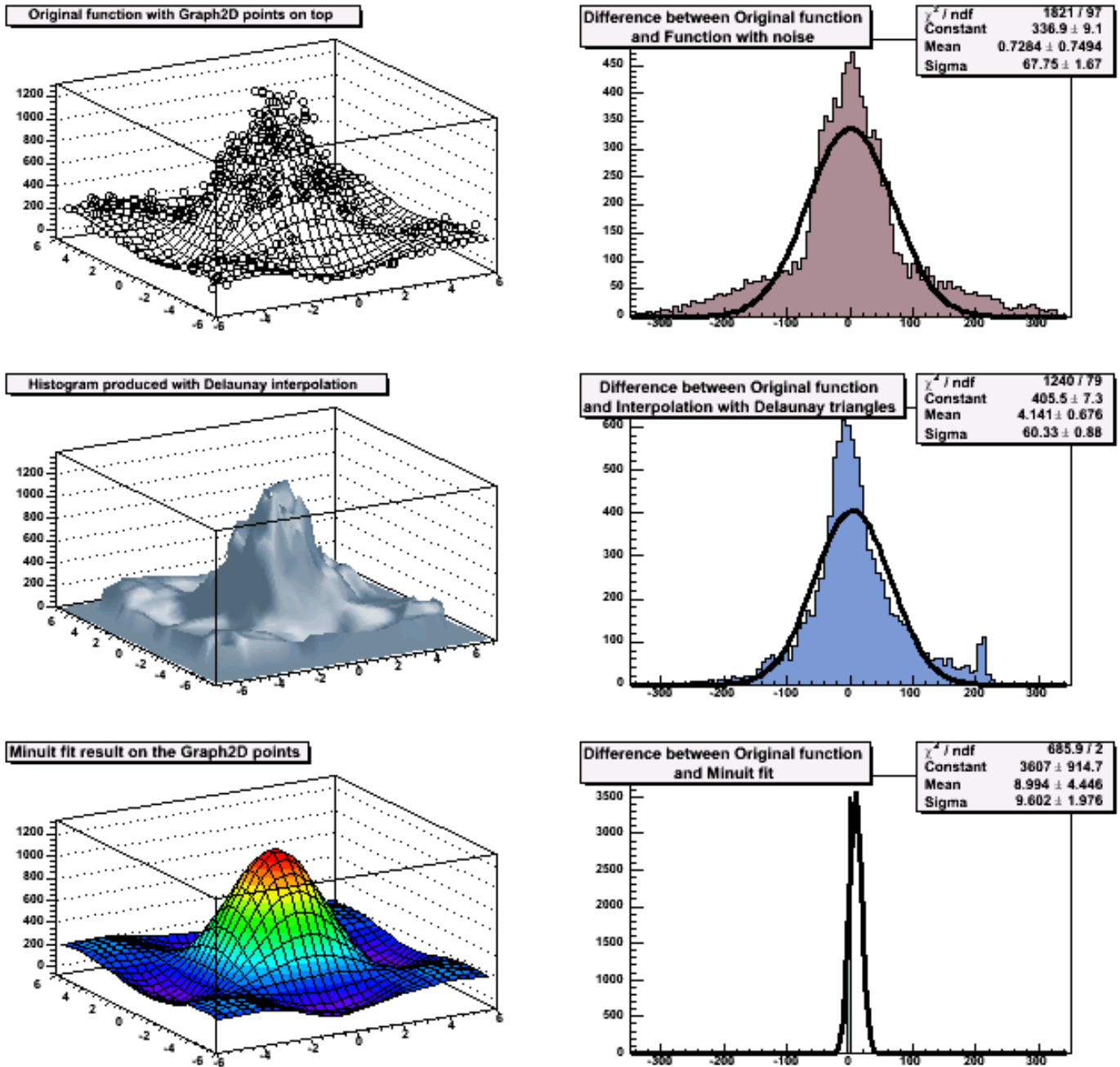

Figure 4.16: Output of macro graph2dfit.C

## 4.11 TGraph2DErrors

A `TGraph2DErrors` is a `TGraph2D` with errors. It is useful to perform fits with errors on a 2D graph. An example is the macro `$ROOTSYS/tutorials/graphs/graph2derrorsfit.C`.

## 4.12 Fitting a Graph

The graph `Fit` method in general works the same way as the `TH1::Fit`. See “Fitting Histograms”.

## 4.13 Setting the Graph’s Axis Title

To give the axis of a graph a title you need to draw the graph first, only then does it actually have an axis object. Once drawn, you set the title by getting the axis and calling the `TAxis::SetTitle` method, and if you want to center it, you can call the `TAxis::CenterTitle` method.

Assuming that `n`, `x`, and `y` are defined. Next code sets the titles of the `x` and `y` axes.

```
root[] gr5 = new TGraph(n,x,y)
root[] gr5->Draw()
<TCanvas::MakeDefCanvas>: created default TCanvas with name c1
root[] gr5->Draw("ALP")
root[] gr5->GetXaxis()->SetTitle("X-Axis")
root[] gr5->GetYaxis()->SetTitle("Y-Axis")
root[] gr5->GetXaxis()->CenterTitle()
root[] gr5->GetYaxis()->CenterTitle()
root[] gr5->Draw("ALP")
```

For more graph examples see the scripts: `$ROOTSYS/tutorials` directory `graph.C`, `gerrors.C`, `zdemo.C`, and `gerrors2.C`.

## 4.14 Zooming a Graph

To zoom a graph you can create a histogram with the desired axis range first. Draw the empty histogram and then draw the graph using the existing axis from the histogram.

```
{
  c1 = new TCanvas("c1","A Zoomed Graph",200,10,700,500);
  hpx = new TH2F("hpx","Zoomed Graph Example",10,0,0.5,10,1.0,8.0);
  hpx->SetStats(kFALSE); // no statistics
  hpx->Draw();
  Int_t n = 10;
  Double_t x[n] = {-.22,.05,.25,.35,.5,.61,.7,.85,.89,.95};
  Double_t y[n] = {1,2.9,5.6,7.4,9,9.6,8.7,6.3,4.5,1};
  gr = new TGraph(n,x,y);
  gr->SetMarkerColor(4);
  gr->SetMarkerStyle(20);
  gr->Draw("LP");// and draw it without an axis
}
```

The next example is the same graph as above with a zoom in the `x` and `y` directions.

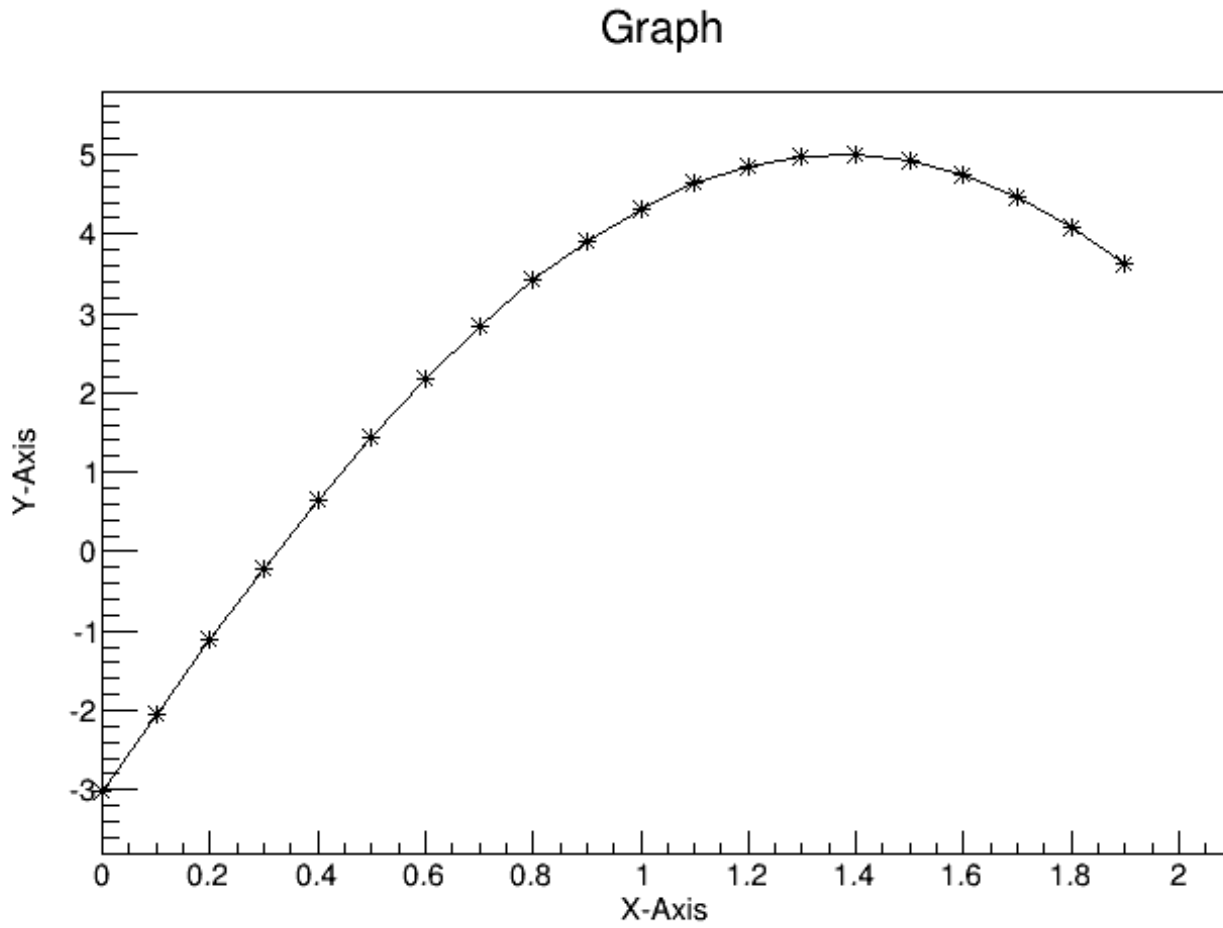

Figure 4.17: A graph with axis titles

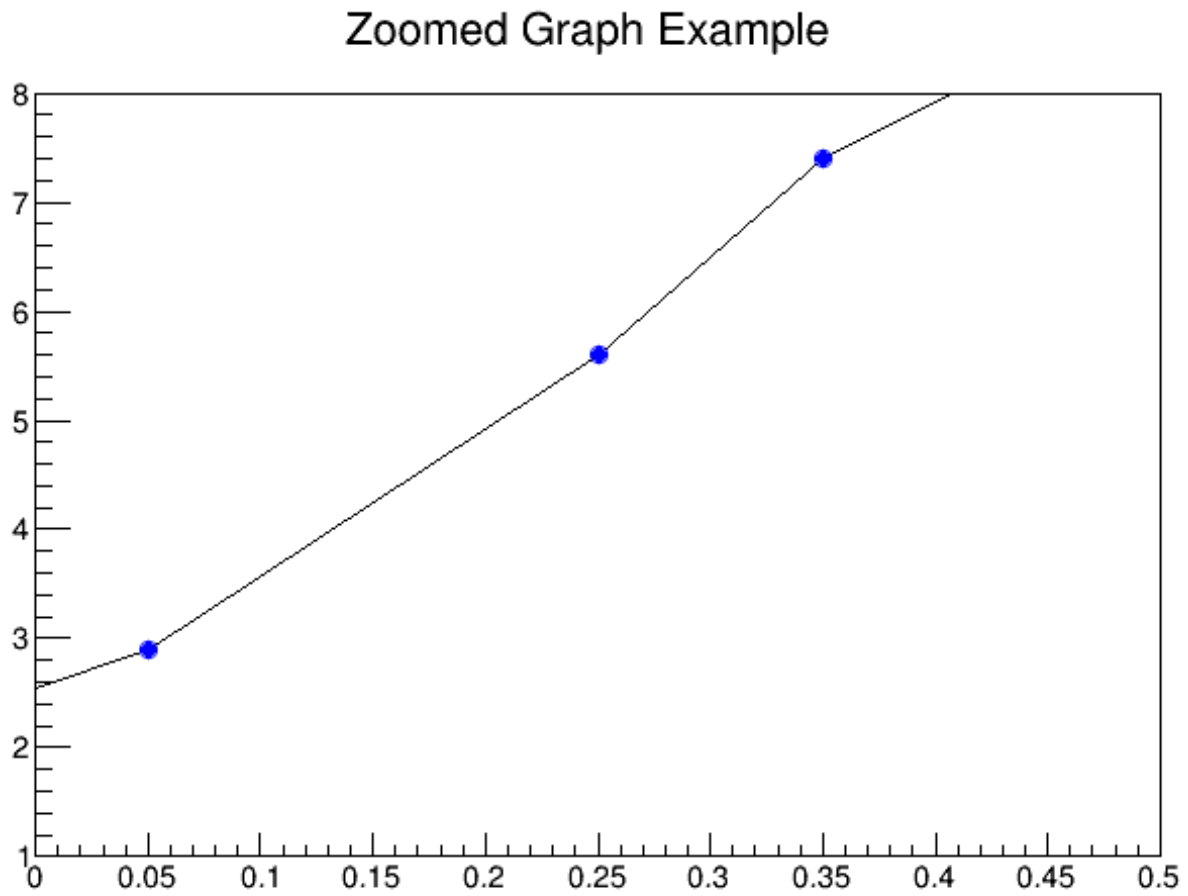
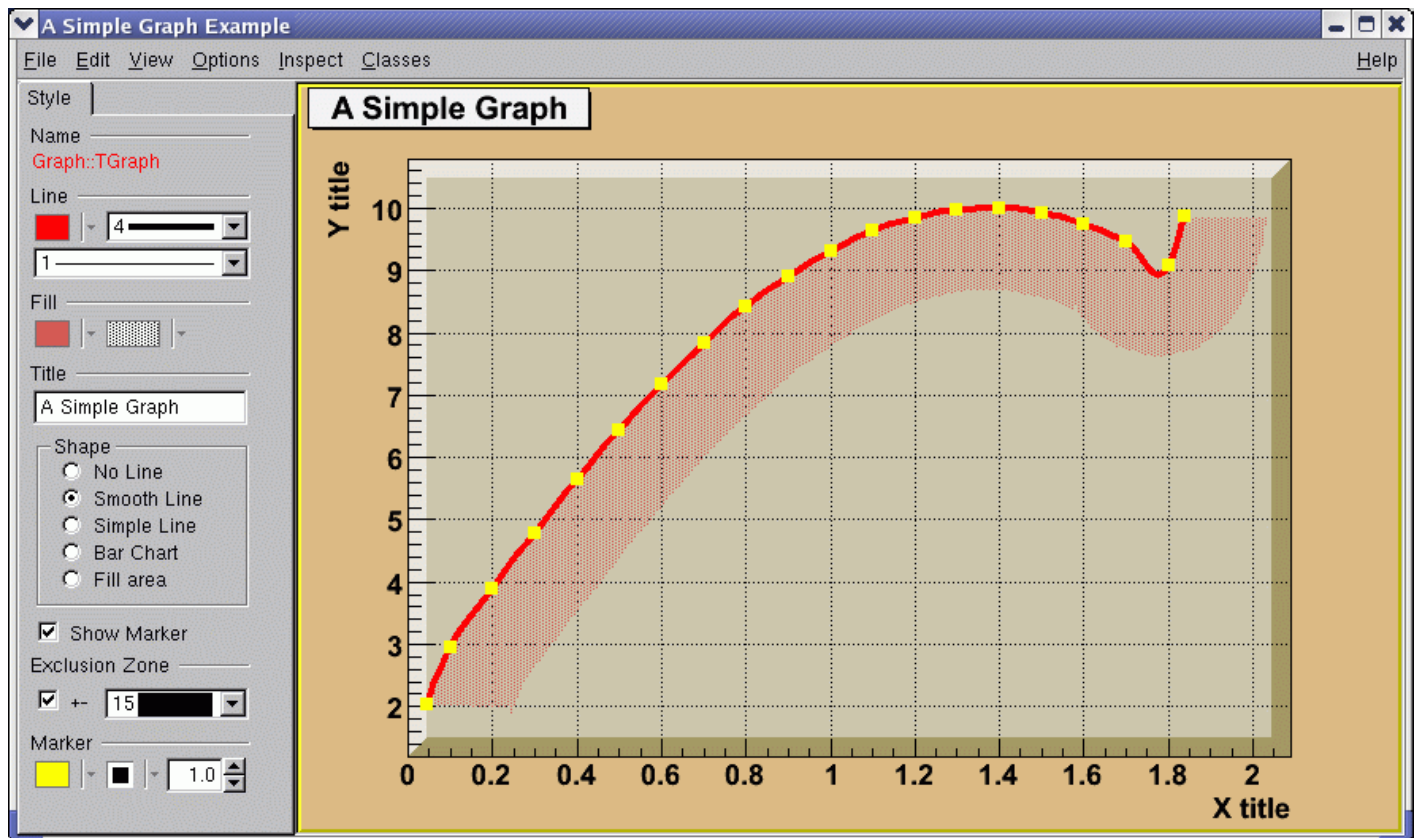

Figure 4.18: A zoomed graph

## 4.15 The User Interface for Graphs

The class `TGraphEditor` provides the user interface for setting the following graph attributes interactively:

- Title text entry field ... sets the title of the graph.
- Shape radio button group - sets the graph shapes:
  - *No Line*: draw unconnected points;
  - *Smooth Line*: a smooth curve;
  - *Simple Line*: a simple poly-line;
  - *Bar Chart*: a bar chart at each point.
  - *Fill Area*: a fill area is drawn.
- Show Marker - sets markers as visible or invisible.
- Exclusion Zone - specifies the exclusion zone parameters :
  - '+' check button: sets on which side of the line the exclusion zone will be drawn;
  - *Width combo box*: defines the width of the zone.



## Chapter 5

# Fitting Histograms

To fit a histogram you can use the Fit Panel on a visible histogram via the context menu, or you can use the `TH1::Fit` method. The Fit Panel, which is limited, is best for prototyping. The histogram needs to be drawn in a pad before the Fit Panel is invoked. The method `TH1::Fit` is more powerful and is used in scripts and programs.

### 5.1 The Fit Method

To fit a histogram programmatically, you can use the `TH1::Fit` method. Here is the signature of `TH1::Fit` and an explanation of the parameters:

```
void Fit(const char *fname, Option_t *option, Option_t *goption,
        Axis_t xxmin, Axis_t xxmax)
```

- `*fname`: The name of the fitted function (the model) is passed as the first parameter. This name may be one of ROOT pre-defined function names or a user-defined function. The functions below are predefined, and can be used with the `TH1::Fit` method:
- “gaus” Gaussian function with 3 parameters:  $f(x) = p0 \cdot \exp(-0.5 \cdot ((x-p1)/p2)^2)$
- “expo” An Exponential with 2 parameters:  $f(x) = \exp(p0+p1 \cdot x)$
- “polN” A polynomial of degree  $N$ :  $f(x) = p0 + p1 \cdot x + p2 \cdot x^2 + \dots$
- “landau” Landau function with mean and sigma. This function has been adapted from the CERNLIB routine G110 `denlan`.
- `*option`: The second parameter is the fitting option. Here is the list of fitting options:
- “W” Set all weights to 1 for non empty bins; ignore error bars
- “WW” Set all weights to 1 including empty bins; ignore error bars
- “I” Use integral of function in bin instead of value at bin center
- “L” Use log likelihood method (default is chi-square method)
- “U” Use a user specified fitting algorithm
- “Q” Quiet mode (minimum printing)
- “V” Verbose mode (default is between Q and V)
- “E” Perform better errors estimation using the Minos technique
- “M” Improve fit results
- “R” Use the range specified in the function range

- “N” Do not store the graphics function, do not draw
- “0” Do not plot the result of the fit. By default the fitted function is drawn unless the option “N” above is specified.
- “+” Add this new fitted function to the list of fitted functions (by default, the previous function is deleted and only the last one is kept)
- “B” Use this option when you want to fix one or more parameters and the fitting function is like `polN`, `expo`, `landau`, `gaus`.
- “LL” An improved Log Likelihood fit in case of very low statistics and when bin contents are not integers. Do not use this option if bin contents are large (greater than 100).
- “C” In case of linear fitting, don’t calculate the chisquare (saves time).
- “F” If fitting a `polN`, switch to Minuit fitter (by default, `polN` functions are fitted by the linear fitter).
- `*goption`: The third parameter is the graphics option that is the same as in the `TH1::Draw` (see the chapter Draw Options).
- `xxmin`, `xxmax`: The fourth and fifth parameters specify the range over which to apply the fit.

By default, the fitting function object is added to the histogram and is drawn in the current pad.

## 5.2 Fit with a Predefined Function

To fit a histogram with a predefined function, simply pass the name of the function in the first parameter of `TH1::Fit`. For example, this line fits histogram object `hist` with a Gaussian.

```
root[] hist.Fit("gaus");
```

The initial parameter values for pre-defined functions are set automatically.

## 5.3 Fit with a User-Defined Function

You can create a `TF1` object and use it in the call the `TH1::Fit`. The parameter in to the `Fit` method is the NAME of the `TF1` object. There are three ways to create a `TF1`.

- Using C++ expression using `x` with a fixed set of operators and functions defined in `TFormula`.
- Same as first one, with parameters
- Using a function that you have defined

### 5.3.1 Creating a TF1 with a Formula

Let’s look at the first case. Here we call the `TF1` constructor by giving it the formula: `sin(x)/x`.

```
root[] TF1 *f1 = new TF1("f1","sin(x)/x",0,10)
```

You can also use a `TF1` object in the constructor of another `TF1`.

```
root[] TF1 *f2 = new TF1("f2","f1*2",0,10)
```

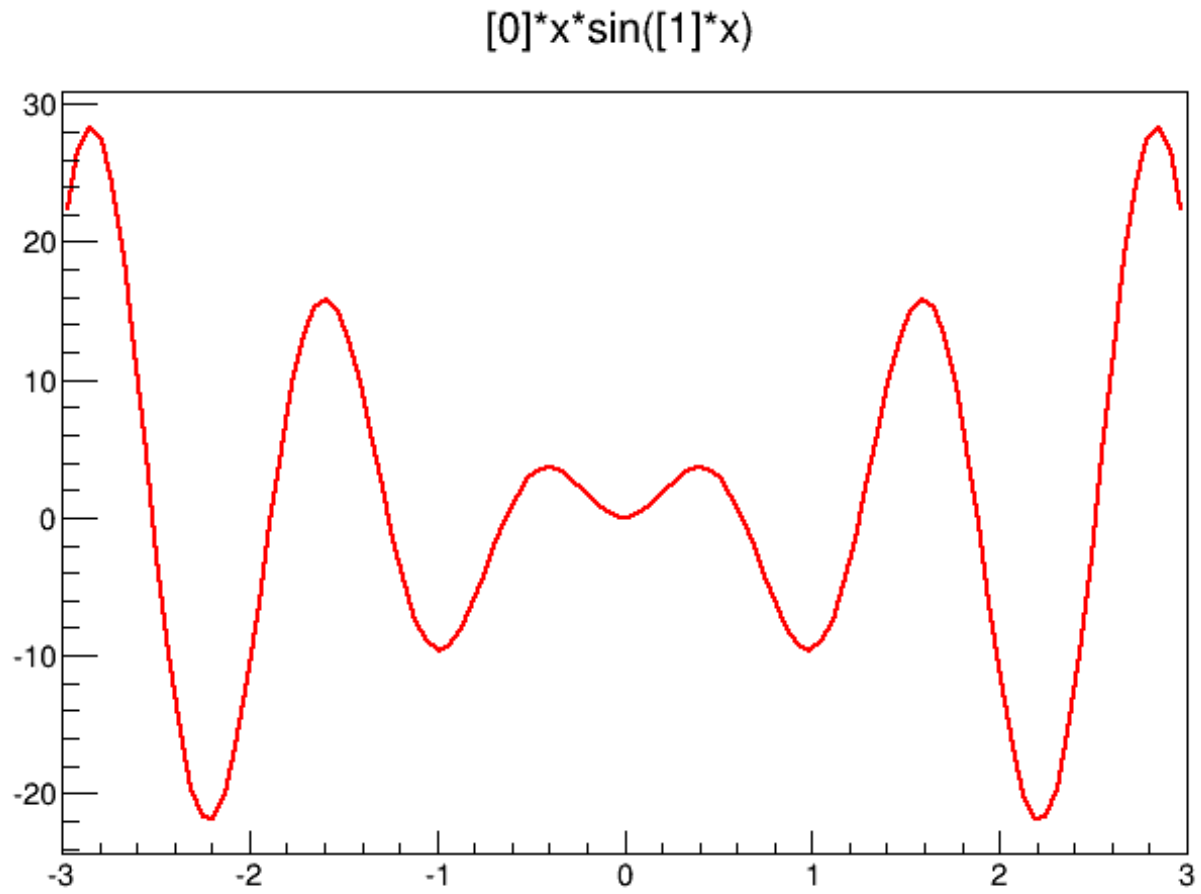

Figure 5.1: The function  $x*\sin(x)$

### 5.3.2 Creating a TF1 with Parameters

The second way to construct a **TF1** is to add parameters to the expression. Here we use two parameters:

```
root[] TF1 *f1 = new TF1("f1", "[0]*x*sin([1]*x)", -3, 3);
```

The parameter index is enclosed in square brackets. To set the initial parameters explicitly you can use:

```
root[] f1->SetParameter(0, 10);
```

This sets parameter 0 to 10. You can also use `SetParameters` to set multiple parameters at once.

```
root[] f1->SetParameters(10, 5);
```

This sets parameter 0 to 10 and parameter 1 to 5. We can now draw the **TF1**:

```
root[] f1->Draw();
```

### 5.3.3 Creating a TF1 with a User Function

The third way to build a **TF1** is to define a function yourself and then give its name to the constructor. A function for a **TF1** constructor needs to have this exact signature:

```
Double_t fitf(Double_t *x, Double_t *par)
```

The two parameters are:

- `x` a pointer to the dimension array. Each element contains a dimension. For a 1D histogram only `x[0]` is used, for a 2D histogram `x[0]` and `x[1]` is used, and for a 3D histogram `x[0]`, `x[1]`, and `x[2]` are used. For histograms, only 3 dimensions apply, but this method is also used to fit other objects, for example an ntuple could have 10 dimensions.
- `par` a pointer to the parameters array. This array contains the current values of parameters when it is called by the fitting function.

The following script `$ROOTSYS/tutorials/fit/myfit.C` illustrates how to fit a 1D histogram with a user-defined function. First we declare the function.

```
// define a function with 3 parameters
Double_t fitf(Double_t *x, Double_t *par) {
    Double_t arg = 0;
    if (par[2] != 0) arg = (x[0] - par[1]) / par[2];
    Double_t fitval = par[0] * TMath::Exp(-0.5 * arg * arg);
    return fitval;
}
```

Now we use the function:

```
// this function used fitf to fit a histogram
void fitexample() {

    // open a file and get a histogram
    TFile *f = new TFile("hsimple.root");
    TH1F *hpx = (TH1F*)f->Get("hpx");

    // Create a TF1 object using the function defined above.
```

```

// The last three parameters specify the number of parameters
// for the function.
TF1 *func = new TF1("fit",fitf,-3,3,3);
// set the parameters to the mean and RMS of the histogram
func->SetParameters(500,hpx->GetMean(),hpx->GetRMS());

// give the parameters meaningful names
func->SetParNames ("Constant","Mean_value","Sigma");

// call TH1::Fit with the name of the TF1 object
hpx->Fit("fit");
}

```

## 5.4 Fixing and Setting Parameters' Bounds

Parameters must be initialized before invoking the `Fit` method. The setting of the parameter initial values is automatic for the predefined functions: `poln`, `exp`, `gaus`, and `landau`. You can fix one or more parameters by specifying the “B” option when calling the `Fit` method. When a function is not predefined, the fit parameters must be initialized to some value as close as possible to the expected values before calling the fit function.

To set bounds for one parameter, use `TF1::SetParLimits`:

```
func->SetParLimits(0,-1,1);
```

When the lower and upper limits are equal, the parameter is fixed. Next two statements fix parameter 4 at 10.

```
func->SetParameter(4,10);
func->SetParLimits(4,10,10);
```

However, to fix a parameter to 0, one must call the `FixParameter` function:

```
func->SetParameter(4,0);
func->FixParameter(4,0);
```

Note that you are not forced to set the limits for all parameters. For example, if you fit a function with 6 parameters, you can:

```
func->SetParameters(0,3.1,1.e-6,-1.5,0,100);
func->SetParLimits(3,-10,4);
func->FixParameter(4,0);
```

With this setup, parameters 0->2 can vary freely, parameter 3 has boundaries  $[-10, 4]$  with initial value -1.5, and parameter 4 is fixed to 0.

## 5.5 Fitting Sub Ranges

By default, `TH1::Fit` will fit the function on the defined histogram range. You can specify the option “R” in the second parameter of `TH1::Fit` to restrict the fit to the range specified in the `TF1` constructor. In this example, the fit will be limited to -3 to 3, the range specified in the `TF1` constructor.

```
root[] TF1 *f1 = new TF1("f1","[0]*x*sin([1]*x)",-3,3);
root[] hist->Fit("f1","R");
```

You can also specify a range in the call to `TH1::Fit`:

```
root[] hist->Fit("f1","","",-2,2)
```

See macros `$ROOTSYS/tutorials/fit/myfit.C` and `multifit.C` as more completed examples.

## 5.6 The Fit Panel

To display the Fit Panel right click on a histogram to pop up the context menu, and then select the menu entry Fit Panel.

The new Fit Panel GUI is available in ROOT v5.14. Its goal is to replace the old Fit Panel and to provide more user friendly way for performing, exploring and comparing fits.

By design, this user interface is planned to contain two tabs: “General” and “Minimization”. Currently, the “General” tab provides user interface elements for setting the fit function, fit method and different fit, draw, print options.

The new fit panel is a modeless dialog, i.e. when opened, it does not prevent users from interacting with other windows. Its first prototype is a singleton application. When the Fit Panel is activated, users can select an object for fitting in the usual way, i.e. by left-mouse click on it. If the selected object is suitable for fitting, the fit panel is connected with this object and users can perform fits by setting different parameters and options.

### 5.6.1 Function Choice and Settings

*‘Predefined’ combo box* - contains a list of predefined functions in ROOT. You have a choice of several polynomials, a Gaussian, a Landau, and an Exponential function. The default one is Gaussian.

*‘Operation’ radio button group* defines the selected operational mode between functions:

*Nop* - no operation (default);

*Add* - addition;

*Conv* - convolution (will be implemented in the future).

Users can enter the function expression into the text entry field below the ‘Predefined’ combo box. The entered string is checked after the Enter key was pressed and an error message shows up, if the function string is not accepted.

*‘Set Parameters’* button opens a dialog for parameters settings, which will be explained later.

### 5.6.2 Fitter Settings

*‘Method’ combo box* currently provides only two fit model choices: Chi-square and Binned Likelihood. The default one is Chi-square. The Binned Likelihood is recommended for bins with low statistics.

*‘Linear Fit’ check button* sets the use of Linear fitter when is selected. Otherwise the minimization is done by Minuit, i.e. fit option “F” is applied. The Linear fitter can be selected only for functions linears in parameters (for example - `polN`).

*‘Robust’ number entry* sets the robust value when fitting graphs.

*‘No Chi-square’ check button* switch On/Off the fit option “C” - do not calculate Chi-square (for Linear fitter).

*‘Integral’ check button* switch On/Off the option “I” - use integral of function instead of value in bin center.

*‘Best Errors’* sets On/Off the option “E” - better errors estimation by using Minos technique.

*‘All weights = 1’* sets On/Off the option “W”- all weights set to 1 excluding empty bins; error bars ignored.

*‘Empty bins, weights=1’* sets On/Off the option “WW” - all weights equal to 1 including empty bins; error bars ignored.

*‘Use range’* sets On/Off the option “R” - fit only data within the specified function range. Sliders settings are used if this option is set to On. Users can change the function range values by pressing the left mouse button near to the left/right slider edges. It is possible to change both values simultaneously by pressing the left mouse button near to the slider center and moving it to a new position.

*‘Improve fit results’* sets On/Off the option “M”- after minimum is found, search for a new one.

*‘Add to list’* sets On/Off the option “+”- add function to the list without deleting the previous one. When fitting a histogram, the function is attached to the histogram’s list of functions. By default, the previously fitted function is deleted and replaced with the most recent one, so the list only contains one function. Setting this option to On will add the newly fitted function to the existing list of functions for the histogram. Note that the fitted functions are saved with the histogram when it is written to a ROOT file. By default, the function is drawn on the pad displaying the histogram.

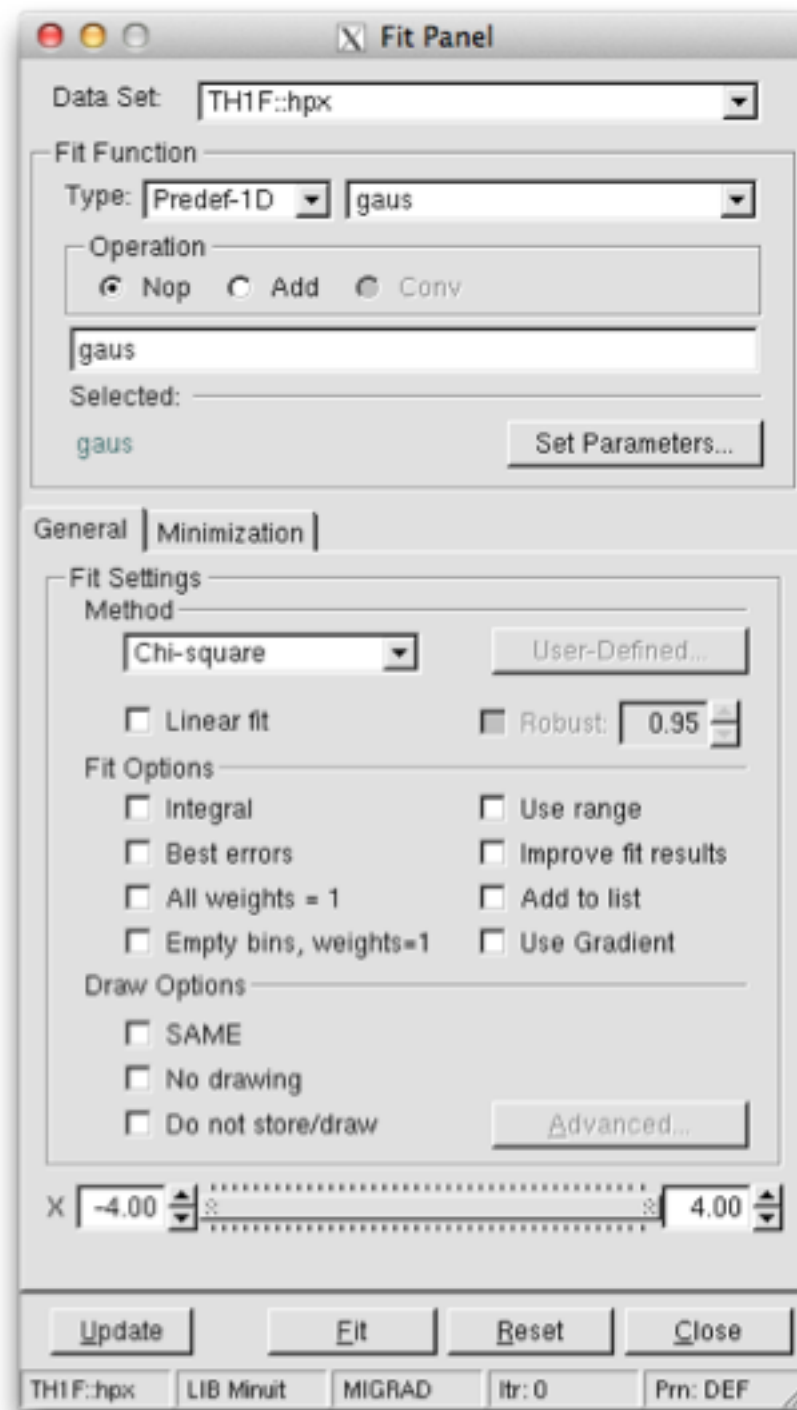

Figure 5.2: The Fit Panel

### 5.6.3 Draw Options

'*SAME*' sets On/Off function drawing on the same pad. When a fit is executed, the image of the function is drawn on the current pad.

'*No drawing*' sets On/Off the option "0"- do not draw the fit results.

'*Do not store/draw*' sets On/Off option "N"- do not store the function and do not draw it.

### 5.6.4 Print Options

This set of options specifies the amount of feedback printed on the root command line after performed fits.

'*Verbose*' - prints fit results after each iteration.

'*Quiet*' - no fit information is printed.

'*Default*' - between Verbose and Quiet.

### 5.6.5 Command Buttons

*Fit button* - performs a fit taking different option settings via the Fit Panel interface.

*Reset* - sets the GUI elements and related fit settings to the default ones.

*Close* - closes the Fit panel window.

## 5.7 Fitting Multiple Sub Ranges

The script for this example is `$ROOTSYS/tutorials/fit/multifit.C`. It shows how to use several Gaussian functions with different parameters on separate sub ranges of the same histogram. To use a Gaussian, or any other ROOT built in function, on a sub range you need to define a new **TF1**. Each is 'derived' from the canned function `gaus`.

First, four TF1 objects are created - one for each sub-range:

```
g1 = new TF1("m1", "gaus", 85, 95);
g2 = new TF1("m2", "gaus", 98, 108);
g3 = new TF1("m3", "gaus", 110, 121);
// The total is the sum of the three, each has 3 parameters
total = new TF1("mstotal", "gaus(0)+gaus(3)+gaus(6)", 85, 125);
```

Next, we fill a histogram with bins defined in the array `x`.

```
// Create a histogram and set it's contents
h = new TH1F("g1", "Example of several fits in subranges",
            np, 85, 134);
h->SetMaximum(7);
for (int i=0; i<np; i++) {
    h->SetBinContent(i+1, x[i]);
}
// Define the parameter array for the total function
Double_t par[9];
```

When fitting simple functions, such as a Gaussian, the initial values of the parameters are automatically computed by ROOT. In the more complicated case of the sum of 3 Gaussian functions, the initial values of parameters must be set. In this particular case, the initial values are taken from the result of the individual fits. The use of the "+" sign is explained below:

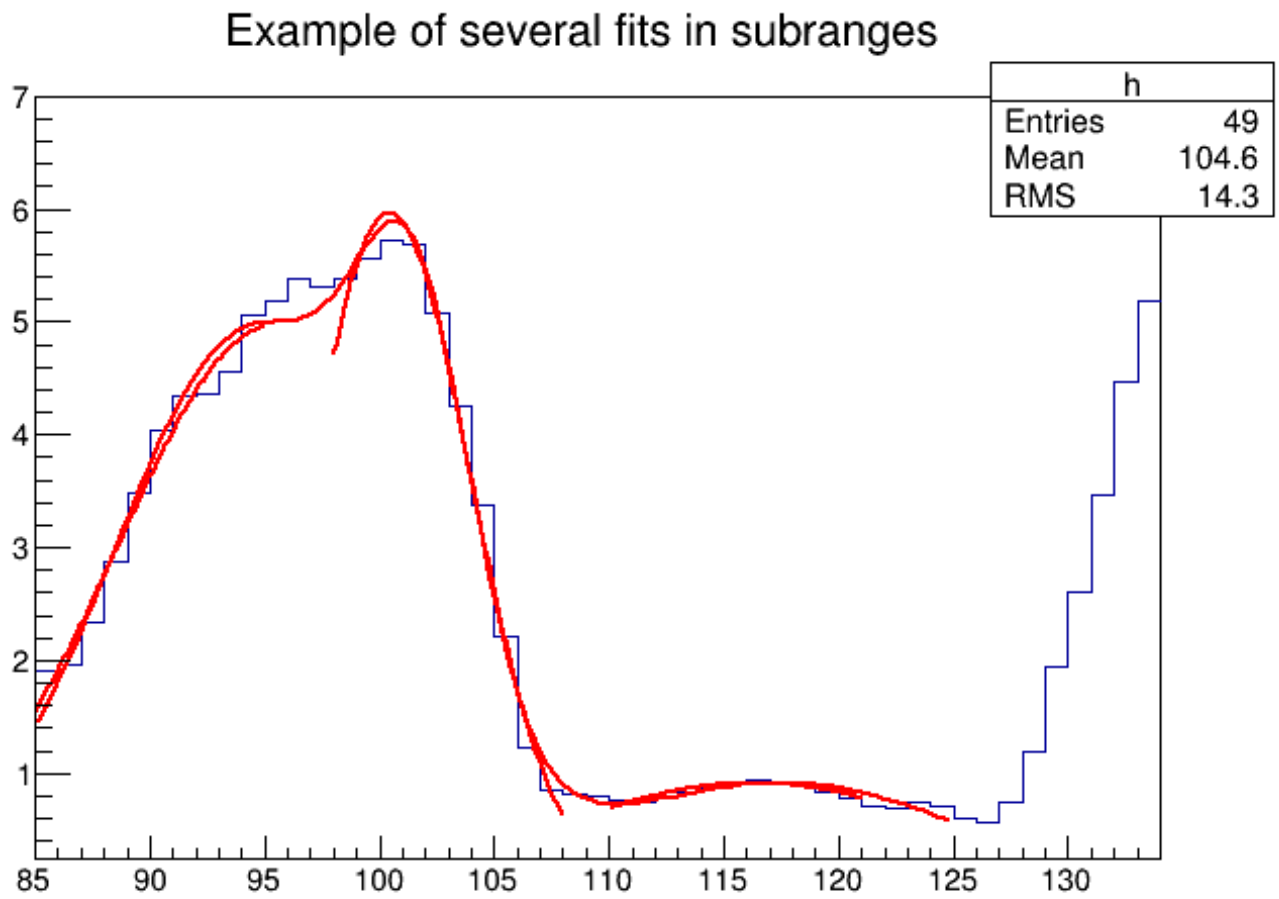

Figure 5.3: Fitting a histogram with several Gaussian functions

```

// Fit each function and add it to the list of functions
h->Fit(g1,"R");
h->Fit(g2,"R+");
h->Fit(g3,"R+");

// Get the parameters from the fit
g1->GetParameters(&par[0]);
g2->GetParameters(&par[3]);
g3->GetParameters(&par[6]);

// Use the parameters on the sum
total->SetParameters(par);
h->Fit(total,"R+");

```

## 5.8 Adding Functions to the List

The example `$ROOTSYS/tutorials/fit/multifit.C` also illustrates how to fit several functions on the same histogram. By default a `Fit` command deletes the previously fitted function in the histogram object. You can specify the option “+” in the second parameter to add the newly fitted function to the existing list of functions for the histogram.

```
root[] hist->Fit("f1","+", "", -2,2)
```

Note that the fitted function(s) are saved with the histogram when it is written to a ROOT file.

## 5.9 Combining Functions

You can combine functions to fit a histogram with their sum as it is illustrated in the macro `FitDemo.C` (`$ROOTSYS/tutorials/fit/FittingDemo.C`). We have a function that is the combination of a background and Lorentzian peak. Each function contributes 3 parameters:

$$y(E) = a_1 + a_2 E + a_3 E^2 + \frac{A_p \left(\frac{G}{2p}\right)}{(E - m)^2 + \left(\frac{G}{2}\right)^2}$$

BackgroundLorentzian Peak

`par[0] = a1 par[0] = Ap`

`par[1] = a2 par[1] = G`

`par[2] = a3 par[2] = m`

The combination function (`fitFunction`) has six parameters:

```
fitFunction = background(x,par) + LorentzianPeak(x,&par[3])
```

```
par[0]=a1 par[1]=a2 par[2]=a3 par[3]=Ap par[4]=G par[5]=m
```

This script creates a histogram and fits it with the combination of two functions. First we define the two functions and the combination function:

```

// Quadratic background function
Double_t background(Double_t *x, Double_t *par) {
    return par[0] + par[1]*x[0] + par[2]*x[0]*x[0];
}

// Lorentzian Peak function
Double_t lorentzianPeak(Double_t *x, Double_t *par) {
    return (0.5*par[0]*par[1]/TMath::Pi()) / TMath::Max(1.e-10,

```



```

    (x[0]-par[2])*(x[0]-par[2])+ .25*par[1]*par[1]);
}

// Sum of background and peak function
Double_t fitFunction(Double_t *x, Double_t *par) {
    return background(x,par) + lorentzianPeak(x,&par[3]);
}

void FittingDemo() {
    // bevington exercise by P. Malzacher, modified by R. Brun
    const int nBins = 60;
    Stat_t data[nBins] = { 6, 1,10,12, 6,13,23,22,15,21,
        23,26,36,25,27,35,40,44,66,81,
        75,57,48,45,46,41,35,36,53,32,
        40,37,38,31,36,44,42,37,32,32,
        43,44,35,33,33,39,29,41,32,44,
        26,39,29,35,32,21,21,15,25,15};
    TH1F *histo = new TH1F("example_9_1",
        "Lorentzian Peak on Quadratic Background",60,0,3);

    for(int i=0; i < nBins; i++) {
        // we use these methods to explicitly set the content
        // and error instead of using the fill method.
        histo->SetBinContent(i+1,data[i]);
        histo->SetBinError(i+1,TMath::Sqrt(data[i]));
    }
    // create a TF1 with the range from 0 to 3 and 6 parameters
    TF1 *fitFcn = new TF1("fitFcn",fitFunction,0,3,6);

    // first try without starting values for the parameters
    // this defaults to 1 for each param.
    histo->Fit("fitFcn");
    // this results in an ok fit for the polynomial function however
    // the non-linear part (Lorentzian

```

## 5.10 Associated Function

One or more objects (typically a **TF1\***) can be added to the list of functions (**fFunctions**) associated to each histogram. A call to **TH1::Fit** adds the fitted function to this list. Given a histogram **h**, one can retrieve the associated function with:

```
TF1 *myfunc = h->GetFunction("myfunc");
```

## 5.11 Access to the Fit Parameters and Results

If the histogram (or graph) is made persistent, the list of associated functions is also persistent. Retrieve a pointer to the function with the **TH1::GetFunction()** method. Then you can retrieve the fit parameters from the function (**\*\*TF1\*\***) with calls such as:

```

root[] TF1 *fit = hist->GetFunction(function_name);
root[] Double_t chi2 = fit->GetChisquare();
// value of the first parameter
root[] Double_t p1 = fit->GetParameter(0);
// error of the first parameter
root[] Double_t e1 = fit->GetParError(0);

```

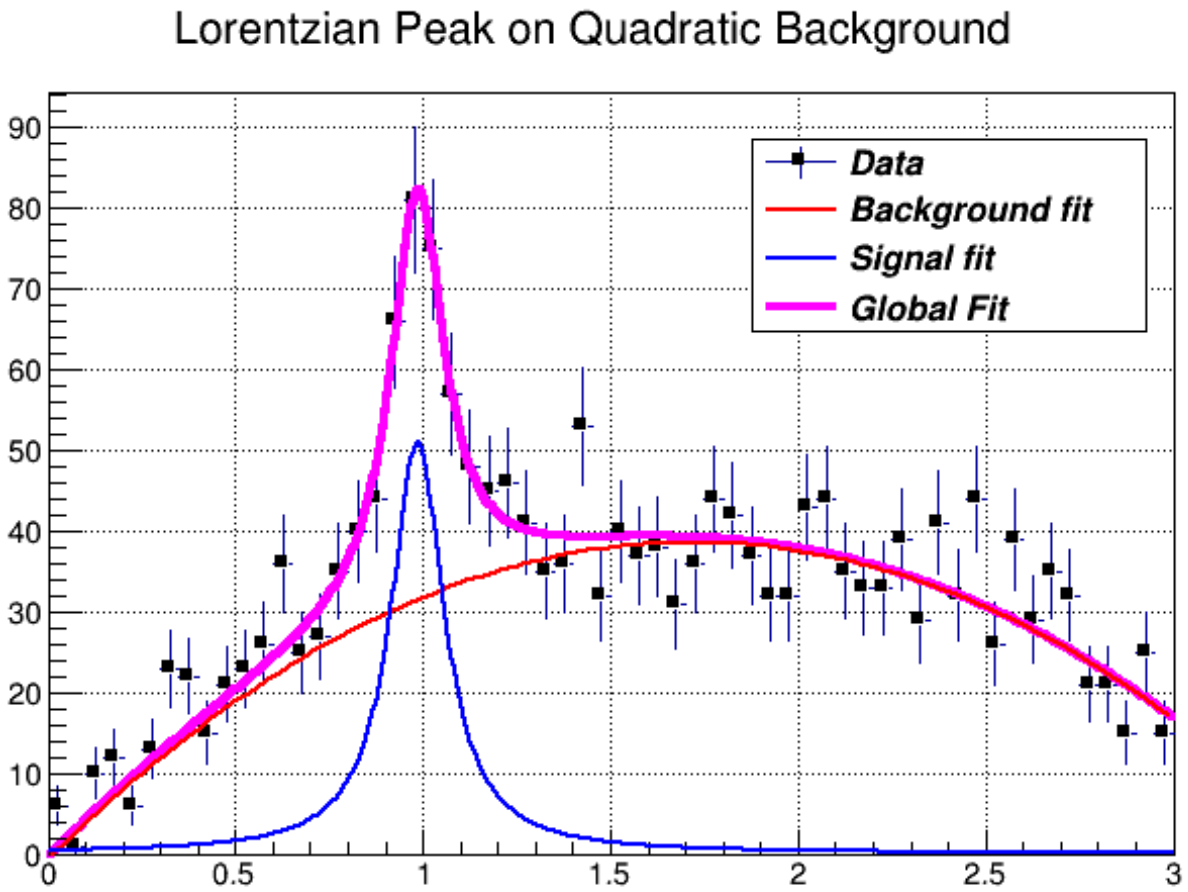

Figure 5.4: The output of the `FittingDemo()` example

## 5.12 Associated Errors

By default, for each bin, the sum of weights is computed at fill time. One can also call `TH1::Sumw2` to force the storage and computation of the sum of the square of weights per bin. If `Sumw2` has been called, the error per bin is computed as the `sqrt(sum of squares of weights)`; otherwise, the error is set equal to the `sqrt(bin content)`. To return the error for a given bin number, do:

```
Double_t error = h->GetBinError(bin);
```

Empty bins are excluded in the fit when using the Chi-square fit method. When fitting the histogram with the low statistics, it is recommended to use the Log-Likelihood method (option 'L' or "LL").

## 5.13 Fit Statistics

You can change the statistics box to display the fit parameters with the `TStyle::SetOptFit(mode)` method. This parameter has four digits: `mode = pcev` (default = 0111)

- p = 1 print probability
- c = 1 print Chi-square/number of degrees of freedom
- e = 1 print errors (if e=1, v must be 1)
- v = 1 print name/values of parameters

For example, to print the fit probability, parameter names/values, and errors, use:

```
gStyle->SetOptFit(1011);
```

## 5.14 The Minimization Package

This package was originally written in FORTRAN by Fred James and part of `PACKLIB` (patch D506). It has been converted to a C++ class by René Brun. The current implementation in C++ is a straightforward conversion of the original FORTRAN version. The main changes are:

- The variables in the various `Minuit` labeled common blocks have been changed to the `TMinuit` class data members
- The internal arrays with a maximum dimension depending on the maximum number of parameters are now data members' arrays with a dynamic dimension such that one can fit very large problems by simply initializing the `TMinuit` constructor with the maximum number of parameters
- The include file `Minuit.h` has been commented as much as possible using existing comments in the code or the printed documentation
- The original `Minuit` subroutines are now member functions
- Constructors and destructor have been added
- Instead of passing the `FCN` function in the argument list, the addresses of this function is stored as pointer in the data members of the class. This is by far more elegant and flexible in an interactive environment. The member function `SetFCN` can be used to define this pointer
- The `ROOT` static function `Printf` is provided to replace all format statements and to print on currently defined output file
- The derived class `TMinuitOld` contains obsolete routines from the FORTRAN based version
- The functions `SetObjectFit/GetObjectFit` can be used inside the `FCN` function to set/get a referenced object instead of using global variables

- By default `fGraphicsMode` is true. When calling the `Minuit` functions such as `mncont`, `mnscan`, or any `Minuit` command invoking `mnplot`, `TMinuit::mnplot()` produces a `TGraph` object pointed by `fPlot`. One can retrieve this object with `TMinuit::GetPlot()`. For example:

```
h->Fit("gaus");
gMinuit->Command("SCAN 1");
TGraph *gr = (TGraph*)gMinuit->GetPlot();
gr->SetMarkerStyle(21);
gr->Draw("alp");
```

- To set `Minuit` in no graphics mode, call

```
gMinuit->SetGraphicsMode(kFALSE);
```

### 5.14.1 Basic Concepts of Minuit

The `Minuit` package acts on a multi parameter FORTRAN function to which one must give the generic name `FCN`. In the ROOT implementation, the function `FCN` is defined via the `Minuit SetFCN` member function when a `HistogramFit` command is invoked. The value of `FCN` will in general depend on one or more variable parameters.

To take a simple example, in case of ROOT histograms (classes `TH1C`, `TH1S`, `TH1F`, `TH1D`) the `Fit` function defines the `Minuit` fitting function as being `H1FitChisquare` or `H1FitLikelihood` depending on the options selected. `H1FitChisquare` calculates the chi-square between the user fitting function (Gaussian, polynomial, user defined, etc) and the data for given values of the parameters. It is the task of `Minuit` to find those values of the parameters which give the lowest value of chi-square.

### 5.14.2 The Transformation of Limited Parameters

For variable parameters with limits, `Minuit` uses the following transformation:

$$P_{int} = \arcsin(2((P_{ext}-a)/(b-a))-1)$$

$$P_{ext} = a + ((b-a)/(2))(\sin P_{int} + 1)$$

so that the internal value `Pint` can take on any value, while the external value `Pext` can take on values only between the lower limit `a` and the ext upper limit `b`. Since the transformation is necessarily non-linear, it would transform a nice linear problem into a nasty non-linear one, which is the reason why limits should be avoided if not necessary. In addition, the transformation does require some computer time, so it slows down the computation a little bit, and more importantly, it introduces additional numerical inaccuracy into the problem in addition to what is introduced in the numerical calculation of the `FCN` value. The effects of non-linearity and numerical round off both become more important as the external value gets closer to one of the limits (expressed as the distance to nearest limit divided by distance between limits). The user must therefore be aware of the fact that, for example, if he puts limits of (0, 1010) on a parameter, then the values 0.0 and 1. 0 will be indistinguishable to the accuracy of most machines.

The transformation also affects the parameter error matrix, of course, so `Minuit` does a transformation of the error matrix (and the “parabolic” parameter errors) when there are parameter limits. Users should however realize that the transformation is only a linear approximation, and that it cannot give a meaningful result if one or more parameters is very close to a limit, where  $\frac{\partial P_{ext}}{\partial P_{int}} \neq 0$ . Therefore, it is recommended that:

- Limits on variable parameters should be used only when needed in order to prevent the parameter from taking on unphysical values
- When a satisfactory minimum has been found using limits, the limits should then be removed if possible, in order to perform or re-perform the error analysis without limits

### 5.14.3 How to Get the Right Answer from Minuit

`Minuit` offers the user a choice of several minimization algorithms. The `MIGRAD` algorithm is in general the best minimized for nearly all functions. It is a variable-metric method with inexact line search, a stable metric updating scheme, and checks for positive-definiteness. Its main weakness is that it depends heavily on knowledge of the first derivatives, and fails miserably if they are very inaccurate.

If parameter limits are needed, in spite of the side effects, then the user should be aware of the following techniques to alleviate problems caused by limits:

#### 5.14.3.1 Getting the Right Minimum with Limits

If `MIGRAD` converges normally to a point where no parameter is near one of its limits, then the existence of limits has probably not prevented `Minuit` from finding the right minimum. On the other hand, if one or more parameters is near its limit at the minimum, this may be because the true minimum is indeed at a limit, or it may be because the minimized has become “blocked” at a limit. This may normally happen only if the parameter is so close to a limit (internal value at an odd multiple of  $\pm\frac{\pi}{2}$ ) that `Minuit` prints a warning to this effect when it prints the parameter values. The minimized can become blocked at a limit, because at a limit the derivative seen by the minimized  $\frac{\partial F}{\partial P_{int}}$  is zero no matter what the real derivative  $\frac{\partial F}{\partial P_{ext}}$  is.

$$\left(\frac{\partial F}{\partial P_{int}}\right) = \left(\frac{\partial F}{\partial P_{ext}}\right) \left(\frac{\partial P_{ext}}{\partial P_{int}}\right) = \left(\frac{\partial F}{\partial P_{ext}}\right) = 0$$

#### 5.14.3.2 Getting the Right Parameter Errors with Limits

In the best case, where the minimum is far from any limits, `Minuit` will correctly transform the error matrix, and the parameter errors it reports should be accurate and very close to those you would have got without limits. In other cases (which should be more common, since otherwise you would not need limits), the very meaning of parameter errors becomes problematic. Mathematically, since the limit is an absolute constraint on the parameter, a parameter at its limit has no error, at least in one direction. The error matrix, which can assign only symmetric errors, then becomes essentially meaningless.

#### 5.14.3.3 Interpretation of Parameter Errors

There are two kinds of problems that can arise: the reliability of `Minuit`'s error estimates, and their statistical interpretation, assuming they are accurate.

#### 5.14.3.4 Statistical Interpretation

For discussion of basic concepts, such as the meaning of the elements of the error matrix, or setting of exact confidence levels see the articles:

- F.James. Determining the statistical Significance of experimental Results. Technical Report DD/81/02 and CERN Report 81-03, CERN, 1981
- W.T.Eadie, D.Drijard, F.James, M.Roos, and B.Sadoulet. *Statistical Methods in Experimental Physics*. North-Holland, 1971

### 5.14.4 Reliability of Minuit Error Estimates

`Minuit` always carries around its own current estimates of the parameter errors, which it will print out on request, no matter how accurate they are at any given point in the execution. For example, at initialization, these estimates are just the starting step sizes as specified by the user. After a `HESSE` step, the errors are usually quite accurate, unless there has been a problem. `Minuit`, when it prints out error values, also gives some indication of how reliable it thinks they are. For example, those marked `CURRENT GUESS ERROR` are only working values not to be believed, and `APPROXIMATE ERROR` means that they have been calculated but there is reason to believe that they may not be accurate.

If no mitigating adjective is given, then at least `Minuit` believes the errors are accurate, although there is always a small chance that `Minuit` has been fooled. Some visible signs that `Minuit` may have been fooled:

- Warning messages produced during the minimization or error analysis
- Failure to find new minimum
- Value of EDM too big (estimated Distance to Minimum)
- Correlation coefficients exactly equal to zero, unless some parameters are known to be uncorrelated with the others
- Correlation coefficients very close to one (greater than 0.99). This indicates both an exceptionally difficult problem, and one which has been badly parameterized so that individual errors are not very meaningful because they are so highly correlated
- Parameter at limit. This condition, signaled by a `Minuit` warning message, may make both the function minimum and parameter errors unreliable. See the discussion above ‘Getting the right parameter errors with limits’

The best way to be absolutely sure of the errors is to use “independent” calculations and compare them, or compare the calculated errors with a picture of the function. Theoretically, the covariance matrix for a “physical” function must be positive-definite at the minimum, although it may not be so for all points far away from the minimum, even for a well-determined physical problem. Therefore, if `MIGRAD` reports that it has found a non-positive-definite covariance matrix, this may be a sign of one or more of the following:

#### 5.14.4.1 A Non-physical Region

On its way to the minimum, `MIGRAD` may have traversed a region that has unphysical behavior, which is of course not a serious problem as long as it recovers and leaves such a region.

#### 5.14.4.2 An Underdetermined Problem

If the matrix is not positive-definite even at the minimum, this may mean that the solution is not well defined, for example that there are more unknowns than there are data points, or that the parameterization of the fit contains a linear dependence. If this is the case, then `Minuit` (or any other program) cannot solve your problem uniquely. The error matrix will necessarily be largely meaningless, so the user must remove the under determinedness by reformulating the parameterization. `Minuit` cannot do this itself.

#### 5.14.4.3 Numerical Inaccuracies

It is possible that the apparent lack of positive-definiteness is due to excessive round off errors in numerical calculations (in the user function), or not enough precision. This is unlikely in general, but becomes more likely if the number of free parameters is very large, or if the parameters are badly scaled (not all of the same order of magnitude), and correlations are large. In any case, whether the non-positive-definiteness is real or only numerical is largely irrelevant, since in both cases the error matrix will be unreliable and the minimum suspicious.

#### 5.14.4.4 An Ill-posed Problem

For questions of parameter dependence, see the discussion above on positive-definiteness. Possible other mathematical problems are the following:

- Excessive numerical round off - be especially careful of exponential and factorial functions which get big very quickly and lose accuracy.
- Starting too far from the solution - the function may have unphysical local minima, especially at infinity in some variables.

## 5.15 FUMILI Minimization Package

FUMILI is used to minimize Chi-square function or to search maximum of likelihood function. Experimentally measured values  $F_i$  are fitted with theoretical functions  $f_i(\vec{x}_i, \vec{\theta})$ , where  $\vec{x}_i$  are coordinates, and  $\vec{\theta}$  - vector of parameters. For better convergence Chi-square function has to be the following form

$$\frac{\chi^2}{2} = \frac{1}{2} \sum_{i=1}^n \left( \frac{f_i(\vec{x}_i, \vec{\theta}) - F_i}{\sigma_i} \right)^2$$

where  $\sigma_i$  are errors of the measured function. The minimum condition is:

$$\frac{\partial \chi^2}{\partial \theta_i} = \sum_{j=1}^n \frac{1}{\sigma_j^2} \cdot \frac{\partial f_j}{\partial \theta_i} \left[ (f_j, \vec{\theta}) - F_j \right] = 0, i = 1 \dots m$$

where  $m$  is the quantity of parameters. Expanding left part of this equation over parameter increments and retaining only linear terms one gets

$$\left( \frac{\partial \chi^2}{\partial \theta_i} \right)_{\theta = \vec{\theta}^0} + \sum_k \left( \frac{\partial^2 \chi^2}{\partial \theta_i \partial \theta_k} \right)_{\theta = \vec{\theta}^0} \cdot (\theta_k - \theta_k^0) = 0$$

here  $\vec{\theta}^0$  is some initial value of parameters. In general case:

$$\frac{\partial^2 \chi^2}{\partial \theta_i \partial \theta_k} = \sum_{j=1}^n \frac{1}{\sigma_j^2} \frac{\partial f_j}{\partial \theta_i} \frac{\partial f_j}{\partial \theta_k} + \sum_{j=1}^n \frac{(f_j - F_j)}{\sigma_j^2} \cdot \frac{\partial^2 f_j}{\partial \theta_i \partial \theta_k}$$

In FUMILI algorithm for second derivatives of Chi-square approximate expression is used when last term in previous equation is discarded. It is often done, not always wittingly, and sometimes causes troubles, for example, if user wants to limit parameters with positive values by writing down  $\theta_i^2$  instead of  $\theta_i$ . FUMILI will fail if one tries minimize  $\chi^2 = g^2(\vec{\theta})$  where  $g$  is arbitrary function.

Approximate value is:

$$\frac{\partial^2 \chi^2}{\partial \theta_i \partial \theta_k} \approx Z_{ik} = \sum_{j=1}^n \frac{1}{\sigma_j^2} \frac{\partial f_j}{\partial \theta_i} \frac{\partial f_j}{\partial \theta_k}$$

Then the equations for parameter increments are:

$$\left( \frac{\partial \chi^2}{\partial \theta_i} \right)_{\vec{\theta} = \vec{\theta}^0} + \sum_k Z_{ik} \cdot (\theta_k - \theta_k^0) = 0, \quad i = 1 \dots m$$

Remarkable feature of algorithm is the technique for step restriction. For an initial value of parameter  $\vec{\theta}^0$  a parallelepiped  $P_0$  is built with the center at  $\vec{\theta}^0$  and axes parallel to coordinate axes  $\theta_i$ . The lengths of parallelepiped sides along  $i$ -th axis is  $2b_i$ , where  $b_i$  is such a value that the functions  $f_j(\vec{\theta})$  are quasi-linear all over the parallelepiped.

FUMILI takes into account simple linear inequalities in the form:

$$\theta_i^{\min} \leq \theta_i \leq \theta_i^{\max}$$

They form parallelepiped  $P$  ( $P_0$  may be deformed by  $P$ ). Very similar step formulae are used in FUMILI for negative logarithm of the likelihood function with the same idea - linearization of function argument.

## 5.16 Neural Networks

### 5.16.1 Introduction

Neural Networks are used in various fields for data analysis and classification, both for research and commercial institutions. Some randomly chosen examples are image analysis, financial movements' predictions and analysis, or sales forecast and product shipping optimization. In particles physics neural networks are mainly used for classification tasks (signal over background discrimination). A vast majority of commonly used neural networks are multilayer perceptrons. This implementation of multilayer perceptrons is inspired from the `MLPfit` package, which remains one of the fastest tools for neural networks studies.

### 5.16.2 The MLP

The multilayer perceptron is a simple feed-forward network with the following structure showed on the left.

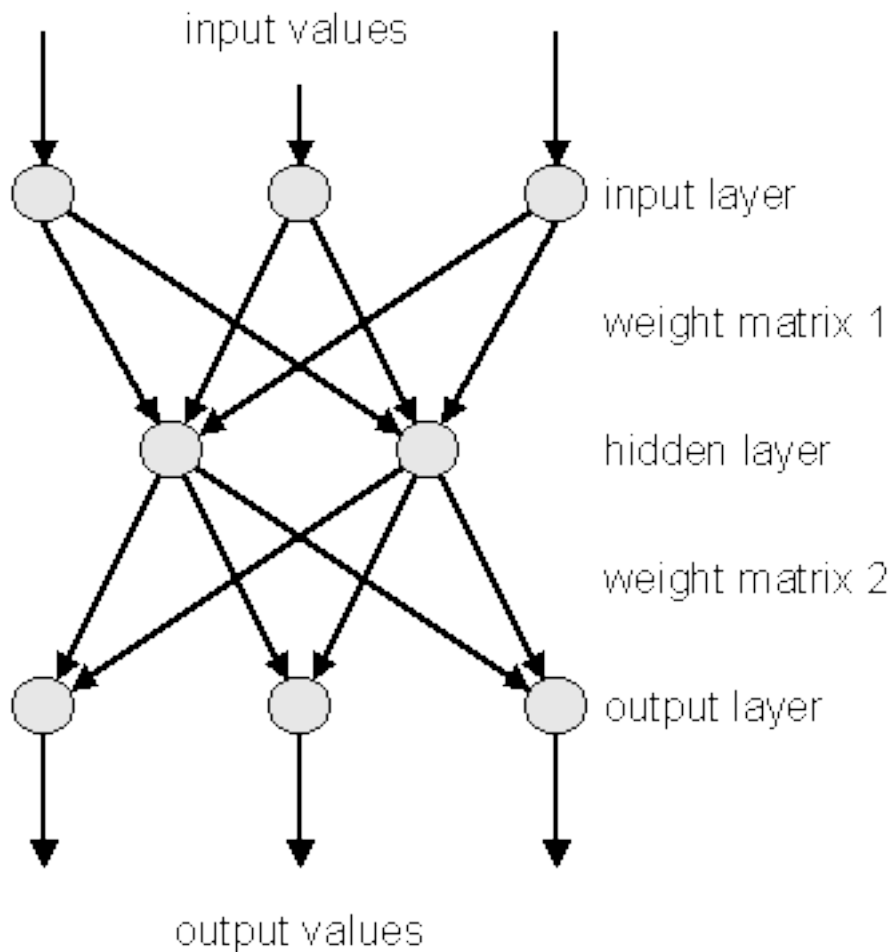

It is made of neurons characterized by a bias and weighted links in between - let's call those links synapses. The input neurons receive the inputs, normalize them and forward them to the first hidden layer. Each neuron in any subsequent layer first computes a linear combination of the outputs of the previous layer. The output of the neuron is then function of that combination with  $f$  being linear for output neurons or a sigmoid for hidden layers.

Such a structure is very useful because of two theorems:

- 1- A linear combination of **sigmoids** can approximate any continuous function.
- 2- Trained with **output=1** for the signal and 0 for the background, the approximated function of inputs  $X$  is the probability of signal, knowing  $X$ .



### 5.16.3 Learning Methods

The aim of all learning methods is to minimize the total error on a set of weighted examples. The error is defined as the sum in quadrate, divided by two, of the error on each individual output neuron. In all methods implemented in this library, one needs to compute the first derivative of that error with respect to the weights. Exploiting the well-known properties of the derivative, one can express this derivative as the product of the local partial derivative by the weighted sum of the outputs derivatives (for a neuron) or as the product of the input value with the local partial derivative of the output neuron (for a synapse). This computation is called “back-propagation of the errors”. Six learning methods are implemented.

#### 5.16.3.1 Stochastic Minimization

This is the most trivial learning method. The Robbins-Monro stochastic approximation is applied to multilayer perceptrons. The weights are updated after each example according to the formula:

$$w_{ij}(t+1) = w_{ij}(t) + \Delta w_{ij}(t)$$

with:

$$\Delta w_{ij}(t) = -\eta \left( \frac{\partial e_p}{\partial w_{ij}} + \delta \right) + \epsilon \Delta w_{ij}(t-1)$$

The parameters for this method are `Eta`, `EtaDecay`, `Delta` and `Epsilon`.

#### 5.16.3.2 Steepest Descent With Fixed Step Size (Batch Learning)

It is the same as the stochastic minimization, but the weights are updated after considering all the examples, with the total derivative `dEdw`. The parameters for this method are `Eta`, `EtaDecay`, `Delta` and `Epsilon`.

#### 5.16.3.3 Steepest Descent Algorithm

Weights are set to the minimum along the line defined by the gradient. The only parameter for this method is `Tau`. Lower `Tau` = higher precision = slower search. A value `Tau=3` seems reasonable.

#### 5.16.3.4 Conjugate Gradients With the Polak-Ribiere Updating Formula

Weights are set to the minimum along the line defined by the conjugate gradient. Parameters are `Tau` and `Reset`, which defines the epochs where the direction is reset to the steepest descent (estimated by using the Polak-Ribiere formula).

#### 5.16.3.5 Conjugate Gradients With the Fletcher-Reeves Updating Formula

Weights are set to the minimum along the line defined by the conjugate gradient. Parameters are `Tau` and `Reset`, which defines the epochs where the direction is reset to the steepest descent (estimated by using the Fletcher-Reeves formula).

#### 5.16.3.6 The Broyden, Fletcher, Goldfarb, Shanno (BFGS) Method

It implies the computation of a  $N \times N$  matrix, but seems more powerful at least for less than 300 weights. Parameters are `Tau` and `Reset`, which defines the epochs where the direction is reset to the steepest descent.

### 5.16.4 Using the Network

Neural network are build from a set of “samples”. A sample is a set of values defining the inputs and the corresponding output that the network should ideally provide. In ROOT this is a **TTree** entry. The first thing to be decided is the network layout. This layout is described in a string where the layers are separated by semicolons. The input/output layers are defined by giving the expression for each neuron, separated by comas. Hidden layers are just described by the number of neurons.

In addition, input and output layer formulas can be preceded by ‘@’ (e.g. “@out”) if one wants to normalize the corresponding value. Also, if the string ends with ‘!’, output neurons are set up for classification, i.e. with a sigmoid (1 neuron) or softmax (more neurons) activation function.

Many questions on the good usage of neural network, including rules of thumb to determine the best network topology are addressed at <ftp://ftp.sas.com/pub/neural/FAQ.html>

```
// a simple network: 2 inputs, 10 hidden and 1 normalized
// output neuron
TMultiLayerPerceptron network("r,z:10:@Br",tree);
```

Expressions are evaluated as for **TTree::Draw()**. Input and outputs are taken from the **TTree** associated with the network. This **TTree** can be given as argument of the constructor or defined later with **TMultiLayerPerceptron::SetData()**. Events can also be weighted. The weight expression can be given in the constructor or set later with the method **SetWeight()** of the class **TMultiLayerPerceptron**. Two datasets must be defined before learning the network: a training dataset that is used when minimizing the error, and a test dataset that will avoid bias. Those two datasets can be build aside and then given to the network, or can be build from a standard expression. By default, half of the events are put in both datasets.

```
// a more complex 4:8:1 network
// the ptsumf branch is used as weigh;
// default event lists are explicit
TMultiLayerPerceptron network("m,pt,acol,acopl:8:type","pt",tree,
                             "Entry$%2","Entry$/2");
```

The method **TMultiLayerPerceptron::SetLearningMethod()** defines the learning method. Learning methods are:

```
TMultiLayerPerceptron::kStochastic,
TMultiLayerPerceptron::kBatch,
TMultiLayerPerceptron::kSteepestDescent,
TMultiLayerPerceptron::kRibierePolak,
TMultiLayerPerceptron::kFletcherReeves,
TMultiLayerPerceptron::kBFGS // default
```

The training can start with **TMultiLayerPerceptron::Train(Int\_t nepoch,Option\_t\* options)**. The first argument is the number of epochs while option is a string that can contain “text” (simple text output), “graph” (evaluating graphical training curves), “update = X” (step for the text/graph output update) or “+” (will skip the randomization and start from the previous values). All combinations are available.

```
network.Train(1000,"text,graph,update=10"); // full output every
                                           // 10 epochs
network.Train(100,"text,+"); // 100 more epochs
//starts with existing weights
```

The weights can be saved to a file (**DumpWeights**) and then reloaded (**LoadWeights**) to a new compatible network. The output can also be evaluated (**Evaluate**) for a given output neuron and an array of double input parameters or the network can be exported (**Export**) as a standalone code. Up to now, this is only as a C++ or PYTHON class, but other languages could be implemented.

### 5.16.5 Examples

An example of how to use `TMultiLayerPerceptron` is the macro `mlpHiggs.C` in `$ROOTSYS/tutorials`. Using some standard simulated information that could have been obtained at LEP, a neural network is build, which can make the difference between WW events and events containing a Higgs boson. Starting with a `TFile` containing two `TTrees`: one for the signal, the other for the background, a simple script is used:

```
void mlpHiggs(Int_t ntrain=100) {
  if (!gROOT->GetClass("TMultiLayerPerceptron"))
    gSystem->Load("libMPL");
  // prepare inputs - the 2 trees are merged into one, and a
  // "type" branch, equal to 1 for the signal and 0 for the
  // background is added
  TFile input("mlpHiggs.root");
  TTree *signal = (TTree *)input.Get("sig_filtered");
  TTree *background = (TTree *)input.Get("bg_filtered");
  TTree *simu = new TTree("MonteCarlo",
    "Filtered Monte Carlo Events");
  ...
}
```

Since the input is a `TTree` and we are starting from two different `TTrees` (with different names), they are first merged into one, and a “type” branch is added, that says whether there is a signal or a background event. Those irrelevant details are skipped here.

```
...
TMultiLayerPerceptron *mlp = new TMultiLayerPerceptron(
  "msumf,ptsumf, acoln, acopl:8:type", "ptsumf", simu,
  "Entry$/2", "Entry$/2");
mlp->Train(ntrain, "text,graph,update=10");
```

The neural network is instantiated and trained. “ptsumf” is used as a weight, and the standard event lists are explicit. The network that is then build has four input neurons, eight additional ones in the only hidden layer and one single output neuron.

```
// Use the NN to plot the results for each sample
TH1F *bg = new TH1F("bgh", "NN output", 50, -.5, 1.5);
TH1F *sig = new TH1F("sigh", "NN output", 50, -.5, 1.5);
bg->SetDirectory(0);
sig->SetDirectory(0);
Double_t params[4];
for (i = 0; i < background->GetEntries(); i++) {
  background->GetEntry(i);
  params[0] = msumf;   params[1] = ptsumf;
  params[2] = acoln;   params[3] = acopl;
  bg->Fill(mlp->Evaluate(0, params));
}
for (i = 0; i < signal->GetEntries(); i++) {
  signal->GetEntry(i);
  params[0] = msumf;
  params[1] = ptsumf;
  params[2] = acoln;
  params[3] = acopl;
  sig->Fill(mlp->Evaluate(0, params));
}
TCanvas *cv = new TCanvas("NNout_cv", "Neural net output");
bg->SetFillStyle(3008);
bg->SetFillColor(kBlue);
sig->SetFillStyle(3003);
```

```

sig->SetFillColor(kRed);
bg->SetStats(0);
sig->SetStats(0);
bg->Draw();
sig->Draw("same");
TLegend *legend = new TLegend(.75,.80,.95,.95);
legend->AddEntry(bg,"Background(WW)");
legend->AddEntry(sig,"Signal(Higgs)");
legend->Draw();

```

The neural net output is then used to display the final difference between background and signal events. The figure “The neural net output” shows this plot.

## NN output

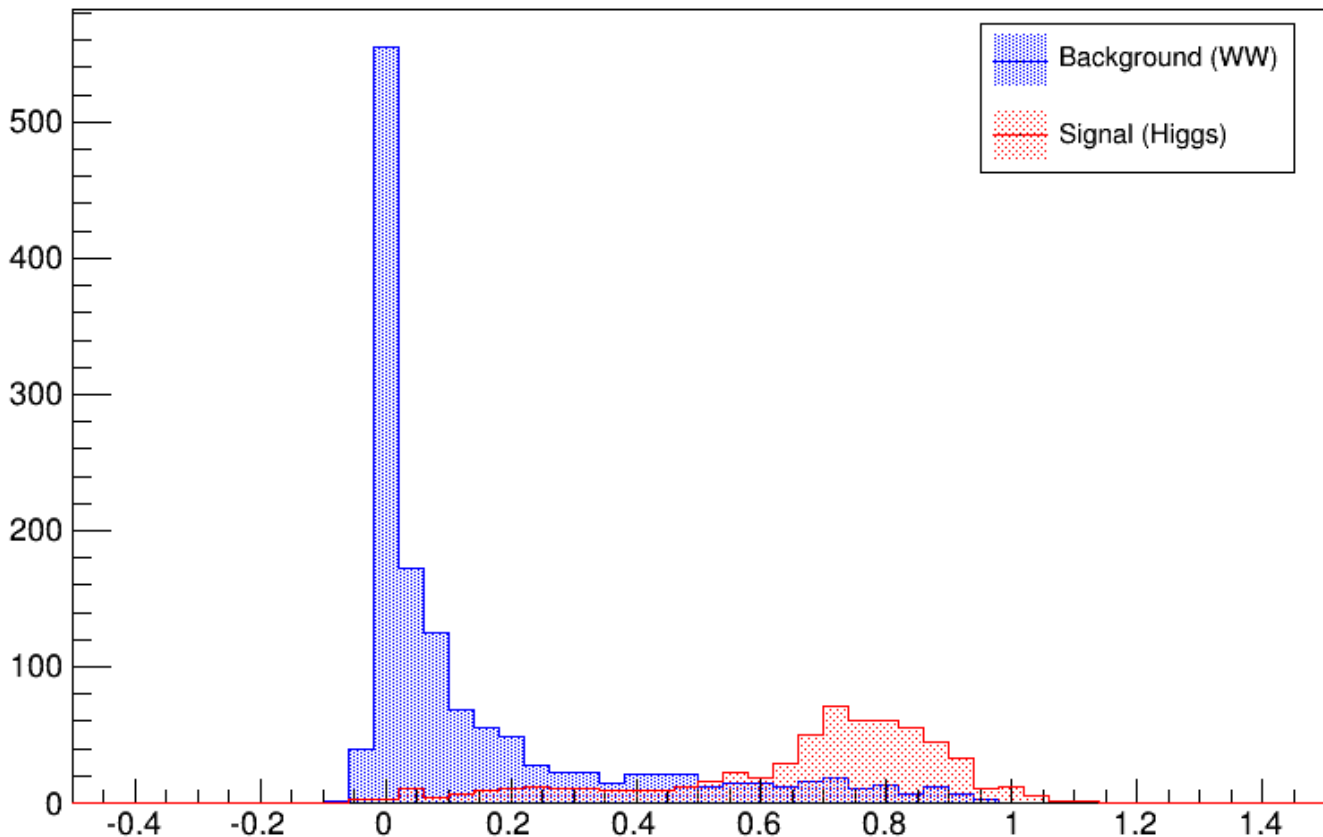

Figure 5.5: The neural net output

As it can be seen, this is a quite efficient technique. As mentioned earlier, neural networks are also used for fitting function. For some application with a cylindrical symmetry, a magnetic field simulation gives as output the angular component of the potential vector  $A$ , as well as the radial and  $z$  components of the  $B$  field.

One wants to fit those distributions with a function in order to plug them into the **Geant** simulation code. Polynomial fits could be tried, but it seems difficult to reach the desired precision over the full range. One could also use a **spline** interpolation between known points. In all cases, the resulting field would not be  $C$ -infinite.

An example of output (for  $Br$ ) is shown. First the initial function can be seen as the target. Then, the resulting (normalized) neural net output. In order to ease the learning, the “normalize output” was used here. The initial amplitude can be recovered by multiplying by the original RMS and then shifting by the original mean.

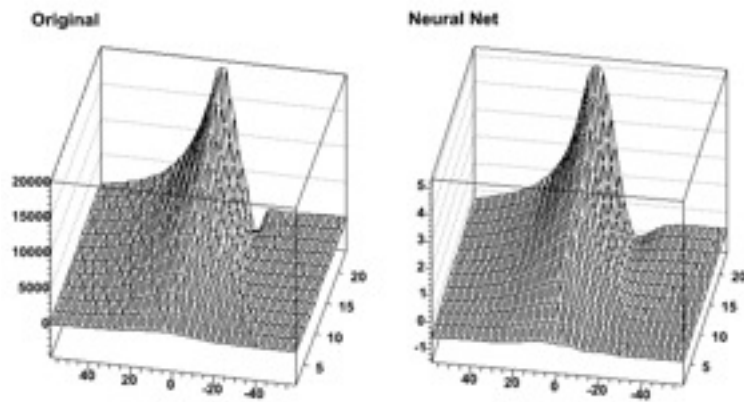

Figure 5.6: The original and the neural net for Br



# Chapter 6

## A Little C++

This chapter introduces you to some useful insights into C++, to allow you to use of the most advanced features in ROOT. It is in no case a full course in C++.

### 6.1 Classes, Methods and Constructors

C++ extends C with the notion of class. If you're used to structures in C, a class is a `struct` that is a group of related variables, which is extended with functions and routines specific to this structure (class). What is the interest? Consider a `struct` that is defined this way:

```
struct Line {  
    float x1;  
    float y1;  
    float x2;  
    float y2;  
}
```

This structure represents a line to be drawn in a graphical window.  $(x_1, y_1)$  are the coordinates of the first point,  $(x_2, y_2)$  the coordinates of the second point. In the standard C, if you want to draw effectively such a line, you first have to define a structure and initialize the points (you can try this):

```
Line firstline;  
firstline.x1 = 0.2;  
firstline.y1 = 0.2;  
firstline.x2 = 0.8;  
firstline.y2 = 0.9;
```

This defines a line going from the point  $(0.2, 0.2)$  to the point  $(0.8, 0.9)$ . To draw this line, you will have to write a function, say `LineDraw(Line l)` and call it with your object as argument:

```
LineDraw(firstline);
```

In C++, we would not do that. We would instead define a class like this:

```
class TLine {  
    Double_t x1;  
    Double_t y1;  
    Double_t x2;  
    Double_t y2;  
    TLine(int x1, int y1, int x2, int y2);  
    void Draw();  
}
```

Here we added two functions, that we will call methods or member functions, to the **TLine** class. The first method is used for initializing the line objects we would build. It is called a constructor. The second one is the **Draw** method itself. Therefore, to build and draw a line, we have to do:

```
TLine l(0.2,0.2,0.8,0.9);
l.Draw();
```

The first line builds the object **l** by calling its constructor. The second line calls the **TLine::Draw()** method of this object. You don't need to pass any parameters to this method since it applies to the object **l**, which knows the coordinates of the line. These are internal variables **x1**, **y1**, **x2**, **y2** that were initialized by the constructor.

## 6.2 Inheritance and Data Encapsulation

We have defined a **TLine** class that contains everything necessary to draw a line. If we want to draw an arrow, is it so different from drawing a line? We just have to draw a triangle at one end. It would be very inefficient to define the class **TArrow** from scratch. Fortunately, inheritance allows a class to be defined from an existing class. We would write something like:

```
class TArrow : public TLine {
    int ArrowHeadSize;
    void Draw();
    void SetArrowSize(int arrowsize);
}
```

The keyword “**public**” will be explained later. The class **TArrow** now contains everything that the class **TLine** does, and a couple of things more, the size of the arrowhead and a function that can change it. The **Draw** method of **TArrow** will draw the head and call the draw method of **TLine**. We just have to write the code for drawing the head!

### 6.2.1 Method Overriding

Giving the same name to a method (remember: method = member function of a class) in the child class (**TArrow**) as in the parent (**TLine**) does not give any problem. This is called **overriding** a method. **Draw** in **TArrow** overrides **Draw** in **TLine**. There is no possible ambiguity since, when one calls the **Draw()** method; this applies to an object which type is known. Suppose we have an object **l** of type **TLine** and an object **a** of type **TArrow**. When you want to draw the line, you do:

```
l.Draw();
```

**Draw()** from **TLine** is called. If you do:

```
a.Draw();
```

**Draw()** from **TArrow** is called and the arrow **a** is drawn.

### 6.2.2 Data Encapsulation

We have seen previously the keyword “**public**”. This keyword means that every name declared public is seen by the outside world. This is opposed to “**private**” that means only the class where the name was declared private could see this name. For example, suppose we declare in **TArrow** the variable **ArrowHeadSize** private.

```
private:
    int ArrowHeadSize;
```



Then, only the methods (i.e. member functions) of **TArrow** will be able to access this variable. Nobody else will see it. Even the classes that we could derive from **TArrow** will not see it. On the other hand, if we declare the method **Draw()** as public, everybody will be able to see it and use it. You see that the character public or private does not depend of the type of argument. It can be a data member, a member function, or even a class. For example, in the case of **TArrow**, the base class **TLine** is declared as public:

```
class TArrow : public TLine { ...
```

This means that all methods of **TArrow** will be able to access all methods of **TLine**, but this will be also true for anybody in the outside world. Of course, this is true if **TLine** accepts the outside world to see its methods/data members. If something is declared private in **TLine**, nobody will see it, not even **TArrow** members, even if **TLine** is declared as a public base class.

What if **TLine** is declared “private” instead of “public”? Well, it will behave as any other name declared private in **TArrow**: only the data members and methods of **TArrow** will be able to access **TLine**, its methods and data members, nobody else. This may seem a little bit confusing and readers should read a good C++ book if they want more details. Especially since, besides public and private, a member can be protected. Usually, one puts private the methods that the class uses internally, like some utilities classes, and that the programmer does not want to be seen in the outside world.

With “good” C++ practice (which we have tried to use in ROOT), all data members of a class are private. This is called data encapsulation and is one of the strongest advantages of Object Oriented Programming (OOP). Private data members of a class are not visible, except to the class itself. So, from the outside world, if one wants to access those data members, one should use so called “getters” and “setters” methods, which are special methods used only to get or set the data members. The advantage is that if the programmers want to modify the inner workings of their classes, they can do so without changing what the user sees. The user does not even have to know that something has changed (for the better, hopefully). For example, in our **TArrow** class, we would have set the data member **ArrowHeadSize** private. The setter method is **SetArrowSize()**, we do not need a getter method:

```
class TArrow : public TLine {
private:
    int ArrowHeadSize;
public:
    void Draw();
    void SetArrowSize(int arrowsize);
}
```

To define an arrow object you call the constructor. This will also call the constructor of **TLine**, which is the parent class of **TArrow**, automatically. Then we can call any of the line or arrow public methods:

```
root[] TArrow *myarrow = new TArrow(1,5,89,124);
root[] myarrow->SetArrowSize(10);
root[] myarrow->Draw();
```

## 6.3 Creating Objects on the Stack and Heap

To explain how objects are created on the stack and on the heap we will use the **Quad** class. You can find the definition in `$ROOTSYS/tutorials/quadp/Quad.h` and `Quad.cxx`. The **Quad** class has four methods. The constructor and destructor, **Evaluate** that evaluates  $ax^2 + bx + c$ , and **Solve** which solves the quadratic equation  $ax^2 + bx + c = 0$ .

Quad.h :

```
class Quad {
public:
    Quad(Float_t a, Float_t b, Float_t c);
    ~Quad();
    Float_t Evaluate(Float_t x) const;
    void Solve() const;
private:
```

```

    Float_t fA;
    Float_t fB;
    Float_t fC;
};

```

Quad.cxx:

```

#include <iostream.h>
#include <math.h>
#include "Quad.h"

Quad::Quad(Float_t a, Float_t b, Float_t c) {
    fA = a;
    fB = b;
    fC = c;
}

Quad::~Quad() {
    Cout <<"deleting object with coeffs: "<< fA << "," << fB << ","
        << fC << endl;
}

Float_t Quad::Evaluate(Float_t x) const {
    return fA*x*x + fB*x + fC;
}

void Quad::Solve() const {
    Float_t temp = fB*fB - 4.*fA*fC;
    if ( temp > 0. ) {
        temp = sqrt( temp );
        cout << "There are two roots: " << ( -fB - temp ) / (2.*fA)
            << " and " << ( -fB + temp ) / (2.*fA) << endl;
    } else {
        if ( temp == 0. ) {
            cout << "There are two equal roots: " << -fB / (2.*fA)
                << endl;
        } else {
            cout << "There are no roots" << endl;
        }
    }
}
}

```

Let us first look how we create an object. When we create an object by:

```
root[] Quad my_object(1.,2.,-3.);
```

We are creating an object on the stack. A FORTRAN programmer may be familiar with the idea; it is not unlike a local variable in a function or subroutine. Although there are still a few old timers who do not know it, FORTRAN is under no obligation to save local variables once the function or subroutine returns unless the SAVE statement is used. If not then it is likely that FORTRAN will place them on the stack and they will “pop off” when the RETURN statement is reached. To give an object more permanence it has to be placed on the heap.

```
root[] .L Quad.cxx
root[] Quad *my_objptr = new Quad(1.,2.,-3.);
```

The second line declares a pointer to Quad called my\_objptr. From the syntax point of view, this is just like all the other declarations we have seen so far, i.e. this is a stack variable. The value of the pointer is set equal to

```
new Quad(1.,2.,-3.);
```

`new`, despite its looks, is an operator and creates an object or variable of the type that comes next, `Quad` in this case, on the heap. Just as with stack objects it has to be initialized by calling its constructor. The syntax requires that the argument list follow the type. This one statement has brought two items into existence, one on the heap and one on the stack. The heap object will live until the delete operator is applied to it.

There is no FORTRAN parallel to a heap object; variables either come or go as control passes in and out of a function or subroutine, or, like a COMMON block variables, live for the lifetime of the program. However, most people in HEP who use FORTRAN will have experience of a memory manager and the act of creating a bank is a good equivalent of a heap object. For those who know systems like ZEBRA, it will come as a relief to learn that objects do not move, C++ does not garbage collect, so there is never a danger that a pointer to an object becomes invalid for that reason. However, having created an object, it is the user's responsibility to ensure that it is deleted when no longer needed, or to pass that responsibility onto to some other object. Failing to do that will result in a memory leak, one of the most common and most hard-to-find C++ bugs.

To send a message to an object via a pointer to it, you need to use the “->” operator e.g.:

```
root[] my_objptr->Solve();
```

Although we chose to call our pointer `my_objptr`, to emphasize that it is a pointer, heap objects are so common in an object-oriented program that pointer names rarely reflect the fact - you have to be careful that you know if you are dealing with an object or its pointer! Fortunately, the compiler won't tolerate an attempt to do something like:

```
root[] my_objptr.Solve();
```

Although this is a permitted by the CINT shortcuts, it is one that you are *strongly* advised not to follow! As we have seen, heap objects have to be accessed via pointers, whereas stack objects can be accessed directly. They can also be accessed via pointers:

```
root[] Quad stack_quad(1.,2.,-3.);
root[] Quad *stack_ptr = &stack_quad;
root[] stack_ptr->Solve();
```

Here we have a `Quad` pointer that has been initialized with the address of a stack object. Be very careful if you take the address of stack objects. As we shall see soon, they are deleted automatically, which could leave you with an illegal pointer. Using it will corrupt and may well crash the program!

It is time to look at the destruction of objects. A destructor is a special C++ function that releases resources for (or destroy) an object of a class. It is opposite of a constructor that create the object of a class when is called. The compiler will provide a destructor that does nothing if none is provided. We will add one to our `Quad` class so that we can see when it is called. The class names the destructor but with a prefix `~` which is the C++ one's complement i.e. bit wise complement, and hence has destruction overtones! We declare it in the `.h` file and define it in the `.cxx` file. It does not do much except print out that it has been called (still a useful debug technique despite today's powerful debuggers!).

Now run `root`, load the `Quad` class and create a heap object:

```
root[] .L Quad.cxx
root[] Quad *my_objptr = new Quad(1.,2.,-3.);
```

To delete the object:

```
root[] delete my_objptr;
root[] my_objptr = 0;
```

You should see the print out from its destructor. Setting the pointer to zero afterwards is not strictly necessary (and CINT does it automatically), but the object is no more accessible, and any attempt to use the pointer again will, as has already been stated, cause grief. So much for heap objects, but how are stack objects deleted? In C++, a stack object is deleted as soon as control leaves the innermost compound statement that encloses it. Therefore, it is singularly futile to do something like:

```
root[] { Quad my_object(1.,2.,-3.); }
```

CINT does not follow this rule; if you type in the above line, you will not see the destructor message. As explained in the Script lesson, you can load in compound statements, which would be a bit pointless if everything disappeared as soon as it was loaded! Instead, to reset the stack you have to type:

```
root[] gROOT->Reset();
```

This sends the Reset message via the global pointer to the ROOT object, which, amongst its many roles, acts as a resource manager. Start ROOT again and type in the following:

```
root[] .L Quad.cxx
root[] Quad my_object(1.,2.,-3.);
root[] Quad *my_objptr = new Quad(4.,5.,-6.);
root[] gROOT->Reset();
```

You will see that this deletes the first object but not the second. We have also painted ourselves into a corner, as `my_objptr` was also on the stack. This command will fail.

```
root[] my_objptr->Solve();
```

CINT no longer knows what `my_objptr` is. This is a great example of a memory leak; the heap object exists but we have lost our way to access it. In general, this is not a problem. If any object will outlive the compound statement in which it was created then a more permanent pointer will point to it, which frequently is part of another heap object. See Resetting the Interpreter Environment in the chapter “CINT the C++ Interpreter”.

## Chapter 7

# CINT the C++ Interpreter

The subject of this chapter is CINT, ROOT command line interpreter and script processor. First, we explain what CINT is and why ROOT uses it. Then we discuss CINT as the command line interpreter, the CINT commands, and CINT extensions to C++ are discussed. CINT as the script interpreter is explained and illustrated with several examples.

### 7.1 What is CINT?

CINT, which is pronounced [ˈsɪnt], is a C++ interpreter. An interpreter takes a program, in this case a C++ program, and carries it out by examining each instruction and in turn executing the equivalent sequence of machine language. For example, an interpreter translates and executes each statement in the body of a loop “n” times. It does not generate a machine language program. This may not be a good example, because most interpreters have become ‘smart’ about loop processing.

A compiler on the other hand, takes a program and makes a machine language executable. Once compiled the execution is very fast, which makes a compiler best suited for the case of “built once, run many times”. For example, the ROOT executable is compiled occasionally and executed many times. It takes anywhere from 1 to 45 minutes to compile ROOT for the first time (depending on the CPU). Once compiled it runs very fast. On the average, a compiled program runs roughly ten times faster than an interpreted one. Because compiling is slow, using a compiler is cumbersome for rapid prototyping when one changes and rebuilds as often as once per minute. An interpreter, on the other hand, is the perfect tool for code that changes often and runs a few times. Most of the time, interpreters are built for scripting languages, such as JavaScript, IDL, or Python. These languages are specifically designed to be interpreted rather than compiled. The advantage of using a normally compiled language is that code can be compiled once the prototype is debugged and refined. CINT is a C++ interpreter, making it a tool for rapid prototyping and scripting in C++. It is also available as a stand-alone product, see <http://root.cern.ch/cint>. This page also has links to all the CINT documentation. The downloadable tar file contains documentation, the CINT executable, and many demo scripts that are not included in the regular ROOT distribution. Here is the list of CINT main features:

- Supports K&R-C, ANSI-C, and ANSI-C++
- CINT covers 85-95% of the C++, ANSI-C and K&R-C language constructs. It supports multiple inheritance, virtual function, function overloading, operator overloading, default parameters, templates, and much more. CINT is robust enough to interpret its own source code. CINT is not designed to be a 100% ANSI/ISO compliant C++ language processor. It is a portable scripting language environment, which is close enough to the standard C++.
- Interprets Large C/C++ source code
- CINT can handle huge C/C++ source code, and loads source files quickly. It can interpret its own, over 70,000 lines source code - more than 150,000 lines.
- Enables mixing Interpretation & Native Code
- Depending on the need for execution speed or the need for interaction, one can mix native code execution and interpretation. “makecint” encapsulates arbitrary C/C++ objects as precompiled libraries. A precompiled library can be configured as a dynamically linked library. Accessing interpreted code and precompiled code can be done seamlessly in both directions.

- Provides a Single-Language solution
- CINT/makecint is a single-language environment. It works with any ANSI-C/C++ compiler to provide the interpreter environment on top of it.
- Simplifies C++
- CINT is meant to bring C++ to the non-software professional. C++ is simpler to use in the interpreter environment. It helps the non-software professional (the domain expert) to talk the same language as the software counterpart.
- Provides RTTI and a Command Line
- CINT can process C++ statements from command line, dynamically define/erase class definition and functions; load/unload source files and libraries. Extended Run Time Type Identification is provided, allowing you to explore imaginative new ways of using C++.
- CINT has a built-in debugger for complex C++ code and a text based class browser is part of it.
- It is portable.
- CINT works on number of operating systems: HP-UX, Linux, SunOS, Solaris, AIX, Alpha-OSF, IRIX, FreeBSD, NetBSD, NEC EWS4800, NewsOS, BeBox, WindowsNT, Windows9x, MS-DOS, MacOS, VMS, NextStep, Convex.

## 7.2 The ROOT Command Line Interface

Start up a ROOT session by typing `root` at the system prompt.

```
> root
*****
*                                     *
*           W E L C O M E to R O O T           *
*                                     *
*   Version   5.16/00           27 June 2007   *
*                                     *
* You are welcome to visit our Web site *
*           http://root.cern.ch           *
*                                     *
*****
FreeType Engine v2.1.9 used to render TrueType fonts.
Compiled on 28 June 2007 for linux with thread support.

CINT/ROOT C/C++ Interpreter version 5.16.21, June 22, 2007
Type ? for help. Commands must be C++ statements.
Enclose multiple statements between { }.
root[0]
```

Now we create a **TLine** object:

```
root[] TLine l
root[] l.Print()
TLine X1=0.000000 Y1=0.000000 X2=0.000000 Y2=0.000000
root[] l.SetX1(10)
root[] l.SetY1(11)
root[] l.Print()
TLine X1=10.000000 Y1=11.000000 X2=0.000000 Y2=0.000000
root[] .g
...
0x4038f080 class TLine l , size=40
0x0          protected: Double_t fX1 //X of 1st point
```

```
0x0      protected: Double_t fY1 //Y of 1st point
0x0      protected: Double_t fX2 //X of 2nd point
0x0      protected: Double_t fY2 //Y of 2nd point
0x0      private: static class TClass* fgIsA
```

Here we note:

- Terminating with ‘;’ is not required, see “ROOT/CINT Extensions to C++”.
- Emacs style command line editing.
- Raw interpreter commands start with a dot (.).

```
root[] .class TLine
=====
class TLine //A line segment
size=0x38
(tagnum=289,voffset=-1,isabstract=0,parent=-1,gcomp=0:-1,d21=~cd=f7)
List of base class-----
0x0      public: TObject //Basic ROOT object
0xc      public: TAttLine //Line attributes
List of member variable-----
Defined in TLine
(compiled) 0x0      protected: Double_t fX1 //X of 1st point
(compiled) 0x0      protected: Double_t fY1 //Y of 1st point
(compiled) 0x0      protected: Double_t fX2 //X of 2nd point
(compiled) 0x0      protected: Double_t fY2 //Y of 2nd point
(compiled) 0x8a3a718 static const enum TLine:: kLineNDC
(compiled) 0x0      private: static TClass* fgIsA
List of member function-----
filename      line:size busy function type and name (in TLine)
(compiled) 0:0      0 public: virtual void ~TLine(void);
(compiled) 0:0      0 public: TLine TLine(void);
(compiled) 0:0      0 public: TLine TLine(Double_t x1,Double_t y1,
                                Double_t x2,Double_t y2);
(compiled) 0:0      0 public: TLine TLine(const TLine& line);
(compiled) 0:0      0 public: virtual void Copy(TObject& line) const;
(compiled) 0:0      0 public: virtual Int_t DistancetoPrimitive(
                                Int_t px,Int_t py);
...
(compiled) 0:0      0 public: static int ImplFileLine(void);
(compiled) 0:0      0 public: static const char* ImplFileName(void);
(compiled) 0:0      0 public: static int DeclFileLine(void);
(compiled) 0:0      0 public:TLine& operator=(const TLine&);
root[] l.Print(); > test.log
root[] l.Dump(); >> test.log
root[] ?
```

Here we see:

- Use `.class` as quick help and reference
- Unix like I/O redirection (`; >` is required before `>`)
- Use `?` to get help on all “raw” interpreter commands
- Use `@` to abort a multi-line command

Now let us execute a multi-line command:

```

root[] {
end with '}', '@:abort > TLine l;
end with '}', '@:abort > for (int i = 0; i < 5; i++) {
end with '}', '@:abort >     l.SetX1(i);
end with '}', '@:abort >     l.SetY1(i+1);
end with '}', '@:abort >     l.Print();
end with '}', '@:abort > }
end with '}', '@:abort > }
TLine X1=0.000000 Y1=1.000000 X2=0.000000 Y2=0.000000
TLine X1=1.000000 Y1=2.000000 X2=0.000000 Y2=0.000000
TLine X1=2.000000 Y1=3.000000 X2=0.000000 Y2=0.000000
TLine X1=3.000000 Y1=4.000000 X2=0.000000 Y2=0.000000
TLine X1=4.000000 Y1=5.000000 X2=0.000000 Y2=0.000000
root[] .q

```

Here we note:

- A multi-line command starts with a { and ends with a }.
- Every line has to be correctly terminated with a ; (like in “real” C++).
- All objects are created in *globalscope*.
- There is no way to back up; you are better off writing a script.
- Use `.q` to exit root.

## 7.3 The ROOT Script Processor

ROOT script files contain pure C++ code. They can contain a simple sequence of statements like in the multi command line example given above, but also arbitrarily complex class and function definitions.

### 7.3.1 Un-named Scripts

Let us start with a script containing a simple list of statements (like the multi-command line example given in the previous section). This type of script must start with a { and end with a } and is called an un-named script. Assume the file is called `script1.C`

```

{
#include <iostream.h>
    cout << " Hello" << endl;
    float x = 3.;
    float y = 5.;
    int    i = 101;
    cout <<" x = "<<x<<" y = "<<y<<" i = "<<i<< endl;
}

```

To execute the stream of statements in `script1.C` do:

```
root[] .x script1.C
```

This loads the contents of file `script1.C` and executes all statements in the interpreter’s global scope. One can re-execute the statements by re-issuing “`.x script1.C`” (since there is no function entry point). Scripts are searched for in the `Root.MacroPath` as defined in your `.rootrc` file. To check which script is being executed use:

```

root[] .which script1.C
/home/rdm/root/./script1.C

```



### 7.3.2 Named Scripts

Let us change the un-named script to a named script. Copy the file `script1.C` to `script2.C` and add a function statement:

```
#include <iostream.h>

int run()
{
    cout << " Hello" << endl;
    float x = 3.;
    float y = 5.;
    int i = 101;
    cout <<" x = "<< x <<" y = "<< y <<" i = "<< i << endl;
    return 0;
}
```

Notice that no surrounding `{}` are required in this case. To execute function `run()` in `script2.C` do:

```
root[] .L script2.C           // load script in memory
root[] run()                 // execute entry point run
Hello
x = 3 y = 5 i = 101
(int)0
root[] run()                 // execute run() again
Hello
x = 3 y = 5 i = 101
(int)0
root[] .func                 // list all functions known by CINT
filename      line:size busy function type and name
...
script2.C      4:9    0 public: int run();
```

The last command shows that `run()` has been loaded from file `script2.C`, that the function `run()` starts on line 4 and is 9 lines long. Notice that once a function has been loaded it becomes part of the system just like a compiled function. Now we copy the file `script2.C` to the `script3.C` and change the function name from `run()` to `script3(int j = 10)`:

```
#include <iostream.h>
int script3(int j = 10) {
    cout << " Hello" << endl;
    float x = 3.;
    float y = 5.;
    int i = j;
    cout <<" x = "<< x <<" y = "<< y <<" i = "<< i << endl;
    return 0;
}
```

To execute `script3()` in `script3.C` type:

```
root[] .x script3.C(8)
```

This loads the contents of file `script3.C` and executes entry point `script3(8)`. Note that the above only works when the filename (minus extension) and function entry point are both the same.

The function `script3()` can still be executed multiple times:

```
root[] script3()
Hello
```

```
x = 3, y = 5, i = 10
(int)0
root[] script3(33)
Hello
x = 3, y = 5, i = 33
(int)0
```

In a named script, the objects created on the stack are deleted when the function exits. For example, this scenario is very common. You create a histogram in a named script on the stack. You draw the histogram, but when the function exits the canvas is empty and the histogram disappeared. To avoid histogram from disappearing you can create it on the heap (by using `new`). This will leave the histogram object intact, but the pointer in the named script scope will be deleted. Since histograms (and trees) are added to the list of objects in the current directory, you can always retrieve them to delete them if needed.

```
root[] TH1F *h = (TH1F*)gDirectory->Get("myHist"); // or
root[] TH1F *h = (TH1F*)gDirectory->GetList()->FindObject("myHist");
```

In addition, histograms and trees are automatically deleted when the current directory is closed. This will automatically take care of the clean up. See “Input/Output”.

### 7.3.3 Executing a Script from a Script

You may want to execute a script conditionally inside another script. To do it you need to call the interpreter and you can do that with `TROOT::ProcessLine()`. The example `$ROOTSYS/tutorials/tree/cernstaff.C` calls a script to build the root file if it does not exist:

```
void cernstaff() {
    if (gSystem->AccessPathName("cernstaff.root")) {
        gROOT->ProcessLine(".x cernbuild.C");
    }
}
```

`ProcessLine` takes a parameter, which is a pointer to an `int` or to a `TInterpreter::EErrorCode` to let you access the CINT error code after an attempt to interpret. This will contain the CINT error as defined in `enum TInterpreter::EErrorCode`.

## 7.4 Resetting the Interpreter Environment

Variables created on the command line and in un-named scripts are in the interpreter’s global scope, which makes the variables created in un-named scripts available on the command line event after the script is done executing. This is the opposite of a named script where the stack variables are deleted when the function in which they are defined has finished execution.

When running an un-named script over again and this is frequently the case since un-named scripts are used to prototype, one should reset the global environment to clear the variables. This is done by calling `gROOT->Reset()`. It is good practice, and you will see this in the examples, to begin an un-named script with `gROOT->Reset()`. It clears the global scope to the state just before executing the previous script (not including any logon scripts). The `gROOT->Reset()` calls the destructor of the objects if the object was created on the stack. If the object was created on the heap (via `new`) it is not deleted, but the variable is no longer associated with it. Creating variables on the heap in un-named scripts and calling `gROOT->Reset()` without you calling the destructor explicitly will cause a memory leak. This may be surprising, but it follows the scope rules. For example, creating an object on the heap in a function (in a named script) without explicitly deleting it will also cause a memory leak. Since when exiting the function only the stack variables are deleted. The code below shows `gROOT->Reset()` calling the destructor for the stack variable, but not for the heap variable. In the end, neither variable is available, but the memory for the heap variable is not released. Here is an example:

```
root[] gDebug = 1
(const int)1
```

```

root[] TFile stackVar("stack.root","RECREATE")
TKey Writing 86 bytes at address 64 for ID= stack.root Title=
root[] TFile *heapVar = new TFile("heap.root","RECREATE")
TKey Writing 84 bytes at address 64 for ID= heap.root Title=

```

We turn on Debug to see what the subsequent calls are doing. Then we create two variables, one on the stack and one on the heap.

```

root[] gROOT->Reset()
TKey Writing 48 bytes at address 150 for ID= stack.root Title=
TKey Writing 54 bytes at address 198 for ID= stack.root Title=
TFile dtor called for stack.root
TDirectory dtor called for stack.root

```

When we call `gROOT->Reset()`, CINT tells us that the destructor is called for the stack variable, but it does not mention the heap variable.

```

root[] stackVar
Error: No symbol stackVar in current scope
FILE:/var/tmp/faaa01jWe_cint LINE:1
*** Interpreter error recovered ***
root[] heapVar
Error: No symbol heapVar in current scope
FILE:/var/tmp/gaaa01jWe_cint LINE:1
*** Interpreter error recovered ***

```

Neither variable is available in after the call to reset.

```

root[] gROOT->FindObject("stack.root")
(class TObject*)0x0
root[] gROOT->FindObject("heap.root")
(class TObject*)0x106bfb30

```

The object on the stack is deleted and shows a null pointer when we do a `FindObject`. However, the heap object is still around and taking up memory.

Note `gROOT->Reset()` should be never called in a named script or a compiled program.

## 7.5 A Script Containing a Class Definition

Lets create a small class `TMyClass` and a derived class `TChild`. The virtual method `TMyClass::Print()` is overridden in `TChild`. Save this in file called `script4.C`.

```

#include <iostream.h>

class TMyClass {
private:
    float  fX;    //x position in centimeters
    float  fY;    //y position in centimeters
public:
    TMyClass() { fX = fY = -1; }
    virtual void Print() const;
    void SetX(float x) { fX = x; }
    void SetY(float y) { fY = y; }
};

void TMyClass::Print() const // parent print method

```

```

{
    cout << "fX = " << fX << ", fY = " << fY << endl;
}
class TChild : public TMyClass {
public:
    void Print() const;
};
void TChild::Print() const // child print metod
{
    cout << "This is TChild::Print()" << endl;
    TMyClass::Print();
}

```

To execute script4.C do:

```

root[] .L script4.C
root[] TMyClass *a = new TChild
root[] a->Print()
This is TChild::Print()
fX = -1, fY = -1
root[] a->SetX(10)
root[] a->SetY(12)
root[] a->Print()
This is TChild::Print()
fX = 10, fY = 12
root[] .class TMyClass
=====
class TMyClass
size=0x8 FILE:script4.C LINE:3
List of base class-----
List of member variable-----
Defined in TMyClass
0x0     private: float fX
0x4     private: float fY
List of member function-----
Defined in TMyClass
filename      line:size busy function type and name
script4.C     16:5    0 public: class TMyClass TMyClass(void);
script4.C     22:4    0 public: void Print(void);
script4.C     12:1    0 public: void SetX(float x);
script4.C     13:1    0 public: void SetY(float y);
root[] .q

```

As you can see, an interpreted class behaves just like a compiled class.

There are some limitations for a class created in a script:

- They cannot inherit from **TObject**. Currently the interpreter cannot patch the virtual table of compiled objects to reference interpreted objects.
- Because the I/O is encapsulated in **TObject** and a class defined in a script cannot inherit from **TObject**, it cannot be written to a ROOT file.

See “Adding a Class” for ways how to add a class with a shared library and with ACLiC.

## 7.6 Debugging Scripts

A powerful feature of CINT is the ability to debug interpreted functions by means of setting breakpoints and being able to single step through the code and print variable values on the way. Assume we have `script4.C` still loaded, we can then do:

```

root[] .b TChild::Print
Break point set to line 26 script4.C
root[] a.Print()

26 TChild::Print() const
27 {
28     cout << "This is TChild::Print()" << endl;
FILE:script4.C LINE:28 cint> .s

311 operator<<(ostream& ostr,G__CINT_ENDL& i) {return(endl(ostr));
FILE:iostream.h LINE:311 cint> .s
}
This is TChild::Print()

29 MyClass::Print();
FILE:script4.C LINE:29 cint> .s

16 MyClass::Print() const
17 {
18     cout << "fX = " << fX << ", fY = " << fY << endl;
FILE:script4.C LINE:18 cint> .p fX
(float)1.000000000000e+01
FILE:script4.C LINE:18 cint> .s

311 operator<<(ostream& ostr,G__CINT_ENDL& i) {return(endl(ostr));
FILE:iostream.h LINE:311 cint> .s
}
fX = 10, fY = 12

19 }

30 }

2 }
root[] .q

```

## 7.7 Inspecting Objects

An object of a class inheriting from **TObject** can be inspected, with the `Inspect()` method. The `TObject::Inspect` method creates a window listing the current values of the objects members. For example, the next picture is of **TFile**.

```

root[] TFile f("staff.root")
root[] f.Inspect()

```

You can see the pointers are in red and can be clicked on to follow the pointer to the object. If you clicked on `fList`, the list of objects in memory and there were none, no new canvas would be shown. On top of the page are the navigation buttons to see the previous and next screen.

## 7.8 ROOT/CINT Extensions to C++

In the next example, we demonstrate three of the most important extensions ROOT/CINT makes to C++. Start ROOT in the directory `$ROOTSYS/tutorials` (make sure to have first run `./x hsimple.C`):

```

root[] f = new TFile("hsimple.root")
(class TFile*)0x4045e690

```

Member Name	Value	Title
<b>TFile</b>	<b>staff.root:0</b>	
fD	10	File descriptor
fBEGIN	64	First used byte in file
fEND	38474	Last used byte in file
fVersion	22600	File format version
fCompress	1	(= 1 file is compressed, 0 otherwise)
fOption.*fData	READ	
fUnits	4	Number of bytes for file pointers
fSeekFree	38420	Location on disk of free segments structure
fNbytesFree	54	Number of bytes for free segments structure
fWritten	0	Number of objects written so far
fSumBuffer	0	Sum of buffer sizes of objects written so far
fSum2Buffer	0	Sum of squares of buffer sizes of objects written so far
*fFree	->0	Free segments linked list table
fBytesWrite	0	Number of bytes written to this file
fBytesRead	352	Number of bytes read from this file
fModified	1	true if directory has been modified
fWritable	0	true if directory is writable
fDatetimeC.fDatetime	20001012/173203	
fDatetimeM.fDatetime	20001012/173204	
fNbytesKeys	116	Number of bytes for the keys
fNbytesName	56	Number of bytes in TNamed at creation time
fSeekDir	64	Location of directory on file
fSeekParent	0	Location of parent directory on file
fSeekKeys	38304	Location of Keys record on file
*fFile	->10711b60	pointer to current file in memory
*fMother	->0	pointer to mother of the directory
*fList	->106f3918	Pointer to objects list in memory
*fKeys	->10711e08	Pointer to keys list in memory
fName.*fData	staff.root	
fTitle.*fData		
fUniqueID	0	object unique identifier
fBits	50331649	bit field status word

Figure 7.1: ROOT object inspector of TFile

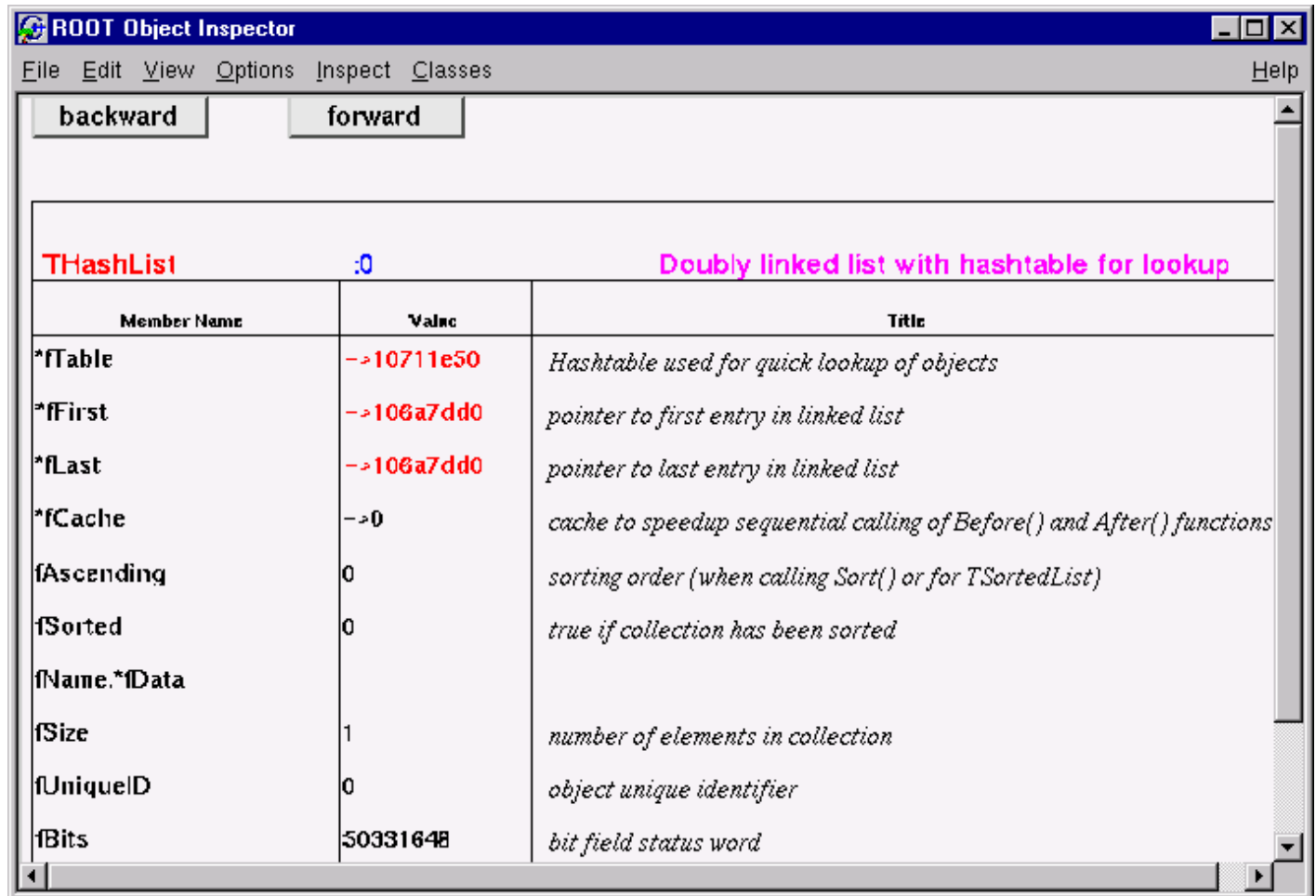

Figure 7.2: The object inspector of fKeys, the list of keys in the memory

```

root[] f.ls()
TFile**      hsimple.root
TFile*       hsimple.root
KEY: TH1F    hpx;1   This is the px distribution
KEY: TH2F    hpxpy;1 py ps px
KEY: THProfile hprof;1 Profile of pz versus px
KEY: TNtuple ntuple;1   Demo ntuple
root[] hpx.Draw()
NULL
Warning in <MakeDefCanvas>: creating a default canvas with name c1
root[] .q

```

The *first* command shows the first extension; the declaration of `f` may be omitted when “`new`” is used. CINT will correctly create `f` as pointer to object of class `TFile`.

The *second* extension is shown in the second command. Although `f` is a pointer to `TFile` we don’t have to use the pointer de-referencing syntax “`->`” but can use the simple “`.`” notation.

The *third* extension is more important. In case CINT cannot find an object being referenced, it will ask ROOT to search for an object with an identical name in the search path defined by `TROOT::FindObject()`. If ROOT finds the object, it returns CINT a pointer to this object and a pointer to its class definition and CINT will execute the requested member function. This shortcut is quite natural for an interactive system and saves much typing. In this example, ROOT searches for `hpx` and finds it in `simple.root`.

The *fourth* is shown below. There is no need to put a semicolon at the end of a line. The difference between having it and leaving it off is that when you leave it off the return value of the command will be printed on the next line. For example:

```

root[] 23+5 // no semicolon prints the return value
(int)28
root[] 23+5; // semicolon no return value is printed
root[]

```

Be aware that these extensions do not work when a compiler replaces the interpreter. Your code will not compile, hence when writing large scripts, it is best to stay away from these shortcuts. It will save you from having problems compiling your scripts using a real C++ compiler.

## 7.9 ACLiC - The Automatic Compiler of Libraries for CINT

Instead of having CINT interpret your script there is a way to have your scripts compiled, linked and dynamically loaded using the C++ compiler and linker. The advantage of this is that your scripts will run with the speed of compiled C++ and that you can use language constructs that are not fully supported by CINT. On the other hand, you cannot use any CINT shortcuts (see ROOT/CINT Extensions to C++) and for small scripts, the overhead of the compile/link cycle might be larger than just executing the script in the interpreter.

ACLiC will build a CINT dictionary and a shared library from your C++ script, using the compiler and the compiler options that were used to compile the ROOT executable. You do not have to write a `makefile` remembering the correct compiler options, and you do not have to exit ROOT.

### 7.9.1 Usage

Before you can compile your interpreted script you need to add include statements for the classes used in the script. Once you did that, you can build and load a shared library containing your script. To load it use the command `.L` and append the file name with a “`+`”.

```

root[] .L MyScript.C+
root[] .files
...
*file="/home/./MyScript_C.so"

```



The `+` option generates the shared library and names it by taking the name of the file “filename” but replacing the dot before the extension by an underscore and by adding the shared library extension for the current platform. For example on most platforms, `hsimple.cxx` will generate `hsimple_cxx.so`. If we execute a `.files` command we can see the newly created shared library is in the list of loaded files.

The `+` command rebuild the library only if the script or any of the files it includes are newer than the library. When checking the timestamp, ACLiC generates a dependency file which name is the same as the library name, just replacing the ‘so’ extension by the extension ‘d’. For example on most platforms, `hsimple.cxx` will generate `hsimple_cxx.d`.

To ensure that the shared library is rebuilt you can use the `++` syntax:

```
root[] .L MyScript.C++
```

To build, load, and execute the function with the same name as the file you can use the `.x` command. This is the same as executing a named script. You can have parameters and use `.xor .X`. The only difference is you need to append a `+` or a `++`.

```
root[] .x MyScript.C+ (4000)
Creating shared library /home/./MyScript_C.so
```

You can select whether the script is compiled with debug symbol or with optimization by appending the letter ‘g’ or ‘O’ after the ‘+’ or ‘++’. Without the specification, the script is compiled with the same level of debugging symbol and optimization as the currently running ROOT executable. For example:

```
root[] .L MyScript.C++g
```

will compile `MyScript.C` with debug symbols; usually this means giving the `-g` option to compiler.

```
root[] .L MyScript.C++O
```

will compile `MyScript.C` with optimizations; usually this means giving the `-O` option to compiler. The syntax:

```
root[] .L MyScript.C++
```

is using the default optimization level. The initial default is to compile with the same level of optimization as the root executable itself. The default can be changed by:

```
root[] gSystem->SetAcllicMode(TSystem::kDebug);
root[] gSystem->SetAcllicMode(TSystem::kOpt);
```

Note that the commands:

```
root[] .L MyScript.C+g
root[] .L MyScript.C+O
```

respectively compile `MyScript.C` with debug and optimization if the library does not exist yet; they will not change the debug and the optimization level if the library already exist and it is up to date. To use ACLiC from compiled code or from inside another macro, we recommend using the `ProcessLine()` method of `TROOT`. For example, in one script you can use ACLiC to compile and load another script.

```
gROOT->ProcessLine(".L MyScript.C+")
gROOT->ProcessLine(".L MyScript.C++")
```

## 7.9.2 Setting the Include Path

You can get the include path by typing:

```
root[] .include
```

You can append to the include path by typing:

```
root[] .include $HOME/mypackage/include
```

In a script you can append to the include path:

```
gSystem->AddIncludePath(" -I$HOME/mypackage/include ")
```

You can also overwrite the existing include path:

```
gSystem->SetIncludePath(" -I$HOME/mypackage/include ")
```

The `$ROOTSYS/include` directory is automatically appended to the include path, so you do not have to worry about including it. To add library that should be used during linking of the shared library use something like:

```
gSystem->AddLinkedLibs("-L/my/path -lanylib");
```

This is especially useful for static libraries. For shared ones you can also simply load them before trying to compile the script:

```
gSystem->Load("mydir/mylib");
```

ACLiC uses the directive `fMakeSharedLibs` to create the shared library. If loading the shared library fails, it tries to output a list of missing symbols by creating an executable (on some platforms like OSF, this does not HAVE to be an executable) containing the script. It uses the directive `fMakeExe` to do so. For both directives, before passing them to `TSystem::Exec()`, it expands the variables `$SourceFiles`, `$SharedLib`, `$LibName`, `$IncludePath`, `$LinkedLibs`, `$ExeNameand$ObjectFiles`. See `SetMakeSharedLib()` for more information on those variables. When the file being passed to ACLiC is on a read only file system, ACLiC warns the user and creates the library in a temporary directory:

```
root[] .L readonly/t.C++
Warning in <ACLiC>: /scratch/aclic/subs/./readonly is not writable!
Warning in <ACLiC>: Output will be written to /tmp
Info in <TUnixSystem::ACLiC>: creating shared library
/tmp//scratch/aclic/subs/./readonly/t_C.so
```

To select the temporary directory ACLiC looks at `$TEMP`, `$TEMP_DIR`, `$TEMPDIR`, `$TMP`, `$TMPDIR`, `$TMP_DIR` or uses `/tmp` (or `C:/`). Also, a new interface `TSystem::Get/SetBuildDir` is introduced to let users select an alternative 'root' for building of the ACLiC libraries. For `filename/full/path/name/macro.C`, the library is created as `fBuildDir/full/path/name/macro_C.so`.

## 7.9.3 Dictionary Generation

You can direct what is added to the dictionary generated by ACLiC in two ways. The simplest way is to add at the end of script (i.e. after the symbols have been defined) something like:

```
#if defined(__MAKECINT__)
#pragma link C++ class MyOtherClass;
#endif
```

You can also write this portion of code in a file name `MyScript_linkdef.h` where the suffix `'_linkdef'` is the prefix defined by the key `'ACLiC.Linkdef'` in the currently used resource file (usually `.rootrcor$ROOTSYS/etc/system.rootrc`) and the prefix is the name of your script.

In ROOT 3.05/03 and above, the default behavior of `rootcint` is to not link in (i.e. generate the dictionary for) any of the symbols. In particular, this means that the following lines are now, in the general case, unnecessary.

```
#pragma link off all globals;
#pragma link off all classes;
#pragma link off all functions;
```

This also means that linking the instantiation of a class template:

```
#pragma link C++ class mytemplate<int>;
```

ONLY links this specific class. In previous versions of ROOT, depending on many factors, this might also have included the linking of many other instantiation of class template used directly or indirectly by `'mytemplate'`.

A typical case would have been to rely on:

```
#pragma link C++ class vector<MyClass>;
```

to also induce the generation of the iterators. You now need to request them explicitly. Another advantage of the change is that now, if you omit the `'pragma link off'` line from your `linkdef` file, you can actually sprinkle the `'pragma link C++ class'` across as many of your header as file as you need.

See the documentation of `rootcint` for details how `pragma` can be used.

NOTE: You should not call ACLiC with a script that has a function called `main()`. When ACLiC calls `rootcint` with a function called `main` it tries to add every symbol it finds while parsing the script and the header files to the dictionary. This includes the system header files and the ROOT header files. It will result in duplicate entries at best and crashes at worst, because some classes in ROOT need special attention before they can be added to the dictionary.

### 7.9.4 Intermediate Steps and Files

ACLiC executes two steps and a third one if needed. These are:

- Calling `rootcint` to create a CINT dictionary. `rootcint` is a ROOT specific version of `makecint`, CINT generic dictionary generator.
- Calling the compiler to build the shared library from the script
- If there are errors, it calls the compiler to build a dummy executable to report clearly unresolved symbols.

ACLiC makes a shared library with a CINT dictionary containing the classes and functions declared in the script. It also adds the classes and functions declared in included files with the same name as the script file and any of the following extensions: `.h`, `.hh`, `.hpp`, `.hxx`, `.hPP`, `.hXX`. This means that, by default, you cannot combine scripts from different files into one library by using `#include` statements; you will need to compile each script separately. In a future release, we plan to add the global variables declared in the script to the dictionary also. If you are curious about the specific calls, you can raise the ROOT debug level: `gDebug=3` and ACLiC will print these steps. If you need to keep the intermediate files around, for example when debugging the script using `gdb`, use `gDebug=7`.

## 7.9.5 Moving between Interpreter and Compiler

The best way to develop portable scripts is to make sure you can always run them with both, the interpreter and with ACLiC. To do so, do not use the CINT extensions and program around the CINT limitations. When it is not possible or desirable to program around the CINT limitations, you can use the C preprocessor symbols defined for CINT and `rootcint`.

The preprocessor symbol `__CINT__` is defined for both CINT and `rootcint`. The symbol `__MAKECINT__` is only defined in `rootcint`.

Use `!defined(__CINT__) || defined(__MAKECINT__)` to bracket code that needs to be seen by the compiler and `rootcint`, but will be invisible to the interpreter.

Use `!defined(__CINT__)` to bracket code that should be seen only by the compiler and not by CINT or `rootcint`. For example, the following will hide the declaration and initialization of the array `gArray` from both CINT and `rootcint`.

```
#if !defined(__CINT__)
int gArray[] = { 2, 3, 4};
#endif
```

Because ACLiC calls `rootcint` to build a dictionary, the declaration of `gArray` will not be included in the dictionary, and consequently, `gArray` will not be available at the command line even if ACLiC is used. CINT and `rootcint` will ignore all statements between the `"#if !defined (__CINT__)"` and `"#endif"`. If you want to use `gArray` in the same script as its declaration, you can do so. However, if you want use the script in the interpreter you have to bracket the usage of `gArray` between `#if`'s, since the definition is not visible. If you add the following preprocessor statements:

```
#if !defined(__CINT__)
int gArray[] = { 2, 3, 4};
#elif defined(__MAKECINT__)
int gArray[];
#endif
```

`gArray` will be visible to `rootcint` but still not visible to CINT. If you use ACLiC, `gArray` will be available at the command line and be initialized properly by the compiled code.

We recommend you always write scripts with the needed include statements. In most cases, the script will still run with the interpreter. However, a few header files are not handled very well by CINT.

These types of headers can be included in interpreted and compiled mode:

- The subset of standard C/C++ headers defined in `$ROOTSYS/cint/include`.
- Headers of classes defined in a previously loaded library (including ROOT own). The defined class must have a name known to ROOT (i.e. a class with a `ClassDef`).

A few headers will cause problems when they are included in interpreter mode, because the interpreter itself already includes them. In general, the interpreter needs to know whether to use the interpreted or compiled version. The mode of the definition needs to match the mode of the reference.

Here are the cases that need to be excluded in interpreted mode, but included for `rootcint`. Bracket these with: `!defined(__CINT__) || defined(__MAKECINT__)`

- All CINT headers, see `$ROOTSYS/cint/inc`
- Headers with classes named other than the file name. For example `Rtypes.h` and `GuiTypes.h`.
- Headers with a class defined in libraries before the library is loaded. For example: having `#include "TLorentzVector.h" before gSystem->Load("libPhysics"). This will also cause problems when compiling the script, but a clear error message will be given. With the interpreter, it may core dump. Bracket these type of include statements with #if !defined (__CINT__), this will print an error in both modes.`

Hiding header files from `rootcint` that are necessary for the compiler but optional for the interpreter can lead to a subtle but fatal error. For example:

```
#ifndef __CINT__
#include "TTree.h"
#else
class TTree;
#endif

class subTree : public TTree {
};
```

In this case, `rootcint` does not have enough information about the `TTree` class to produce the correct dictionary file. If you try this, `rootcint` and compiling will be error free, however, instantiating a `subTree` object from the CINT command line will cause a fatal error. In general, it is recommended to let `rootcint` see as many header files as possible.

## 7.10 Reflex

Reflection is the ability of a programming language to introspect its data structures and interact with them at runtime without prior knowledge. Reflex provides reflection capabilities for C++. With the ROOT v5.08, Reflex is an optional package. It will become a mandatory package (loaded by default) with the next ROOT versions. In order to build it you have to `./configure --enable-reflex`

### 7.10.1 Overview

Inside ROOT Reflex is thought to replace the current reflection system, which is inherent to CINT. This is an ongoing work and not part of this release. Nevertheless, Reflex dictionaries can be used inside ROOT while populating the current CINT data structures via a special gateway called `Cintex` (see “`Cintex`”).

In order to use reflection a dictionary of the data structures involved has to be generated. Before generating the dictionaries, the source code has to be parsed and the information extracted. In the ROOT environment, there are two ways to generate dictionaries for the Reflex library.

- Using CINT as a source code parser - the command to issue when using CINT for parsing C++ constructs is:

```
rootcint -reflex -f module/src/G_Module.cxx -c module/inc/TMod1.h
module/inc/TMod2.h module/inc/Linkdef.h
```

- Using the `gcc` compiler as a source code parser: With this option a special program called “`gccxml`” has to be installed. This program is an extension to `gcc` and produces `xml` code out of parsed C++ definitions which will be further used to generate the proper dictionary source code via a python script. For parsing C++ constructs using the `gcc` compiler the command will be:

```
rootcint -gccxml -f module/src/G_Module.cxx -c module/inc/TMod1.h
module/inc/TMod2.h module/inc/Linkdef.h
```

Note: an installation of Python and `gccxml` is required for using this option.

### 7.10.2 Selecting Types And Members

You can use selection files to tell `genreflex` what it should generate a dictionary for. If you do not use it, it will generate a dictionary for all types in the files passed at the command line, or when specifying `--deep` for all types it finds.

The selection file is passed to `genreflex` with the `-s` parameters like this:

```
genreflex -s selection.xml header1.h header2.h.
```

It is an XML file with the following structure:

```
<lcgdict>
[<selection>]
<class [name="classname" [pattern="wildname"
[file_name="filename" [file_pattern="wildname"
[id="xxxx" [type="vector"]]/>
<class name="classname" >
<field name="m_transient" transient="true"/>
<field name="m_anothertransient" transient="true"/>
<properties prop1="value1" [prop2="value2"]/>
</class>
<function [name="funcname" [pattern="wildname"
[proto_name="name(int)"] [proto_pattern="name(int,*)" ]/>
<enum [name="enumname" [patter="wildname" ]/>
<variable [name="varname" [patter="wildname" ]/>
[</selection>]
<exclusion>
<class [name="classname" [pattern="wildname" ]/>
<method name="unwanted" ]/>
</class>
...
</lcgdict>
```

### 7.10.3 Genreflex and Templates

The program parsing the header files and providing genreflex with the information what's in them is called GCCXML. It only sees templates if they are instantiated. See the C++ standard on when template instantiation happens. The rule of thumb is: if you design a templated class then it probably does not happen in that templated class's header.

So you need to help GCCXML. There are two common approaches: the struct member, and the "proper" C++ way.

#### 7.10.3.1 Explicit Template Instantiation

This is the preferred method, but it is not widely used. Suppose you have a templated template class C and a templated function template T `A::f(const T&) const;`. You can instantiate them (say with template parameter `long long`) using:

```
#ifdef __GCCXML__
// GCCXML explicit template instantiation block
template class C<long long>;
template long long A::f(const long long&);
#endif
```

You can even put this into your regular header file: it is surrounded by an `#ifdef __GCCXML__` and will thus be invisible to any other compiler.

#### 7.10.3.2 Template Instantiation by struct Members

Suppose you have a templated template class C and a templated function template T `f(const T&) const;` defined in file C.h. For the templated class you can use:

```

#include "C.h"
#ifdef __GCCXML__
// GCCXML explicit template instantiation block
namespace {
    struct GCCXML_DUMMY_INSTANTIATION {
        C<long long> dummyMember;
    };
}
#endif

```

Often people put these instantiations into a separate header which in turn `#includes` the actual header, such that the C++ sources do not see the `GCCXML_DUMMY_INSTANTIATION`.

### 7.10.4 GCCXML Installation

Gccxml is a front-end to the gcc compiler suite, which generates xml code out of parsed C++ definitions. Gccxml needs to be installed in order to use this option. Now we are using a patched version of gccxml release 0.6.0 called (0.6.0\_patch3). This installation can be downloaded from <http://spi.cern.ch/lcgsoft/>.

Once the dictionary sources have been generated, they can be compiled into a library and loaded via the Reflex builder system. The dictionary information can be used via the Reflex API. For this purpose, Reflex provides eight classes, which exploit the whole functionality of the system.

### 7.10.5 Reflex API

Reflex offers a simple yet powerful API to access Reflex reflection database. The following classes are defined in the namespace `ROOT::Reflex` and documented at [http://root.cern.ch/root/html/REFLEX\\_Index.html](http://root.cern.ch/root/html/REFLEX_Index.html).

An **object** is an abstraction of a user object. It contains the information about its type and its location in memory.

**Type** is an abstraction of a C++ type. Types in Reflex are:

- Array
- Class/struct
- Templated class/struct
- Enum
- Function
- Fundamental
- Pointer
- Pointer to member
- Typedef
- Union

A **scope** is an abstraction of a C++ type. It holds information such as its declaring scope, its underlying scope and its data/function members. Scopes are:

- Namespace
- Class/Struct
- Templated class/struct
- Union
- Enum

A **member** lives inside a scope and is of a given Type. Members can be distinguished as:

- DataMember
- FunctionMember

- Templated member

**Base** holds the information about the inheritance structure of classes. It contains information such as the offset to the base class and the type of the base class.

**Properties** are key/value pairs where the key is a string and the value an Any object (Boost::Any). Any objects can hold any type of information be it a string, int or any arbitrary object. Properties can be attached to Types, Scopes and Members and hold any kind of information that is not specific to C++. Examples for Properties would be the class author, a description of a member or the class id.

A **MemberTemplate** is an abstraction of a templated member. It holds the information about its template parameters and a list of its instantiations.

A **TypeTemplate** is an abstraction of a templated type (e.g. class). It holds the same information as the MemberTemplate (e.g. template parameters, list of instantiations)

The Reflex package lives in the namespace `ROOT::Reflex`. Below some examples of usage of the package are given. For further information please see the documentation of the different API classes.

The next examples will refer to the example class `MyClass`:

```
class MyClass {

public:
    MyClass() : fMem1(47), fMem2("foo") { }
    int GetMem1() { return fMem1; }
    int GetMem1(int i) { return fMem1*i; }
    void SetMem1(int i) { fMem1 = i; }
    std::string GetMem2() { return fMem2; }
    void SetMem2(const std::string & str) { fMem2 = str; }

private:
    int fMem1;
    std::string fMem2;
};
```

The first thing after loading a dictionary (which is done at the moment at the same time as the implementation library), will be to look up a certain Type or Scope.

```
Type t1 = Type::ByName("MyClass");
```

Every API class provides the operator `bool`, which will return true if the information retrieved for this instance is valid and further actions on this instance can be taken.

```
if (t1) {
    if (t1.IsClass()) std::cout << "Class ";
    std::cout << t1.Name();
}
```

As a class is also a scope (as enum and union) we can now also iterate over its members. This can be done either with stl like iterators or with an iteration by number:

```
For (Member_Iterator mi = t1.DataMember_Begin();
     mi != DataMember_End(); ++mi) {
    std::cout << (*mi).Name(SCOPED) << " "
              << (*mi).TypeOf().Name(QUALIFIED);
}
```

```
Member m;
```



```

for (size_t i = 0; i < t1.FunctionMemberSize(); ++i) {
    m = t1.FunctionMemberAt(i);
    std::cout << m.Name() << " " << m.TypeOf().Name();
    for (Type_Iterator ti = m.FunctionParameter_Begin(); ti !=
        m.FunctionParameter_End(); ++ti) {
        std::cout << (*ti).Name() << std::endl;
    }
}
}

```

It is not only possible to introspect information through Reflex but also take actions. E.g. instantiate classes/structs, invoke functions, set data members, etc. The instantiation of a type which represents a class struct can be done with:

```
Object o1 = t1.Construct();
```

which will call the default constructor for this type and allocate the memory for this type inside the Object. The Object will also contain the type information constructed.

Now the object of a certain type has been constructed one may interact with it. E.g. getting the value of a data member can be done via which will return an Object of the data member in question.

```

Object mem_obj = o1.Get("fMem1");
int real_value = 0;
if (mem_obj.TypeOf().Name() == "int")
    int real_value = Object_Cast<int>(mem_obj);

```

It is also possible to invoke function members via the Object class. A function member can be looked up by name, if the member is overloaded an additional parameter which is the string representation of the type can be passed. Currently parameters for the function to invoke shall be passed as a vector of memory addresses of the parameters. This may change in the future to pass a vector of Objects.

```

int par1 = 2;
std::vector<void*> parVec;
parVec.push_back(&par1);
int ret_val = Object_Cast<int>(
    o1.Invoke("GetMem1", "int (int)", parVec));

```

Calling the destructor of an Object can be done via, this will call both the destructor and of the object type and deallocate the memory.

```
o1.Destruct();
```

### 7.10.6 Cintex

Cintex is an optional package inside ROOT. In order to build it you have to

```
./configure --enable-cintex at the ROOT configuration step.
```

The purpose of the Cintex package is to bridge uni-directional information from the Reflex to the CINT dictionary system. This package will be needed as long as the unification of the Reflex and CINT dictionaries has not been completed. This unification is work ongoing. In order to use Cintex functionality it will be needed to load the Cintex library (e.g. libCintex.so on linux systems) and enable the Cintex gateway with

```
Cintex::Enable();
```

After these two steps have been taken, any Reflex dictionary information should be propagated to the CINT dictionaries and subsequently usable inside the CINT environment (e.g. from the root prompt). If wanted debugging information while loading Reflex dictionaries can be turned on with (any number greater than 0 can be used as argument but will not make any difference in the amount of debugging output for the time being).

```
Cintex::SetDebug(1);
```



# Chapter 8

## Object Ownership

An object has ownership of another object if it has permission to delete it. Usually a collection or a parent object such as a pad holds ownership. To prevent memory leaks and multiple attempts to delete an object, you need to know which objects ROOT owns and which are owned by you.

The following rules apply to the ROOT classes.

- Histograms, trees, and event lists created by the user are owned by current directory (*gDirectory*). When the current directory is closed or deleted the objects it owns are deleted.
- The TROOT master object (*gROOT*) has several collections of objects. Objects that are members of these collections are owned by *gROOT* see “Ownership by the Master TROOT Object (*gROOT*)”.
- Objects created by another object, for example the function object (e.g. *TF1*) created by the *TH1::Fitmethod* is **owned by the histogram**.
- An object created by *DrawCopy* methods, is owned by the pad it is drawn in.

If an object fits none of these cases, the user has ownership. The next paragraphs describe each rule and user ownership in more detail.

### 8.1 Ownership by Current Directory (*gDirectory*)

When a histogram, tree, or event list (*TEventList*) is created, it is added to the list of objects in the current directory by default. You can get the list of objects in a directory and retrieve a pointer to a specific object with the *GetList* method. This example retrieves a histogram.

```
TH1F *h = (TH1F*)gDirectory->GetList()->FindObject("myHist");
```

The method *TDirectory::GetList()* returns a *TList* of objects in the directory. It looks in memory, and is implemented in all ROOT collections. You can change the directory of a histogram, tree, or event list with the *SetDirectory* method. Here we use a histogram for an example, but the same applies to trees and event lists.

```
h->SetDirectory(newDir);
```

You can also remove a histogram from a directory by using *SetDirectory(0)*. Once a histogram is removed from the directory, it will not be deleted when the directory is closed. It is now your responsibility to delete this histogram once you have finished with it. To change the default that automatically adds the histogram to the current directory, you can call the static function:

```
TH1::AddDirectory(kFALSE);
```

Not all histograms created here after will be added to the current directory. In this case, you own all histogram objects and you will need to delete them and clean up the references. You can still set the directory of a histogram by calling `SetDirectory` once it has been created as described above.

Note that, when a file goes out of scope or is closed all objects on its object list are deleted.

## 8.2 Ownership by the Master TROOT Object (gROOT)

The master object `gROOT`, maintains several collections of objects. For example, a canvas is added to the collection of canvases and it is owned by the canvas collection.

```
TSeqCollection* fFiles      List of TFile
TSeqCollection* fMappedFiles List of TMappedFile
TSeqCollection* fSockets    List of TSocket and TServerSocket
TSeqCollection* fCanvases   List of TCanvas
TSeqCollection* fStyles     List of TStyle
TSeqCollection* fFunctions  List of TF1, TF2, TF3
TSeqCollection* fTasks      List of TTask
TSeqCollection* fColors     List of TColor
TSeqCollection* fGeometries List of geometries
TSeqCollection* fBrowsers   List of TBrowser
TSeqCollection* fSpecials   List of special objects
TSeqCollection* fCleanups   List of recursiveRemove collections
```

These collections are also displayed in the root folder of the `Object Browser`. Most of these collections are self explanatory. The special cases are the collections of specials and cleanups.

### 8.2.1 The Collection of Specials

This collection contains objects of the following classes: `TCutG`, `TMultiDimFit`, `TPrincipal`, `TChains`. In addition it contains the `gHtml` object, `gMinuit` objects, and the array of contours graphs (`TGraph`) created when calling the `Draw` method of a histogram with the "CONT, LIST" option.

### 8.2.2 Access to the Collection Contents

The current content for a collection listed above can be accessed with the corresponding `gROOT->GetListOf` method (for example `gROOT->GetListOfCanvases`). In addition, `gROOT->GetListOfBrowsablees` returns a collection of all objects visible on the left side panel in the browser. See the image of the `Object Browser` in the next figure.

## 8.3 Ownership by Other Objects

When an object creates another, the creating object is the owner of the created one. For example:

```
myHisto->Fit("gaus")
```

The call to `Fit` copies the global `TF1` Gaussian function and attaches the copy to the histogram. When the histogram is deleted, the copy is deleted also.

When a pad is deleted or cleared, all objects in the pad with the `kCanDelete` bit set are deleted automatically. Currently the objects created by the `DrawCopy` methods, have the `kCanDelete` bit set and are therefore owned by the pad.

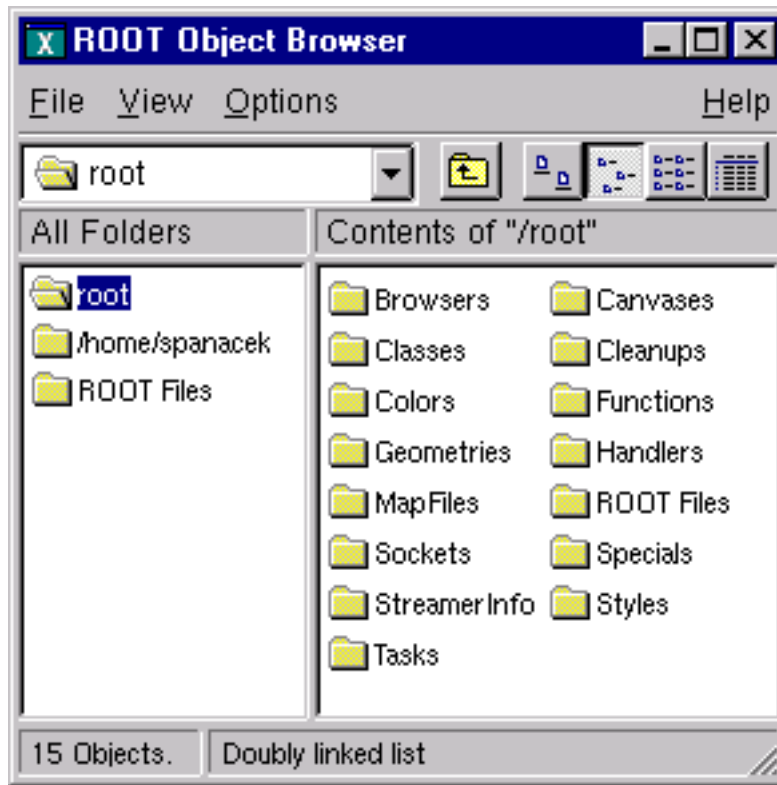

Figure 8.1: The ROOT Object Browser

## 8.4 Ownership by the User

The user owns all objects not described in one of the above cases. `TObject` has two bits, `kCanDelete` and `kMustCleanup`, that influence how an object is managed (in `TObject::fBits`). These are in an enumeration in `TObject.h`. To set these bits do:

```
MyObject->SetBit(kCanDelete)
MyObject->SetBit(kMustCleanup)
```

The bits can be reset and tested with the `TObject::ResetBit` and `TObject::TestBit` methods.

### 8.4.1 The `kCanDelete` Bit

The `gROOT` collections (see above) own their members and will delete them regardless of the `kCanDelete` bit. In all other collections, when the collection `Clear` method is called (i.e. `TList::Clear()`), members with the `kCanDelete` bit set, are deleted and removed from the collection. If the `kCanDelete` bit is not set, the object is only removed from the collection but not deleted.

If a collection `Delete` (`TList::Delete()`) method is called, all objects in the collection are deleted without considering the `kCanDelete` bit. It is important to realize that deleting the collection (i.e. `delete MyCollection`), DOES NOT delete the members of the collection.

If the user specified `MyCollection->SetOwner()` the collection owns the objects and `delete MyCollection` will delete all its members. Otherwise, you need to:

```
// delete all member objects in the collection
MyCollection->Delete();

// and delete the collection object
delete MyCollection;
```

Note that `kCanDelete` is automatically set by the `DrawCopy` method and the user can set it for any object. For example, the user must manage all graphics primitives. If you want `TCanvas` to delete the primitive you created you have to set the `kCanDelete` bit.

The `kCanDelete` bit setting is displayed with `TObject::ls()`. The last number is either 1 or 0 and is the `kCanDelete` bit.

```
root[] TCanvas MyCanvas("MyCanvas")
root[] MyCanvas.Divide(2,1)
root[] MyCanvas->cd(MyCanvas_1)
root[] hstat.Draw()           // hstat is an existing TH1F
root[] MyCanvas->cd(MyCanvas_2)
root[] hstat.DrawCopy()      // DrawCopy sets the kCanDelete bit
(class TH1*)0x88e73f8
root[] MyCanvas.ls()
Canvas Name=MyCanvas ...
  TCanvas ... Name= MyCanvas ...
    TPad ... Name= MyCanvas_1 ...
      TFrame ...
        OBJ: TH1F hstat Event Histogram : 0
        TPaveText ... title
        TPaveStats ... stats
    TPad ... Name= MyCanvas_2 ...
      TFrame ...
        OBJ: TH1F hstat Event Histogram : 1
        TPaveText ... title
    TPaveStats ... stats
```

## 8.4.2 The `kMustCleanup` Bit

When the `kMustCleanup` bit is set, the object destructor will remove the object and its references from all collections in the clean up collection (`gROOT::fCleanups`). An object can be in several collections, for example if an object is in a browser and on two canvases. If the `kMustCleanup` bit is set, it will be removed automatically from the browser and both canvases when the destructor of the object is called.

The `kMustCleanup` bit is set:

- When an object is added to a pad (or canvas) in `TObject::AppendPad`.
- When an object is added to a `TBrowser` with `TBrowser::Add`.
- When an object is added to a `TFolder` with `TFolder::Add`.
- When creating an inspector canvas with `TInspectCanvas::Inspector`.
- When creating a `TCanvas`.
- When painting a frame for a pad, the frame's `kMustCleanup` is set in `TPad::PaintPadFrame`

The user can add his own collection to the collection of clean ups, to take advantage of the automatic garbage collection. For example:

```
// create two list
TList *myList1, *myList2;

// add both to of clean ups
gROOT->GetListOfCleanUps()->Add(myList1);
gROOT->GetListOfCleanUps()->Add(myList2);

// assuming myObject is in myList1 and myList2, when calling:
delete myObject;

// the object is deleted from both lists
```

## Chapter 9

# Graphics and the Graphical User Interface

Graphical capabilities of ROOT range from 2D objects (lines, polygons, arrows) to various plots, histograms, and 3D graphical objects. In this chapter, we are going to focus on principals of graphics and 2D objects. Plots and histograms are discussed in a chapter of their own.

### 9.1 Drawing Objects

In ROOT, most objects derive from a base class `TObject`. This class has a virtual method `Draw()` so all objects are supposed to be able to be “drawn”. The basic whiteboard on which an object is drawn is called a canvas (defined by the class `TCanvas`). If several canvases are defined, there is only one active at a time. One draws an object in the active canvas by using the statement:

```
object.Draw()
```

This instructs the object “object” to draw itself. If no canvas is opened, a default one (named “c1”) is instantiated and is drawn.

```
root[] TLine a(0.1,0.1,0.6,0.6)
root[] a.Draw()
<TCanvas::MakeDefCanvas>: created default TCanvas with name c1
```

The first statement defines a line and the second one draws it. A default canvas is drawn since there was no opened one.

### 9.2 Interacting with Graphical Objects

When an object is drawn, one can interact with it. For example, the line drawn in the previous paragraph may be moved or transformed. One very important characteristic of ROOT is that transforming an object on the screen will also transform it in memory. One actually interacts with the real object, not with a copy of it on the screen. You can try for instance to look at the starting X coordinate of the line:

```
root[] a.GetX1()
(double)1.000000000e-1
```

X1 is the x value of the starting coordinate given in the definition above. Now move it interactively by clicking with the left mouse button in the line’s middle and try to do again:

```
root[] a.GetX1()
(Double_t)1.31175468483816005e-01
```



You do not obtain the same result as before, the coordinates of ‘a’ have changed. As said, interacting with an object on the screen changes the object in memory.

### 9.2.1 Moving, Resizing and Modifying Objects



Changing the graphic objects attributes can be done with the GUI or programmatically. First, let's see how it is done in the GUI.

#### 9.2.1.1 The Left Mouse Button

As was just seen moving or resizing an object is done with the left mouse button. The cursor changes its shape to indicate what may be done:

Point the object or one part of it:  

Rotate: 

Resize (exists also for the other directions):  

Enlarge (used for text): 

Move: 

Here are some examples of:

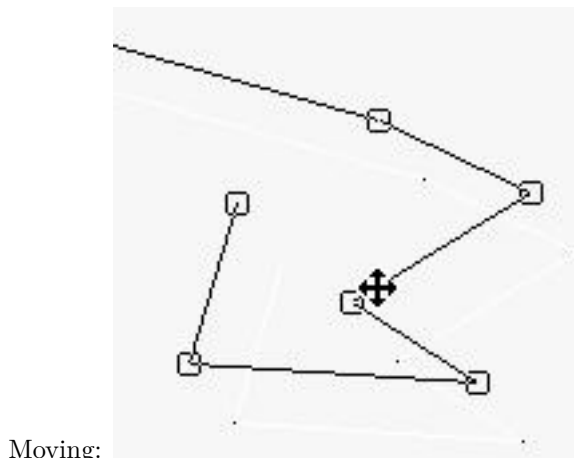

Moving:

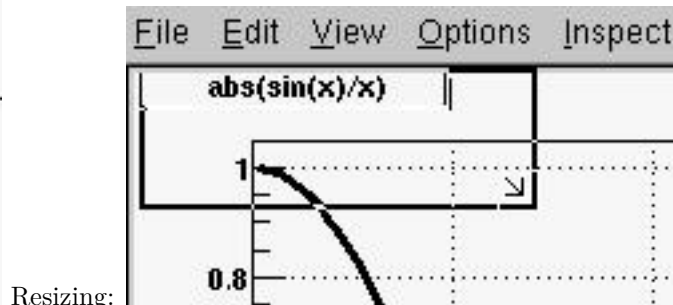

Resizing:



Rotating:

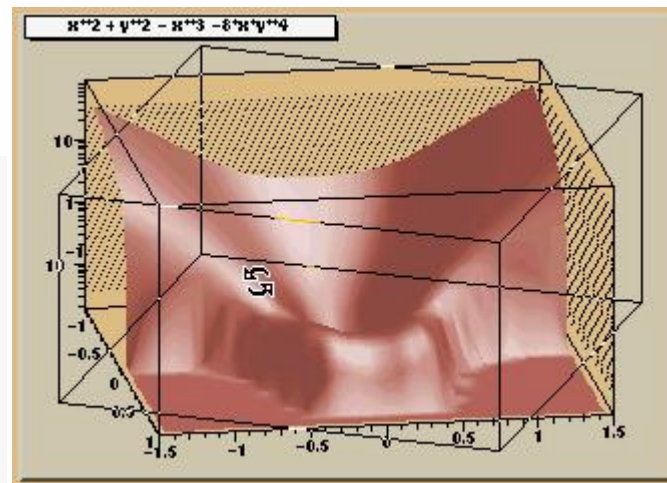



### 9.2.1.2 With C++ Statements (Programmatically)

How would one move an object in a script? Since there is a tight correspondence between what is seen on the screen and the object in memory, changing the object changes it on the screen. For example, try to do:

```
root [] a.SetX1(0.9)
```

This should change one of the coordinates of our line, but nothing happens on the screen. Why is that? In short, the canvas is not updated with each change for performance reasons. See “Updating the Pad”.

## 9.2.2 Selecting Objects

### 9.2.2.1 The Middle Mouse Button

Objects in a canvas, as well as in a pad, are stacked on top of each other in the order they were drawn. Some objects may become “active” objects, which mean they are reordered to be on top of the others. To interactively make an object “active”, you can use the middle mouse button. In case of canvases or pads, the border becomes highlighted when it is active.

### 9.2.2.2 With C++ Statements (Programmatically)

Frequently we want to draw in different canvases or pads. By default, the objects are drawn in the active canvas. To activate a canvas you can use the `TPad::cd()` method.

```
root [] c1->cd()
```

## 9.2.3 Context Menus: the Right Mouse Button

The context menus are a way to interactively call certain methods of an object. When designing a class, the programmer can add methods to the context menu of the object by making minor changes to the header file.

### 9.2.3.1 Using Context Menus

On a ROOT canvas, you can right-click on any object and see the context menu for it. The script `hsimple.C` draws a histogram. The image below shows the context menus for some of the objects on the canvas. Next picture shows that drawing a simple histogram involves as many as seven objects. When selecting a method from the context menu and that method has options, the user will be asked for numerical values or strings to fill in the option. For example, `TAxis::SetTitle` will prompt you for a string to use for the axis title.

### 9.2.3.2 Structure of the Context Menus

The curious reader will have noticed that each entry in the context menu corresponds to a method of the class. Look for example to the menu named `TAxis::xaxis`. `xaxis` is the name of the object and `TAxis` the name of its class. If we look at the list of `TAxis` methods, for example in <http://root.cern.ch/root/html/doc/TAxis.html>, we see the methods `SetTimeDisplay()` and `UnZoom()`, which appear also in the context menu.

There are several divisions in the context menu, separated by lines. The top division is a list of the class methods; the second division is a list of the parent class methods. The subsequent divisions are the methods other parent classes in case of multiple inheritance. For example, see the `TPaveText::title` context menu. A `TPaveText` inherits from `TAttLine`, which has the method `SetLineAttributes()`.

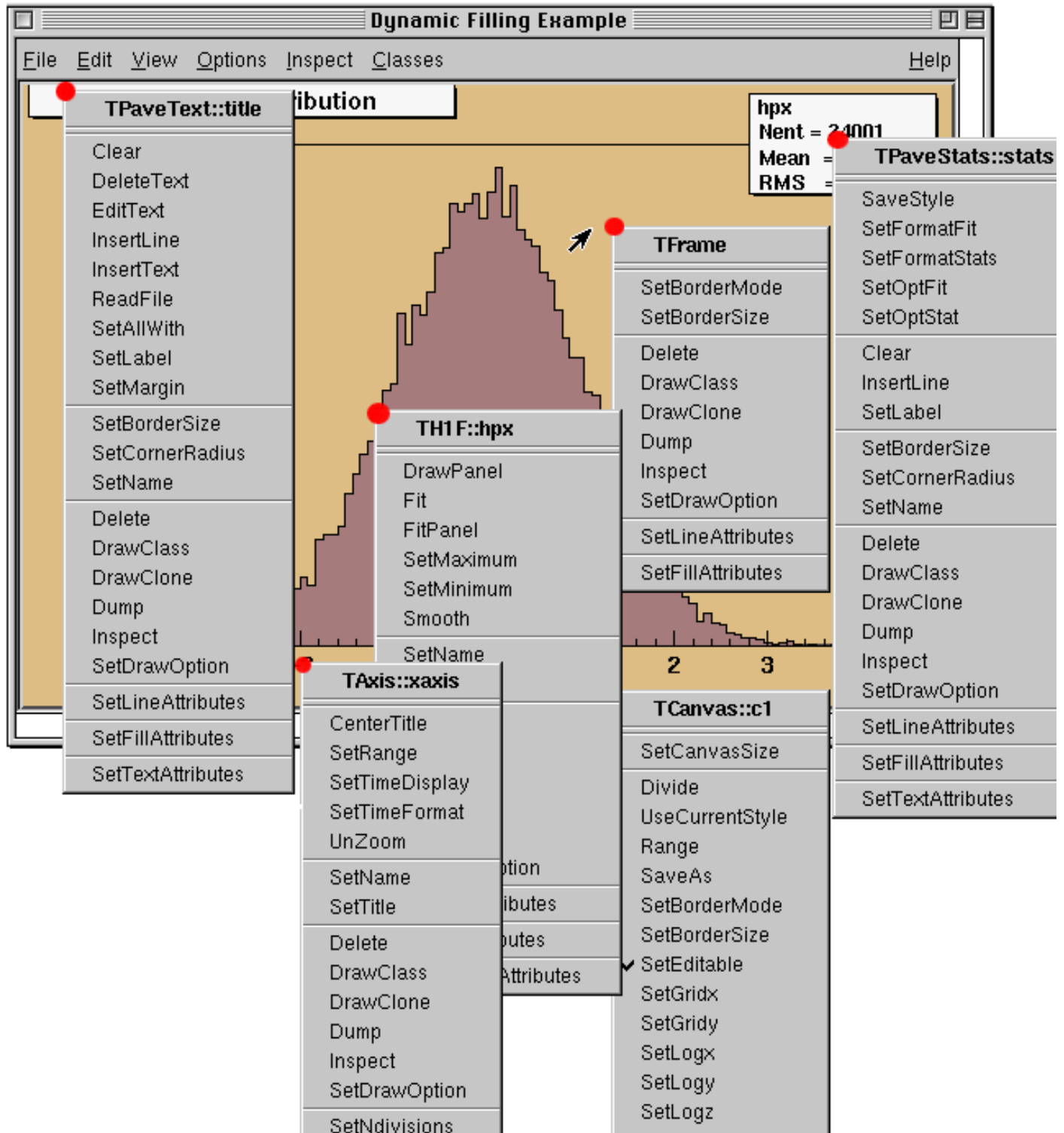

Figure 9.1: Context menus of different objects in a canvas

### 9.2.3.3 Adding Context Menus for a Class

For a method to appear in the context menu of the object it has to be marked by `// *MENU*` in the header file. Below is the line from `TAttLine.h` that adds the `SetLineAttribute` method to the context menu.

```
virtual void SetLineAttributes(); // *MENU*
```

Nothing else is needed, since CINT knows the classes and their methods. It takes advantage of that to create the context menu on the fly when the object is clicking on. If you click on an axis, ROOT will ask the interpreter what are the methods of the `TAxis` and which ones are set for being displayed in a context menu.

Now, how does the interpreter know this? Remember, when you build a class that you want to use in the ROOT environment, you use `rootcint` that builds the so-called stub functions and the dictionary. These functions and the dictionary contain the knowledge of the used classes. To do this, `rootcint` parses all the header files. ROOT has defined some special syntax to inform CINT of certain things, this is done in the comments so that the code still compiles with a C++ compiler.

For example, you have a class with a `Draw()` method, which will display itself. You would like a context menu to appear when on clicks on the image of an object of this class. The recipe is the following:

- The class has to contain the `ClassDef/ClassImp` macros
- For each method you want to appear in the context menu, put a comment after the declaration containing `*MENU*` or `*TOGGLE*` depending on the behavior you expect. One usually uses Set methods (setters). The `*TOGGLE*` comment is used to toggle a `boolean` data field. In that case, it is safe to call the data field `fMyBool` where `MyBool` is the name of the setter `SetMyBool`. Replace `MyBool` with your own `boolean` variable.
- You can specify arguments and the data members in which to store the arguments.

For example:

```
class MyClass : public TObject {
private:
    int    fV1;    // first variable
    double fV2;    // second variable
public:
    int    GetV1() {return fV1;}
    double GetV2() {return fV2;}
    void    SetV1(int x1) { fV1 = x1; } // *MENU*
    void    SetV2(double d2) { fV2 = d2; } // *MENU*
    void    SetBoth(int x1, double d2) {fV1 = x1; fV2 = d2;}

    ClassDef (MyClass,1)
}
```

To specify arguments:

```
void SetXXX(Int_t x1, Float_t y2); // *MENU* *ARGS={x1=>fV1}
```

This statement is in the comment field, after the `*MENU*`. If there is more than one argument, these arguments are separated by commas, where `fX1` and `fY2` are data fields in the same class.

```
void SetXXX(Int_t x1, Float_t y2); // *MENU* *ARGS={x1=>fX1,y2=>fY2}
```

If the arguments statement is present, the option dialog displayed when selecting `SetXXX` field will show the values of variables. We indicate to the system which argument corresponds to which data member of the class.

## 9.2.4 Executing Events when a Cursor Passes on Top of an Object

This paragraph is for class designers. When a class is designed, it is often desirable to include drawing methods for it. We will have a more extensive discussion about this, but drawing an object in a canvas or a pad consists in “attaching” the object to that pad. When one uses `object.Draw()`, the object is NOT painted at this moment. It is only attached to the active pad or canvas.

Another method should be provided for the object to be painted, the `Paint()` method. This is all explained in the next paragraph. As well as `Draw()` and `Paint()`, other methods may be provided by the designer of the class. When the mouse is moved or a button pressed/released, the `TCanvas` function named `HandleInput()` scans the list of objects in all its pads and for each object calls some standard methods to make the object react to the event (mouse movement, click or whatever).

The second one is `DistanceToPrimitive(px,py)`. This function computes a “distance” to an object from the mouse position at the pixel position (`px`, `py`, see definition at the end of this paragraph) and returns this distance in pixel units. The selected object will be the one with the shortest computed distance. To see how this works, select the “Event Status” item in the canvas “Options” menu. ROOT will display one status line showing the picked object. If the picked object is, for example, a histogram, the status line indicates the name of the histogram, the position `x,y` in histogram coordinates, the channel number and the channel content.

It is nice for the canvas to know what the closest object from the mouse is, but it’s even nicer to be able to make this object react. The third standard method to be provided is `ExecuteEvent()`. This method actually does the event reaction. Its prototype is where `px` and `py` are the coordinates at which the event occurred, except if the event is a key press, in which case `px` contains the key code.

```
void ExecuteEvent(Int_t event, Int_t px, Int_t py);
```

Where `event` is the event that occurs and is one of the following (defined in `Buttons.h`):

```
kNoEvent,          kButton1Down,      kButton2Down,
kButton3Down,      kKeyDown,          kButton1Up,
kButton2Up,        kButton3Up,        kButton1Motion,
kButton2Motion,    kButton3Motion,    kKeyPress,
kButton1Locate,    kButton2Locate,    kButton3Locate,
kKeyUp,            kButton1Double,    kButton2Double,
kButton3Double,    kMouseMotion,      kMouseEnter,
kMouseLeave
```

We hope the names are self-explanatory.

Designing an `ExecuteEvent` method is not very easy, except if one wants very basic treatment. We will not go into that and let the reader refer to the sources of classes like `TLine` or `TBox`. Go and look at their `ExecuteEvent` method! We can nevertheless give some reference to the various actions that may be performed. For example, one often wants to change the shape of the cursor when passing on top of an object. This is done with the `SetCursor` method:

```
gPad->SetCursor(cursor)
```

The argument `cursor` is the type of cursor. It may be:

```
kBottomLeft, kBottomRight, kTopLeft,
kTopRight,   kBottomSide,  kLeftSide,
kTopSide,    kRightSide,   kMove,
kCross,      kArrowHor,    kArrowVer,
kHand,       kRotate,      kPointer,
kArrowRight, kCaret,       kWatch
```

They are defined in `TVirtualX.h` and again we hope the names are self-explanatory. If not, try them by designing a small class. It may derive from something already known like `TLine`.

Note that the `ExecuteEvent()` functions may in turn; invoke such functions for other objects, in case an object is drawn using other objects. You can also exploit at best the virtues of inheritance. See for example how the class `TArrow` (derived from `TLine`) use or redefine the picking functions in its base class.

The last comment is that mouse position is always given in pixel units in all these standard functions. `px=0` and `py=0` corresponds to the top-left corner of the canvas. Here, we have followed the standard convention in windowing systems. Note that user coordinates in a canvas (pad) have the origin at the bottom-left corner of the canvas (pad). This is all explained in the paragraph “The Coordinate Systems of a Pad”.

## 9.3 Graphical Containers: Canvas and Pad

We have talked a lot about canvases, which may be seen as windows. More generally, a graphical entity that contains graphical objects is called a Pad. A Canvas is a special kind of Pad. From now on, when we say something about pads, this also applies to canvases. A pad (class `TPad`) is a graphical container in the sense it contains other graphical objects like histograms and arrows. It may contain other pads (sub-pads) as well. A Pad is a linked list of primitives of any type (graphs, histograms, shapes, tracks, etc.). It is a kind of display list.

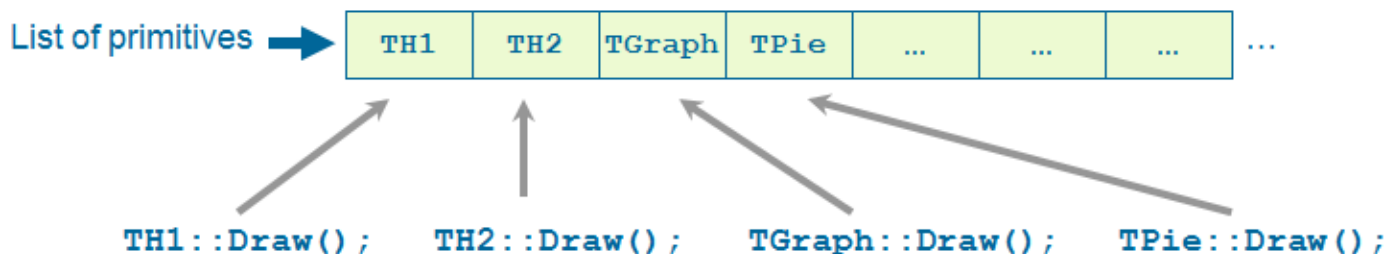

Figure 9.2: The pad display list

Drawing an object is nothing more than adding its pointer to this list. Look for example at the code of `TH1::Draw()`. It is merely ten lines of code. The last statement is `AppendPad()`. This statement calls method of `TObject` that just adds the pointer of the object, here a histogram, to the list of objects attached to the current pad. Since this is a `TObject`'s method, every object may be “drawn”, which means attached to a pad.

When is the painting done then ? The answer is: when needed. Every object that derives from `TObject` has a `Paint()` method. It may be empty, but for graphical objects, this routine contains all the instructions to paint effectively it in the active pad. Since a Pad has the list of objects it owns, it will call successively the `Paint()` method of each object, thus re-painting the whole pad on the screen. If the object is a sub-pad, its `Paint()` method will call the `Paint()` method of the objects attached, recursively calling `Paint()` for all the objects.

In some cases a pad need to be painted during a macro execution. To force the pad painting `gPad->Update()` (see next section) should be performed.

The list of primitives stored in the pad is also used to pick objects and to interact with them.

### 9.3.1 The Global Pad: gPad

When an object is drawn, it is always in the so-called active pad. For every day use, it is comfortable to be able to access the active pad, whatever it is. For that purpose, there is a global pointer, called `gPad`. It is always pointing to the active pad. If you want to change the fill color of the active pad to blue but you do not know its name, do this.

```
root[] gPad->SetFillColor(38)
```

To get the list of colors, go to the paragraph “Color and color palettes” or if you have an opened canvas, click on the **View** menu, selecting the **Colors** item.

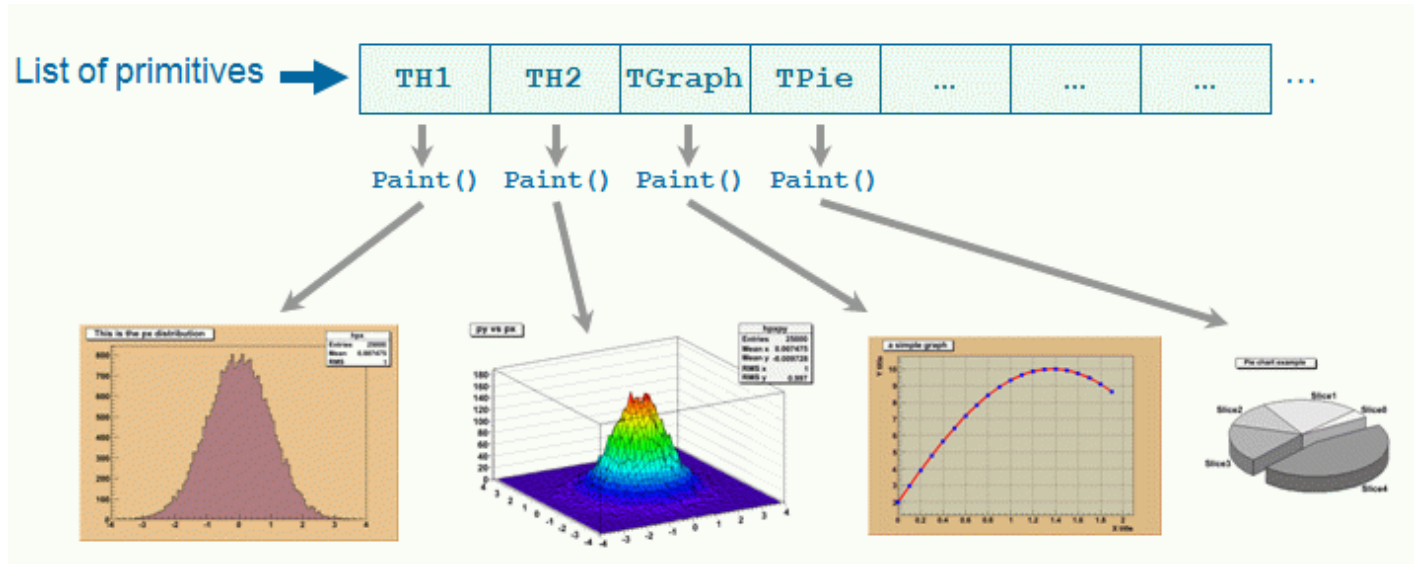

Figure 9.3: Pad painting

### 9.3.1.1 Finding an Object in a Pad

Now that we have a pointer to the active pad, `gPad` and that we know this pad contains some objects, it is sometimes interesting to access one of those objects. The method `GetPrimitive()` of `TPad`, i.e. `TPad::GetPrimitive(const char* name)` does exactly this. Since most of the objects that a pad contains derive from `TObject`, they have a name. The following statement will return a pointer to the object `myobjectname` and put that pointer into the variable `obj`. As you can see, the type of returned pointer is `TObject*`.

```
root[] obj = gPad->GetPrimitive("myobjectname")
(class TObject*)0x1063cba8
```

Even if your object is something more complicated, like a histogram `TH1F`, this is normal. A function cannot return more than one type. So the one chosen was the lowest common denominator to all possible classes, the class from which everything derives, `TObject`. How do we get the right pointer then? Simply do a cast of the function output that will transform the output (pointer) into the right type. For example if the object is a `TPaveLabel`:

```
root[] obj = (TPaveLabel*)(gPad->GetPrimitive("myobjectname"))
(class TPaveLabel*)0x1063cba8
```

This works for all objects deriving from `TObject`. However, a question remains. An object has a name if it derives from `TNamed`, not from `TObject`. For example, an arrow (`TArrow`) doesn't have a name. In that case, the "name" is the name of the class. To know the name of an object, just click with the right button on it. The name appears at the top of the context menu. In case of multiple unnamed objects, a call to `GetPrimitive("className")` returns the instance of the class that was first created. To retrieve a later instance you can use `GetListOfPrimitives()`, which returns a list of all the objects on the pad. From the list you can select the object you need.

### 9.3.1.2 Hiding an Object

Hiding an object in a pad can be made by removing it from the list of objects owned by that pad. This list is accessible by the `GetListOfPrimitives()` method of `TPad`. This method returns a pointer to a `TList`. Suppose we get the pointer to the object, we want to hide, call it `obj` (see paragraph above). We get the pointer to the list:

```
root[] li = gPad->GetListOfPrimitives()
```

Then remove the object from this list:

```
root [] li->Remove(obj)
```

The object will disappear from the pad as soon as the pad is updated (try to resize it for example). If one wants to make the object reappear:

```
root [] obj->Draw()
```

Caution, this will not work with composed objects, for example many histograms drawn on the same plot (with the option “same”). There are other ways! Try to use the method described here for simple objects.

### 9.3.2 The Coordinate Systems of a Pad

There are coordinate systems in a **TPad**: user coordinates, normalized coordinates (NDC), and pixel coordinates.

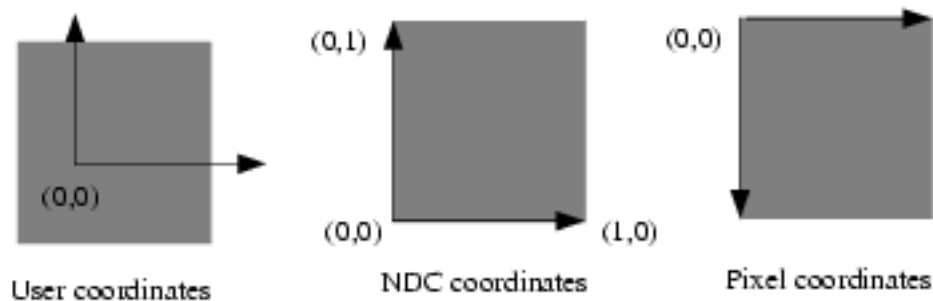

Figure 9.4: Pad coordinate systems

#### 9.3.2.1 The User Coordinate System

The most common is the user coordinate system. Most methods of **TPad** use the user coordinates, and all graphic primitives have their parameters defined in terms of user coordinates. By default, when an empty pad is drawn, the user coordinates are set to a range from 0 to 1 starting at the lower left corner. At this point they are equivalent of the NDC coordinates (see below). If you draw a high level graphical object, such as a histogram or a function, the user coordinates are set to the coordinates of the histogram. Therefore, when you set a point it will be in the histogram coordinates.

For a newly created blank pad, one may use **TPad::Range** to set the user coordinate system. This function is defined as:

```
void Range(float x1,float y1,float x2,float y2)
```

The arguments **x1**, **x2** defines the new range in the x direction, and the **y1**, **y2** define the new range in the y-direction.

```
root [] TCanvas MyCanvas ("MyCanvas")
root [] gPad->Range(-100,-100,100,100)
```

This will set the active pad to have both coordinates to go from -100 to 100, with the center of the pad at (0,0). You can visually check the coordinates by viewing the status bar in the canvas. To display the status bar select Event Status entry in the View canvas menu.

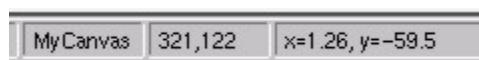

Figure 9.5: The status bar

### 9.3.2.2 The Normalized Coordinate System (NDC)

Normalized coordinates are independent of the window size and of the user system. The coordinates range from 0 to 1 and (0, 0) corresponds to the bottom-left corner of the pad. Several internal ROOT functions use the NDC system (3D primitives, PostScript, log scale mapping to linear scale). You may want to use this system if the user coordinates are not known ahead of time.

### 9.3.2.3 The Pixel Coordinate System

The least common is the pixel coordinate system, used by functions such as `DistanceToPrimitive()` and `ExecuteEvent()`. Its primary use is for cursor position, which is always given in pixel coordinates. If (px,py) is the cursor position, px=0 and py=0 corresponds to the top-left corner of the pad, which is the standard convention in windowing systems.

### 9.3.2.4 Using NDC for a particular Object

Most of the time, you will be using the user coordinate system. But sometimes, you will want to use NDC. For example, if you want to draw text always at the same place over a histogram, no matter what the histogram coordinates are. There are two ways to do this. You can set the NDC for one object or may convert NDC to user coordinates. Most graphical objects offer an option to be drawn in NDC. For instance, a line (**TLine**) may be drawn in NDC by using `DrawLineNDC()`. A latex formula or a text may use `TText::SetNDC()` to be drawn in NDC coordinates.

## 9.3.3 Converting between Coordinate Systems

There are a few utility functions in **TPad** to convert from one system of coordinates to another. In the following table, a point is defined by (px,py) in pixel coordinates, (ux,uy) in user coordinates, (ndcx,ndcy) in normalized coordinates, (apx, apy) are in absolute pixel coordinates.

Conversion	TPad's Methods	Returns
NDC to Pixel	<code>UtoPixel(ndcx)</code>	<code>Int_t</code>
	<code>VtoPixel(ndcy)</code>	<code>Int_t</code>
Pixel to User	<code>PixeltoX(px)</code>	<code>Double_t</code>
	<code>PixeltoY(py)</code>	<code>Double_t</code>
	<code>PixeltoXY(px,py,&amp;ux,&amp;uy)</code>	<code>Double_t ux,uy</code>
User to Pixel	<code>XtoPixel(ux)</code>	<code>Int_t</code>
	<code>YtoPixel(uy)</code>	<code>Int_t</code>
	<code>XYtoPixel(ux,uy,&amp;px,&amp;py)</code>	<code>Int_t px,py</code>
User to absolute pixel	<code>XtoAbsPixel(ux)</code>	<code>Int_t</code>
	<code>YtoAbsPixel(uy)</code>	<code>Int_t</code>
	<code>XYtoAbsPixel(ux,uy,&amp;apx,&amp;apy)</code>	<code>Int_t apx,apy</code>
Absolute pixel to user	<code>AbsPixeltoX(apx)</code>	<code>Double_t</code>
	<code>AbsPixeltoY(apy)</code>	<code>Double_t</code>
	<code>AbsPixeltoXY(apx,apy,&amp;ux,&amp;uy)</code>	<code>Double_t ux,uy</code>

Note: all the pixel conversion functions along the Y axis consider that py=0 is at the top of the pad except `PixeltoY()` which assume that the position py=0 is at the bottom of the pad. To make `PixeltoY()` converting the same way as the other conversion functions, it should be used the following way (p is a pointer to a **TPad**):

```
p->PixeltoY(py - p->GetWh());
```

## 9.3.4 Dividing a Pad into Sub-pads

Dividing a pad into sub pads in order for instance to draw a few histograms, may be done in two ways. The first is to build pad objects and to draw them into a parent pad, which may be a canvas. The second is to automatically divide a



pad into horizontal and vertical sub pads.

### 9.3.4.1 Creating a Single Sub-pad

The simplest way to divide a pad is to build sub-pads in it. However, this forces the user to explicitly indicate the size and position of those sub-pads. Suppose we want to build a sub-pad in the active pad (pointed by `gPad`). First, we build it, using a `TPad` constructor:

```
root[] spad1 = new TPad("spad1","The first subpad",.1,.1,.5,.5)
```

One gives the coordinates of the lower left point (0.1, 0.1) and of the upper right one (0.5, 0.5). These coordinates are in NDC. This means that they are independent of the user coordinates system, in particular if you have already drawn for example a histogram in the mother pad. The only thing left is to draw the pad:

```
root[] spad1->Draw()
```

If you want more sub-pads, you have to repeat this procedure as many times as necessary.

### 9.3.4.2 Dividing a Canvas into Sub-Pads

The manual way of dividing a pad into sub-pads is sometimes very tedious. There is a way to automatically generate horizontal and vertical sub-pads inside a given pad.

```
root[] pad1->Divide(3,2)
```

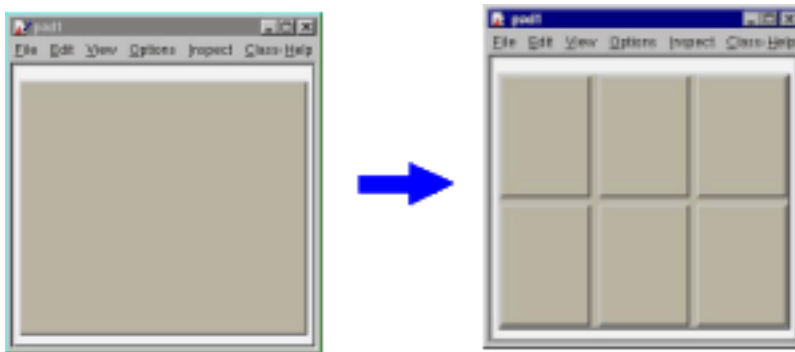

Figure 9.6: Dividing a pad into 6 sub-pads

If `pad1` is a pad then, it will divide the pad into 3 columns of 2 sub-pads. The generated sub-pads get names `pad1_i` where the index  $i=1$  to  $n \times m$  (in our case `pad1_1`, `pad1_2`... `pad1_6`). The names `pad1_1`etc... correspond to new variables in CINT, so you may use them as soon as the executed method was `pad->Divide()`. However, in a compiled program, one has to access these objects. Remember that a pad contains other objects and that these objects may themselves be pads. So we can use the `GetPrimitive()` method:

```
TPad* pad1_1 = (TPad*)(pad1->GetPrimitive("pad1_1"))
```

One question remains. In case one does an automatic divide, how one can set the default margins between pads? This is done by adding two parameters to `Divide()`, which are the margins in `x` and `y`:

```
root[] pad1->Divide(3,2,0.1,0.1)
```

The margins are here set to 10% of the parent pad width.

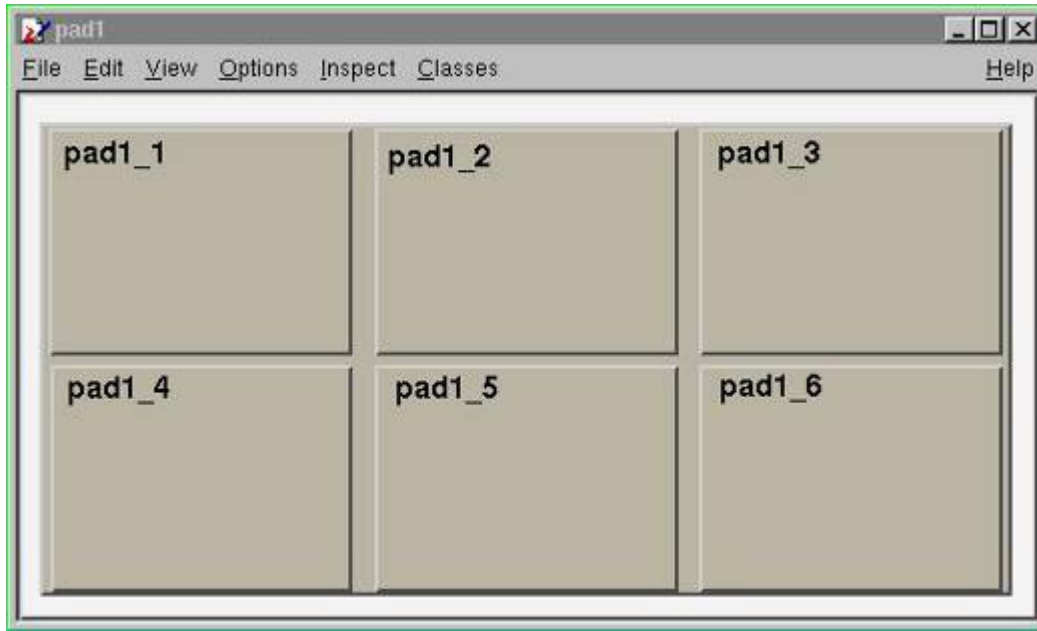

Figure 9.7: Dividing a pad into 6 sub-pads

### 9.3.5 Updating the Pad

For performance reasons, a pad is not updated with every change. For example, changing the coordinates of the pad does not automatically redraw it. Instead, the pad has a “bit-modified” that triggers a redraw. This bit is automatically set by:

- Touching the pad with the mouse - for example resizing it with the mouse.
- Finishing the execution of a script.
- Adding a new primitive or modifying some primitives for example the name and title of an object.
- You can also set the “bit-modified” explicitly with the `Modified` method:

```
// the pad has changed
root[] pad1->Modified()
// recursively update all modified pads:
root[] c1->Update()
```

A subsequent call to `TCanvas::Update()` scans the list of sub-pads and repaints the pads declared modified.

In compiled code or in a long macro, you may want to access an object created during the paint process. To do so, you can force the painting with a `TCanvas::Update()`. For example, a `TGraph` creates a histogram (`TH1`) to paint itself. In this case the internal histogram obtained with `TGraph::GetHistogram()` is created only after the pad is painted. The pad is painted automatically after the script is finished executing or if you force the painting with `TPad::Modified()` followed by a `TCanvas::Update()`. Note that it is not necessary to call `TPad::Modified()` after a call to `Draw()`. The “bit-modified” is set automatically by `Draw()`. A note about the “bit-modified” in sub pads: when you want to update a sub pad in your canvas, you need to call `pad->Modified()` rather than `canvas->Modified()`, and follow it with a `canvas->Update()`. If you use `canvas->Modified()`, followed by a call to `canvas->Update()`, the sub pad has not been declared modified and it will not be updated. Also note that a call to `pad->Update()` where `pad` is a sub pad of `canvas`, calls `canvas->Update()` and recursively updates all the pads on the canvas.

### 9.3.6 Making a Pad Transparent

As we will see in the paragraph “Fill Attributes”, a fill style (type of hatching) may be set for a pad.

```
root[] pad1->SetFillStyle(istyle)
```

This is done with the `SetFillStyle` method where `istyle` is a style number, defined in “Fill Attributes”. A special set of styles allows handling of various levels of transparency. These are styles number 4000 to 4100, 4000 being fully transparent and 4100 fully opaque. So, suppose you have an existing canvas with several pads. You create a new pad (transparent) covering for example the entire canvas. Then you draw your primitives in this pad. The same can be achieved with the graphics editor. For example:

```
root[] .x tutorials/hist/hidraw.C
root[] TPad *newpad=new TPad("newpad","Transparent pad",0,0,1,1);
root[] newpad->SetFillStyle(4000);
root[] newpad->Draw();
root[] newpad->cd();
root[] // create some primitives, etc
```

### 9.3.7 Setting the Log Scale

Setting the scale to logarithmic or linear is an attribute of the pad, not the axis or the histogram. The scale is an attribute of the pad because you may want to draw the same histogram in linear scale in one pad and in log scale in another pad. Frequently, we see several histograms on top of each other in the same pad. It would be very inconvenient to set the scale attribute for each histogram in a pad.

Furthermore, if the logic was set in the histogram class (or each object) the scale setting in each `Paint` method of all objects should be tested.

If you have a pad with a histogram, a right-click on the pad, outside of the histograms frame will convince you. The `SetLogx()`, `SetLogy()` and `SetLogz()` methods are there. As you see, `TPad` defines log scale for the two directions `x` and `y` plus `z` if you want to draw a 3D representation of some function or histogram.

The way to set log scale in the `x` direction for the active pad is:

```
root[] gPad->SetLogx(1)
```

To reset log in the `z` direction:

```
root[] gPad->SetLogz(0)
```

If you have a divided pad, you need to set the scale on each of the sub-pads. Setting it on the containing pad does not automatically propagate to the sub-pads. Here is an example of how to set the log scale for the `x`-axis on a canvas with four sub-pads:

```
root[] TCanvas MyCanvas("MyCanvas","My Canvas")
root[] MyCanvas->Divide(2,2)
root[] MyCanvas->cd(1)
root[] gPad->SetLogx()
root[] MyCanvas->cd(2)
root[] gPad->SetLogx()
root[] MyCanvas->cd(3)
root[] gPad->SetLogx()
```

### 9.3.8 WaitPrimitive method

When the `TPad::WaitPrimitive()` method is called with no arguments, it will wait until a double click or any key pressed is executed in the canvas. A call to `gSystem->Sleep(10)` has been added in the loop to avoid consuming at all the CPU. This new option is convenient when executing a macro. By adding statements like:

```
canvas->WaitPrimitive();
```

You can monitor the progress of a running macro, stop it at convenient places with the possibility to interact with the canvas and resume the execution with a double click or a key press.

### 9.3.9 Locking the Pad

You can make the **TPad** non-editable. Then no new objects can be added, and the existing objects and the pad can not be changed with the mouse or programmatically. By default the **TPad** is editable.

```
TPad::SetEditable(kFALSE)
```

## 9.4 Graphical Objects

In this paragraph, we describe the various simple 2D graphical objects defined in ROOT. Usually, one defines these objects with their constructor and draws them with their **Draw()** method. Therefore, the examples will be very brief. Most graphical objects have line and fill attributes (color, width) that will be described in “Graphical objects attributes”. If the user wants more information, the class names are given and he may refer to the online developer documentation. This is especially true for functions and methods that set and get internal values of the objects described here. By default 2D graphical objects are created in User Coordinates with (0, 0) in the lower left corner.

### 9.4.1 Lines, Arrows and Polylines

The simplest graphical object is a line. It is implemented in the **TLine** class. The line constructor is:

```
TLine(Double_t x1, Double_t y1, Double_t x2, Double_t y2)
```

The arguments **x1**, **y1**, **x2**, **y2** are the coordinates of the first and second point. It can be used:

```
root[] l = new TLine(0.2,0.2,0.8,0.3)
root[] l->Draw()
```

The arrow constructor is:

```
TArrow(Double_t x1, Double_t y1,
       Double_t x2, Double_t y2,
       Float_t arrowsize, Option_t *option)
```

It defines an arrow between points **x1,y1** and **x2,y2**. The arrow size is in percentage of the pad height. The **option** parameter has the following meanings:

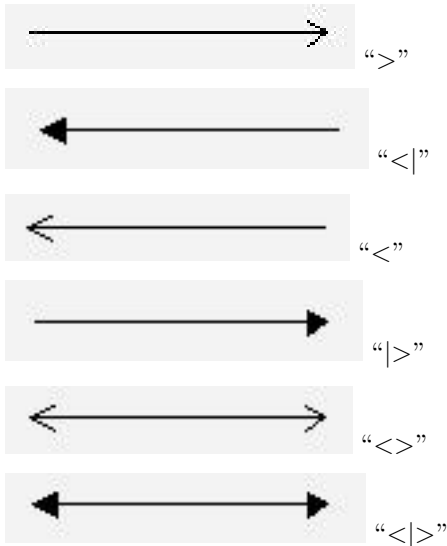

Once an arrow is drawn on the screen, one can:

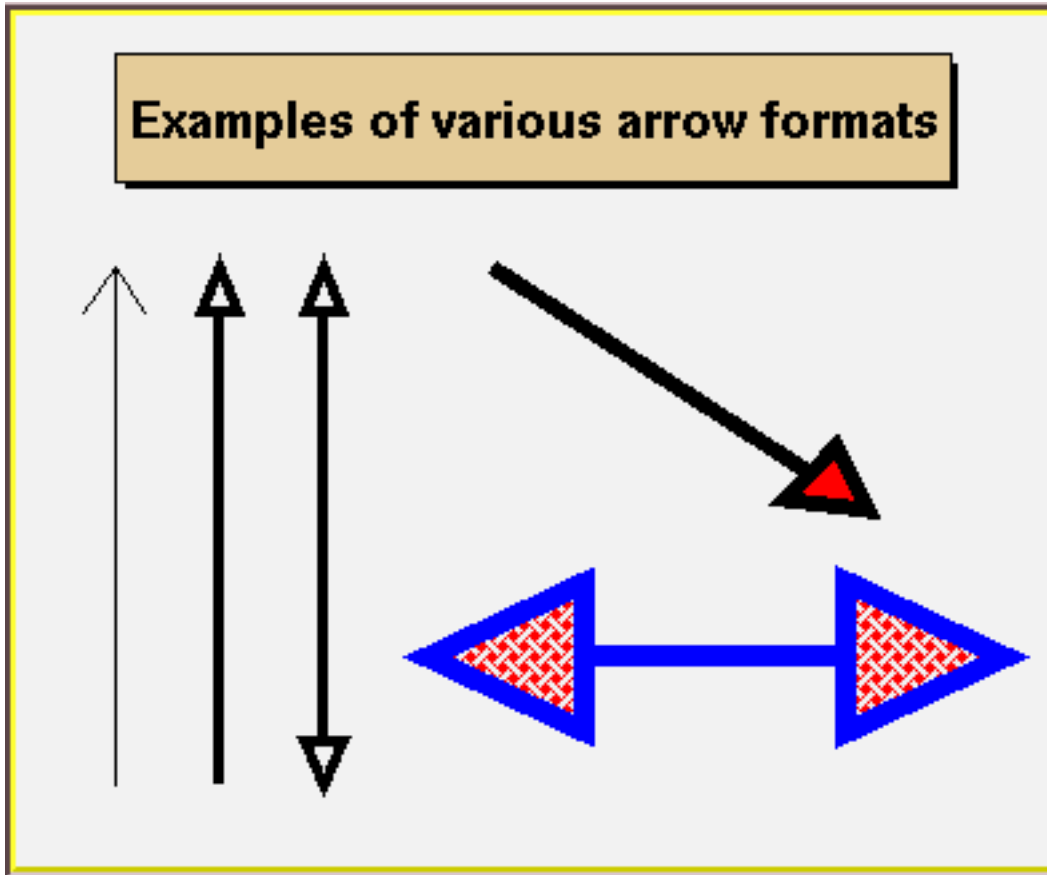

Figure 9.8: Different arrow formats

- click on one of the edges and move this edge.
- click on any other arrow part to move the entire arrow.

If `FillColor` is 0, an open triangle is drawn; else a full triangle is filled with the set fill color. If `ar` is an arrow object, fill color is set with:

```
ar.SetFillColor(icolor);
```

Where `icolor` is the color defined in “Color and Color Palettes”.

The default-opening angle between the two sides of the arrow is 60 degrees. It can be changed with the method `ar->SetAngle(angle)`, where `angle` is expressed in degrees.

A poly-line is a set of joint segments. It is defined by a set of `N` points in a 2D space. Its constructor is:

```
TPolyLine(Int_t n, Double_t* x, Double_t* y, Option_t* option)
```

Where `n` is the number of points, and `x` and `y` are arrays of `n` elements with the coordinates of the points. `TPolyLine` can be used by itself, but is also a base class for other objects, such as curly arcs.

## 9.4.2 Circles and Ellipses

An ellipse can be truncated and rotated. It is defined by its center  $(x_1, y_1)$  and two radii `r1` and `r2`. A minimum and maximum angle may be specified (`phimin, phimax`). The ellipse may be rotated with an angle `theta`. All these angles are in degrees. The attributes of the outline line are set via `TAttLine`, of the fill area - via `TAttFill` class. They are described in “Graphical Objects Attributes”.

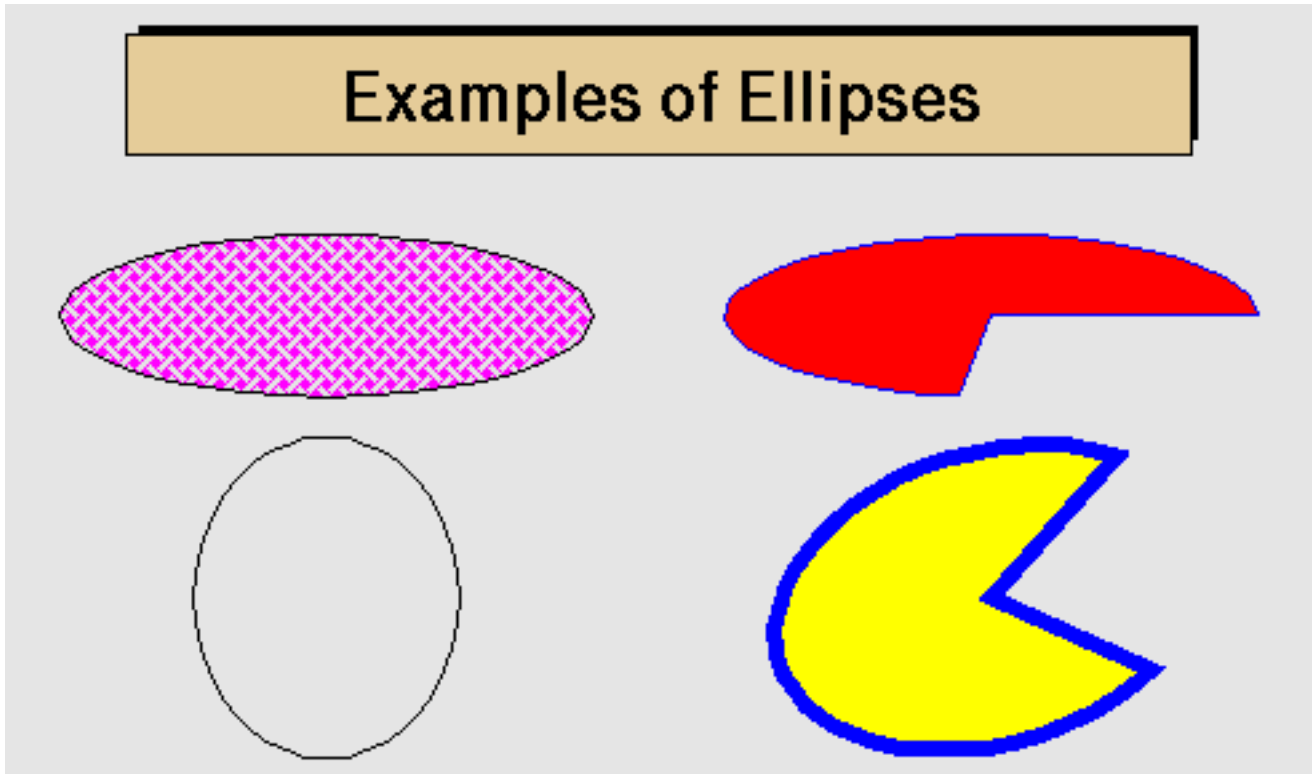

Figure 9.9: Different types of ellipses

When an ellipse sector is drawn only, the lines between the center and the end points of the sector are drawn by default. By specifying the drawn option “only”, these lines can be avoided. Alternatively, the method `SetNoEdges()` can be called. To remove completely the ellipse outline, specify zero (0) as a line style.

The `TEllipse` constructor is:

```
TEllipse(Double_t x1, Double_t y1, Double_t r1, Double_t r2,
         Double_t phimin, Double_t phimax, Double_t theta)
```

An ellipse may be created with:

```
root[] e = new TEllipse(0.2,0.2,0.8,0.3)
root[] e->Draw()
```

### 9.4.3 Rectangles

The class `TBox` defines a rectangle. It is a base class for many different higher-level graphical primitives. Its bottom left coordinates `x1`, `y1` and its top right coordinates `x2`, `y2`, defines a box. The constructor is:

```
TBox(Double_t x1, Double_t y1, Double_t x2, Double_t y2)
```

It may be used as in:

```
root[] b = new TBox(0.2,0.2,0.8,0.3)
root[] b->SetFillColor(5)
root[] b->Draw()
```

A `TWbox` is a rectangle (`TBox`) with a border size and a border mode. The attributes of the outline line and of the fill area are described in “Graphical Objects Attributes”



Figure 9.10: A rectangle with a border

#### 9.4.4 Markers

A marker is a point with a fancy shape! The possible markers are shown in the next figure.

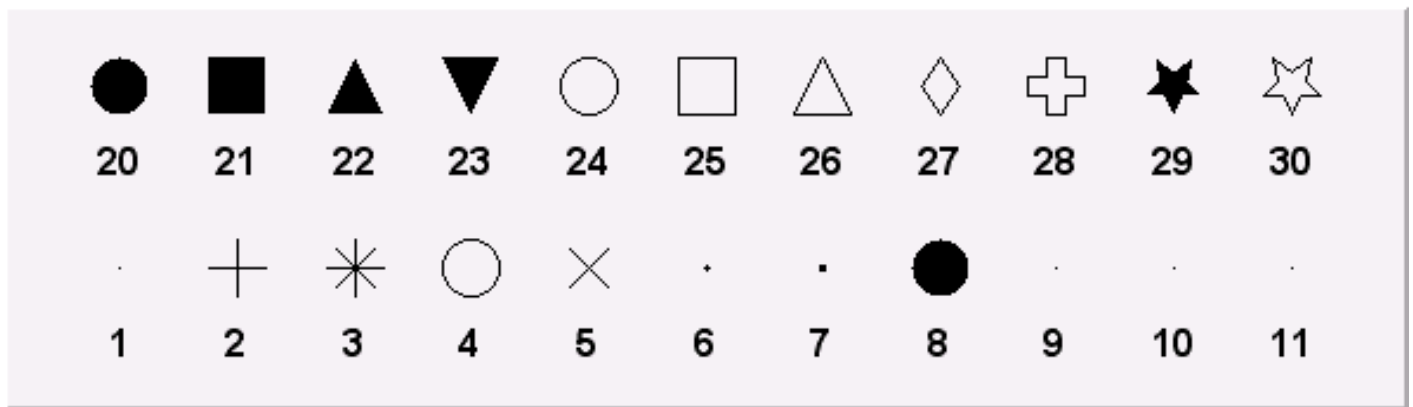

Figure 9.11: Markers

The marker constructor is:

```
TMarker(Double_t x, Double_t y, Int_t marker)
```

The parameters  $x$  and  $y$  are the marker coordinates and `marker` is the marker type, shown in the previous figure. Suppose the pointer `ma` is a valid marker. The marker size is set via `ma->SetMarkerSize(size)`, where `size` is the desired size. Note, that the marker types 1, 6 and 7 (the dots) cannot be scaled. They are always drawn with the same number of pixels. `SetMarkerSize` does not apply on them. To have a “scalable dot” a circle shape should be used instead, for example, the marker type 20. The default marker type is 1, if `SetMarkerStyle` is not specified. It is the most common one to draw scatter plots.

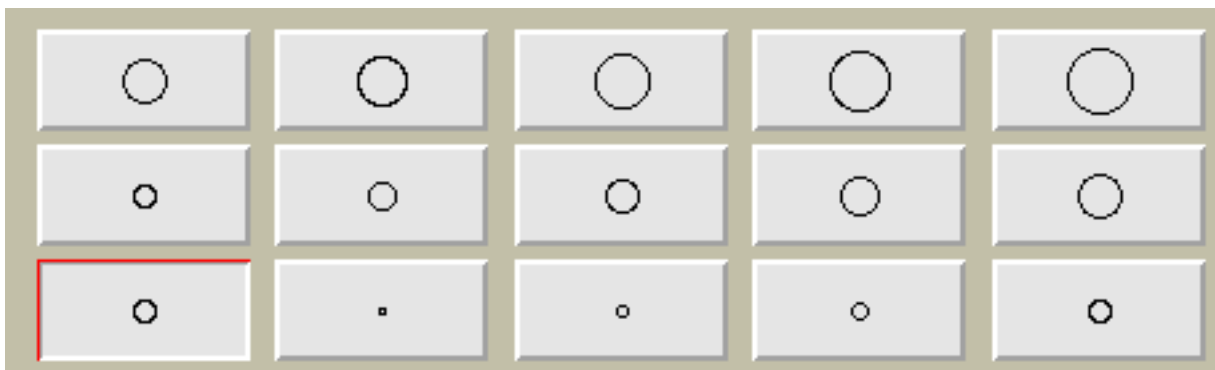

Figure 9.12: Different marker sizes



Figure 9.13: Different marker sizes

The user interface for changing the marker color, style and size looks like shown in this picture. It takes place in the editor frame anytime the selected object inherits the class **TAttMarker**.

Non-symmetric symbols should be used carefully in plotting. The next two graphs show how the misleading a careless use of symbols can be. The two plots represent the same data sets but because of a bad symbol choice, the two on the top appear further apart from the next example.

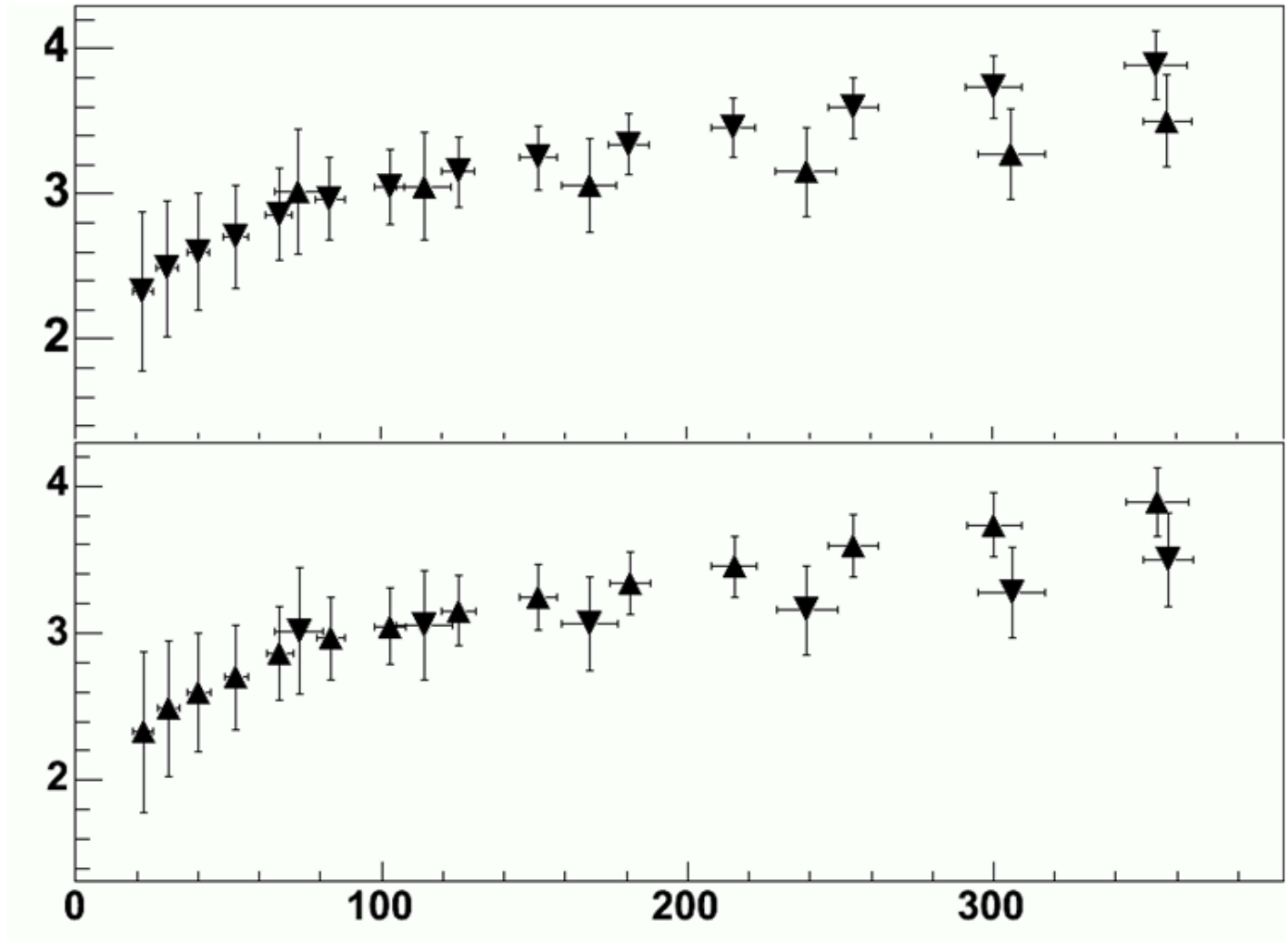

Figure 9.14: The use of non-symmetric markers

A **TPolyMaker** is defined by an array on  $N$  points in a 2D space. At each point  $x[i]$ ,  $y[i]$  a marker is drawn. The list of marker types is shown in the previous paragraph. The marker attributes are managed by the class **TAttMarker** and are described in “Graphical Objects Attributes”. The **TPolyMaker** constructor is:

```
TPolyMarker(Int_t n, Double_t *x, Double_t *y, Option_t *option)
```

Where  $x$  and  $y$  are arrays of coordinates for the  $n$  points that form the poly-marker.



### 9.4.5 Curly and Wavy Lines for Feynman Diagrams

This is a peculiarity of particle physics, but we do need sometimes to draw Feynman diagrams. Our friends working in banking can skip this part. A set of classes implements curly or wavy poly-lines typically used to draw Feynman diagrams. Amplitudes and wavelengths may be specified in the constructors, via commands or interactively from context menus. These classes are `TCurlyLine` and `TCurlyArc`. These classes make use of `TPolyLine` by inheritance; `ExecuteEvent` methods are highly inspired from the methods used in `TPolyLine` and `TArc`.

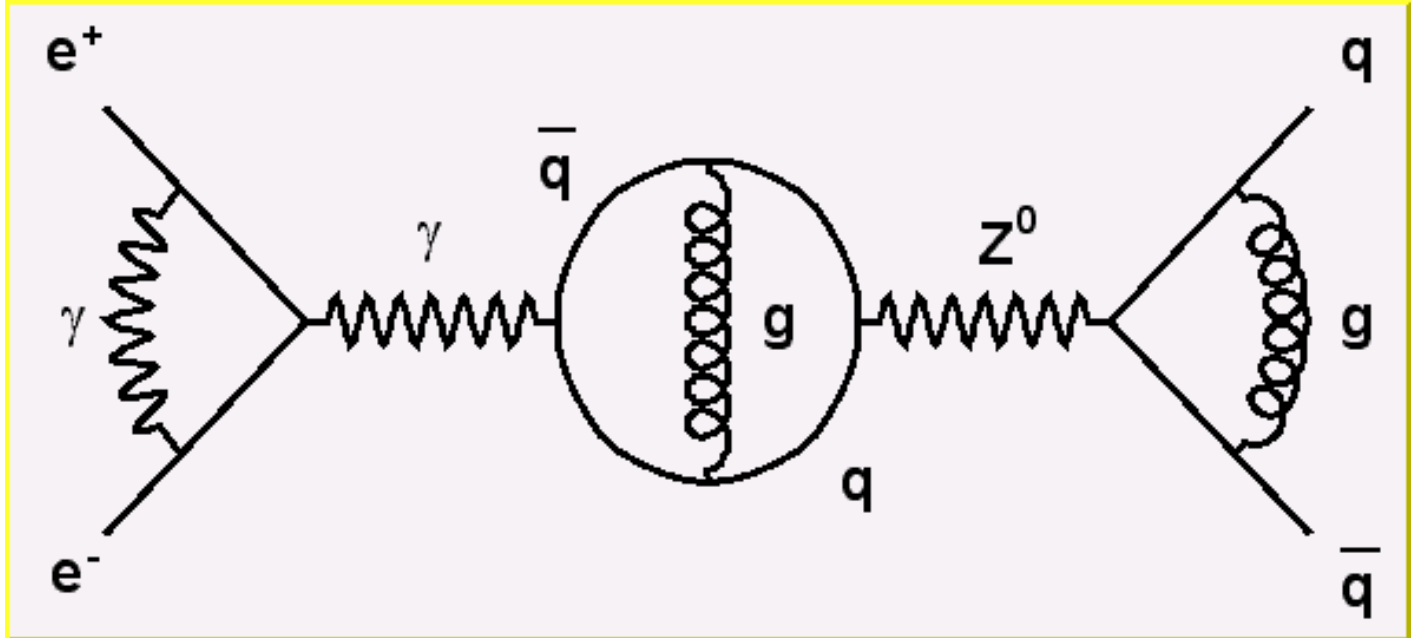

Figure 9.15: The picture generated by the tutorial macro `feynman.C`

The `TCurlyLine` constructor is:

```
TCurlyLine(Double_t x1, Double_t y1, Double_t x2, Double_t y2,
           Double_t wavelength, Double_t amplitude)
```

The coordinates  $(x_1, y_1)$  define the starting point,  $(x_2, y_2)$  - the end-point. The `wavelength` and the `amplitude` are given in percent of the pad height.

The `TCurlyArc` constructor is:

```
TCurlyArc(Double_t x1, Double_t y1, Double_t rad,
          Double_t phimin, Double_t phimax,
          Double_t wavelength, Double_t amplitude)
```

The curly arc center is  $(x_1, y_1)$  and the radius is `rad`. The `wavelength` and the `amplitude` are given in percent of the line length. The parameters `phimin` and `phimax` are the starting and ending angle of the arc (given in degrees). Refer to `$ROOTSYS/tutorials/graphics/feynman.C` for the script that built the figure above.

### 9.4.6 Text and Latex Mathematical Expressions

Text displayed in a pad may be embedded into boxes, called paves (`TPaveLabel`), or titles of graphs or many other objects but it can live a life of its own. All text displayed in ROOT graphics is an object of class `TText`. For a physicist, it will be most of the time a `TLatex` expression (which derives from `TText`). `TLatex` has been conceived to draw mathematical formulas or equations. Its syntax is very similar to the Latex in mathematical mode.

### 9.4.6.1 Subscripts and Superscripts

Subscripts and superscripts are made with the `_` and `^` commands. These commands can be combined to make complex subscript and superscript expressions. You may choose how to display subscripts and superscripts using the 2 functions `SetIndiceSize(Double_t)` and `SetLimitIndiceSize(Int_t)`. Examples of what can be obtained using subscripts and superscripts:

The expression	Gives	The expression	Gives	The expression	Gives
<code>x^{2y}</code>	$x^{2y}$	<code>x^{y^{2}}</code>	$x^{y^2}$	<code>x_{1}^{y_{1}}</code>	$x_1^{y_1}$
<code>x_{2y}</code>	$x_{2y}$	<code>x^{y_{1}}</code>	$x^{y_1}$	<code>x_{1}^{y}</code>	$x_1^y$

### 9.4.6.2 Fractions

Fractions denoted by the `/` symbol are made in the obvious way. The `#frac` command is used for large fractions in displayed formula; it has two arguments: the numerator and the denominator. For example, the equation  $x = y + z \sqrt{2} + 1$  is obtained by following expression `x=#frac{y+z/2}{y^{2}+1}`.

### 9.4.6.3 Roots

The `#sqrt` command produces the square ROOT of its argument; it has an optional first argument for other roots.

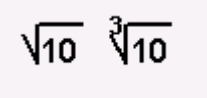

$$\sqrt{10} \quad \sqrt[3]{10}$$

Example: `#sqrt{10}` `#sqrt[3]{10}`

### 9.4.6.4 Delimiters

You can produce three kinds of proportional delimiters.

`#[]{...}` or “à la” Latex

`#left[...#right]` big square brackets

`#>{...}` or `#left{...#right}` big curly brackets

`#||{...}` or `#left|...#right|` big absolute value symbol

`#(){...}` or `#left(...#right)` big parenthesis

### 9.4.6.5 Changing Style in Math Mode

You can change the font and the text color at any moment using:

`#font[font-number]{...}` and `#color[color-number]{...}`

### 9.4.6.6 Line Splitting

A `TLatex` string may be split in two with the following command: `#splitline{top}{bottom}`. `TAxis` and `TGaxis` objects can take advantage of this feature. For example, the date and time could be shown in the time axis over two lines with: `#splitline{21 April 2003}{14:23:56}`

### 9.4.7 Greek Letters

The command to produce a lowercase Greek letter is obtained by adding # to the name of the letter. For an uppercase Greek letter, just capitalize the first letter of the command name.

```
#alpha    #beta    #chi    #delta    #varepsilon #phi
#gamma    #eta    #iota    #varphi    #kappa    #lambda
#mu       #nu     #omicron #pi       #theta    #rho
#sigma    #tau    #upsilon #varomega #omega    #xi
#psi      #zeta   #Alpha   #Beta    #Chi      #Delta
#Epsilon  #Phi    #Gamma   #Eta     #Iota     #Kappa
#vartheta #Lambda #Mu      #Nu     #Omicron  #Pi
#Theta    #Rho   #Sigma   #Tau    #Upsilon  #Omega
#varsigma #Xi    #Psi     #epsilon #varUpsilon #Zeta
```

### 9.4.8 Mathematical Symbols

**T**Latex can make mathematical and other symbols. A few of them, such as + and >, are produced by typing the corresponding keyboard character. Others are obtained with the commands as shown in the table above.

#### 9.4.8.1 Accents, Arrows and Bars

Symbols in a formula are sometimes placed one above another. **T**Latex provides special commands for that.

`#hat{a}` =hat

`#check` =inverted hat

`#acute` =acute

`#grave` =accent grave

`#dot` =derivative

`#ddot` =double derivative

`#tilde` =tilde

`#slash` =special sign. Draw a slash on top of the text between brackets for example

`#slash{E}_T` generates “Missing ET”

a `_` is obtained with `#bar{a}`

a `->` is obtained with `#vec{a}`

#### 9.4.8.2 Example 1

The script `$ROOTSYS/tutorials/graphics/latex.C`:

```
{
  TCanvas c1("c1","Latex",600,700);
  TLatex l;
  l.SetTextAlign(12);
  l.SetTextSize(0.04);

  l.DrawLatex(0.1,0.8,"1) C(x) = d #sqrt{#frac{2}{#lambdaD}}
#int^x_{0}cos(#frac{#pi}{2}t^2)dt");
  l.DrawLatex(0.1,0.6,"2) C(x) = d #sqrt{#frac{2}{#lambdaD}}
#int^x_{0}cos(#frac{#pi}{2}t^2)dt");
  l.DrawLatex(0.1,0.4,"3) R = |A|^2 =
```

Lower case		Upper case		Variations
alpha :	α	Alpha :	Α	
beta :	β	Beta :	Β	
gamma :	γ	Gamma :	Γ	
delta :	δ	Delta :	Δ	
epsilon :	ε	Epsilon :	Ε	varepsilon : ε
zeta :	ζ	Zeta :	Ζ	
eta :	η	Eta :	Η	
theta :	θ	Theta :	Θ	vartheta : ϑ
iota :	ι	Iota :	Ι	
kappa :	κ	Kappa :	Κ	
lambda :	λ	Lambda :	Λ	
mu :	μ	Mu :	Μ	
nu :	ν	Nu :	Ν	
xi :	ξ	Xi :	Ξ	
omicron :	ο	Omicron :	Ο	
pi :	π	Pi :	Π	
rho :	ρ	Rho :	Ρ	
sigma :	σ	Sigma :	Σ	varsigma : ς
tau :	τ	Tau :	Τ	
upsilon :	υ	Upsilon :	Υ	varUpsilon : Ύ
phi :	φ	Phi :	Φ	varphi : ϕ
chi :	χ	Chi :	Χ	
psi :	ψ	Psi :	Ψ	
omega :	ω	Omega :	Ω	varomega : ϖ

♣ <b>#club</b>	♦ <b>#diamond</b>	♥ <b>#heart</b>	♠ <b>#spade</b>
∅ <b>#voidn</b>	ℵ <b>#aleph</b>	ℵ <b>#Jgothic</b>	ℜ <b>#Rgothic</b>
≤ <b>#leq</b>	≥ <b>#geq</b>	< <b>#LT</b>	> <b>#GT</b>
≈ <b>#approx</b>	≠ <b>#neq</b>	≡ <b>#equiv</b>	∝ <b>#propto</b>
∈ <b>#in</b>	∉ <b>#notin</b>	⊂ <b>#subset</b>	⊄ <b>#notsubset</b>
⊃ <b>#supset</b>	⊆ <b>#subseteq</b>	⊇ <b>#supseteq</b>	∅ <b>#oslash</b>
∩ <b>#cap</b>	∪ <b>#cup</b>	∧ <b>#wedge</b>	∨ <b>#vee</b>
© <b>#ocopyright</b>	© <b>#copyright</b>	® <b>#oright</b>	® <b>#void1</b>
™ <b>#trademark</b>	™ <b>#void3</b>	Å <b>#AA</b>	å <b>#aa</b>
× <b>#times</b>	÷ <b>#divide</b>	± <b>#pm</b>	/ <b>#/</b>
• <b>#bullet</b>	° <b>#circ</b>	… <b>#3dots</b>	· <b>#upoint</b>
<i>f</i> <b>#voidb</b>	∞ <b>#infty</b>	∇ <b>#nabla</b>	∂ <b>#partial</b>
" <b>#doublequote</b>	∠ <b>#angle</b>	↙ <b>#downleftarrow</b>	⋈ <b>#corner</b>
<b>#lbar</b>	<b>#cbar</b>	— <b>#topbar</b>	{ <b>#ltbar</b>
\ <b>#arcbottom</b>	/ <b>#arctop</b>	<b>#arcbar</b>	⌊ <b>#bottombar</b>
↓ <b>#downarrow</b>	← <b>#leftarrow</b>	↑ <b>#uparrow</b>	→ <b>#rightarrow</b>
↔ <b>#leftrightarrow</b>	⊗ <b>#otimes</b>	⊕ <b>#oplus</b>	√ <b>#surd</b>
⇓ <b>#Downarrow</b>	⇐ <b>#Leftarrow</b>	⇑ <b>#Uparrow</b>	⇒ <b>#Rightarrow</b>
⇔ <b>#Leftrightarrow</b>	∏ <b>#prod</b>	∑ <b>#sum</b>	∫ <b>#int</b>

```

#frac{1}{2}(\frac{1}{2}+C(V))^2+
#\frac{1}{2}+S(V))^2)");
l.DrawLatex(0.1,0.2,"4) F(t) = \sum_{i=
-\infty}^{\infty}A(i)\cos\frac{i}{t+i}");
}

```

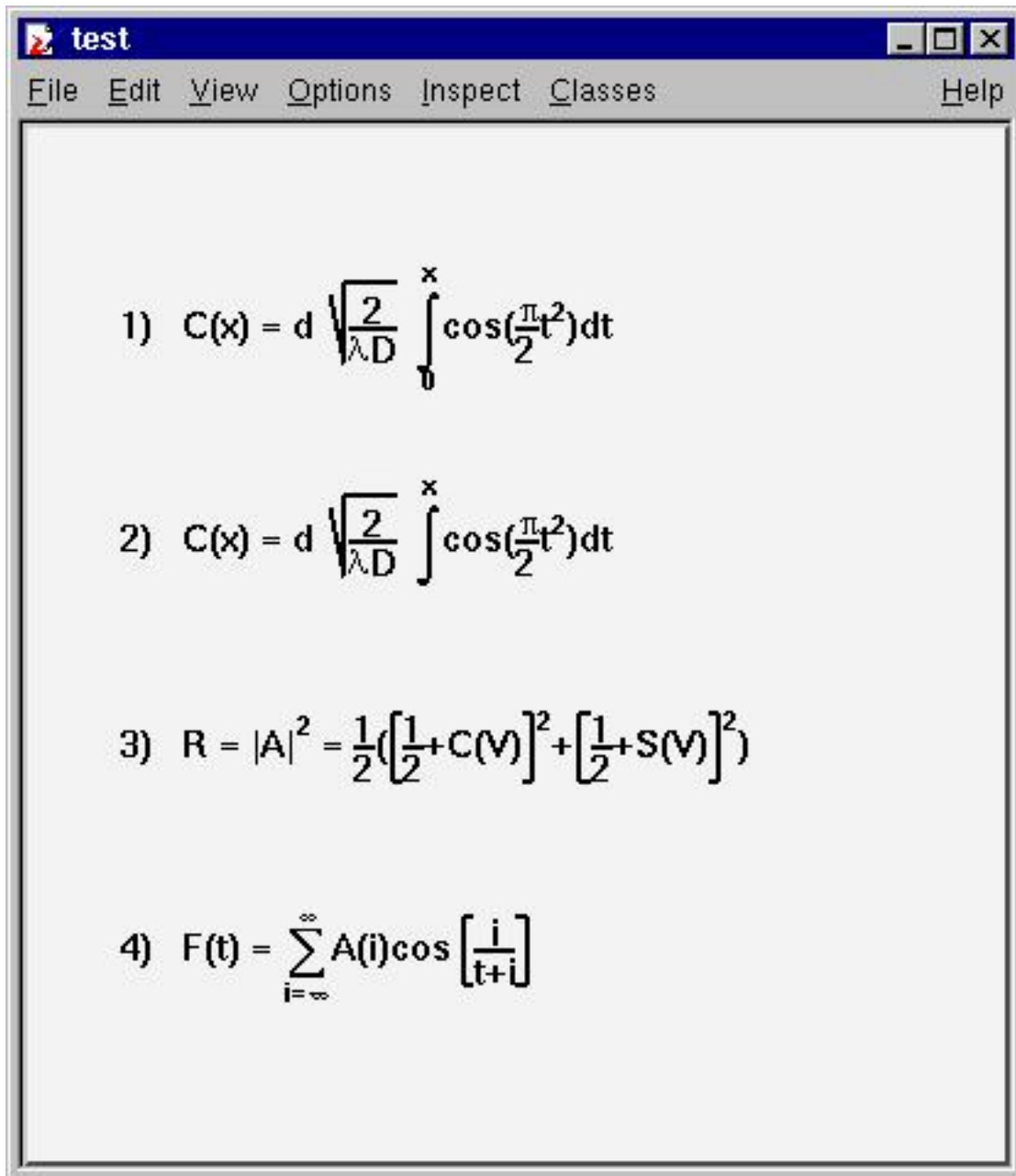

Figure 9.16: The picture generated by the tutorial macro latex.C

### 9.4.8.3 Example 2

The script \$ROOTSYS/tutorials/graphics/latex2.C:

```

{
TCanvas c1("c1","Latex",600,700);
TLatex l;
l.SetTextAlign(23);

```

```

1.SetTextSize(0.1);
1.DrawLatex(0.5,0.95,"e^{+}e^{-}\rightarrow Z^0
#rightarrow I#bar{I}, q#bar{q}");
1.DrawLatex(0.5,0.75,"|\vec{a}\#bullet\vec{b}|=
#Sigma^{i}_{jk}+b^{bj}_{i}");
1.DrawLatex(0.5,0.5,"i(\#partial_{\mu}\#bar{\psi}\#gamma^{\mu}
+m\#bar{\psi})=0
#Leftrightarrow(\#Box+m^2)\#psi=0");
1.DrawLatex(0.5,0.3,"L_{em}=eJ^{\mu}_{em}A_{\mu} ,
J^{\mu}_{em}=\#bar{I}\gamma_{\mu}I , M^j_i=\Sigma A_{\alpha}\tau^{\alpha j}");
}

```

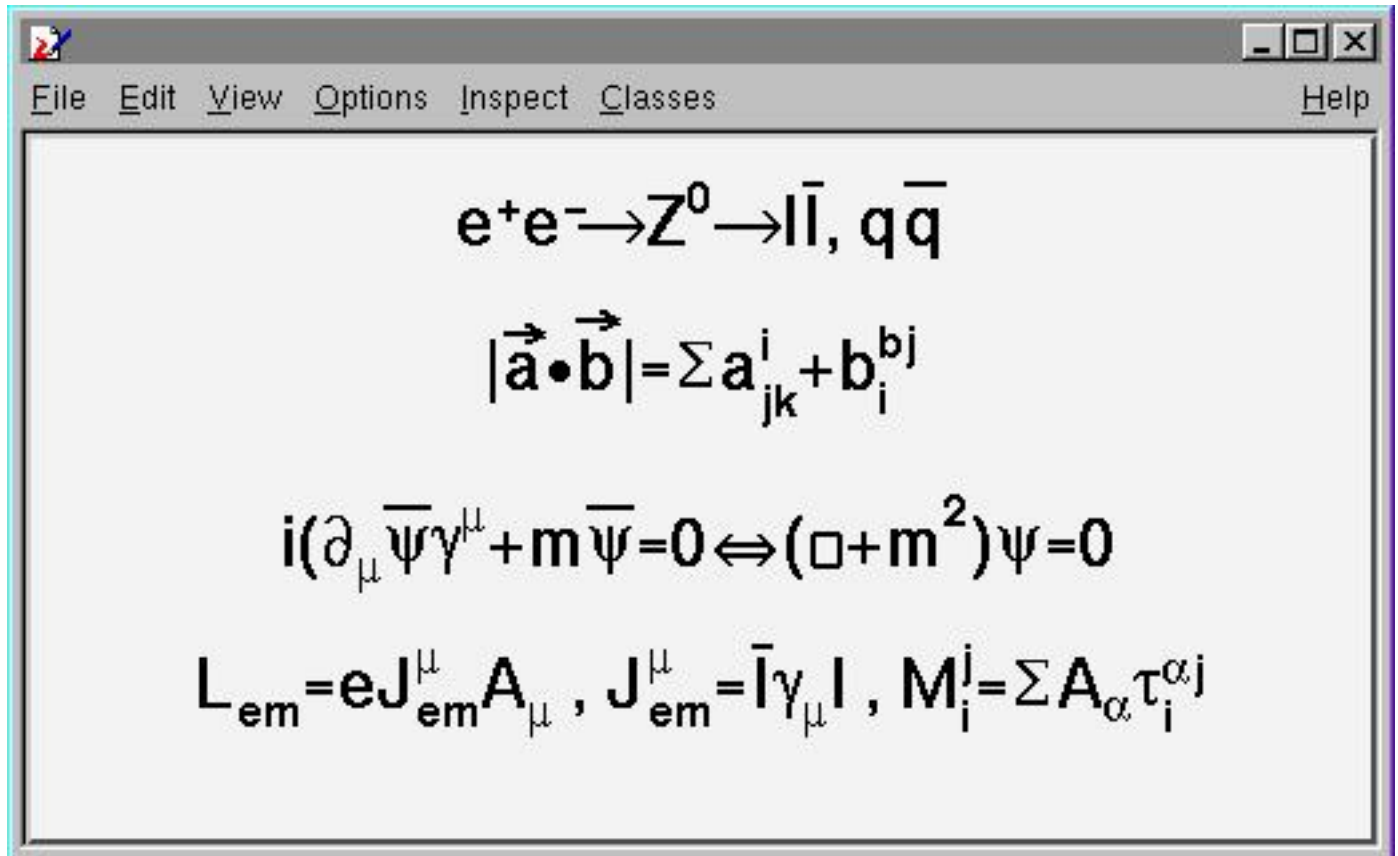

Figure 9.17: The picture generated by the tutorial macro latex2.C

#### 9.4.8.4 Example 3

The script \$ROOTSYS/tutorials/graphics/latex3.C:

```

{
TCanvas c1("c1");
TPaveText pt(.1,.5,.9,.9);
pt.AddText("#frac{2s}{\pi\alpha^2}
#frac{d\sigma}{d\cos\theta} (e^{+}e^{-}
#rightarrow f#bar{f} ) = ");
pt.AddText("#left| \frac{1}{1 - \Delta\alpha} \right|^2
(1+\cos^2\theta)");
pt.AddText("+ 4 Re \left\{ \frac{2}{1 - \Delta\alpha} \chi(s)
#[]{\hat{g}_{\nu}^e}\hat{g}_{\nu}^f\right\}");
}

```

```

(1 + cos^{2}#theta) + 2 #hat{g}_{a}^{e}
#hat{g}_{a}^{f} cos#theta } #right)");
pt.SetLabel("Born equation");
pt.Draw();
}

```

$$\begin{aligned}
 & \frac{2s}{\pi\alpha^2} \frac{d\sigma}{d\cos\theta} (e^+e^- \rightarrow f\bar{f}) = \left| \frac{1}{1-\Delta\alpha} \right|^2 (1+\cos^2\theta) \\
 & + 4 \operatorname{Re} \left\{ \frac{2}{1-\Delta\alpha} \chi(s) \left[ \tilde{g}_v^e \tilde{g}_v^f (1 + \cos^2\theta) + 2 \tilde{g}_a^e \tilde{g}_a^f \cos\theta \right] \right\} \\
 & + 16 |\chi(s)|^2 \left[ (\tilde{g}_a^e + \tilde{g}_v^e) (\tilde{g}_a^f + \tilde{g}_v^f) (1 + \cos^2\theta) + 8 \tilde{g}_a^e \tilde{g}_a^f \tilde{g}_v^e \tilde{g}_v^f \cos\theta \right]
 \end{aligned}$$

Figure 9.18: The picture generated by the tutorial macro latex3.C

#### 9.4.9 Text in a Pad

Text displayed in a pad may be embedded into boxes, called paves, or may be drawn alone. In any case, it is recommended to use a Latex expression, which is covered in the previous paragraph. Using **T<sub>L</sub>atex** is valid whether the text is embedded or not. In fact, you will use Latex expressions without knowing it since it is the standard for all the embedded text. A pave is just a box with a border size and a shadow option. The options common to all types of paves and used when building those objects are the following:

```

option = "T" top frame
option = "B" bottom frame
option = "R" right frame
option = "L" left frame
option = "NDC" x1,y1,x2,y2 are given in NDC
option = "ARC" corners are rounded

```

We will see the practical use of these options in the description of the more functional objects like `TPaveLabels`. There are several categories of paves containing text: `TPaveLabel`, `TPaveText` and `TPavesText`. `TPaveLabels` are panels containing one line of text. They are used for labeling.

```

TPaveLabel(Double_t x1, Double_t y1, Double_t x2, Double_t y2,
           const char *label, Option_t *option)

```

Where  $(x_1, y_1)$  are the coordinates of the bottom left corner,  $(x_2, y_2)$  - coordinates of the upper right corner. “label” is the text to be displayed and “option” is the drawing option, described above. By default, the border size is 5 and the



option is “br”. If one wants to set the border size to some other value, one may use the method `SetBorderSize()`. For example, suppose we have a histogram, which limits are (-100,100) in the x direction and (0, 1000) in the y direction. The following lines will draw a label in the center of the histogram, with no border. If one wants the label position to be independent of the histogram coordinates, or user coordinates, one can use the option “NDC”. See “The Coordinate Systems of a Pad”.

```
root[] p1 = new TPaveLabel(-50,0,50,200,"Some text")
root[] p1->SetBorderSize(0)
root[] p1->Draw()
```



Figure 9.19: PaveLabels drawn with different options

A `TPaveLabel` can contain only one line of text. A `TPaveText` may contain several lines. This is the only difference. This picture illustrates and explains some of the points of `TPaveText`. Once a `TPaveText` is drawn, a line can be added or removed by bringing up the context menu with the mouse.

A `TPavesText` is a stack of text panels (see `TPaveText`). One can set the number of stacked panels at building time. It has the following constructor: By default, the number of stacked panels is 5, `option="br"`.

```
TPavesText(Double_t x1, Double_t y1, Double_t x2, Double_t y2,
Int_t npaves, Option_t* option)
```

#### 9.4.10 The TeX Processor TMathText

`TMathText`'s purpose is to write mathematical equations, exactly as TeX would do it. The syntax is the same as the TeX's one.

The script `$ROOTSYS/tutorials/graphics/tmathtex.C`:

gives the following output:

`TMathText` uses plain TeX syntax and uses “\” as control instead of “#”. If a piece of text containing “\” is given to `TLatex` then `TMathText` is automatically invoked. Therefore, as histograms' titles, axis titles, labels etc ... are drawn using `TLatex`, the `TMathText` syntax can be used for them also.

## 9.5 Axis

The axis objects are automatically built by various high level objects such as histograms or graphs. Once build, one may access them and change their characteristics. It is also possible, for some particular purposes to build axis on their own. This may be useful for example in the case one wants to draw two axis for the same plot, one on the left and one on the right.

For historical reasons, there are two classes representing axis. `TAxis * axis` is the axis object, which will be returned when calling the `TH1::GetAxis()` method.

```
TAxis *axis = histo->GetXaxis()
```

Of course, you may do the same for Y and Z-axis. The graphical representation of an axis is done with the `TGaxis` class. The histogram classes and `TGraph` generate instances of this class. This is internal and the user should not have to see it.

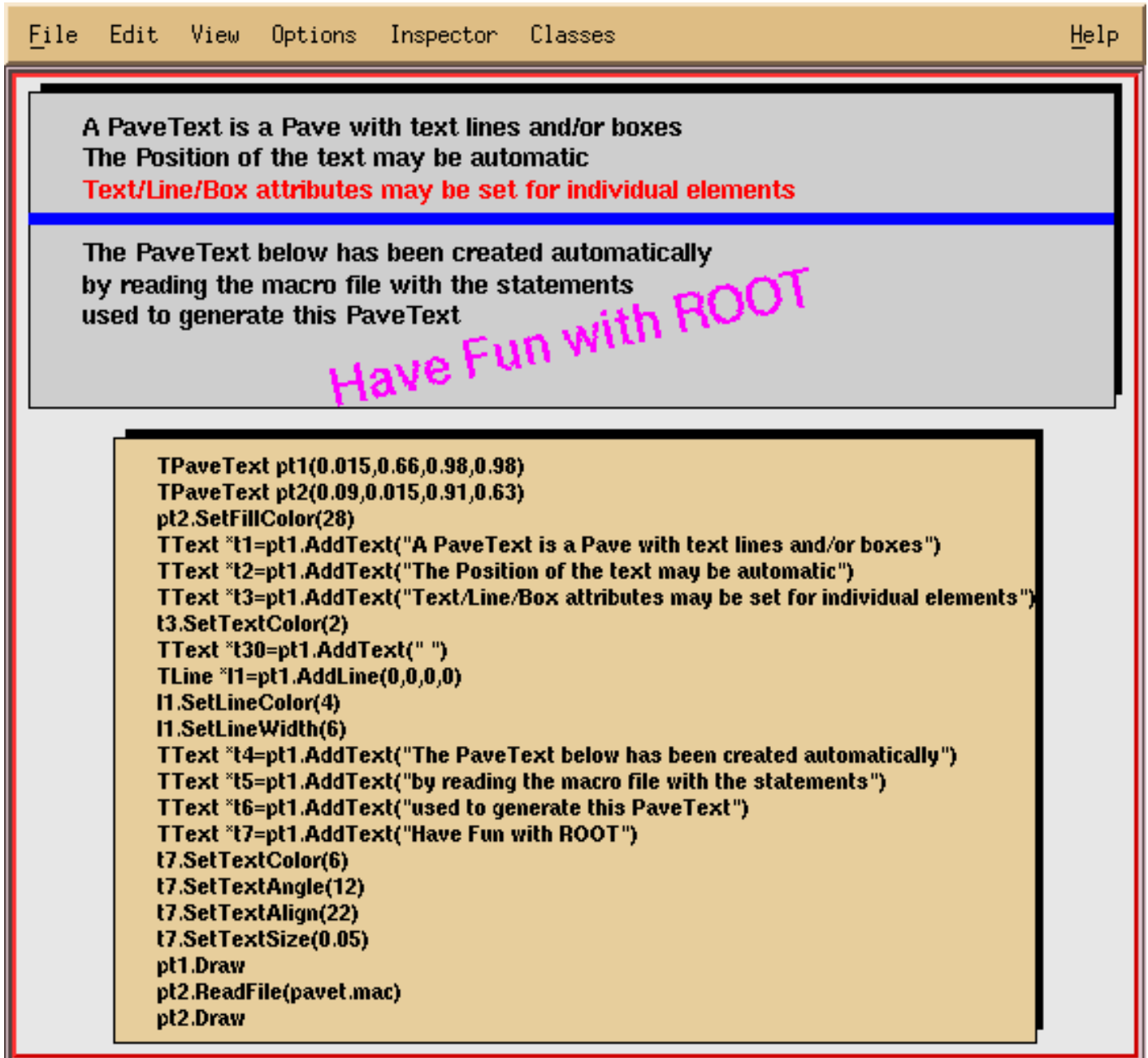

Figure 9.20: PaveText examples



Figure 9.21: A PaveText example

$$\prod_{j \geq 0} \left( \sum_{k \geq 0} a_{jk} z^k \right) = \sum_{n \geq 0} z^n \left( \sum_{\substack{k_0, k_1, \dots \geq 0 \\ k_0 + k_1 + \dots = n}} a_{0k_0} a_{1k_1} \dots \right)$$

$$W_{\delta_1 \rho_1 \sigma_2}^{3\beta} = U_{\delta_1 \rho_1 \sigma_2}^{3\beta} + \frac{1}{8\pi^2} \int_{a_1}^{a_2} da'_2 \left[ \frac{U_{\delta_1 \rho_1}^{2\beta} - a'_2 U_{\rho_1 \sigma_2}^{1\beta}}{U_{\rho_1 \sigma_2}^{0\beta}} \right]$$

$$d\Gamma = \frac{1}{2m_A} \left( \prod_f \frac{d^3 p_f}{(2\pi)^3} \frac{1}{2E_f} \right) |\mathcal{M}(m_A - \{p_f\})|^2 (2\pi)^4 \delta^{(4)}(p_A - \sum p_f)$$

$$4\text{Re} \left\{ \frac{2}{1-\Delta a} \chi(s) [\hat{g}_v^e \hat{g}_v^f (1 + \cos^2 \theta) + \hat{g}_a^e \hat{g}_a^f \cos \theta] \right\}$$

$$p(n) = \frac{1}{\pi\sqrt{2}} \sum_{k=1}^{\infty} \sqrt{k} A_k(n) \frac{d}{dn} \frac{\sinh \left\{ \frac{\pi}{k} \sqrt{\frac{2}{3}} \sqrt{n - \frac{1}{24}} \right\}}{\sqrt{n - \frac{1}{24}}}$$

$$\frac{(\ell+1)C_\ell^{TE}}{2\pi} \mathbb{N} \subset \mathbb{R}$$

RHIC スピン物理 ニュー-Йорク

Figure 9.22: A TMathText example

### 9.5.1 Axis Title

The axis title is set, as with all named objects, by

```
axis->SetTitle("Whatever title you want");
```

When the axis is embedded into a histogram or a graph, one has to first extract the axis object:

```
h->GetXaxis()->SetTitle("Whatever title you want")
```

### 9.5.2 Axis Options and Characteristics

The axis options are most simply set with the styles. The available style options controlling specific axis options are the following:

```
TAxis *axis = histo->GetXaxis();
axis->SetAxisColor(Color_t color = 1);
axis->SetLabelColor(Color_t color = 1);
axis->SetLabelFont(Style_t font = 62);
axis->SetLabelOffset(Float_t offset = 0.005);
axis->SetLabelSize(Float_t size = 0.04);
axis->SetNdivisions(Int_t n = 510, Bool_t optim = kTRUE);
axis->SetNoExponent(Bool_t noExponent = kTRUE);
axis->SetTickLength(Float_t length = 0.03);
axis->SetTitleOffset(Float_t offset = 1);
axis->SetTitleSize(Float_t size = 0.02);
```

The getters corresponding to the described setters are also available. The general options, not specific to axis, as for instance `SetTitleTextColor()` are valid and do have an effect on axis characteristics.

### 9.5.3 Setting the Number of Divisions

Use `TAxis::SetNdivisions(ndiv,optim)` to set the number of divisions for an axis. The `ndiv` and `optim` are as follows:

- `ndiv = N1 + 100*N2 + 10000*N3`
- `N1` = number of first divisions.
- `N2` = number of secondary divisions.
- `N3` = number of tertiary divisions.
- `optim = kTRUE` (default), the divisions' number will be optimized around the specified value.
- `optim = kFALSE`, or `n < 0`, the axis will be forced to use exactly `n` divisions.

For example:

`ndiv = 0`: no tick marks.

`ndiv = 2`: 2 divisions, one tick mark in the middle of the axis.

`ndiv = 510`: 10 primary divisions, 5 secondary divisions

`ndiv = -10`: exactly 10 primary divisions

### 9.5.4 Zooming the Axis

You can use `TAxis::SetRange` or `TAxis::SetRangeUser` to zoom the axis.

```
TAxis::SetRange(Int_t binfirst,Int_t binlast)
```

The `SetRange` method parameters are bin numbers. They are not axis. For example if a histogram plots the values from 0 to 500 and has 100 bins, `SetRange(0,10)` will cover the values 0 to 50. The parameters for `SetRangeUser` are user coordinates. If the start or end is in the middle of a bin the resulting range is approximation. It finds the low edge bin for the start and the high edge bin for the high.

```
TAxis::SetRangeUser(Axis_t ufirst,Axis_t ulast)
```

Both methods, `SetRange` and `SetRangeUser`, are in the context menu of any axis and can be used interactively. In addition, you can zoom an axis interactively: click on the axis on the start, drag the cursor to the end, and release the mouse button.

### 9.5.5 Drawing Axis Independently of Graphs or Histograms

An axis may be drawn independently of a histogram or a graph. This may be useful to draw for example a supplementary axis for a graph. In this case, one has to use the `TGaxis` class, the graphical representation of an axis. One may use the standard constructor for this kind of objects:

```
TGaxis(Double_t xmin, Double_t ymin, Double_t xmax, Double_t ymax,
       Double_t wmin, Double_t wmax, Int_t ndiv = 510,
       Option_t* chopt,Double_t gridlength = 0)
```

The arguments `xmin`, `ymin` are the coordinates of the axis' start in the user coordinates system, and `xmax`, `ymax` are the end coordinates. The arguments `wmin` and `wmax` are the minimum (at the start) and maximum (at the end) values to be represented on the axis; `ndiv` is the number of divisions. The options, given by the “`chopt`” string are the following:

- `chopt = 'G'`: logarithmic scale, default is linear.
- `chopt = 'B'`: Blank axis (it is useful to superpose the axis).

Instead of the `wmin,wmax` arguments of the normal constructor, i.e. the limits of the axis, the name of a `TF1` function can be specified. This function will be used to map the user coordinates to the axis values and ticks.

The constructor is the following:

```
TGaxis(Double_t xmin, Double_t ymin, Double_t xmax, Double_t ymax,
       const char* funcname, Int_t ndiv=510,
       Option_t* chopt, Double_t gridlength=0)
```

In such a way, it is possible to obtain exponential evolution of the tick marks position, or even decreasing. In fact, anything you like.

### 9.5.6 Orientation of Tick Marks on Axis

Tick marks are normally drawn on the positive side of the axis, however, if `xmin = xmax`, then negative.

- `chopt = '+'`: tick marks are drawn on Positive side. (Default)
- `chopt = '-'`: tick marks are drawn on the negative side.
- `chopt = '+-'`: tick marks are drawn on both sides of the axis.
- `chopt = 'U'`: unlabeled axis, default is labeled.

## 9.5.7 Labels

### 9.5.7.1 Position

Labels are normally drawn on side opposite to tick marks. However, `chopt = '='` on Equal side. The function `TAxis::CenterLabels()` sets the bit `kCenterLabels` and it is visible from `TAxis` context menu. It centers the bin labels and it makes sense only when the number of bins is equal to the number of tick marks. The class responsible for drawing the axis `TGaxis` inherits this property.

### 9.5.7.2 Orientation

Labels are normally drawn parallel to the axis. However, if `xmin = xmax`, then they are drawn orthogonal, and if `ymin=ymax` they are drawn parallel.

### 9.5.7.3 Labels for Exponents

By default, an exponent of the form  $10^N$  is used when the label values are either all very small or very large. One can disable the exponent by calling:

```
TAxis::SetNoExponent(kTRUE)
```

Note that this option is implicitly selected if the number of digits to draw a label is less than the `fgMaxDigits` global member. If the property `SetNoExponent` was set in `TAxis` (via `TAxis::SetNoExponent`), the `TGaxis` will inherit this property. `TGaxis` is the class responsible for drawing the axis. The method `SetNoExponent` is also available from the axis context menu.

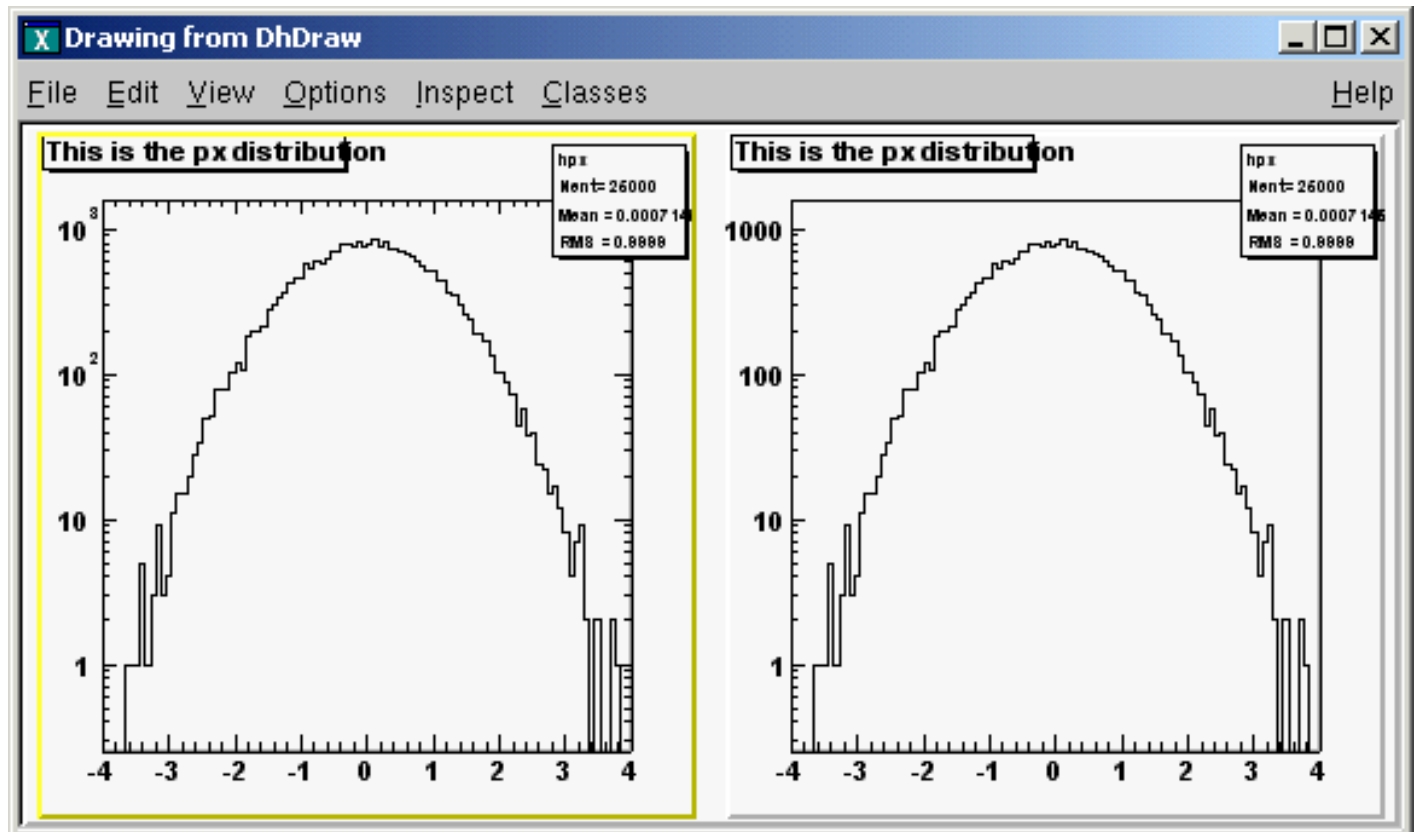

Figure 9.23: Y-axis with and without exponent labels

#### 9.5.7.4 Number of Digits in Labels

`TGaxis::fgMaxDigits` is the maximum number of digits permitted for the axis labels above which the notation with  $10^N$  is used. It must be greater than 0. By default `fgMaxDigits` is 5 and to change it use the `TGaxis::SetMaxDigits` method. For example to set `fgMaxDigits` to accept 6 digits and accept numbers like 900000 on an axis call:

```
TGaxis::SetMaxDigits(6)
```

#### 9.5.7.5 Tick Mark Positions

Labels are centered on tick marks. However, if `xmin = xmax`, then they are right adjusted.

- `chopt = 'R'`: labels are right adjusted on tick mark (default is centered)
- `chopt = 'L'`: labels are left adjusted on tick mark.
- `chopt = 'C'`: labels are centered on tick mark.
- `chopt = 'M'`: In the Middle of the divisions.

#### 9.5.7.6 Label Formatting

Blank characters are stripped, and then the label is correctly aligned. The dot, if last character of the string, is also stripped. In the following, we have some parameters, like tick marks length and characters height (in percentage of the length of the axis, in user coordinates). The default values are as follows:

- Primary tick marks: 3.0 %
- Secondary tick marks: 1.5 %
- Third order tick marks: .75 %
- Characters height for labels: 4%
- Labels offset: 1.0 %

#### 9.5.7.7 Stripping Decimals

Use the `TStyle::SetStripDecimals` to strip decimals when drawing axis labels. By default, the option is set to true, and `TGaxis::PaintAxis` removes trailing zeros after the dot in the axis labels, e.g. {0, 0.5, 1, 1.5, 2, 2.5, etc.}

```
TStyle::SetStripDecimals (Bool_t strip=kTRUE)
```

If this function is called with `strip=kFALSE`, `TGaxis::PaintAxis()` will draw labels with the same number of digits after the dot, e.g. {0.0, 0.5, 1.0, 1.5, 2.0, 2.5, etc.}

#### 9.5.7.8 Optional Grid

`chopt = 'W'`: cross-Wire

#### 9.5.7.9 Axis Binning Optimization

By default, the axis binning is optimized.

- `chopt = 'N'`: No binning optimization
- `chopt = 'I'`: Integer labeling

## 9.5.8 Axis with Time Units

Histograms' axis can be defined as "time axis". To do that it is enough to activate the `SetTimeDisplay` attribute on a given axis. If `h` is a histogram, it is done the following way:

```
h->GetXaxis()->SetTimeDisplay(1);    // X axis is a time axis
```

Two parameters can be adjusted in order to define time axis: the time format and the time offset.

### 9.5.8.1 Time Format

It defines the format of the labels along the time axis. It can be changed using the **TAxis** method `SetTimeFormat`. The time format is the one used by the C function `strftime()`. It is a string containing the following formatting characters:

---

For the date:	%a abbreviated weekday name
	%b abbreviated month name
	%d day of the month (01-31)
	%m month (01-12)
	%y year without century
	%Y year with century
For the time:	%H hour (24-hour clock)
	%I hour (12-hour clock)
	%p local equivalent of AM or PM
	%M minute (00-59)
	%S seconds (00-61)
	%% %

---

The other characters are output as is. For example to have a format like `dd/mm/yyyy` one should do:

```
h->GetXaxis()->SetTimeFormat("%d/%m/%Y");
```

If the time format is not defined, a default one will be computed automatically.

### 9.5.8.2 Time Offset

This is a time in seconds in the UNIX standard UTC format (the universal time, not the local one), defining the starting date of a histogram axis. This date should be greater than 01/01/95 and is given in seconds. There are three ways to define the time offset:

1- By setting the global default time offset:

```
TDate da(2003,02,28,12,00,00);
gStyle->SetTimeOffset(da.Convert());
```

If no time offset is defined for a particular axis, the default time offset will be used. In the example above, notice the usage of `TDate` to translate an explicit date into the time in seconds required by `SetTimeFormat`.

2- By setting a time offset to a particular axis:

```
TDate dh(2001,09,23,15,00,00);
h->GetXaxis()->SetTimeOffset(dh.Convert());
```

3- Together with the time format using `SetTimeFormat`. The time offset can be specified using the control character `%F` after the normal time format. `%F` is followed by the date in the format: `yyyy-mm-dd hh:mm:ss`.



```
h->GetXaxis()->SetTimeFormat("%d/%m/%y%F2000-02-28 13:00:01");
```

Notice that this date format is the same used by the `TDatetime` function `AsSQLString`. If needed, this function can be used to translate a time in seconds into a character string which can be appended after `%F`. If the time format is not specified (before `%F`) the automatic one will be used. The following example illustrates the various possibilities.

```
{
  gStyle->SetTitleH(0.08);
  TDatetime da(2003,02,28,12,00,00);
  gStyle->SetTimeOffset(da.Convert());
  ct = new TCanvas("ct","Time on axis",0,0,600,600);
  ct->Divide(1,3);
  ht1 = new TH1F("ht1","ht1",30000,0.,200000.);
  ht2 = new TH1F("ht2","ht2",30000,0.,200000.);
  ht3 = new TH1F("ht3","ht3",30000,0.,200000.);
  for (Int_t i=1;i<30000;i++) {
    Float_t noise = gRandom->Gaus(0,120);
    ht1->SetBinContent(i,noise);
    ht2->SetBinContent(i,noise*noise);
    ht3->SetBinContent(i,noise*noise*noise);
  }
  ct->cd(1);
  ht1->GetXaxis()->SetLabelSize(0.06);
  ht1->GetXaxis()->SetTimeDisplay(1);
  ht1->GetXaxis()->SetTimeFormat("%d/%m/%y%F2000-02-2813:00:01");
  ht1->Draw();
  ct->cd(2);
  ht2->GetXaxis()->SetLabelSize(0.06);
  ht2->GetXaxis()->SetTimeDisplay(1);
  ht2->GetXaxis()->SetTimeFormat("%d/%m/%y");
  ht2->Draw();
  ct->cd(3);
  ht3->GetXaxis()->SetLabelSize(0.06);
  TDatetime dh(2001,09,23,15,00,00);
  ht3->GetXaxis()->SetTimeDisplay(1);
  ht3->GetXaxis()->SetTimeOffset(dh.Convert());
  ht3->Draw();
}
```

The output is shown in the figure below. If a time axis has no specified time offset, the global time offset will be stored in the axis data structure. The histogram limits are in seconds. If `wmin` and `wmax` are the histogram limits, the time axis will spread around the time offset value from `TimeOffset+wmin` to `TimeOffset+wmax`. Until now all examples had a lowest value equal to 0. The following example demonstrates how to define the histogram limits relatively to the time offset value.

```
{
  // Define the time offset as 2003, January 1st
  TDatetime T0(2003,01,01,00,00,00);
  int X0 = T0.Convert();
  gStyle->SetTimeOffset(X0);

  // Define the lowest histogram limit as 2002,September 23rd
  TDatetime T1(2002,09,23,00,00,00);
  int X1 = T1.Convert()-X0;

  // Define the highest histogram limit as 2003, March 7th
  TDatetime T2(2003,03,07,00,00,00);
  int X2 = T2.Convert(1)-X0;
```

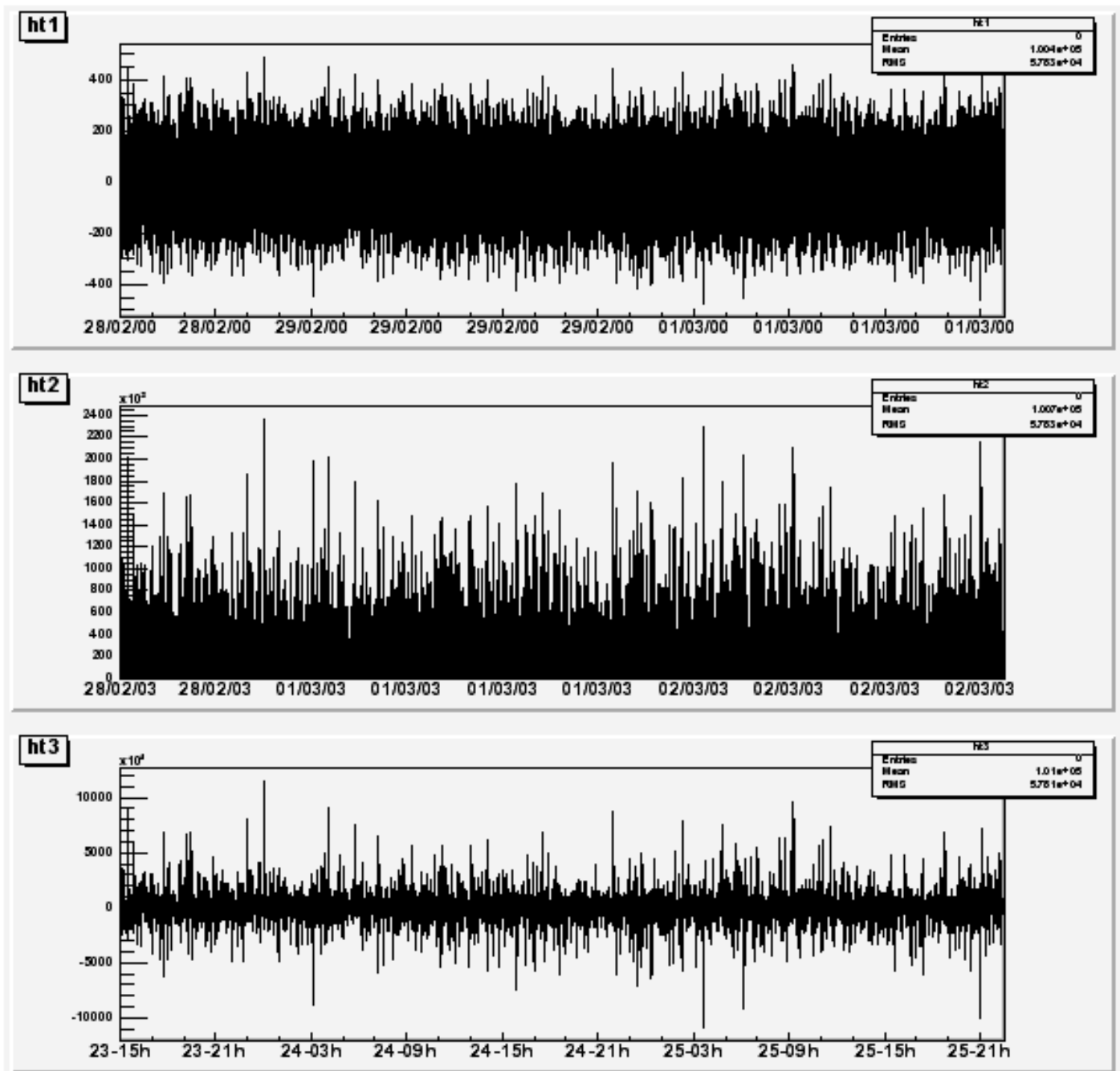

Figure 9.24: Time axis examples

```

TH1F * h1 = new TH1F("h1","test",100,X1,X2);

TRandom r;
for (Int_t i=0;i<30000;i++) {
  Double_t noise = r.Gaus(0.5*(X1+X2),0.1*(X2-X1));
  h1->Fill(noise);
}

h1->GetXaxis()->SetTimeDisplay(1);
h1->GetXaxis()->SetLabelSize(0.03);
h1->GetXaxis()->SetTimeFormat("%Y/%m/%d");
h1->Draw();
}

```

The output is shown in the next figure. Usually time axes are created automatically via histograms, but one may also want to draw a time axis outside a “histogram context”. Therefore, it is useful to understand how **TGaxis** works for such axis. The time offset can be defined using one of the three methods described before. The time axis will spread around the time offset value. Actually, it will go from `TimeOffset+wmin` to `TimeOffset+wmax` where `wmin` and `wmax` are the minimum and maximum values (in seconds) of the axis. Let us take again an example. Having defined “2003, February 28 at 12h”, we would like to see the axis a day before and a day after.

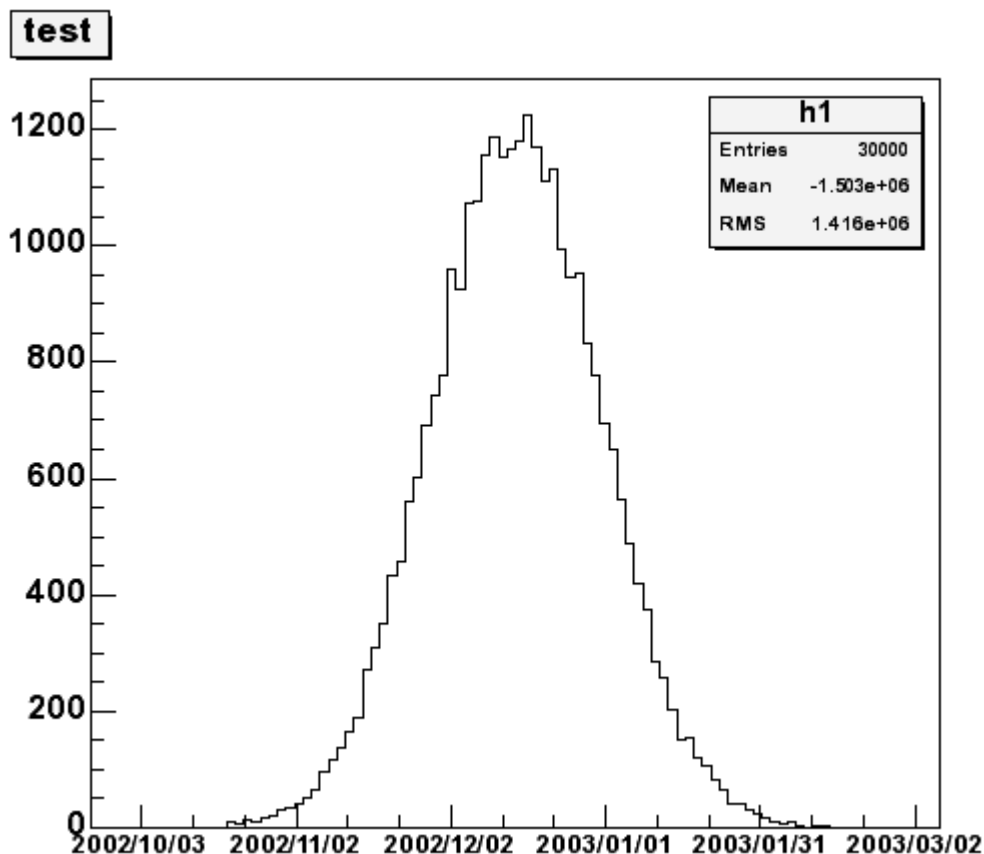

Figure 9.25: A histogram with time axis X

A **TGaxis** can be created the following way (a day has 86400 seconds):

```
TGaxis *axis = new TGaxis(x1,y1,x2,y2,-100000,150000,2405,"t");
```

the “t” option (in lower case) means it is a “time axis”. The axis goes from 100000 seconds before `TimeOffset` and 150000 seconds after. So the complete macro is:

```
{
  c1 = new TCanvas("c1","Examples of TGaxis",10,10,700,500);
  c1->Range(-10,-1,10,1);
  TGaxis *axis = new TGaxis(-8,-0.6,8,-0.6,-100000,150000,2405,"t");
  axis->SetLabelSize(0.03);

  TDateTime da(2003,02,28,12,00,00);
  axis->SetTimeOffset(da.Convert());
  axis->SetTimeFormat("%d/%m/%Y");
  axis->Draw();
}
```

The time format is specified with:

```
axis->SetTimeFormat("%d/%m/%Y");
```

The macro gives the following output:

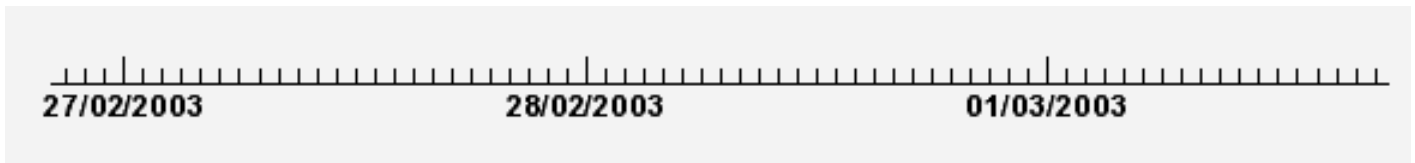

Thanks to the `TLatex` directive `#splitline` it is possible to write the time labels on two lines. In the previous example changing the `SetTimeFormat` line by:

```
axis->SetLabelOffset(0.02);
axis->SetTimeFormat("#splitline{%Y}{-%d/%m}");
```

will produce the following axis:



### 9.5.9 Axis Examples

To illustrate what was said, we provide two scripts. The first one creates the picture shown in the next figure.

The first script is:

```
{
  c1 = new TCanvas("c1","Examples of Gaxis",10,10,700,500);
  c1->Range(-10,-1,10,1);

  TGaxis *axis1 = new TGaxis(-4.5,-0.2,5.5,-0.2,-6,8,510,"");
  axis1->SetName("axis1");
  axis1->Draw();
  TGaxis *axis2 = new TGaxis(4.5,0.2,5.5,0.2,0.001,10000,510,"G");
  axis2->SetName("axis2");
  axis2->Draw();

  TGaxis *axis3 = new TGaxis(-9,-0.8,-9,0.8,-8,8,50510,"");
  axis3->SetName("axis3");
}
```

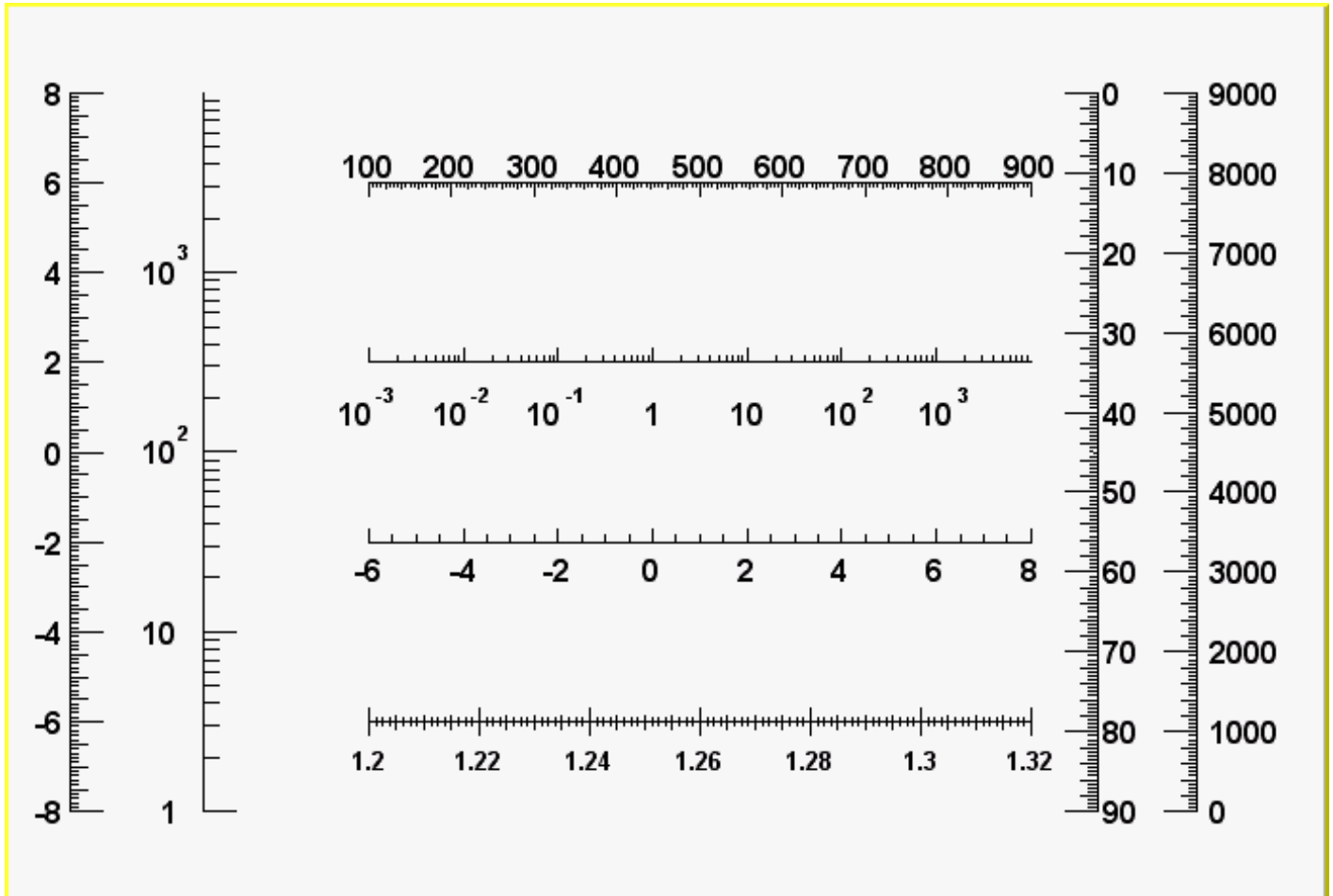

Figure 9.26: The first axis example

```

axis3->Draw();
TGaxis *axis4 = new TGaxis(-7,-0.8,7,0.8,1,10000,50510,"G");
axis4->SetName("axis4");
axis4->Draw();

TGaxis *axis5 = new TGaxis(-4.5,-6,5.5,-6,1.2,1.32,80506,"-+");
axis5->SetName("axis5");
axis5->SetLabelSize(0.03);
axis5->SetTextFont(72);
axis5->SetLabelOffset(0.025);
axis5->Draw();

TGaxis *axis6 = new TGaxis(-4.5,0.6,5.5,0.6,100,900,50510,"-");
axis6->SetName("axis6");
axis6->Draw();
TGaxis *axis7 = new TGaxis(8,-0.8,8,0.8,0,9000,50510,"+L");
axis7->SetName("axis7");
axis7->SetLabelOffset(0.01);
axis7->Draw();

// one can make axis top->bottom. However because of a problem,
// the two x values should not be equal
TGaxis *axis8 = new TGaxis(6.5,0.8,6.499,-0.8,0,90,50510,"-");
axis8->SetName("axis8");
axis8->Draw();
}

```

The second example shows the use of the second form of the constructor, with axis ticks position determined by a function TF1:

```

void gaxis3a()
{
  gStyle->SetOptStat(0);

  TH2F *h2 = new TH2F("h","Axes",2,0,10,2,-2,2);
  h2->Draw();
  TF1 *f1=new TF1("f1","-x",-10,10);
  TGaxis *A1 = new TGaxis(0,2,10,2,"f1",510,"-");
  A1->SetTitle("axis with decreasing values");
  A1->Draw();

  TF1 *f2=new TF1("f2","exp(x)",0,2);
  TGaxis *A2 = new TGaxis(1,1,9,1,"f2");
  A2->SetTitle("exponential axis");
  A2->SetLabelSize(0.03);
  A2->SetTitleSize(0.03);
  A2->SetTitleOffset(1.2);
  A2->Draw();

  TF1 *f3=new TF1("f3","log10(x)",0,800);
  TGaxis *A3 = new TGaxis(2,-2,2,0,"f3",505);
  A3->SetTitle("logarithmic axis");
  A3->SetLabelSize(0.03);
  A3->SetTitleSize(0.03);
  A3->SetTitleOffset(1.2);
  A3->Draw();
}

```

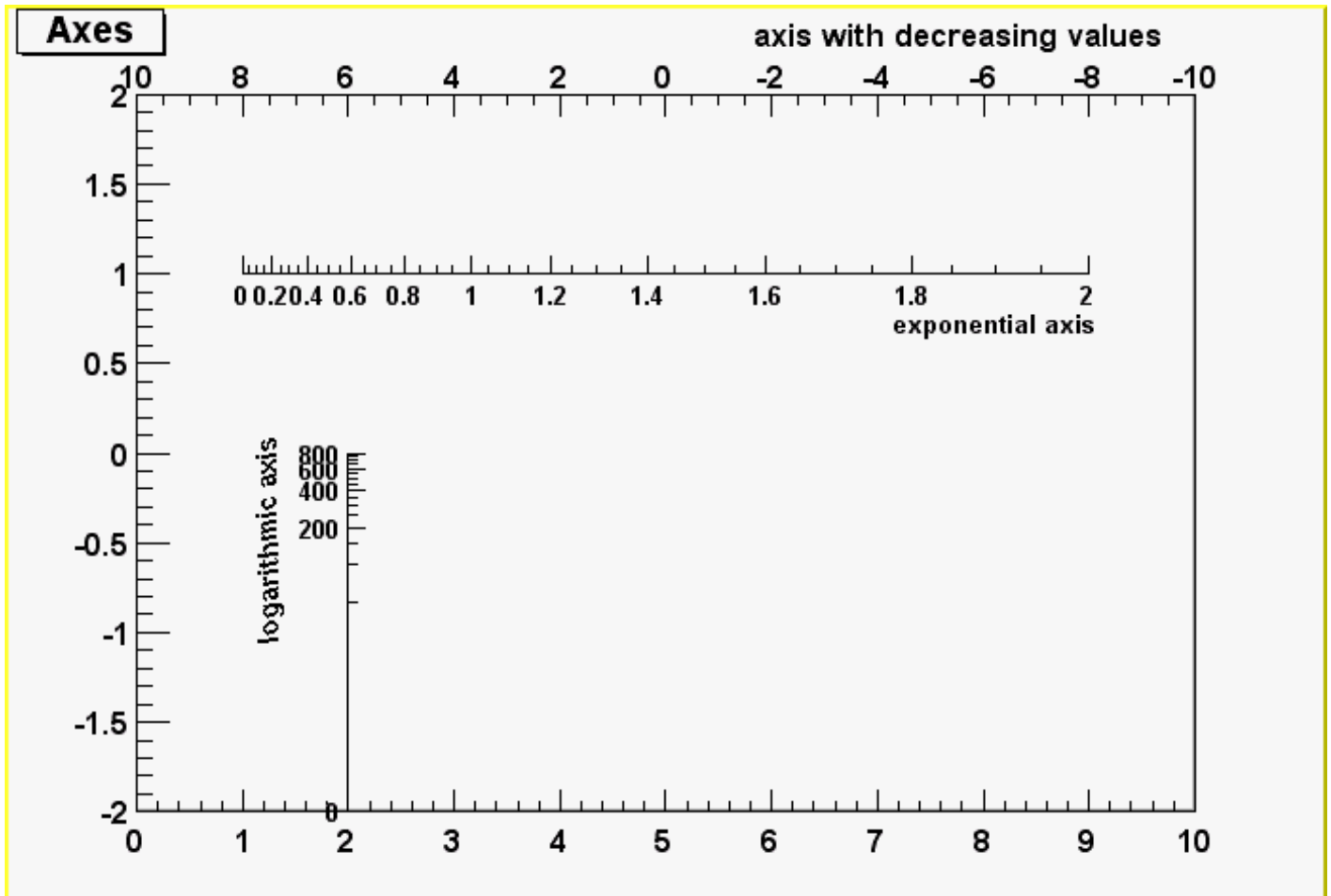

Figure 9.27: The second axis example

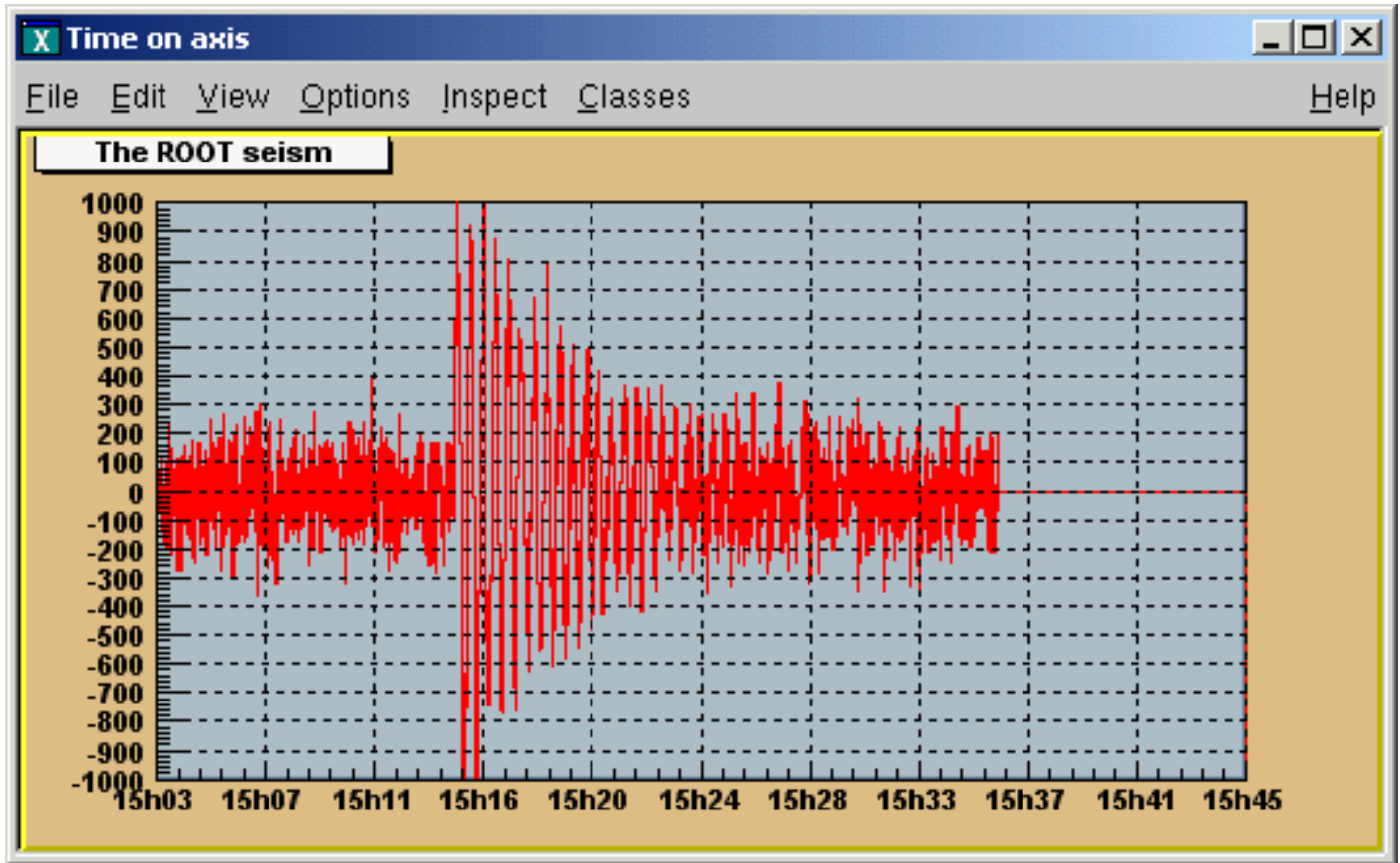

Figure 9.28: An axis example with time display

```

// strip chart example
void seism() {

    TStopwatch sw; sw.Start();
    //set time offset
    TDateTime dt;
    gStyle->SetTimeOffset(dt.Convert());
    TCanvas *c1 = new TCanvas("c1","Time on axis",10,10,1000,500);
    c1->SetFillColor(42);
    c1->SetFrameFillColor(33);
    c1->SetGrid();

    Float_t bintime = 1;
    // one bin = 1 second. change it to set the time scale
    TH1F *ht = new TH1F("ht","The ROOT seism",10,0,10*bintime);
    Float_t signal = 1000;
    ht->SetMaximum(signal);
    ht->SetMinimum(-signal);
    ht->SetStats(0);
    ht->SetLineColor(2);
    ht->GetXaxis()->SetTimeDisplay(1);
    ht->GetYaxis()->SetNdivisions(520);
    ht->Draw();

    for (Int_t i=1;i<2300;i++) {
        // Build a signal : noisy damped sine
        Float_t noise = gRandom->Gaus(0,120);
        if (i > 700)

```



```

    noise += signal*sin((i-700.)*6.28/30)*exp((700.-i)/300.);
    ht->SetBinContent(i,noise);
    c1->Modified();
    c1->Update();
    gSystem->ProcessEvents();
    //canvas can be edited during the loop
}
printf("Real Time = %8.3fs,Cpu Time = %8.3fsn",sw.RealTime(),
       sw.CpuTime());
}

```

## 9.6 Graphical Objects Attributes

### 9.6.1 Text Attributes

When a class contains text or derives from a text class, it needs to be able to set text attributes like font type, size, and color. To do so, the class inherits from the **TAttText** class (a secondary inheritance), which defines text attributes. **TLatex** and **TText** inherit from **TAttText**.

#### 9.6.1.1 Setting Text Alignment

Text alignment may be set by a method call. What is said here applies to all objects deriving from **TAttText**, and there are many. We will take an example that may be transposed to other types. Suppose “**la**” is a **TLatex** object. The alignment is set with:

```
root[] la->SetTextAlign(align)
```

The parameter **align** is a short describing the alignment:

```
align = 10*HorizontalAlign + VerticalAlign
```

For horizontal alignment, the following convention applies:

- 1 = left
- 2 = centered
- 3 = right

For vertical alignment, the following convention applies:

- 1 = bottom
- 2 = centered
- 3 = top

For example, align: 11 = left adjusted and bottom adjusted; 32 = right adjusted and vertically centered.

#### 9.6.1.2 Setting Text Angle

Use **TAttText::SetTextAngle** to set the text angle. The **angle** is the degrees of the horizontal.

```
root[] la->SetTextAngle(angle)
```

### 9.6.1.3 Setting Text Color

Use `TAttText::SetTextColor` to set the text color. The `color` is the color index. The colors are described in “Color and Color Palettes”.

```
root[] la->SetTextColor(color)
```

### 9.6.1.4 Setting Text Font

Use `TAttText::SetFont` to set the font. The parameter `font` is the font code, combining the font and precision: `font = 10 * fontID + precision`

```
root[] la->SetFont(font)
```

The table below lists the available fonts. The font IDs must be between 1 and 14. The precision can be:

- Precision = 0 fast hardware fonts (steps in the size)
- Precision = 1 scalable and rotate-able hardware fonts (see below)
- Precision = 2 scalable and rotate-able hardware fonts

When precision 0 is used, only the original non-scaled system fonts are used. The fonts have a minimum (4) and maximum (37) size in pixels. These fonts are fast and are of good quality. Their size varies with large steps and they cannot be rotated. Precision 1 and 2 fonts have a different behavior depending if True Type Fonts (TTF) are used or not. If TTF are used, you always get very good quality scalable and rotate-able fonts. However, TTF are slow. Precision 1 and 2 fonts have a different behavior for PostScript in case of **TLatex** objects:

- With precision 1, the PostScript text uses the old convention (see **TPostScript**) for some special characters to draw sub and superscripts or Greek text.
- With precision 2, the “PostScript” special characters are drawn as such. To draw sub and superscripts it is highly recommended to use **TLatex** objects instead.

For example: `font = 62` is the font with ID 6 and precision 2.

The available fonts are:

Font ID	X11	True Type name	Is italic	“boldness”
1	times-medium-i-normal	“Times New Roman”	Yes	4
2	times-bold-r-normal	“Times New Roman”	No	7
3	times-bold-i-normal	“Times New Roman”	Yes	7
4	helvetica-medium-r-normal	“Arial”	No	4
5	helvetica-medium-o-normal	“Arial”	Yes	4
6	helvetica-bold-r-normal	“Arial”	No	7
7	helvetica-bold-o-normal	“Arial”	Yes	7
8	courier-medium-r-normal	“Courier New”	No	4
9	courier-medium-o-normal	“Courier New”	Yes	4
10	courier-bold-r-normal	“Courier New”	No	7
11	courier-bold-o-normal	“Courier New”	Yes	7
12	symbol-medium-r-normal	“Symbol”	No	6
13	times-medium-r-normal	“Times New Roman”	No	4
14		“Wingdings”	No	4

ID 1 : *The quick brown fox is not here anymore*  
ID 2 : **The quick brown fox is not here anymore**  
ID 3 : *The quick brown fox is not here anymore*  
ID 4 : The quick brown fox is not here anymore  
ID 5 : *The quick brown fox is not here anymore*  
ID 6 : **The quick brown fox is not here anymore**  
ID 7 : *The quick brown fox is not here anymore*  
ID 8 : The quick brown fox is not here anymore  
ID 9 : *The quick brown fox is not here anymore*  
ID 10 : **The quick brown fox is not here anymore**  
ID 11 : *The quick brown fox is not here anymore*  
ID 12 : Τηρ θυικκ βρωων φοξ ισ νοτ ηερρ ανψμορε  
ID 13 : The quick brown fox is not here anymore  
ID 14 : **The quick brown fox is not here anymore**

Figure 9.29: Font's examples

This script makes the image of the different fonts:

```
{
  textc = new TCanvas("textc","Example of text",1);
  for (int i=1;i<15;i++) {
    cid = new char[8];
    sprintf(cid,"ID %d :",i);
    cid[7] = 0;
    lid = new TLatex(0.1,1-(double)i/15,cid);
    lid->SetTextFont(62);
    lid->Draw();
    l = new TLatex(.2,1-(double)i/15,
                  "The quick brown fox is not here anymore")
    l->SetTextFont(i*10+2);
    l->Draw();
  }
}
```

### 9.6.1.5 How to use True Type Fonts

You can activate the True Type Fonts by adding the following line in your `.rootrc` file.

```
Unix.*.Root.UseTTFonts:    true
```

You can check that you indeed use the TTF in your Root session. When the TTF is active, you get the following message at the start of a session: “Free Type Engine v1.x used to render TrueType fonts.” You can also check with the command:

```
gEnv->Print()
```

### 9.6.1.6 Setting Text Size

Use `TAttText::SetTextSize` to set the text size.

```
root[] la->SetTextSize(size)
```

The `size` is the text size expressed in percentage of the current pad size.

The text size in pixels will be:

- If current pad is horizontal, the size in pixels = `textsize * canvas_height`
- If current pad is vertical, the size in pixels = `textsize * canvas_width`

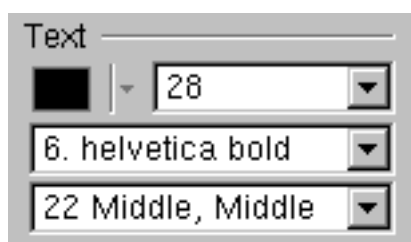

The user interface for changing the text color, size, font and allignment looks like shown in this picture. It takes place in the editor frame anytime the selected object inherits the class `TAttText`.

## 9.6.2 Line Attributes

All classes manipulating lines have to deal with line attributes: color, style and width. This is done by using secondary inheritance of the class **TAttLine**. The line color may be set by a method call. What is said here applies to all objects deriving from **TAttLine**, and there are many (histograms, plots). We will take an example that may be transposed to other types. Suppose “li” is a **TLine** object. The line color is set with:

```
root [] li->SetLineColor(color)
```

The argument `color` is a color number. The colors are described in “Color and Color Palettes”

The line style may be set by a method call. What is said here applies to all objects deriving from **TAttLine**, and there are many (histograms, plots). We will take an example that may be transposed to other types. Suppose “li” is a **TLine** object. The line style is set with:

```
root [] li->SetLineStyle(style)
```

The argument `style` is one of: 1=solid, 2=dash, 3=dot, 4=dash-dot.

The line width may be set by a method call. What is said here applies to all objects deriving from **TAttLine**, and there are many (histograms, plots). We will take an example that may be transposed to other types. Suppose “li” is a **TLine** object. The line width is set with:

```
root [] li->SetLineWidth(width)
```

The `width` is the width expressed in pixel units.



The user interface for changing the line color, line width and style looks like shown in this picture.

It takes place in the editor frame anytime the selected object inherits the class **TAttLine**.

## 9.6.3 Fill Attributes

Almost all graphics classes have a fill area somewhere. These classes have to deal with fill attributes. This is done by using secondary inheritance of the class **TAttFill**. Fill color may be set by a method call. What is said here applies to all objects deriving from **TAttFill**, and there are many (histograms, plots). We will take an example that may be transposed to other types. Suppose “h” is a **TH1F** (1 dim histogram) object. The histogram fill color is set with:

```
root [] h->SetFillColor(color)
```

The color is a color number. The colors are described in “Color and color palettes”

Fill style may be set by a method call. What is said here applies to all objects deriving from **TAttFill**, and there are many (histograms, plots). We will take an example that may be transposed to other types. Suppose “h” is a **TH1F** (1 dim histogram) object. The histogram fill style is set with:

```
root [] h->SetFillStyle(style)
```

The convention for style is: 0:hollow, 1001:solid, 2001:hatch style, 3000+pattern number:patterns, 4000 to 4100:transparency, 4000:fully transparent, 4100: fully opaque.

Fill styles >3100 and <3999 are hatches. They are defined according to the `FillStyle=3ijk` value as follows:

- `i(1-9)` specifies the space between each hatch (1=minimum space, 9=maximum). The final spacing is set by `SetHatchesSpacing()` method and it is `*GetHatchesSpacing()`.
- `j(0-9)` specifies the angle between 0 and 90 degrees as follows: 0=0, 1=10, 2=20, 3=30, 4=45, 5=not drawn, 6=60, 7=70, 8=80 and 9=90.
- `k(0-9)` specifies the angle between 0 and 90 degrees as follows: 0=180, 1=170, 2=160, 3=150, 4=135, 5=not drawn, 6=120, 7=110, 8=100 and 9=90.

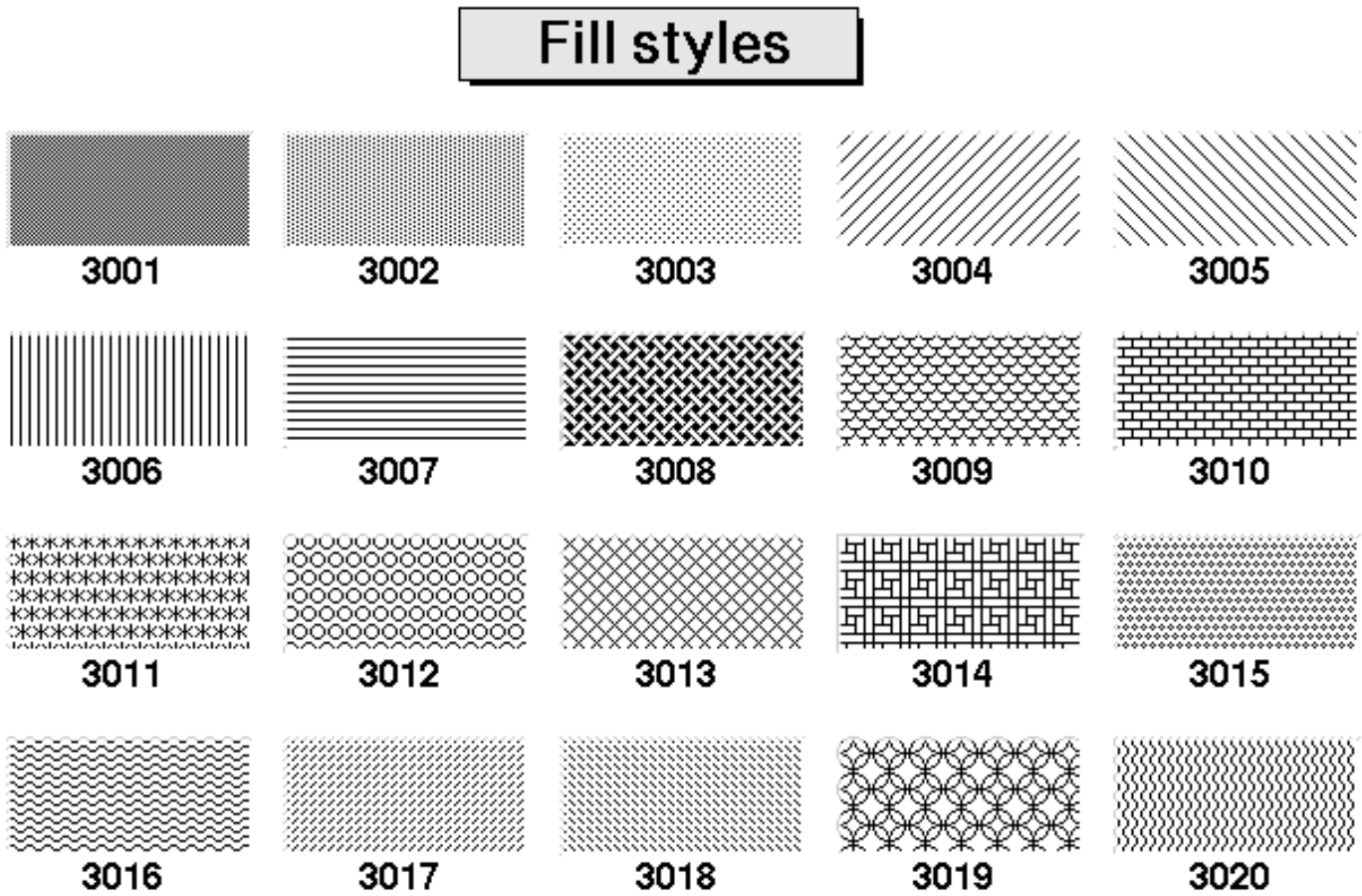

Figure 9.30: The various patterns

### 9.6.4 Color and Color Palettes

At initialization time, a table of basic colors is generated when the first Canvas constructor is called. This table is a linked list, which can be accessed from the *gROOT* object (see `TROOT::GetListOfColors()`). Each color has an index and when a basic color is defined, two “companion” colors are defined:

- the dark version (color index + 100)
- the bright version (color index + 150)

The dark and bright colors are used to give 3-D effects when drawing various boxes (see `TWbox`, `TPave`, `TPaveText`, `TPaveLabel`, etc). If you have a black and white copy of the manual, here are the basic colors and their indices.

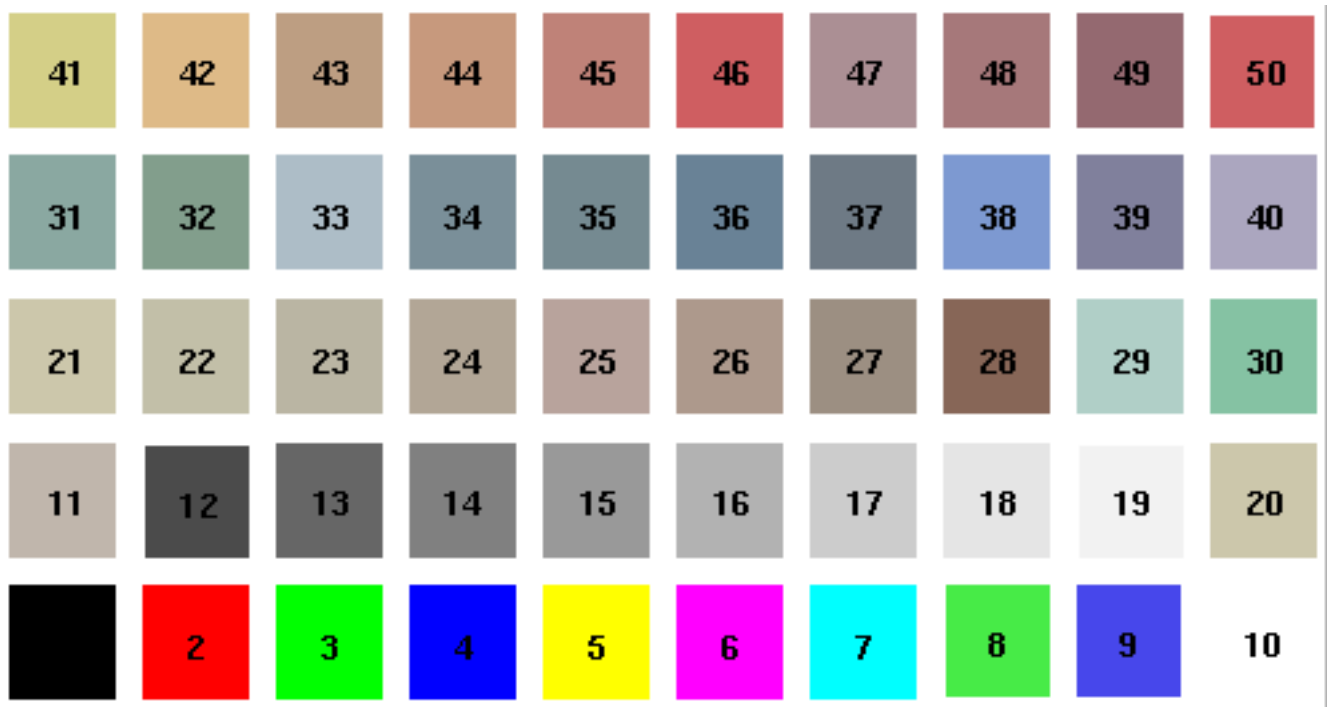

Figure 9.31: The basic ROOT colors

```

1 =black
2 = red
3 = bright green
4 = bright blue
5 = yellow
6 = hot pink
7 = aqua
8 = green
9 = blue
0->9: basic colors
10->19: gray shades
20->29: brown shades
30->39: blue shades
40->49: red shade

```

The list of currently supported basic colors (here dark and bright colors are not shown) are shown. The color numbers specified in the basic palette, and the picture above, can be viewed by selecting the menu entry Colors in the View canvas menu. The user may define other colors. To do this, one has to build a new `TColor`:

```
TColor(Int_t color,Float_t r,Float_t g,Float_t b,const char* name)
```

One has to give the color number and the three Red, Green, Blue values, each being defined from 0 (min) to 1(max). An optional name may be given. When built, this color is automatically added to the existing list of colors. If the color number already exists, one has to extract it from the list and redefine the RGB values. This may be done for example with:

```
root[] color=(TColor*)(gROOT->GetListOfColors()->At(index_color))
root[] color->SetRGB(r,g,b)
```

Where `r`, `g` and `b` go from 0 to 1 and `index_color` is the color number you wish to change.



The user interface for changing the fill color and style looks like shown in this picture. It takes place in the editor frame anytime the selected object inherits the class `TAttFill`.

#### 9.6.4.1 Color Palette (for Histograms)

Defining one color at a time may be tedious. The histogram classes (see Draw Options) use the color palette. For example, `TH1::Draw("col")` draws a 2-D histogram with cells represented by a box filled with a color `CI` function of the cell content. If the cell content is `N`, the color `CI` used will be the color number in `colors[N]`. If the maximum cell content is `>ncolors`, all cell contents are scaled to `ncolors`. The current color palette does not have a class or global object of its own. It is defined in the current style as an array of color numbers. The current palette can be changed with:

```
TStyle::SetPalette(Int_t ncolors,Int_t*color_indexes).
```

By default, or if `ncolors <= 0`, a default palette (see above) of 50 colors is defined. The colors defined in this palette are good for coloring pads, labels, and other graphic objects. If `ncolors > 0` and `colors = 0`, the default palette is used with a maximum of `ncolors`. If `ncolors == 1 && colors == 0`, then a pretty palette with a spectrum `Violet->Red` is created. It is recommended to use this pretty palette when drawing lego(s), surfaces or contours. For example, to set the current palette to the “pretty” one, do:

```
root[] gStyle->SetPalette(1)
```

A more complete example is shown below. It illustrates the definition of a custom palette. You can adapt it to suit your needs. In case you use it for contour coloring, with the current color/contour algorithm, always define two more colors than the number of contours.

```
void palette() {
    // Example of creating new colors (purples)
    const Int_t colNum = 10;    // and defining of a new palette
    Int_t palette[colNum];
    for (Int_t i=0; i<colNum; i++) {
        // get the color and if it does not exist create it
        if (! gROOT->GetColor(230+i) ){
            TColor *color =
                new TColor(230+i,1-(i/((colNum)*1.0)),0.3,0.5,"");
        } else {
            TColor *color = gROOT->GetColor(230+i);
            color->SetRGB(1-(i/((colNum)*1.0)),0.3,0.5);
        }
        palette[i] = 230+i;
    }
    gStyle->SetPalette(colNum,palette);
    TF2 *f2 = new TF2("f2","exp(-(x^2)-(y^2))",-3,3,-3,3);
    // two contours less than the number of colors in palette
    f2->SetContour(colNum-2);
    f2->Draw("cont");
}
```



## 9.7 The Graphics Editor

A new graphics editor took place in ROOT v4.0. The editor can be activated by selecting the Editor menu entry in the canvas View menu or one of the context menu entries for setting line, fill, marker or text attributes. The following object editors are available for the current ROOT version.

### 9.7.1 TAxisEditor

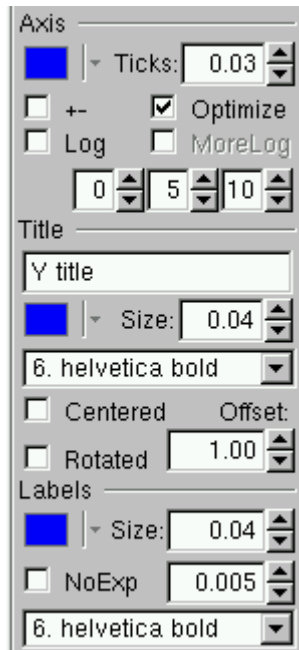

This user interface gives the possibility for changing the following axis attributes:

- color of the selected axis, the axis' title and labels;
- the length of tick parameters and the possibility to set them on both axis sides (if +- is selected);
- to set logarithmic or linear scale along the selected axis with a choice for optimized or more logarithmic labels;
- primary, secondary and tertiary axis divisions can be set via the three number fields;
- the axis title can be added or edited and the title's color, position, offset, size and font can be set interactively;
- the color, size, and offset of axis labels can be set similarly. In addition, there is a check box for no exponent choice, and another one for setting the same decimal part for all labels.

### 9.7.2 TPadEditor

- It provides the following user interface:
- Fixed aspect ratio - can be set for pad resizing.
- Edit - sets pad or canvas as editable.
- Cross-hair - sets a cross hair on the pad.
- TickX - set ticks along the X axis.
- TickY - set ticks along the Y axis.
- GridX - set a grid along the X axis.

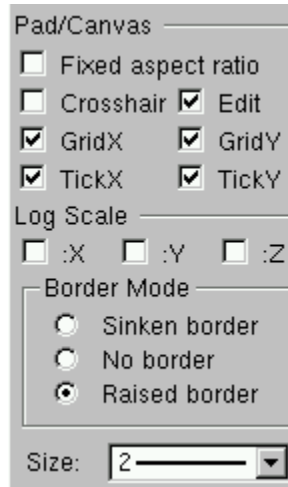

- GridY - set a grid along the Y axis.
- The pad or canvas border size can be set if a sunken or a raised border mode is selected; no border mode can be set too.

## 9.8 Copy and Paste

You can make a copy of a canvas using `TCanvas::DrawClonePad`. This method is unique to `TCanvas`. It clones the entire canvas to the active pad. There is a more general method `TObject::DrawClone`, which all objects descendent of `TObject`, specifically all graphic objects inherit. Below are two examples, one to show the use of `DrawClonePad` and the other to show the use of `DrawClone`.

### 9.8.1 Using the GUI

In this example we will copy an entire canvas to a new one with `DrawClonePad`. Run the script `draw2dopt.C`.

```
root[] .x tutorials/hist/draw2dopt.C
```

This creates a canvas with 2D histograms. To make a copy of the canvas follow the steps:

- Right-click on it to bring up the context menu
- Select `DrawClonePad`

This copies the entire canvas and all its sub-pads to a new canvas. The copied canvas is a deep clone, and all the objects on it are copies and independent of the original objects. For instance, change the fill on one of the original histograms, and the cloned histogram retains its attributes. `DrawClonePad` will copy the canvas to the active pad; the target does not have to be a canvas. It can also be a pad on a canvas.

If you want to copy and paste a graphic object from one canvas or pad to another canvas or pad, you can do so with `DrawClone` method inherited from `TObject`. All graphics objects inherit the `TObject::DrawClone` method. In this example, we create a new canvas with one histogram from each of the canvases from the script `draw2dopt.C`.

- Start a new ROOT session and execute the script `draw2dopt.C`
- Select a canvas displayed by the script, and create a new canvas `c1` from the File menu.
- Make sure that the target canvas (`c1`) is the active one by middle clicking on it. If you do this step right after step 2, `c1` will be active.

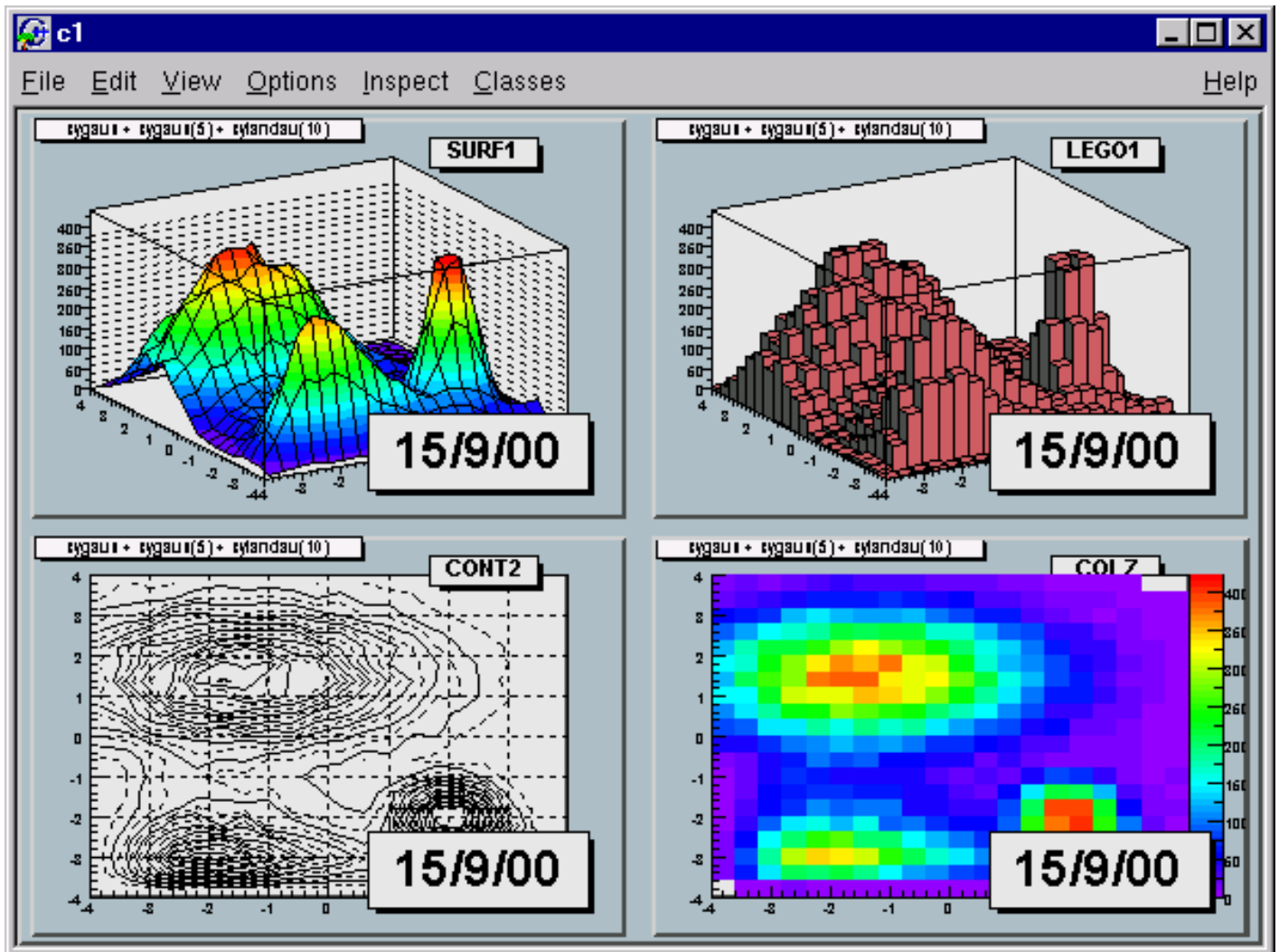

Figure 9.32: Different draw options

- Select the pad with the first histogram you want to copy and paste.
- Right click on it to show the context menu, and select `DrawClone`.
- Leave the option blank and hit OK.

Repeat these steps for one histogram on each of the canvases created by the script, until you have one pad from each type. If you wanted to put the same annotation on each of the sub pads in the new canvas, you could use `DrawClone` to do so. Here we added the date to each pad. The steps to this are:

- Create the label in on of the pads with the graphics editor.
- Middle-click on the target pad to make it the active pad
- Use `DrawClone` method of the label to draw it in each of the other panels.

The option in the `DrawClone` method argument is the Draw option for a histogram or graph. A call to `TH1::DrawClone` can clone the histogram with a different draw option.

## 9.8.2 Programmatically

To copy and paste the four pads from the command line or in a script you would execute the following statements:

```
root[] .x tutorials/hist/draw2dopt.C
root[] TCanvas c1("c1","Copy Paste",200,200,800,600);
root[] surfaces->cd(1); // get the first pad
root[] TPad *p1 = gPad;
root[] lego->cd(2); // get the next pad
root[] TPad *p2 = gPad;
root[] cont->cd(3); // get the next pad
root[] TPad *p3 = gPad;
root[] c2h->cd(4); // get the next pad
root[] TPad *p4 = gPad;
root[] // to draw the four clones
root[] c1->cd();
root[] p1->DrawClone();
root[] p2->DrawClone();
root[] p3->DrawClone();
root[] p4->DrawClone();
```

Note that the pad is copied to the new canvas in the same location as in the old canvas. For example if you were to copy the third pad of `surf` to the top left corner of the target canvas you would have to reset the coordinates of the cloned pad.

## 9.9 Legends

Legends for a graph are obtained with a `TLegend` object. This object points to markers, lines, boxes, histograms, graphs and represent their marker, line, fill attributes. Any object that has a marker or line or fill attribute may have an associated legend. A `TLegend` is a panel with several entries (class `TLegendEntry`) and is created by the constructor

```
TLegend(Double_t x1, Double_t y1, Double_t x2, Double_t y2,
        const char *header, Option_t *option)
```

The legend is defined with default coordinates, border size and option. The legend coordinates (NDC) in the current pad are `x1`, `y1`, `x2`, `y2`. The default text attributes for the legend are:

- Alignment = 12 left adjusted and vertically centered

- Angle = 0 (degrees)
- Color = 1 (black)
- Size = calculate when number of entries is known
- Font = helvetica-medium-r-normal scalable font = 42, and bold = 62 for title

The title is a regular entry and supports **T $\text{L}a\text{T}e\text{x}$** . The default is no title (`header = 0`). The options are the same as for **TPave**; by default, they are “**brand**”. Once the legend box is created, one has to add the text with the `AddEntry()` method:

```
TLegendEntry* TLegend::AddEntry(TObject *obj,
                                const char *label,
                                Option_t *option)
```

The parameters are:

- `*obj` is a pointer to an object having marker, line, or fill attributes (a histogram, or a graph)
- `label` is the label to be associated to the object
- `option`:
- “L” draw line associated with line attributes of `obj`, if `obj` inherits from **TAttLine**.
- “P” draw poly-marker associated with marker attributes of `obj`, if `obj` inherits **TAttMarker**.
- “F” draw a box with fill associated with fill attributes of `obj`, if `obj` inherits **TAttFill**.

One may also use the other form of the method `AddEntry`:

```
TLegendEntry* TLegend::AddEntry(const char *name,
                                const char *label,
                                Option_t *option)
```

Here `name` is the name of the object in the pad. Other parameters are as in the previous case. Next example shows how to create a legend:

```
leg = new TLegend(0.4,0.6,0.89,0.89);
leg->AddEntry(fun1,"One Theory","l");
leg->AddEntry(fun3,"Another Theory","f");
leg->AddEntry(gr,"The Data","p");
leg->Draw();
// oops we forgot the blue line... add it after
leg->AddEntry(fun2,
              "#sqrt{2#pi} P_{T} (#gamma) latex formula","f");
// and add a header (or "title") for the legend
leg->SetHeader("The Legend Title");
leg->Draw();
```

Here `fun1`, `fun2`, `fun3` and `gr` are pre-existing functions and graphs. You can edit the **TLegend** by right clicking on it.

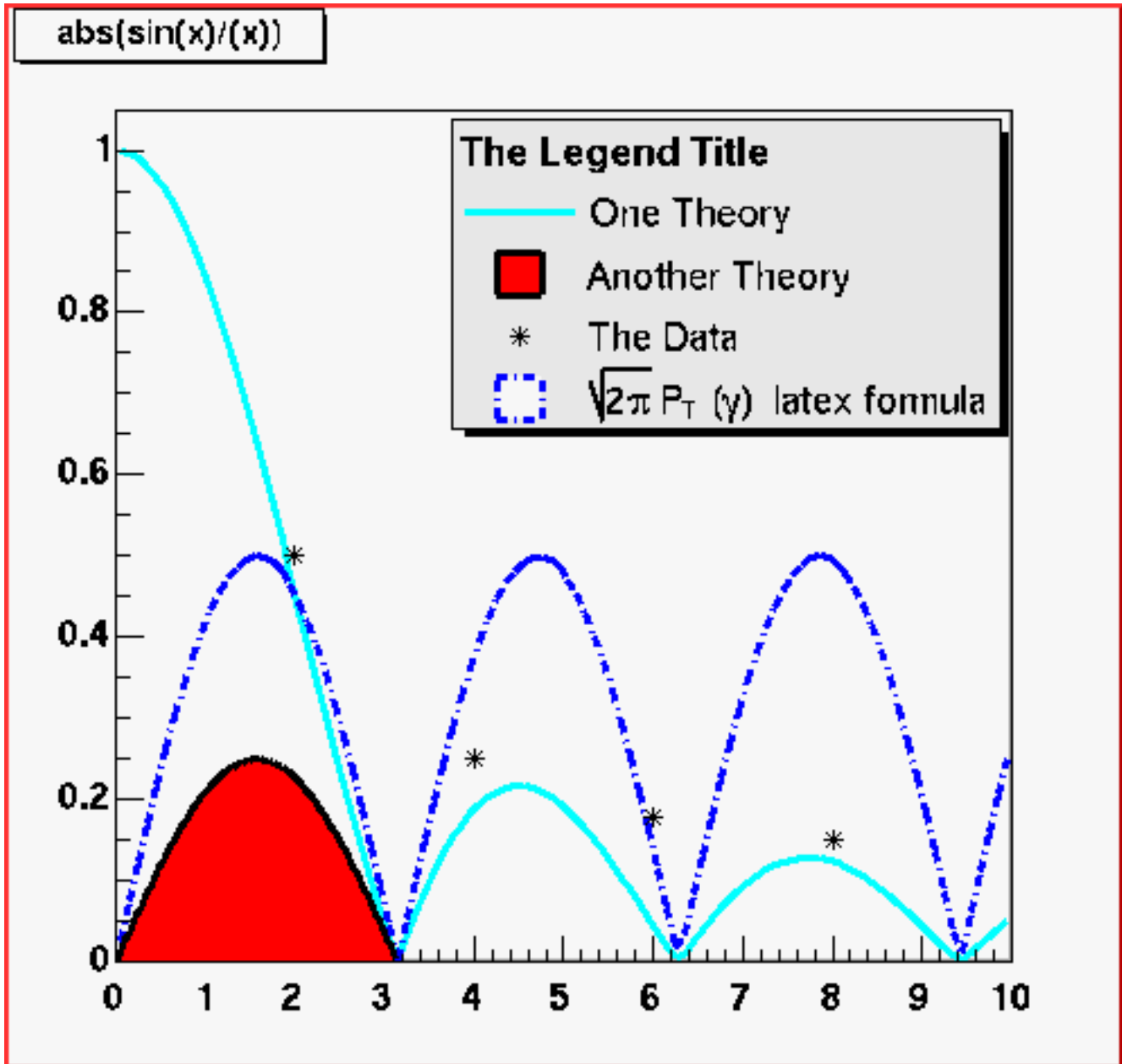

Figure 9.33: A legend example

## 9.10 The PostScript Interface

To generate a PostScript (or encapsulated PostScript) file for a single image in a canvas, you can:

- Select to print the canvas in the PostScript file format from the File menu / Save or Save As menu entries. By default, a PostScript file is generated, if you do not specify the file format.
- Click in the canvas area, near the edges, with the right mouse button and select the Print context menu entry. This will generate a file of canvas pointed to by `c1`. You can select the name of the PostScript file. If the file name is `xxx.ps`, you will generate a PostScript file named `xxx.ps`. If the file name is `xxx.eps`, you generate an encapsulated Postscript file instead. In your program (or script), you can type:

```
c1->Print("xxx.ps") // or
c1->Print("xxx.eps")
```

Next example prints the picture in the pad pointed by `pad1`.

```
pad1->Print("xxx.ps")
```

The `TPad::Print` method has a second parameter called `option`. Its value can be:

- `0` which is the default and is the same as “ps”
- “ps” a Postscript file is produced
- “Portrait” a Postscript file is produced with Portrait orientation
- “Landscape” a Postscript file is produced with Landscape orientation
- “eps” an Encapsulated Postscript file
- “Preview” an Encapsulated Postscript file with preview is produced
- “gif” a Graphics Interchange Format file
- “cxx” a C++ macro file is generated
- “pdf” a Portable Document Format file
- “xml” a eXtensible Mark-up Language file
- “jpg” a Joint Photographic Experts Group file
- “png” a Portable Network Graphics Format (PNG file)
- “xpm” a X11 Pixel Map Format
- “svg” a Scalable Vector Graphics file
- “tiff” a Tagged-Image File Format
- “root” a ROOT binary file is produced

You do not need to specify this second parameter; you can indicate by the filename extension what format you want to save a canvas in (i.e. `canvas.ps`, `canvas.gif`, `canvas.C`, etc).

The size of the PostScript picture, by default, is computed to keep the aspect ratio of the picture on the screen, where the size along `x` is always 20 cm. You can set the size of the PostScript picture before generating the picture with a command such as:

```
TPostScript myps("myfile.ps",111)
mysp.Range(xsize,ysize);
object->Draw();
mysp.Close();
```

The first parameter in the `TPostScript` constructor is the name of the file; the second one is the format option:

- 111 - ps portrait
- 112 - ps landscape
- 113 - eps

You can set the default paper size with:

```
gStyle->SetPaperSize(xsize,ysize);
```

You can resume writing again in this file with `mys.Open()`. Note that you may have several Post Script files opened simultaneously. Use `TPostScript::Text(x,y,"string")` to add text to a postscript file. This method writes the string in quotes into a PostScript file at position `x`, `y` in world coordinates.

### 9.10.1 Special Characters

The following characters have a special action on the PostScript file:

- ‘ - go to Greek
- ’ - go to special
- ~ - go to Zapf Dingbats
- ? - go to subscript
- ^ - go to superscript
- ! - go to normal level of script
- & - backspace one character
- # - end of Greek or end of ZapfDingbats

These special characters are printed as such on the screen. To generate one of these characters on the PostScript file, you must escape it with the escape character “@”. The use of these special characters is illustrated in several scripts referenced by the `TPostScript` constructor.

### 9.10.2 Writing Several Canvases to the Same PostScript File

The following sequence writes the canvas to “c1.ps” and closes the postscript file:

```
TCanvas c1("c1");
h1.Draw();
c1.Print("c1.ps");
```

If the Postscript file name finishes with “(”, the file remains opened (it is not closed). If the Postscript file name finishes with “)” and the file has been opened with “(”, the file is closed.

```
{
  TCanvas c1("c1");
  h1.Draw();
  c1.Print("c1.ps"); // write canvas and keep the ps file open
  h2.Draw();
  c1.Print("c1.ps"); // canvas is added to "c1.ps"
  h3.Draw();
  c1.Print("c1.ps"); // canvas is added to "c1.ps"
                    // and ps file is closed
}
```



The `TCanvas::Print("file.ps(")` mechanism is very useful, but it can be a little inconvenient to have the action of opening/closing a file being atomic with printing a page. Particularly if pages are being generated in some loop, one needs to detect the special cases of first and last page. The “[” and “]” can be used instead of “(” and “)” as shown in the next example.

```
c1.Print("file.ps[");      // no actual print; just open file.ps
for (i=0; i<10; ++i) {
    // fill canvas for context i
    ...
    c1.Print("file.ps");   // actually print canvas to file.ps
} // end loop
c1.Print("file.ps]");     // no actual print; just close file.ps
```

The following script illustrates how to open a postscript file and draw several pictures. The generation of a new postscript page is automatic when `TCanvas::Clear` is called by `object->Draw()`.

```
{
    TFile f("hsimple.root");
    TCanvas c1("c1","canvas",800,600);

    //select PostScript output type
    Int_t type = 111;      //portrait ps
    // Int_t type = 112;   //landscape ps
    // Int_t type = 113;   //eps

    //create a PostScript file and set the paper size
    TPostScript ps("test.ps",type);
    ps.Range(16,24);      //set x,y of printed page

    //draw 3 histograms from file hsimple.root on separate pages
    hpx->Draw();
    c1.Update();          //force drawing in a script
    hprof->Draw();
    c1.Update();
    hpx->Draw("lego1");
    c1.Update();
    ps.Close();
}
```

The next example does the same:

```
{
    TFile f("hsimple.root");
    TCanvas c1("c1","canvas",800,600);

    //set x,y of printed page
    gStyle->SetPaperSize(16,24);

    //draw 3 histograms from file hsimple.root on separate pages
    hpx->Draw();
    c1->Print("test1.ps(", "Portrait");
    hprof->Draw();
    c1->Print("test1.ps");
    hpx->Draw("lego1");
    c1->Print("test1.ps)");
}
```

This following example shows two pages. The canvas is divided. `TPostScript::NewPage` must be called before starting a new picture. `object->Draw` does not clear the canvas in this case because we clear only the pads and not the main canvas. Note that `c1->Update` must be called at the end of the first picture.

```
{
  TFile *f1 = new TFile("hsimple.root");
  TCanvas *c1 = new TCanvas("c1");
  TPostScript *ps = new TPostScript("file.ps",112);

  // picture 1
  c1->Divide(2,1);
  ps->NewPage();
  c1->cd(1);
  hpx->Draw();
  c1->cd(2);
  hprof->Draw();

  // picture 2
  c1->Update();
  ps->NewPage();
  c1->cd(1);
  hpxpy->Draw();
  c1->cd(2);
  ntuple->Draw("px");
  c1->Update();
  ps->Close();

  // invoke PostScript viewer
  gSystem->Exec("gs file.ps");
}
```

The next one does the same:

```
{
  TFile *f1 = new TFile("hsimple.root");
  TCanvas *c1 = new TCanvas("c1");
  c1->Divide(2,1);

  // picture 1
  c1->cd(1);
  hpx->Draw();
  c1->cd(2);
  hprof->Draw();
  c1->Print("test2.ps", "Landscape");

  // picture 2
  c1->cd(1);
  hpxpy->Draw();
  c1->cd(2);
  ntuple->Draw("px");
  c1->Print("test2.ps");
  gSystem->Exec("gs file.ps"); // invoke PostScript viewer
}
```

### 9.10.3 The Color Models

`TPostScript` (and `TPDF`) support two color models: RGB and CMYK. CMY and CMYK models are subtractive color models unlike RGB which is an additive. They are mainly used for printing purposes. CMY means Cyan Magenta Yellow

to convert RGB to CMY it is enough to do:  $C=1-R$ ,  $M=1-G$  and  $Y=1-B$ . CMYK has one more component K (black). The conversion from RGB to CMYK is:

```
Double_t Black   = TMath::Min(TMath::Min(1-Red,1-Green),1-Blue);
Double_t Cyan    = (1-Red-Black)/(1-Black);
Double_t Magenta = (1-Green-Black)/(1-Black);
Double_t Yellow  = (1-Blue-Black)/(1-Black);
```

CMYK add the black component which allows to have a better quality for black printing. TPostScript (and TPDF) support the CMYK model. To change the color model use:

```
gStyle->SetColorModelPS(c);
```

- $c = 0$  means TPostScript will use RGB color model (default)
- $c = 1$  means TPostScript will use CMYK color model

## 9.11 The PDF Interface

Like PostScript, PDF is a vector graphics output format allowing a very high graphics output quality. The functionalities provided by this class are very similar to those provided by TPostScript.

Compare to PostScript output, the PDF files are usually smaller because some parts of them can be compressed.

PDF also allows to define table of contents. This facility can be used in ROOT. The following example shows how to proceed:

```
{
  TCanvas* canvas = new TCanvas("canvas");
  TH1F* histo = new TH1F("histo","test 1",10,0.,10.);
  histo->SetFillColor(2);
  histo->Fill(2.);
  histo->Draw();
  canvas->Print("plots.pdf","Title:One bin filled");
  histo->Fill(4.);
  histo->Draw();
  canvas->Print("plots.pdf","Title:Two bins filled");
  histo->Fill(6.);
  histo->Draw();
  canvas->Print("plots.pdf","Title:Three bins filled");
  histo->Fill(8.);
  histo->Draw();
  canvas->Print("plots.pdf","Title:Four bins filled");
  histo->Fill(8.);
  histo->Draw();
  canvas->Print("plots.pdf","Title:The fourth bin content is 2");
}
```

Each character string following the keyword “Title:” makes a new entry in the table of contents.

## 9.12 Create or Modify a Style

All objects that can be drawn in a pad inherit from one or more attribute classes like **TAttLine**, **TAttFill**, **TAttText**, **TAttMarker**. When objects are created, their default attributes are taken from the current style. The current style is an object of the class **TStyle** and can be referenced via the global variable **gStyle** (in **TStyle.h**). See the class **TStyle** for a complete list of the attributes that can be set in one style.

ROOT provides several styles called:

- “Default” - the default style
- “Plain” - the simple style (black and white)
- “Bold” - bolder lines
- “Video” - suitable for html output or screen viewing

The “Default” style is created by:

```
TStyle *default = new TStyle("Default","Default Style");
```

The “Plain” style can be used if you want to get a “conventional” PostScript output or if you are working on a monochrome display. The following example shows how to create it.

```
TStyle *plain = new TStyle("Plain",
                          "Plain Style(no colors/fill areas)");
plain->SetCanvasBorderMode(0);
plain->SetPadBorderMode(0);
plain->SetPadColor(0);
plain->SetCanvasColor(0);
plain->SetTitleColor(0);
plain->SetStatColor(0);
```

You can set the current style by:

```
gROOT->SetStyle(style_name);
```

You can get a pointer to an existing style by:

```
TStyle *style = gROOT->GetStyle(style_name);
```

You can create additional styles by:

```
TStyle *st1 = new TStyle("st1","my style");
st1->Set...
st1->cd(); // this becomes now the current style gStyle
```

In your `rootlogon.C` file, you can redefine the default parameters via statements like:

```
gStyle->SetStatX(0.7);
gStyle->SetStatW(0.2);
gStyle->SetLabelOffset(1.2);
gStyle->SetLabelFont(72);
```

Note that when an object is created, its attributes are taken from the current style. For example, you may have created a histogram in a previous session and saved it in a file. Meanwhile, if you have changed the style, the histogram will be drawn with the old attributes. You can force the current style attributes to be set when you read an object from a file by calling `ForceStyle` before reading the objects from the file.

```
gROOT->ForceStyle();
```

When you call `gROOT->ForceStyle()` and read an object from a ROOT file, the object’s method `UseCurrentStyle` is called. The attributes saved with the object are replaced by the current style attributes. You can also call `myObject->UseCurrentStyle()` directly. For example if you have a canvas or pad with your histogram or any other object, you can force these objects to get the attributes of the current style by:

```
canvas->UseCurrentStyle();
```

The description of the style functions should be clear from the name of the **TStyle** setters or getters. Some functions have an extended description, in particular:

- **TStyle::SetLabelFont**
- **TStyle::SetLineStyleString**: set the format of dashed lines.
- **TStyle::SetOptStat**
- **TStyle::SetPalette** to change the colors palette
- **TStyle::SetTitleOffset**
- **TStyle::SetOptDate(Int\_t optdate)** to support several date formats. If **optdate** is non-null, the current date/time will be printed in the canvas. The position of the date string can be controlled by: **optdate = 10\*format+mode**
- **mode = 1** the date is printed in the bottom/left corner
- **mode = 2** date is printed in the bottom/right corner
- **mode = 3** date is printed in the top/right corner
- **format = 0** (default) date format is like: “Wed Sep 25 17:10:35 2002”
- **format = 1** date format is: “2002-09-25”
- **format = 2** date format is: “2002-09-25 17:10:35”

## 9.13 3D Viewers

ROOT provides several viewers capable of displaying 3D content:

- the Pad - simple line drawing using **TPad** and associated projection class **TView**;
- GL Viewer - high quality and performance viewer(See “The GL Viewer”);
- X3D viewer - simple legacy viewer (See “The X3D Viewer”);
- GL-in-pad - combination of basic GL viewer in **TPad**, with no hardware acceleration.

The X3D and GL viewers are created as external windows, associated with a pad, and displaying the same content as it. Only these external viewers are detailed here - for Pad (**TPad**, **TView** classes) you should refer to “Graphical Containers: Canvas and Pad” and the class definitions.

All viewers use a common architecture to publish 3D objects to the viewer - described in “Common 3D Viewer Architecture” below. In most cases, you will **not** need to use this, working instead with a package, such as the “The Geometry Package”, which provides comprehensive, high level functionality to create and place objects into complex 3D scenes, and uses the viewer architecture internally to show the result in your chosen viewer.

### 9.13.1 Invoking a 3D viewer

A 3D viewer can be created in a script by passing the appropriate option to **Draw()** when attaching the drawn object(s) to a pad. For a fuller explanation of pads, attaching objects with **Draw()** etc. refer to “Graphical Containers: Canvas and Pad”.

```
root[] myShapes->Draw("ogl");
```

Valid option strings are:

- “ogl” : external GL viewer
- “x3d”: external X3D viewer
- “pad”: pad viewer

If no option is passed to `Draw()` then the “pad” is used by default. If you already have content in a pad, which you would like to display in one of the external viewers you can select from the canvas View menu / View With, and pick the viewer type.

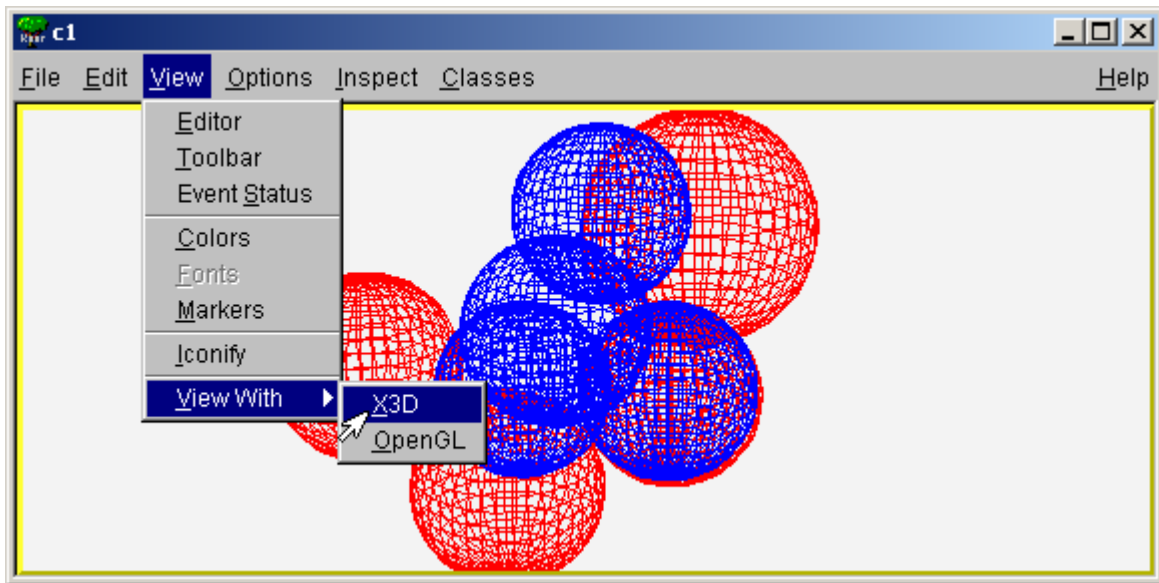

Figure 9.34: Invoking external 3D viewers from canvas menus

Note: A current limitation means that when an external viewer is created the pad is no longer redrawn. When the external viewer is closed, clicking in the pad will refresh.

### 9.13.2 The GL Viewer

The GL Viewer uses (or compliant libraries such as ) to generate high quality, high-performance 3D renderings, with sophisticated lighting, materials and rendering styles for 3D scenes. Many users will be able to take advantage of hardware acceleration of the underlying OpenGL commands by their computer’s video card, resulting in considerable performance gains - up to interactive manipulation of 1000’s of complex shapes in real-time.

The GL Viewer is supported on all official ROOT platforms (assuming you have suitable libraries), and is the main 3D viewer, which development effort is concentrated upon. As OpenGL® is a trademark we refer to our viewer built on this technology as the ‘GL Viewer’. The code for it can be found under \$ROOTSYS/gl.

You can manipulate the viewer via the GUI or via the base `TGLViewer` object behind the interface. These are detailed below - see also \$ROOTSYS/tutorials/gl/glViewerExercise.C.

#### 9.13.2.1 Projections Modes (Cameras)

The GL Viewer supports two basic types of camera, which affect how the 3D world is projected onto the 2D render area:

- Perspective: Objects are drawn with characteristic ‘foreshortening’ effect, where distant objects appear smaller than near ones. This is useful for obtaining a ‘real world’ views. The degree of foreshortening is affected by the current camera field of view (focal length of its ‘lens’) - see “Adjusting Cameras”.
- Orthographic: Distance from camera does not affect object size. These projections are useful for measurement or checking alignments, as the sizes and angles between objects are preserved.

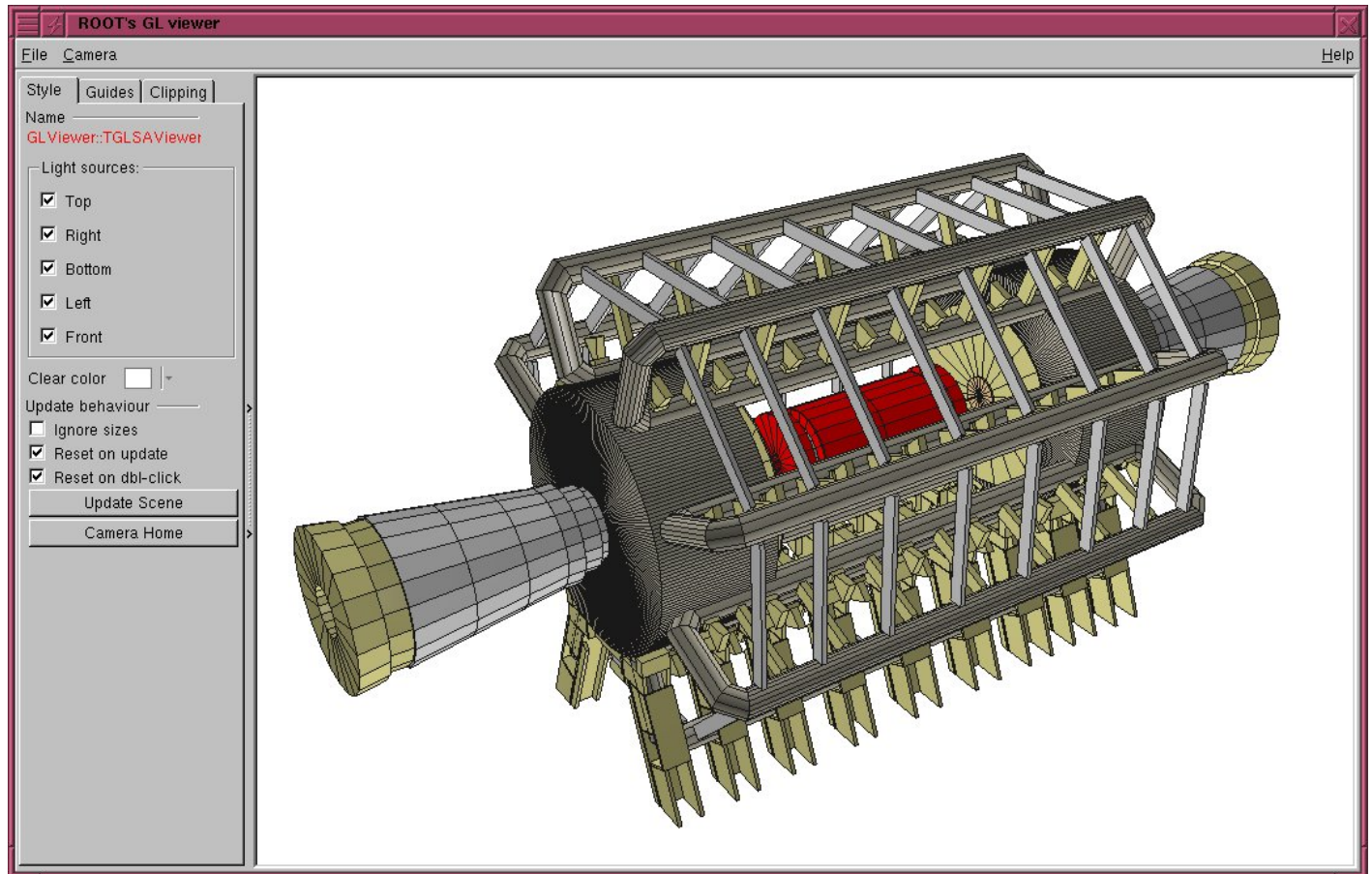

Figure 9.35: The GL 3D Viewer

You can select the active camera from the viewer's Camera menu on the top menu bar. There are three perspective camera choices:

- Perspective (Floor XOZ) Default
- Perspective (Floor YOZ)
- Perspective (Floor XOY)

In each case the perspective camera is constrained to keep the chosen floor plane, defined by a pair of world axes, appearing level at all times - i.e. there is no banking of the 'horizon' that you experience when a plane rolls. There are also three orthographic camera choices:

- Orthographic (XOY)
- Orthographic (XOZ)
- Orthographic (ZOY)

Orthographic projections are generally constrained to look down one of the global axes of the world, with the other two axes lying horizontal/vertical on the viewer window. Therefore, XOY has the X-axis horizontal, the Y-axis vertical. You can always confirm the orientation and constraints of the camera in the world by enabling axis drawing in the "Guides" tab - see sections "Guides" and "Clipping" below. For orthographic camera a ruler-depicting current scene units is also available.

You can also pick the current camera by obtaining a handle to the GL Viewer object behind the interface:

```
TGLViewer * v = (TGLViewer *)gPad->GetViewer3D();
```

calling the method `TGLViewer::SetCurrentCamera` with one of the `TGLViewer::ECameraType` types:

```
v->SetCurrentCamera(TGLViewer::kCameraPerspXOZ);
```

See also `$ROOTSYS/tutorials/gl/glViewerExercise.C`.

### 9.13.2.2 Adjusting Cameras

The interactions with the camera are summarized above. In each case the interaction is listed, along with description and user actions required to achieve it. For all cameras you can reset the original default view, framing the entire scene, by double clicking any mouse button.

For the Zoom interaction you can use the following modifiers combinations to adjust the sensitivity:

- Shiftx 10
- Ctrlx 0.1
- Shift + Ctrlx 0.01

The modifiers must be applied after the zoom action has started (right mouse button is down).

Note for orthographic cameras:

- There is no field of view or focal length - dolly and zooming producing an identical scaling action.
- There is a fixed eye direction - so the 'Orbit' action is disabled.

Note for perspective cameras:



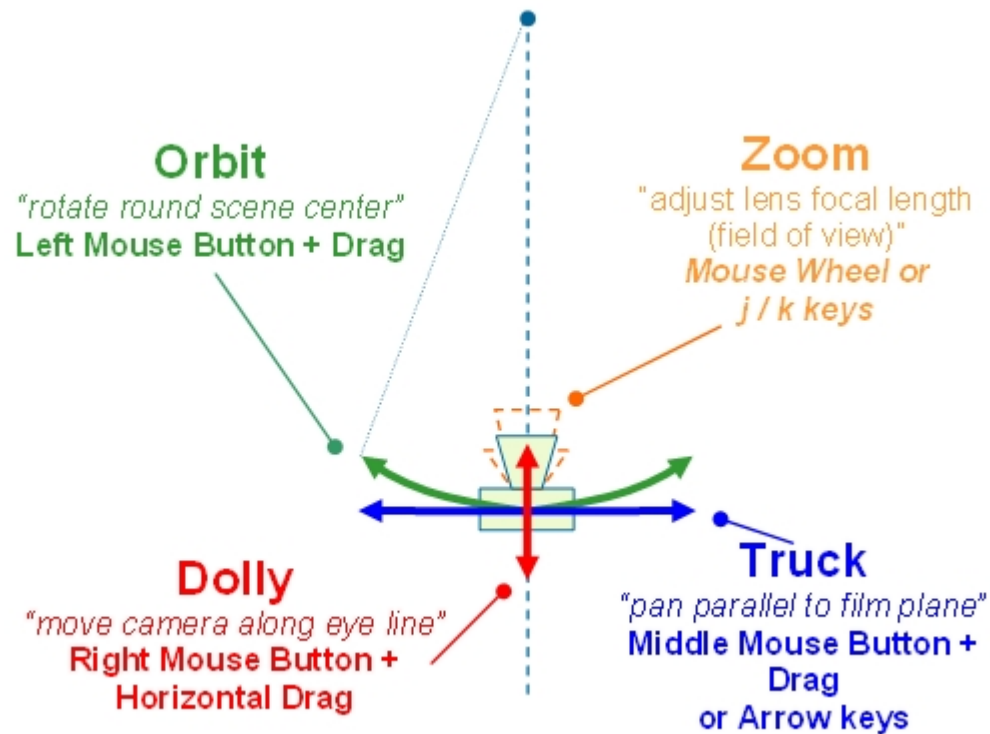

Figure 9.36: GL Viewer camera interactions

- Dolly (moving the camera backwards/forwards) and zooming are often confused, and may appear very similar.
- When you dolly the camera the lens focal length does not change, hence the distortions associated with the projections are unaffected. However the movement can result in objects coming ‘through the front’ of the camera and disappearing.
- When you zoom, the camera does not move - hence clipping of near objects is unaffected. However with extremely small zooms (FOV large/focal length short) noticeable distortions, causing straight lines to become curved, can be seen with objects near the camera - the ‘fisheye’ lens effect.
- Generally dolly is more ‘natural’, but you may need to use both to achieve the desired perspective and eye position - particularly when you are working inside or very close to 3D objects.

Configure the camera by calling the methods `SetPerspectiveCamera()` or `SetOrthographicCamera()` of `TGLViewer`:

```
TGLViewer * v = (TGLViewer *)gPad->GetViewer3D();
v->SetOrthoCamera(TGLViewer::kCameraOrthoXOY,
                left,right,top,bottom);
...
v->SetPerspectiveCamera (camera,fov,dolly,center,hRotate,vRotate);
```

Note - you can configure any of the six cameras in the viewer at any time, but you will not see the result until the camera is made current.

### 9.13.2.3 Draw Styles

The GL Viewer supports three different rendering modes, which are applied to all the objects in your scene, but not Clip Shapes and Guides (See “Clipping” and “Manipulators”). These are shown below, along with the key used to activate the style.

**Filled Polygons Wireframe Outline** Enable with ‘r’ key Enable with ‘w’ key Enable with ‘t’ key Solid polygons, with hidden surface Object edges in color, with Combination of Filled Polygons removal, color surface materials, no surface

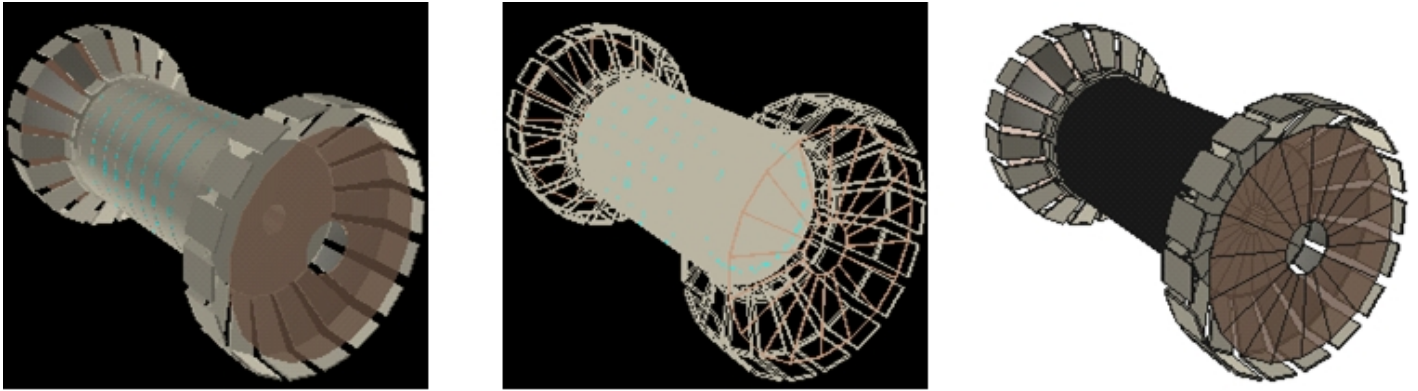

Figure 9.37: GL Viewer draw styles

filling/hiding, and Outline styles. Solid opacity, specular reflection etc. shapes with edges. Black background. Black background. White background.

Call method `TGLViewer::SetStyle` with one of `TGLRnrCtx::EDrawStyleflags` `kFill`, `kOutline`, `kWireFrame`:

```
v->SetStyle(TGLRnrCtx::kFill);
```

#### 9.13.2.4 Lighting / Style

The GL viewer creates five diffuse lights (left, right, top, bottom, and front) arranged around the 3D scene. These lights are carried with the camera - that is they are always in same position relative to your eye - the left light always shines from the left.

Light controls are located: Viewer Controls Pane ‘Style’.

Each light has a checkbox to enable/disable it. Set lights on/off with `TGLLightSet::SetLight` e.g.

```
v->GetLightSet()->SetLight(TGLLightSet::kLightBottom, kFALSE);
```

#### 9.13.2.5 Clipping

The GL viewer supports interactive clipping, enabling you to remove sections of your 3D scene and the shapes, revealing internal details.

The controls for clipping can be found under: Viewer Controls Pane ‘Clipping’ tab.

Two clipping ‘shapes’ are currently supported:

- Single plane
- Box

Pick the type from the radio buttons - only one (or none) may be active at one time.

The clip object can be adjusted by:

- Adjusting the values in the properties panel GUI
- Directly manipulating the clip object in the viewer

To show and/or directly manipulate the object check the ‘Show / Edit in Viewer’ checkbox. The clip object is drawn in semi-transparent light brown. The current manipulator is attached to it, allowing you direct control over its position, scale and rotation. See “Manipulators” section below for details on using viewer manipulators.

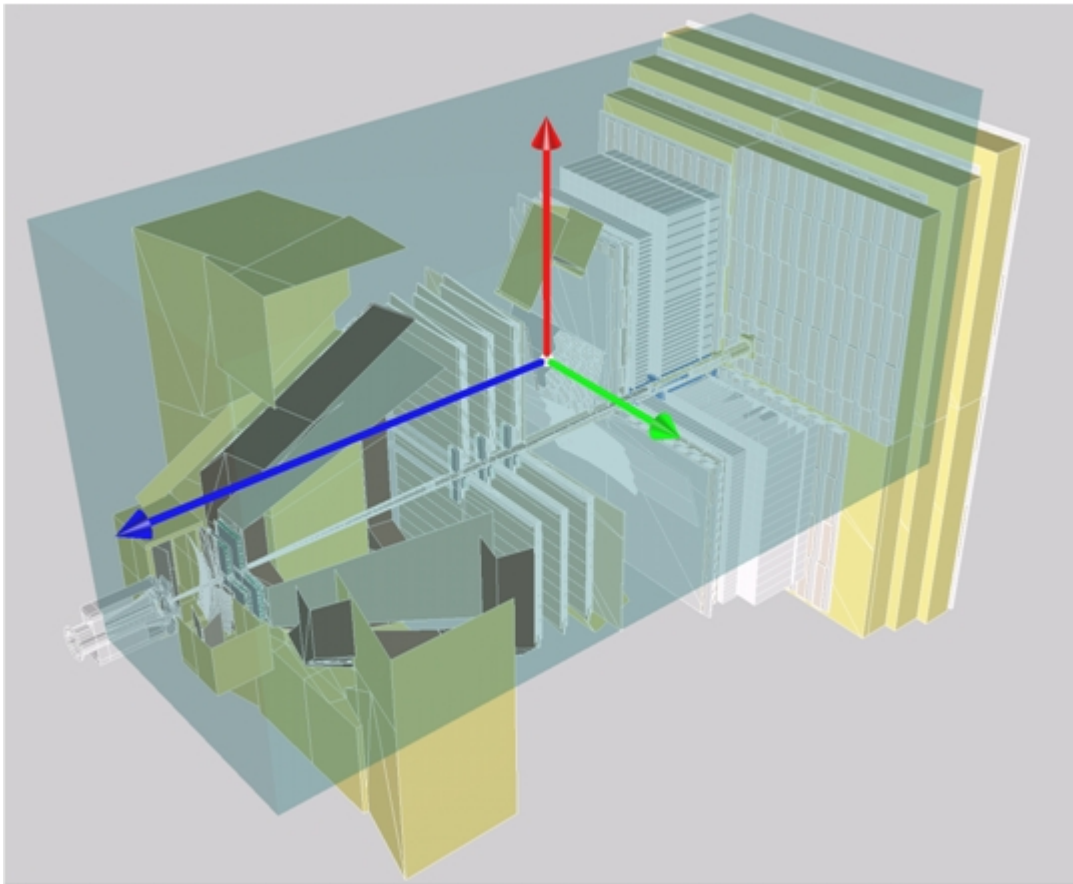

Figure 9.38: GL Viewer interactive box clipping

The clip plane is described by the standard plane equation:  $\mathbf{ax+by+cz+d=0}$ , where the factors **a**, **b**, **c**, **d** are entered into the edit boxes, and applied using the ‘Apply’ button.

The clip box is described by its center position, entered in the ‘Center X’, ‘Center Y’ and ‘Center Z’ edit boxes, and its lengths (extents) entered in the ‘Length X’, ‘Length Y’ and ‘Length Z’ edit boxes.

This clipping is achieved using OpenGL clip plane support; as such, there are certain limitations:

- Solid shapes are not capped - they appear hollow.
- Only shapes, which can be described with combination of planes, can be rendered in this fashion - e.g. a clipping tube is not possible.
- Each additional clipping plane requires an additional render pass - so the more active planes the more time the render will take.

Set the current clip object with `TGLClipSet::SetClipType`

```
v->GetClipSet()->SetClipType(TGLClipSet::kClipPlane);
```

Configure the clip object with `TGLClipSet::SetClipState`

```
Double_t planeEq[4] = {0.5,1.0,-1.0, 2.0};
v->GetClipSet()->SetClipState(TGLClipSet::kClipPlane, planeEq);
```

As with cameras, any clip can be configured at any time, but you must set the clip current to see the effect.

### 9.13.2.6 Manipulators

*Manipulators* are GUI ‘widgets’ or controls attached to a 3D object in the viewer, allowing a direct manipulation of the object’s geometry. There are three manipulators for the three basic geometries transformations. In each case, the *manipulator* consists of three components, one for each local axis of the object, shown in standard colors: red (X), green (Y) and blue (Z).

Activate the *manipulator* by moving the mouse over one of these components (which turns yellow to indicate active state). Click with left mouse and drag this active component to perform the manipulation. Toggle between the *manipulator* types using the ‘x’, ‘c’, ‘v’ keys while the mouse cursor is above the manipulator. Note: Manipulators cannot be controlled via the API at present.

### 9.13.2.7 Guides

Guides are visual aids drawn into the viewer world. Controls for these are under the “Guides” tab:

Viewer Controls Pane Guides Tab

Axes show the world (global) frame *coordinated* directions: X (red), Y (green) and Z (blue). The negative portion of the *axis* line is shown in dark color, the positive in bright. The *axis* name and minimum / maximum values are labeled in the same color. There are three options for *axes* drawing - selected by radio buttons:

- None - not drawn (default).
- Edge - draw axes on the (minimum) edge of the scene extents box.
- Origin - drawn axes through the origin.

For *edge axes*, the zero value for each axis is marked on the axis line with a colored sphere. For *origin axes*, a single white sphere is shown at the origin.

*Edge axes* are depth clipped - i.e. are obscured by 3D objects in front of them. *Origin axes* (which generally pass through the middle of the 3D scene) are not depth clipped - so always visible.

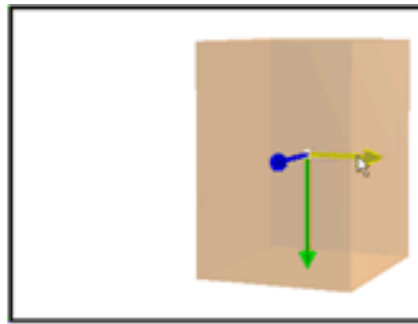
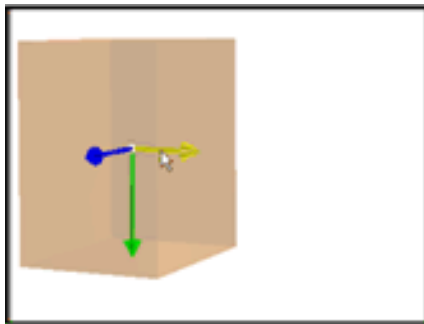

### Translation

Move the object along one of a local axis. Axis lines with arrow heads.

*(enable with 'v' key)*

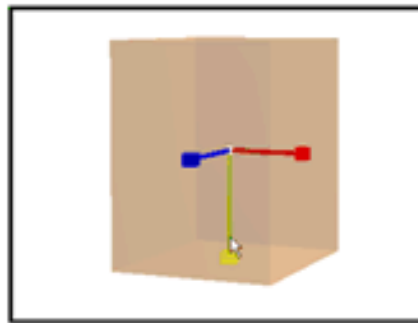
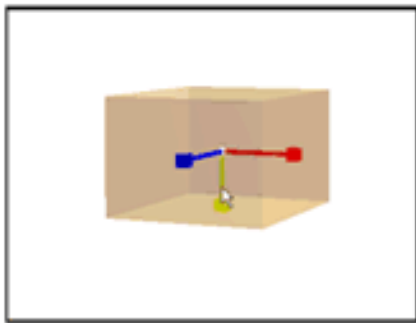

### Scale

Scale the object along one of a local axis. Axis lines with box heads.

*(enable with 'x' key)*

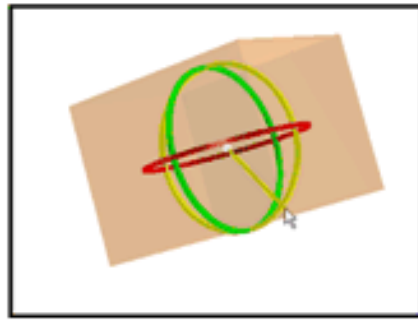
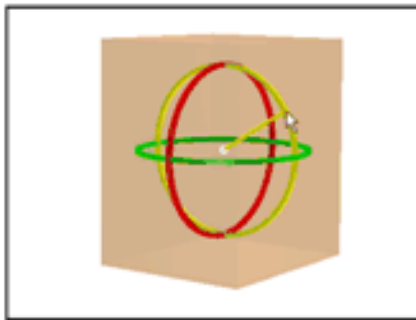

### Rotation

Rotate the object along one of a local axis. Axis rings in plane with axis normal.

*(enable with 'c' key)*

Figure 9.39: GL Viewer object manipulators

A single orange sphere of fixed view port (window) size can be shown at any arbitrary position. Enable / disable the drawing with ‘*Show*’ checkbox. Enter X/Y/Z position in the edit boxes to set position. Initial position is at the center of the scene.

Set the guides using `TGLViewer::SetGuideState` e.g. to enable edge axes, and enable a reference marker at world position 50, 60, 100:

```
Double_t refPos[3] = {50.0,60.0,100.0};
v->SetGuideState(TGLUtil::kAxesEdge, kTRUE, refPos);
```

### 9.13.2.8 Selecting Scene Shapes

You can select a single shape from your scene by pressing ‘Shift’ key, pointing and left clicking anywhere on the shape in the viewer. Selection is currently shown by drawing the shape-bounding box (not depth clipped) in white (polygon or wire frame render styles) or red (outline render style). Manipulators supported by the shape are drawn in red, green and blue while the non-supported ones are drawn in grey. To deselect a shape, either select another, or shift/click anywhere on the background (empty space) in the viewer. You cannot select Manipulators or Guides (Axes / Reference Marker).

### 9.13.2.9 Editing Shapes

When a shape is selected, the viewer’s control pane shows the user interface that allows you to review and adjust the color and geometry properties of the shape.

Note: At present modifications to the shapes are local to the viewer - they are not propagated back to external objects/client that published to the viewer. The changes are preserved only until the viewer is closed. In some cases, this will never be feasible as there is not a one-to-one correspondence between a shape in the viewer and a single external object in which the modification could be stored.

### 9.13.2.10 Colors / Style

Viewer Controls Pane ‘Style’ tab.

A full description of OpenGL materials, colors and lighting is beyond the scope of this document. You should refer to the OpenGL programming manual (Red Book) for a full discussion. In most cases adjustment of the Diffuse color material + Opacity/Shine properties is sufficient to achieve desired results.

A shape has four-color materials (components):

- Diffuse
- Ambient
- Specular
- Emissive

For each of these you can select the component via the radio buttons. Each component can have the red, green and blue values for the component adjusted via the sliders. You can apply this adjustment to the shape itself, or to all shapes sharing a common ‘family’. Shapes of the same family have external objects with the same **TObject** name string. You can also adjust the ‘Opacity’ and ‘Shine’ for the shapes materials via the sliders.

### 9.13.2.11 Geometry

Viewer Controls Pane ‘Geometry’ tab.

Review and modify the shapes X/Y/Z center and scaling factors via the edit boxes. Selection and editing of shapes is not available via the API at present.

### 9.13.2.12 Outputting Viewer Contents

The current viewer rendering can be output to an external EPS or PDF, using the options under the ‘File’ menu on the top menu bar. The file is named ‘viewer.eps’ or ‘viewer.pdf’ and written to the current ROOT directory.

### 9.13.3 The X3D Viewer

The X3D viewer is a fairly simple and limited viewer, capable of showing basic lines and polygons. It lacks the quality, performance and more advanced features of the GL Viewer, and additionally is not supported on Windows. It is not actively developed and you are encouraged to use the GL Viewer out of preference. The below table presents the main interactions - these are repeated in the Help dialog of the viewer.

Action KeyActionKey

Wireframe Mode wRotate about xx a

Hidden Line Mode eRotate about yy b

Hidden Surface Mode rRotate about zz c

Move object down uAuto-rotate about x1 2 3

Move object up iAuto-rotate about y4 5 6

Move object left lAuto-rotate about z7 8 9

Move object right hToggle controls styleo

Move object forward jToggle stereo displays

Move object backward kToggle blue stereo viewd

Adjust focus (stereo mode) [ ] { }Toggle double bufferf

Rotate object Left mouse button down + move.

### 9.13.4 Common 3D Viewer Architecture

The 3D Viewer Architecture provides a common mechanism for viewer clients to publish 3D objects to it. It enables:

- Decoupling of producers (geometry packages etc) who model collection of 3D objects from consumers (viewers) which display them.
- Producer code free of explicit drawing commands & viewer specific branching.
- Support differing viewers and clients capabilities, e.g.
- Mix of native (in viewer) shapes and generic client side tessellation.
- Local/global frame object description
- Bounding boxes
- Placing copies sharing common geometry (logical/physical shapes).

The architecture consists of:

- **TVirtualViewer3D** interface: An abstract handle to the viewer, allowing client to add objects, test preferences etc.
- **TBuffer3D** class hierarchy: Used to describe 3D objects (“shapes”) - filled /added by negotiation with viewer via **TVirtualViewer3D**.

A typical interaction between viewer and client using these, taken from **TGeoPainter** is:

```

TVirtualViewer3D * viewer = gPad->GetViewer3D();
// Does viewer prefer local frame positions?
Bool_t localFrame = viewer->PreferLocalFrame();
// Perform first fetch of buffer from the shape and try adding it to the viewer
const TBuffer3D &buffer = shape.GetBuffer3D(TBuffer3D::kCore |
TBuffer3D::kBoundingBox |
TBuffer3D::kShapeSpecific,
localFrame);
Int_t reqSections = viewer->AddObject(buffer, &addDaughters);

// If the viewer requires additional sections fetch from the shape
// (if possible) and add again
if (reqSections != TBuffer3D::kNone)
shape.GetBuffer3D(reqSections, localFrame);

```

Together these allow clients to publish objects to any one of the 3D viewers free of viewer specific drawing code. They allow our simple x3d viewer, and considerably more sophisticated OpenGL one to both work with both geometry libraries (g3d and geom) efficiently.

In addition to external viewers, created in separate windows, this architecture is also used by internal **TPad** drawing when it requires 3D projections. Publishing to a viewer consists of the following steps:

- 1- Create / obtain viewer handle.
- 2- Begin scene on viewer.
- 3- Fill mandatory parts of TBuffer3D describing object.
- 4- Add to viewer.
- 5- Fill optional parts of TBuffer3D as requested by viewer.
- [ . . . . repeat 3/4/5 as required for other/child objects]
- 6- End scene on viewer.

You should attach the top-level node of your external geometry (or the manager) to a **TPad** object using **TObject::Draw()**, and perform the publishing to the viewer in your object's **TObject::Paint()** overloaded method. See “Scene Rebuilds”, and example scripts, for more details.

#### 9.13.4.1 Creating / Obtaining Viewer Handle

External viewers are bound to a **TPad** object (this may be removed as a requirement in the future). You can create or obtain the current viewer handle via the method:

```
TVirtualViewer3D * v = gPad->GetViewer3D("type");
```

Here the “type” string defines the viewer type - currently one of:

- “ogl” : External GL viewer
- “x3d”: External X3D viewer
- “pad”: Pad viewer

If no type is passed (null string), and there is no current viewer, then the type is defaulted to “pad”. If no type is passed and there is a current viewer, then this is returned - hence once a viewer is created it can be obtained elsewhere by:

```
TVirtualViewer3D * v = gPad->GetViewer3D();
```



### 9.13.4.2 Opening / Closing Scenes

Objects must be added to viewer between `BeginScene()` and `EndScene()` calls e.g.

```
viewer->BeginScene();
// Add objects
viewer ->EndScene();
```

These calls enable the viewer to suspend redraws, and perform internal caching/setup. If the object you attach to the pad derives from `TAtt3D`, then the pad will take responsibility for calling `BeginScene()` and `EndScene()` for you. You can always test if the scene is already open for object addition with:

```
viewer->BuildingScene();
```

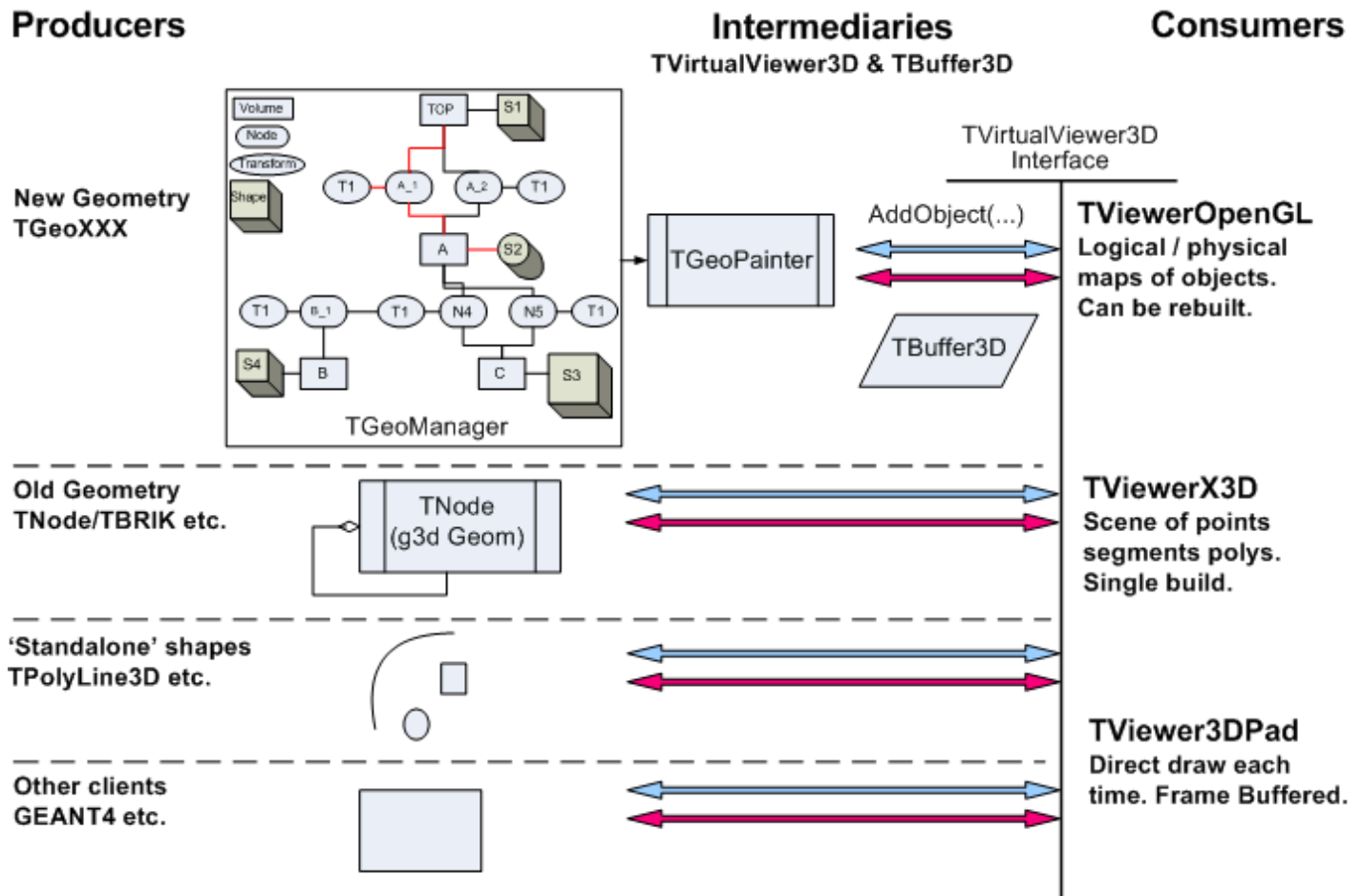

Figure 9.40: Overview of 3D viewer architecture

Note: the x3d viewer does not support rebuilding of scenes - objects added after the first Open/Close Scene pair will be ignored.

### 9.13.4.3 Describing Objects - Filling TBuffer3D

The viewers behind the `TVirtualViewer3D` interface differ greatly in their capabilities e.g.

- Some support native shape (e.g. spheres/tubes in OpenGL) and can draw these based on an abstract description. Others always require a tessellation description based on `TBuffer3D`'s `kRaw` / `kRawSizes` points/lines/segments sections.

- Some need the 3D object positions in the master (world) frame, others can cope with local frames and a translation matrix to place the object.
- Some require bounding boxes for objects - others do not.

Similarly some viewer clients are only capable of providing positions in master frame, cannot provide bounding boxes etc. Additionally we do not want to incur the cost of expensive tessellation operations if the viewer does not require them. To cope with these variations the **TBuffer3D** objects are filled by negotiation with the viewer.

**TBuffer3D** classes are conceptually divided into enumerated sections: **kCore**, **kBoundingBox**, **kRaw** - see the class diagram and the file **TBuffer3D.h** for more details. The **TBuffer3D** methods **SectionsValid()**, **SetSectionsValid()**, **ClearSectionsValid()** are used to test, set, clear these section validity flags e.g.

```
buffer.SetSectionsValid(TBuffer3D::kShapeSpecific);
...
if (buffer.SectionsValid(TBuffer3D::kShapeSpecific)) {
    ...
}
```

The sections found in the base **TBuffer3D** (**kCore/kBoundingBox/kRawSizes/kRaw**) are sufficient to describe any tessellated shape in a generic fashion. An additional **kShapeSpecific** section is added in **TBuffer3D** derived classes, allowing a more abstract shape description (“a sphere of inner radius x, outer radius y”). This enables a viewer, which knows how to draw (tessellate) the shape itself to do so, while providing a generic fallback suitable for all viewers. The rules for client negotiation with the viewer are:

- If suitable specialized **TBuffer3D** class exists, use it, otherwise use **TBuffer3D**.
- Complete the mandatory **kCore** section.
- Complete the **kShapeSpecific** section if applicable.
- Complete the **kBoundingBox** if you can.
- Pass this buffer to the viewer using one of the **TBuffer3D::AddObject()** methods.

If the viewer requires more sections to be completed (**kRaw/kRawSizes**) **TBuffer3D::AddObject()** will return flags indicating which ones, otherwise it returns **kNone**. If requested, you must fill the buffer, mark these sections valid, and call **TBuffer3D::AddObject** again, to complete adding the object. For example, in our **TGeo** geometry package, in **TGeoPainter::PaintShape**, we perform the negotiation with viewer:

```
TVirtualViewer3D * viewer = gPad->GetViewer3D();
if (shape.IsA() != TGeoCompositeShape::Class()) {
    // Does viewer prefer local frame positions?
    Bool_t localFrame = viewer->PreferLocalFrame();
    // Perform first fetch of buffer from the shape and adding
    // it to the viewer
    const TBuffer3D &buffer = shape.GetBuffer3D(TBuffer3D::kCore |
        TBuffer3D::kBoundingBox |
        TBuffer3D::kShapeSpecific, localFrame);
    Int_t reqSections = viewer->AddObject(buffer, &addDaughters);
    // If the viewer requires additional sections fetch from the
    // shape (if possible) and add again
    if (reqSections != TBuffer3D::kNone) {
        shape.GetBuffer3D(reqSections, localFrame);
        viewer->AddObject(buffer, &addDaughters);
    }
}
```

The buffer is supplied/filled by the appropriate **TShape::GetBuffer3D()** and **TShape::FillBuffer3D** overloads e.g. for a sphere in **TGeoSphere**.

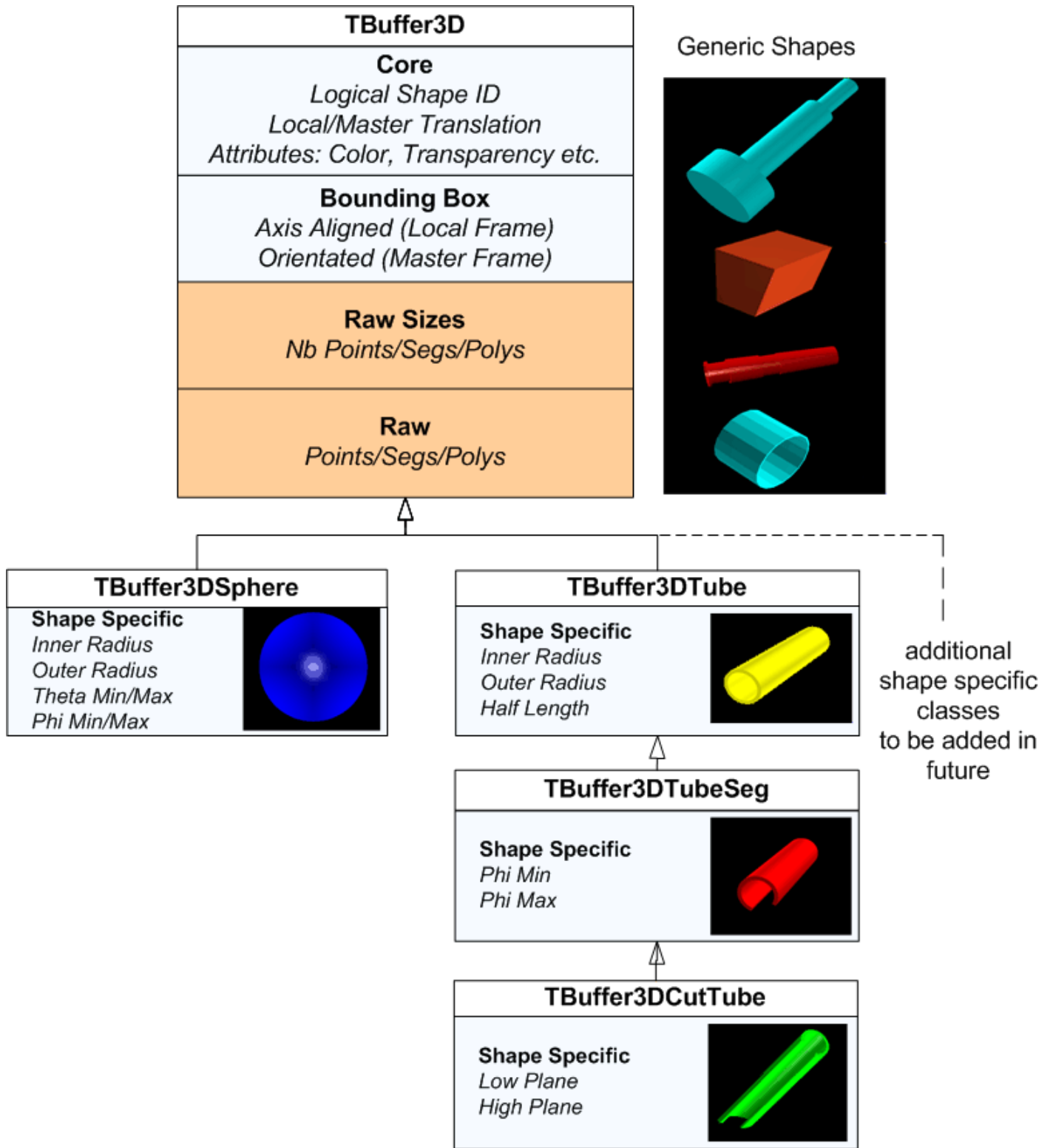

Figure 9.41: TBuffer3D class hierarchy

```

const TBuffer3D &TGeoSphere::GetBuffer3D(Int_t reqSections,
Bool_t localFrame) const {
    // Fills a static 3D buffer and returns a reference.
    static TBuffer3DSphere buffer;
    // Filling of kBoundingBox is deferred to TGeoBBox, and
    // kCore on up to TGeoShape
    TGeoBBox::FillBuffer3D(buffer, reqSections, localFrame);
    // Complete kShapeSpecific section for sphere
    if (reqSections & TBuffer3D::kShapeSpecific) {
        buffer.fRadiusInner = fRmin;
        buffer.fRadiusOuter = fRmax;
        ...
        buffer.SetSectionsValid(TBuffer3D::kShapeSpecific);
    }
    // Complete kRawSizes section
    if (reqSections & TBuffer3D::kRawSizes) {
        ...
        buffer.SetSectionsValid(TBuffer3D::kRawSizes);
    }
}
// Complete kRaw tessellation section
if ((reqSections & TBuffer3D::kRaw) &&
    buffer.SectionsValid(TBuffer3D::kRawSizes)) {
    SetPoints(buffer.fPnts);
    // Transform points to master frame if viewer requires it
    // The fLocalFrame flag and translation matrix will have
    // already been set in TGeoShape::FillBuffer3D() as required
    if (!buffer.fLocalFrame)
        TransformPoints(buffer.fPnts, buffer.NbPnts());
    SetSegsAndPols(buffer);
    buffer.SetSectionsValid(TBuffer3D::kRaw);
}
return buffer;
}

```

Note:

- we use a static **TBuffer3D** derived object for efficiency - once the object is added the buffer can be reused.
- **kRawSize** (the calculation of tessellation sizing required in buffer) and **kRaw** (the actual filling of tessellation) is split, as the X3D viewer requires two publication passes - one to establish the full tessellation capacity for all shapes, and another to actually add them. Splitting avoids having to do the expensive tessellation on the first pass.

#### 9.13.4.4 Shape Specific TBuffer3D Derived Classes

Currently we provide the following shape specific classes, which the GL Viewer can take advantage of (see **TBuffer3D.h** and **TBuffer3DTypes.h**)

- **TBuffer3DSphere** - solid, hollow and cut spheres (GL Viewer only supports solid spheres at present - cut / hollow ones will be requested as tessellated objects by client.)
- **TBuffer3DTube** - basic tube with inner/outer radius and length.
- **TBuffer3DTubeSeg** - angle tube segment.
- **TBuffer3DCutTube** - angle tube segment with plane cut ends.

See the above example from **TGeoSphere::GetBuffer3D** and also equivalent functions in **TGeoTube**, **TGeoTubeSeg** and **TGeoCutub**. Anyone is free to add new **TBuffer3D** classes, but it should be clear that one or more viewers will require updating to be able to take advantage of them. Hence we only provide classes which existing viewers can benefit from. The number of native shapes in GL Viewer will be expanded in the future.

### 9.13.4.5 Master / Local Reference Frames

The Core section of **TBuffer3D** contains two members relating to reference frames:

- **fLocalFrame**: indicates if any positions in the buffer (bounding box and tessellation vertexes) are in local or master (world frame).
- **fLocalMaster**: is a standard 4x4 translation matrix (OpenGL column major ordering) for placing the object into the 3D master frame.

If **fLocalFrame** is false, **fLocalMaster** should contain an identity matrix. This is set by default, and can be reset using the **TBuffer3D::SetLocalMasterIdentity()** method.

### 9.13.4.6 Bounding Boxes

You are not obliged to complete the **kBoundingBox** section, as any viewer requiring one internally (GL Viewer) will build it if you do not provide. However to do this the viewer will force you to provide the (expensive) raw tessellation, and the resulting box will be axis aligned with the overall scene, which is non-ideal for rotated shapes. As we need to support orientated (rotated) bounding boxes, **TBuffer3D** requires the 6 vertices of the box. We also provide a convenience function, **TBuffer::SetAABoundingBox()**, for simpler case of setting an axis aligned bounding box. The bounding box should be filled in same frame (local / master) as the rest of the **TBuffer3D**, and in accordance with **fLocalFrame** flag.

A typical example from **TGeoBBox::FillBuffer3D**:

```

if (reqSections & TBuffer3D::kBoundingBox) {
    Double_t halfLengths[3] = { fDX, fDY, fDZ };
    buffer.SetAABoundingBox(fOrigin, halfLengths);
    if (!buffer.fLocalFrame) {
        TransformPoints(buffer.fBBVertex[0], 8);
    }
    buffer.SetSectionsValid(TBuffer3D::kBoundingBox);
}

```

### 9.13.4.7 Logical and Physical Objects

Some viewers can support two types of object placement:

- Add object as a single independent entity in the world reference frame - e.g. a sphere, radius **r**, at **x**, **y**, **z**.
- Repeated placement (copying) in world frame of this locally unique piece of geometry (described in local reference frame) e.g. define a sphere **S** (radius **r**), place copy at **x1**, **y1**, **z1**, another copy at **x2**, **y2**, **z2** etc.

The second case is very typical in geometry packages, e.g. ROOT's **TGeo** package, GEANT4 etc, where we have very large number repeated placements of relatively few unique "shapes".

Some viewers (GL Viewer only at present) are able to take advantage of this by identifying unique logical shapes from the **fID** logical ID member of **TBuffer3D**. If repeated addition of the same **fID** is found, the shape is cached already - and the costly tessellation does not need to be sent again. The viewer can also perform internal GL specific caching (display lists) with considerable performance gains in these cases. For this to work correctly the logical object in must be described in **TBuffer3D** in the local reference frame, complete with the local/master translation. In some cases you will not have a real object you can reasonably set **TBuffer3D::fID** to, or the object is recycled or temporary. **To suppress internal caching in the GL Viewer in these cases, set TBuffer3D::fID to 0 (null).**

The viewer indicates it can support local frame objects through the **TVirtualViewer3D** interface method: **PreferLocalFrame()**. If this returns **kTRUE** you can make repeated calls to **AddObject()**, with **TBuffer3D** containing the same **fID**, and different **fLocalMaster** placements.

For viewers supporting logical/physical objects, the **TBuffer3D** content refers to the properties of the logical object, with the exception of:

- `fLocalMaster` transform
- `fColor`
- `fTransparency`

attributes, which can be varied for **each** physical object.

As a **minimum requirement** all clients must be capable of filling the raw tessellation of the object buffer, in the master reference frame. Conversely viewers must always be capable of displaying the object described by this buffer. If either does not meet this requirement the object may not be displayed.

#### 9.13.4.8 Scene Rebuilds

`TBuffer3D::AddObject` is not an explicit command to the viewer - it may for various reasons decide to ignore it:

- It already has the object internally cached.
- The object falls outside some 'interest' limits of the viewer camera.
- The object is too small to be worth drawing.

In all these cases `TBuffer3D::AddObject()` returns `kNone`, as it does for successful addition, indicating it does not require further information about this object. Hence you should not try to make any assumptions about what the viewer did with the object. The viewer may decide to force the client to rebuild (republish) the scene, obtaining a different collection of objects, if the internal viewer state changes .e.g. significant camera move. It does this presently by forcing a repaint on the attached `TPad` object - hence you should attach you master geometry object to the pad (via `TObject::Draw()`), and perform the publishing to the viewer in response to `TObject::Paint()`.

#### 9.13.4.9 Physical IDs

`TVirtualViewer3D` provides for two methods of object addition:

```
virtual Int_t AddObject(const TBuffer3D &buffer,
                      Bool_t * addChildren = 0)
virtual Int_t AddObject(UInt_t physicalID,
                      const TBuffer3D & buffer,
                      Bool_t *addChildren = 0)
```

If you use the first (simple) case a viewer using logical/physical pairs will generate sequential IDs for each physical object internally. Scene rebuilds will require destruction and recreation of all physical objects. For the second you can specify an identifier from the client side, which must be unique and stable - i.e. the IDs of a published object is consistent, regardless of changes in termination of contained child geometry branches. In this case the viewer can safely cache the physical objects across scene rebuilds, discarding those no longer of interest.

#### 9.13.4.10 Child Objects

In many geometries there is a rigid containment hierarchy, and so if the viewer is not interested in a certain object due to limits/size then it will also not be interest in any of the contained branch of siblings. Both `TBuffer3D::AddObject()` methods have an `addChildren` return parameter. The viewer will complete this (if passed) indicating if children of the object just sent are worth sending.

#### 9.13.4.11 Recycling TBuffer3D

Once add `TBuffer3D::AddObject()` has been called, the contents are copied to the viewer's internal data structures. You are free to destroy this `TBuffer3D`, or recycle it for the next object if suitable.

#### 9.13.4.12 Examples

For an example of a simple geometry, working in master reference frame examine the code under `$ROOTSYS/g3d`. For a more complex example, which works in both master and local frames, and uses logical/physical division of shape geometry and placement, examine the code under `$ROOTSYS/geom` - in particular **TGeoShape** hierarchy, and the painter object **TGeoPainter** (under `geopainter`) where the negotiation with the viewer is performed.





# Chapter 10

## Folders and Tasks

### 10.1 Folders

A **TFolder** is a collection of objects visible and expandable in the ROOT object browser. Folders have a name and a title and are identified in the folder hierarchy by an “UNIX-like” naming convention. The base of all folders is `//root`. It is visible at the top of the left panel in the browser. The browser shows several folders under `//root`.

New folders can be added and removed to/from a folder.

### 10.2 Why Use Folders?

One reason to use folders is to reduce class dependencies and improve modularity. Each set of data has a producer class and one or many consumer classes. When using folders, the producer class places a pointer to the data into a folder, and the consumer class retrieves a reference to the folder.

The consumer can access the objects in a folder by specifying the path name of the folder.

Here is an example of a folder's path name:

```
//root/Event/Hits/TCP
```

One does not have to specify the full path name. If the partial path name is unique, it will find it; otherwise it will return the first occurrence of the path.

The first diagram shows a system without folders. The objects have pointers to each other to access each other's data. Pointers are an efficient way to share data between classes. However, a direct pointer creates a direct coupling between classes. This design can become a very tangled web of dependencies in a system with a large number of classes.

In the second diagram, a reference to the data is in the folder and the consumers refer to the folder rather than each other to access the data. The naming and search service provided by the ROOT folders hierarchy provides an alternative. It loosely couples the classes and greatly enhances I/O operations. In this way, folders separate the data from the algorithms and greatly improve the modularity of an application by minimizing the class dependencies.

In addition, the folder hierarchy creates a picture of the data organization. This is useful when discussing data design issues or when learning the data organization. The example below illustrates this point.

### 10.3 How to Use Folders

Using folders means to build a hierarchy of folders, posting the reference to the data in the folder by the producer, and creating a reference to the folder by the user.

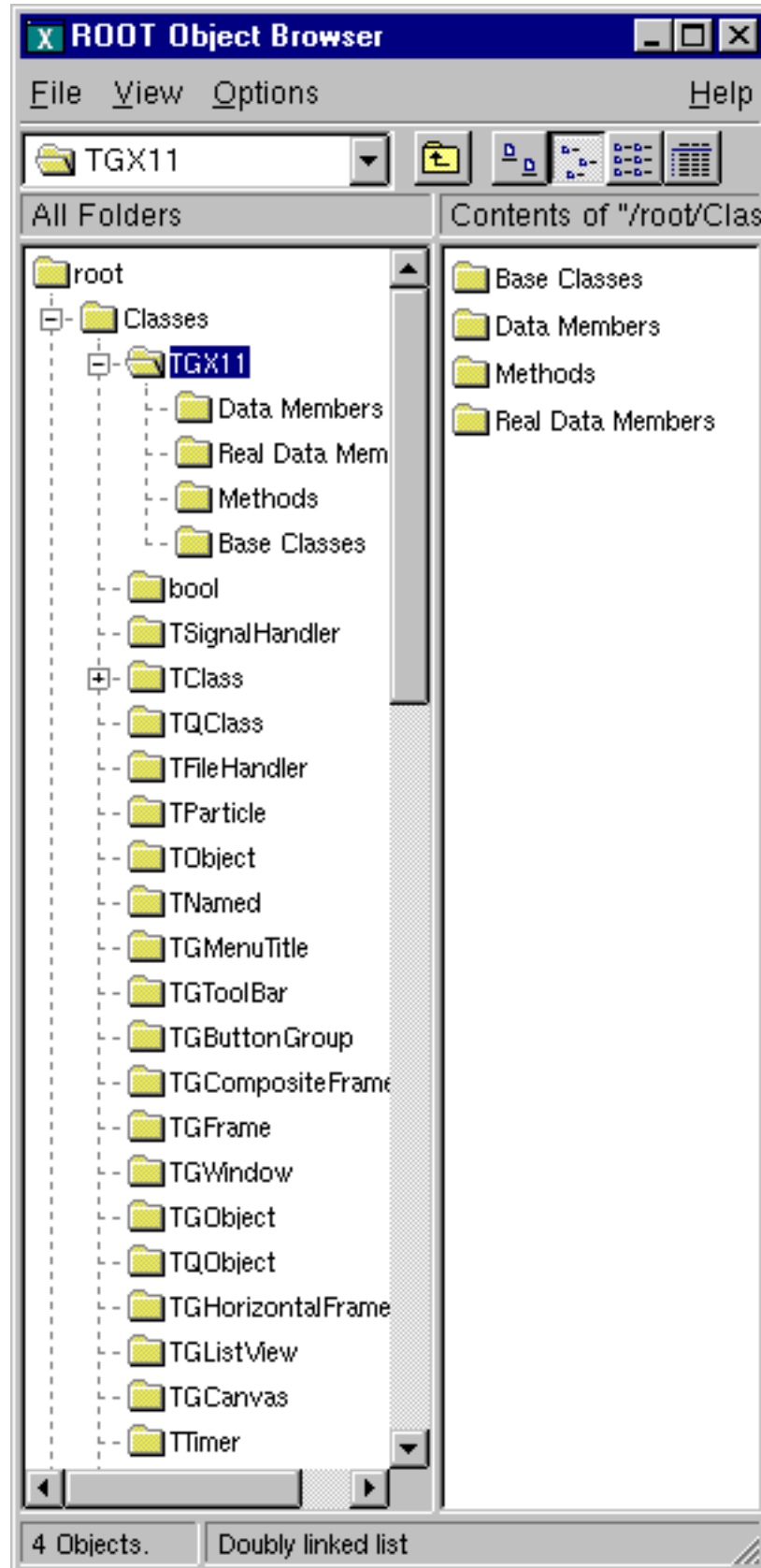



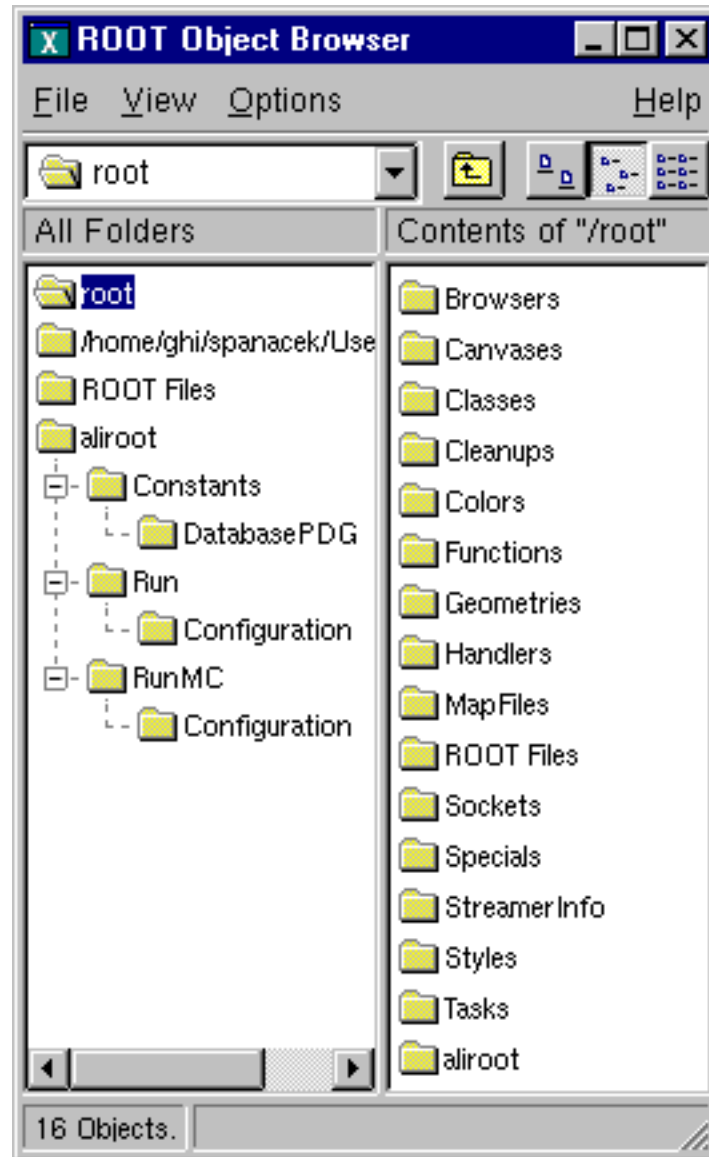

### 10.3.2 Posting Data to a Folder (Producer)

A **TFolder** can contain other folders as shown above or any **TObject** descendents. In general, users will not post a single object to a folder; they will store a collection or multiple collections in a folder. For example, to add an array to a folder:

```
TObjArray *array;
run_mc->Add(array);
```

### 10.3.3 Reading Data from a Folder (Consumer)

One can search for a folder or an object in a folder using the **TROOT::FindObjectAny** method. It analyzes the string passed as its argument and searches in the hierarchy until it finds an object or folder matching the name. With **FindObjectAny**, you can give the full path name, or the name of the folder. If only the name of the folder is given, it will return the first instance of that name. A string-based search is time consuming. If the retrieved object is used frequently or inside a loop, you should save a pointer to the object as a class data member. Use the naming service only in the initialization of the consumer class. When a folder is deleted, any reference to it in the parent or other folder is deleted also.

```
conf=(TFolder*)gROOT->FindObjectAny("/aliroot/Run/Configuration");
// or ...
conf=(TFolder*)gROOT->FindObjectAny("Configuration");
```

By default, a folder does not own the object it contains. You can overwrite that with **TFolder::SetOwner**. Once the folder is the owner of its contents, the contents are deleted when the folder is deleted. Some **ROOT** objects are automatically added to the folder hierarchy. For example, the following folders exist on start up:

```
//root/ROOT Files with the list of open Root files
//root/Classes with the list of active classes
//root/Geometries with active geometries
//root/Canvases with the list of active canvases
//root/Styles with the list of graphics styles
//root/Colors with the list of active colors
```

For example, if a file **myFile.root** is added to the list of files, one can retrieve a pointer to the corresponding **TFile** object with a statement like:

```
TFile *myFile = (TFile*)gROOT->FindObjectAny(
    "/ROOTFiles/myFile.root");
//or...
TFile *myFile = (TFile*)gROOT->FindObjectAny("myFile.root");
```

## 10.4 Tasks

Tasks can be organized into a hierarchy and displayed in the browser. The **TTask** class is the base class from which the tasks are derived. To give task functionality, you need to subclass the **TTask** class and override the **Exec** method. An example of **TTask** subclass is **\$ROOTSYS/tutorials/MyTasks.cxx**. The script that creates a task hierarchy and adds it to the browser is **\$ROOTSYS/tutorials/tasks.C**. Here is a part of **MyTasks.cxx** that shows how to subclass from **TTask**.

```
// A set of classes deriving from TTask see macro tasks.C. The Exec
// function of each class prints one line when it is called.
#include "TTask.h"
class MyRun : public TTask {
public:
    MyRun() { ; }
    MyRun(const char *name, const char *title);
```

```

    virtual ~MyRun() { ; }
    void Exec(Option_t *option="");
    ClassDef(MyRun,1)          // Run Reconstruction task
};

class MyEvent : public TTask {
public:
    MyEvent() { ; }
    MyEvent(const char *name,const char *title);
    virtual ~MyEvent() { ; }
    void Exec(Option_t *option="");
    ClassDef(MyEvent,1)      // Event Reconstruction task
};

```

Later in `MyTasks.cxx`, we can see examples of the constructor and overridden `Exec()` method:

```

ClassImp(MyRun)
MyRun::MyRun(const char *name,const char *title):TTask(name,title)
{
    ...
}
void MyRun::Exec(Option_t *option)
{
    printf("MyRun executingn");
}

```

Each `TTask` derived class may contain other `TTasks` that can be executed recursively. In this way, a complex program can be dynamically built and executed by invoking the services of the top level task or one of its subtasks. The constructor of `TTask` has two arguments: the name and the title. This script creates the task defined above, and creates a hierarchy of tasks.

```

// Show the tasks in a browser. To execute a Task, select
// "ExecuteTask" in the context menu see also other functions in the
// TTask context menu, such as:
//      -setting a breakpoint in one or more tasks
//      -enabling/disabling one task, etc
void tasks() {
    gROOT->ProcessLine(".L MyTasks.cxx");

    TTask *run = new MyRun("run","Process one run");
    TTask *event = new MyEvent("event","Process one event");
    TTask *geomInit = new MyGeomInit("geomInit",
        "Geometry Initialisation");
    TTask *matInit = new MyMaterialInit("matInit",
        "MaterialsInitialisation");
    TTask *tracker = new MyTracker("tracker","Tracker manager");
    TTask *tpc = new MyRecTPC("tpc","TPC Reconstruction");
    TTask *its = new MyRecITS("its","ITS Reconstruction");
    TTask *muon = new MyRecMUON("muon","MUON Reconstruction");
    TTask *phos = new MyRecPHOS("phos","PHOS Reconstruction");
    TTask *rich = new MyRecRICH("rich","RICH Reconstruction");
    TTask *trd = new MyRecTRD("trd","TRD Reconstruction");
    TTask *global = new MyRecGlobal("global","Global Reconstruction");

    // Create a hierarchy by adding sub tasks
    run->Add(geomInit);
    run->Add(matInit);
    run->Add(event);
}

```

```

event->Add(tracker);
event->Add(global);
tracker->Add(tpc);
tracker->Add(its);
tracker->Add(muon);
tracker->Add(phos);
tracker->Add(rich);
tracker->Add(trd);

// Add the top level task
gROOT->GetListOfTasks()->Add(run);

// Add the task to the browser
gROOT->GetListOfBrowsables()->Add(run);
new TBrowser;
}

```

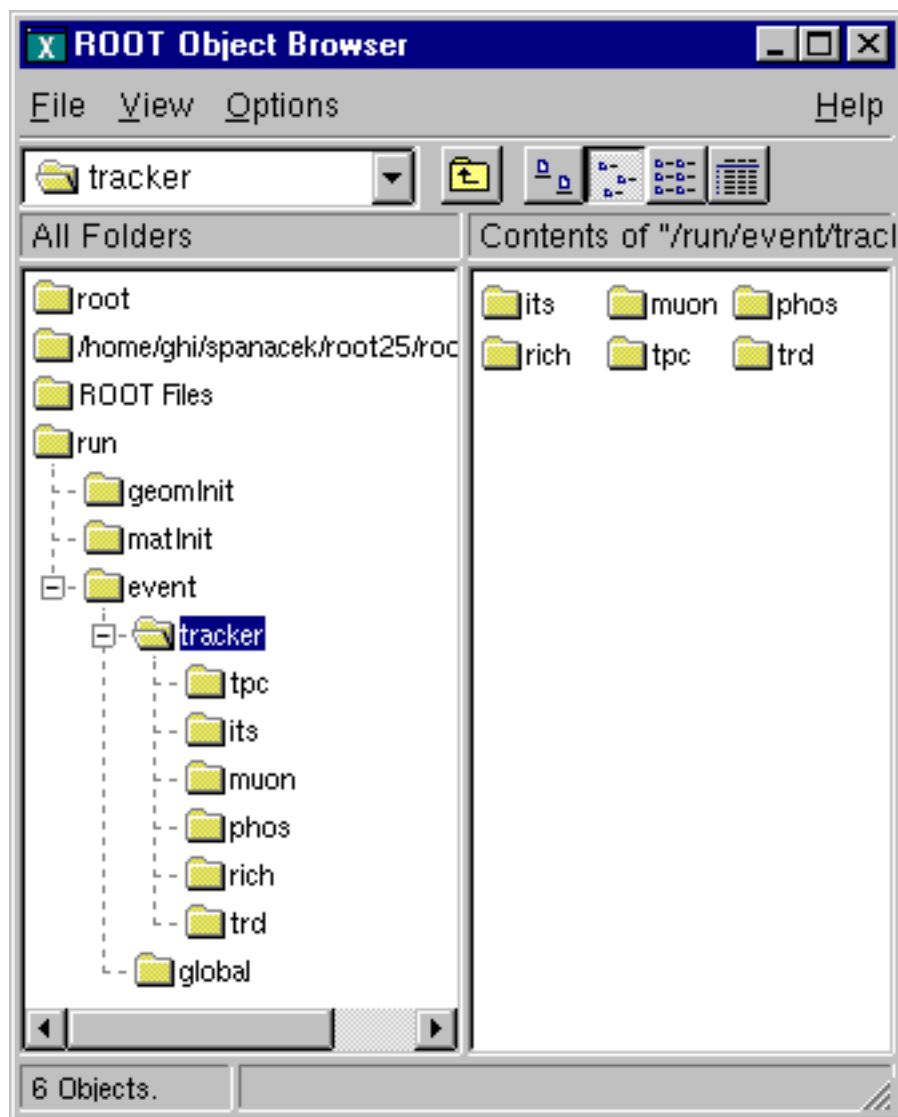

Figure 10.1: Tasks in the ROOT browser

Note that the first line loads the class definitions in `MyTasks.cxx` with ACLiC. ACLiC builds a shared library and adds the classes to the CINT dictionary. See “Adding a Class with ACLiC”.

To execute a `TTask`, you call the `ExecuteTask` method. `ExecuteTask` will recursively call:

- the `TTask::Execmethod` of the derived class;
- the `TTask::ExecuteTasks` to execute for each task the list of its subtasks;

If the top level task is added to the list of ROOT browseable objects, the tree of tasks can be seen in the ROOT browser. To add it to the browser, get the list of browseable objects first and add it to the collection.

```
gROOT->GetListOfBrowsables()->Add(run);
```

The first parameter of the `Add` method is a pointer to a `TTask`, the second parameter is the string to show in the browser. If the string is left out, the name of the task is used.

After executing, the script above the browser will look like in this figure.

## 10.5 Execute and Debug Tasks

The browser can be used to start a task, set break points at the beginning of a task or when the task has completed. At a breakpoint, data structures generated by the execution up this point may be inspected asynchronously and then the execution can be resumed by selecting the “`Continue`” function of a task.

A task may be active or inactive (controlled by `TTask::SetActive`). When a task is inactive, its sub tasks are not executed. A task tree may be made persistent, saving the status of all the tasks.



# Chapter 11

## Input/Output

This chapter covers the saving and reading of objects to and from ROOT files. It begins with an explanation of the physical layout of a ROOT file. It includes a discussion on compression, and file recovery. Then we explain the logical file, the class `TFile` and its methods. We show how to navigate in a file, how to save objects and read them back. We also include a discussion on `Streamers`. `Streamers` are the methods responsible to capture an objects current state to save it to disk or send it over the network. At the end of the chapter is a discussion on the two specialized ROOT files: `TNetFile` and `TWebFile`.

### 11.1 The Physical Layout of ROOT Files

A ROOT file is like a UNIX file directory. It can contain directories and objects organized in unlimited number of levels. It also is stored in machine independent format (ASCII, IEEE floating point, Big Endian byte ordering). To look at the physical layout of a ROOT file, we first create one. This example creates a ROOT file and 15 histograms, fills each histogram with 1000 entries from a Gaussian distribution, and writes them to the file.

```
{
  char name[10], title[20];
  TObjArray Hlist(0);      // create an array of Histograms
  TH1F* h;                // create a pointer to a histogram
  // make and fill 15 histograms and add them to the object array
  for (Int_t i = 0; i < 15; i++) {
    sprintf(name,"h%d",i);
    sprintf(title,"histo nr:%d",i);
    h = new TH1F(name,title,100,-4,4);
    Hlist.Add(h);
    h->FillRandom("gaus",1000);
  }
  // open a file and write the array to the file
  TFile f("demo.root","recreate");
  Hlist->Write();
  f.Close();
}
```

The example begins with a call to the `TFile` constructor. This class is describing the ROOT file (that has the extension “.root”). In the next section, we will cover `TFile` in details. The last line of the example closes the file. To view its contents we need to open it again, and to create a `TBrowser` object by:

```
root[] TFile f("demo.root")
root[] TBrowser browser;
```

You can check if the file is correctly opened by:

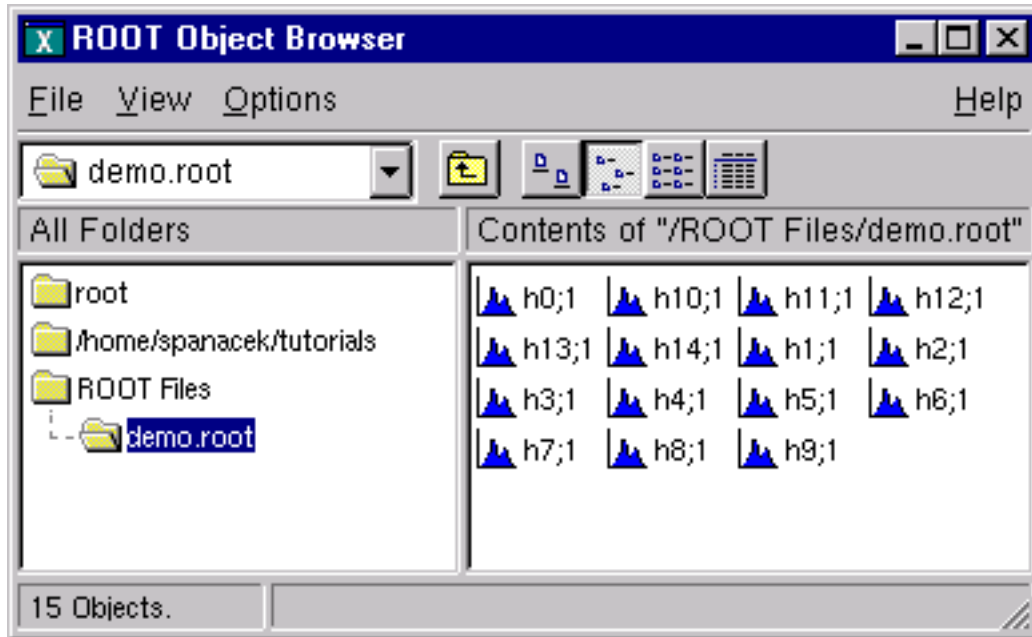

Figure 11.1: The browser with 15 created histograms

```

TFile f("demo.root");
if (f.IsZombie()) {
    cout << "Error opening file" << endl;
    exit(-1);
} else {
    ...
}

```

Once we have the `TFile` object, we can call the `TFile::Map()` method to view the physical layout. The output prints the date/time, the start record address, the number of bytes in the record, the class name of the record and the compression factor.

```

root[] f.Map()
20051208/124502 At:100 N=114 TFile
20051208/124502 At:214 N=413 TH1F CX = 2.35
20051208/124502 At:627 N=410 TH1F CX = 2.36
20051208/124502 At:1037 N=396 TH1F CX = 2.45
20051208/124502 At:1433 N=400 TH1F CX = 2.42
20051208/124502 At:1833 N=402 TH1F CX = 2.41
20051208/124502 At:2235 N=416 TH1F CX = 2.33
20051208/124502 At:2651 N=406 TH1F CX = 2.39
20051208/124502 At:3057 N=403 TH1F CX = 2.40
20051208/124502 At:3460 N=411 TH1F CX = 2.36
20051208/124502 At:3871 N=400 TH1F CX = 2.42
20051208/124502 At:4271 N=409 TH1F CX = 2.38
20051208/124502 At:4680 N=409 TH1F CX = 2.38
20051208/124502 At:5089 N=420 TH1F CX = 2.32
20051208/124502 At:5509 N=406 TH1F CX = 2.40
20051208/124502 At:5915 N=405 TH1F CX = 2.40
20051208/124503 At:6320 N=3052 StreamerInfo CX = 3.16
20051208/124503 At:9372 N=732 KeysList
20051208/124503 At:10104 N=53 FreeSegments
20051208/124503 At:10157 N=1 END

```

Here we see the fifteen histograms (`TH1F`'s) with the first one starting at byte 148. We also see an entry `TFile`. You may notice that the first entry starts at byte 100. The first 100 bytes are taken by the file header.

### 11.1.1 The File Header

This table shows the file header information. When `fVersion` is greater than 1000000, the file is a large file (> 2 GB) and the offsets will be 8 bytes long. The location in brackets are the location in the case of a large file.

Byte	Value Name	Description
1 -> 4	"root"	Root file identifier
5 -> 8	<code>fVersion</code>	File format version
9 -> 12	<code>fBEGIN</code>	Pointer to first data record
13 -> 16 [13->20]	<code>fEND</code>	Pointer to first free word at the EOF
17 -> 20 [21->28]	<code>fSeekFree</code>	Pointer to FREE data record
21 -> 24 [29->32]	<code>fNbytesFree</code>	Number of bytes in FREE data record
25 -> 28 [33->36]	<code>nfree</code>	Number of free data records
29 -> 32 [37->40]	<code>fNbytesName</code>	Number of bytes in <b>TNamed</b> at creation time
33 -> 33 [41->41]	<code>fUnits</code>	Number of bytes for file pointers
34 -> 37 [42->45]	<code>fCompress</code>	Zip compression level
34 -> 37 [46->53]	<code>fSeekInfo</code>	Pointer to <b>TStreamerInfo</b> record
34 -> 37 [54->57]	<code>fNBytesInfo</code>	Number of bytes in <b>TStreamerInfo</b> record
34 -> 37 [58->75]	<code>fCompress</code>	Universal Unique ID

The first four bytes of the file header contain the string "root" which identifies a file as a ROOT file. Because of this identifier, ROOT is not dependent on the ".root" extension. It is still a good idea to use the extension, just for us to recognize them easier. The `nfree` and value is the number of free records. This variable along with `FNBytesFree` keeps track of the free space in terms of records and bytes. This count also includes the deleted records, which are available again.

### 11.1.2 The Top Directory Description

The 84 bytes after the file header contain the top directory description, including the name, the date and time it was created, and the date and time of the last modification.

```
20010404/092347 At:64      N=84      TFile
```

### 11.1.3 The Histogram Records

What follows are the 15 histograms, in records of variable length.

```
20010404/092347 At:148      N=380      TH1F      CX = 2.49
20010404/092347 At:528      N=377      TH1F      CX = 2.51
```

The first 4 bytes of each record is an integer holding the number of bytes in this record. A negative number flags the record as deleted, and makes the space available for recycling in the next writing. The rest of bytes in the header contain all the information to identify uniquely a data block on the file. It is followed by the object data.

The next table explains the values in each individual record. If the key is located past the 32 bit file limit (> 2 GB) then some fields will be 8 bytes instead of 4 bytes (values between the brackets):

---

Byte	Value Name	Description
1 -> 4	Nbytes	Length of compressed object (in bytes)
5 -> 6	Version	<b>TKey</b> version identifier
7 -> 10	ObjLen	Length of uncompressed object
11 -> 14	Datetime	Date and time when object was written to file
15 -> 16	KeyLen	Length of the key structure (in bytes)
17 -> 18	Cycle	Cycle of key
19 -> 22 [19->26]	SeekKey	Pointer to record itself (consistency check)
23 -> 26 [27->34]	SeekPdir	Pointer to directory header
27 -> 27 [35->35]	lname	Number of bytes in the class name
28 -> ... [36->..	.]   ClassName	Object Class Name
... -> ...	lname	Number of bytes in the object name
... -> ...	Name	lname bytes with the name of the object
... -> ...	lTitle	Number of bytes in the object title
... -> ...	Title	Title of the object
... -> ...	DATA	Data bytes associated to the object

---

You see a reference to **TKey**. It is explained in detail in the next section.

### 11.1.4 The Class Description List (StreamerInfo List)

The histogram records are followed by the **StreamerInfo** list of class descriptions. The list contains the description of each class that has been written to file.

```
20010404/092347 At:5854 N=2390 StreamerInfo CX = 3.41
```

The class description is recursive, because to fully describe a class, its ancestors and object data members have to be described also. In `demo.root`, the class description list contains the description for:

- **TH1F**
- all classes in the **TH1F** inheritance tree
- all classes of the object data members
- all classes in the object data members' inheritance tree.

This description is implemented by the **TStreamerInfo** class, and is often referred to as simply **StreamerInfo**. You can print a file's **StreamerInfo** list with the `TFile::ShowStreamerInfo` method. Below is an example of the output. Only the first line of each class description is shown. The `demo.root` example contains only **TH1F** objects. Here we see the recursive nature of the class description; it contains the **StreamerInfo** of all the classes needed to describe **TH1F**.

```
root[] f.ShowStreamerInfo()
StreamerInfo for class: TH1F, version=1
  BASE      TH1          offset=0 type= 0 1-Dim histogram base class
  BASE      TArrayF      offset=0 type= 0 Array of floats

StreamerInfo for class: TH1, version=3
```

```

BASE      TNamed      offset=0 type=67 The basis for named object(name,title)
BASE      TAttLine   offset=0 type=0  Line attributes
BASE      TAttFill   offset=0 type=0  Fill area attributes
BASE      TAttMarker offset=0 type=0  Marker attributes
Int_t     fNcells    offset=0 type=3  number bins(1D),cells(2D)+U/Overflows
TAxis     fXaxis     offset=0 type=61 X axis descriptor
TAxis     fYaxis     offset=0 type=61 Y axis descriptor
TAxis     fZaxis     offset=0 type=61 Z axis descriptor
Short_t   fBarOffset offset=0 type=2  (1000*offset) for barcharts or legos
Short_t   fBarWidth  offset=0 type=2  (1000*width) for bar charts or legos
Stat_t    fEntries   offset=0 type=8  Number of entries//continued...
Stat_t    fTsumw     offset=0 type=8  Total Sum of weights
Stat_t    fTsumw2    offset=0 type=8  Total Sum of squares of weights
Stat_t    fTsumwx    offset=0 type=8  Total Sum of weight*X
Stat_t    fTsumwx2   offset=0 type=8  Total Sum of weight*X*X
Double_t  fMaximum   offset=0 type=8  Maximum value for plotting
Double_t  fMinimum   offset=0 type=8  Minimum value for plotting
Double_t  fNormFactor offset=0 type=8  Normalization factor
TArrayD   fContour   offset=0 type=62 Array to display contour levels
TArrayD   fSumw2     offset=0 type=62 Array of sum of squares of weights
TString   fOption    offset=0 type=65 histogram options
TList*    fFunctions offset=0 type=63 ->Pointer to list of functions(fits,user)

```

```

StreamerInfo for class: TNamed, version=1
...
StreamerInfo for class: TAttLine, version=1
...
StreamerInfo for class: TAttFill, version=1
...
StreamerInfo for class: TAttMarker, version=1
...
StreamerInfo for class: TArrayF, version=1
...
StreamerInfo for class: TArray, version=1
...
StreamerInfo for class: TAxis, version=6
...
StreamerInfo for class: TAttAxis, version=4
...

```

ROOT allows a class to have multiple versions, and each version has its own description in form of a `StreamerInfo`. Above you see the class name and version number. The `StreamerInfoList` has only one description for each class/version combination it encountered. The file can have multiple versions of the same class, for example objects of old and new versions of a class can be in the same file. The `StreamerInfos` is described in detail in the section on Streamers.

### 11.1.5 The List of Keys and the List of Free Blocks

The last three entries on the output of `TFile::Map()` are the list of keys, the list of free segments, and the address where the data ends.. When a file is closed, it writes a linked list of keys at the end of the file. This is what we see in the third to the last entry. In our example, the list of keys is stored in 732 bytes beginning at byte# 8244.

```

20010404/092347   At:8244      N=732      KeysList
20010404/092347   At:8976      N=53       FreeSegments
20010404/092347   At:9029      N=1        END

```

The second to last entry is a list of free segments. In our case, this starts 8976 and is not very long, only 53 bytes, since we have not deleted any objects. The last entry is the address of the last byte in the file.

### 11.1.6 File Recovery

A file may become corrupted or it may be impossible to write it to disk and close it properly. For example if the file is too large and exceeds the disk quota, or the job crashes or a batch job reaches its time limit before the file can be closed. In these cases, it is imperative to recover and retain as much information as possible. ROOT provides an intelligent and elegant file recovery mechanism using the redundant directory information in the record header.

If a file that has been not properly closed is opened again, it is scanned and rebuilt according to the information in the record header. The recovery algorithm reads the file and creates the saved objects in memory according to the header information. It then rebuilds the directory and file structure. If the file is opened in write mode, the recovery makes the correction on disk when the file is closed; however if the file is opened in read mode, the correction can not be written to disk. You can also explicitly invoke the recovery procedure by calling the `TFile::Recover()` method. You can recover the directory structure, but you cannot save what you recovered to the file on disk. In the following example, we interrupted and aborted the previous ROOT session, causing the file not to be closed. When we start a new session and attempt to open the file, it gives us an explanation and status on the recovery attempt.

```
root[] TFile f("demo.root")
Warning in <TFile::TFile>: file demo.root probably not closed, trying to recover successfully recovered 15 ke
```

## 11.2 The Logical ROOT File: TFile and TKey

We saw that the `TFile::Map()` method reads the file sequentially and prints information about each record while scanning the file. It is not feasible to support only sequential access and hence ROOT provides random or direct access, i.e. reading a specified object at a time. To do so, `TFile` keeps a list of **TKeys**, which is essentially an index to the objects in the file. The `TKey` class describes the record headers of objects in the file. For example, we can get the list of keys and print them. To find a specific object on the file we can use the `TFile::Get()` method.

```
root[] TFile f("demo.root")
root[] f.GetListOfKeys()->Print()
TKey Name = h0, Title = histo nr:0, Cycle = 1
TKey Name = h1, Title = histo nr:1, Cycle = 1
TKey Name = h2, Title = histo nr:2, Cycle = 1
TKey Name = h3, Title = histo nr:3, Cycle = 1
TKey Name = h4, Title = histo nr:4, Cycle = 1
TKey Name = h5, Title = histo nr:5, Cycle = 1
TKey Name = h6, Title = histo nr:6, Cycle = 1
TKey Name = h7, Title = histo nr:7, Cycle = 1
TKey Name = h8, Title = histo nr:8, Cycle = 1
TKey Name = h9, Title = histo nr:9, Cycle = 1
TKey Name = h10, Title = histo nr:10, Cycle = 1
TKey Name = h11, Title = histo nr:11, Cycle = 1
TKey Name = h12, Title = histo nr:12, Cycle = 1
TKey Name = h13, Title = histo nr:13, Cycle = 1
TKey Name = h14, Title = histo nr:14, Cycle = 1
root[] TH1F *h9 = (TH1F*)f.Get("h9");
```

The `TFile::Get()` finds the `TKey` object with name “h9”. Using the `TKey` info it will import in memory the object in the file at the file address #3352 (see the output from the `TFile::Map` above). This is done by the `Streamer` method that is covered in detail in a later section. Since the keys are available in a `TList` of **TKeys** we can iterate over the list of keys:

```
{
  TFile f("demo.root");
  TIter next(f.GetListOfKeys());
  TKey *key;
  while ((key=(TKey*)next())) {
    printf("key: %s points to an object of class: %s at %dn",
```

```

    key->GetName(),
    key->GetClassName(),key->GetSeekKey());
}
}

```

The output of this script is:

```

root[] .x iterate.C
key: h0 points to an object of class: TH1F at 150
key: h1 points to an object of class: TH1F at 503
key: h2 points to an object of class: TH1F at 854
key: h3 points to an object of class: TH1F at 1194
key: h4 points to an object of class: TH1F at 1539
key: h5 points to an object of class: TH1F at 1882
key: h6 points to an object of class: TH1F at 2240
key: h7 points to an object of class: TH1F at 2582
key: h8 points to an object of class: TH1F at 2937
key: h9 points to an object of class: TH1F at 3293
key: h10 points to an object of class: TH1F at 3639
key: h11 points to an object of class: TH1F at 3986
key: h12 points to an object of class: TH1F at 4339
key: h13 points to an object of class: TH1F at 4694
key: h14 points to an object of class: TH1F at 5038

```

In addition to the list of keys, **TFile** also keeps two other lists: **TFile::fFree** is a **TList** of free blocks used to recycle freed up space in the file. **ROOT** tries to find the best free block. If a free block matches the size of the new object to be stored, the object is written in the free block and this free block is deleted from the list. If not, the first free block bigger than the object is used. **TFile::fListHead** contains a sorted list (**TSortedList**) of objects in memory. The diagram below illustrates the logical view of the **TFile** and **TKey**.

### 11.2.1 Viewing the Logical File Contents

**TFile** is a descendent of **TDirectory**, which means it behaves like a **TDirectory**. We can list the contents, print the name, and create subdirectories. In a **ROOT** session, you are always in a directory and the directory you are in is called the current directory and is stored in the global variable **gDirectory**. Let us look at a more detailed example of a **ROOT** file and its role as the current directory. First, we create a **ROOT** file by executing a sample script.

```
root[] .x $ROOTSYS/tutorials/hsimple.C
```

Now you should have **hsimple.root** in your directory. The file was closed by the script so we have to open it again to work with it. We open the file with the intent to update it, and list its contents.

```

root[] TFile f ("hsimple.root","UPDATE")
root[] f.ls()
TFile** hsimple.root
TFile* hsimple.root
KEY: TH1F hpx;1 This is the px distribution
KEY: TH2F hpxpy;1 py vs px
KEY: TProfile hprof;1 Profile of pz versus px
KEY: TTuple ntuple;1 Demo tuple

```

It shows the two lines starting with **TFile** followed by four lines starting with the word “KEY”. The four keys tell us that there are four objects on disk in this file. The syntax of the listing is:

```
KEY: <class> <variable>;<cycle number> <title>
```

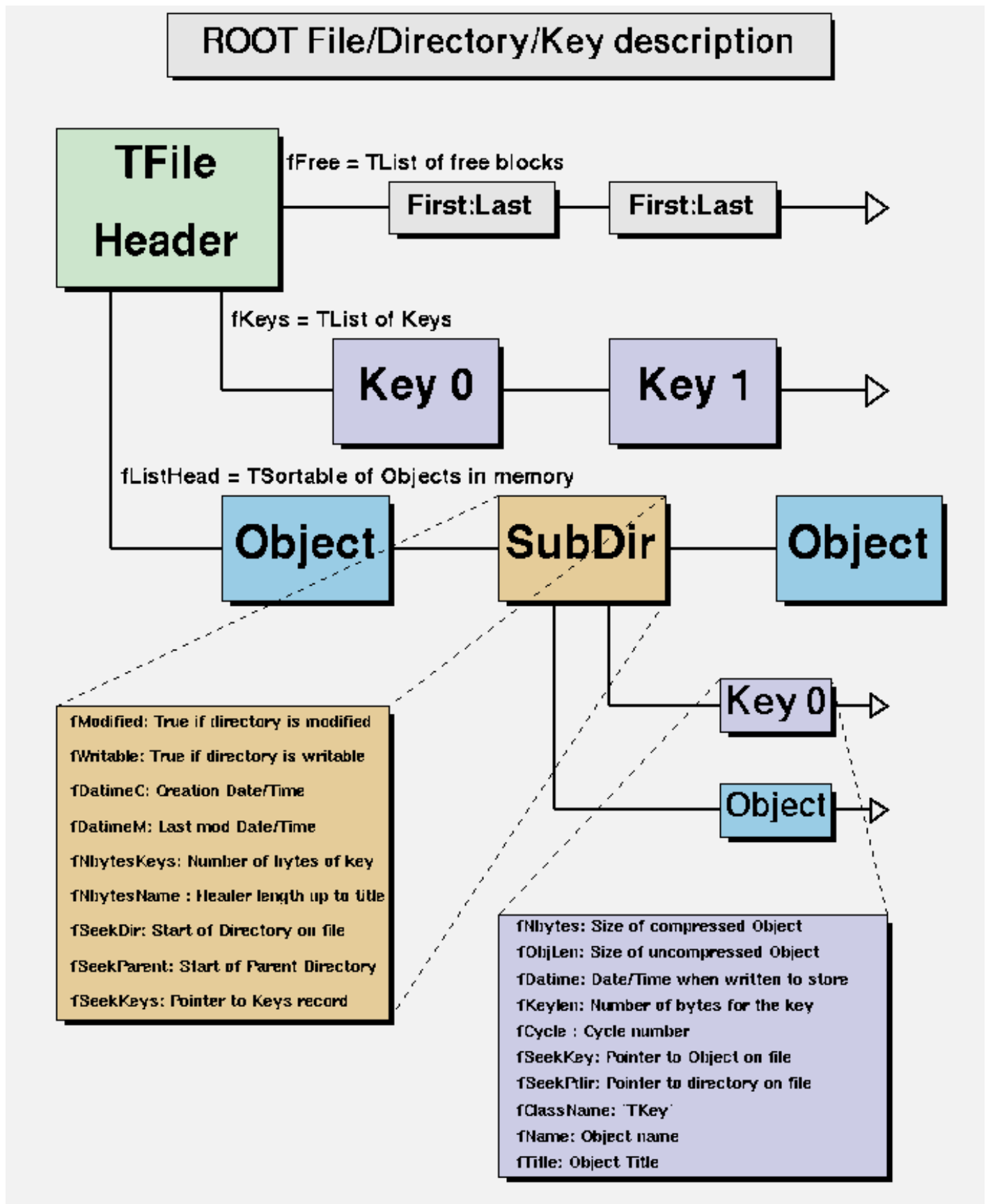

Figure 11.2: ROOT File/Directory/Key description



For example, the first line in the list means there is an object in the file on disk, called `hpx`. It is of the class `TH1F` (one-dimensional histogram of floating numbers). The object's title is "This is the `px` distribution". If the line starts with `OBJ`, the object is in memory. The `<class>` is the name of the ROOT class (T-something). The `<variable>` is the name of the object. The cycle number along with the variable name uniquely identifies the object. The `<title>` is the string given in the constructor of the object as title.

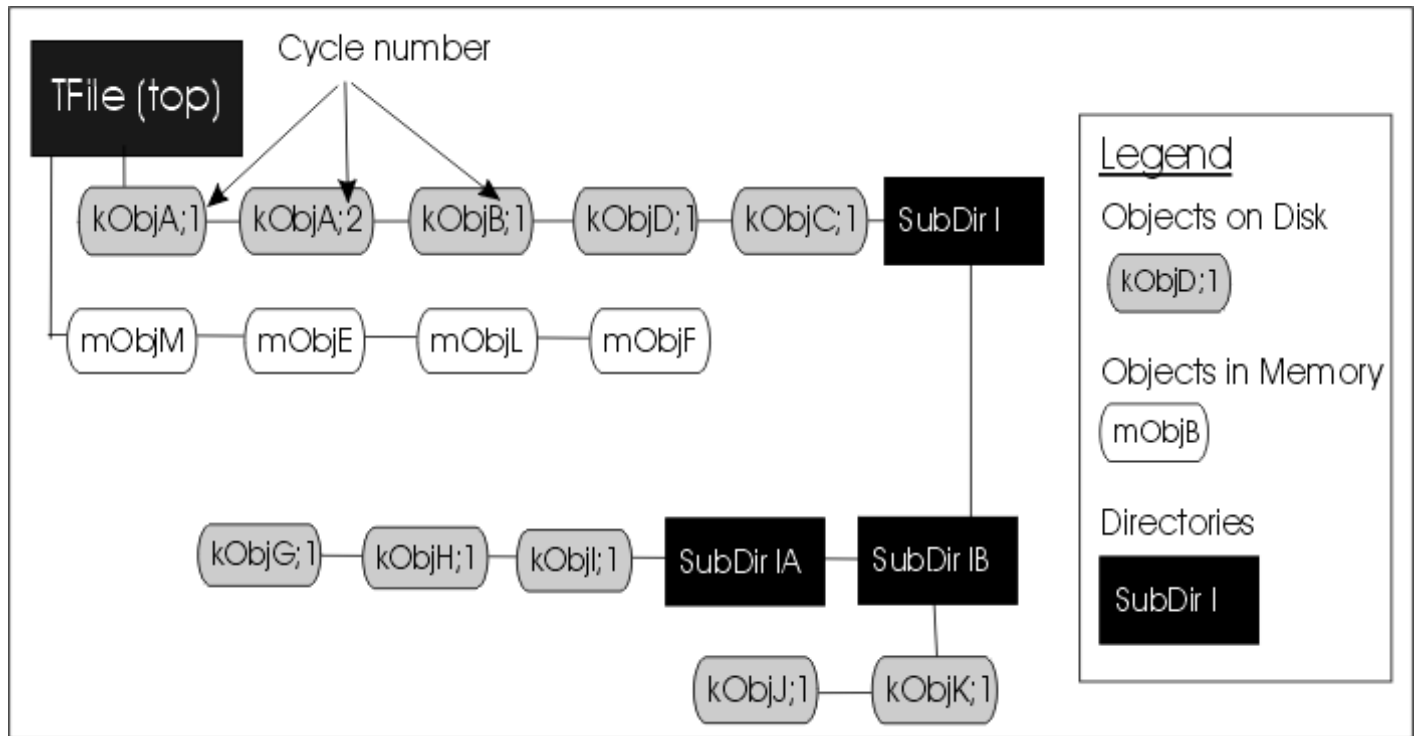

Figure 11.3: The structure of TFile

The figure shows a `TFile` with five objects in the top directory (`kObjA;1`, `kObjA;2`, `kObjB;1`, `kObjC;1` and `kObjD;1`). `ObjA` is on file twice with two different cycle numbers. It also shows four objects in memory (`mObjE`, `mObjF`, `mObjM`, `mObjL`). It also shows several subdirectories.

### 11.2.2 The Current Directory

When you create a `TFile` object, it becomes the current directory. Therefore, the last file to be opened is always the current directory. To check your current directory you can type:

```
root[] gDirectory->pwd()
Rint: /
```

This means that the current directory is the ROOT session (`Rint`). When you create a file, and repeat the command the file becomes the current directory.

```
root[] TFile f1("AFile1.root");
root[] gDirectory->pwd()
AFile1.root: /
```

If you create two files, the last becomes the current directory.

```
root[] TFile f2("AFile2.root");
root[] gDirectory->pwd()
AFile2.root: /
```

To switch back to the first file, or to switch to any file in general, you can use the `TDirectory::cd` method. The next command changes the current directory back to the first file.

```
root[] f1.cd();
root[] gDirectory->pwd()
AFile1.root: /
```

Note that even if you open the file in “READ” mode, it still becomes the current directory. CINT also offers a shortcut for `gDirectory->pwd()` and `gDirectory->ls()`, you can type:

```
root[] .pwd
AFile1.root: /
root[] .ls
TFile**      AFile1.root
TFile*       AFile1.root
```

To return to the home directory where we were before:

```
root[] gROOT->cd()
(unsigned char)1
root[] gROOT->pwd()
Rint: /
```

### 11.2.3 Objects in Memory and Objects on Disk

The `TFile::ls()` method has an option to list the objects on disk (“-d”) or the objects in memory (“-m”). If no option is given it lists both, first the objects in memory, then the objects on disk. For example:

```
root[] TFile *f = new TFile("hsimple.root");
root[] gDirectory->ls("-m")
TFile**      hsimple.root
TFile*       hsimple.root
```

Remember that `gDirectory` is the current directory and at this time is equivalent to “f”. This correctly states that no objects are in memory.

The next command lists the objects on disk in the current directory.

```
root[] gDirectory->ls("-d")
TFile**      hsimple.root
TFile*       hsimple.root
KEY: TH1F     hpx;1      This is the px distribution
KEY: TH2F     hpxpy;1    py vs px
KEY: TProfile hprof;1    Profile of pz versus px
KEY: TNtuple  ntuple;1   Demo ntuple
```

To bring an object from disk into memory, we have to use it or “Get” it explicitly. When we use the object, ROOT gets it for us. Any reference to `hprof` will read it from the file. For example drawing `hprof` will read it from the file and create an object in memory. Here we draw the profile histogram, and then we list the contents.

```
root[] hprof->Draw()
<TCanvas::MakeDefCanvas>: created default TCanvas with name c1
root[] f->ls()
TFile** hsimple.root
TFile*  hsimple.root
OBJ: TProfile hprof Profile of pz versus px : 0
```

```
KEY: TH1F hpx;1 This is the px distribution
KEY: TH2F hpxpy;1 py vs px
KEY: TProfile hprof;1 Profile of pz versus px
KEY: TNtuple ntuple;1 Demo ntuple
```

We now see a new line that starts with OBJ. This means that an object of class **TProfile**, called **hprof** has been added in memory to this directory. This new **hprof** in memory is independent from the **hprof** on disk. If we make changes to the **hprof** in memory, they are not propagated to the **hprof** on disk. A new version of **hprof** will be saved once we call **Write**.

You may wonder why **hprof** is added to the objects in the current directory. **hprof** is of the class **TProfile** that inherits from **TH1D**, which inherits from **TH1**. **TH1** is the basic histogram. All histograms and trees are created in the current directory (also see “Histograms and the Current Directory”). The reference to “all histograms” includes objects of any class descending directly or indirectly from **TH1**. Hence, our **TProfile** **hprof** is created in the current directory **f**. There was another side effect when we called the **TH1::Draw** method. **CINT** printed this statement:

```
<TCanvas::MakeDefCanvas>: created default TCanvas with name c1
```

It tells us that a **TCanvas** was created and it named it **c1**. This is where **ROOT** is being nice, and it creates a canvas for drawing the histogram if no canvas was named in the draw command, and if no active canvas exists. The newly created canvas, however, is **NOT** listed in the contents of the current directory. Why is that? The canvas is not added to the current directory, because by default **ONLY** histograms and trees are added to the object list of the current directory. Actually, **TEventList** objects are also added to the current directory, but at this time, we don’t have to worry about those. If the canvas is not in the current directory then where is it? Because it is a canvas, it was added to the list of canvases.

This list can be obtained by the command **gROOT->GetListOfCanvases()->ls()**. The **ls()** will print the contents of the list. In our list, we have one canvas called **c1**. It has a **TFrame**, a **TProfile**, and a **TPaveStats**.

```
root[] gROOT->GetListOfCanvases()->ls()
Canvas Name=c1 Title=c1
Option=TCanvas fXlowNDC=0 fYlowNDC=0 fWNDC=1 fHNDC=1
Name= c1 Title= c1
Option=TFrame X1= -4.000000 Y1=0.000000 X2=4.000000 Y2=19.384882
OBJ: TProfile hprof Profile of pz versus px : 0
TPaveText X1=-4.900000 Y1=20.475282 X2=-0.950000 Y2=21.686837 title
TPaveStats X1=2.800000 Y1=17.446395 X2=4.800000 Y2=21.323371 stats
```

Lets proceed with our example and draw one more histogram, and we see one more OBJ entry.

```
root[] hpx->Draw()
root[] f->ls()
TFile**          hsimple.root
TFile*           hsimple.root
OBJ: TProfile hprof Profile of pz versus px : 0
OBJ: TH1F hpx This is the px distribution : 0
KEY: TH1F hpx;1 This is the px distribution
KEY: TH2F hpxpy;1 py vs px
KEY: TProfile hprof;1 Profile of pz versus px
KEY: TNtuple ntuple;1 Demo ntuple
```

**TFile::ls()** loops over the list of objects in memory and the list of objects on disk. In both cases, it calls the **ls()** method of each object. The implementation of the **ls** method is specific to the class of the object, all of these objects are descendants of **TObject** and inherit the **TObject::ls()** implementation. The histogram classes are descendants of **TNamed** that in turn is a descent of **TObject**. In this case, **TNamed::ls()** is executed, and it prints the name of the class, and the name and title of the object. Each directory keeps a list of its objects in the memory. You can get this list by **TDirectory::GetList()**. To see the lists in memory contents you can do:

```
root[] f->GetList()->ls()
OBJ: TProfile hprof Profile of pz versus px : 0
OBJ: TH1F hpx This is the px distribution : 0
```

Since the file `f` is the current directory (`gDirectory`), this will yield the same result:

```
root[] gDirectory->GetList()->ls()
OBJ: TProfile  hprof  Profile of pz versus px : 0
OBJ: TH1F      hpx    This is the px distribution : 0
```

### 11.2.4 Saving Histograms to Disk

At this time, the objects in memory (OBJ) are identical to the objects on disk (KEY). Let's change that by adding a fill to the `hpx` we have in memory.

```
root[] hpx->Fill(0)
```

Now the `hpx` in memory is different from the histogram (`hpx`) on disk. Only one version of the object can be in memory, however, on disk we can store multiple versions of the object. The `TFile::Write` method will write the list of objects in the current directory to disk. It will add a new version of `hpx` and `hprof`.

```
root[] f->Write()
root[] f->ls()
TFile**      hsimple.root
TFile*       hsimple.root
OBJ: TProfile hprof  Profile of pz versus px : 0
OBJ: TH1F     hpx    This is the px distribution : 0
KEY: TH1F     hpx;2  This is the px distribution
KEY: TH1F     hpx;1  This is the px distribution
KEY: TH2F     hpxpy;1 py vs px
KEY: TProfile hprof;2 Profile of pz versus px
KEY: TProfile hprof;1 Profile of pz versus px
KEY: TTuple   ntuple;1      Demo ntuple
```

The `TFile::Write` method wrote the entire list of objects in the current directory to the file. You see that it added two new keys: `hpx;2` and `hprof;2` to the file. Unlike memory, a file is capable of storing multiple objects with the same name. Their cycle number, the number after the semicolon, differentiates objects on disk with the same name. If you wanted to save only `hpx` to the file, but not the entire list of objects, you could use the `TH1::Write` method of `hpx`:

```
root[] hpx->Write()
```

A call to `obj->Write` without any parameters will call `obj->GetName()` to find the name of the object and use it to create a key with the same name. You can specify a new name by giving it as a parameter to the `Write` method.

```
root[] hpx->Write("newName")
```

If you want to re-write the same object, with the same key, use the overwrite option.

```
root[] hpx->Write("", TObject::kOverwrite)
```

If you give a new name and use the `kOverwrite`, the object on disk with the matching name is overwritten if such an object exists. If not, a new object with the new name will be created.

```
root[] hpx->Write("newName", TObject::kOverwrite)
```

The `Write` method did not affect the objects in memory at all. However, if the file is closed, the directory is emptied and the objects on the list are deleted.

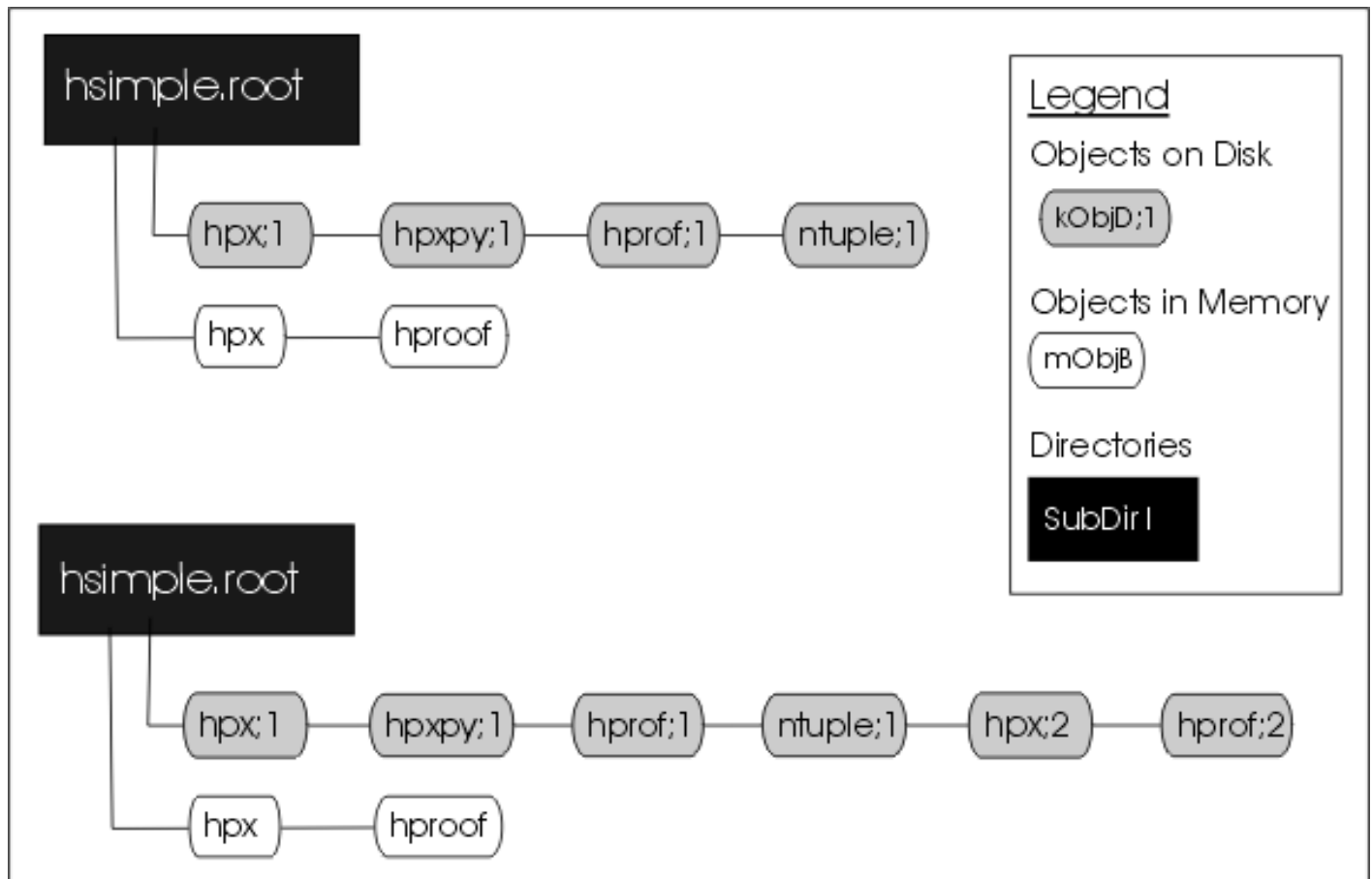
Figure 11.4: The file before and after the call to `Write`

```

root[] f->Close()
root[] f->ls()
TFile**    hsimple.root
TFile*     hsimple.root

```

In the code snippet above, you can see that the directory is now empty. If you followed along so far, you can see that `c1` which was displaying `hpx` is now blank. Furthermore, `hpx` no longer exists.

```

root[] hpx->Draw()
Error: No symbol hpx in current scope

```

This is important to remember, do not close the file until you are done with the objects or any attempt to reference the objects will fail.

### 11.2.5 Histograms and the Current Directory

When a histogram is created, it is added by default to the list of objects in the current directory. You can get the list of histograms in a directory and retrieve a pointer to a specific histogram.

```

TH1F *h = (TH1F*)gDirectory->Get("myHist"); // or
TH1F *h = (TH1F*)gDirectory->GetList()->FindObject("myHist");

```

The method `TDirectory::GetList()` returns a `TList` of objects in the directory. You can change the directory of a histogram with the `SetDirectory` method.

```
h->SetDirectory(newDir);
```

If the parameter is 0, the histogram is no longer associated with a directory.

```
h->SetDirectory(0);
```

Once a histogram is removed from the directory, it will no longer be deleted when the directory is closed. It is now your responsibility to delete this histogram object once you are finished with it. To change the default that automatically adds the histogram to the current directory, you can call the static function:

```
TH1::AddDirectory(kFALSE);
```

In this case, you will need to do all the bookkeeping for all the created histograms.

### 11.2.6 Saving Objects to Disk

In addition to histograms and trees, you can save any object in a ROOT file. For example to save a canvas to the ROOT file you can use either `TObject::Write()` or `TDirectory::WriteTObject()`. The example:

```
root[] c1->Write()
```

This is equivalent to:

```
root[] f->WriteTObject(c1)
```

For objects that do not inherit from `TObject` use:

```
root[] f->WriteObject(ptr,"nameofobject")
```

Another example:

```
root[] TFile *f = new TFile("hsimple.root","UPDATE")
root[] hpx->Draw()
<TCanvas::MakeDefCanvas>: created default TCanvas with name c1
root[] c1->Write()
root[] f->ls()
TFile**      hsimple.root
TFile*       hsimple.root
OBJ: TH1F    hpx      This is the px distribution : 0
KEY: TH1F    hpx;2    This is the px distribution
KEY: TH1F    hpx;1    This is the px distribution
KEY: TH2F    hpxpy;1  py vs px
KEY: TProfile hprof;2  Profile of pz versus px
KEY: TProfile hprof;1  Profile of pz versus px
KEY: TNtuple  ntuple;1 Demo ntuple
KEY: TCanvas  c1;1    c1
```

### 11.2.7 Saving Collections to Disk

All collection classes inherit from `TCollection` and hence inherit the `TCollection::Write()` method. When you call `TCollection::Write()` each object in the container is written individually into its own key in the file. To write all objects into one key you can specify the name of the key and use the option `TObject::kSingleKey`. For example:

```
root[] TList * list = new TList;
root[] TNamed * n1, * n2;
root[] n1 = new TNamed("name1","title1");
root[] n2 = new TNamed("name2","title2");
root[] list->Add(n1);
root[] list->Add(n2);
root[] gFile->WriteObject(list,"list",TObject::kSingleKey);
```

### 11.2.8 A TFile Object Going Out of Scope

There is another important point to remember about `TFile::Close` and `TFile::Write`. When a variable is declared on the stack in a function such as in the code below, it will be deleted when it goes out of scope.

```
void foo() {
    TFile f("AFile.root","RECREATE");
}
```

As soon as the function `foo` has finished executing, the variable `f` is deleted. When a `TFile` object is deleted an implicit call to `TFile::Close` is made. This will save only the file descriptor to disk. It contains the file header, the `StreamerInfo` list, the key list, the free segment list, and the end address. See “The Physical Layout of ROOT Files”. The `TFile::Close` does not make a call to `Write()`, which means that the objects in memory will not be saved in the file. You need to explicitly call `TFile::Write()` to save the object in memory to file before the exit of the function.

```
void foo() {
    TFile f("AFile.root","RECREATE");
    ... stuff ...
    f.Write();
}
```

To prevent an object in a function from being deleted when it goes out of scope, you can create it on the heap instead of on the stack. This will create a `TFile` object `f`, that is available on a global scope, and it will still be available when exiting the function.

```
void foo() {
    TFile *f = new TFile("AFile.root","RECREATE");
}
```

### 11.2.9 Retrieving Objects from Disk

If you have a ROOT session running, please quit and start fresh.

We saw that multiple versions of an object with the same name could be in a ROOT file. In our example, we saved a modified histogram `hpx` to the file, which resulted in two `hpx`'s uniquely identified by the cycle number: `hpx;1` and `hpx;2`. The question is how we can retrieve the right version of `hpx`. When opening the file and using `hpx`, CINT retrieves the one with the highest cycle number. To read the `hpx;1` into memory, rather than the `hpx;2` we would get by default, we have to explicitly get it and assign it to a variable.

```
root[] TFile *f1 = new TFile("hsimple.root")
root[] TH1F *hpx1; f1->GetObject("hpx;1",hpx)
root[] hpx1->Draw()
```

### 11.2.10 Subdirectories and Navigation

The `TDirectory` class lets you organize its contents into subdirectories, and `TFile` being a descendent of `TDirectory` inherits this ability. Here is an example of a ROOT file with multiple subdirectories as seen in the ROOT browser. To add a subdirectory to a file use `TDirectory::mkdir`. The example below opens the file for writing and creates a subdirectory called "Wed011003". Listing the contents of the file shows the new directory in the file and the `TDirectory` object in memory.

```
root[] TFile *f = new TFile("AFile.root","RECREATE")
root[] f->mkdir("Wed011003")
(class TDirectory*)0x1072b5c8

root[] f->ls()
TFile**      AFile.root
TFile*       AFile.root
TDirectory*  Wed011003      Wed011003
KEY: TDirectory  Wed011003;1  Wed011003
```

We can change the current directory by navigating into the subdirectory, and after changing directory; we can see that `gDirectory` is now "Wed011003".

```
root[] f->cd("Wed011003")
root[] gDirectory->pwd()
AFile.root:/Wed011003
```

In addition to `gDirectory` we have `gFile`, another global that points to the current file. In our example, `gDirectory` points to the subdirectory, and `gFile` points to the file (i.e. the files' top directory).

```
root[] gFile->pwd()
AFile.root:/
```

Use `cd()` without any arguments to return to the file's top directory.

```
root[] f->cd()
AFile.root:/
```

Change to the subdirectory again, and create a histogram. It is added to the current directory, which is the subdirectory "Wed011003".



```

root[] f->cd("Wed011003")
root[] TH1F *histo = new TH1F("histo","histo",10,0,10)
root[] gDirectory->ls()
TDirectory* Wed011003  Wed011003
OBJ: TH1F      histo  histo : 0

```

If you are in a subdirectory and you want to have a pointer to the file containing the subdirectory, you can do:

```
root[] gDirectory->GetFile()
```

If you are in the top directory *gDirectory\* is the same asgFile\**. We write the file to save the histogram on disk, to show you how to retrieve it later.

```

root[] f->Write()
root[] gDirectory->ls()
TDirectory*          Wed011003      Wed011003
OBJ: TH1F      histo  histo : 0
KEY: TH1F      histo;1 histo

```

When retrieving an object from a subdirectory, you can navigate to the subdirectory first or give it the path name relative to the file. The read object is created in memory in the current directory. In this first example, we get `histo` from the top directory and the object will be in the top directory.

```
root[] TH1 *h; f->GetObject("Wed011003/histo;1",h)
```

If file is written, a copy of `histo` will be in the top directory. This is an effective way to copy an object from one directory to another. In contrast, in the code box below, `histo` will be in memory in the subdirectory because we changed the current directory.

```

root[] f->cd("Wed011003")
root[] TH1 *h; gDirectory->GetObject("histo;1",h)

```

Note that there is no warning if the retrieving was not successful. You need to explicitly check the value of `h`, and if it is null, the object could not be found. For example, if you did not give the path name the histogram cannot be found and the pointer to `h` is null:

```

root[] TH1 *h; gDirectory->GetObject("Wed011003/histo;1",h)
root[] h
(class TH1*)0x10767de0
root[] TH1 *h; gDirectory->GetObject("histo;1",h)
root[] h
(class TH1*)0x0

```

To remove a subdirectory you need to use `TDirectory::Delete`. There is no `TDirectory::rmdir`. The `Delete` method takes a string containing the variable name and cycle number as a parameter.

```
void Delete(const char *namecycle)
```

The `namecycle` string has the format `name;cycle`. The next are some rules to remember:

- `name = *` means all, but don't remove the subdirectories
- `cycle = *` means all cycles (memory and file)
- `cycle = ""` means apply to a memory object

- `cycle = 9999` also means apply to a memory object
- `namecycle = ""` means the same as `namecycle = "T*"`
- `namecycle = T*` delete subdirectories

For example to delete a directory from a file, you must specify the directory cycle:

```
root[] f->Delete("Wed011003;1")
```

Some other examples of `namecycle` format are:

- `foo:delete` the object named `foo` from memory
- `foo;1`: delete the cycle 1 of the object named `foo` from the file
- `foo;*`: delete all cycles of `foo` from the file and also from memory
- `*;2`: delete all objects with cycle number 2 from the file
- `*;*`: delete all objects from memory and from the file
- `T;*`: delete all objects from memory and from the file including all subdirectories

## 11.3 Streamers

To follow the discussion on **Streamers**, you need to know what a *simple* data type is. A variable is of a simple data type if it cannot be decomposed into other types. Examples of simple data types are longs, shorts, floats, and chars. In contrast, a variable is of a *composite* data type if it can be decomposed. For example, classes, structures, and arrays are composite types. Simple types are also called primitive types, basic types, and CINT sometimes calls them fundamental types.

When we say, “writing an object to a file”, we actually mean writing the current values of the data members. The most common way to do this is to decompose (also called the serialization of) the object into its data members and write them to disk. The decomposition is the job of the **Streamer**. Every class with ambitions to be stored in a file has a **Streamer** that decomposes it and “streams” its members into a buffer.

The methods of the class are not written to the file, it contains only the persistent data members. To decompose the parent classes, the **Streamer** calls the **Streamer** of the parent classes. It moves up the inheritance tree until it reaches an ancestor without a parent. To serialize the object data members it calls their **Streamer**. They in turn move up their own inheritance tree and so forth. The simple data members are written to the buffer directly. Eventually the buffer contains all simple data members of all the classes that make up this particular object. Data members that are references (as `MyClass &fObj;`) are never saved, it is always the responsibility of the object’s constructor to set them properly.

### 11.3.1 Automatically Generated Streamers

A **Streamer** usually calls other **Streamers**: the **Streamer** of its parents and data members. This architecture depends on all classes having **Streamers**, because eventually they will be called. To ensure that a class has a **Streamer**, `rootcint` automatically creates one in the `ClassDef` macro that is defined in `$ROOTSYS/include/Rtypes.h`. `ClassDef` defines several methods for any class, and one of them is the **Streamer**. The automatically generated **Streamer** is complete and can be used as long as no customization is needed.

The `Event` class is defined in `$ROOTSYS/test/Event.h`. Looking at the class definition, we find that it inherits from `TObject`. It is a simple example of a class with diverse data members.

```
class Event : public TObject {
private:
    TDirectory    *fTransient;           ///! current directory
    Float_t      fPt;                   ///! transient value
    char         fType[20];
```

```

Int_t      fNtrack;
Int_t      fNseg;
Int_t      fNvertex;
UInt_t     fFlag;
Float_t    fTemperature;
EventHandler fEvtHdr;          //// don't split
TClonesArray *fTracks;        //->
TH1F       *fH;                //->
Int_t      fMeasures[10];
Float_t    fMatrix[4][4];
Float_t    *fClosestDistance; //[fNvertex]
...

```

The Event class is added to the CINT dictionary by the `rootcint` utility. This is the `rootcint` statement in the `$ROOTSYS/test/Makefile`:

```
@rootcint -f EventDict.cxx -c Event.h EventLinkDef.h
```

The `EventDict.cxx` file contains the automatically generated `Streamer` for Event:

```

void Event::Streamer(TBuffer &R_b){
    // Stream an object of class Event.
    if (R_b.IsReading()) {
        Event::Class()->ReadBuffer(R_b, this);
    } else {
        Event::Class()->WriteBuffer(R_b, this);
    }
}

```

When writing an Event object, `TClass::WriteBuffer` is called. `WriteBuffer` writes the current version number of the Event class, and its contents into the buffer `R_b`. The `Streamer` calls `TClass::ReadBuffer` when reading an Event object. The `ReadBuffer` method reads the information from buffer `R_b` into the Event object.

### 11.3.2 Transient Data Members (///*!*)

To prevent a data member from being written to the file, insert a “!” as the first character after the comment marks. It tells ROOT not to save that data member in a root file when saving the class. For example, in this version of Event, the `fPt` and `fTransient` data members are not persistent.

```

class Event : public TObject {
private:
    TDirectory *fTransient; ///! current directory
    Float_t fPt;           ///! transient value
    ...

```

### 11.3.3 The Pointer to Objects (///*->*)

The string “->” in the comment field of the members `*fH` and `*fTracks` instruct the automatic `Streamer` to assume these will point to valid objects and the `Streamer` of the objects can be called rather than the more expensive `R_b << fH`. It is important to note that no check is done on the validity of the pointer value. In particular if the pointer points, directly or indirectly, back to the current object, this will result in an infinite recursion and the abrupt end of the process.

```

TClonesArray *fTracks;        //->
TH1F         *fH;              //->

```

### 11.3.4 Variable Length Array

When the `Streamer` comes across a pointer to a simple type, it assumes it is an array. Somehow, it has to know how many elements are in the array to reserve enough space in the buffer and write out the appropriate number of elements. This is done in the class definition. For example:

```
class Event : public TObject {
private:
    char          fType[20];
    Int_t         fNtrack;
    Int_t         fNseg;
    Int_t         fNvertex;
    ...
    Float_t      *fClosestDistance;    //[fNvertex]
```

The array `fClosestDistance` is defined as a pointer of floating point numbers. A comment mark (`//`), and the number in square brackets tell the `Streamer` the length of the array for this object. In general the syntax is:

```
<simple type> *<name> //[<length>]
```

The length cannot be an expression. If a variable is used, it needs to be an integer data member of the class. It must be defined ahead of its use, or in a base class.

The same notation also applies to variable length array of object and variable length array of pointer to objects.

```
MyObject *obj; //[fNojbs]
MyObject **objs; //[fDatas]
```

### 11.3.5 Double32\_t

Math operations very often require double precision, but on saving single usually precision is sufficient. For this purpose we support the typedef `Double32_t` which is stored in memory as a double and on disk as a float or integer. The actual size of disk (before compression) is determined by the parameter next to the data member declaration. For example:

```
Double32_t m_data;    //[min,max,<nbits>]
```

If the comment is absent or does not contain `min`, `max`, `nbit`, the member is saved as a float.

If `min` and `max` are present, they are saved as a 32 bits precision. `min` and `max` can be explicit values or be expressions of values known to CINT (e.g. "pi").

If `nbits` is present, the member is saved as `int` with 'nbit'. For more details see the io tutorials `double32.C`.

### 11.3.6 Prevent Splitting ( `//||` )

If you want to prevent a data member from being split when writing it to a tree, append the characters `||` right after the comment string. This only makes sense for object data members. For example:

```
EventHeader    fEvtHdr;    /// do not split the header
```

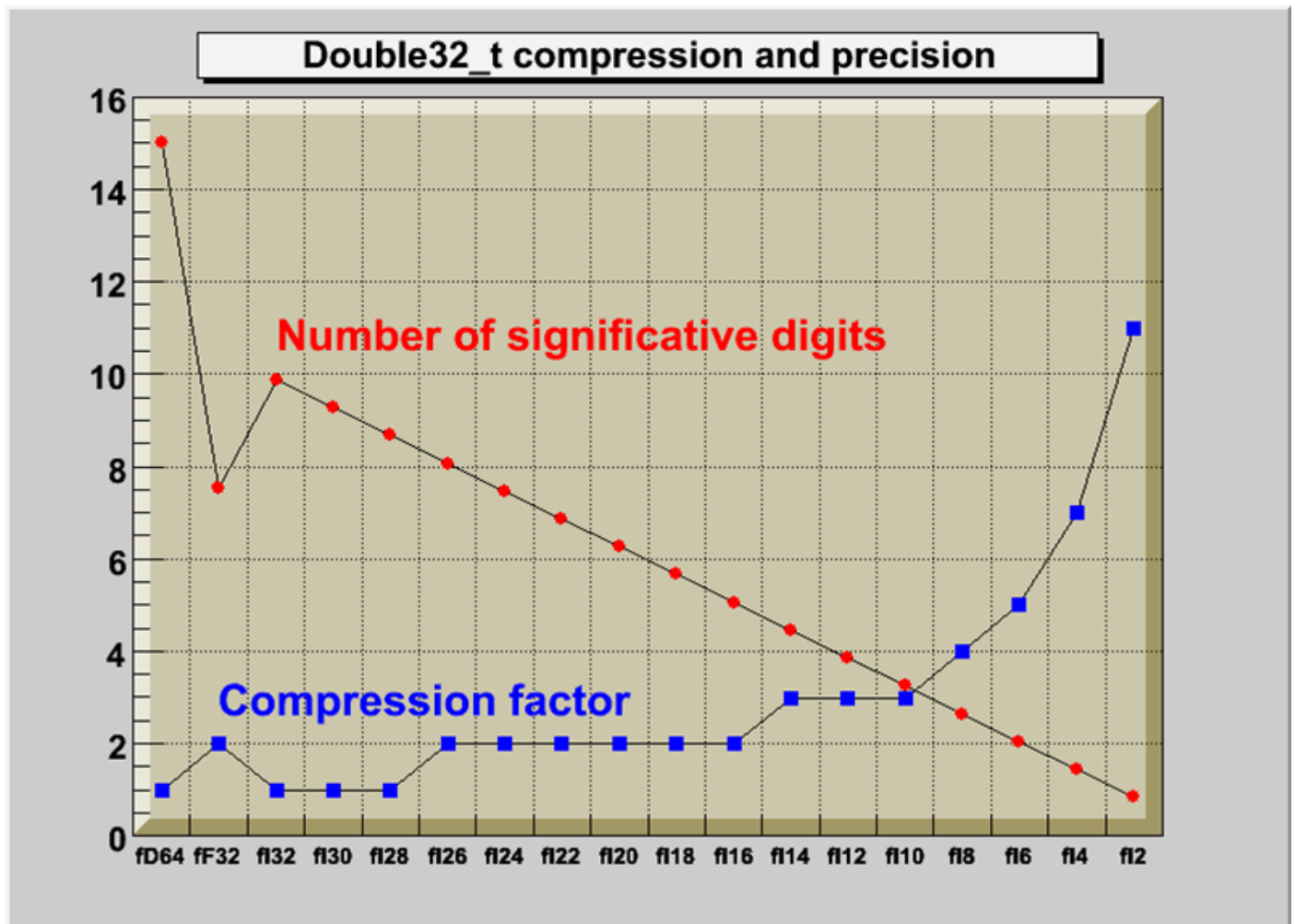

Figure 11.5: Compression and precision of Double32\_t

### 11.3.7 Streamers with Special Additions

Most of the time you can let `rootcint` generate a `Streamer` for you. However if you want to write your own `Streamer` you can do so. For some classes, it may be necessary to execute some code before or after the read or write block in the automatic `Streamer`. For example after the execution of the read block, one can initialize some non persistent members. There are two reasons why you would need to write your own `Streamer`: 1) if you have a non-persistent data member that you want to initialize to a value depending on the read data members; 2) if you want or need to handle the schema evolution on your own. In addition, the automatic `Streamer` does not support C-structures. It is best to convert the structure to a class definition.

First, you need to tell `rootcint` not to build a `Streamer` for you. The input to the `rootcint` command (in the `makefile`) is a list of classes in a `LinkDef.h` file. For example, the list of classes for `Event` is listed in `$ROOTSYS/test/EventLinkDef.h`. The “-” at the end of the class name tells `rootcint` not to generate a `Streamer`. In the example, you can see the `Event` class is the only one for which `rootcint` is instructed not to generate a `Streamer`.

```
#ifndef __CINT__

#pragma link off all globals;
#pragma link off all classes;
#pragma link off all functions;
#pragma link C++ class EventHeader+;
#pragma link C++ class Event-;
#pragma link C++ class HistogramManager+;
#pragma link C++ class Track+;

#endif
#pragma link C++ class EventHeader+;
```

The “+” sign tells `rootcint` to use the new `Streamers` system introduced in ROOT 3.0. The following is an example of a customized `Streamer` for `Event`. The `Streamer` takes a `TBuffer` as a parameter, and first checks to see if this is a case of reading or writing the buffer.

```
void Event::Streamer(TBuffer &R_b) {
    if (R_b.IsReading()) {
        Event::Class()->ReadBuffer(R_b, this);
        fTransient = gDirectory; //save current directory
        fPt= TMath::Sqrt(fPx*fPx + fPy*fPy + fPz*fPz);
    } else {
        Event::Class()->WriteBuffer(R_b, this);
    }
}
```

### 11.3.8 Writing Objects

The `Streamer` decomposes the objects into data members and writes them to a buffer. It does not write the buffer to a file, it simply populates a buffer with bytes representing the object. This allows us to write the buffer to a file or do anything else we could do with the buffer. For example, we can write it to a socket to send it over the network. This is beyond the scope of this chapter, but it is worthwhile to emphasize the need and advantage of separating the creation of the buffer from its use. Let us look how a buffer is written to a file. The dictionary for a class needs to be loaded before any object of that type can be saved.

The `TObject::Write` method does the following:

- Creates a `TKey` object in the current directory
- Creates a `TBuffer` object which is part of the newly created `TKey`
- Fills the `TBuffer` with a call to the `class::Streamer` method

- Creates a second buffer for compression, if needed
- Reserves space by scanning the **TFree** list. At this point, the size of the buffer is known.
- Writes the buffer to the file
- Releases the **TBuffer** part of the key

In other words, the `TObject::Write` calls the `Streamer` method of the class to build the buffer. The buffer is in the key and the key is written to disk. Once written to disk the memory consumed by the buffer part is released. The key part of the `TKey` is kept.

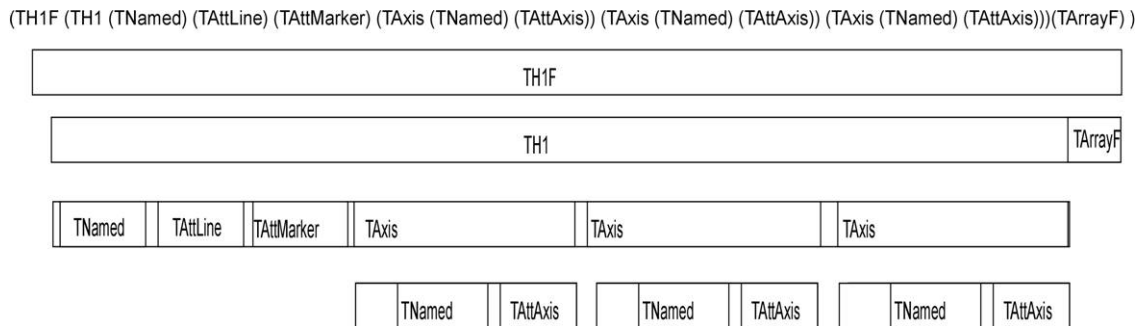

Figure 11.6: A diagram of a streamed TH1F in the buffer

The key consumes about 60 bytes, whereas the buffer, since it contains the object data, can be very large.

### 11.3.9 Ignore Object Streamers

Your class can ignore the `TObject` Streamer with the `MyClass->Class::IgnoreObjectStreamer()` method. When the class `kIgnoreTObjectStreamerbit` is set (by calling the `IgnoreTObjectStreamer` method), the automatically generated `Streamer` will not call `TObject::Streamer`, and the `TObject` part of the class is not streamed to the file. This is useful in case you do not use the `TObject` `fBits` and `fUniqueID` data members. You gain space on the file, and you do not lose functionality if you do not use the `fBits` and `fUniqueID`. See “The Role of `TObject`” on the use of `fBits` and `fUniqueID`.

### 11.3.10 Streaming a `TClonesArray`

When writing a `TClonesArray` it bypasses by default the `Streamer` of the member class and uses a more efficient internal mechanism to write the members to the file. You can override the default and specify that the member class `Streamer` is used by setting the `TClonesArray::BypassStreamer` bit to false:

```

TClonesArray *fTracks;
fTracks->BypassStreamer(kFALSE);    // use the member Streamer

```

When the `kBypassStreamer` bit is set, the automatically generated `Streamer` can call directly the method `TClass::WriteBuffer`. Bypassing the `Streamer` improves the performance when writing/reading the objects in the `TClonesArray`. However, the drawback is when a `TClonesArray` is written with `split=0` bypassing the `Streamer`, the `StreamerInfo` of the class in the array being optimized, one cannot later use the `TClonesArray` with `split > 0`. For example, there is a problem with the following scenario: a class `Foo` has a `TClonesArray` of `Bar` objects the `Foo` object is written with `split=0` to `Tree T1`. In this case the `StreamerInfo` for the class `Bar` is created in optimized mode in such a way that data members of the same type are written as an array improving the I/O performance. In a new program, `T1` is read and a new `Tree T2` is created with the object `Foo` in `split > 1`.

When the `T2` branch is created, the `StreamerInfo` for the class `Bar` is created with no optimization (mandatory for the `split` mode). The optimized `Bar` `StreamerInfo` is going to be used to read the `TClonesArray` in `T1`. The result will be `Bar` objects with data member values not in the right sequence. The solution to this problem is to call `BypassStreamer(kFALSE)` for the `TClonesArray`. In this case, the normal `Bar::Streamer` function will be called. The `Bar::Streamer` function works OK independently if the `Bar` `StreamerInfo` had been generated in optimized mode or not.

## 11.4 Pointers and References in Persistency

An object pointer as a data member presents a challenge to the streaming software. If the object pointed to is saved every time, it could create circular dependencies and consume a large amount of disk space. The network of references must be preserved on disk and recreated upon reading the file.

If you use independent I/O operations for pointers and their referenced objects you can use the **TRef** class. Later in this section is an example that compares disk space, memory usage, and I/O times of C++ pointers and **TRefs**. In general, a **TRef** is faster than C++ but the advantage of a C++ pointer is that it is already C++.

### 11.4.1 Streaming C++ Pointers

When ROOT encounters a pointer data member it calls the **Streamer** of the object and labels it with a unique object identifier. The object identifier is unique for one I/O operation. If there is another pointer to the object in the same I/O operation, the first object is referenced i.e. it is not saved again. When reading the file, the object is rebuilt and the references recalculated.

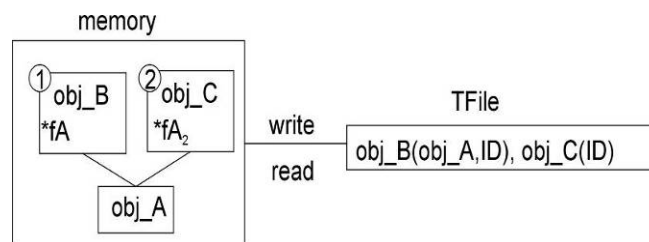

Figure 11.7: Streaming object pointers

In this way, the network of pointers and their objects is rebuilt and ready to use the same way it was used before it was persistent. If the pointer hold the address of an object which is embedded in another object (as opposed to being pointed to by a pointer), the object will be duplicate at read time. To avoid this, make the pointer a transient data member.

### 11.4.2 Motivation for the TRef Class

If the object is split into several files or into several branches of one or more **Ttrees**, standard C++ pointers cannot be used because each I/O operation will write the referenced objects, and multiple copies will exist. In addition, if the pointer is read before the referenced object, it is null and may cause a run time system error. To address these limitations, ROOT offers the **TRef** class.

**TRef** allows referencing an object in a different branch and/or in a different file. **TRef** also supports the complex situation where a **Tfile** is updated multiple times on the same machine or a different machine. When a **TRef** is read before its referenced object, it is null. As soon as the referenced object is read, the **TRef** points to it. In addition, one can specify an action to be taken by **TRef** in the case it is read before its reference object (see “Action on Demand” below).

### 11.4.3 Using TRef

A **TRef** is a lightweight object pointing to any **TObject**. This object can be used instead of normal C++ pointers in case:

- The referenced object R and the pointer P are not written to the same file
- P is read before R
- R and P are written to different Tree branches

Below is a line from the example in `$ROOTSYS/test/Event.cxx`.



```

TRef  fLastTrack;           //pointer to last track
...
Track *track = (Track*)fTracks->ConstructedAt(fNtrack++);
track->Set(random);
// Save reference to last Track in the collection of Tracks
fLastTrack = track;

```

The `track` and its reference `fLastTrack` can be written with two separate I/O calls in the same or in different files, in the same or in different branches of a `TTree`. If the `TRef` is read and the referenced object has not yet been read, `TRef` will return a null pointer. As soon as the referenced object will be read, `TRef` will point to it.

#### 11.4.4 How Does It Work?

A `TRef` is itself a `TObject` with an additional transient pointer `fPID`. When a `TRef` is used to point to a `TObject*R`, for example in a class with

```
TRef  P;
```

one can do:

```
P = R;    //to set the pointer
```

When the statement `P = R` is executed, the following happens:

- The pointer `fPID` is set to the current `TProcessID` (see below).
- The current `ObjectNumber` (see below) is incremented by one.
- `R.fUniqueID` is set to `ObjectNumber`.
- In the `fPID` object, the element `fObjects[ObjectNumber]` is set to `R`
- `P.fUniqueID` is also set to `ObjectNumber`.

After having set `P`, one can immediately return the value of `R` using `P.GetObject()`. This function returns the `fObjects[fUniqueID]` from the `fPID` object.

When the `TRef` is written, the process id number `pidf` of `fPID` is written in addition to the `TObject` part of the `TRef` (`fBits,fUniqueID`). When the `TRef` is read, its pointer `fPID` is set to the value stored in the `TObjArray` of `TFile::fProcessIDs(fProcessIDs[pidf])`.

When a referenced object is written, `TObject::Streamer` writes the `pidf` in addition to the standard `fBits` and `fUniqueID`. When `TObject::Streamer` reads a reference object, the `pidf` is read. At this point, the referenced object is entered into the table of objects of the `TProcessID` corresponding to `pidf`.

WARNING: If `MyClass` is the class of the referenced object, The `TObject` part of `MyClass` must be streamed. One should not call `MyClass::Class()->IgnoreTObjectStreamer()`.

##### 11.4.4.1 TProcessID and TUUID

A `TProcessID` uniquely identifies a ROOT job. The `TProcessID` title consists of a `TUUID` object, which provides a globally unique identifier. The `TUUID` class implements the UUID (Universally Unique Identifier), also known as GUID (Globally Unique Identifier). A UUID is 128 bits long, and if generated according to this algorithm, is either guaranteed to be different from all other UUID generated until 3400 A.D. or extremely likely to be different.

The `TROOT` constructor automatically creates a `TProcessID`. When a `TFile` contains referenced objects, the `TProcessID` object is written to the file. If a file has been written in multiple sessions (same machine or not), a `TProcessID` is written for each session. The `TProcessID` objects are used by `TRef` to uniquely identify the referenced `TObject`.

When a referenced object is read from a file (its bit `kIsReferenced` is set), this object is entered into the objects table of the corresponding `TProcessID`. Each `TFile` has a list of `TProcessIDs` (see `TFile::fProcessIDs`) also accessible from `TProcessID::fgPIDs` (for all files). When this object is deleted, it is removed from the table via the cleanup mechanism invoked by the `**TObject**` destructor. Each `**TProcessID**` has a table (`TObjArray *fObjects`) that keeps track of all referenced objects. If a referenced object has `afUniqueID`, a pointer to this unique object may be found using `fObjects->At(fUniqueID)`. In the same way, when a `**TRef::GetObject**` is called, `GetObject` uses its own `fUniqueID` to find the pointer to the referenced object. See `TProcessID::GetObjectWithIDandPutObjectWithID`.

#### 11.4.4.2 Object Number

When an object is referenced, a unique identifier is computed and stored in both the `fUniqueID` of the referenced and referencing object. This `uniqueID` is computed by incrementing by one the static global in `TProcessID::fgNumber`. The `fUniqueID` is the serial object number in the current session. One can retrieve the current `fgNumber` value by calling the static function `TProcessID::GetObjectCount` at any time or can set this number by `TProcessID::SetObjectCount`. To avoid a growing table of `fObjects` in `TProcessID`, in case, for example, one processes many events in a loop, it might be necessary to reset the object number at the end of processing of one event. See an example in `$ROOTSYS/test/Event.cxx` (look at function `Build`). The value of `ObjectNumber` may be saved at the beginning of one event and reset to this original value at the end of the event. These actions may be nested.

```
    saveNumber = TProcessID::GetObjectCount();
    ...
    TProcessID::SetObjectCount(savedNumber);
```

#### 11.4.5 Action on Demand

The normal behavior of a `TRef` has been described above. In addition, `TRef` supports “Actions on Demand”. It may happen that the referenced object is not yet in the memory, on a separate file or not yet computed. In this case, `TRef` is able to execute automatically an action:

- Call to a compiled function (static function of member function)
- Call to an interpreted function
- Execution of a CINT script

##### 11.4.5.1 How to Select This Option?

In the definition of the `TRef` data member in the original class, do:

```
TRef fRef;    //EXEC:execName points to something
```

When the special keyword “EXEC:” is found in the comment field of the member, the next string is assumed to be the name of a `TExec` object. When a file is connected, the dictionary of the classes on the file is read in memory (see `TFile::ReadStreamInfo`). When the `TStreamerElement` object is read, a `TExec` object is automatically created with the name specified after the keyword “EXEC:” in case a `TExec` with a same name does not already exist.

The action to be executed via `this TExec` can be specified with:

- A call to the `TExec` constructor, if the constructor is called before
- Opening the file.
- A call to `TExec::SetAction` at any time.

One can compute a pointer to an existing `TExec` with a name with:

```
TExec *myExec = gROOT->GetExec(execName);
myExec->SetAction(actionCommand);
```

The parameter `actionCommand` is a string containing a CINT instruction. Examples:

```
myExec->SetAction("LoadHits()");
myExec->SetAction(".x script.C");
```

When a `TRef` is de-referenced via `TRef::GetObject`, its `TExec` *is automatically executed*. The `TExec` function/script can do one or more of the following:

- Load a file containing the referenced object. This function typically looks in the file catalog.
- Compute a pointer to the referenced object and communicate this pointer back to the calling function `TRef::SetObject` via:

```
TRef::SetObject(object)
```

As soon as an object is returned to `GetObject`, the `fUniqueID` of the `TRef` is set to the `fUniqueID` of the referenced object. At the next call to `GetObject`, the pointer stored in `fPid:fObjects[fUniqueID]` will be returned directly. An example of action on demand is in `$ROOTSYS/test/Event.h`:

```
TRef    fWebHistogram;          //EXEC:GetWebHistogram
```

When calling `fWebHistogram.GetObject()`, the function `GetObject` will automatically invoke the script `GetWebHistogram.C` via the interpreter. An example of a `GetWebHistogram.C` script is shown below:

```
void GetWebHistogram() {
  TFile *f=TFile::Open("http://root.cern.ch/files/pippa.root");
  f->cd("DM/CJ");
  TH1 *h6 = (TH1*)gDirectory->Get("h6");
  h6->SetDirectory(0);
  delete f;
  TRef::SetObject(h6);
}
```

In the above example, a call to `fWebHistogram.GetObject()` executes the script with the function `GetWebHistogram`. This script connects a file with histograms: `pippa.root` on the ROOT Web site and returns the object `h6` to `TRef::GetObject`.

```
TRef    fWebHistogram;          //EXEC:GetWebHistogram()
```

Note that if the definition of the `TRef fWebHistogram` had been changed the compiled or interpreted function `GetWebHistogram()` would have been called instead of the CINT script `GetWebHistogram.C`.

### 11.4.6 Array of TRef

When storing multiple `TRefs`, it is more efficient to use a `TRefArray`. The efficiency is due to having a single pointer `fPID` for all `TRefs` in the array. It has a dynamic compact table of `fUniqueIDs`. We recommend that you use a `TRefArray` rather than a collection of `TRefs`.

Example:

- Suppose a `TObjArray *mytracks` containing a list of `Track` objects.
- Suppose a `TRefArray *pions` containing pointers to the pion tracks in `mytracks`. This list is created with statements like: `pions->Add(track)`;
- Suppose a `TRefArray *muons` containing pointers to the muon tracks in `mytracks`.

The 3 arrays `mytracks`, `pions` and `muons` may be written separately.

## 11.5 Schema Evolution

Schema evolution is a problem faced by long-lived data. When a schema changes, existing persistent data can become inaccessible unless the system provides a mechanism to access data created with previous versions of the schema. In the lifetime of collaboration, the class definitions (i.e. the schema) are likely to change frequently. Not only can the class itself change, but any of its parent classes or data member classes can change also. This makes the support for schema evolution necessary.

ROOT fully supports schema evolution. The next figure below illustrates some of the scenarios.

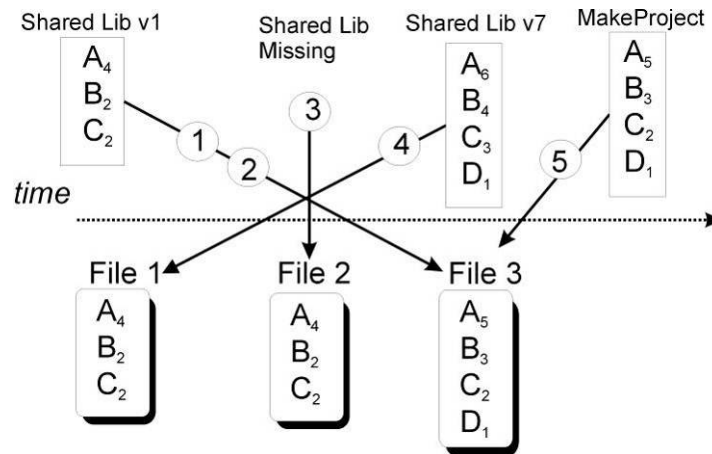

Figure 11.8: The ROOT schema evolution

The top half represents different versions of the shared library with the class definitions. These are the in-memory class versions. The bottom half represents data files that contain different versions of the classes.

- An old version of a shared library and a file with new class definitions - this can be the case when someone has not updated the library and is reading a new file.
- Reading a file with a shared library that is missing a class definition (i.e. missing class D).
- Reading a file without any class definitions. This can be the case where the class definition is lost, or unavailable.
- The current version of a shared library and an old file with old class versions (backward compatibility). This is often the case when reading old data.
- Reading a file with a shared library built with `MakeProject`. This is the case when someone has already read the data without a shared library and has used ROOT `MakeProject` feature to reconstruct the class definitions and shared library (`MakeProject` is explained in detail later on).

In case of a mismatch between the in-memory version and the persistent version of a class, ROOT maps the persistent one to the one in memory. This allows you to change the class definition at will, for example:

- Change the order of data members in the class.
- Add new data members. By default, the value of the missing member will be 0 or in case of an object it will be set to null.
- Remove data members.
- Move a data member to a base class or vice-versa.
- Change the type of a member if it is a simple type or a pointer to a simple type. If a loss of precision occurs, a warning is given.
- Add or remove a base class

ROOT supports schema evolution by keeping a class description of each version of the class that was ever written to disk, with the class. When it writes an object to file, it also writes the description of the current class version along with it. This description is implemented in the `StreamerInfo` class.

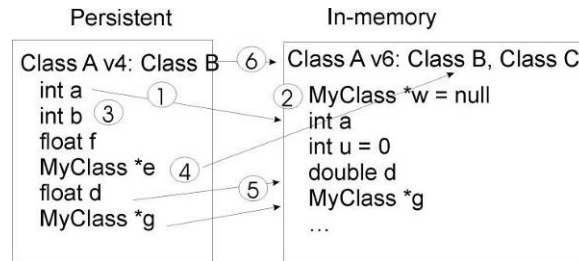

Figure 11.9: The schema evolution for objects written on disk and in memory

### 11.5.1 The TStreamerInfo Class

Each class has a list of `StreamerInfo` objects, one for each version of the class if that version was written to disk at least once. When reading an object from a file, the system uses the `StreamerInfo` list to decode an object into the current version. The `StreamerInfo` is made up of `TStreamerElements`. Each describes one persistent data member of the class. By default, all data members of a class are persistent. To exclude a data member (i.e. make it not persistent), add a “!” after the comment marks. For example the pointer `*fPainter` of a `TH1` is not persistent:

```
TVirtualHistPainter* fPainter ///pointer to histogram painter
```

### 11.5.2 The TStreamerElement Class

A `TStreamerElement` describes a data member of a simple type, object, array, pointer, or container. The offset in the `TStreamerElement` is the starting address of the data for that data member.

```
BASE   TNamed      offset=  0 type=67 The basis for a named object
BASE   TAttLine   offset= 28 type=  0 Line attributes
```

In this example, the `TNamed` data starts at byte 0, and `TAttLine` starts at byte 28. The offset is machine and compiler dependent and is computed when the `StreamerInfo` is analyzed. The types are defined in the file `TStreamerInfo.h` and listed here:

```
enum EReadWrite {
kBase=0,   kChar=1,kShort=2,kInt=3,kLong=4,
kFloat=5,   kCounter=6,kCharStar=7, kDouble=8,kUChar=11,
kUShort=12,   kUInt=13,kULong=14,kBits=15,kOffsetL=20,
kOffsetP=40, kObject=61,kAny=62,kObjectp=63,kObjectP=64,
kTString=65, kTObject=66,kTNamed=67,kSkip=100,kSkipL=120,
kSkipP=140,  kConv=200,   kConvL=220,kConvP=240,kStreamer=500,
kStreamLoop=501,  kMissing=99999
};
```

The method `TClass::GetStreamerInfo` analyzes the `StreamerInfo` the same way it would be analyzed by referring to the class. While analyzing the `StreamerInfo`, it computes the offsets. The type field is the type of the `TStreamerElement`. It is specific to the `StreamerInfo` definition.

### 11.5.3 Example: TH1 StreamerInfo

In the `StreamerInfo` of the `TH1` class we see the four base classes: `TNamed`, `TAttLine`, `TAttFill`, and `TAttMarker`. These are followed by a list of the data members. Each data member is implemented by a `TStreamerElement` object.

```
root[] TH1::Class()->GetStreamerInfo()->ls()
StreamerInfo for class: TH1, version=3
BASE   TNamed  offset=  0 type=67 The basis for a named object
```

```

BASE    TAttLine    offset= 28 type= 0 Line attributes
BASE    TAttFill   offset= 40 type= 0 Fill area attributes
BASE    TAttMarker offset= 48 type= 0 Marker attributes
Int_t   fNcells   offset= 60 type= 3 number of bins(1D)
TAxis   fXaxis    offset= 64 type=61 X axis descriptor
TAxis   fYaxis    offset=192 type=61 Y axis descriptor
TAxis   fZaxis    offset=320 type=61 Z axis descriptor
Short_t fBarOffset offset=448 type= 2(1000*offset)for bar charts or legos
Short_t fBarWidth  offset=450 type= 2 (1000*width)for bar charts or legos
Stat_t  fEntries   offset=452 type= 8 Number of entries
Stat_t  fTsumw     offset=460 type= 8 Total Sum of weights
Stat_t  fTsumw2    offset=468 type= 8 Total Sum of squares of weights
Stat_t  fTsumwx    offset=476 type= 8 Total Sum of weight*X
Stat_t  fTsumwx2   offset=484 type= 8 Total Sum of weight*X*X
Double_t fMaximum  offset=492 type= 8 Maximum value for plotting
Double_t fMinimum  offset=500 type= 8 Minimum value for plotting
Double_t fNormFactor offset=508 type= 8 Normalization factor
TArrayD fContour   offset=516 type=62 Array to display contour levels
TArrayD fSumw2     offset=528 type=62 Array of sum of squares of weights
TString fOption    offset=540 type=65 histogram options
TList*  fFunctions offset=548 type=63 ->Pointer to list of functions
i= 0, TNamed      type= 67, offset= 0, len=1, method=0
i= 1, TAttLine    type= 0, offset= 28, len=1, method=142484480
i= 2, TAttFill    type= 0, offset= 40, len=1, method=142496992
i= 3, TAttMarker  type= 0, offset= 48, len=1, method=142509704
i= 4, fNcells     type= 3, offset= 60, len=1, method=0
i= 5, fXaxis      type= 61, offset= 64, len=1, method=1081287424
i= 6, fYaxis      type= 61, offset=192, len=1, method=1081287548
i= 7, fZaxis      type= 61, offset=320, len=1, method=1081287676
i= 8, fBarOffset  type= 22, offset=448, len=2, method=0
i= 9, fEntries    type= 28, offset=452, len=8, method=0
i=10, fContour    type= 62, offset=516, len=1, method=1081287804
i=11, fSumw2     type= 62, offset=528, len=1, method=1081287924
i=12, fOption     type= 65, offset=540, len=1, method=1081288044
i=13, fFunctions  type= 63, offset=548, len=1, method=1081288164

```

### 11.5.4 Optimized StreamerInfo

The entries starting with “i = 0” is the optimized format of the `StreamerInfo`. Consecutive data members of the same simple type and size are collapsed and read at once into an array for performance optimization.

```

i= 0, TNamed      type= 67, offset= 0, len=1, method=0
i= 1, TAttLine    type= 0, offset= 28, len=1, method=142484480
i= 2, TAttFill    type= 0, offset= 40, len=1, method=142496992
i= 3, TAttMarker  type= 0, offset= 48, len=1, method=142509704

```

For example, the five data members beginning with `fEntries` and the three data members beginning with `fMaximum`, are put into an array called `fEntries` (i = 9) with the length 8.

```

i= 9, fEntries    type= 28, offset=452, len=8, method=0

```

Only simple type data members are combined, object data members are not combined. For example the three axis data members remain separate. The “method” is a handle to the method that reads the object.

### 11.5.5 Automatic Schema Evolution

When a class is defined in ROOT, it must include the `ClassDef` macro as the last line in the header file inside the class definition. The syntax is:

```
ClassDef(<ClassName>,<VersionNumber>)
```

The version number identifies this particular version of the class. When a class has version 0 it is not stored in a root file but its base class(es) is(are). The reason can be that this class has no data members worth saving or all real info is in the base classes. The version number is written to the file in the **Streamer** by the call `TBuffer::WriteVersion`. You, as the designer of the class, do not need to do any manual modification in the **Streamer**. ROOT schema evolution mechanism is automatic and handled by the **StreamerInfo**.

### 11.5.6 Manual Data Model Evolution Capabilities

The automatic data model schema evolution implemented in ROOT makes it possible to read back the serialized data object in the situation when the definition of the classes those objects represent changed slightly (some of the data members were removed or some new ones added). It is also possible to manually specify the rules for more sophisticated data transformations done while reading to load the serialized objects into data structures that changed quite significantly.

ROOT provides two interface enabling users to specify the conversion rules. The first way is to define a rule in the dictionary file and the second way is to insert it to the `TClass` object using the C++ API.

There are two types of conversion rules. The first of them, the normal rules, are the ones that should be used in the most of the cases. They provide a buffered input data and an address of the in-memory target object and allow user to specify the conversion function mapping the data being read to the output format. The second type of the rules, the raw rules, also provide the pointer to the target object but the input is a raw `TBuffer` object containing the input data member declared as an input to the rule. This type of a rule is provided mainly to handle the file format changes that couldn't have been handled otherwise and in general should not be used unless there is no other option.

#### 11.5.6.1 The dictionaries

The most convenient place to specify the conversion rules is a dictionary. One can do that either in CINT's `LinkDef` file or in the selection xml file being fed to `genreflex`. The syntax of the rules is the following:

- For CINT dictionaries:

```
#pragma read                                     \
  sourceClass="ClassA"                           \
  source="double m_a; double m_b; double m_c"    \
  version="[4-5,7,9,12-]"                       \
  checksum="[12345,123456]"                     \
  targetClass="ClassB"                          \
  target="m_x"                                    \
  embed="true"                                    \
  include="iostream,cstdlib"                    \
  code="{m_x = onfile.m_a * onfile.m_b * onfile.m_c; }" \

#pragma readraw                                  \
  sourceClass="TAxis" \
  source="fXbins" \
  targetClass="TAxis" \
  target="fXbins" \
  version="[-5]" \
  include="TAxis.h" \
  code="\

{\
Float_t * xbins=0; \
Int_t n = buffer.ReadArray( xbins ); \
fXbins.Set( xbins ); \
}"
```

- For REFLEX dictionaries:

```
<ioread sourceClass="ClassA"
  source="double m_a; double m_b; double m_c"
  version="[4-5,7,9,12-]"
  checksum="[12345,123456]"
  targetClass="ClassB"
  target="m_x"
  embed="true"
  include="iostream,cstdlib">
<![CDATA[
  m_x = onfile.m_a * onfile.m_b * onfile.m_c;
]] >
</ioread>
```

```
<ioreadraw sourceClass="TAxis"
  source="fXbins"
  targetClass="TAxis"
  target="fXbins"
  version="[-5]"
  include="TAxis.h">
<![CDATA[
  Float_t *xbins = 0;
  Int_t n = buffer.ReadArray( xbins ) ;
  fXbins.Set( xbins );
]] >
</ioreadraw>
```

The variables in the rules have the following meaning:

- sourceClass
  - The field defines the on-disk class that is the input for the rule.
- source
  - A semicolon-separated list of values defining the source class data members that need to be cached and accessible via object proxy when the rule is executed. The values are either the names of the data members or the type-name pairs (separated by a space). If types are specified then the ondisk structure can be generated and used in the code snippet defined by the user.
- version
  - A list of versions of the source class that can be an input for this rule. The list has to be enclosed in a square bracket and be a comma-separated list of versions or version ranges. The version is an integer number, whereas the version range is one of the following:
    - “a-b”: a and b are integers and the expression means all the numbers between and including a and b
    - “-a”: a is an integer and the expression means all the version numbers smaller than or equal to a
    - “a-”: a is an integer and the expression means all the version numbers greater than or equal to a
- checksum
  - A list of checksums of the source class that can be an input for this rule. The list has to be enclosed in a square brackets and is a comma-separated list of integers.
- targetClass
  - The field is obligatory and defines the name of the in-memory class that this rule can be applied to.
- target
  - A semicolon-separated list of target class data member names that this rule is capable of calculating.
- embed



- This property tells the system if the rule should be written in the output file if some objects of this class are serialized.
- include
  - A list of header files that should be included in order to provide the functionality used in the code snippet; the list is comma delimited.
- code
  - An user specified code snippet

The user can assume that in the provided code snippet the following variables will be defined:

The user provided code snippets have to consist of valid C++ code. The system can do

some preprocessing before wrapping the code into function calls and declare some variables to facilitate the rule definitions. The user can expect the following variables being predeclared:

- newObj
  - variable representing the target in-memory object, its type is that of the target object
- oldObj
  - in normal conversion rules, an object of TVirtualObject class representing the input data, guaranteed to hold the data members declared in the source property of the rule
- buffer
  - in raw conversion rules, an object of TBuffer class holding the data member declared in source property of the rule
- names of the data members of the target object declared in the target property of the rule declared to be the appropriate type
- onfile.xxx
  - in normal conversion rules, names of the variables of basic types declared in the source property of the rule

### 11.5.6.2 The C++ API

The schema evolution C++ API consists of two classes: `ROOT::TSchemaRuleSet` and `ROOT::TSchemaRule`. Objects of the `TSchemaRule` class represent the rules and their fields have exactly the same meaning as the ones of rules specified in the dictionaries. `TSchemaRuleSet` objects manage the sets of rules and ensure their consistency. There can be no conflicting rules in the rule sets. The rule sets are owned by the `TClass` objects corresponding to the target classes defined in the rules and can be accessed using `TClass:: {Get|Adopt}SchemaRules`.

## 11.5.7 Manual Schema Evolution

If you have written your own `Streamer` as described in the section “Streamers with Special Additions”, you will have to manually add code for each version and manage the evolution of your class. When you add or remove data members, you must modify the `Streamer` by hand. ROOT assumes that you have increased the class version number in the `ClassDef` statement and introduced the relevant test in the read part of the `Streamer`. For example, if a new version of the `Event` class above includes a new member: `Int_t fNew` the `ClassDef` statement should be changed to `ClassDef(Event,2)` and the following lines should be added to the read part of the `Streamer`:

```
if (R__v > 1) R__b >> fNew;
else fNew = 0;           // set to some default value
```

If, in the same new version 2 you remove the member `fH`, you must add the following code to read the histogram object into some temporary object and delete it:

```

if (R__v) < 2 {
  TH1F *dummy = 0;
  R__b >> dummy;
  delete dummy;
}

```

Our experience with manual schema evolution shows that it is easy to make and mismatches between `Streamer` writers and readers are frequent and increase as the number of classes increase. We recommend you use `rootcint` generated `Streamers` whenever you can, and profit from the automatic schema evolution.

### 11.5.8 Building Class Definitions with the StreamerInfo

A ROOT file's `StreamerInfo` list contains the description of all versions of all classes in the file. When a file is opened the `StreamerInfo`s read into memory and it provides enough information to make the file browsable. The `TStreamerInfo` enables us to recreate a header file for the class in case the compiled class is not available. This is done with the `TFile::MakeProject` method. It creates a directory with the header files for the named classes and a `makefile` to compile a shared library with the class definitions.

### 11.5.9 Example: MakeProject

To explain the details, we use the example of the `ATLFast` project that is a fast simulation for the ATLAS experiment. The complete source for `ATLFast` can be downloaded at <ftp://root.cern.ch/root/atlfast.tar.gz>. Once we compile and run `ATLFast` we get a ROOT file called `atlfast.root`, containing the `ATLFast` objects. When we open the file, we get a warning that the file contains classes that are not in the CINT dictionary. This is correct since we did not load the class definitions.

```

root[] TFile f("atlfast.root")
Warning in <TClass::TClass>: no dictionary for class TMCParticle is available
Warning in <TClass::TClass>: no dictionary for class ATLFMuon available

```

We can see the `StreamerInfo` for the classes:

```

root[] f.ShowStreamerInfo()
...
StreamerInfo for class: ATLFMuon, version=1
BASE TObject      offset= 0 type=66 Basic ROOT object
BASE TAtt3D       offset= 0 type= 0 3D attributes
Int_t m_KFcode    offset= 0 type= 3 Muon KF-code
Int_t m_MCParticle offset= 0 type= 3 Muon position in MCParticles list
Int_t m_KFmother  offset= 0 type= 3 Muon mother KF-code
Int_t m_UseFlag   offset= 0 type= 3 Muon energy usage flag
Int_t m_Isolated  offset= 0 type= 3 Muon isolation (1 for isolated)
Float_t m_Eta     offset= 0 type= 5 Eta coordinate
Float_t m_Phi     offset= 0 type= 5 Phi coordinate
Float_t m_PT      offset= 0 type= 5 Transverse energy
Int_t m_Trigger   offset= 0 type= 3 Result of trigger...

```

However, when we try to use a specific class we get a warning because the class is not in the CINT dictionary. We can create a class using `gROOT->GetClass()` which makes a fake class from the `StreamerInfo`.

```

// Build a 'fake' class
root[] gROOT->GetClass("ATLFMuon")
(const class TClass*)0x87e5c08
// The fake class has a StreamerInfo
root[] gROOT->GetClass("ATLFMuon")->GetStreamerInfo()->ls()
StreamerInfo for class: ATLFMuon, version=1

```

```

BASE    TObject      offset=  0 type=66 Basic ROOT object
BASE    TAtt3D       offset=  0 type=  0 3D attributes
Int_t   m_KFcode     offset= 16 type=  3 Muon KF-code
Int_t   m_MCParticle offset= 20 type=  3 Muon position in MCParticles list
Int_t   m_KFmother   offset= 24 type=  3 Muon mother KF-code
Int_t   m_UseFlag    offset= 28 type=  3 Muon energy usage flag
Int_t   m_Isolated   offset= 32 type=  3 Muon isolation
Float_t m_Eta        offset= 36 type=  5 Eta coordinate
Float_t m_Phi        offset= 40 type=  5 Phi coordinate
Float_t m_PT         offset= 44 type=  5 Transverse energy
Int_t   m_Trigger    offset= 48 type=  3 Result of trigger
i= 0, TObject      type= 66, offset=  0, len=1, method=0
i= 1, TAtt3D       type=  0, offset=  0, len=1, method=142684688
i= 2, m_KFcode     type= 23, offset= 16, len=5, method=0
i= 3, m_Eta        type= 25, offset= 36, len=3, method=0
i= 4, m_Trigger    type=  3, offset= 48, len=1, method=0

```

MakeProject has three parameters:

```
MakeProject(const char *dirname,const char *classes,Option_t *option)
```

The first is the directory name in which to place the generated header files. The second parameter is the name of the classes to include in the project. By default, all classes are included. It recognizes the wild card character \*, for example, "ATLF\*" includes all classes beginning with ATLF. The third parameter is an option with the following values:

- "new" If the directory does not exist, it is created.
- "recreate" If the directory does not exist, it is created as in "new", in addition if the directory does exist, all existing files are deleted before creating the new files.
- "update" The new classes are added to the existing directory and the existing classes are replaced with the new definition. If the directory does not exist, it creates it as in "new".
- "+": This option can be used in combination with the other three. It will create the necessary files to easily build a shared library containing the class definitions. Specifically it will:
  - Generate a script called MAKE that builds the shared library containing the definition of all classes in the directory.
  - Generate a LinkDef.h files to use with rootcint in MAKE.
  - Run rootcint to generate a <dirname>ProjectDict.cxx file.
  - Compile the <dirname>ProjectDict.cxx with the current options in compiledata.h.
  - Build a shared library <dirname>.so.
- "++": This option can be used instead of the single "+". It does everything the single "+" does, and dynamically loads the shared library <dirname>.so.

This example makes a directory called MyProject that will contain all class definitions from the atlfast.root file. The necessary makefile to build a shared library are also created, and since the '++' is appended, the shared library is also loaded.

```

root[] f.MakeProject("MyProject","*", "recreate++")
MakeProject has generated 0 classes in MyProject
MyProject/MAKE file has been generated
Shared lib MyProject/MyProject.so has been generated
Shared lib MyProject/MyProject.so has been dynamically linked

```

The contents of MyProject:

```

root[]      .! ls MyProject
ATLFClsr.h   ATLFJet.h       ATLFMiscMaker.h   ATLFTrack.h
TMCParticle.h ATLFClusterMaker.h ATLFJetMaker.h   ATLFMuon.h
ATLFElectron.h ATLFMCMaker.h     ATLFMuonMaker.h  ATLFElectronMaker.h
ATLFMaker.h   ATLFPhoton.h     ATLFHistBrowser.h ATLFMisc.h
ATLFPhotonMaker.h ATLFTrackMaker.h ATLFTrigger.h    ATLFTriggerMaker.h
LinkDef.h     MAKE             MyProject.so      MyProjectProjectDict.h
MyProjectProjectDict.cxx MyProjectProjectDict.o

```

Now you can load the shared library in any consecutive root session to use the `atlfast` classes.

```

root[] gSystem->Load("MyProject/MyProject")
root[] ATLFMuon muon

```

This is an example of a generated header file:

```

////////////////////////////////////
// This class has been generated by TFile::MakeProject
// (Thu Apr 5 10:18:37 2001 by ROOT version 3.00/06)
// from the TStreamerInfo in file atlfast.root
////////////////////////////////////
#ifndef ATLFMuon_h
#define ATLFMuon_h
#include "TObject.h"
#include "TAtt3D.h"
class ATLFMuon : public TObject , public TAtt3D {
public:
    Int_t      m_KFcode;           //Muon KF-code
    Int_t      m_MCParticle;      //Muon position in MCParticles list
    Int_t      m_KFmother;        //Muon mother KF-code
    Int_t      m_UseFlag;         //Muon energy usage flag
    Int_t      m_Isolated;        //Muon isolation (1 for isolated)
    Float_t    m_Eta;             //Eta coordinate
    Float_t    m_Phi;            //Phi coordinate
    Float_t    m_PT;             //Transverse energy
    Int_t      m_Trigger;         //Result of trigger
    ATLFMuon() {}
    virtual ~ATLFMuon() {}
    ClassDef(ATLFMuon,1) //
};
    ClassImp(ATLFMuon)
#endif

```

## 11.6 Migrating to ROOT 3

We will distinguish the following cases:

**Case A:** You have your own `Streamer` method in your class implementation file. This also means that you have specified `MyClass` in the `LinkDef.h` file.

- Keep `MyClass` - unchanged.
- Increment your class version id in `ClassDef` by 1, e.g. `ClassDef(MyClass, 2)`
- Change your `Streamer` function in the following way: The old write block can be replaced by the new standard `Write`. Change the read block to use the new scheme for the new versions and the old code for the old versions.

```

void MyClass::Streamer(TBuffer &R__b) {
    // Stream an object of class MyClass.
    if (R__b.IsReading()) {
        UInt_t R__s, R__c;
        Version_t R__v = R__b.ReadVersion(&R__s, &R__c);
        if (R__v > 1) {
            MyClass::Class()->ReadBuffer(R__b, this, R__v, R__s, R__c);
            return;
        }
        // process old versions before automatic schema evolution
        R__b >> xxxx;
        R__b >> .. etc
        R__b.CheckByteCount(R__s, R__c, MyClass::IsA()); // end of old versions
    } else
        MyClass::Class()->WriteBuffer(R__b, this);
}

```

**Case B:** You use the automatic `Streamer` in the dictionary file.

- Move the old `Streamer` from the file generated by `rootcint` to your class implementation file, then modify the `Streamer` function as in Case A above.
- Increment your class version id in `ClassDef` by 1, i.e. `ClassDef(MyClass, 2)`
- Add option “-” in the pragma line of `LinkDef`.

**Case C:** You use the automatic `Streamer` in the dictionary file and you already use the option “+” in the `LinkDef` file. If the old automatic `Streamer` does not contain any statement using the function `WriteArray`, you have nothing to do, except running `rootcint` again to regenerate the new form of the `Streamer` function, otherwise proceed like for case B.

## 11.7 Compression and Performance

ROOT uses a compression algorithm based on the well-known `gzip` algorithm. It supports nine levels of compression. The default for ROOT is one. The compression level can be set with the method `TFile::SetCompressionLevel`. The experience with this algorithm shows that a compression level of 1.3 for raw data files and around two on most DST files is the optimum. The choice of one for the default is a compromise between the time it takes to read and write the object vs. the disk space savings.

To specify no compression, set the level to zero.

We recommend using compression when the time spent in I/O is small compared to the total processing time. If the I/O operation is increased by a factor of 5 it is still a small percentage of the total time and it may compress the data by a factor of 10. On the other hand if the time spend on I/O is large, compression may have a large impact on the program’s performance.

The compression factor, i.e. the savings of disk space, varies with the type of data. A buffer with a same value array is compressed so that the value is only written once. For example, a track has the mass of a pion that it is always the same, and the charge of the pion that is either positive or negative. For 1000 pions, the mass will be written only once, and the charge only twice (positive and negative). When the data is sparse, i.e. when there are many zeros, the compression factor is also high.

Compression level	Bytes	Write Time (sec)	Read Time (sec.)
0	1,004,998	4.77	0.07
1	438,366	6.67	0.05
5	429,871	7.03	0.06
9	426,899	8.47	0.05

The time to uncompress an object is small compared to the compression time and is independent of the selected compression level. Note that the compression level may be changed at any time, but the new compression level will only apply to newly written objects. Consequently, a ROOT file may contain objects with different compression levels. This table shows four runs of the demo script that creates 15 histograms with different compression parameters. To make the numbers more significant, the macro was modified to create 1000 histograms. We have included two more examples to show the impact of compression on Trees in the next chapter.

## 11.8 Remotely Access to ROOT Files via a rootd

Reading and writing ROOT files over the net can be done by creating a **TNetFile** object instead of a **TFile** object. Since the **TNetFile** class inherits from the **TFile** class, it has exactly the same interface and behavior. The only difference is that it reads and writes to a remote **rootd** daemon.

### 11.8.1 TNetFile URL

**TNetFile** file names are in standard URL format with protocol “**root**”. The following are valid **TNetFile** URL’s:

```
root://hpsalo/files/aap.root
root://hpbrun.cern.ch/root/hsimple.root
root://pcna49a:5151/~na49/data/run821.root
root://pcna49d.cern.ch:5050//v1/data/run810.root
```

The only difference with the well-known http URL’s is that the root of the remote file tree is the remote user’s home directory. Therefore an absolute pathname requires a // after the host or port (as shown in the last example above). Further the expansion of the standard shell characters, like ~, \$, . . ., etc. is handled as expected. The default port on which the remote **rootd** listens is 1094 and **TNetFile** (actually by **TUrl** that is used by **TNetFile**) assumes this default port. The port number has been allocated by the IANA and is reserved for ROOT.

### 11.8.2 Remote Authentication

Connecting to a **rootd** daemon requires a remote user id and password. **TNetFile** supports several ways for you to provide your login information:

- Setting it globally via the static methods **TNetFile::SetUser** and **TNetFile::SetPasswd**
- Via the `~/.netrc` file (same format and file as used by **ftp**)
- Via command line prompt
- Setting the SPR password file via the option `-P FILE`, i.e. the next line will start the **rootd** daemon using the files `$HOME/.srootdpass2.conf` and `$HOME/.srootdpass2` for SPR authentication:  
`rootd -P $HOME/.srootdpass2`

### 11.8.3 A Simple Session

```
root[] TFile *f1 = TFile::Open("local/file.root","update")
root[] TFile *f2 = TFile::Open("root://pcna49a.cern.ch/data/file.root","new")
Name (pcna49a:rdm):
Password:
root[] TFile *f3 = TFile::Open("http://root.cern.ch/~rdm/hsimple.root")
root[] f3.ls()
TWebFile** http://root.cern.ch/~rdm/hsimple.root
TWebFile* http://root.cern.ch/~rdm/hsimple.root
KEY: TH1F hpx;1 This is the px distribution
KEY: TH2F hpxpy;1 py vs px
KEY: TProfile hprof;1 Profile of pz versus px
KEY: TNtuple ntuple;1 Demo ntuple
root[] hpx.Draw()
```

### 11.8.4 The rootd Daemon

The `rootd` daemon works with the `TNetFile` class. It allows remote access to ROOT database files in read or read/write mode. The `rootd` daemon can be found in the directory `$ROOTSYS/bin`. It can be started either via `inetd` or by hand from the command line (no need to be super user). Its performance is comparable with NFS but while NFS requires all kind of system permissions to setup, `rootd` can be started by any user. The simplest way to start `rootd` is by starting it from the command line while being logged in to the remote machine. Once started `rootd` goes immediately in the background (does not need `&`) and you can log out from the remote node. The only required argument is the range of ports (specified using `-p port1-port2`). `rootd` will listen on the first available port in this range. You can also specify `-p 0-N` to search relative to the service port specified in `/etc/services`. If a single port is specified (`rootd -p 1094`) then no search is made. Unless started by `inetd` (`rootd -i`), it prints information about the found port, something like: `ROOTD_PORT=5151`, `ROOTD_PID=14433` before spawning the daemon. This way the user knows what was used (`eval 'rootd'` will set these as variables in Bourne-like shells). Also, `rootd` shows an error message (as well as sending the `syslog` message) if there is any problem binding the port or forking the daemon.

Using `TNetFile` you can now read and write files on the remote machine.

In the example below, `rootd` runs on the remote node under user id `minuser` and searches for an available port into the range 1094-1098. It finds and listens to port 1094. When creating a `TNetFile` object you have to specify the same port number 1094 and use `minuser` (and corresponding password) as login id. When `rootd` is started in this way, you can only login with the user id under which `rootd` was started on the remote machine.

```
hpsalo[]      telnet fsgio2.fnal.gov
login:        minuser
Password:
<fsgio2>      rootd -p 1094-1098
ROOTD_PORT=1094
ROOTD_PID=14433
<fsgio2>      exit
hpsalo[]      root
root[]        TFile *f = TFile::Open("root://fsgio2.fnal.gov:1094/file.root","new")
Name (fsgio2.fnal.gov:rdm):      minuser
Password:
root[]        f.ls()
```

However, you can make many connections since the original `rootd` will fork (spawn) a new `rootd` that will service the requests from the `TNetFile`. The original `rootd` keeps listening on the specified port for other connections. Each time a `TNetFile` makes a connection; it gets a new private `rootd` that will handle its requests. At the end of a ROOT, session when all `TNetFiles` are closed only the original `rootd` will stay alive ready to service future `TNetFiles`.

### 11.8.5 Starting rootd via inetd

If you expect to often connect via `TNetFile` to a remote machine, it is more efficient to install `rootd` as a service of the `inetd` super daemon. In this way, it is not necessary for each user to run a private `rootd`. However, this requires a one-time modification of two system files (and super user privileges to do so). Add to `/etc/services` the line: `rootd 1094/tcp`. To `/etc/inetd.conf` the line:

```
rootd stream tcp nowait root /usr/local/root/bin/rootd rootd -i
```

After these changes force `inetd` to reread its configuration file with: “`kill -HUP <pid inetd>`”. It is not necessary to specify a port number in the URL given to `TNetFile` when the setup done this way. `TNetFile` assumes the default port to be 1094 as specified above in the `/etc/services` file.

### 11.8.6 Command Line Arguments for rootd

`rootd` supports the following arguments:

- `-i` says that `rootd` is started by `inetd`



- `-p port#-port#` specifies the range of ports to be searched
- `-p 0-N` the service ports range in `/etc/services`
- `-d level` level of debug info written to `syslogd`

0 = no debug (default) 1 = minimum

2 = medium 3 = maximum

## 11.9 Reading ROOT Files via Apache Web Server

By adding one ROOT specific module to your Apache web server, you can distribute ROOT files to any ROOT user. There is no longer a need to send your files via FTP and risking (out of date) histograms or other objects. Your latest up-to-date results are always accessible to all your colleagues. To access ROOT files via a web server, create a `TWebFile` object instead of a `TFile` object with a standard URL as file name. For example:

```
root[] TWebFile f("http://root.cern.ch/~rdm/hsimple.root")
root[] f.ls()
TWebFile** http://root.cern.ch/~rdm/hsimple.root
TWebFile* http://root.cern.ch/~rdm/hsimple.root
KEY: TH1F hpx;1 This is the px distribution
KEY: TH2F hpxpy;1 py vs px
KEY: TProfile hprof;1 Profile of pz versus px
KEY: TNtuple ntuple;1 Demo ntuple
root[] hpx.Draw()
```

Since `TWebFile` inherits from `TFile` all `TFile` operations work as expected. However, due to the nature of a web server a `TWebFile` is a read-only file. A `TWebFile` is ideally suited to read relatively small objects (like histograms or other data analysis results). Although possible, you don't want to analyze large `TTree`'s via a `TWebFile`.

Here follows a step-by-step recipe for making your Apache 1.1 or 1.2 web server ROOT aware:

- Go to your Apache source directory and add the file [ftp://root.cern.ch/root/mod\\_root.c](ftp://root.cern.ch/root/mod_root.c) or [ftp://root.cern.ch/root/mod\\_root133.c](ftp://root.cern.ch/root/mod_root133.c) when your Apache server is >1.2 (rename the file `mod_root.c`).
- Add to the end of the Configuration file the line: `Module root_module mod_root.o`
- Run the Configure script
- Type `make`
- Copy the new `httpd` to its expected place
- Go to the `conf` directory and add at the end of the `srm.conf` file the line: `AddHandler root-action root`
- Restart the `httpd` server

### 11.9.1 Using the General Open Function of TFile

To make life simple we provide a general function to open any type of file (except shared memory files of class `TMapFile`). This functionality is provided by the static `TFile::Open()` function:

```
TFile *TFile::Open(const Text_t *name, Option_t *option="",
const Text_t *title="", Int_t compress, Int_t netopt)
```



Depending on the `name` argument, the function returns a `TFile`, a `TNetFile` or a `TWebFile` object. In case a `TNetFile` URL specifies a local file, a `TFile` object will be returned (and of course no login information is needed). The arguments of the `Open()` function are the same as the ones for the `TFile` constructor.

Using `ReOpen()` method it is possible to reopen a file with a different access mode, like from `READ` to `UPDATE` or from `NEW`, `CREATE`, `RECREATE`, `UPDATE` to `READ`. Thus the mode argument can be either “`READ`” or “`UPDATE`”. The method returns:

- 0 in case the mode was successfully modified;
- 1 in case the mode did not change (it was already as requested or there were wrong input arguments);
- -1 in case of failure. In the last case the file cannot be used anymore.

## 11.10 XML Interface

A new module `xml` as implemented by Sergey Linev (GSI). It is an optional package that can be used to save a canvas into `file.xml` file format instead of `file.root`. XML files do not have any advantages compared to the normal ROOT files, except that the information in these files can be edited via a normal editor. The main motivation for this new format is to facilitate the communication with other non ROOT applications. Currently writing and reading XML files is limited to ROOT applications. It is our intention to develop a simple reader independent of the ROOT libraries that could be used as an example for real applications.

The XML format should be used only for small data volumes, typically histogram files, pictures, geometries, calibrations. The XML file is built in memory before being dumped to disk. Like for normal ROOT files, XML files use the same I/O mechanism exploiting the ROOT/CINT dictionary. Any class having a dictionary can be saved in XML format. This first implementation does not support subdirectories or trees.

The shared library `libRXML.so` may be loaded dynamically via `gSystem->Load("libRXML")`. This library is also automatically loaded by the plug-in manager as soon a XML file is created. To create an XTM file, simply specify a filename with an `.xml` extension when calling `TFile::Open`. `TFile::Open` will recognize that you are trying to open an XML file and return a `TXMLFile` object. When a XML file is open in write mode, one can use the normal `TObject::Write` to write an object in the file.

```
// example of a session saving a histogram to a XML file
TFile *f = TFile::Open("Example.xml","recreate");
TH1F *h = new TH1F("h","test",1000,-2,2)
h->FillRandom("gaus");
h->Write();
delete f;
// example of a session saving a histogram to a XML file
TFile *f = TFile::Open("Example.xml");
TH1F *h = (TH1F*)f->Get("h");
h->Draw();
```

The canvas can be saved as a XML file format via File menu / Save or Save As menu entries. One can do also:

```
canvas->Print("Example.xml");
```



# Chapter 12

## Trees

### 12.1 Why Should You Use a Tree?

In the “Input/Output” chapter, we saw how objects can be saved in ROOT files. In case you want to store large quantities of same-class objects, ROOT has designed the **TTree** and **TNtuple** classes specifically for that purpose. The **TTree** class is optimized to reduce disk space and enhance access speed. A **TNtuple** is a **TTree** that is limited to only hold floating-point numbers; a **TTree** on the other hand can hold all kind of data, such as objects or arrays in addition to all the simple types.

When using a **TTree**, we fill its branch buffers with leaf data and the buffers are written to disk when it is full. Branches, buffers, and leaves, are explained a little later in this chapter, but for now, it is important to realize that each object is not written individually, but rather collected and written a bunch at a time.

This is where the **TTree** takes advantage of compression and will produce a much smaller file than if the objects were written individually. Since the unit to be compressed is a buffer, and the **TTree** contains many same-class objects, the header of the objects can be compressed.

The **TTree** reduces the header of each object, but it still contains the class name. Using compression, the class name of each same-class object has a good chance of being compressed, since the compression algorithm recognizes the bit pattern representing the class name. Using a **TTree** and compression the header is reduced to about 4 bytes compared to the original 60 bytes. However, if compression is turned off, you will not see these large savings.

The **TTree** is also used to optimize the data access. A tree uses a hierarchy of branches, and each branch can be read independently from any other branch. Now, assume that  $P_x$  and  $P_y$  are data members of the event, and we would like to compute  $P_x^2 + P_y^2$  for every event and histogram the result.

If we had saved the million events without a **TTree** we would have to:

- read each event in its entirety into memory
- extract the  $P_x$  and  $P_y$  from the event
- compute the sum of the squares
- fill a histogram

We would have to do that a million times! This is very time consuming, and we really do not need to read the entire event, every time. All we need are two little data members ( $P_x$  and  $P_y$ ). On the other hand, if we use a tree with one branch containing  $P_x$  and another branch containing  $P_y$ , we can read all values of  $P_x$  and  $P_y$  by only reading the  $P_x$  and  $P_y$  branches. This makes the use of the **TTree** very attractive.

### 12.2 A Simple TTree

This script builds a **TTree** from an ASCII file containing statistics about the staff at CERN. This script, `staff.C` and its input file `staff.dat` are in `$ROOTSYS/tutorials/tree`.

```

{
    // example of macro to read data from an ascii file and
    // create a root file with an histogram and a TTree
    gROOT->Reset();

    // the structure to hold the variables for the branch

    struct staff_t {
        Int_t cat;
        Int_t division;
        Int_t flag;
        Int_t age;
        Int_t service;
        Int_t children;
        Int_t grade;
        Int_t step;
        Int_t nation;
        Int_t hrweek;
        Int_t cost;
    };
    staff_t staff;
    // continued...
    // open the ASCII file
    FILE *fp = fopen("staff.dat","r");
    char line[81];
    // create a new ROOT file
    TFile *f = new TFile("staff.root","RECREATE");
    // create a TTree
    TTree *tree = new TTree("T","staff data from ascii file");
    // create one branch with all information from the stucture
    tree->Branch("staff",&staff.cat,"cat/I:division:flag:age:service:
                children:grade:step:nation:hrweek:cost");
    // fill the tree from the values in ASCII file
    while (fgets(&line,80,fp)) {
        sscanf(&line[0],"%d%d%d",&staff.cat,&staff.division,
            &staff.flag,&staff.age);
        sscanf(&line[13],"%d%d%d",&staff.service,&staff.children,
            &staff.grade,&staff.step);
        sscanf(&line[24],"%d%d",&staff.nation,&staff.hrweek,
            &staff.cost);
        tree->Fill();
    }
    // check what the tree looks like
    tree->Print();
    fclose(fp);
    f->Write();
}

```

The script declares a structure called `staff_t`, with several integers representing the relevant attribute of a staff member. It opens the ASCII file, creates a ROOT file and a `TTree`. Then it creates one branch with the `TTree::Branch` method. The first parameter of the `Branch` method is the branch name. The second parameter is the address from which the first leaf is to be read. In this example it is the address of the structure `staff`. Once the branch is defined, the script reads the data from the ASCII file into the `staff_t` structure and fills the `tree`. The ASCII file is closed, and the ROOT file is written to disk saving the `tree`. Remember, trees and histograms are created in the current directory, which is the file in our example. Hence an `f->Write()` saves the tree.

## 12.3 Show an Entry with TTree::Show

An easy way to access one entry of a tree is the use the TTree::Show method. For example to look at the 10th entry in the `staff.root` tree:

```
root[] TFile f("staff.root")
root[] T->Show(10)
=====> EVENT:10
  Category      = 361
  Flag          = 15
  Age           = 51
  Service       = 29
  Children      = 0
  Grade        = 7
  Step         = 13
  Hrweek       = 40
  Cost         = 7599
  Division     = PS
  Nation       = FR
```

## 12.4 Print the Tree Structure with TTree::Print

A helpful command to see the tree structure meaning the number of entries, the branches and the leaves, is TTree::Print.

```
root[] T->Print()
*****
*Tree      :T          : staff data from ascii file          *
*Entries :3354        : Total = 245417 bytes File Size =     59945*
*          Tree compression factor = 2.90                    *
*****
*Br   0 :staff      :Category/I:Flag:Age:Service:Children:Grade:... *
*      | Cost                                             *
*Entries :3354 : Total Size = 154237 bytes File Size = 32316 *
*Baskets : 3 : Basket Size = 32000 bytes Compression= 2.97 *
*****
```

## 12.5 Scan a Variable the Tree with TTree::Scan

The TTree::Scan method shows all values of the list of leaves separated by a colon.

```
root[] T->Scan("Cost:Age:Children")
*****
* Row *      Cost *      Age * Children *
*****
*   0 *    11975 *     58 *      0 *
*   1 *    10228 *     63 *      0 *
*   2 *    10730 *     56 *      2 *
*   3 *     9311 *     61 *      0 *
*   4 *     9966 *     52 *      2 *
*   5 *     7599 *     60 *      0 *
*   6 *     9868 *     53 *      1 *
*   7 *     8012 *     60 *      1 *
*   ...
```

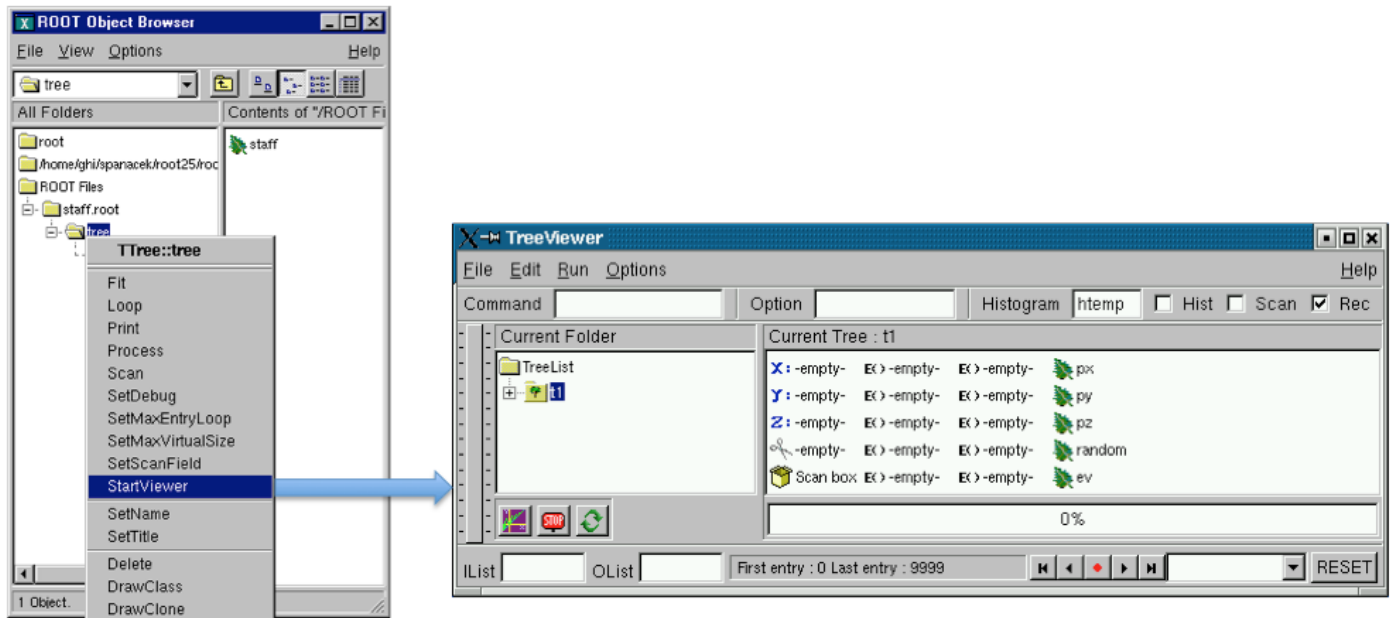

Figure 12.1: Activating the tree viewer

## 12.6 The Tree Viewer

The tree viewer is a quick and easy way to examine a tree. To start the tree viewer, open a file and object browser. Right click on a **TTree** and select **StartViewer**. You can also start the tree viewer from the command line. First load the viewer library.

```
root[] TFile f("staff.root")
root[] T->StartViewer()
```

If you want to start a tree viewer without a tree, you need to load the tree player library first:

```
root[] gSystem->Load("libTreeViewer.so")
root[] new TTreeViewer()
```

The figure above shows how the tree viewer looks like for the example file `staff.root`. The left panel contains the list of trees and their branches; in this case there is only one tree. You can add more trees with the File-Open command to open the file containing the new tree, then use the context menu on the right panel, select `SetTreeName` and enter the name of the tree to add. On the right are the leaves or variables in the tree. You can double click on any leaf to a histogram it.



The toolbar in the upper part can be used for user commands, changing the drawing option and the histogram name. The lower part contains three picture buttons that draw a histogram, stop the current command, and refresh the tree.

The three check buttons toggle the following:

**Hist**- the histogram drawing mode;

**Scan**- enables redirecting of `TTree::Scancommand` in an ASCII file;

**Rec** - enables recording of the last issued command.

-  To draw more than one dimension you can drag and drop any leaf to the X,Y,Z boxes“. Then push the Draw button, which is marked with the purple icon on the bottom left.
-  All commands can be interrupted at any time by pressing this button.



- The method `TTree::Refresh` is called by pressing the refresh button in `TTreeView`. It redraws the current exposed expression. Calling `TTree::Refresh` is useful when a tree is produced by a writer process and concurrently analyzed by one or more readers.

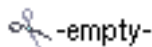

- To add a cut/weight to the histogram, enter an expression in the “cut box”. The cut box is the one with the scissor icon.

Below them there are two text widgets for specifying the input and output event lists. A Tree Viewer session is made by the list of user-defined expressions and cuts, applying to a specified tree. A session can be saved using File / `SaveSource` menu or the `SaveSource` method from the context menu of the right panel. This will create a macro having as default name `treeviewer.C` that can be ran at any time to reproduce the session.

Besides the list of user-defined expressions, a session may contain a list of RECORDS. A record can be produced in the following way: dragging leaves/expression on X/Y/Z; changing drawing options; clicking the RED button on the bottom when happly with the histogram

NOTE that just double clicking a leaf will not produce a record: the histogram must be produced when clicking the DRAW button on the bottom-left. The records will appear on the list of records in the bottom right of the tree viewer. Selecting a record will draw the corresponding histogram. Records can be played using the arrow buttons near to the record button. When saving the session, the list of records is being saved as well.

Records have a default name corresponding to the Z: Y: X selection, but this can be changed using `SetRecordName()` method from the right panel context menu. You can create a new expression by right clicking on any of the `E()` boxes. The expression can be dragged and dropped into any of the boxes (X, Y, Z, Cut, or Scan). To scan one or more variables, drop them into the Scan box, then double click on the box. You can also redirect the result of the scan to a file by checking the Scan box on top.



When the “Rec” box is checked, the Draw and Scan commands are recorded in the history file and echoed on the command line. The “Histogram” text box contains the name of the resulting histogram. By default it is `htemp`. You can type any name, if the histogram does not exist it will create one. The Option text box contains the list of Draw options. See “Draw Options”. You can select the options with the Options menu. The Command box lets you enter any command that you could also enter on the command line. The vertical slider on the far left side can be used to select the minimum and maximum of an event range. The actual start and end index are shown in on the bottom in the status window.

There is an extensive help utility accessible with the Help menu. The `IList` and `OList` are to specify an input list of entry indices and a name for the output list respectively. Both need to be of type `TList` and contain integers of entry indices. These lists are described below in the paragraph “**Error! Reference source not found.**”.

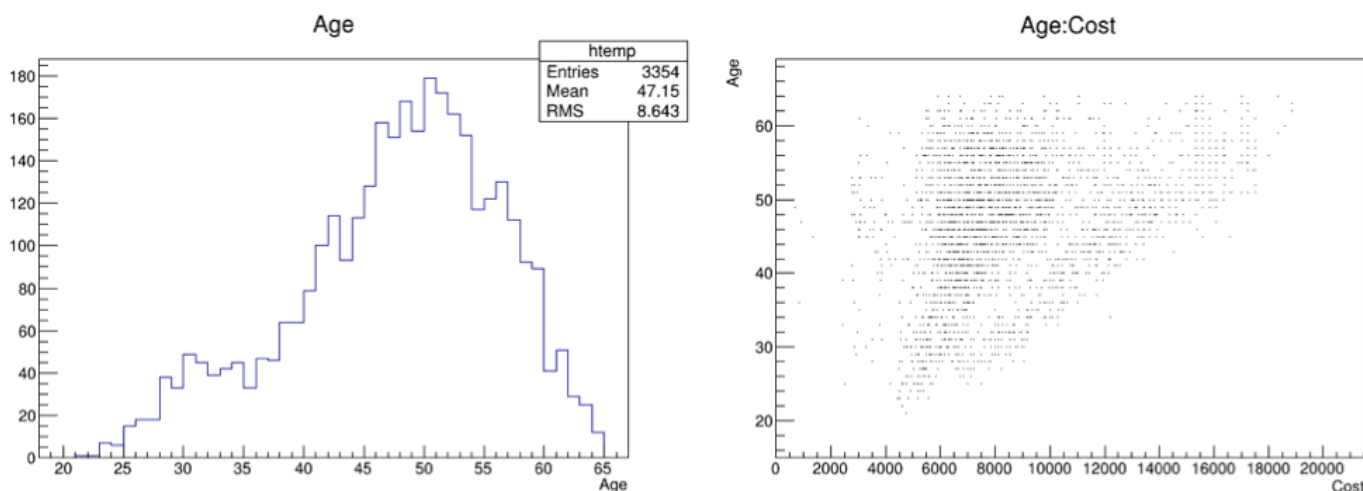

Figure 12.2: A couple of graphs

The first one is a plot of the age distribution, the second a scatter plot of the cost vs. age. The second one was generated by dragging the age leaf into the Y-box and the cost leaf into the X-box, and pressing the Draw button. By default, this will generate a scatter plot. Select a different option, for example "lego" to create a 2D histogram.

## 12.7 Creating and Saving Trees

This picture shows the `TTree` class:

To create a `TTree` we use its constructor. Then we design our data layout and add the branches. A tree can be created by giving a name and title:

```
TTree t("MyTree", "Example Tree");
```

### 12.7.1 Creating a Tree from a Folder Hierarchy

An alternative way to create a tree and organize it is to use folders (see “Folders and Tasks”). You can build a folder structure and create a tree with branches for each of the sub-folders:

```
TTree folder_tree("MyFolderTree", "/MyFolder");
```

The second argument `"/MyFolder"` is the top folder, and the `"/` signals the `TTree` constructor that this is a folder not just the title. You fill the tree by placing the data into the folder structure and calling `TTree::Fill`.

### 12.7.2 Tree and TRef Objects

```
MyTree->BranchRef();
```

This call requests the construction of an optional branch supporting table of references (`TRefTable`). This branch (`TBranchRef`) will keep all the information needed to find the branches containing referenced objects at each `Tree::Fill`, the branch numbers containing the referenced objects are saved in the table of references. When the Tree header is saved (via `TTree::Write` for example), the branch is saved, keeping the information with the pointers to the branches having referenced objects. Enabling this optional table, allow `TTree::Draw` to automatically load the branches needed to dereference a `TRef` (or `TRefArray`) object.

### 12.7.3 Autosave

`Autosave` gives the option to save all branch buffers every `n` byte. We recommend using `Autosave` for large acquisitions. If the acquisition fails to complete, you can recover the file and all the contents since the last `Autosave`. To set the number of bytes between `Autosave` you can use the `TTree::SetAutosave()` method. You can also call `TTree::Autosave` in the acquisition loop every `nentry`.

### 12.7.4 Trees with Circular Buffers

When a `TTree` is memory resident, you set it up so that it retains retain only the last few entries. For example, this can be very useful for monitoring purpose.

```
void TTree::SetCircular(Long64_t maxEntries);
```

where `maxEntries` is the maximum number of entries to be kept in the buffers. When the number of entries exceeds this value, the first entries in the `Tree` are deleted and the buffers used again. An example of a script using a circular buffer is shown below:



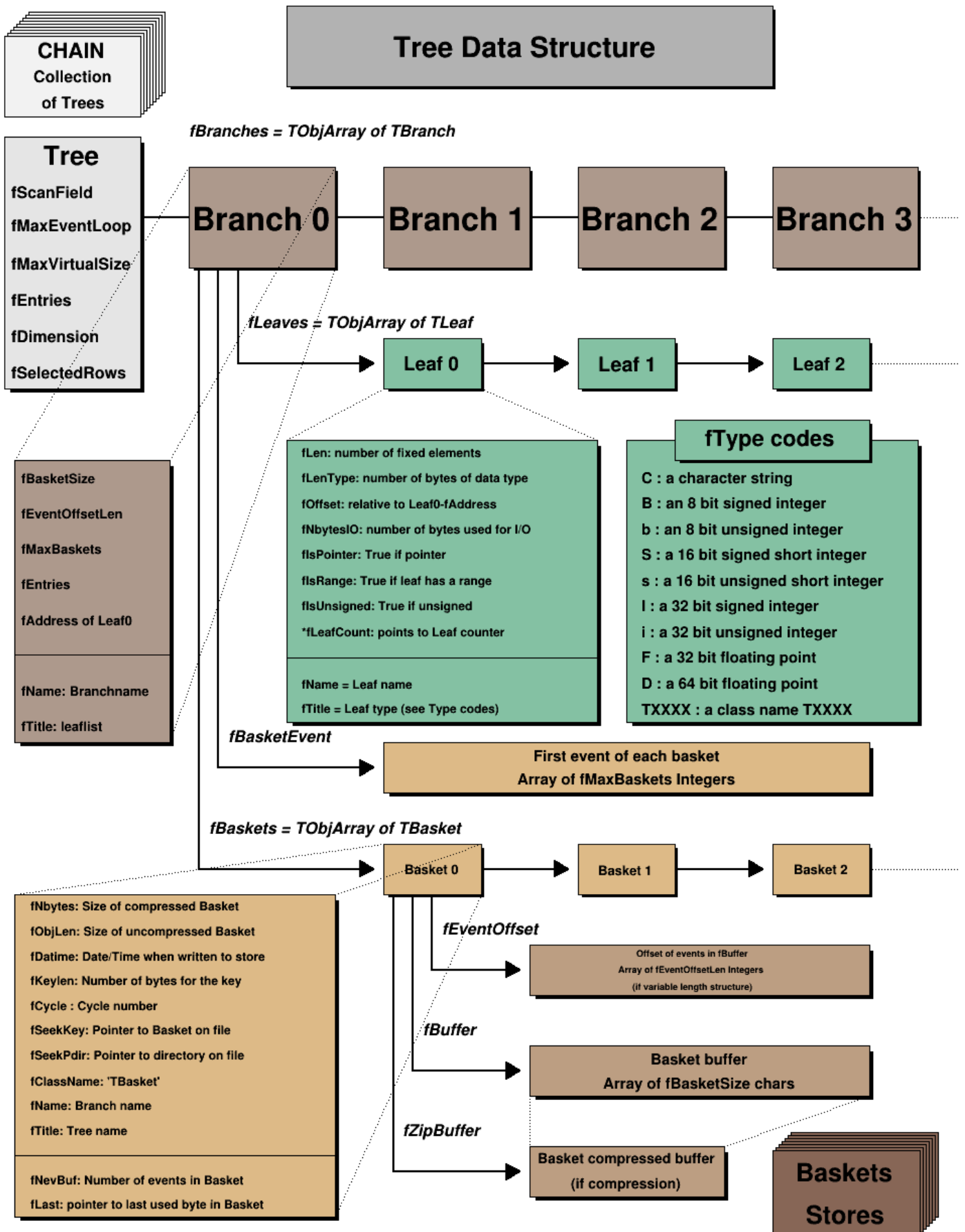

Figure 12.3: The TTree class

```

void circular() {
    gROOT->cd(); //make sure that the Tree is memory resident
    TTree *T = new TTree("T","test circular buffers");
    TRandom r;
    Float_t px,py,pz;
    Double_t random;
    UShort_t i;
    T->Branch("px",&px,"px/F");
    T->Branch("py",&py,"py/F");
    T->Branch("pz",&pz,"pz/F");
    T->Branch("random",&random,"random/D");
    T->Branch("i",&i,"i/s");
    T->SetCircular(20000);
    for (i = 0; i < 65000; i++) {
        r.Rannor(px,py);
        pz = px*px + py*py;
        random = r.Rndm();
        T->Fill();
    }
    T->Print();
}

```

### 12.7.5 Size of TTree in the File

When writing a **TTree** to a file, if the file size reaches the value stored in the `TTree::GetMaxTreeSize()`, the current file is closed and a new file is created. If the original file is named “myfile.root”, subsequent files are named “myfile\_1.root”, “myfile\_2.root”, etc.

Currently, the automatic change of file is restricted to the case where the tree is in the top level directory. The file should not contain sub-directories. Before switching to a new file, the tree header is written to the current file, then the current file is closed. To process the multiple files created by `ChangeFile()`, one must use a **TChain**.

The new file name has a suffix “\_N” where N is equal to `fFileNumber+1`. By default a Root session starts with `fFileNumber=0`. One can set `fFileNumber` to a different value via `TTree::SetFileNumber()`. In case a file named “\_N” already exists, the function will try a file named “\_\_N”, then “\_\_\_N”, etc. The maximum tree size can be set via the static function `TTree::SetMaxTreeSize()`. The default value of `fgMaxTreeSize` is 1.9 GB. If the current file contains other objects (like **TH1** and **TTree**), these objects are automatically moved to the new file.

### 12.7.6 User Info Attached to a TTree Object

The function `TTree::GetUserInfo()` allows adding any object defined by a user to the tree that is not depending on the entry number. For example:

```
tree->GetUserInfo()->Add(myruninfo);
```

### 12.7.7 Indexing a Tree

Use `TTree::BuildIndex()`, to build an index table using expressions depending on the value in the leaves.

```
tree->BuildIndex(majorname, minorname);
```

The index is built in the following way:

- a pass on all entries is made like in `TTree::Draw()`
- `var1 = majorname`
- `var2 = minorname`

- $sel = 2^{31} \times majorname + minorname$
- for each entry in the tree the sel expression is evaluated and the results array is sorted into `fIndexValues`

Once the index is computed, using the `TTree::GetEntryWithIndex(majornumber, minornumber)` one entry can be retrieved. Example:

```
// to create an index using leaves Run and Event
tree.BuildIndex("Run", "Event");
// to read entry corresponding to Run=1234 and Event=56789
tree.GetEntryWithIndex(1234, 56789);
```

Note that `majorname` and `minorname` may be expressions using original tree variables e.g.: “run-90000”, “event +3\*xx”. In case an expression is specified, the equivalent expression must be computed when calling `GetEntryWithIndex()`. To build an index with only `majorname`, specify `minorname="0"` (default).

Note that once the index is built, it can be saved with the `TTree` object with:

```
tree.Write(); //if the file has been open in "update" mode
```

The most convenient place to create the index is at the end of the filling process just before saving the tree header. If a previous index was computed, it is redefined by this new call.

Note that this function can also be applied to a `TChain`. The return value is the number of entries in the Index (< 0 indicates failure).

## 12.8 Branches

The organization of branches allows the designer to optimize the data for the anticipated use. The class for a branch is called `TBranch`. If two variables are independent, and the designer knows the variables will not be used together, they should be placed on separate branches. If, however, the variables are related, such as the coordinates of a point, it is most efficient to create one branch with both coordinates on it. A variable on a `TBranch` is called a leaf (yes - `TLeaf`). Another point to keep in mind when designing trees is that branches of the same `TTree` can be written to separate files. To add a `TBranch` to a `TTree` we call the method `TTree::Branch()`. Note that we DO NOT use the `TBranch` constructor.

The `TTree::Branch` method has several signatures. The branch type differs by what is stored in it. A branch can hold an entire object, a list of simple variables, contents of a folder, contents of a `TList`, or an array of objects. Let's see some examples. To follow along you will need the shared library `libEvent.so`. First, check if it is in `$ROOTSYS/test`. If it is, copy it to your own area. If it is not there, you have to build it by typing `make` in `$ROOTSYS/test`.

## 12.9 Adding a Branch to Hold a List of Variables

As in the very first example (`staff.root`) the data we want to save is a list of simple variables, such as integers or floats. In this case, we use the following `TTree::Branch` signature:

```
tree->Branch("Ev_Branch", &event,
            "temp/F:ntrack/I:nseg:ntex:flag/i");
```

The first parameter is the branch name.

The second parameter is the address from which the first variable is to be read. In the code above, “event” is a structure with one float and three integers and one unsigned integer. You should not assume that the compiler aligns the elements of a structure without gaps. To avoid alignment problems, you need to use structures with same length members. If your structure does not qualify, you need to create one branch for each element of the structure.

The leaf name is NOT used to pick the variable out of the structure, but is only used as the name for the leaf. This means that the list of variables needs to be in a structure in the order described in the third parameter.

This third parameter is a string describing the leaf list. Each leaf has a name and a type separated by a “/” and it is separated from the next leaf by a “:”.

```
<Variable>/<type>:<Variable>/<type>
```

The example on the next line has two leaves: a floating-point number called `temp` and an integer named `ntrack`.

```
"temp/F:ntrack/I:"
```

The type can be omitted and if no type is given, the same type as the previous variable is assumed. This leaf list has three integers called `ntrack`, `nseg`, and `nvtx`.

```
"ntrack/I:nseg:nvtx"
```

There is one more rule: when no type is given for the very first leaf, it becomes a `float` (F). This leaf list has three floats called `temp`, `mass`, and `px`.

```
"temp:mass:px"
```

The symbols used for the type are:

- C: a character string terminated by the 0 character
- B: an 8 bit signed integer
- b: an 8 bit unsigned integer
- S: a 16 bit signed integer
- s: a 16 bit unsigned integer
- I: a 32 bit signed integer
- i: a 32 bit unsigned integer
- L: a 64 bit signed integer
- l: a 64 bit unsigned integer
- F: a 32 bit floating point
- D: a 64 bit floating point
- O: [the letter 'o', not a zero] a boolean (`Bool_t`)

The type is used for a byte count to decide how much space to allocate. The variable written is simply the block of bytes starting at the starting address given in the second parameter. It may or may not match the leaf list depending on whether or not the programmer is being careful when choosing the leaf address, name, and type.

By default, a variable will be copied with the number of bytes specified in the type descriptor symbol. However, if the type consists of two characters, the number specifies the number of bytes to be used when copying the variable to the output buffer. The line below describes `ntrack` to be written as a 16-bit integer (rather than a 32-bit integer).

```
"ntrack/I2"
```

With this Branch method, you can also add a leaf that holds an entire array of variables. To add an array of floats use the `f[n]` notation when describing the leaf.

```
Float_t f[10];
tree->Branch("fBranch",f,"f[10]/F");
```

You can also add an array of variable length:

```
{
  TFile *f = new TFile("peter.root","recreate");
  Int_t nPhot;
  Float_t E[500];
  TTree* nEmcPhotons = new TTree("nEmcPhotons","EMC Photons");
  nEmcPhotons->Branch("nPhot",&nPhot,"nPhot/I");
  nEmcPhotons->Branch("E",E,"E[nPhot]/F");
}
```

See “Example 2: A Tree with a C Structure” below (`$ROOTSYS/tutorials/tree/tree2.C`) and `staff.C` at the beginning of this chapter.

## 12.10 Adding a TBranch to Hold an Object

To write a branch to hold an event object, we need to load the definition of the `Event` class, which is in `$ROOTSYS/test/libEvent.so` (if it doesn't exist type make in `$ROOTSYS/test`). An object can be saved in a tree if a `ROOT` dictionary for its class has been generated and loaded.

```
root[] .L libEvent.so
```

First, we need to open a file and create a tree.

```
root[] TFile *f = new TFile("AFile.root","RECREATE")
root[] TTree *tree = new TTree("T","A Root Tree")
```

We need to create a pointer to an `Event` object that will be used as a reference in the `TTree::Branch` method. Then we create a branch with the `TTree::Branch` method.

```
root[] Event *event = new Event()
root[] tree->Branch("EventBranch","Event",&event,32000,99)
```

To add a branch to hold an object we use the signature above. The first parameter is the name of the branch. The second parameter is the name of the class of the object to be stored. The third parameter is the address of a pointer to the object to be stored.

Note that it is an address of a pointer to the object, not just a pointer to the object.

The fourth parameter is the buffer size and is by default 32000 bytes. It is the number of bytes of data for that branch to save to a buffer until it is saved to the file. The last parameter is the split-level, which is the topic of the next section. Static class members are not part of an object and thus not written with the object. You could store them separately by collecting these values in a special "status" object and write it to the file outside of the tree. If it makes sense to store them for each object, make them a regular data member.

### 12.10.1 Setting the Split-level

To split a branch means to create a sub-branch for each data member in the object. The split-level can be set to 0 to disable splitting or it can be set to a number between 1 and 99 indicating the depth of splitting.

If the split-level is set to zero, the whole object is written in its entirety to one branch. The `TTree` will look like the one on the right, with one branch and one leaf holding the entire event object.

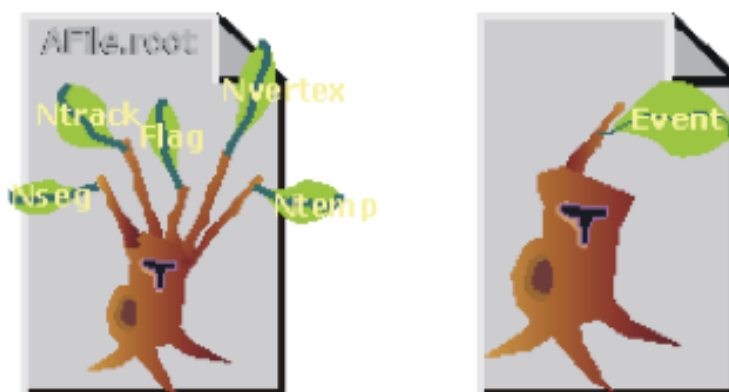

Figure 12.4: A split and not split tree

When the split-level is 1, an object data member is assigned a branch. If the split-level is 2, the data member objects will be split also, and a split level of 3 its data members objects, will be split. As the split-level increases so does the splitting depth. The `ROOT` default for the split-level is 99. This means the object will be split to the maximum.

### 12.10.1.1 Memory Considerations when Splitting a Branch

Splitting a branch can quickly generate many branches. Each branch has its own buffer in memory. In case of many branches (say more than 100), you should adjust the buffer size accordingly. A recommended buffer size is 32000 bytes if you have less than 50 branches. Around 16000 bytes if you have less than 100 branches and 4000 bytes if you have more than 500 branches. These numbers are recommended for computers with memory size ranging from 32MB to 256MB. If you have more memory, you should specify larger buffer sizes. However, in this case, do not forget that your file might be used on another machine with a smaller memory configuration.

### 12.10.1.2 Performance Considerations when Splitting a Branch

A split branch is faster to read, but slightly slower to write. The reading is quicker because variables of the same type are stored consecutively and the type does not have to be read each time. It is slower to write because of the large number of buffers as described above. See "

Performance Benchmarks" for performance impact of split and non-split mode.

### 12.10.1.3 Rules for Splitting

When splitting a branch, variables of different types are handled differently. Here are the rules that apply when splitting a branch.

- If a data member is a basic type, it becomes one branch of class **TBranchElement**.
- A data member can be an array of basic types. In this case, one single branch is created for the array.
- A data member can be a pointer to an array of basic types. The length can vary, and must be specified in the comment field of the data member in the class definition. See "Input/Output".
- Pointer data member are not split, except for pointers to a **TClonesArray**. The **TClonesArray** (pointed to) is split if the split level is greater than two. When the split level is one, the **TClonesArray** is not split.
- If a data member is a pointer to an object, a special branch is created. The branch will be filled by calling the class **Streamer** function to serialize the object into the branch buffer.
- If a data member is an object, the data members of this object are split into branches according to the split-level (i.e. split-level > 2).
- Base classes are split when the object is split.
- Abstract base classes are never split.
- All STL containers are supported.

```
// STL vector of vectors of TAxis*
vector<vector<TAxis *> > fVectAxis;
// STL map of string/vector
map<string,vector<int> > fMapString;
// STL deque of pair
deque<pair<float,float> > fDequePair;
```

- As of ROOT 4.01/00, only `std::vector` of objects can be split. Support for splitting the other type of STL containers will be introduced in the near future.
- C-structure data members are not supported in split mode.
- An object that is not split may be slow to browse.
- A STL container that is not split will not be accessible in the browser.



The method returns the total number of branches created. Each entry in the collection becomes a top level branch if the corresponding class is not a collection. If it is a collection, the entry in the collection becomes in turn top level branches, etc. The split level is decreased by 1 every time a new collection is found. For example if `list` is a `TObjArray*`

- If `splitlevel = 1`, one top level branch is created for each element of the `TObjArray`.
- If `splitlevel = 2`, one top level branch is created for each array element. If one of the array elements is a `TCollection`, one top level branch will be created for each element of this collection.

In case a collection element is a `TClonesArray`, the special Tree constructor for `TClonesArray` is called. The collection itself cannot be a `TClonesArray`. If `name` is given, all branch names will be prefixed with `name_`.

*IMPORTANT NOTE1:* This function should not be called if `splitlevel < 1`. *IMPORTANT NOTE2:* The branches created by this function will have names corresponding to the collection or object names. It is important to give names to collections to avoid misleading branch names or identical branch names. By default collections have a name equal to the corresponding class name, e.g. the default name of `TList` is “`TList`”.

## 12.13 Examples for Writing and Reading Trees

The following sections are examples of writing and reading trees increasing in complexity from a simple tree with a few variables to a tree containing folders and complex Event objects. Each example has a named script in the `$ROOTSYS/tutorials/tree` directory. They are called `tree1.C` to `tree4.C`. The examples are:

- `tree1.C`: a tree with several simple (integers and floating point) variables.
- `tree2.C`: a tree built from a C structure (`struct`). This example uses the `Geant3 C` wrapper as an example of a FORTRAN common block ported to C with a C structure.
- `tree3.C`: in this example, we will show how to extend a tree with a branch from another tree with the Friends feature. These trees have branches with variable length arrays. Each entry has a variable number of tracks, and each track has several variables.
- `tree4.C`: a tree with a class (`Event`). The class `Event` is defined in `$ROOTSYS/test`. In this example we first encounter the impact of splitting a branch.

Each script contains the main function, with the same name as the file (i.e. `tree1`), the function to write - `tree1w`, and the function to read - `tree1r`. If the script is not run in batch mode, it displays the tree in the browser and tree viewer. To study the example scripts, you can either execute the main script, or load the script and execute a specific function. For example:

```
// execute the function that writes, reads, shows the tree
root[] x tree1.C
// use ACLiC to build shared library, check syntax, execute
root[] x tree1.C++
// Load the script and select a function to execute
root[] L tree1.C
root[] tree1w()
root[] tree1r()
```

## 12.14 Example 1: A Tree with Simple Variables

This example shows how to write, view, and read a tree with several simple (integers and floating-point) variables.



### 12.14.1 Writing the Tree

Below is the function that writes the tree (`tree1w`). First, the variables are defined (`px`, `py`, `pz`, `random` and `ev`). Then we add a branch for each of the variables to the tree, by calling the `TTree::Branch` method for each variable.

```
void tree1w(){
    // create a tree file tree1.root - create the file, the Tree and
    // a few branches
    TFile f("tree1.root","recreate");
    TTree t1("t1","a simple Tree with simple variables");
    Float_t px, py, pz;
    Double_t random;
    Int_t ev;
    t1.Branch("px",&px,"px/F");
    t1.Branch("py",&py,"py/F");
    t1.Branch("pz",&pz,"pz/F");
    t1.Branch("ev",&ev,"ev/I");

    // fill the tree
    for (Int_t i=0; i<10000; i++) {
        gRandom->Rannor(px,py);
        pz = px*px + py*py;
        random = gRandom->Rndm();
        ev = i;
        t1.Fill();
    }
    // save the Tree heade; the file will be automatically closed
    // when going out of the function scope
    t1.Write();
}
```

#### 12.14.1.1 Creating Branches with A single Variable

This is the signature of `TTree::Branch` to create a branch with a list of variables:

```
TBranch* TTree::Branch(const char* name,void* address,
                      const char* leaflist,
                      Int_t bufsize = 32000)
```

The first parameter is the branch name. The second parameter is the address from which to read the value. The third parameter is the leaf list with the name and type of each leaf. In this example, each branch has only one leaf. In the box below, the branch is named `px` and has one floating point type leaf also called `px`.

```
t1.Branch("px",&px,"px/F");
```

#### 12.14.1.2 Filling the Tree

First we find some random values for the variables. We assign `px` and `py` a Gaussian with mean = 0 and sigma = 1 by calling `gRandom->Rannor(px,py)`, and calculate `pz`. Then we call the `TTree::Fill()` method. The call `t1.Fill()` fills all branches in the tree because we have already organized the tree into branches and told each branch where to get the value from. After this script is executed we have a ROOT file called `tree1.root` with a tree called `t1`. There is a possibility to fill branches one by one using the method `TBranch::Fill()`. In this case you do not need to call `TTree::Fill()` method. The entries can be set by `TTree::SetEntries(Double_t n)`. Calling this method makes sense only if the number of existing entries is null.

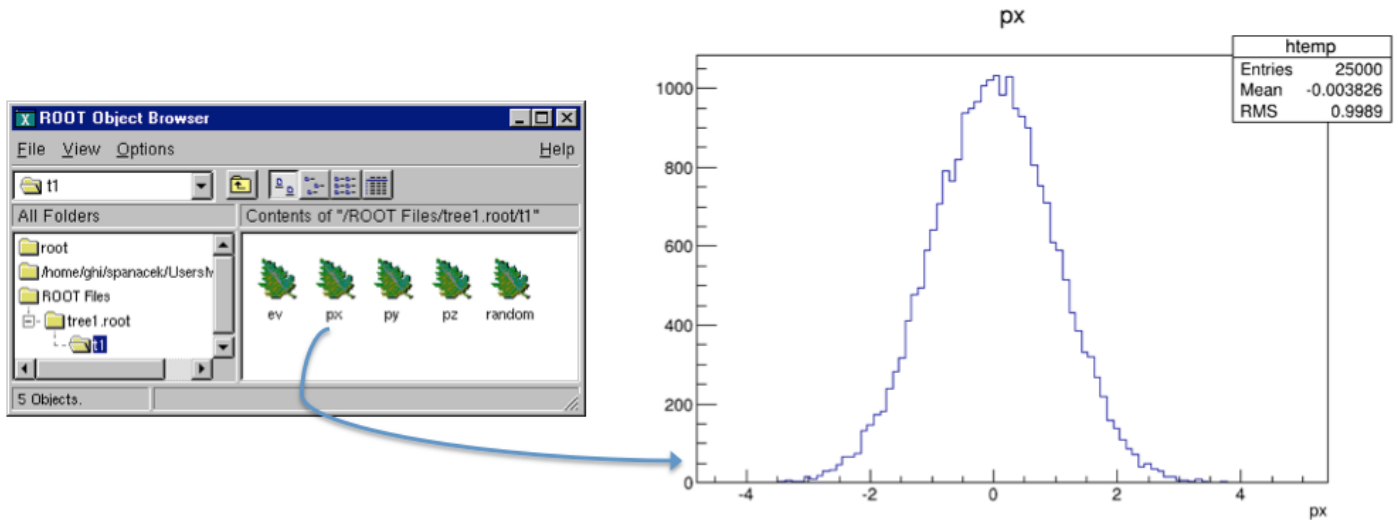

Figure 12.5: The tree1.root file and its tree in the browser and a leaf histogram

### 12.14.2 Viewing the Tree

In the right panel of the ROOT object browser are the branches: `ev`, `px`, `py`, `pz`, and `random`. Note that these are shown as leaves because they are “end” branches with only one leaf. To histogram a leaf, we can simply double click on it in the browser. This is how the tree `t1` looks in the Tree Viewer. Here we can add a cut and add other operations for histogramming the leaves. See “The Tree Viewer”. For example, we can plot a two dimensional histogram.

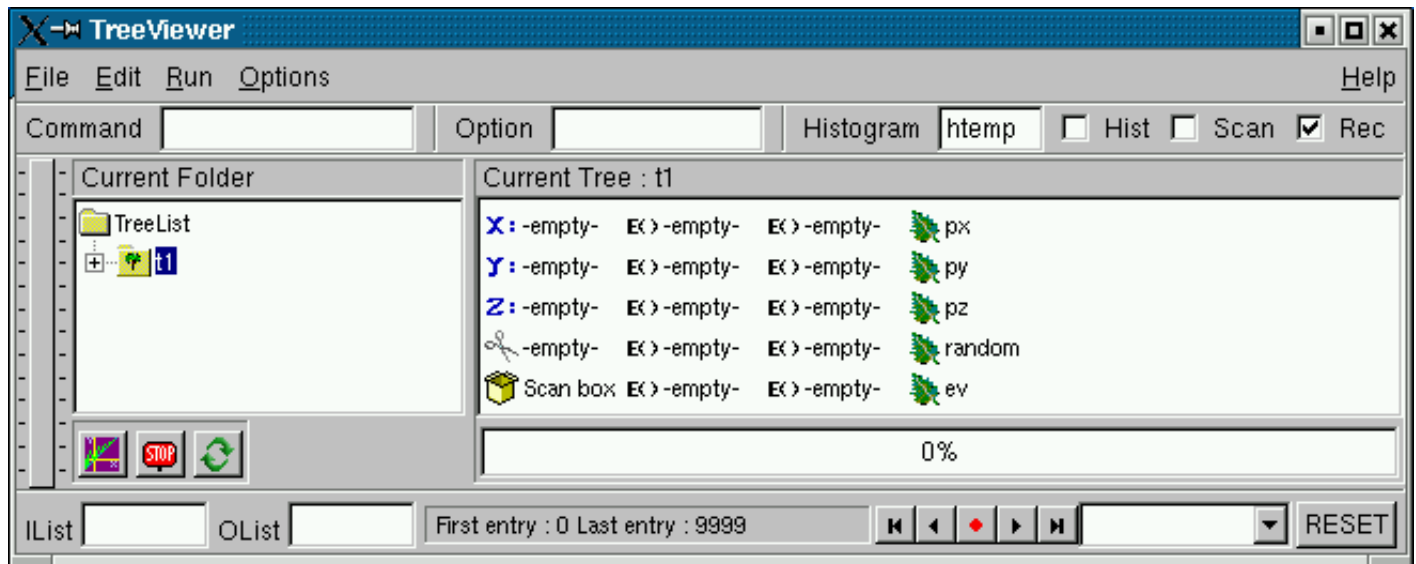

Figure 12.6: The tree viewer

### 12.14.3 Reading the Tree

The `tree1r` function shows how to read the tree and access each entry and each leaf. We first define the variables to hold the read values.

```
Float_t px, py, pz;
```

Then we tell the tree to populate these variables when reading an entry. We do this with the method `TTree::SetBranchAddresses`. The first parameter is the branch name, and the second is the address of the variable where the branch data is to be placed. In this example, the branch name is `px`. This name was given when the tree was written (see `tree1w`). The second parameter is the address of the variable `px`.

```
t1->SetBranchAddress("px",&px);
```

### 12.14.3.1 GetEntry

Once the branches have been given the address, a specific entry can be read into the variables with the method `TTree::GetEntry(n)`. It reads all the branches for entry (n) and populates the given address accordingly. By default, `GetEntry()` reuses the space allocated by the previous object for each branch. You can force the previous object to be automatically deleted if you call `mybranch.SetAutoDelete(kTRUE)` (default is `kFALSE`).

Consider the example in `$ROOTSYS/test/Event.h`. The top-level branch in the tree T is declared with:

```
Event *event = 0;
// event must be null or point to a valid object;
// it must be initialized
T.SetBranchAddress("event",&event);
```

When reading the Tree, one can choose one of these 3 options:

Option 1:

```
for (Int_t i = 0; i<nentries; i++) {
  T.GetEntry(i);
  //the object event has been filled at this point
}
```

This is the default and recommended way to create an object of the class `Event`. It will be pointed by `event`.

At the following entries, `event` will be overwritten by the new data. All internal members that are `TObject*` are automatically deleted. It is important that these members be in a valid state when `GetEntry` is called. Pointers must be correctly initialized. However these internal members will not be deleted if the characters “->” are specified as the first characters in the comment field of the data member declaration.

The pointer member is read via the `pointer->Streamer(buf)` if “->” is specified. In this case, it is assumed that the pointer is never null (see pointer `TClonesArray *fTracks` in the `$ROOTSYS/test/Event` example). If “->” is not specified, the pointer member is read via `buf >> pointer`. In this case the pointer may be null. Note that the option with “->” is faster to read or write and it also consumes less space in the file.

Option 2 - the option `AutoDelete` is set:

```
TBranch *branch = T.GetBranch("event");
branch->SetAddress(&event);
branch->SetAutoDelete(kTRUE);
for (Int_t i=0; i<nentries; i++) {
  T.GetEntry(i); // the object event has been filled at this point
}
```

At any iteration, the `GetEntry` deletes the object `event` and a new instance of `Event` is created and filled.

Option 3 - same as option 1, but you delete the event yourself:

```
for (Int_t i=0; i<nentries; i++) {
  delete event;
  event = 0; //EXTREMELY IMPORTANT
  T.GetEntry(i);
  // the object event has been filled at this point
}
```

It is strongly recommended to use the default option 1. It has the additional advantage that functions like `TTree::Draw` (internally calling `TTree::GetEntry`) will be functional even when the classes in the file are not available. Reading selected branches is quicker than reading an entire entry. If you are interested in only one branch, you can use the `TBranch::GetEntry` method and only that branch is read. Here is the script `tree1r`:

```

void tree1r(){
    // read the Tree generated by tree1w and fill two histograms
    // note that we use "new" to create the TFile and TTree objects,
    // to keep them alive after leaving this function.
    TFile *f = new TFile("tree1.root");
    TTree *t1 = (TTree*)f->Get("t1");
    Float_t px, py, pz;
    Double_t random;
    Int_t ev;
    t1->SetBranchAddress("px",&px);
    t1->SetBranchAddress("py",&py);
    t1->SetBranchAddress("pz",&pz);
    t1->SetBranchAddress("random",&random);
    t1->SetBranchAddress("ev",&ev);
    // create two histograms
    TH1F *hpx = new TH1F("hpx","px distribution",100,-3,3);
    TH2F *hpxpy = new TH2F("hpxpy","py vs px",30,-3,3,30,-3,3);
    //read all entries and fill the histograms
    Int_t nentries = (Int_t)t1->GetEntries();
    for (Int_t i=0; i<nentries; i++) {
        t1->GetEntry(i);
        hpx->Fill(px);
        hpxpy->Fill(px,py);
    }
    // We do not close the file. We want to keep the generated
    // histograms we open a browser and the TreeViewer
    if (gROOT->IsBatch()) return;
    new TBrowser ();
    t1->StartViewer();

    //In the browser, click on "ROOT Files", then on "tree1.root"
    //You can click on the histogram icons in the right panel to draw
    //them in the TreeViewer, follow the instructions in the Help.
}

```

## 12.15 Example 2: A Tree with a C Structure

The executable script for this example is `$ROOTSYS/tutorials/tree/tree2.C`. In this example we show:

- how to build branches from a C structure
- how to make a branch with a fixed length array
- how to make a branch with a variable length array
- how to read selective branches
- how to fill a histogram from a branch
- how to use `TTree::Draw` to show a 3D plot

A C structure (`struct`) is used to build a ROOT tree. In general we discourage the use of C structures, we recommend using a class instead. However, we do support them for legacy applications written in C or FORTRAN. The example `struct` holds simple variables and arrays. It maps to a Geant3 common block `/gctrak/`. This is the definition of the common block/structure:

```

const Int_t MAXMEC = 30;
// PARAMETER (MAXMEC=30)
// COMMON/GCTRAK/VECT(7),GETOT,GEKIN,VOUT(7)
//     + ,NMEC,LMEC(MAXMEC)
//     + ,NAMEC(MAXMEC),NSTEP

```

```

//      + ,PID,DESTEP,DESTEL,SAFETY,SENG
//      + ,STEP,SNEXT,SFIELD,TOFG,GEKRAT,UPWGHT

typedef struct {
    Float_t  vect[7];
    Float_t  getot;
    Float_t  gekin;
    Float_t  vout[7];
    Int_t    nmec;
    Int_t    lmec[MAXMEC];
    Int_t    namec[MAXMEC];
    Int_t    nstep;
    Int_t    pid;
    Float_t  destep;
    Float_t  destel;
    Float_t  safety;
    Float_t  sleng;
    Float_t  step;
    Float_t  snext;
    Float_t  sfield;
    Float_t  tofg;
    Float_t  gekrat;
    Float_t  upwght;
} Gctrak_t;

```

When using Geant3, the common block is filled by Geant3 routines at each step and only the `TTree::Fill` method needs to be called. In this example we emulate the Geant3 step routine with the `helixStep` function. We also emulate the filling of the particle values. The calls to the `Branch` methods are the same as if Geant3 were used.

```

void helixStep(Float_t step, Float_t *vect, Float_t *vout)
{
    // extrapolate track in constant field
    Float_t field = 20; // field in kilogauss
    enum Evect {kX,kY,kZ,kPX,kPY,kPZ,kPP};
    vout[kPP] = vect[kPP];

    Float_t h4    = field*2.99792e-4;
    Float_t rho   = -h4/vect[kPP];
    Float_t tet   = rho*step;
    Float_t tsint = tet*tet/6;
    Float_t sintt = 1 - tsint;
    Float_t sint  = tet*sintt;
    Float_t cos1t = tet/2;
    Float_t f1    = step*sintt;
    Float_t f2    = step*cos1t;
    Float_t f3    = step*tsint*vect[kPZ];
    Float_t f4    = -tet*cos1t;
    Float_t f5    = sint;
    Float_t f6    = tet*cos1t*vect[kPZ];

    vout[kX] = vect[kX] + (f1*vect[kPX] - f2*vect[kPY]);
    vout[kY] = vect[kY] + (f1*vect[kPY] + f2*vect[kPX]);
    vout[kZ] = vect[kZ] + (f1*vect[kPZ] + f3);
    vout[kPX] = vect[kPX] + (f4*vect[kPX] - f5*vect[kPY]);
    vout[kPY] = vect[kPY] + (f4*vect[kPY] + f5*vect[kPX]);
    vout[kPZ] = vect[kPZ] + (f4*vect[kPZ] + f6);
}

```

## 12.15.1 Writing the Tree

```

void tree2w() {
    // write tree2 example
    //create a Tree file tree2.root
    TFile f("tree2.root","recreate");

    //create the file, the Tree
    TTree t2("t2","a Tree with data from a fake Geant3");
    // declare a variable of the C structure type
    Gctrak_t gstep;

    // add the branches for a subset of gstep
    t2.Branch("vect",gstep.vect,"vect[7]/F");
    t2.Branch("getot",&gstep.getot,"getot/F");
    t2.Branch("gekin",&gstep.gekin,"gekin/F");
    t2.Branch("nmec",&gstep.nmec,"nmec/I");
    t2.Branch("lmec",gstep.lmec,"lmec[nmec]/I");
    t2.Branch("destep",&gstep.destep,"destep/F");
    t2.Branch("pid",&gstep.pid,"pid/I");

    //Initialize particle parameters at first point
    Float_t px,py,pz,p,charge=0;
    Float_t vout[7];
    Float_t mass = 0.137;
    Bool_t newParticle = kTRUE;
    gstep.step = 0.1;
    gstep.destep = 0;
    gstep.nmec = 0;
    gstep.pid = 0;

    //transport particles
    for (Int_t i=0; i<10000; i++) {
        //generate a new particle if necessary (Geant3 emulation)
        if (newParticle) {
            px = gRandom->Gaus(0,.02);
            py = gRandom->Gaus(0,.02);
            pz = gRandom->Gaus(0,.02);
            p = TMath::Sqrt(px*px+py*py+pz*pz);
            charge = 1;
            if (gRandom->Rndm() < 0.5) charge = -1;
            gstep.pid += 1;
            gstep.vect[0] = 0;
            gstep.vect[1] = 0;
            gstep.vect[2] = 0;
            gstep.vect[3] = px/p;
            gstep.vect[4] = py/p;
            gstep.vect[5] = pz/p;
            gstep.vect[6] = p*charge;
            gstep.getot = TMath::Sqrt(p*p + mass*mass);
            gstep.gekin = gstep.getot - mass;
            newParticle = kFALSE;
        }
        // fill the Tree with current step parameters
        t2.Fill();

        //transport particle in magnetic field (Geant3 emulation)
        helixStep(gstep.step, gstep.vect, vout);
    }
}

```

```

//make one step
//apply energy loss
gstep.dstep = gstep.step*gRandom->Gaus(0.0002,0.00001);
gstep.gekin -= gstep.dstep;
gstep.getot = gstep.gekin + mass;
gstep.vect[6]= charge*TMath::Sqrt(gstep.getot*gstep.getot
- mass*mass);
gstep.vect[0] = vout[0];
gstep.vect[1] = vout[1];
gstep.vect[2] = vout[2];
gstep.vect[3] = vout[3];
gstep.vect[4] = vout[4];
gstep.vect[5] = vout[5];
gstep.nmec = (Int_t)(5*gRandom->Rndm());
for (Int_t l=0; l<gstep.nmec; l++) gstep.lmec[l] = 1;
if (gstep.gekin < 0.001) newParticle = kTRUE;
if (TMath::Abs(gstep.vect[2]) > 30) newParticle = kTRUE;
}
//save the Tree header. The file will be automatically
// closed when going out of the function scope
t2.Write();
}

```

### 12.15.1.1 Adding a Branch with a Fixed Length Array

At first, we create a tree and create branches for a subset of variables in the C structure `Gctrak_t`. Then we add several types of branches. The first branch reads seven floating-point values beginning at the address of `'gstep.vect'`. You do not need to specify `&gstep.vect`, because in C and C++ the array variable holds the address of the first element.

```

t2.Branch("vect",gstep.vect,"vect[7]/F");
t2.Branch("getot",&gstep.getot,"getot/F");
t2.Branch("gekin",&gstep.gekin,"gekin/F");

```

### 12.15.1.2 Adding a Branch with a Variable Length Array

The next two branches are dependent on each other. The first holds the length of the variable length array and the second holds the variable length array. The `lmec` branch reads `nmec` number of integers beginning at the address `gstep.lmec`.

```

t2.Branch("nmec",&gstep.nmec,"nmec/I");
t2.Branch("lmec",gstep.lmec,"lmec[nmec]/I");

```

The variable `nmec` is a random number and is reset for each entry.

```

gstep.nmec = (Int_t)(5*gRandom->Rndm());

```

### 12.15.1.3 Filling the Tree

In this emulation of Geant3, we generate and transport particles in a magnetic field and store the particle parameters at each tracking step in a ROOT tree.

## 12.15.2 Analysis

In this analysis, we do not read the entire entry we only read one branch. First, we set the address for the branch to the file `dstep`, and then we use the `TBranch::GetEntry` method. Then we fill a histogram with the `dstep` branch entries, draw it and fit it with a Gaussian. In addition, we draw the particle's path using the three values in the vector. Here we use the `TTree::Draw` method. It automatically creates a histogram and plots the 3 expressions (see Trees in Analysis).

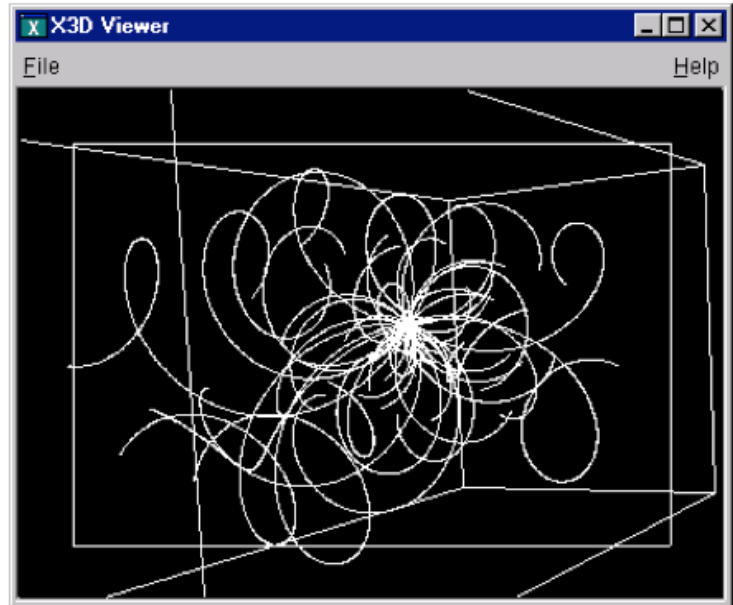
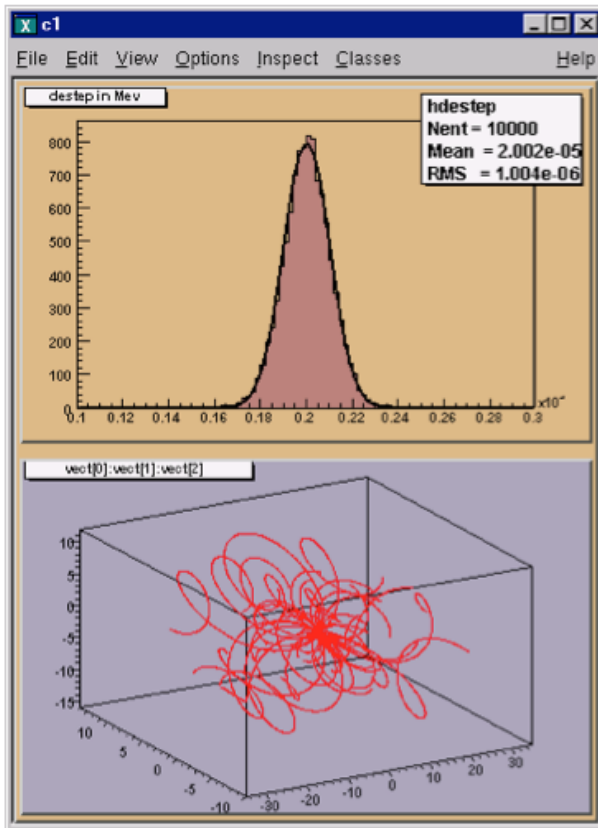

```

void tree2r() {

    // read the Tree generated by tree2w and fill one histogram
    // we are only interested by the destep branch

    // note that we use "new" to create the TFile and TTree objects because we
    // want to keep these objects alive when we leave this function
    TFile *f = new TFile("tree2.root");
    TTree *t2 = (TTree*)f->Get("t2");
    static Float_t destep;
    TBranch *b_destep = t2->GetBranch("destep");
    b_destep->SetAddress(&destep);

    //create one histogram
    TH1F *hdestep = new TH1F("hdestep","destep in Mev",100,1e-5,3e-5);
    //read only the destep branch for all entries
    Int_t nentries = (Int_t)t2->GetEntries();
    for (Int_t i=0;i<nentries;i++) {
        b_destep->GetEntry(i);
        // fill the histogram with the destep entry
        hdestep->Fill(destep);
    }

    // we do not close the file; we want to keep the generated histograms;
    // we fill a 3-d scatter plot with the particle step coordinates
    TCanvas *c1 = new TCanvas("c1","c1",600,800);
    c1->SetFillColor(42);
    c1->Divide(1,2);

    c1->cd(1);

```



```

hdestep->SetFillColor(45);
hdestep->Fit("gaus");

c1->cd(2);
gPad->SetFillColor(37);           // continued...
t2->SetMarkerColor(kRed);
t2->Draw("vect[0]:vect[1]:vect[2]");
if (gROOT->IsBatch()) return;

// invoke the x3d viewer
gPad->GetViewer3D("x3d");
}

```

## 12.16 Example 3: Adding Friends to Trees

In this example, we will show how to extend a tree with a branch from another tree with the Friends feature.

### 12.16.1 Adding a Branch to an Existing Tree

You may want to add a branch to an existing tree. For example, if one variable in the tree was computed with a certain algorithm, you may want to try another algorithm and compare the results. One solution is to add a new branch, fill it, and save the tree. The code below adds a simple branch to an existing tree. Note that the `kOverwrite` option in the `Write` method overwrites the existing tree. If it is not specified, two copies of the tree headers are saved.

```

void tree3AddBranch() {
    TFile f("tree3.root","update");
    Float_t new_v;
    TTree *t3 = (TTree*)f->Get("t3");
    TBranch *newBranch = t3-> Branch("new_v",&new_v,"new_v/F");
    //read the number of entries in the t3
    Int_t nentries = (Int_t)t3->GetEntries();
    for (Int_t i = 0; i < nentries; i++){
        new_v= gRandom->Gaus(0,1);
        newBranch->Fill();
    }
    t3->Write("",TObject::kOverwrite); // save only the new version of
    // the tree
}

```

Adding a branch is often not possible because the tree is in a read-only file and you do not have permission to save the modified tree with the new branch. Even if you do have the permission, you risk losing the original tree with an unsuccessful attempt to save the modification. Since trees are usually large, adding a branch could extend it over the 2GB limit. In this case, the attempt to write the tree fails, and the original data is may also be corrupted. In addition, adding a branch to a tree enlarges the tree and increases the amount of memory needed to read an entry, and therefore decreases the performance. For these reasons, ROOT offers the concept of friends for trees (and chains). We encourage you to use `TTree::AddFriend` rather than adding a branch manually.

### 12.16.2 TTree::AddFriend

A tree keeps a list of friends. In the context of a tree (or a chain), friendship means unrestricted access to the friends data. In this way it is much like adding another branch to the tree without taking the risk of damaging it. To add a friend to the list, you can use the `TTree::AddFriend` method. The `TTree` (`tree`) below has two friends (`ft1` and `ft2`) and now has access to the variables `a,b,c,i,j,k,l` and `m`.

The `AddFriend` method has two parameters, the first is the tree name and the second is the name of the ROOT file where the friend tree is saved. `AddFriend` automatically opens the friend file. If no file name is given, the tree called `ft1` is assumed to be in the same file as the original tree.

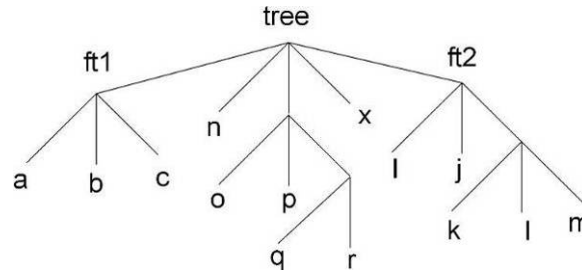

```
tree.AddFriend("ft1","friendfile1.root");
```

If the friend tree has the same name as the original tree, you can give it an alias in the context of the friendship:

```
tree.AddFriend("tree1 = tree","friendfile1.root");
```

Once the tree has friends, we can use `TTree::Draw` as if the friend's variables were in the original tree. To specify which tree to use in the `Draw` method, use the syntax:

```
<treeName>.<branchname>.<varname>
```

If the `variablename` is enough to identify uniquely the variable, you can leave out the tree and/or branch name.

For example, these commands generate a 3-d scatter plot of variable “`var`” in the `TTree tree` versus variable `v1` in `TTree ft1` versus variable `v2` in `**TTree**ft2`:

```
tree.AddFriend("ft1","friendfile1.root");
tree.AddFriend("ft2","friendfile2.root");
tree.Draw("var:ft1.v1:ft2.v2");
```

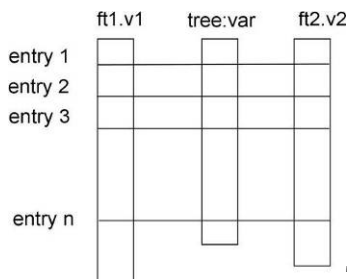

The picture illustrates the access of the tree and its friends with a `Draw` command.

When `AddFriend` is called, the `ROOT` file is automatically opened and the friend tree (`ft1`) header is read into memory. The new friend (`ft1`) is added to the list of friends of `tree`. The number of entries in the friend must be equal or greater to the number of entries of the original tree. If the friend tree has fewer entries, a warning is given and the missing entries are not included in the histogram.

Use `TTree::GetListOfFriends` to retrieve the list of friends from a tree.

When the tree is written to file (`TTree::Write`), the friends list is saved with it. Moreover, when the tree is retrieved, the trees on the friends list are also retrieved and the friendship restored. When a tree is deleted, the elements of the friend list are also deleted. It is possible to declare a friend tree that has the same internal structure (same branches and leaves) as the original tree, and compare the same values by specifying the tree.

```
tree.Draw("var:ft1.var:ft2.var");
```

The example code is in `$ROOTSYS/tutorials/tree/tree3.C`. Here is the script:

```
void tree3w() {
    // Example of a Tree where branches are variable length arrays
    // A second Tree is created and filled in parallel.
```

```

// Run this script with .x tree3.C
// In the function treer, the first Tree is open.
// The second Tree is declared friend of the first tree.
// TTree::Draw is called with variables from both Trees.
const Int_t kMaxTrack = 500;
Int_t ntrack;
Int_t stat[kMaxTrack];
Int_t sign[kMaxTrack];
Float_t px[kMaxTrack];
Float_t py[kMaxTrack];
Float_t pz[kMaxTrack];
Float_t pt[kMaxTrack];
Float_t zv[kMaxTrack];
Float_t chi2[kMaxTrack];
Double_t sumstat;

// create the first root file with a tree
TFile f("tree3.root","recreate");
TTree *t3 = new TTree("t3","Reconst ntuple");
t3->Branch("ntrack",&ntrack,"ntrack/I");
t3->Branch("stat",stat,"stat[ntrack]/I");
t3->Branch("sign",sign,"sign[ntrack]/I");
t3->Branch("px",px,"px[ntrack]/F");
t3->Branch("py",py,"py[ntrack]/F");
t3->Branch("pz",pz,"pz[ntrack]/F");
t3->Branch("zv",zv,"zv[ntrack]/F");
t3->Branch("chi2",chi2,"chi2[ntrack]/F");

// create the second root file with a different tree
TFile fr("tree3f.root","recreate");
TTree *t3f = new TTree("t3f","a friend Tree");
t3f->Branch("ntrack",&ntrack,"ntrack/I");
t3f->Branch("sumstat",&sumstat,"sumstat/D");
t3f->Branch("pt",pt,"pt[ntrack]/F");

// Fill the trees
for (Int_t i=0;i<1000;i++) {
    Int_t nt = gRandom->Rndm()*(kMaxTrack-1);
    ntrack = nt;
    sumstat = 0;
    // set the values in each track
    for (Int_t n=0;n<nt;n++) {
        stat[n] = n%3;
        sign[n] = i%2;
        px[n] = gRandom->Gaus(0,1);
        py[n] = gRandom->Gaus(0,2);
        pz[n] = gRandom->Gaus(10,5);
        zv[n] = gRandom->Gaus(100,2);
        chi2[n] = gRandom->Gaus(0,.01);
        sumstat += chi2[n];
        pt[n] = TMath::Sqrt(px[n]*px[n] + py[n]*py[n]);
    }
    t3->Fill();
    t3f->Fill();
}

// Write the two files
t3->Print();
f.cd();
t3->Write();

```

```

fr.cd();
t3f->Write();
}

// Function to read the two files and add the friend
void tree3r()
{
  TFile *f = new TFile("tree3.root");
  TTree *t3 = (TTree*)f->Get("t3");
  // Add the second tree to the first tree as a friend
  t3->AddFriend("t3f","tree3f.root");
  // Draw pz which is in the first tree and use pt
  // in the condition. pt is in the friend tree.
  t3->Draw("pz","pt>3");
}

// This is executed when typing .x tree3.C
void tree3() {
  tree3w();
  tree3r();
}

```

## 12.17 Example 4: A Tree with an Event Class

This example is a simplified version of `$ROOTSYS/test/MainEvent.cxx` and where Event objects are saved in a tree. The full definition of Event is in `$ROOTSYS/test/Event.h`. To execute this macro, you will need the library `$ROOTSYS/test/libEvent.so`. If it does not exist you can build the test directory applications by following the instruction in the `$ROOTSYS/test/README` file.

In this example we will show

- the difference in splitting or not splitting a branch
- how to read selected branches of the tree,
- how to print a selected entry

### 12.17.1 The Event Class

Event is a descendent of `TObject`. As such it inherits the data members of `TObject` and its methods such as `Dump()` and `Inspect()` and `Write()`. In addition, because it inherits from `TObject` it can be a member of a collection. To summarize, the advantages of inheriting from a `TObject` are:

- Inherit the `Write`, `Inspect`, and `Dump` methods
- Enables a class to be a member of a ROOT collection
- Enables RTTI

Below is the list of the Event data members. It contains a character array, several integers, a floating-point number, and an `EventHeader` object. The `EventHeader` class is described in the following paragraph. Event also has two pointers, one to a `TClonesArray` of tracks and one to a histogram. The string “->” in the comment field of the members `*fTracks` and `*fH` instructs the automatic `Streamer` to assume that the objects `*fTracks` and `*fH` are never null pointers and that `fTracks->Streamer` can be used instead of the more time consuming form `R__b << fTracks`.

```

class Event : public TObject {
private:
  char          fType[20];
  Int_t         fNtrack;
  Int_t         fNseg;
  Int_t         fNvertex;

```

```

UInt_t          fFlag;
Float_t         fTemperature;
EventHeader     fEvtHdr;
TClonesArray    *fTracks;          //->
TH1F           *fH;                //->
Int_t           fMeasures[10];
Float_t         fMatrix[4][4];
Float_t         *fClosestDistance; //[fNvertex]
static TClonesArray *fgTracks;
static TH1F     *fgHist;
// ... list of methods
ClassDef(Event,1) //Event structure
};

```

### 12.17.2 The EventHeader Class

The `EventHeader` class (also defined in `Event.h`) does not inherit from `TObject`. Beginning with ROOT 3.0, an object can be placed on a branch even though it does not inherit from `TObject`. In previous releases branching were restricted to objects inheriting from the `TObject`. However, it has always been possible to write a class not inheriting from `TObject` to a tree by encapsulating it in a `TObject` descending class as is the case in `EventHeader` and `Event`.

```

class EventHeader {
private:
    Int_t    fEvtNum;
    Int_t    fRun;
    Int_t    fDate;
    // ... list of methods
    ClassDef(EventHeader,1) //Event Header
};

```

### 12.17.3 The Track Class

The `Track` class descends from `TObject` since tracks are in a `TClonesArray` (i.e. a ROOT collection class) and contains a selection of basic types and an array of vertices. Its `TObject` inheritance enables `Track` to be in a collection and in `Event` is a `TClonesArray` of `Tracks`.

```

class Track : public TObject {
private:
    Float_t    fPx;           //X component of the momentum
    Float_t    fPy;           //Y component of the momentum
    Float_t    fPz;           //Z component of the momentum
    Float_t    fRandom;       //A random track quantity
    Float_t    fMass2;        //The mass square of this particle
    Float_t    fBx;           //X intercept at the vertex
    Float_t    fBy;           //Y intercept at the vertex
    Float_t    fMeanCharge;   //Mean charge deposition of all hits
    Float_t    fXfirst;       //X coordinate of the first point
    Float_t    fXlast;        //X coordinate of the last point
    Float_t    fYfirst;       //Y coordinate of the first point
    Float_t    fYlast;        //Y coordinate of the last point
    Float_t    fZfirst;       //Z coordinate of the first point
    Float_t    fZlast;        //Z coordinate of the last point
    Float_t    fCharge;       //Charge of this track
    Float_t    fVertex[3];    //Track vertex position
    Int_t      fNpoint;       //Number of points for this track
    Short_t    fValid;        //Validity criterion
};

```

```

    // method definitions ...
    ClassDef(Track,1)          //A track segment
};

```

### 12.17.4 Writing the Tree

We create a simple tree with two branches both holding `Event` objects. One is split and the other is not. We also create a pointer to an `Event` object (`event`).

```

void tree4w() {
    // check to see if the event class is in the dictionary
    // if it is not load the definition in libEvent.so
    if (!TClassTable::GetDict("Event")) {
        gSystem->Load("$ROOTSYS/test/libEvent.so");
    }
    // create a Tree file tree4.root
    TFile f("tree4.root","RECREATE");
    // create a ROOT Tree
    TTree t4("t4","A Tree with Events");
    // create a pointer to an Event object
    Event *event = new Event();
    // create two branches, split one
    t4.Branch("event_branch", "Event", &event,16000,2);
    t4.Branch("event_not_split", "Event", &event,16000,0);

    // a local variable for the event type
    char etype[20];

    // fill the tree
    for (Int_t ev = 0; ev <100; ev++) {
        Float_t sigmat, sigmas;
        gRandom->Rannor(sigmat,sigmas);
        Int_t ntrack = Int_t(600 + 600 *sigmat/120.);
        Float_t random = gRandom->Rndm(1);
        sprintf(etype,"type%d",ev%5);
        event->SetType(etype);
        event->SetHeader(ev, 200, 960312, random);
        event->SetNseg(Int_t(10*ntrack+20*sigmas));
        event->SetNvertex(Int_t(1+20*gRandom->Rndm()));
        event->SetFlag(UInt_t(random+0.5));
        event->SetTemperature(random+20.);
        for (UChar_t m = 0; m < 10; m++) {
            event->SetMeasure(m, Int_t(gRandom->Gaus(m,m+1)));
        }
        // continued...

    // fill the matrix
    for (UChar_t i0 = 0; i0 < 4; i0++) {
        for (UChar_t i1 = 0; i1 < 4; i1++) {
            event->SetMatrix(i0,i1,gRandom->Gaus(i0*i1,1));
        }
    }
    // create and fill the Track objects
    for (Int_t t = 0; t < ntrack; t++) event->AddTrack(random);
    t4.Fill(); // Fill the tree
    event->Clear(); // Clear before reloading event
}
f.Write(); // Write the file header

```

```

t4.Print();           // Print the tree contents
}

```

### 12.17.5 Reading the Tree

First, we check if the shared library with the class definitions is loaded. If not we load it. Then we read two branches, one for the number of tracks and one for the entire event. We check the number of tracks first, and if it meets our condition, we read the entire event. We show the first entry that meets the condition.

```

void tree4r() {
    // check if the event class is in the dictionary
    // if it is not load the definition in libEvent.so
    if (!TClassTable::GetDict("Event")) {
        gSystem->Load("$ROOTSYS/test/libEvent.so");
    }
    // read the tree generated with tree4w

    // note that we use "new" to create the TFile and TTree objects, because we
    // want to keep these objects alive when we leave this function.
    TFile *f = new TFile("tree4.root");
    TTree *t4 = (TTree*)f->Get("t4");

    // create a pointer to an event object for reading the branch values.
    Event *event = new Event();
    // get two branches and set the branch address
    TBranch *bntrack = t4->GetBranch("fNtrack");
    TBranch *branch = t4->GetBranch("event_split");
    branch->SetAddress(&event);

    Int_t nevent = t4->GetEntries();
    Int_t nselected = 0;
    Int_t nb = 0;
    for (Int_t i=0; i<nevent; i++) {
        //read branch "fNtrack"only
        bntrack->GetEntry(i);

        // reject events with more than 587 tracks
        if (event->GetNtrack() > 587)continue;

        // read complete accepted event in memory
        nb += t4->GetEntry(i);
        nselected++;

        // print the first accepted event
        if (nselected == 1) t4->Show();
        // clear tracks array
        event->Clear();
    }

    if (gROOT->IsBatch()) return;
    new TBrowser();
    t4->StartViewer();
}

```

Now, let's see how the tree looks like in the tree viewer.

You can see the two branches in the tree in the left panel: the event branch is split and hence expands when clicked on. The other branch event not split is not expandable and we can not browse the data members.

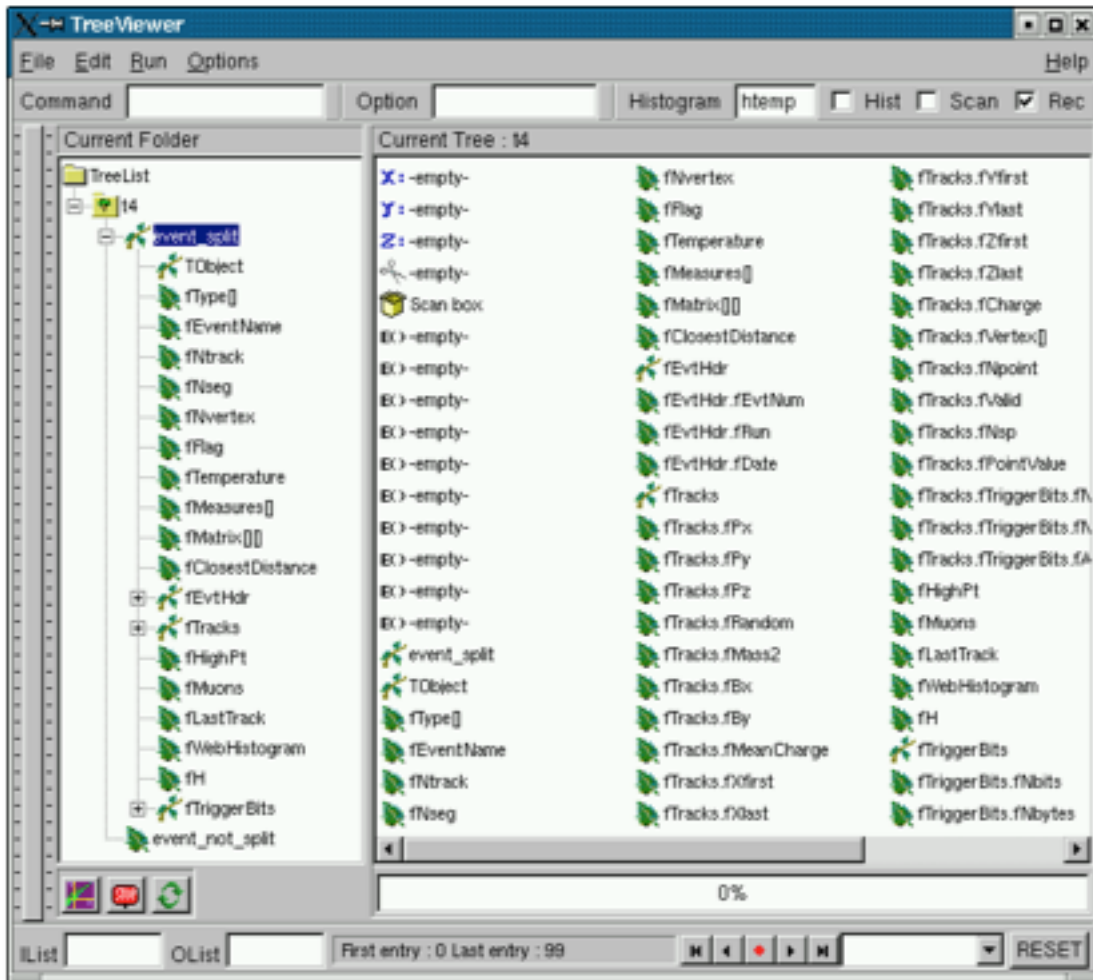

Figure 12.7: The tree viewer with tree4 example



The `TClonesArray` of tracks `fTracks` is also split because we set the split level to 2. The output on the command line is the result of `tree4->Show()`. It shows the first entry with more than 587 tracks:

```
=====> EVENT:26
event_split      =
fUniqueID       = 0
fBits           = 50331648
fType[20]       = 116 121 112 101 49 0 0 0 0 0 0 0 0 0 0 0 0 0 0 0
fNtrack         = 585
fNseg           = 5834
fNvertex        = 17
fFlag           = 0
fTemperature    = 20.044315
fEvtHdr.fEvtNum = 26
fEvtHdr.fRun    = 200
fEvtHdr.fDate   = 960312
fTracks         = 585
fTracks.fUniqueID = 0, 0, 0, 0, 0, 0, 0, 0, 0, 0, 0
...
```

## 12.18 Example 5: Import an ASCII File into a TTree

The method `TTree::ReadFile` can be used to automatic define the structure of the `TTree` and read the data from a formatted ascii file.

```
Long64_t TTree::ReadFile(const char *filename,
                        const char *branchDescriptor)
```

Creates or simply read branches from the file named whose name is passed in 'filename'.

```
{
  gROOT->Reset();
  TFile *f = new TFile("basic2.root","RECREATE");
  TH1F *h1 = new TH1F("h1","x distribution",100,-4,4);
  TTree *T = new TTree("ntuple","data from ascii file");
  Long64_t nlines = T->ReadFile("basic.dat","x:y:z");
  printf(" found %lld pointsn",nlines);
  T->Draw("x","z>2");
  T->Write();
}
```

If `branchDescriptor` is set to an empty string (the default), it is assumed that the `Tree` descriptor is given in the first line of the file with a syntax like: `A/D:Table[2]/F:Ntracks/I:astring/C`.

Otherwise `branchDescriptor` must be specified with the above syntax. Lines in the input file starting with “#” are ignored. A `TBranch` object is created for each variable in the expression. The total number of rows read from the file is returned.

## 12.19 Trees in Analysis

The methods `TTree::Draw`, `TTree::MakeClass` and `TTree::MakeSelector` are available for data analysis using trees. The `TTree::Draw` method is a powerful yet simple way to look and draw the trees contents. It enables you to plot a variable (a leaf) with just one line of code. However, the `Draw` method falls short once you want to look at each entry and design more sophisticated acceptance criteria for your analysis. For these cases, you can use `TTree::MakeClass`. It creates a class that loops over the trees entries one by one. You can then expand it to do the logic of your analysis.

The `TTree::MakeSelector` is the recommended method for ROOT data analysis. It is especially important for large data set in a parallel processing configuration where the analysis is distributed over several processors and you can specify which entries to send to each processor. With `MakeClass` the user has control over the event loop, with `MakeSelector` the tree is in control of the event loop.

## 12.20 Simple Analysis Using `TTree::Draw`

We will use the tree in `staff.root` that was made by the macro in `$ROOTSYS/tutorials/tree/staff.C`.

First, open the file and lists its contents.

```
root[] TFile f ("staff.root")
root[] f.ls()
TFile**      staff.root
TFile*       staff.root
KEY: TTree   T;1      staff data from ascii file
```

We can see the `TTree` “T” in the file. We will use it to experiment with the `TTree::Draw` method, so let’s create a pointer to it:

```
root[] TTree *MyTree = T
```

CINT allows us to get simply the object by using it. Here we define a pointer to a `TTree` object and assign it the value of “T”, the `TTree` in the file. CINT looks for an object named “T” in the current ROOT file and returns it (this assumes that “T” has not previously been used to declare a variable or function).

In contrast, in compiled code, you can use:

```
TTree *MyTree;f.GetObject("T",MyTree);
```

To show the different `Draw` options, we create a canvas with four sub-pads. We will use one sub-pad for each `Draw` command.

```
root[] TCanvas *myCanvas = new TCanvas()
root[] myCanvas->Divide(2,2)
```

We activate the first pad with the `TCanvas::cd` statement:

```
root[] myCanvas->cd(1)
```

We then draw the variable `Cost`:

```
root[] MyTree->Draw("C
```

As you can see, the last call `TTree::Draw` has only one parameter. It is a string containing the leaf name. A histogram is automatically created as a result of a `TTree::Draw`. The style of the histogram is inherited from the `TTree` attributes and the current style (`gStyle`) is ignored. The `TTree` gets its attributes from the current `TStyle` at the time it was created. You can call the method `TTree::UseCurrentStyle` to change to the current style rather than the `TTree` style. (See `gStyle`; see also “Graphics and the Graphical User Interface” )

In the next segment, we activate the second pad and draw a scatter plot variables:

```
root[] myCanvas->cd(2)
root[] MyTree->Draw("Cost:Age")
```

This signature still only has one parameter, but it now has two dimensions separated by a colon (“x:y”). The item to be plotted can be an expression not just a simple variable. In general, this parameter is a string that contains up to three expressions, one for each dimension, separated by a colon (“e1:e2:e3”). A list of examples follows this introduction.

### 12.20.1 Using Selection with TTree:Draw

Change the active pad to 3, and add a selection to the list of parameters of the draw command.

```
root[] myCanvas->cd(3)
root[] MyTree->Draw("Cost:Age", "Nation == \"FR\"")
```

This will draw the `Cost` vs. `Age` for the entries where the nation is equal to “FR”. You can use any C++ operator, and some functions defined in `TFormula`, in the selection parameter. The value of the selection is used as a weight when filling the histogram. If the expression includes only Boolean operations as in the example above, the result is 0 or 1. If the result is 0, the histogram is not filled. In general, the expression is:

```
Selection = "weight *(boolean expression)"
```

If the Boolean expression evaluates to true, the histogram is filled with a weight. If the weight is not explicitly specified it is assumed to be 1.

For example, this selection will add 1 to the histogram if `x` is less than `y` and the square root of `z` is less than 3.2.

```
"x<y && sqrt(z)>3.2"
```

On the other hand, this selection will add `x+y` to the histogram if the square root of `z` is larger than 3.2.

```
"(x+y)*(sqrt(z)>3.2)"
```

The `Draw` method has its own parser, and it only looks in the current tree for variables. This means that any variable used in the selection must be defined in the tree. You cannot use an arbitrary global variable in the `TTree::Draw` method.

### 12.20.2 Using TCut Objects in TTree::Draw

The `TTree::Draw` method also accepts `TCutG` objects. A `TCut` is a specialized string object used for `TTree` selections. A `TCut` object has a name and a title. It does not have any data members in addition to what it inherits from `TNamed`. It only adds a set of operators to do logical string concatenation. For example, assume:

```
TCut cut1 = "x<1"
TCut cut2 = "y>2"
```

then

```
cut1 && cut2
//result is the string "(x<1)&&(y>2)"
```

Operators `=`, `+=`, `+`, `*`, `!`, `&&`, `||` are overloaded, here are some examples:

```
root[] TCut c1 = "x < 1"
root[] TCut c2 = "y < 0"
root[] TCut c3 = c1 && c2
root[] MyTree.Draw("x", c1)
root[] MyTree.Draw("x", c1 || "x>0")
root[] MyTree.Draw("x", c1 && c2)
root[] MyTree.Draw("x", "(x + y)" * (c1 && c2))
```

### 12.20.3 Accessing the Histogram in Batch Mode

The `TTree::Draw` method creates a histogram called `htemp` and puts it on the active pad. In a batch program, the histogram `htemp` created by default, is reachable from the current pad.

```
// draw the histogram
nt->Draw("x", "cuts");
// get the histogram from the current pad
TH1F *htemp = (TH1F*)gPad->GetPrimitive("htemp");
// now we have full use of the histogram
htemp->GetEntries();
```

If you pipe the result of the `TTree::Draw` into a histogram, the histogram is also available in the current directory. You can do:

```
// Draw the histogram and fill hnew with it
nt->Draw("x>>hnew", "cuts");
// get hnew from the current directory
TH1F *hnew = (TH1F*)gDirectory->Get("hnew");
// or get hnew from the current Pad
TH1F *hnew = (TH1F*)gPad->GetPrimitive("hnew");
```

### 12.20.4 Using Draw Options in TTree::Draw

The next parameter is the draw option for the histogram:

```
root[] MyTree->Draw("Cost:Age", "Nation == \"FR\"", "surf2");
```

The draw options are the same as for `TH1::Draw`. See “Draw Options” where they are listed. In addition to the draw options defined in `TH1`, there are three more. The ‘`prof`’ and ‘`profs`’ draw a profile histogram (`TProfile`) rather than a regular 2D histogram (`TH2D`) from an expression with two variables. If the expression has three variables, a `TProfile2D` is generated.

The ‘`profs`’ generates a `TProfile` with error on the spread. The ‘`prof`’ option generates a `TProfile` with error on the mean. The “`goff`” option suppresses generating the graphics. You can combine the draw options in a list separated by commas. After typing the lines above, you should now have a canvas that looks this.

### 12.20.5 Superimposing Two Histograms

When superimposing two 2-D histograms inside a script with `TTree::Draw` and using the “`same`” option, you will need to update the pad between `Draw` commands.

```
{
// superimpose two 2D scatter plots
// Create a 2D histogram and fill it with random numbers
TH2 *h2 = new TH2D ("h2", "2D histo", 100, 0, 70, 100, 0, 20000);
for (Int_t i = 0; i < 10000; i++)
    h2->Fill(gRandom->Gaus(40, 10), gRandom->Gaus(10000, 3000));
// set the color to differentiate it visually
h2->SetMarkerColor(kGreen);
h2->Draw();
// Open the example file and get the tree
TFile f("staff.root");
TTree *myTree = (TTree*)f.Get("T");
// the update is needed for the next draw command to work properly
gPad->Update();
myTree->Draw("Cost:Age", "", "same");
}
```

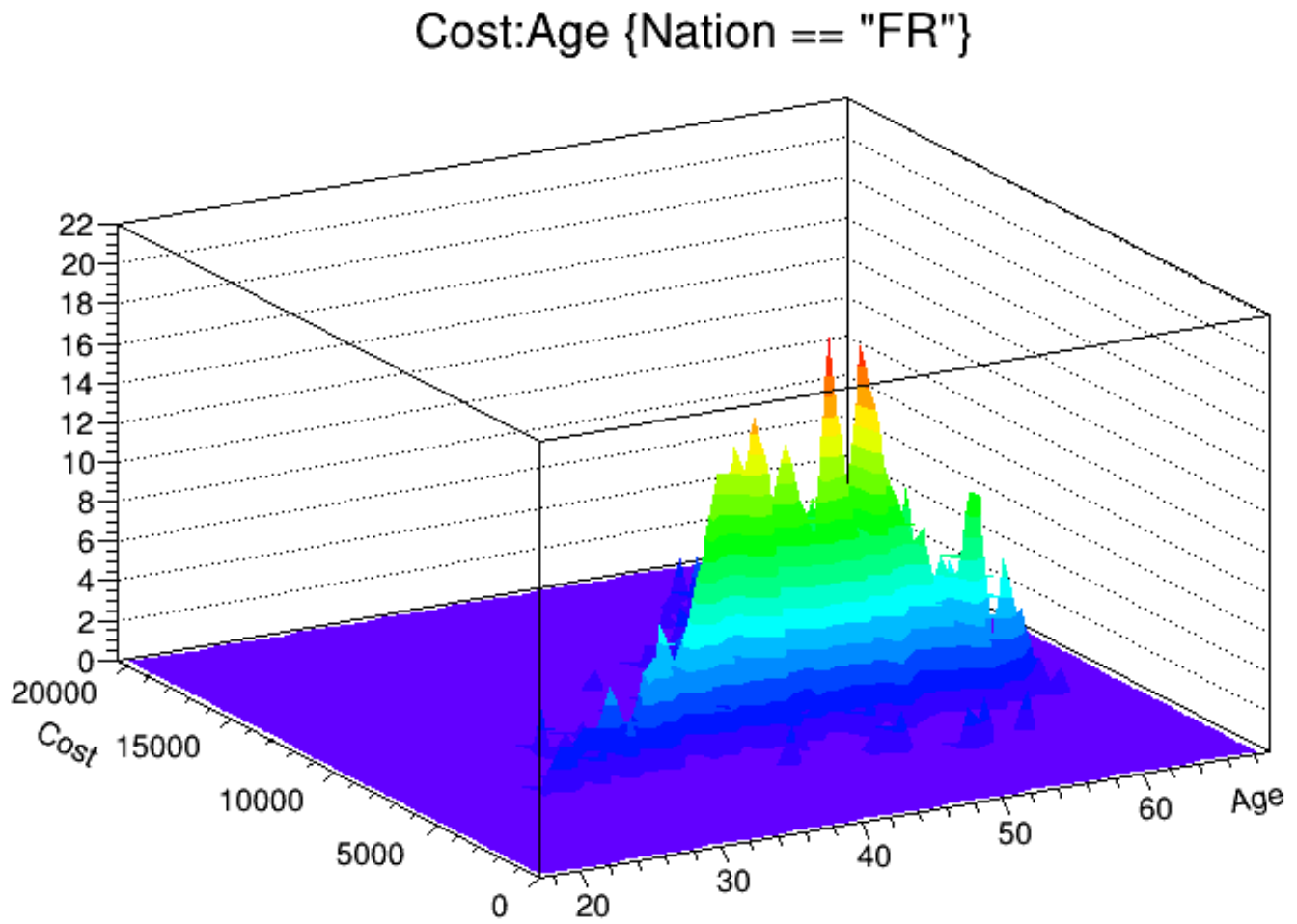

Figure 12.8: Using draw options in trees

In this example, `h2->Draw` is only adding the object `h2` to the pad's list of primitives. It does not paint the object on the screen. However, `TTree::Draw` when called with option “same” gets the current pad coordinates to build an intermediate histogram with the right limits. Since nothing has been painted in the pad yet, the pad limits have not been computed. Calling `pad->Update()` forces the painting of the pad and allows `TTree::Draw` to compute the right limits for the intermediate histogram.

### 12.20.6 Setting the Range in `TTree::Draw`

There are two more optional parameters to the `TTree::Draw` method: one is the number of entries and the second one is the entry to start with. For example, this command draws 1000 entries starting with entry 100:

```
myTree->Draw("Cost:Age", "", "", 1000, 100);
```

### 12.20.7 `TTree::Draw` Examples

The examples below use the `Event.root` file generated by the `$ROOTSYS/test/Event` executable and the `Event`, `Track`, and `EventHeader` class definitions are in `$ROOTSYS/test/Event.h`. The commands have been tested on the split-levels 0, 1, and 9. Each command is numbered and referenced by the explanations immediately following the examples.

```

// Data members and methods
1 tree->Draw("fNtrack");
2 tree->Draw("event.GetNtrack()");
3 tree->Draw("GetNtrack()");
4 tree->Draw("fH.fXaxis.fXmax");
5 tree->Draw("fH.fXaxis.GetXmax()");
6 tree->Draw("fH.GetXaxis().fXmax");
7 tree->Draw("GetHistogram().GetXaxis().GetXmax()");
// Expressions in the selection parameter
8 tree->Draw("fTracks.fPx", "fEvtHdr.fEvtNum%10 == 0");
9 tree->Draw("fPx", "fEvtHdr.fEvtNum%10 == 0");
// Two dimensional arrays defined as:
// Float_t fMatrix[4][4] in Event class
10 tree->Draw("fMatrix");
11 tree->Draw("fMatrix[ ][ ]");
12 tree->Draw("fMatrix[2][2]");
13 tree->Draw("fMatrix[ ][0]");
14 tree->Draw("fMatrix[1][ ]");
// using two arrays... Float_t fVertex[3]; in Track class
15 tree->Draw("fMatrix - fVertex");
16 tree->Draw("fMatrix[2][1] - fVertex[5][1]");
17 tree->Draw("fMatrix[ ][1] - fVertex[5][1]");
18 tree->Draw("fMatrix[2][ ] - fVertex[5][ ]");
19 tree->Draw("fMatrix[ ][2] - fVertex[ ][1]");
20 tree->Draw("fMatrix[ ][2] - fVertex[ ][ ]");
21 tree->Draw("fMatrix[ ][ ] - fVertex[ ][ ]");
// variable length arrays
22 tree->Draw("fClosestDistance");
23 tree->Draw("fClosestDistance[fNvertex/2]");
// mathematical expressions
24 tree->Draw("sqrt(fPx*fPx + fPy*fPy + fPz*fPz)");
// external function call
25 tree->Draw("TMath::BreitWigner(fPx,3,2)");
// strings
26 tree->Draw("fEvtHdr.fEvtNum", "fType=="type1" ");
27 tree->Draw("fEvtHdr.fEvtNum", "strstr(fType, "1" ");
// Where fPoints is defined in the track class:
// Int_t fNpoint;
```

```

//      Int_t *fPoints; [fNpoint]
28 tree->Draw("fTracks.fPoints");
29 tree->Draw("fTracks.fPoints - fTracks.fPoints[] [fAvgPoints]");
30 tree->Draw("fTracks.fPoints[2] [] - fTracks.fPoints[] [55]");
31 tree->Draw("fTracks.fPoints[] [] - fTracks.fVertex[] []");
// selections
32 tree->Draw("fValid&0x1", "(fNvertex>10) && (fNseg<=6000)");
33 tree->Draw("fPx", "(fBx>.4) || (fBy<=-.4)");
34 tree->Draw("fPx", "fBx*fBx*(fBx>.4) + fBy*fBy*(fBy<=-.4)");
35 tree->Draw("fVertex", "fVertex>10");
36 tree->Draw("fPx[600]");
37 tree->Draw("fPx[600]", "fNtrack>600");
// alphanumeric bin histogram
// where Nation is a char* intended to be used as a string
38 tree->Draw("Nation");
// where MyByte is a char* intended to be used as a byte
39 tree->Draw("MyByte + 0");
// where fTriggerBits is a data member of TTrack of type TBits
40 tree->Draw("fTracks.fTriggerBits");
// using alternate values
41 tree->Draw("fMatrix-Alt$(fClosestDistance,0)");
// using meta information about the formula
42 tree->Draw("fMatrix:Iteration$");
43 T->Draw("fLastTrack.GetPx():fLastTrack.fPx");
44 T->Scan("((Track*)(fLastTrack@.GetObject())).GetPx()", "", "");
45 tree->Draw("This->GetReadEntry()");
46 tree->Draw("mybr.mystring");
47 tree->Draw("myTimeStamp");

```

### 12.20.7.1 Explanations:

1. `tree->Draw("fNtrack");`

It fills the histogram with the number of tracks for each entry. `fNtrack` is a member of event.

2. `tree->Draw("event.GetNtrack()");`

Same as case 1, but use the method of event to get the number of tracks. When using a method, you can include parameters for the method as long as the parameters are literals.

3. `tree->Draw("GetNtrack()");`

Same as case 2, the object of the method is not specified. The command uses the first instance of the `GetNtrack` method found in the objects stored in the tree. We recommend using this shortcut only if the method name is unique.

4. `tree->Draw("fH.fXaxis.fXmax");`

Draw the data member of a data member. In the tree, each entry has a histogram. This command draws the maximum value of the X-axis for each histogram.

5. `tree->Draw("fH.fXaxis.GetXmax()");`

Same as case 4, but use the method of a data member.

6. `tree->Draw("fH.GetXaxis().fXmax");`

The same as case 4: a data member of a data member retrieved by a method.

```
7. **tree->Draw("GetHistogram().GetXaxis().GetXmax()");**
```

Same as case 4, but using methods.

```
8. tree->Draw("fTracks.fPx","fEvtHdr.fEvtNum%10 == 0");
```

Use data members in the expression and in the selection parameter to plot `fPx` or all tracks in every 10th entry. Since `fTracks` is a `TClonesArray` of `Tracks`, there will be `d` values of `fPx` for each entry.

```
9. tree->Draw("fPx","fEvtHdr.fEvtNum%10 == 0");
```

Same as case 8, use the name of the data member directly.

```
10. tree->Draw("fMatrix");
```

When the index of the array is left out or when empty brackets are used `[]`, all values of the array are selected. Draw all values of `fMatrix` for each entry in the tree. If `fMatrix` is defined as: `Float_t fMatrix[4][4]`, all 16 values are used for each entry.

```
11. tree->Draw("fMatrix[ ][ ]");
```

The same as case 10, all values of `fMatrix` are drawn for each entry.

```
12. tree->Draw("fMatrix[2][2]");
```

The single element at `fMatrix[2][2]` is drawn for each entry.

```
13. tree->Draw("fMatrix[ ][0]");
```

Four elements of `fMatrix` are used: `fMatrix[1][0]`, `fMatrix[2][0]`, `fMatrix[3][0]`, `fMatrix[4][0]`.

```
14. tree->Draw("fMatrix[1][ ]");
```

Four elements of `fMatrix` are used: `fMatrix[1][0]`, `fMatrix[1][2]`, `fMatrix[1][3]`, `fMatrix[1][4]`.

```
15. tree->Draw("fMatrix - fVertex");
```

With two arrays and unspecified element numbers, the number of selected values is the minimum of the first dimension times the minimum of the second dimension. In this case `fVertex` is also a two dimensional array since it is a data member of the tracks array. If `fVertex` is defined in the track class as: `Float_t *fVertex[3]`, it has `fNtracks` x 3 elements. `fMatrix` has 4 x 4 elements. This case, draws 4 (the smaller of `fNtrack` and 4) times 3 (the smaller of 4 and 3), meaning 12 elements per entry. The selected values for each entry are:

```
fMatrix[0][0] - fVertex[0][0]
```

```
fMatrix[0][1] - fVertex[0][1]
```

```
fMatrix[0][2] - fVertex[0][2]
```

```
fMatrix[1][0] - fVertex[1][0]
```

```
fMatrix[1][1] - fVertex[1][1]
```

```
fMatrix[1][2] - fVertex[1][2]
```

```
fMatrix[2][0] - fVertex[2][0]
```



```
fMatrix[2][1] - fVertex[2][1]
fMatrix[2][2] - fVertex[2][2]
fMatrix[3][0] - fVertex[3][0]
fMatrix[3][1] - fVertex[3][1]
fMatrix[3][2] - fVertex[3][2]
```

```
16. tree->Draw("fMatrix[2][1] - fVertex[5][1]");
```

This command selects one value per entry.

```
17. tree->Draw("fMatrix[ ][1] - fVertex[5][1]");
```

The first dimension of the array is taken by the `fMatrix`.

```
fMatrix[0][1] - fVertex[5][1]
fMatrix[1][1] - fVertex[5][1]
fMatrix[2][1] - fVertex[5][1]
fMatrix[3][1] - fVertex[5][1]
```

```
18. tree->Draw("(fMatrix[2][ ] - fVertex[5][ ]");
```

The first dimension minimum is 2, and the second dimension minimum is 3 (from `fVertex`). Three values are selected from each entry:

```
fMatrix[2][0] - fVertex[5][0]
fMatrix[2][1] - fVertex[5][1]
fMatrix[2][2] - fVertex[5][2]
```

```
19. tree->Draw("fMatrix[ ][2] - fVertex[ ][1]");
```

This is similar to case 18. Four values are selected from each entry:

```
fMatrix[0][2] - fVertex[0][1]
fMatrix[1][2] - fVertex[1][1]
fMatrix[2][2] - fVertex[2][1]
fMatrix[3][2] - fVertex[3][1]
```

```
20. tree->Draw("fMatrix[ ][2] - fVertex[ ][ ]");
```

This is similar to case 19. Twelve values are selected (4x3) from each entry:

```
fMatrix[0][2] - fVertex[0][0]
fMatrix[0][2] - fVertex[0][1]
fMatrix[0][2] - fVertex[0][2]
fMatrix[1][2] - fVertex[1][0]
fMatrix[1][2] - fVertex[1][1]
fMatrix[1][2] - fVertex[1][2]
fMatrix[2][2] - fVertex[2][0]
fMatrix[2][2] - fVertex[2][1]
```

```
fMatrix[2][2] - fVertex[2][2]
fMatrix[3][2] - fVertex[3][0]
fMatrix[3][2] - fVertex[3][1]
fMatrix[3][2] - fVertex[3][2]
```

```
21. tree->Draw("fMatrix[ ][ ] - fVertex[ ][ ]")
```

This is the same as case 15. The first dimension minimum is 4 (from `fMatrix`), and the second dimension minimum is 3 (from `fVertex`). Twelve values are selected from each entry.

```
22. tree->Draw("fClosestDistance")
```

This event data member `fClosestDistance` is a variable length array:

```
Float_t *fClosestDistance; //[fNvertex]
```

This command selects all elements, but the number per entry depends on the number of vertices of that entry.

```
23. tree->Draw("fClosestDistance[fNvertex/2]")
```

With this command the element at `fNvertex/2` of the `fClosestDistance` array is selected. Only one per entry is selected.

```
24. tree->Draw("sqrt(fPx*fPx + fPy*fPy + fPz*fPz)")
```

This command shows the use of a mathematical expression. It draws the square root of the sum of the product.

```
25. tree->Draw("TMath::BreitWigner(fPx,3,2)")
```

The formula can contain call to a function that takes numerical arguments and returns a numerical value. The function needs to be declared to the dictionary and need to be available from the global namespace. In particular, global functions and public static member functions can be called.

```
26. tree->Draw("fEvtHdr.fEvtNum", "fType=="type1" ")
```

You can compare strings, using the symbols `==` and `!=`, in the first two parameters of the `Draw` command (`TTreeFormula`). In this case, the event number for ‘type1’ events is plotted.

```
27. tree->Draw("fEvtHdr.fEvtNum", "strstr(fType, "1" )")
```

To compare strings, you can also use `strstr`. In this case, events having a ‘1’ in `fType` are selected.

```
28. tree->Draw("fTracks.fPoints")
```

If `fPoints` is a data member of the `Track` class declared as:

```
Int_t fNpoint;
Int_t *fPoints; [fNpoint]
```

The size of the array `fPoints` varies with each track of each event. This command draws all the value in the `fPoints` arrays.

```
29. tree->Draw("fTracks.fPoints - fTracks.fPoints[] [fAvgPoints]");
```

When `fAvgPoints` is a data member of the `Event` class, this example selects:

```
fTracks[0].fPoints[0] - fTracks[0].fPoint[fAvgPoints]
fTracks[0].fPoints[1] - fTracks[0].fPoint[fAvgPoints]
fTracks[0].fPoints[2] - fTracks[0].fPoint[fAvgPoints]
fTracks[0].fPoints[3] - fTracks[0].fPoint[fAvgPoints]
fTracks[0].fPoints[4] - fTracks[0].fPoint[fAvgPoints]
...
fTracks[0].fPoints[max0] - fTracks[0].fPoint[fAvgPoints]
...
fTracks[1].fPoints[0] - fTracks[1].fPoint[fAvgPoints]
fTracks[1].fPoints[1] - fTracks[1].fPoint[fAvgPoints]
fTracks[1].fPoints[2] - fTracks[1].fPoint[fAvgPoints]
fTracks[1].fPoints[3] - fTracks[1].fPoint[fAvgPoints]
fTracks[1].fPoints[4] - fTracks[1].fPoint[fAvgPoints]
...
fTracks[1].fPoints[max1] - fTracks[1].fPoint[fAvgPoints]
...
fTracks[fNtrack-1].fPoints[0] - fTracks[fNtrack-1].fPoint[fAvgPoints]
fTracks[fNtrack-1].fPoints[1] - fTracks[fNtrack-1].fPoint[fAvgPoints]
fTracks[fNtrack-1].fPoints[2] - fTracks[fNtrack-1].fPoint[fAvgPoints]
fTracks[fNtrack-1].fPoints[3] - fTracks[fNtrack-1].fPoint[fAvgPoints]
fTracks[fNtrack-1].fPoints[4] - fTracks[fNtrack-1].fPoint[fAvgPoints]
...
fTracks[fNtrack-1].fPoints[maxn] - fTracks[fNtrack-1].fPoint[fAvgPoints]
```

Where `max0`, `max1`, ... `max n`, is the size of the `fPoints` array for the respective track.

```
30. tree->Draw("fTracks.fPoints[2] [] - fTracks.fPoints [] [55]")
```

For each event, this expression is selected:

```
fTracks[2].fPoints[0] - fTracks[0].fPoints[55]
fTracks[2].fPoints[1] - fTracks[1].fPoints[55]
fTracks[2].fPoints[2] - fTracks[2].fPoints[55]
fTracks[2].fPoints[3] - fTracks[3].fPoints[55]
...
fTracks[2].fPoints[max] - fTracks[max].fPoints[55]
```

where `max` is the minimum of `fNtrack` and `fTracks[2].fNpoint`.

```
31. tree->Draw("fTracks.fPoints [] [] - fTracks.fVertex [] []")
```

For each event and each track, this expression is selected. It is the difference between `fPoints` and of `fVertex`. The number of elements used for each track is the minimum of `fNpoint` and 3 (the size of the `fVertex` array).

```
fTracks[0].fPoints[0] - fTracks[0].fVertex[0]
fTracks[0].fPoints[1] - fTracks[0].fVertex[1]
fTracks[0].fPoints[2] - fTracks[0].fVertex[2]
// with fTracks[1].fNpoint==7
fTracks[1].fPoints[0] - fTracks[1].fVertex[0]
fTracks[1].fPoints[1] - fTracks[1].fVertex[1]
fTracks[1].fPoints[2] - fTracks[1].fVertex[2]
// with fTracks[1].fNpoint==5
fTracks[2].fPoints[0] - fTracks[1].fVertex[0]
fTracks[2].fPoints[1] - fTracks[1].fVertex[1]
// with fTracks[2].fNpoint==2
fTracks[3].fPoints[0] - fTracks[3].fVertex[0]
// with fTracks[3].fNpoint==1
fTracks[4].fPoints[0] - fTracks[4].fVertex[0]
fTracks[4].fPoints[1] - fTracks[4].fVertex[1]
fTracks[4].fPoints[2] - fTracks[4].fVertex[2]
// with fTracks[4].fNpoint==3
```

```
32. tree->Draw("fValid&0x1", "(fNvertex>10) && (fNseg<=6000)")
```

You can use bit patterns (`&`, `|`, `<<`) or Boolean operation.

```
33. tree->Draw("fPx", "(fBx>.4) || (fBy<=-.4)");
```

```
34. tree->Draw("fPx", "fBx*fBx*(fBx>.4) + fBy*fBy*(fBy<=-.4)");
```

The selection argument is used as a weight. The expression returns a multiplier and in case of a Boolean the multiplier is either 0 (for false) or 1 (for true). The first command draws `fPx` for the range between 0.4 and -0.4, the second command draws `fPx` for the same range, but adds a weight using the result of the second expression.

```
35. tree->Draw("fVertex", "fVertex>10")
```

When using arrays in the selection and the expression, the selection is applied to each element of the array.

```
if (fVertex[0]>10) fVertex[0]
if (fVertex[1]>10) fVertex[1]
if (fVertex[2]>10) fVertex[2]
```

```
36. tree->Draw("fPx[600]")
```

```
37. tree->Draw("fPx[600]", "fNtrack > 600")
```

When using a specific element for a variable length array the entries with fewer elements are ignored. Thus these two commands are equivalent.

```
38. tree->Draw("Nation")
```

`Nation` is a `char*` branch. When drawing a `char*` it will plot an alphanumeric histogram, of the different value of the string `Nation`. The axis will have the `Nation` values. See “Histograms”.

```
39. tree->Draw("MyChar +0")
```

If you want to plot a `char*` variable as a byte rather than a string, you can use the syntax above.

```
40. tree->Draw("fTracks.fTriggerBits")
```

`fTriggerBits` is a data member of `TTrack` of type `TBits`. Objects of class `TBits` can be drawn directly. This command will create a 1D histogram from 0 to `nbits` which is filled for each non-null bit-number.

```
41. tree->Draw("fMatrix-Alt$(fClosestDistance,0)")
```

`Alt$(primary,alternate)` returns the value of “primary” if it is available for the current iteration; otherwise return the value of “alternate”. Assuming that `fClosestDistance` is a smaller array than `fMatrix`. This example will draw `fMatrix[i]+fClosestDistance[i]` for `i` less than the size of `fClosestDistance`, and will draw `fMatrix[i]+0` for the other value of `i`.

```
42. tree->Draw("fClosestDistance:Iteration$")
```

This example draws a 2D plot with, for all entries, `fClosestDistance[i]:i` for each value of `i` between 0 and the size of `fClosestDistance`. `Iterations$` is one of four special variables giving some indications of the state of the loops implied by the formula:

`Entry$` : return the current entry number (`TTree::GetReadEntry()`)

`Entries$` : return the total number of entries (`TTree::GetEntries()`)

`Length$` : return the total number of element of this formula for this entry

`Iteration$`: return the current iteration over this formula for this entry (i.e. varies from 0 to `Length$`).

```
43. T->Draw("fLastTrack.GetPx():fLastTrack.fPx");**
```

`TRef` and `TRefArray` are automatically dereferenced and this shows the value of the `fPx` of the track referenced by `fLastTrack`. To access the `TRef` object itself use the ‘@’ notation (see next example). This auto dereferencing can be extended (via an implementation of `TVirtualRefProxy`) to any reference type.

```
44. T->Scan("((Track*)(fLastTrack@.GetObject()).GetPx()","","");**
```

Will cast the return value of `GetObject()` (which happens to be `TObject*` in this case) before requesting the `GetPx()` member functions.

```
45. tree->Draw("This->GetReadEntry()");
```

You can refer to the tree (or chain) containing the data by using the string ‘This’. You can also call any `TTree` methods. Next example will display the name of the first ‘user info’ object:

```
tree->Draw("This->GetUserInfo()->At(0)->GetName()");
```

```
46. tree->Draw("mybr.mystring");
```

`TString` and `std::string` object are plotted directly. The example 45 draws the same results - i.e. an histogram whose labels are the string value of ‘mystring’:

```
tree->Draw("mybr.mystring.c_str()");
```

or

```
tree->Draw("mybr.mytstring.Data()");
```

```
47. tree->Draw("myTimeStamp");
```

You can plot objects of any class which has either `AsDouble` or `AsString` (`AsDouble` has priority). For such a class (for example `TTimeStamp`), the line 46 will plot the same as:

```
tree->Draw("myTimeStamp.AsDouble");
```

`AsString` can be returning either a `char*`, or a `TString` or an `std::string`.

## 12.20.8 Multiple variables visualisation

This section presents the visualization technique available in ROOT to represent multiple variables (>4) data sets.

### 12.20.8.1 Spider (Radar) Plots

Spider plots (sometimes called “web-plots” or “radar plots”) are used to compare series of data points (events). They use the human ability to spot un-symmetry.

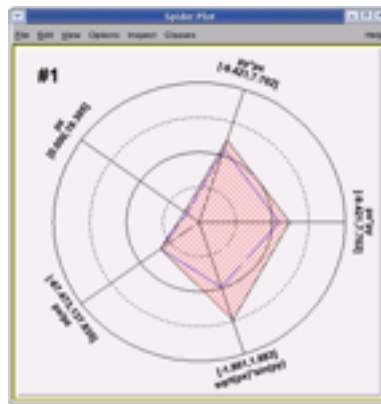

Figure 12.9: Example of spider plot.

Variables are represented on individual axes displayed along a circle. For each variable the minimum value sits on the circle’s center, and the maximum on the circle’s radius. Spider plots are not suitable for an accurate graph reading since, by their nature, it can be difficult to read out very detailed values, but they give quickly a global view of an event in order to compare it with the others. In ROOT the spider plot facility is accessed from the tree viewer GUI. The variables to be visualized are selected in the tree viewer and can be scanned using the spider plot button.

The spider plot graphics editor provides two tabs to interact with the spider plots’ output: the tab “Style” defining the spider layout and the tab “Browse” to navigate in the tree.

### 12.20.8.2 Parallel Coordinates Plots

The Parallel Coordinates Plots are a common way of studying and visualizing multiple variables data sets. They were proposed by in A.Inselberg in 1981 as a new way to represent multi-dimensional information. In traditional Cartesian coordinates, axes are mutually perpendicular. In Parallel coordinates, all axes are parallel which allows representing data in much more than three dimensions. To show a set of points in Parallel Coordinates, a set of parallel lines is drawn, typically vertical and equally spaced. A point in n-dimensional space is represented as a polyline with vertices on the parallel axes. The position of the vertex on the i-th axis corresponds to the i-th coordinate of the point. The three following figures show some very simple examples:

The Parallel Coordinates technique is good at: spotting irregular events, seeing the data trend, finding correlations and clusters. Its main weakness is the cluttering of the output. Because each “point” in the multidimensional space is represented as a line, the output is very quickly opaque and therefore it is difficult to see the data clusters. Most of the work done about Parallel Coordinates is to find techniques to reduce the output’s cluttering. The Parallel Coordinates plots in ROOT have been implemented as a new plotting option “PARA” in the `TTree::Draw()` method. To demonstrate how the Parallel Coordinates works in ROOT we will use the tree produced by the following “pseudo C++” code:

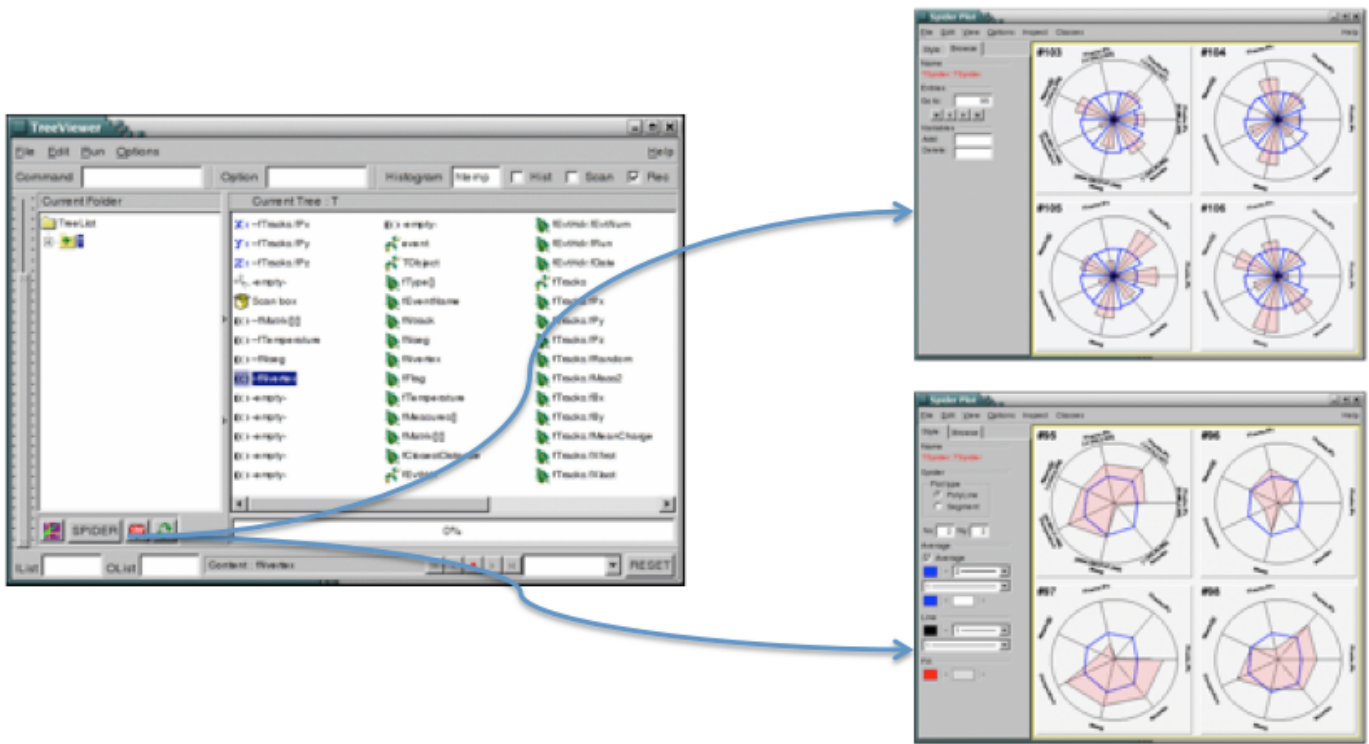

Figure 12.10: The tree viewer Graphical User Interface and the Spider Plot Editor.

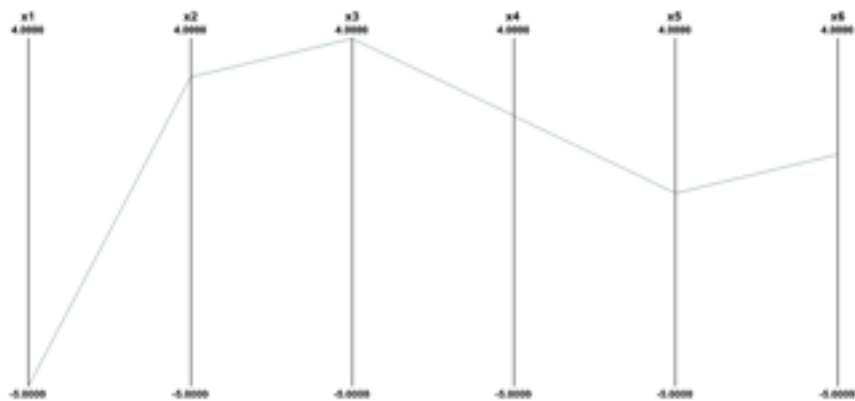

Figure 12.11: The Parallel Coordinates representation of the six dimensional point  $(-5, 3, 4, 2, 0, 1)$ .

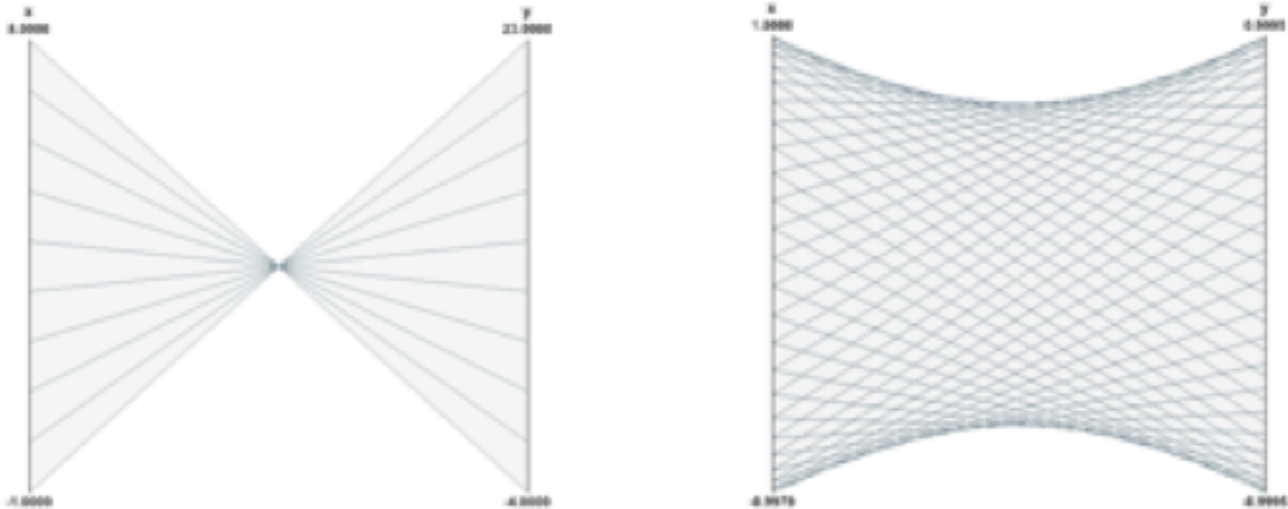

Figure 12.12: The line  $y = -3x + 20$  and a circle in Parallel Coordinates.

```
void parallel_example() {
  TNtuple *nt = new TNtuple("nt","Demo ntuple","x:y:z:u:v:w:a:b:c");
  for (Int_t i=0; i<3000; i++) {
    nt->Fill( rnd, rnd, rnd, rnd, rnd, rnd, rnd, rnd, rnd );
    nt->Fill( s1x, s1y, s1z, s2x, s2y, s2z, rnd, rnd, rnd );
    nt->Fill( rnd, rnd, rnd, rnd, rnd, rnd, rnd, rnd, s3y, rnd );
    nt->Fill( s2x-1, s2y-1, s2z, s1x+.5, s1y+.5, s1z+.5, rnd, rnd, rnd );
    nt->Fill( rnd, rnd, rnd, rnd, rnd, rnd, rnd, rnd, rnd, rnd );
    nt->Fill( s1x+1, s1y+1, s1z+1, s3x-2, s3y-2, s3z-2, rnd, rnd, rnd );
    nt->Fill( rnd, rnd, rnd, rnd, rnd, rnd, rnd, s3x, rnd, s3z );
    nt->Fill( rnd, rnd, rnd, rnd, rnd, rnd, rnd, rnd, rnd, rnd );
  }
}
```

The data set generated has:

- 9 variables: x, y, z, u, v, w, a, b, c.
- $3000 \cdot 8 = 24000$  events.
- 3 sets of random points distributed on spheres: s1, s2, s3
- Random values (noise): rnd
- The variables a,b,c are almost completely random. The variables a and c are correlated via the 1st and 3rd coordinates of the 3rd “sphere” s3.

The command used to produce the Parallel Coordinates plot is:

```
nt->Draw("x:a:y:b:z:u:c:v:w", "", "PARA");
```

If the 24000 events are plotted as solid lines and no special techniques are used to clarify the picture, the result is the previous picture which is very cluttered and useless. To improve the readability of the Parallel Coordinates output and to explore interactively the data set, many techniques are available. We have implemented a few in ROOT. First of all, in order to show better where the clusters on the various axes are, a 1D histogram is associated to each axis. These histograms (one per axis) are filled according to the number of lines passing through the bins.

These histograms can be represented with colors (get from a palette according to the bin contents) or as bar charts. Both representations can be cumulated on the same plot. This technique allows seeing clearly where the clusters are on an individual axis but it does not give any hints about the correlations between the axes.



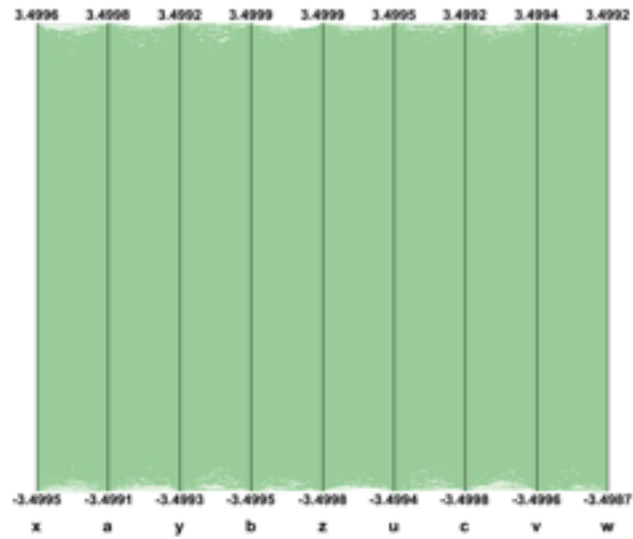

Figure 12.13: Cluttered output produced when all the tree events are plotted.

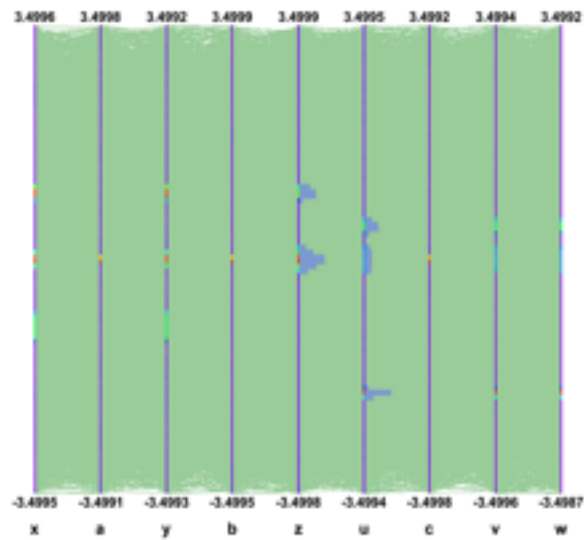

Figure 12.14: The histogram's axis can be represented with colors or as bar charts.

A very simple technique allows to make the clusters appearing: Instead of painting solid lines we paint dotted lines. The cluttering of each individual line is reduced and the clusters show clearly as we can see on the next figure. The spacing between the dots is a parameter which can be adjusted in order to get the best results.

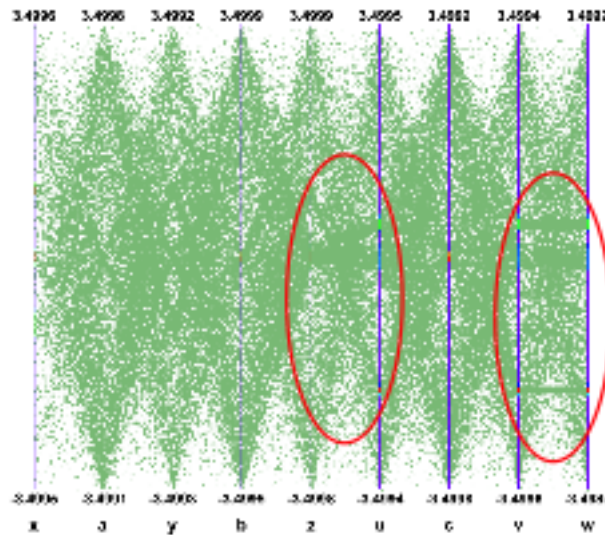

Figure 12.15: Using dotted lines is a very simple method to reduce the cluttering.

Interactivity is a very important aspect of the Parallel Coordinates plots. To really explore the data set it is essential to act directly with the events and the axes. For instance, changing the axes order may show clusters which were not visible in a different order. On the next figure the axes order has been changed interactively. We can see that many more clusters appear and all the “random spheres” we put in the data set are now clearly visible. Having moved the variables  $u, v, w$  after the variables  $x, y, z$  the correlation between these two sets of variables is clear also.

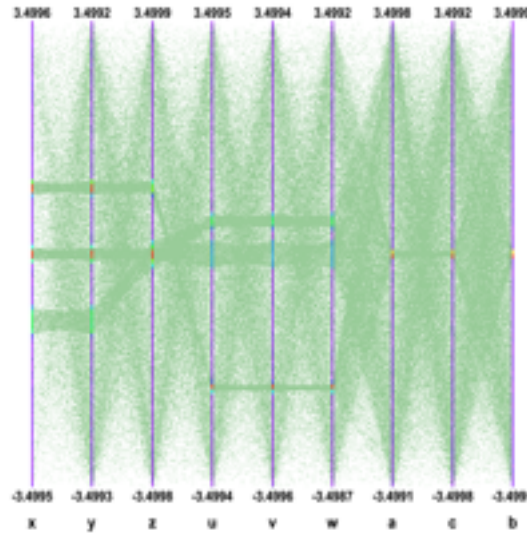

Figure 12.16: Axis order is very important to show clusters.

To pursue further data sets exploration we have implemented the possibility to define selections interactively. A selection is a set of ranges combined together. Within a selection, ranges along the same axis are combined with logical OR, and ranges on different axes with logical AND. A selection is displayed on top of the complete data set using its own color. Only the events fulfilling the selection criteria (ranges) are displayed. Ranges are defined interactively using cursors, like on the first axis on the figure. Several selections can be defined at the same time, each selection having its own color.

Several selections can be defined. Each cluster is now clearly visible and the zone with crossing clusters is now understandable whereas, without any selection or with only a single one, it was not easy to understand.

Interactive selections on Parallel Coordinates are a powerful tool because they can be defined graphically on many variables (graphical cuts in ROOT can be defined on two variables only) which allow a very accurate events filtering. Selections allow

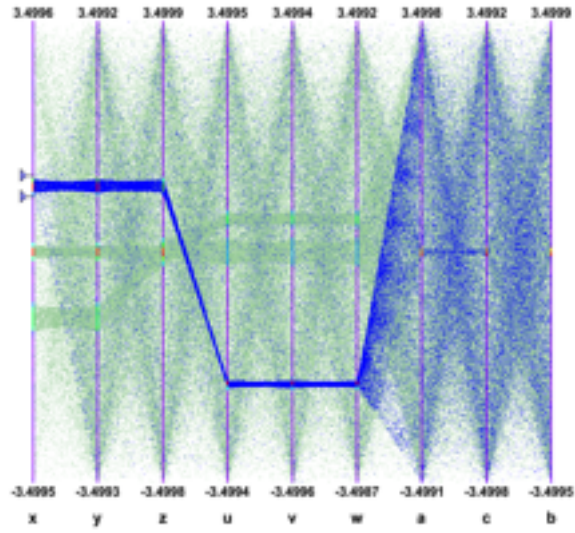

Figure 12.17: Selections are set of ranges which can be defined interactively.

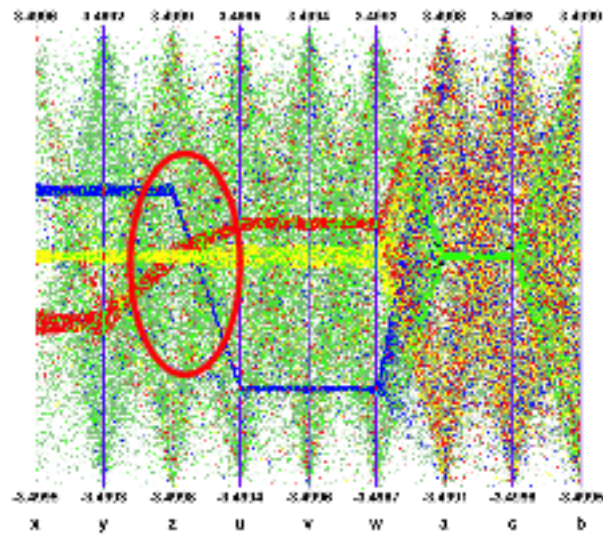

Figure 12.18: Several selections can be defined each of them having its own color.

making precise events choices: a single outlying event is clearly visible when the lines are displayed as “solid” therefore it is easy to make cuts in order to eliminate one single event from a selection. Such selection (to filter one single event) on a scatter plot would be much more difficult.

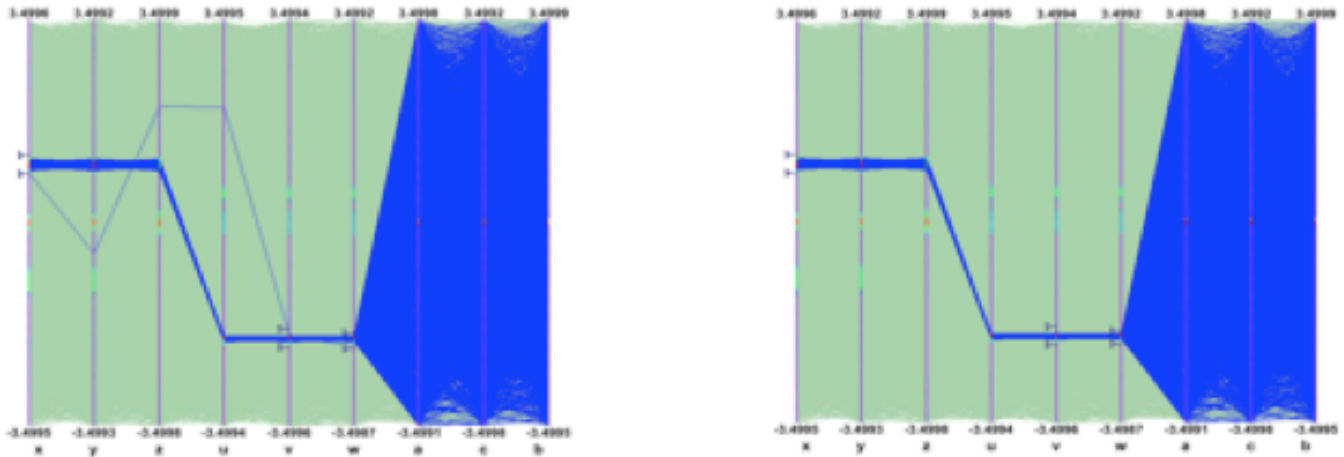

Figure 12.19: Selections allow to easily filter one single event.

Once a selection has been defined, it is possible to use it to generate a `TEntryList` which is applied on the tree and used at drawing time. In our example the selection we defined allows to select exactly the two correlated “random spheres”.

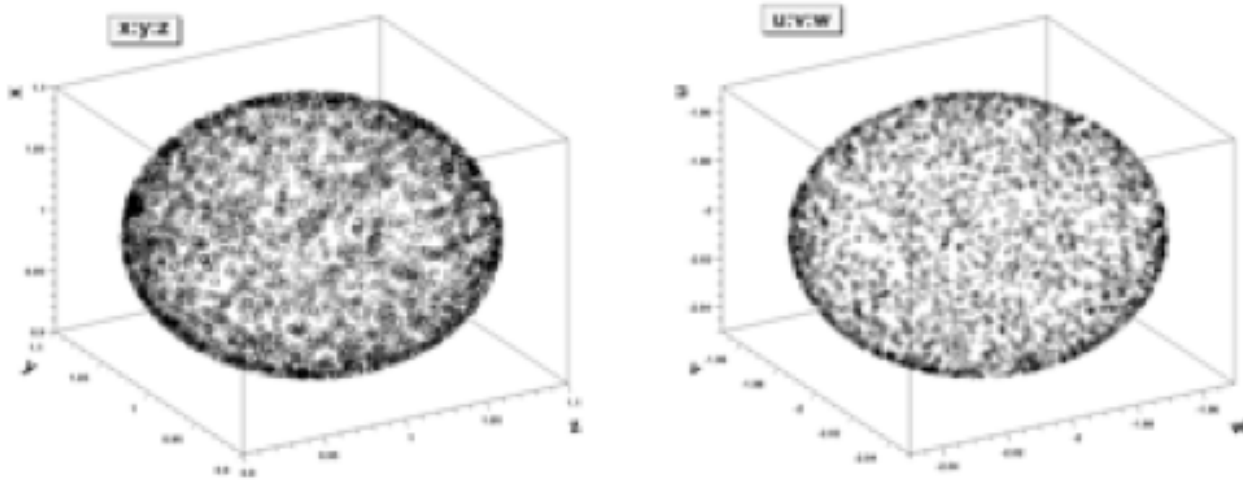

Figure 12.20: Output of `nt->Draw("x:y:z")` and `nt->Draw("u:v:w")` after applying the selection.

Another technique has been implemented in order to show clusters when the picture is cluttered. A weight is assigned to each event. The weight value is computed as:

$$weight = \sum_{i=1}^n b_i$$

Where:

- $b_i$  is the content of bin crossed by the event on the  $i$ -th axis.
- $n$  is the number of axis.

The events having the bigger weights are those belonging to clusters. It is possible to paint only the events having a weight above a given value and the clusters appear. The next example “weight cut” applied on the right plot is 50. Only the events with a weight greater than 50 are displayed.

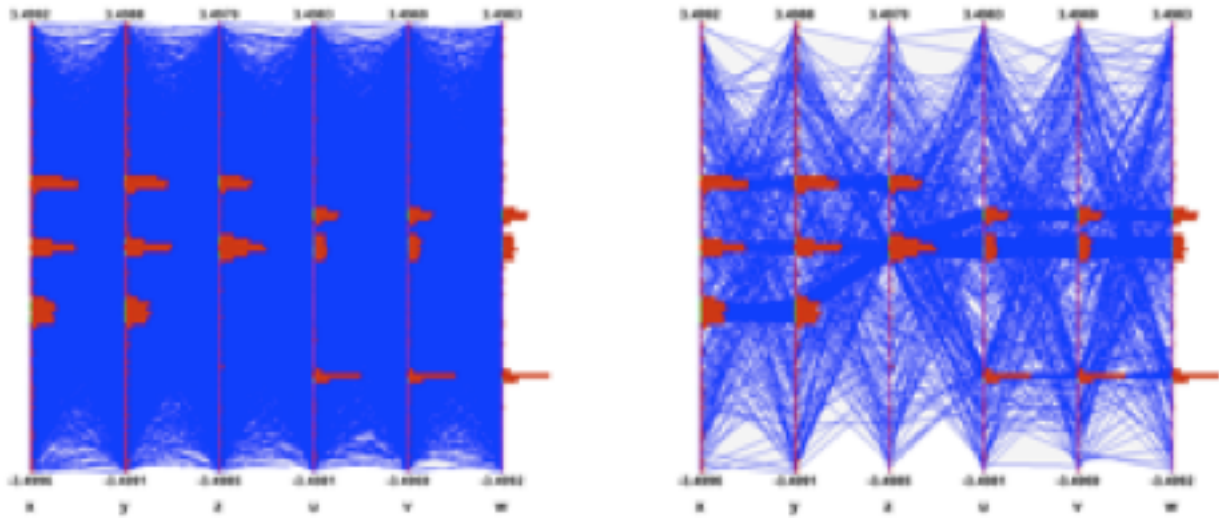

Figure 12.21: Applying a “weight cut” makes the clusters visible.



Figure 12.22: Zoom on a Parallel Coordinates plot detail: curves differentiate better events.



In case only a few events are displayed, drawing them as smooth curves instead of straight lines helps to differentiate them.

Interactivity and therefore the Graphical User Interface are very important to manipulate the Parallel Coordinates plots. The ROOT framework allows to easily implement the direct interactions on the graphical area and the graphical editor facility provides dedicated GUI.

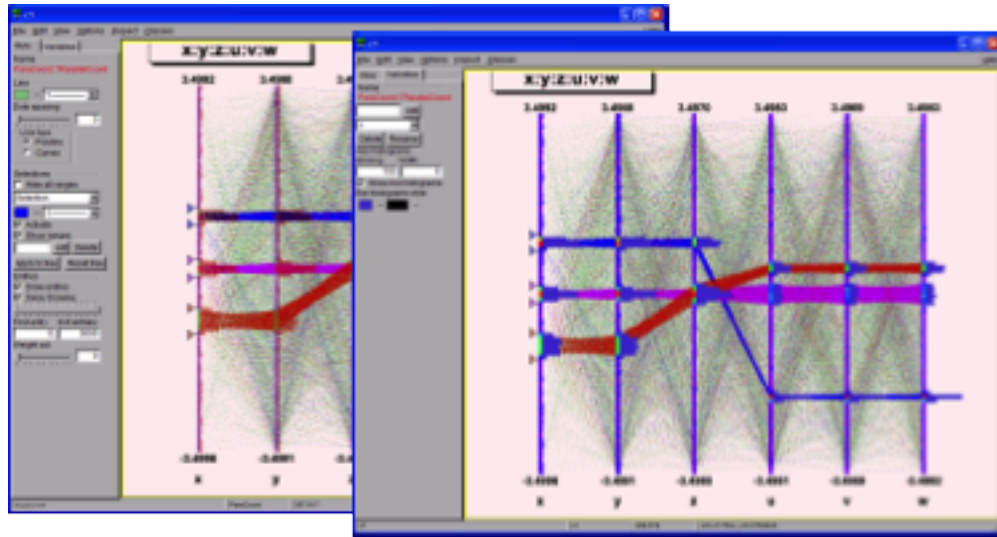

Figure 12.23: Parallel Coordinates graphical editors.

Transparency is very useful with parallel coordinates plots. It allows to show clearly the clusters.

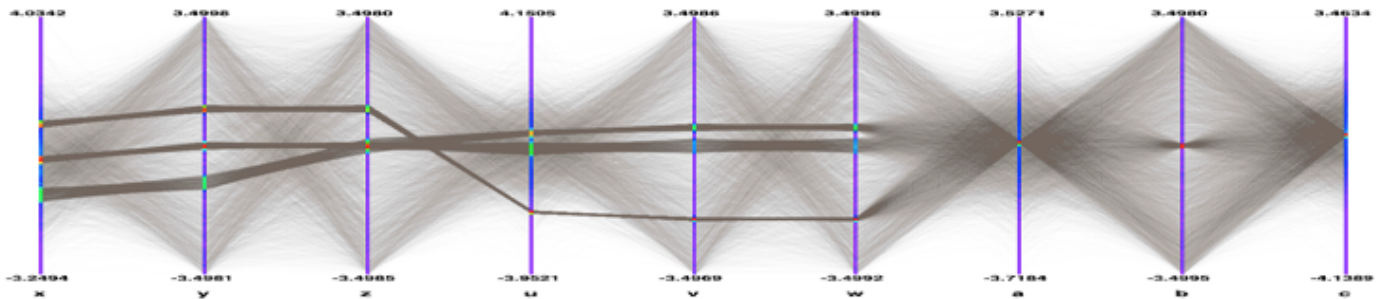

Figure 12.24: Parallel Coordinates with transparency.

### 12.20.8.3 Box (Candle) Plots

A Box Plot (also known as a “box-and whisker” plot or “candle stick” plot) is a convenient way to describe graphically a data distribution (D) with only the five numbers. It was invented in 1977 by John Tukey. The five numbers are:

1. The minimum value of the distribution D (Min).
2. The lower quartile (Q1): 25% of the data points in D are less than Q1.
3. The median (M): 50% of the data points in D are less than M.
4. The upper quartile (Q3): 75% of the data points in D are less than Q3.
5. The maximum value of the distribution D (Max).

In ROOT Box Plots (Candle Plots) can be produced from a TTree using the “candle” option in TTree::Draw().

```
tree->Draw("px:cos(py):sin(pz)", "", "candle");
```

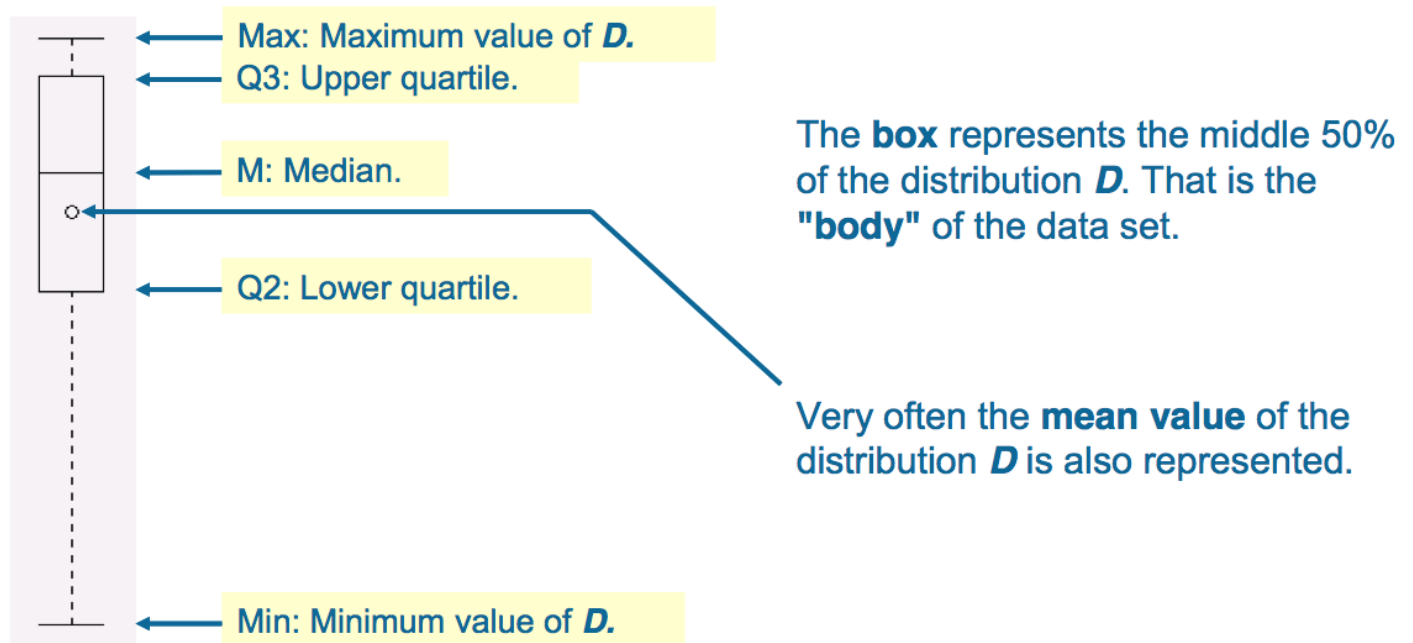

Figure 12.25: A box plot describes a distribution with only five numbers.

### 12.20.9 Using TTree::Scan

TTree::Scan can be used to print the content of the tree's entries optional passing a selection.

```
root [] MyTree->Scan();
```

will print the first 8 variables of the tree.

```
root [] MyTree->Scan("*");
```

will print all the variable of the tree.

Specific variables of the tree can be explicit selected by list them in column separated list:

```
root [] MyTree->Scan("var1:var2:var3");
```

will print the values of var1, var2 and var3. A selection can be applied in the second argument:

```
root [] MyTree->Scan("var1:var2:var3", "var1==0");
```

will print the values of var1, var2 and var3 for the entries where var1 is exactly 0.

TTree::Scan returns the number of entries passing the selection. By default 50 rows are shown before TTree::Scan pauses and ask you to press the Enter key to see the next 50 rows. You can change the default number of rows to be shown before <CR> via mytree->SetScanField(maxrows) where maxrows is 50 by default. If maxrows is set to 0 all rows of the TTree are shown. This option is interesting when dumping the contents of a Tree to an ascii file, eg from the command line:

```
root [] tree->SetScanField(0);
root [] tree->Scan("*"); >tree.log
```

will create a file tree.log.

Arrays (within an entry) are printed in their linear forms. If several arrays with multiple dimensions are printed together, they will NOT be synchronized. For example, with a tree containing arr1[4][2] and arr2[2][3],

```
root[] MyTree("arr1:arr2");
```

will results in a printing similar to:

```
*****
*   Row   * Instance *      arr1 *      arr2 *
*****
*     x *      0 * arr1[0][0]* arr2[0][0]*
*     x *      1 * arr1[0][1]* arr2[0][1]*
*     x *      2 * arr1[1][0]* arr2[0][2]*
*     x *      3 * arr1[1][1]* arr2[1][0]*
*     x *      4 * arr1[2][0]* arr2[1][1]*
*     x *      5 * arr1[2][1]* arr2[1][2]*
*     x *      6 * arr1[3][0]*          *
*     x *      7 * arr1[3][1]*          *
```

However, if there is a selection criterium which is an array, then all the formulas will be synchronized with the selection criterium (see `TTree::Draw` for more information).

The third parameter of `TTree::Scan` can be use to specific the layout of the table:

- `lenmax=dd` - where 'dd' is the maximum number of elements per array that should be printed. If 'dd' is 0, all elements are printed (this is the default).
- `colsize=ss` - where 'ss' will be used as the default size for all the column. If this options is not specified, the default column size is 9.
- `precision=pp` - where 'pp' will be used as the default 'precision' for the printing format.
- `col=xxx` - where 'xxx' is colon (:) delimited list of printing format for each column if no format is specified for a column, the default is used.

For example:

```
tree->Scan("a:b:c", "", "colsize=30 precision=3 col=:20.10");
```

will print 3 columns, the first 2 columns will be 30 characters long, the third columns will be 20 characters long. The printf format for the columns (assuming they are numbers) will be respectively: `%30.3g %30.3g %20.10g`.

### 12.20.10 TEventList and TEntryList

The `TTree::Draw` method can also be used to build a list of the entries. When the first argument is preceded by ">>" ROOT knows that this command is not intended to draw anything, but to save the entries in a list with the name given by the first argument. As a result, a `TEventList` or a `TEntryList` object is created in the current directory. For example, to create a `TEventList` of all entries with more than 600 tracks, do:

```
root[] TFile *f = new TFile("Event.root");
root[] T->Draw(">> myList", "fNtrack > 600");
```

To create a `TEntryList`, use the option "entrylist".

```
root[] T->Draw(">>myList", "fNtrack>600", "entrylist");
```

This list contains the entry number of all entries with more than 600 tracks. To see the entry numbers use the `Print("all")` command.

```
root[] myList->Print("all");
```



When using the “>>” whatever was in the list is overwritten. The list can be grown by using the “>>+” syntax. For example to add the entries, with exactly 600 tracks:

```
root [] T->Draw(">>+ myList", "fNtrack == 600", "entrylist");
```

If the Draw command generates duplicate entries, they are not added to the list.

```
root [] T->Draw(">>+ myList", " fNtrack > 610", "entrylist");
```

This command does not add any new entries to the list because all entries with more than 610 tracks have already been found by the previous command for entries with more than 600 tracks.

### 12.20.10.1 Main Differences between TEventList and TEntryList

The functionality is essentially the same: both are used to store entry numbers. **TEntryList**, however, uses considerably less memory for storage, and is optimized for both very high and very low selectivity of cuts (see **TEntryListBlock** class description for the details of internal storage). Unlike the **TEventList**, **TEntryList** makes a distinction between indices from a **TChain** and from a **TTree**. While a **TEntryList** for a **TTree** can be seen as just a list of numbers, a **TEntryList** for a **TChain** is a collection of **TEntryList**(s) for the **TTree**(s) that constitute this **TChain**. Such “sub-lists” can be extracted by calling the function

```
TEntryList::GetEntryList(const char *treename, const char *filename)
```

and then be used to construct a new **TEntryList** for a new **TChain**, or processed independently as normal **TEntryList**(s) for **TTree**(s). This modularity makes **TEntryList** much better suited for PROOF processing than the **TEventList**.

### 12.20.10.2 Using an Event List

A **TEventList** or a **TEntryList** can be used to limit the **TTree** to the events in the list. The methods **SetEventList** and **SetEntryList** tell the tree to use the list and hence limit all subsequent calls to **Draw**, **Scan**, **Process**, **Query**, **Principal** and **CopyTree** methods to the entries in the list. In general, it affects the **GetEntryNumber** method and all functions using it for looping over the tree entries. The **GetEntry** and **GetEntries** methods are not affected. Note, that in the **SetEventList** method, the **TEventList** argument is internally transformed into a **TEntryList**, and this operation, in case of a **TChain**, requires loading of all the tree headers. In this example, we create a list with all entries with more than 600 tracks and then set it so that the tree will use this list. To reset the **TTree** to use all events use **SetEventList(0)** or **SetEntryList(0)**.

1. Let's look at an example. First, open the file and draw the **fNtrack**.

```
root [] TFile *f = new TFile("Event.root");
root [] TTree *T = (TTree*)f->Get("T");
root [] T->Draw("fNtrack");
```

2. Now, put the entries with over 600 tracks into a **TEntryList** called **myList**. We get the list from the current directory and assign it to a variable **list**.

```
root [] T->Draw(">>myList", "fNtrack > 600", "entrylist");
root [] TEntryList *list=(TEntryList*)gDirectory->Get("myList");
```

3. Instruct the tree **T** to use the new list and draw it again. Note that this is exactly the same **Draw** command. The list limits the entries.

```
root [] T->SetEntryList(list);
root [] T->Draw("fNtrack");
```

You should now see a canvas similar to this one.

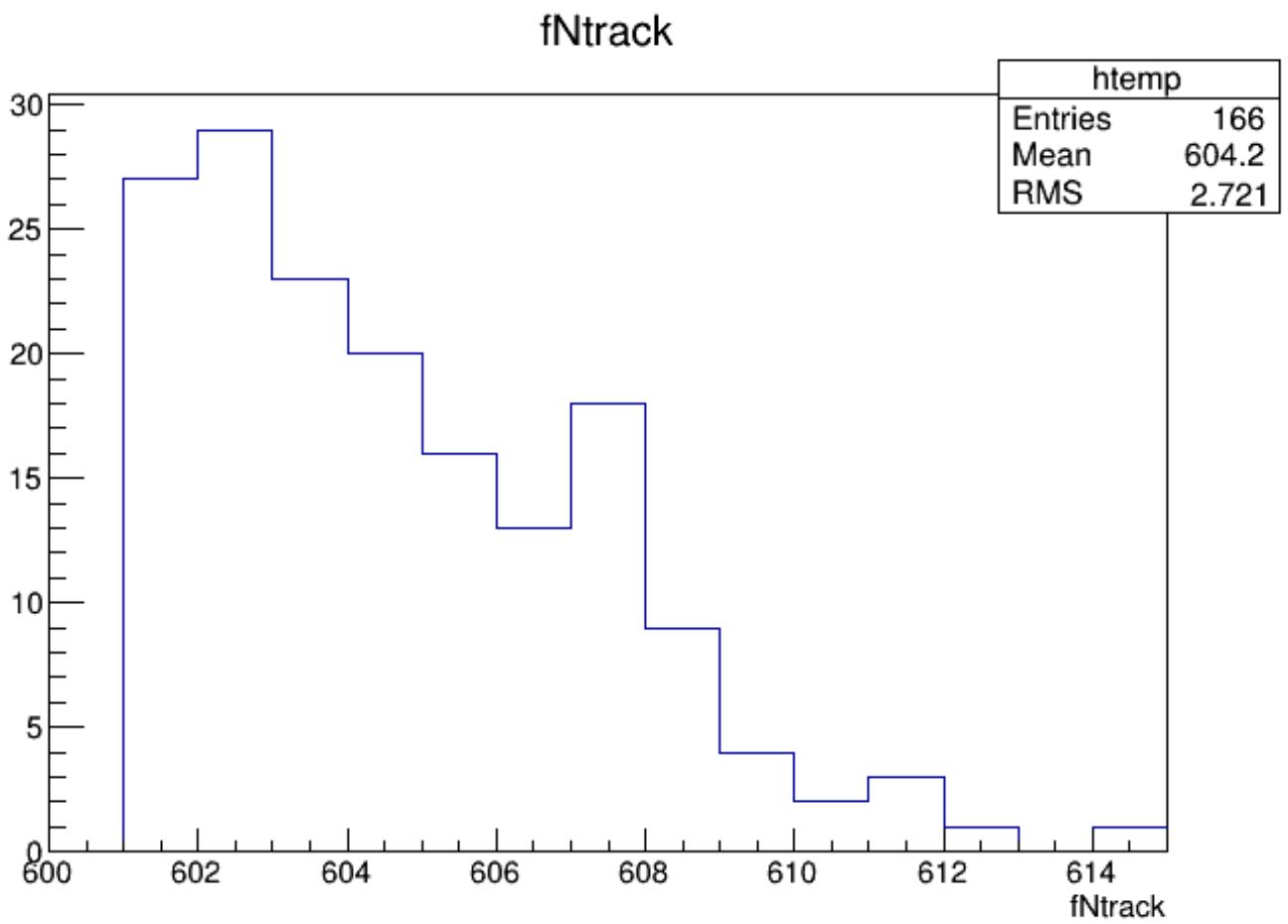

### 12.20.10.3 Operations on TEntryLists

If you have entry lists that were created using different cuts, you can combine the lists to get a new list, with entries passing at least one of the cuts. Example:

```
root[] T->Draw(">>list1","fNtrack>600","entrylist");
root[] TEntryList *list1 = (TEntryList*)gDirectory->Get("list1");
root[] T->Draw(">>list2","fNtrack<590","entrylist");
root[] TEntryList *list2 = (TEntryList*)gDirectory->Get("list2");
root[] list1->Add(list2);
```

list1 now contains entries with more than 600 or less than 590 tracks. Check this by calling:

```
root[] T->SetEntryList(list1);
root[] T->Draw("fNtrack");
```

You can also subtract **TEntryList** from each other, so that the first list contains only the entries, passing the selection of the first list and not present in the second list.

To add some individual entries, use **TEntryList::Enter()** function. To remove the entries you don't like, use **TEntryList::Remove()**. To see if the entry is in the list, use **TEntryList::Contains()**. Remember, that all operation in a **TEntryList** for a **TChain** are on the **TTree** level. This is illustrated by the following example:

```
root[] TEntryList *list1 = new TEntryList("list1","list1");
root[] list1->SetTree("tree1","file1")
root[] list1->Enter(0);
root[] list1->Enter(2);
root[] TEntryList *list2 = new TEntryList("list2", "list2");
root[] list2->SetTree("tree2", "file2");
root[] list2->Enter(0);
root[] list2->Enter(3);
root[] list1->Add(list2);
root[] list1->Print("all")
tree1 file1
0
2
tree2 file2
0
3
```

The result is a **TEntryList** for a **TChain** of **tree1** and **tree2**. If the second list was for the same **TTree** in the same file as the first list, the result would be as follows:

```
root[] TEntryList *list2_2 = new TEntryList("list2_2", "list2_2");
root[] list2_2->SetTree("tree2", "file2");
root[] list2_2->Enter(1);
root[] list2_2->Enter(2);
root[] list2->Add(list2_2);
root[] list2->Print("all")
tree2 file2
0
1
2
3
```

#### 12.20.10.4 TEntryListFromFile

This is a special kind of `TEntryList`, used only when processing `TChain` objects (see the method `TChain::SetEntryListFile()`). It is used in the case, when the entry lists, corresponding to the trees of this chain, are stored in separate files. It allows to load the entry lists in memory one by one, keeping only the list for the currently processed tree loaded.

For more details on entry lists, see `TEntryList`, `TEntryListBlock` and `TEntryListFromFile` class descriptions, functions `TChain::SetEntryList()`, `TChain::SetEntryListFile()`, and the macro `$ROOTSYS/test/stressEntryList.C`.

#### 12.20.11 Filling a Histogram

The `TTree::Draw` method can also be used to fill a specific histogram. The syntax is:

```
root[] TFile *f = new TFile("Event.root")
root[] T->Draw("fNtrack >> myHisto")
root[] myHisto->Print()
TH1.Print Name= myHisto, Entries= 100, Total sum= 100
```

As we can see, this created a `TH1`, called `myHisto`. If you want to append more entries to the histogram, you can use this syntax:

```
root[] T->Draw("fNtrack >>+ myHisto")
```

If you do not create a histogram ahead of time, `ROOT` will create one at the time of the `Draw` command (as is the case above). If you would like to draw the variable into a specific histogram where you, for example, set the range and bin number, you can define the histogram ahead of time and use it in the `Draw` command. The histogram has to be in the same directory as the tree.

```
root[] TH1 *h1 = new TH1("h1", "h1", 50, 0., 150.);
root[] T->Draw("fNtrack>> h1");
```

When you project a `TTree` into a histogram, the histogram inherits the `TTree` attributes and not the current style attributes. This allows you to project two Trees with different attributes into the same picture. You can call the method `TTree::UseCurrentStyle` to change the histogram to use the current style `gStyle`. See “Graphics and the Graphical User Interface.

The binning of the newly created histogram can be specified in two ways. You can set a default in the `.rootrc` and/or you can add the binning information in the `TTree::Draw` command.

To set number of bins default for the 1-D, 2-D, 3-D histograms can be specified in the `.rootrc` file via the environment variables, e.g.:

```
# default binnings   Hist.Binning.1D.x: 100
```

```
Hist.Binning.2D.x: 40
Hist.Binning.2D.y: 40
Hist.Binning.2D.Prof: 100
```

```
Hist.Binning.3D.x: 20
Hist.Binning.3D.y: 20
Hist.Binning.3D.z: 20
Hist.Binning.3D.Profx: 100
Hist.Binning.3D.Profy: 100
```

To set the number of bins for a specific histogram when using `TTree::Draw`, add up to nine numbers following the histogram name. The numbers meaning is:

1 bins in x-direction

2 lower limit in x-direction

3upper limit in x-direction

4-6 same for y-direction

7-9 same for z-direction

When a bin number is specified, the value becomes the default. Any of the numbers can be skipped. For example:

```
tree.Draw("sqrt(x)>>hsqrt(500,10,20)");
// plot sqrt(x) between 10 and 20 using 500 bins
tree.Draw("sqrt(x):sin(y)>>hsqrt(100,10,,50,.1,.5)");
// plot sqrt(x) against sin(y) 100 bins in x-direction;
// lower limit on x-axis is 10; no upper limit
// 50 bins in y-direction; lower limit on y-axis is .1;
// upper limit is .5
```

When the name is followed by binning information, appending the histogram with a "+", will not reset `hsqrt`, but will continue to fill it.

```
tree.Draw("sqrt(x)>>+hsqrt","y>0");
```

This works for 1-D, 2-D and 3-D histograms.

### 12.20.11.1 Projecting a Histogram

If you would like to fill a histogram, but not draw it you can use the `TTree::Project()` method.

```
root[] T->Project("quietHisto","fNtrack")
```

### 12.20.11.2 Making a Profile Histogram

In case of a two dimensional expression, you can generate a **TProfile** histogram instead of a two dimensional histogram by specifying the 'prof' or 'profs' option. The `prof` option is automatically selected when the output is redirected into a **TProfile**. For example `y:x>>pf` where `pf` is an existing **TProfile** histogram.

### 12.20.11.3 Tree Information

Once we have drawn a tree, we can get information about the tree. These are the methods used to get information from a drawn tree **TTree**:

- `GetSelectedRows`: Returns the number of entries accepted by the selection expression. In case where no selection was specified, it returns the number of entries processed.
- `GetV1`: Returns a pointer to the float array of the first variable.
- `GetV2`: Returns a pointer to the float array of second variable
- `GetV3`: Returns a pointer to the float array of third variable.
- `GetW`: Returns a pointer to the float array of Weights where the weight equals the result of the selection expression.

To read the drawn values of `fNtrack` into an array, and loop through the entries follow the lines below. First, open the file and draw the `fNtrack` variable:

```
root[] TFile *f = new TFile("Event.root")
root[] T->Draw("fNtrack")
```

Then declare a pointer to a float and use the `GetV1` method to retrieve the first dimension of the tree. In this example we only drew one dimension (`fNtrack`) if we had drawn two, we could use `GetV2` to get the second one.

```
root[] Float_t *a
root[] a = T->GetV1()
```

Loop through the first 10 entries and print the values of `fNtrack`:

```
root[] for (int i = 0; i < 10; i++)
root[] cout << a[i] << " " << endl // need an endl to see the values
594 597 606 595 604 610 604 602 603 596
```

By default, `TTree::Draw` creates these arrays with `fEstimate` words where `fEstimate` can be set via `TTree::SetEstimate`. If you have more entries than `fEstimate` only the first `fEstimate` selected entries will be stored in the arrays. The arrays are used as buffers. When `fEstimate` entries have been processed, `ROOT` scans the buffers to compute the minimum and maximum of each coordinate and creates the corresponding histograms. You can use these lines to read all entries into these arrays:

```
root[] Int_t nestimate = (Int_t)T->GetEntries();
root[] T->SetEstimate(nestimate);
```

Obviously, this will not work if the number of entries is very large. This technique is useful in several cases, for example if you want to draw a graph connecting all the `x`, `y` (or `z`) points. Note that you may have a tree (or chain) with 1 billion entries, but only a few may survive the cuts and will fit without problems in these arrays.

## 12.21 Using TTree::MakeClass

The `TTree::Draw` method is convenient and easy to use; however it falls short if you need to do some programming with the variable.

For example, for plotting the masses of all oppositely charged pairs of tracks, you would need to write a program that loops over all events, finds all pairs of tracks, and calculates the required quantities. We have shown how to retrieve the data arrays from the branches of the tree in the previous section, and you could just write that program from scratch. Since this is a very common task, `ROOT` provides a utility that generates a skeleton class designed to loop over the entries of the tree.

This is the `TTree::MakeClass` method. We will now go through the steps of using `MakeClass` with a simplified example. The methods used here obviously work for complex event loop calculations.

These are our assumptions: we would like to do selective plotting and loop through each entry of the tree and tracks. We chose a simple example: we want to plot `fPx` of the first 100 tracks of each entry. We have a `ROOT` tree with a branch for each data member in the “`Event`” object. To build this file and tree follow the instructions on how to build the examples in `$ROOTSYS/test`. Execute `Event` and instruct it to split the object with this command (from the UNIX command line).

```
> $ROOTSYS/test/Event 400 1 2 1
```

This creates an `Event.root` file with 400 events, compressed, split, and filled.

See `$ROOTSYS/test/MainEvent.cxx` for more info.

The person who designed the tree makes a shared library available to you, which defines the classes needed. In this case, the classes are `Event`, `EventHeader`, and `Track` and they are defined in the shared library `libEvent.so`. The designer also gives you the `Event.h` file to see the definition of the classes. You can locate `Event.h` in `$ROOTSYS/test`, and if you have not yet built `libEvent.so`, please see the instructions of how to build it (typing `make` in `$ROOTSYS/test` is enough). If you have already built it, you can now use it again.

### 12.21.1 Creating a Class with MakeClass

First, we load the shared library and open `Event.root`.

```
root[] .L libEvent.so
root[] TFile *f = new TFile("Event.root");
root[] f->ls();
TFile**      Event.root      TTree benchmark ROOT file
TFile*       Event.root      TTree benchmark ROOT file
KEY: TH1F     htime;1 Real-Time to write versus time
KEY: TTree    T;1           An example of a ROOT tree
```

We can see there is a tree “T”, and just to verify that we are working with the correct one, we print the tree, which will show us the header and branches.

```
root[] T->Print();
```

From the output of print we can see that the tree has one branch for each data member of `Event`, `Track`, and `EventHeader`. Now we can use `TTree::MakeClass` on our tree “T”. `MakeClass` takes one parameter, a string containing the name of the class to be made. In the command below, the name of our class will be “MyClass”.

```
root[] T->MakeClass("MyClass")
Files: MyClass.h and MyClass.C generated from Tree: T
```

CINT informs us that it has created two files. `MyClass.h` contains the class definition and `MyClass.C` contains the `MyClass::Loop()` method. `MyClass` has more methods than just `Loop()`. The other methods are a constructor, a destructor, `GetEntry()`, `LoadTree()`, `Notify()`, `Cut()` and `Show()`. The implementations of these methods are in the `.h` file. This division of methods was done intentionally. The `.C` file is kept as short as possible, and contains only code that is intended for you to customize. The `.h` file contains all the other methods. It is clear that you want to be as independent as possible of the header file (i.e. `MyClass.h`) generated by `MakeClass`. The solution is to implement a derived class, for example `MyRealClass` deriving from `MyClass` such that a change in your `Tree` or regeneration of `MyClass.h` does not force you to change `MyRealClass.h`. You can imagine deriving several classes from `MyClass.h`, each with a specific algorithm. To understand both files, let’s start with `MyClass.h` and the class declaration:

### 12.21.2 MyClass.h

```
class MyClass {
public :
    // Pointer to the analyzed TTree or TChain
    TTree      *fChain;
    // Current Tree number in a TChain
    Int_t      fCurrent;
    // Declaration of leaves types
    UInt_t     fUniqueID;
    UInt_t     fBits;
    Char_t     fType[20];
    Int_t      fNtrack;
    Int_t      fNseg;
    Int_t      fNvertex;
    UInt_t     fFlag;
    Float_t    fTemperature;
    Int_t      fEvtHdr_fEvtNum;
    // List of branches
    TBranch    *b_fUniqueID;
    TBranch    *b_fBits;
    TBranch    *b_fType;
```

```

TBranch      *b_fNtrack;
TBranch      *b_fNseg;
TBranch      *b_fNvertex;
TBranch      *b_fFlag;
TBranch      *b_fTemperature;
TBranch      *b_fEvtHdr_fEvtNum;
...
        MyClass(TTree *tree=0);
        ~MyClass();
Int_t  Cut(Int_t entry);
Int_t  GetEntry(Int_t entry);
Int_t  LoadTree(Int_t entry);
void   Init(TTree *tree);
void   Loop();
Bool_t Notify();
void   Show(Int_t entry = -1);
};

```

We can see data members in the generated class. The first data member is `fChain`. Once this class is instantiated, `fChain` will point to the original tree or chain this class was made from. In our case, this is “T” in “`Event.root`”. If the class is instantiated with a tree as a parameter to the constructor, `fChain` will point to the tree named in the parameter. Next is `fCurrent`, which is also a pointer to the current tree/chain. Its role is only relevant when we have multiple trees chained together in a `TChain`. The class definition shows us that this tree has one branch and one leaf per data member. The methods of `MyClass` are:

- `MyClass(TTree *tree=0)` - this constructor has an optional tree for a parameter. If you pass a tree, `MyClass` will use it rather than the tree from which it was created.
- `void Init(TTree *tree)` - it is called by the constructor to initialize the tree for reading. It associates each branch with the corresponding leaf data member.
- `~MyClass()` -the destructor, nothing special.
- `Int_t GetEntry(Int_t entry)` - it loads the class with the entry specified. Once you have executed `GetEntry`, the leaf data members in `MyClass` are set to the values of the entry. For example, `GetEntry(12)` loads the 13th event into the event data member of `MyClass` (note that the first entry is 0). `GetEntry` returns the number of bytes read from the file. In case the same entry is read twice, `ROOT` does not have to do any I/O. In this case `GetEntry` returns 1. It does not return 0, because many people assume a return of 0 means an error has occurred while reading.
- `Int_t LoadTree(Int_t entry)` and `void Notify()` - these two methods are related to chains. `LoadTree` will load the tree containing the specified entry from a chain of trees. `Notify` is called by `LoadTree` to adjust the branch addresses.
- `void Loop()` - it is the skeleton method that loops through each entry of the tree. This is interesting to us, because we will need to customize it for our analysis.

### 12.21.3 MyClass.C

`MyClass::Loop` consists of a for-loop calling `GetEntry` for each entry. In the template, the numbers of bytes are added up, but it does nothing else. If we were to execute it now, there would be no output.

```

void MyClass::Loop() {
    if (fChain == 0) return;

    Int_t nentries = Int_t(fChain->GetEntries());
    Int_t nbytes = 0, nb = 0;
    for (Int_t jentry=0; jentry<nentries;jentry++) {
        Int_t ientry = LoadTree(jentry);
        // in case of a TChain , ientry is the entry number in the

```



```

    // current file
    nb = fChain->GetEntry(jentry);   nbytes += nb;
    // if (Cut(ientry) < 0) continue;
}
}

```

At the beginning of the file are instructions about reading selected branches. They are not reprinted here, but please read them from your own file

### 12.21.4 Modifying MyClass::Loop

Let us continue with the goal of going through the first 100 tracks of each entry and plot Px. To do this we change the Loop method.

```

...
if (fChain == 0) return;
Int_t nentries = fChain->GetEntries();
TH1F *myHisto = new TH1F("myHisto","fPx", 100, -5,5);
TH1F *smallHisto = new TH1F("small","fPx", 100, -5,5);
...

```

In the for-loop, we need to add another for-loop to go over all the tracks. In the outer for-loop, we get the entry and the number of tracks. In the inner for-loop, we fill the large histogram (myHisto) with all tracks and the small histogram (smallHisto) with the track if it is in the first 100.

```

...
for (Int_t jentry=0; jentry<nentries;jentry++) {
  GetEntry(jentry);
  for (Int_t j = 0; j < 100; j++) {
    myHisto->Fill(fTracks_fPx[j]);
    if (j < 100) {
      smallHisto->Fill(fTracks_fPx[j]);
    }
  }
}
}
...

```

Outside of the for-loop, we draw both histograms on the same canvas.

```

...
myHisto->Draw();
smallHisto->Draw("Same");
...

```

Save these changes to MyClass.C and start a fresh root session. We will now load MyClass and experiment with its methods.

### 12.21.5 Loading MyClass

The first step is to load the library and the class file. Then we can instantiate a MyClass object.

```

root[] .L libEvent.so
root[] .L MyClass.C
root[] MyClass m

```

Now we can get a specific entry and populate the event leaf. In the code snippet below, we get entry 0, and print the number of tracks (594). Then we get entry 1 and print the number of tracks (597).

```
root[] m.GetEntry(0)
(int)57503
root[] m.fNtrack()
(Int_t)594
root[] m.GetEntry(1)
(int)48045
root[] m.fNtrack()
(Int_t)597
```

Now we can call the Loop method, which will build and display the two histograms.

```
root[] m.Loop()
```

You should now see a canvas that looks like this.

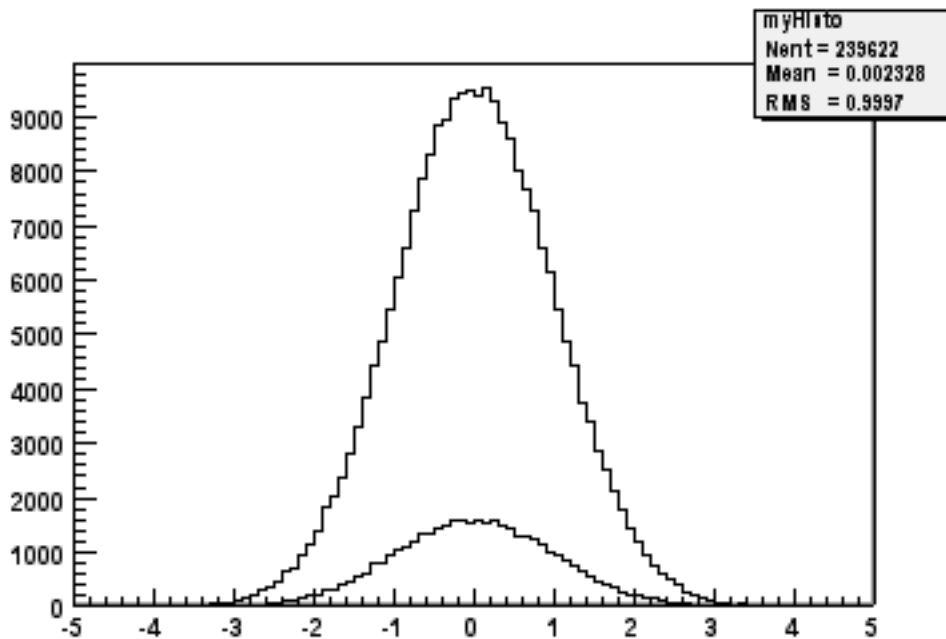

To conclude the discussion on `MakeClass` let us list the steps that got us here.

- Call `TTree::MakeClass`, which automatically creates a class to loop over the tree.
- Modify the `MyClass::Loop()` method in `MyClass.C` to fit your task.
- Load and instantiate `MyClass`, and run `MyClass::Loop()`.

## 12.22 Using `TTree::MakeSelector`

With a `TTree` we can make a selector and use it to process a limited set of entries. This is especially important in a parallel processing configuration where the analysis is distributed over several processors and we can specify which entries

to send to each processor. The `TTree::Process` method is used to specify the selector and the entries. Before we can use `TTree::Process` we need to make a selector. We can call the `TTree::MakeSelector` method. It creates two files similar to `TTree::MakeClass`.

In the resulting files is a class that is a descendent of `TSelector` and implements the following methods:

- `TSelector::Begin()` - this method is called every time a loop over the tree starts. This is a convenient place to create your histograms.
- `TSelector::Notify()` - it is called at the first entry of a new tree in a chain.
- `TSelector::Process()` - it is called to process an event. It is the user's responsibility to read the corresponding entry in memory (may be just a partial read). Once the entry is in memory one can apply a selection and if the event is selected histograms can be filled. Processing stops when this function returns `kFALSE`. It combines the methods `TSelector::ProcessCut()` and `TSelector::ProcessFill()` in one, avoiding the necessity to maintain the state in the class to communicate between these two functions. It reduces the information that needs to be shared between them and promotes a more granular data access by reading branches as they are needed.
- `TSelector::Terminate()` - it is called at the end of a loop on a `TTree`. This is a convenient place to draw and fit your histograms.
- `TSelector::Version()` - this function provides backward compatibility for old versions and support for the future upgrades.
- The `TSelector`, unlike the resulting class from `MakeClass`, separates the processing into a `ProcessCut()` and `ProcessFill()`, so we can limit reading of branches to the ones we need.
- When a selector is used with a `TChain` in methods `Process()`, `ProcessFill()`, `ProcessCut()`, you must use the pointer to the current `TTree` to call the method `GetEntry(entry)`. The parameter `entry` is always the local entry number in the current tree. Assuming that `fChain` is the pointer to the `TChain` being processed, use

```
fChain->GetTree()->GetEntry(entry);
```

To create a selector call:

```
root [] T->MakeSelector("MySelector");
```

Where `T` is the `TTree` and `MySelector` is the name of created class and the name of the `.h` and `.C` files. The resulting `TSelector` is the argument to `TTree::Process`. The argument can be the file name or a pointer to the selector object.

```
root [] T->Process("MySelector.C", "", 1000, 100);
```

This call will interpret the class defined in `MySelector.C` and process 1000 entries beginning with entry 100. The file name can be appended with a "+" or a "++" to use `ACLIC`.

```
root [] T->Process("MySelector.C++", "", 1000, 100);
```

When appending a "++", the class will be compiled and dynamically loaded.

```
root [] T->Process("MySelector.C+", "", 1000, 100);
```

When appending a "+", the class will also be compiled and dynamically loaded. When it is called again, it recompiles only if the macro (`MySelector.C`) has changed since it was compiled last. If not, it loads the existing library. The next example shows how to create a selector with a pointer:

```
MySelector *selector = (MySelector *)TSelector::GetSelector("MySelector.C+");
T->Process(selector);
```

Using this form, you can do things like:

```
selector->public_attribute1 = init_value;
for (int i=0; i<limit; i++) {
    T->Process(selector);
    selector->public_attribute1 =
        function(selector->public_attribute2);
}
```

`TTree::Process()` is aware of PROOF, ROOT parallel processing facility. If PROOF is setup, it divides the processing amongst the slave CPUs.

### 12.22.1 Performance Benchmarks

The program `$ROOTSYS/test/bench.cxx` compares the I/O performance of STL vectors to the ROOT native `TClonesArrays` collection class. It creates trees with and without compression for the following cases: `vector<THit>`, `vector<THit*>`, `TClonesArray(TObjHit)` not split `TClonesArray(TObjHit)` split.

The next graphs show the two columns on the right which represent the split and non-split `TClonesArray`, are significantly lower than the vectors. The most significant difference is in reading a file without compression.

The file size with compression, write times with and without compression and the read times with and without compression all favor the `TClonesArray`.

## 12.23 Impact of Compression on I/O

This benchmark illustrates the pros and cons of the compression option. We recommend using compression when the time spent in I/O is small compared to the total processing time. In this case, if the I/O operation is increased by a factor of 5 it is still a small percentage of the total time and it may very well save a factor of 10 on disk space. On the other hand if the time spend on I/O is large, compression may slow down the program's performance. The standard test program `$ROOTSYS/test/Event` was used in various configurations with 400 events. The data file contains a `TTree`. The program was invoked with:

Event 400 comp split

- comp = 0 means: no compression at all.
- comp = 1 means: compress everything if split = 0.
- comp = 1 means: compress only the tree branches with integers if split = 1.
- comp = 2 means: compress everything if split=1.
- split = 0 : the full event is serialized into one single buffer.
- split = 1 : the event is split into branches. One branch for each data member of the Event class. The list of tracks (a `TClonesArray`) has the data members of the Track class also split into individual buffers.

These tests were run on Pentium III CPU with 650 MHz.

Event Parameters	File Size	Total Time to Write (MB/sec)	Effective Time to Write (MB/sec)	Total Time to Read All (MB/sec)	Total Time to Read Sample (MB/sec)
Comp = 0 Split = 1	19.75 MB	6.84 s.(2.8 MB/s)	3.56 s.(5.4 MB/s)	0.79s.(24.2 MB/s)	0.79 s.(24.2 MB/s)
Comp = 1 Split = 1	17.73 MB	6.44 s.(3.0 MB/s)	4.02 s.(4.8 MB/s)	0.90 s.(21.3 MB/s)	0.90 s.(21.3 MB/s)
Comp = 2 Split = 1	13.78 MB	11.34s.(1.7 MB/s)	9.51 s.(2.0 MB/s)	2.17 s.(8.8 MB/s)	2.17 s.(8.8 MB/s)

The **Total Time** is the real time in seconds to run the program. **Effective time** is the real time minus the time spent in non I/O operations (essentially the random number generator). The program **Event** generates in average 600 tracks per event. Each track has 17 data members. The read benchmark runs in the interactive version of ROOT. The ‘Total Time to Read All’ is the real time reported by the execution of the script `&ROOTSYS/test/eventa`.

We did not correct this time for the overhead coming from the interpreter itself. The **Total time to read sample** is the execution time of the script `$ROOTSYS/test/eventb`. This script loops on all events. For each event, the branch containing the number of tracks is read. In case the number of tracks is less than 585, the full event is read in memory. This test is obviously not possible in non-split mode. In non-split mode, the full event must be read in memory. The times reported in the table correspond to complete I/O operations necessary to deal with **machine independent binary files**. On **Linux**, this also includes byte-swapping operations. The ROOT file allows for direct access to any event in the file and direct access to any part of an event when `split=1`.

Note also that the uncompressed file generated with `split=0` is 48.7 Mbytes and only 47.17 Mbytes for the option `split=1`. The difference in size is due to the object identification mechanism overhead when the event is written to a single buffer. This overhead does not exist in split mode because the branch buffers are optimized for homogeneous data types. You can run the test programs on your architecture. The program **Event** will report the write performance. You can measure the read performance by executing the scripts `eventa` and `eventb`. The performance depends not only of the processor type, but also of the disk devices (local, NFS, AFS, etc.).

## 12.24 Chains

A **TChain** object is a list of ROOT files containing the same tree. As an example, assume we have three files called `file1.root`, `file2.root`, `file3.root`. Each file contains one tree called “T”. We can create a chain with the following statements:

```
TChain chain("T"); // name of the tree is the argument
chain.Add("file1.root");
chain.Add("file2.root");
chain.Add("file3.root");
```

The name of the **TChain** will be the same as the name of the tree; in this case it will be “T”. Note that two objects can have the same name as long as they are not histograms in the same directory, because there, the histogram names are used to build a hash table. The class **TChain** is derived from the class **TTree**. For example, to generate a histogram corresponding to the attribute “x” in tree “T” by processing sequentially the three files of this chain, we can use the `TChain::Draw` method.

```
chain.Draw("x");
```

When using a **TChain**, the branch address(es) must be set with:

```
chain.SetBranchAddress(branchname,...) // use this for TChain
```

rather than:

```
branch->SetAddress(...); // this will not work
```

The second form returns the pointer to the branch of the current **TTree** in the chain, typically the first one. The information is lost when the next **TTree** is loaded. The following statements illustrate how to set the address of the object to be read and how to loop on all events of all files of the chain.

```
{
TChain chain("T"); // create the chain with tree "T"
chain.Add("file1.root"); // add the files
chain.Add("file2.root");
chain.Add("file3.root");
```

```

TH1F *hnseg = new TH1F("hnseg",
                      "Number of segments for selected tracks",
                      5000,0,5000);
// create an object before setting the branch address
Event *event = new Event();
// Specify the address where to read the event object
chain.SetBranchAddress("event", &event);

// Start main loop on all events In case you want to read only a few
// branches, use TChain::SetBranchStatus to activate a branch.
Int_t nevent = chain.GetEntries();
for (Int_t i=0;i<nevent;i++) {
    // read complete accepted event in memory
    chain.GetEvent(i);
    // Fill histogram with number of segments
    hnseg->Fill(event->GetNseg());
}
// Draw the histogram
hnseg->Draw();
}

```

### 12.24.1 TChain::AddFriend

**ATChain** has a list of friends similar to a tree (see **TTree::AddFriend**). You can add a friend to a chain with the **TChain::AddFriend** method. With **TChain::GetListOfFriends** you can retrieve the list of friends. The next example has four chains each has 20 ROOT trees from 20 ROOT files.

```

TChain ch("t"); // a chain with 20 trees from 20 files
TChain ch1("t1");
TChain ch2("t2");
TChain ch3("t3");

```

Now we can add the friends to the first chain.

```

ch.AddFriend("t1");
ch.AddFriend("t2");
ch.AddFriend("t3");

```

The parameter is the name of friend chain (the name of a chain is always the name of the tree from which it was created). The original chain has access to all variables in its friends. We can use the **TChain::Draw** method as if the values in the friends were in the original chain. To specify the chain to use in the **Draw** method, use:

```
<chainname>.<branchname>.<varname>
```

If the variable name is enough to identify uniquely the variable, you can leave out the chain and/or branch name. For example, this generates a 3-d scatter plot of variable “var” in the **TChain ch** versus variable **v1** in **TChain t1** versus variable **v2** in **TChain t2**.

```
ch.Draw("var:t1.v1:t2.v2");
```

When a **TChain::Draw** is executed, an automatic call to **TTree::AddFriend** connects the trees in the chain. When a chain is deleted, its friend elements are also deleted.

The number of entries in the friend must be equal or greater to the number of entries of the original chain. If the friend has fewer entries a warning is given and the resulting histogram will have missing entries. For additional information see **TTree::AddFriends()**. A full example of a tree and friends is in Example #3 (`$ROOTSYS/tutorials/tree/tree3.C`) in the Trees section above.

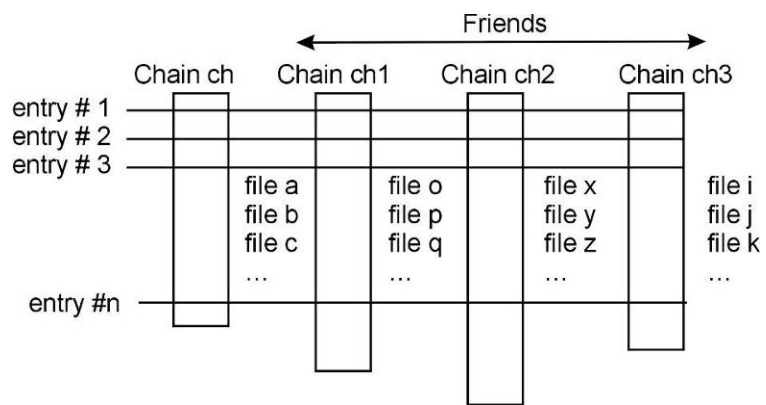





# Chapter 13

## Math Libraries in ROOT

The aim of Math libraries in ROOT is to provide and to support a coherent set of mathematical and statistical functions. The latest developments have been concentrated in providing first versions of the **MathCore** and **MathMore** libraries, included in ROOT v5.08. Other recent developments include the new version of MINUIT, which has been re-designed and re-implemented in the C++ language. It is integrated in ROOT. In addition, an optimized package for describing small matrices and vector with fixed sizes and their operation has been developed (**SMatrix**). The structure is shown in the following picture.

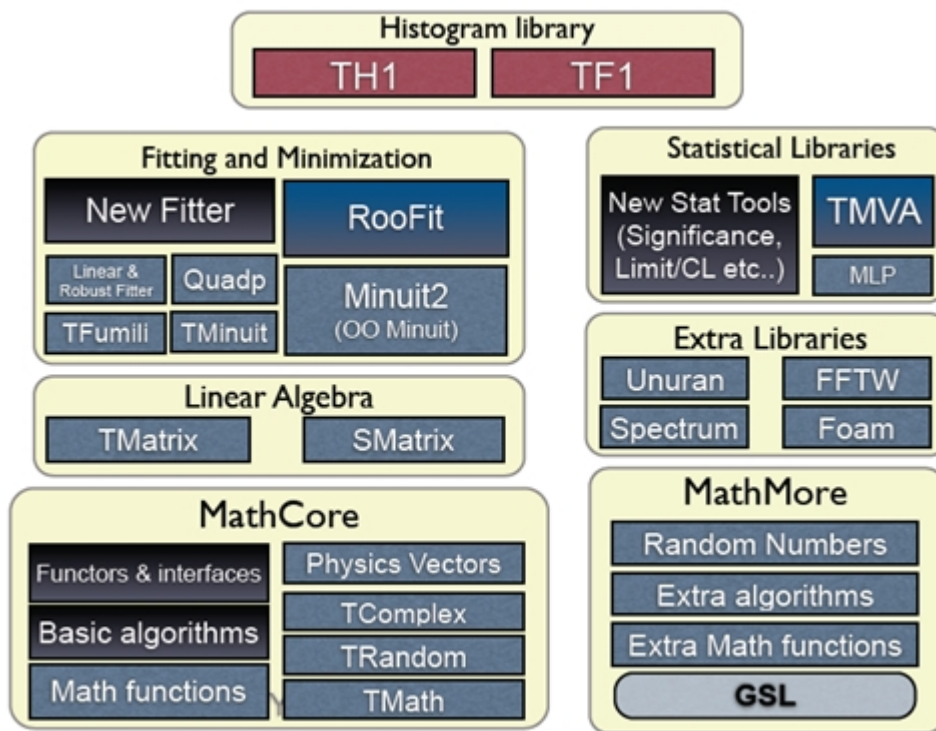

Figure 13.1: Math libraries and packages

### 13.1 TMath

In the namespace, **TMath** a collection of free functions is provided for the following functionality:

- numerical constants (like  $\pi$ ,  $e$ ,  $h$ , etc.);
- elementary and trigonometric functions;

- functions to find `min` and `max` of arrays;
- statistic functions to find mean and `rms` of arrays of data;
- algorithms for binary search/hasing sorting;
- special mathematical functions like `Bessel`, `Erf`, `Gamma`, etc.;
- statistical functions, like common probability and cumulative (quantile) distributions

For more details, see the reference documentation of **TMath** at <http://root.cern.ch/root/html/doc/TMath.html>.

## 13.2 Random Numbers

In ROOT pseudo-random numbers can be generated using the **TRandom** classes. 4 different types exist: **TRandom**, **TRandom1**, **TRandom2** and **TRandom3**. All they implement a different type of random generators. **TRandom** is the base class used by others. It implements methods for generating random numbers according to pre-defined distributions, such as Gaussian or Poisson.

### 13.2.1 TRandom

Pseudo-random numbers are generated using a linear congruential random generator. The multipliers used are the same of the BSD `rand()` random generator. Its sequence is:

$$x_{n+1} = (ax_n + c) \bmod m \text{ with } a = 1103515245, c = 12345 \text{ and } m = 2^{31}.$$

This type of generator uses a state of only a 32 bit integer and it has a very short period,  $2^{31}$ , about  $10^9$ , which can be exhausted in just few seconds. The quality of this generator is therefore BAD and it is strongly recommended to NOT use for any statistical study.

### 13.2.2 TRandom1

This random number generator is based on the Ranlux engine, developed by M. Lüscher and implemented in Fortran by F. James. This engine has mathematically proven random proprieties and a long period of about  $10^{171}$ . Various luxury levels are provided (1,2,3,4) and can be specified by the user in the constructor. Higher the level, better random properties are obtained at a price of longer CPU time for generating a random number. The level 3 is the default, where any theoretical possible correlation has very small chance of being detected. This generator uses a state of 24 32-bits words. Its main disadvantage is that is much slower than the others (see timing table). For more information on the generator see the following article:

- F. James, "RANLUX: A Fortran implementation of the high quality pseudo-random number generator of Lüscher", Computer Physics Communication, 79 (1994) 111.

### 13.2.3 TRandom2

This generator is based on the maximally equidistributed combined Tausworthe generator by L'Ecuyer. It uses only 3 32-bits words for the state and it has a period of about  $10^{26}$ . It is fast and given its small states, it is recommended for applications, which require a very small random number size. For more information on the generator see the following article:

- P. L'Ecuyer, "Maximally Equidistributed Combined Tausworthe Generators", Mathematics of Computation, 65, 213 (1996), 203-213.

### 13.2.4 TRandom3

This is based on the Mersenne and Twister pseudo-random number generator, developed in 1997 by Makoto Matsumoto and Takuji Nishimura. The newer implementation is used, referred in the literature as MT19937. It is a very fast and very high quality generator with a very long period of  $10^{6000}$ . The disadvantage of this generator is that it uses a state of 624 words. For more information on the generator see the following article:

- M. M. Matsumoto and T. Nishimura, “Mersenne twister: A 623-dimensionally equidistributed uniform pseudorandom number generator”, ACM Trans. on Modeling and Computer Simulations, 8, 1, (1998), 3-20.

**TRandom3** is the recommended random number generator, and it is used by default in ROOT using the global *gRandom* object (see chapter *gRandom*).

### 13.2.5 Seeding the Generators

The seeds for the generators can be set in the constructor or by using the **SetSeed** method. When no value is given the generator default seed is used, like 4357 for **TRandom3**. In this case identical sequence will be generated every time the application is run. When the 0 value is used as seed, then a unique seed is generated using a **TUUID**, for **TRandom1**, **TRandom2** and **TRandom3**. For **TRandom** the seed is generated using only the machine clock, which has a resolution of about 1 sec. Therefore identical sequences will be generated if the elapsed time is less than a second.

### 13.2.6 Examples of Using the Generators

The method **Rndm()** is used for generating a pseudo-random number distributed between 0 and 1 as shown in the following example:

```
// use default seed
// (same random numbers will be generated each time)
TRandom3 r; // generate a number in interval ]0,1] (0 is excluded)
r.Rndm();
double x[100];
r.RndmArray(100,x); // generate an array of random numbers in ]0,1]
TRandom3 rdm(111); // construct with a user-defined seed
// use 0: a unique seed will be automatically generated using TUUID
TRandom1 r1(0);
TRandom2 r2(0);
TRandom3 r3(0);
// seed generated using machine clock (different every second)
TRandom r0(0);
```

### 13.2.7 Random Number Distributions

The **TRandom** base class provides functions, which can be used by all the other derived classes for generating random variates according to predefined distributions. In the simplest cases, like in the case of the exponential distribution, the non-uniform random number is obtained by applying appropriate transformations. In the more complicated cases, random variates are obtained using acceptance-rejection methods, which require several random numbers.

```
TRandom3 r;
// generate a gaussian distributed number with:
// mu=0, sigma=1 (default values)
double x1 = r.Gaus();
double x2 = r.Gaus(10,3); // use mu = 10, sigma = 3;
```

The following table shows the various distributions that can be generated using methods of the **TRandom** classes. More information is available in the reference documentation for **TRandom**. In addition, random numbers distributed according to a user defined function, in a limited interval, or to a user defined histogram, can be generated in a very efficient way using **TF1::GetRandom()** or **TH1::GetRandom()**.

---

Distributions	Description
<code>Double_t Uniform(Double_t x1,Double_t x2 )</code>	Uniform random numbers between $x_1, x_2$
<code>Double_t Gaus(Double_t mu,Double_t sigma )</code>	Gaussian random numbers. Default values: <code>mu=0, sigma=1</code>
<code>Double_t Exp(Double_t tau)</code>	Exponential random numbers with mean $\tau$ .
<code>Double_t Landau(Double_t mean,Double_t s igma)</code>	Landau distributed random numbers. Default values: <code>mean=0, sigma=1</code>
<code>Double_t BreitWigner(Double_t mean, Double_t gamma)</code>	Breit-Wigner distributed random numbers. Default values <code>mean=0, gamma=1</code>
<code>Int_t Poisson(Double_t mean)</code>	Poisson random numbers
<code>Double_t PoissonD(Double_t mean)</code>	
<code>Int_t Binomial(Int_t ntot,Double_t prob )</code>	Binomial Random numbers
<code>Circle(Double_t &amp;x,Double_t &amp;y,Double_t r)</code>	Generate a random 2D point $(x,y)$ in a circle of radius $r$
<code>Sphere(Double_t &amp;x,Double_t &amp;y, Double_t &amp;z,Double_t r)</code>	Generate a random 3D point $(x,y,z)$ in a sphere of radius $r$
<code>Rannor(Double_t &amp;a,Double_t &amp;b)</code>	Generate a pair of Gaussian random numbers with <code>mu=0</code> and <code>sigma=1</code>

---

### 13.2.8 UNURAN

An interface to a new package, UNU.RAN, (Universal Non Uniform Random number generator for generating non-uniform pseudo-random numbers) was introduced in ROOT v5.16.

UNU.RAN is an ANSI C library licensed under GPL. It contains universal (also called automatic or black-box) algorithms that can generate random numbers from large classes of continuous (in one or multi-dimensions), discrete distributions, empirical distributions (like histograms) and also from practically all standard distributions. An extensive online documentation is available at the UNU.RAN Web Site <http://statmath.wu-wien.ac.at/unuran/>

The ROOT class `TUnuran` is used to interface the UNURAN package. It can be used as following:

- With the UNU.RAN native, string API for pre-defined distributions (see UNU.RAN documentation for the allowed string values at <http://statistik.wu-wien.ac.at/unuran/doc/unuran.html>):

```
TUnuran unr;
// initialize unuran to generate normal random numbers using
// a "arou" method
unr.Init("normal()", "method=arou");
...
// sample distributions N times (generate N random numbers)
for (int i = 0; i<N; ++i)
    double x = unr.Sample();
```

- For continuous 1D distribution object via the class `TUnuranContDist` that can be created for example from a `TF1` function providing the pdf (probability density function) . The user can optionally provide additional information via `TUnuranContDist::SetDomain(min,max)` like the `domain()` for generating numbers in a restricted region.

```
// 1D case: create a distribution from two TF1 object
// pointers pdfFunc
TUnuranContDist dist( pdfFunc);
// initialize unuran passing the distribution and a string
// defining the method
```

```

unr.Init(dist, "method=hinv");
// sample distribution N times (generate N random numbers)
for (int i = 0; i < N; ++i)
    double x = unr.Sample();

```

- For multi-dimensional distribution via the class **TUnuranMultiContDist**, which can be created from a the multi-dimensional pdf.

```

// Multi- dimensional case from a TF1 (TF2 or TF3) objects
TUnuranMultiContDist dist( pdfFuncMulti);
// the recommended method for multi-dimensional function is "hitro"
unr.Init(dist,"method=hitro");
// sample distribution N times (generate N random numbers)
double x[NDIM];
for (int i = 0; i<N; ++i)
    unr.SampleMulti(x);

```

- For discrete distribution via the class **TUnuranDiscrDist**, which can be initialized from a **TF1** or from a vector of probabilities.

```

// Create distribution from a vector of probabilities
double pv[NSize] = {0.1,0.2,...};
TUnuranDiscrDist dist(pv,pv+NSize);
// the recommended method for discrete distribution is
unr.Init(dist, "method=dgt");
// sample N times (generate N random numbers)
for (int i = 0; i < N; ++i)
    int k = unr.SampleDiscr();

```

- For empirical distribution via the class **TUnuranEmpDist**. In this case one can generate random numbers from a set of un-bin or bin data. In the first case the parent distribution is estimated by UNU.RAN using a gaussian kernel smoothing algorithm. The **TUnuranEmpDist** distribution class can be created from a vector of data or from **TH1** (using the bins or from its buffer for un-binned data).

```

// Create distribution from a set of data
// vdata is an std::vector containing the data
TUnuranEmpDist dist(vdata.begin(),vdata.end());
unr.Init(dist);
// sample N times (generate N random numbers)
for (int i = 0; i<N; ++i)
    double x = unr.Sample();

```

- For some predefined distributions, like **Poisson** and **Binomial**, one can use directly a function in the **TUnuran** class. This is more convenient in passing distribution parameters than using directly the string interface.

```

TUnuran unr;
// Initialize unuran to generate normal random numbers from the
// Poisson distribution with parameter mu
unr.InitPoisson(mu);
...
// Sample distributions N times (generate N random numbers)
for (int i = 0; i<N; ++i)
    int k = unr.SampleDiscr();

```

Functionality is also provided via the C++ classes for using a different random number generator by passing a **TRandom** pointer when constructing the **TUnuran** class (by default the ROOT **gRandom** is passed to UNURAN).

### 13.2.9 Performances of Random Numbers

Here are the CPU times obtained using the four random classes on an `lxplus` machine with an Intel 64 bit architecture and compiled using `gcc 3.4`:

	<b>TRandom</b> (ns/call)	<b>TRandom1</b> (ns/call)	<b>TRandom2</b> (ns/call)	<b>TRandom3</b> (ns/call)
<code>Rndm()</code>	-	-	6	9
<code>Gaus()</code>	31	161	35	42
<code>Rannor()</code>	116	216	126	130
<code>Poisson(m=10)</code>	147	1161	162	239
<code>Poisson(m=10) UNURAN</code>	80	294	89	99

## 13.3 MathCore Library

**MathCore** provides a collection of functions and C++ classes for numerical computing. This library includes only the basic mathematical functions and algorithms and not all the functionality required by the physics community. A more advanced mathematical functionality is provided by the **MathMore** library. The current set included classes are:

- Basic special functions like the gamma, beta and error function.
- Mathematical functions used in statistics, such as the probability density functions and the cumulative distributions functions (lower and upper integral of the pdf's).
- **GenVector**: physics and geometry vectors for 3 and 4 dimensions with their transformations (rotations and boost).
- Generic (`ROOT::Math::IFunction`) and parametric (`ROOT::Math::IParamFunction`) function interfaces for one and multi dimensions.

A detailed description for all **MathCore** classes is available in the [online reference documentation](#). The **MathCore** library presented in the ROOT distribution contains the CINT dictionary for I/O and interactive usage. For the template classes, the dictionary is provided for some of the possible types, such as those based on double and `Double32_t`. For the I/O or interactive use of other types, the dictionary must be first generated. An example on how to generate the required dictionary is provided in the tutorial `mathcoreVectorFloatIO.C` (in `$ROOTSYS/tutorials/math`). **MathCore** can also be built as an independent package using `configure/make`. In this case the library will not contain the dictionary information and cannot be used interactively in ROOT.

## 13.4 Generic Vectors for 2, 3 and 4 Dimensions (**GenVector**)

**GenVector** is a package intended to represent vectors and their operations and transformations, such as rotations and Lorentz transformations, in 3 and 4 dimensions. The 3D space is used to describe the geometry vectors and points, while the 4D space-time is used for physics vectors representing relativistic particles. These 3D and 4D vectors are different from vectors of the linear algebra package, which describe generic N-dimensional vectors. Similar functionality is currently provided by the CLHEP and packages and the ROOT Physics vector classes (See “Physics Vectors”). It also re-uses concepts and ideas from the CMS [Common Vector package](#). In contrast to CLHEP or the ROOT physics libraries, **GenVector** provides class templates for modeling the vectors. The user can control how the vector is internally represented. This is expressed by a choice of coordinate system, which is supplied as a template parameter when the vector is constructed. Furthermore, each coordinate system is itself a template, so that the user can specify the underlying scalar type.

The **GenVector** classes do not inherit from **TObject**, therefore cannot be used as in the case of the physics vector classes in ROOT collections.

In addition, to optimize performances, no virtual destructors are provided. In the following paragraphs, the main characteristics of **GenVector** are described. A more detailed description of all the **GenVector** classes is available also at <http://seal.cern.ch/documents/mathlib/GenVector.pdf>

## 13.4.1 Main Characteristics

### 13.4.1.1 Optimal Runtime Performances

We try to minimize any overhead in the run-time performance. We have deliberately avoided the use of any virtual function and even virtual destructors in the classes. In addition, as much as possible functions are defined as inline. For this reason, we have chosen to use template classes to implement the `GenVector` concepts instead of abstract or base classes and virtual functions. It is then recommended to avoid using the `GenVector` classes polymorphically and developing classes inheriting from them.

### 13.4.1.2 Points and Vector Concept

Mathematically vectors and points are two distinct concepts. They have different transformations, as vectors only rotate while points rotate and translate. You can add two vectors but not two points and the difference between two points is a vector. We then distinguish for the 3 dimensional case, between points and vectors, modeling them with different classes:

- `ROOT::Math::DisplacementVector2D` and `ROOT::Math::DisplacementVector3D` template classes describing 2 and 3 component direction and magnitude vectors, not rooted at any particular point;
- `ROOT::Math::PositionVector2D` and `ROOT::Math::PositionVector3D` template classes modeling the points in 2 and 3 dimensions.

For the 4D space-time vectors, we use the same class to model them, `ROOT::Math::LorentzVector`, since we have recognized a limited need for modeling the functionality of a 4D point.

### 13.4.1.3 Generic Coordinate System

The vector classes are based on a generic type of coordinate system, expressed as a template parameter of the class. Various classes exist to describe the various coordinates systems:

2D coordinate system classes:

- `ROOT::Math::Cartesian2D`, based on  $(x,y)$ ;
- `ROOT::Math::Polar2D`, based on  $(r,phi)$ ;

3D coordinate system classes:

- `ROOT::Math::Cartesian3D`, based on  $(x,y,z)$ ;
- `ROOT::Math::Polar3D`, based on  $(r,theta,phi)$ ;
- `ROOT::Math::Cylindrical3D`, based on  $(rho,z,phi)$
- `ROOT::Math::CylindricalEta3D`, based on  $(rho,eta,phi)$ , where `eta` is the pseudo-rapidity;

4D coordinate system classes:

- `ROOT::Math::PxPyPzE4D`, based on based on  $(px,py,pz,E)$ ;
- `ROOT::Math::PxPyPzM4D`, based on based on  $(px,py,pz,M)$ ;
- `ROOT::Math::PtEtaPhiE4D`, based on based on  $(pt,eta,phi,E)$ ;
- `ROOT::Math::PtEtaPhiM4D`, based on based on  $(pt,eta,phi,M)$ ;

Users can define the vectors according to the coordinate type, which is the most efficient for their use. Transformations between the various coordinate systems are available through copy constructors or the assignment (`=`) operator. For maximum flexibility and minimize memory allocation, the coordinate system classes are templated on the scalar type. To avoid exposing templated parameter to the users, typedefs are defined for all types of vectors based on doubles. See in the examples for all the possible types of vector classes, which can be constructed by users with the available coordinate system types.

#### 13.4.1.4 Coordinate System Tag

The 2D and 3D points and vector classes can be associated to a tag defining the coordinate system. This can be used to distinguish between vectors of different coordinate systems like global or local vectors. The coordinate system tag is a template parameter of the `ROOT::Math::DisplacementVector3D` and `ROOT::Math::PositionVector3D` (and also for 2D classes). A default tag exists for users who do not need this functionality, `ROOT::Math::DefaultCoordinateSystemTag`.

#### 13.4.1.5 Transformations

The transformations are modeled using simple (non-template) classes, using double as the scalar type to avoid too large numerical errors. The transformations are grouped in rotations (in 3 dimensions), Lorentz transformations and Poincare transformations, which are translation/rotation combinations. Each group has several members which may model physically equivalent transformations but with different internal representations. Transformation classes can operate on all type of vectors by using the operator `()` or the operator `*` and the transformations can be combined via the operator `*`. The available transformations are:

- 3D rotation classes
- rotation described by a 3x3 matrix (`ROOT::Math::Rotation3D`)
- rotation described by Euler angles (`ROOT::Math::EulerAngles`)
- rotation described by a direction axis and an angle (`ROOT::Math::AxisAngle`)
- rotation described by a quaternion (`ROOT::Math::Quaternion`)
- optimized rotation around x (`ROOT::Math::RotationX`), y (`ROOT::Math::RotationY`) and z (`ROOT::Math::RotationZ`) and described by just one angle.
- 3D transformation: we describe the transformations defined as a composition between a rotation and a translation using the class `ROOT::Math::Transform3D`. It is important to note that transformations act differently on vectors and points. The vectors only rotate, therefore when applying a transformation (rotation + translation) on a vector, only the rotation operates while the translation has no effect. The `Transform3D` class interface is similar to the one used in the CLHEP Geometry package (class).
- Lorentz rotation:
  - generic Lorentz rotation described by a 4x4 matrix containing a 3D rotation part and a boost part (class `ROOT::Math::LorentzRotation`)
  - a pure boost in an arbitrary direction and described by a 4x4 symmetric matrix or 10 numbers (class `ROOT::Math::Boost`)
  - boost along the axis: x(`ROOT::Math::BoostX`), y(`ROOT::Math::BoostY`) and z(`ROOT::Math::BoostZ`).

#### 13.4.1.6 Minimal Vector Classes Interface

We have tried to keep the interface to a minimal level by:

- Avoiding methods that provide the same functionality but use different names (like `getX()` and `x()`).
- Minimizing the number of setter methods, avoiding methods, which can be ambiguous and can set the vector classes in an inconsistent state. We provide only methods which set all the coordinates at the same time or set only the coordinates on which the vector is based, for example `SetX()` for a Cartesian vector. We then enforce the use of transformations as rotations or translations (additions) for modifying the vector contents.
- The majority of the functionality, which is present in the CLHEP package, involving operations on two vectors, is moved in separated helper functions (see `ROOT::Math::VectorUtil`). This has the advantage that the basic interface will remain more stable with time while additional functions can be added easily.



### 13.4.1.7 Naming Convention

As part of ROOT, the `GenVector` package adheres to the prescribed ROOT naming convention, with some (approved) exceptions, as described here:

- Every class and function is in the `ROOT::Math` namespace.
- Member function names start with upper-case letter, apart some exceptions (see the next section about CLHEP compatibility).

### 13.4.1.8 Compatibility with CLHEP Vector Classes

- For backward compatibility with CLHEP the vector classes can be constructed from a CLHEP `HepVector` or `HepLorentzVector`, by using a template constructor, which requires only that the classes implement the accessors `x()`, `y()`, and `z()` (and `t()` for the 4D).
- We provide vector member function with the same naming convention as CLHEP for the most used functions like `x()`, `y()` and `z()`.

### 13.4.1.9 Connection to Linear Algebra Package

In some use cases, like in track reconstruction, it is needed to use the content of the vector and rotation classes in conjunction with linear algebra operations. We prefer to avoid any direct dependency to any linear algebra package. However, we provide some hooks to convert to and from linear algebra classes. The vector and the transformation classes have methods which allow to get and set their data members (like `SetCoordinates` and `GetCoordinates`) passing either a generic iterator or a pointer to a contiguous set of data, like a C array. This allows an easy connection with the linear algebra package, which in turn, allows creation of matrices using C arrays (like the ROOT `TMatrix` classes) or iterators (`SMatrix` classes). Multiplication between linear algebra matrices and `GenVector` vectors is possible by using the template free functions `ROOT::Math::VectorUtil::Mult`. This function works for any linear algebra matrix, which implements the operator `(i,j)` and with first matrix element at `i=j=0`.

## 13.4.2 Example: 3D Vector Classes

To avoid exposing template parameter to the users, typedef's are defined for all types of vectors based on double's and float's. To use them, one must include the header file `Math/Vector3D.h`. The following typedef's, defined in the header file `Math/Vector3Dfwd.h`, are available for the different instantiations of the template class `ROOT::Math::DisplacementVector3D`:

- `ROOT::Math::XYZVector` vector based on `x,y,z` coordinates (Cartesian) in double precision
- `ROOT::Math::XYZVectorF` vector based on `x,y,z` coordinates (Cartesian) in float precision
- `ROOT::Math::Polar3DVector` vector based on `r,theta,phi` coordinates (polar) in double precision
- `ROOT::Math::Polar3DVectorF` vector based on `r,theta,phi` coordinates (polar) in float precision
- `ROOT::Math::RhoZPhiVector` vector based on `rho,z,phi` coordinates (cylindrical) in double precision
- `ROOT::Math::RhoZPhiVectorF` vector based on `rho,z,phi` coordinates (cylindrical) in float precision
- `ROOT::Math::RhoEtaPhiVector` vector based on `rho,eta,phi` coordinates (cylindrical using `eta` instead of `z`) in double precision
- `ROOT::Math::RhoEtaPhiVectorF` vector based on `rho,eta,phi` coordinates (cylindrical using `eta` instead of `z`) in float precision

### 13.4.2.1 Constructors and Assignment

The following declarations are available:

```
XYZVector      v1;           //an empty vector (x=0, y=0, z=0)
XYZVector      v2(1,2,3);    //vector with x=1, y=2, z=3;
Polar3DVector   v3(1,PI/2,PI); //vector with r=1, theta=PI/2, phi=PI
RhoEtaPhiVector v4(1,2, PI); //vector with rho=1, eta=2, phi=PI
```

Note that each vector type is constructed by passing its coordinate representation, so a `XYZVector(1,2,3)` is different from a `Polar3DVector(1,2,3)`. In addition, the vector classes can be constructed by any vector, which implements the accessors `x()`, `y()` and `z()`. This can be another 3D vector based on a different coordinate system type. It can be even any vector of a different package, like the CLHEP `HepThreeVector` that implements the required signature.

```
XYZVector      v1(1,2,3);
RhoEtaPhiVector r2(v1);
CLHEP::HepThreeVector q(1,2,3);
XYZVector      v3(q);
```

### 13.4.2.2 Coordinate Accessors

All coordinate accessors are available through the class `ROOT::Math::DisplacementVector3D`:

```
//returns cartesian components for the cartesian vector v1
v1.X(); v1.Y(); v1.Z();
//returns cylindrical components for the cartesian vector v1
v1.Rho(); v1.Eta(); v1.Phi();
//returns cartesian components for the cylindrical vector r2
r2.X(); r2.Y(); r2.Z()
```

In addition, all the 3 coordinates of the vector can be retrieved with the `GetCoordinates` method:

```
double d[3];
//fill d array with (x,y,z) components of v1
v1.GetCoordinates(d);
//fill d array with (r,eta,phi) components of r2
r2.GetCoordinates(d);
std::vector vc(3);
//fills std::vector with (x,y,z) components of v1
v1.GetCoordinates(vc.begin(),vc.end());
```

See the reference documentation of `ROOT::Math::DisplacementVector3D` for more details on all the coordinate accessors.

### 13.4.2.3 Setter Methods

One can set only all the three coordinates via:

```
v1.SetCoordinates(c1,c2,c3); // (x,y,z) for a XYZVector
r2.SetCoordinates(c1,c2,c3); // r,theta,phi for a Polar3DVector
r2.SetXYZ(x,y,z); // 3 cartesian components for Polar3DVector
```

Single coordinate setter methods are available for the basic vector coordinates, like `SetX()` for a `XYZVector` or `SetR()` for a polar vector. Attempting to do a `SetX()` on a polar vector will not compile.

```

XYZVector v1;
v1.SetX(1);    //OK setting x for a Cartesian vector
Polar3DVector v2;
v2.SetX(1);    //ERROR: cannot set X for a Polar vector.
//Method will not compile
v2.SetR(1);    //OK setting r for a Polar vector

```

In addition, there are setter methods from C arrays or iterator

```

double d[3] = {1.,2.,3.};
XYZVector v;
// set (x,y,z) components of v using values from d
v.SetCoordinates(d);

```

or, for example, from an `std::vector` using the iterator

```

std::vector w(3);
// set (x,y,z) components of v using values from w
v.SetCoordinates(w.begin(),w.end());

```

#### 13.4.2.4 Arithmetic Operations

The following operations are possible between vector classes, even of different coordinate system types: ( $v_1, v_2$  are any type of `ROOT::Math::DisplacementVector3D` classes,  $v_3$  is the same type of  $v_1$ ;  $a$  is a scalar value)

```

v1 += v2;
v1 -= v2;
v1 = - v2;
v1 *= a;
v1 /= a;
v2 = a * v1;
v2 = v1 / a;
v2 = v1 * a;
v3 = v1 + v2;
v3 = v1 - v2;

```

#### 13.4.2.5 Comparison

For  $v_1$  and  $v_2$  of the same type (same coordinate system and same scalar type):

```

v1 == v2;
v1 != v2;

```

#### 13.4.2.6 Dot and Cross Product

We support the dot and cross products, through the `Dot()` and `Cross()` method, with any vector ( $q$ ) implementing `x()`, `y()` and `z()`.

```

XYZVector v1(x,y,z);
double s = v1.Dot(q);
XYZVector v2 = v1.Cross(q);

```

Note that the multiplication between two vectors using the operator `*` is not supported because it is ambiguous.

### 13.4.2.7 Other Methods

```
XYZVector u = v1.Unit(); //return unit vector parallel to v1
```

### 13.4.3 Example: 3D Point Classes

To use all possible types of 3D points one must include the header file `Math/Point3D.h`. The following typedef's defined in the header file `Math/Point3Dfwd.h`, are available for different instantiations of the template class `ROOT::Math::PositionVector3D`:

- `ROOT::Math::XYZPoint` point based on `x`, `y`, `z` coordinates (Cartesian) in double precision
- `ROOT::Math::XYZPointF` point based on `x`, `y`, `z` coordinates (Cartesian) in float precision
- `ROOT::Math::Polar3DPoint` point based on `r`, `theta`, `phi` coordinates (polar) in double precision
- `ROOT::Math::Polar3DPointF` point based on `r`, `theta`, `phi` coordinates (polar) in float precision
- `ROOT::Math::RhoZPhiPoint` point based on `rho`, `z`, `phi` coordinates (cylindrical using `z`) in double precision
- `ROOT::Math::RhoZPhiPointF` point based on `rho`, `z`, `phi` coordinates (cylindrical using `z`) in float precision
- `ROOT::Math::RhoEtaPhiPoint` point based on `rho`, `eta`, `phi` coordinates (cylindrical using `eta` instead of `z`) in double precision
- `ROOT::Math::RhoEtaPhiPointF` point based on `rho`, `eta`, `phi` coordinates (cylindrical using `eta` instead of `z`) in float precision

#### 13.4.3.1 Constructors and Assignment

The following declarations are available:

```
XYZPoint      p1;           //an empty vector (x=0, y=0, z=0)
XYZPoint      p2(1,2,3);   //
```

Note that each point type is constructed by passing its coordinate representation, so a `XYZPoint(1,2,3)` is different from a `Polar3DPoint(1,2,3)`. In addition the point classes can be constructed by any vector, which implements the accessors `x()`, `y()` and `z()`. This can be another 3D point based on a different coordinate system type or even any vector of a different package, like the CLHEP `HepThreePoint` that implements the required signatures.

```
XYZPoint      p1(1,2,3);
RhoEtaPhiPoint r2(v1);
CLHEP::HepThreePoint q(1,2,3);
XYZPoint      p3(q);
```

#### 13.4.3.2 Coordinate Accessors and Setter Methods

For the points classes we have the same getter and setter methods as for the vector classes. See “Example: 3D Vector Classes”.

#### 13.4.3.3 Point-Vector Operations

The following operations are possible between points and vector classes: (`p1`, `p2` and `p3` are instantiations of the `ROOT::Math::PositionVector3D` objects with `p1` and `p3` of the same type; `v1` and `v2` are `ROOT::Math::DisplacementVector3D` objects).

```

p1 += v1;
p1 -= v1;
p3 = p1 + v1;    // p1 and p3 are the same type
p3 = v1 + p1;    // p3 is based on the same coordinate system as v1
p3 = p1 - v1;
p3 = v1 - p1;
v2 = p1 - p2;    // difference between points returns a vector v2
                  // based on the same coordinate system as p1

```

Note that the addition between two points is **NOT** possible and the difference between points returns a vector.

#### 13.4.3.4 Other Operations

Exactly as for the 3D Vectors, the following operations are allowed:

- comparison of points
- scaling and division of points with a scalar
- dot and cross product with any type of vector

#### 13.4.4 Example: LorentzVector Classes

As in the 3D case, typedef's are defined for user convenience. and can be used by including the header file `Math/Vector4D.h`. The following typedef's, defined in the header file `Math/Vector4Dfwd.h`, are available for the different instantiations of the template class `ROOT::Math::LorentzVector`:

- `ROOT::Math::XYZTVector` vector based on `x`, `y`, `z`, `t` coordinates (Cartesian) in double precision
- `ROOT::Math::XYZTVectorF` vector based on `x`, `y`, `z`, `t` coordinates (Cartesian) in float precision
- `ROOT::Math::PtEtaPhiEVector` vector based on `pt(rho)`, `eta`, `phi` and `E(t)` coordinates in double precision
- `ROOT::Math::PtEtaPhiMVector` vector based on `pt(rho)`, `eta`, `phi` and `M(t)` coordinates in double precision
- `ROOT::Math::PxPyPzMVector` vector based on `px`, `py`, `pz` and `M(mass)` coordinates in double precision

The metric used for all the LorentzVector is  $(-, -, -, +)$ .

##### 13.4.4.1 Constructors and Assignment

The following declarations are available:

```

// create an empty vector (x=0, y=0, z=0, t=0)
XYZTVector    v1;
// vector with x=1, y=2, z=3, t=4
XYZTVector    v2(1,2,3,4);
// vector with pt=1, eta=2, phi=PI, E=5
PtEtaPhiEVector v3(1,2,PI,5);

```

Note that each type of vector is constructed by passing its coordinate representation, so a `XYZTVector(1,2,3,4)` is different from a `PtEtaPhiEVector(1,2,3,4)`. In addition, the Vector classes can be constructed by any vector, which implements the accessors `x()`, `y()`, `z()` and `t()`.

This can be another `ROOT::Math::LorentzVector` based on a different coordinate system or any vector of a different package, like the CLHEP `HepLorentzVector` that implements the required signature.

```

XYZTVector    v1(1,2,3,4);
PtEtaPhiEVector v2(v1);
CLHEP::HepLorentzVector q(1,2,3,4);
XYZTVector    v3(q);

```

### 13.4.4.2 Coordinate Accessors

All the same coordinate accessors are available through the interface of `ROOT::Math::LorentzVector`. For example:

```
//returns cartesian components for the cartesian vector v1
v1.X(); v1.Y(); v1.Z(); v1.T();
//returns cartesian components for the cylindrical vector v2
v2.Px(); v2.Py(); v2.Pz(); v2.E();
//returns other components for the cartesian vector v1
v1.Pt(); v1.Eta(); v1.Phi(); v1.M()
```

In addition, all 4 vector coordinates can be retrieved with the `GetCoordinates` method:

```
double d[4];
//fill d array with (x,y,z,t) components of v1
v1.GetCoordinates(d);
//fill d array with (pt,eta,phi,e) components of v2
v2.GetCoordinates(d);
std::vector w(4);
//fill std::vector with (x,y,z,t)
v1.GetCoordinates(w.begin(),w.end());
//components of v1
```

To get information on all the coordinate accessors see the `ROOT::Math::LorentzVector` reference documentation.

### 13.4.4.3 Setter Methods

One can set only all the three coordinates via:

```
//sets the (x,y,z,t) for a XYZTVector
v1.SetCoordinates(c1,c2,c3,c4);
//sets pt,eta,phi,e for a PtEtaPhiEVector
v2.SetCoordinates(c1,c2,c3,c4);
//sets cartesian components for PtEtaPhiEVector
v2.SetXYZ(x,y,z,t);
```

Single coordinate setter methods are available for the basic vector coordinates, like `SetX()` for a `XYZTVector` or `SetPt()` for a `PtEtaPhiEVector`. Attempting to do a `SetX()` on a non-Cartesian vector will not compile.

```
XYZTVector v1;
v1.SetX(1); //OK setting x for a cartesian vector
PtEtaPhiEVector v2;
v2.SetX(1); //ERROR: cannot set X for a non-cartesian
//vector. Method will not compile.
v2.SetR(1) // OK setting Pt for a PtEtaPhiEVector vector
```

In addition, there are setter methods from C arrays or iterators.

```
double d[4] = {1.,2.,3.,4.};
XYZTVector v;
//set (x,y,z,t) components of v using values from d
v.SetCoordinates(d);
```

or for example from an `std::vector` using the iterators

```
std::vector w(4);
//set (x,y,z,t) components of v using values from w
v.SetCoordinates(w.begin(),w.end());
```

#### 13.4.4.4 Arithmetic Operations

The following operations are possible between Lorentz vectors classes, even of different coordinate system types: ( $v$  and  $w$  are two Lorentz vector of the same type,  $q$  is a generic Lorentz vector implementing  $x()$ ,  $y()$ ,  $z()$  and  $t()$ , and  $a$  is a generic scalar type: double, float, int, etc.) .

```
v += q;
v -= q;
v = -q;
v *= a;
v /= a;
w = v + q;
w = v - q;
w = v * a;
w = a * v;
w = v / a;
```

#### 13.4.4.5 Comparison

```
v == w;
v != w;
```

#### 13.4.4.6 Other Methods

```
a = v.Dot(q); //dot product in metric(+,+,+,-) of 2 LorentzVectors
XYZVector s = v.Vect() //return the spatial components (x,y,z)
v.Beta(); //return beta and gamma value (vector must
v.Gamma() // be time-like otherwise result is meaningless)
XYZVector b = v.BoostToCM(); //return boost vector which will bring
//the Vector in its mas frame (P=0)
```

### 13.4.5 Example: Vector Transformations

Transformation classes are grouped in rotations (in three dimensions), Lorentz transformations and Poincarre transformations, which are translation/rotation combinations. Each group has several members which may model physically equivalent transformations but with different internal representations. All the classes are non-template and use double precision as the scalar type. The following types of transformation classes are defined:

3D rotations:

- `ROOT::Math::Rotation3D`, rotation described by a 3x3 matrix of doubles
- `ROOT::Math::EulerAngles` rotation described by the three Euler angles (`phi`, `theta` and `psi`) following the [Goldstein definition](#).
- `ROOT::Math::RotationZYX` rotation described by three angles defining a rotation first along the Z axis, then along the rotated Y' axis and then along the rotated X" axis.
- `ROOT::Math::AxisAngle`, rotation described by a vector (axis) and an angle
- `ROOT::Math::Quaternion`, rotation described by a quaternion (4 numbers)
- `ROOT::Math::RotationX`, specialized rotation along the X axis
- `ROOT::Math::RotationY`, specialized rotation along the Y axis
- `ROOT::Math::RotationZ`, specialized rotation along the Z axis

3D transformations (rotations + translations)

- `ROOT::Math::Transform3D`, (rotations and then translation) described by a 3x4 matrix (12 double numbers)
- `ROOT::Math::Translation3D` (only translation) described by a 3D Vector

Lorentz rotations and boosts

- `ROOT::Math::LorentzRotation`, 4D rotation (3D rotation plus a boost) described by a 4x4 matrix
- `ROOT::Math::Boost`, a Lorentz boost in an arbitrary direction and described by a 4x4 symmetric matrix (10 numbers)
- `ROOT::Math::BoostX`, a boost in the X axis direction
- `ROOT::Math::BoostY`, a boost in the Y axis direction
- `ROOT::Math::BoostZ`, a boost in the Z axis direction

### 13.4.5.1 Constructors

All rotations and transformations are default constructible (giving the identity transformation). All rotations are constructible taking a number of scalar arguments matching the number (and order of components).

```
Rotation3D  rI;           //a summy rotation (Identity matrix)
RotationX   rX(PI);      //a RotationX with an angle PI
EulerAngles rE(phi,theta,psi); //an Euler rotation with phi,
                          //theta,psi angles

XYZVector   u(ux,uy,uz);
AxisAngle    rA(u,delta); //a rotation based on direction u,
                          //angle delta
```

In addition, all rotations and transformations (other than the axial rotations) and transformations are constructible from `(begin,end)` iterators or from pointers behave like iterators.

```
double      data[9];
//create a rotation from a rotation matrix
Rotation3D  r(data,data+9);
std::vector w(12);
//create Transform3D from std::vector content
Transform3D t(w.begin(),w.end());
```

All rotations, except the axial rotations, are constructible and assigned from any other type of rotation (including the axial):

```
//create a rotation 3D from a rotation along X axis of angle PI
Rotation3D  r(ROOT::Math::RotationX(PI));

//construct an Euler rotation from A Rotation3D
EulerAngles r2(r);

//assign an Axis rotation from an Euler Rotation
AxisAngle   r3; r3 = r2;
```

`Transform3D` (rotation + translation) can be constructed from a rotation and a translation vector:

```
Rotation3D  r;
XYZVector   v;
Transform3D t1(r,v); //construct from rotation and then
                    //translation
Transform3D t2(v,r); //construct inverse from first translation
```



```

//then rotation
Transform3D t3(r); //construct from only a rotation
//zero translation
Transform3D t4(v); //construct from only translation
//identity rotation

```

### 13.4.5.2 Operations

All transformations can be applied to vector and points using the operator `*` or using the operator `()`

```

XYZVector v1(...);
Rotation3D r(...);
XYZVector v2 = r*v1; //rotate vector v1 using r
v2 = r(v1); //equivalent

```

Transformations can be combined using the operator `*`. Rotation, translation and **Transform3D** classes can be all combined with the operator `*`. The result of a combination of a rotation and a translation will be a **Transform3D** class. Note that the rotations are not commutative, the order is then important.

```

Rotation3D r1(...);
Rotation3D r2(...);
Rotation3D r3 = r2*r1; //a combine rotation r3 by
//applying first r1 then r2

```

We can combine rotations of different types, like **Rotation3D** with any other type of rotations. The product of two different axial rotations returns a **Rotation3D**:

```

RotationX rx(1.);
RotationY ry(2.);
Rotation3D r = ry * rx; //rotation along X and then Y axis

```

It is also possible to invert all the transformation or return their inverse:

```

Rotation3D r1(...);
r1.Invert(); //invert the rotation modifying its content
Rotation3D r2 =r1.Inverse(); //return the inverse in a new
//rotation class

```

We have used rotation as examples, but all these operations can be applied to all the transformation classes.

### 13.4.5.3 Set/GetComponents Methods

Common methods to all transformations are **Get** and **SetComponents**. They can be used to retrieve all the scalar values on which the transformation is based.

```

RotationX rx;
rx.SetComponents(1.); //set aple of the X rotation
double d[9] = {.....};
Rotation3D r;
r.SetComponents(d,d+9); //set 9 components of 3D rotation
double d[16];
LorentzRotation lr;
lr.GetComponents(d,d+16); //get 16 components of a LorentzRotation
TMatrixD(3,4) m;
Transform3D t;
t.GetComponens(m); //fill 3x4 matrix with components of t

```

The **GetComponents** and **SetComponents** methods can be used with a signature based iterators or by using any foreign matrix which implements the operator `(i,j)` or a different signatures depending on the transformation type. For more details on all methods see the reference documentation of any specific transformation class.

## 13.4.6 Example with External Packages

### 13.4.6.1 Connection to Linear Algebra Classes

It is possible to use the vector and rotation classes together with the linear algebra classes and to set and get the contents of any 3D or 4D vector from a linear algebra vector class which implements an iterator or something which behaves like an iterator. For example a pointer to a C array (double\*) behaves like an iterator. It is then assumed that the coordinates, like (x,y,z) will be stored contiguously.

```
TVectorD   r2(N); //ROOT Linear Algebra Vector containing
                //many vectors
XYZVector  v2;
//construct vector from x=r[INDEX], y=r[INDEX+1], z=r[INDEX+2]
v2.SetCoordinates(&r2[INDEX],&r2[index]+3);
```

To fill a linear algebra vector from a 3D or 4D vector, with `GetCoordinates()` one can get the internal coordinate data.

```
HepVector   c(3); //CLHEP Linear algebra vector
//fill HepVector c with c[0]=x, c[1]=y, c[2]=z
v2.GetCoordinates(&c[0],&c[index]+3)
```

or using `TVectorD`:

```
double   *data[3];
v2.GetCoordinates(data,data+3);
TVectorD  r1(3,data); //create a new Linear Algebra vector
                //copying the data
```

In the case of transformations, constructor and method to set/get components exist with linear algebra matrices. The requisite is that the matrix data are stored, for example in the case of a Lorentz rotation, from (0,0) thru (3,3)

```
TMatrixD(4,4)  m;
LorentzRotation r(m); //create Lorentz r
```

### 13.4.6.2 Connection to Other Vector Classes

The 3D and 4D vectors of the `GenVector` package can be constructed and assigned from any vector which satisfies the following requisites:

- for 3D vectors implementing the `x()`, `y()` and `z()` methods
- for Lorentz vectors implementing the `x()`, `y()`, `z()` and `t()` methods.

```
CLHEP::Hep3Vector hv;
XYZVector         v1(hv); //create 3D vector from
                          //CLHEP 3D Vector
HepGeom::Point3D  hp;
XYZPoint          p1(hp); //create a 3D p
```

## 13.5 MathMore Library

The `MathMore` library provides an advanced collection of functions and C++ classes for numerical computing. This is an extension of the functionality provided by the `MathCore` library. The current set includes:

- Special functions (see Special Functions in `MathMore`)

- Mathematical functions used in statistics such as probability density functions, cumulative distributions functions and their inverse.
- Numerical algorithms for one dimensional functions based on implementation of the GNU Scientific Library (GSL):
- Numerical integration using the class `ROOT::Math::Integrator` which is based on the Adaptive integration algorithms of QUADPACK
- Numerical differentiation via `ROOT::Math::Derivator`
- Root finder via `ROOT::Math::RootFinder` which uses different solver algorithms from GSL
- Minimization via `ROOT::Math::Minimizer1D`
- Interpolation via `ROOT::Math::Interpolation`. All the GSL interpolation types are supported
- Function approximation based on Chebyshev polynomials via the class `ROOT::Math::Chebyshev`
- Random number generators and distributions
- Polynomial evaluation and root solvers

The mathematical functions are implemented as a set of free functions in the namespace `ROOT::Math`. The naming used for the special functions is the same proposed for the C++ standard (see C++ standard extension [proposal document](#)). The `MathCore` library is implemented wrapping in C++ the GNU Scientific Library ( ). Building `MathMore` requires a version of GSL larger or equal 1.8. The source code of `MathMore` is distributed under the GNU General Public License.

`MathMore` (and its ROOT CINT dictionary) can be built within ROOT whenever a GSL library is found in the system. The GSL library and header file location can be specified in the ROOT configure script, by doing:

```
./configure --with-gsl-incl=... --with-gsl-libdir=...
```

`MathMore` can be built also a stand-alone library (without requiring ROOT) downloading the tar file from the Web at this link. In this case the library will not contain the dictionary information and therefore cannot be used interactively

More information on the classes and functions present in `MathMore` is available in the [online reference documentation](#).

## 13.6 Mathematical Functions

The mathematical functions are present in both `MathCore` and `MathMore` libraries. All mathematical functions are implemented as free functions in the namespace `ROOT::Math`. The most used functions are in the `MathCore` library while the others are in the `MathMore` library. The functions in `MathMore` are all using the implementation of the GNU Scientific Library (GSL). The naming of the special functions is the same defined in the C++ [Technical Report on Standard Library extensions](#). The special functions are defined in the header file `Math/SpecFunc.h`.

### 13.6.1 Special Functions in MathCore

- `ROOT::Math::beta(double x, double y)` - evaluates the beta function:

$$B(x, y) = \frac{\Gamma(x)\Gamma(y)}{\Gamma(x+y)}$$

- `double ROOT::Math::erf(double x)` - evaluates the error function encountered in integrating the normal distribution:

$$\operatorname{erf}(x) = \frac{2}{\sqrt{\pi}} \int_0^x e^{-t^2} dt$$

- `double ROOT::Math::erfc(double x)` - evaluates the complementary error function:

$$\operatorname{erfc}(x) = 1 - \operatorname{erf}(x) = \frac{2}{\sqrt{\pi}} \int_x^\infty e^{-t^2} dt$$

- `double ROOT::Math::tgamma(double x)` - calculates the gamma function:

$$\Gamma(x) = \int_0^\infty t^{x-1} e^{-t} dt$$

### 13.6.2 Special Functions in MathMore

- `double ROOT::Math::assoc_legendre(unsigned l,unsigned m,double x)` -computes the associated Legendre polynomials (with  $m \geq 0$ ,  $l \geq m$  and  $|x| < 1$ ):

$$P_l^m(x) = (1 - x^2)^{m/2} \frac{d^m}{dx^m} P_l(x)$$

- `double ROOT::Math::comp_ellint_1(double k)` - calculates the complete elliptic integral of the first kind (with  $0 \leq k^2 \leq 1$ ):

$$K(k) = F(k, \pi/2) = \int_0^{\pi/2} \frac{d\theta}{\sqrt{1 - k^2 \sin^2 \theta}}$$

- `double ROOT::Math::comp_ellint_2(double k)` - calculates the complete elliptic integral of the second kind (with  $0 \leq k^2 \leq 1$ ):

$$E(k) = E(k, \pi/2) = \int_0^{\pi/2} \sqrt{1 - k^2 \sin^2 \theta} d\theta$$

- `double ROOT::Math::comp_ellint_3(double n,double k)` - calculates the complete elliptic integral of the third kind (with  $0 \leq k^2 \leq 1$ ):

$$\Pi(n, k, \pi/2) = \int_0^{\pi/2} \frac{d\theta}{(1 - n \sin^2 \theta) \sqrt{1 - k^2 \sin^2 \theta}}$$

- `double ROOT::Math::conf_hyperg(double a,double b,double z)` - calculates the confluent hyper-geometric functions of the first kind:

$${}_1F_1(a; b; z) = \frac{\Gamma(b)}{\Gamma(a)} \sum_{n=0}^{\infty} \frac{\Gamma(a+n)}{\Gamma(b+n)} \frac{z^n}{n!}$$

- `double ROOT::Math::conf_hypergU(double a,double b,double z)` - calculates the confluent hyper-geometric functions of the second kind, known also as Kummer function of the second type. It is related to the confluent hyper-geometric function of the first kind:

$$U(a, b, z) = \frac{\pi}{\sin \pi b} \left[ \frac{{}_1F_1(a, b, z)}{\Gamma(a-b+1)} - \frac{z^{1-b} {}_1F_1(a-b+1, 2-b, z)}{\Gamma(a)} \right]$$

- `double ROOT::Math::cyl_bessel_i(double nu,double x)` - calculates the modified Bessel function of the first kind, also called regular modified (cylindrical) Bessel function:

$$I_\nu(x) = i^{-\nu} J_\nu(ix) = \sum_{k=0}^{\infty} \frac{(\frac{1}{2}x)^{\nu+2k}}{k! \Gamma(\nu+k+1)}$$

- `double ROOT::Math::cyl_bessel_j(double nu,double x)` - calculates the (cylindrical) Bessel function of the first kind, also called regular (cylindrical) Bessel function:

$$J_\nu(x) = \sum_{k=0}^{\infty} \frac{(-1)^k (\frac{1}{2}x)^{\nu+2k}}{k! \Gamma(\nu+k+1)}$$

- `double ROOT::Math::cyl_bessel_k(double nu,double x)` - calculates the modified Bessel function of the second kind, also called irregular modified (cylindrical) Bessel function for  $x > 0$ ,  $\nu > 0$ :

$$K_\nu(x) = \frac{\pi}{2} i^{\nu+1} (J_\nu(ix) + iN_\nu(ix)) = \begin{cases} \frac{\pi}{2} \frac{I_{-\nu}(x) - I_\nu(x)}{\sin \nu \pi} & \text{for non-integral } \nu \\ \frac{\pi}{2} \lim_{\mu \rightarrow \nu} \frac{I_{-\mu}(x) - I_\mu(x)}{\sin \mu \pi} & \text{for integral } \nu \end{cases}$$

- `double ROOT::Math::cyl_neumann(double nu,double x)` - calculates the (cylindrical) Bessel function of the second kind, also called irregular (cylindrical) Bessel function or (cylindrical) Neumann function:

$$N_\nu(x) = Y_\nu(x) = \begin{cases} \frac{J_\nu \cos \nu \pi - J_{-\nu}(x)}{\sin \nu \pi} & \text{for non-integral } \nu \\ \lim_{\mu \rightarrow \nu} \frac{J_\mu \cos \mu \pi - J_{-\mu}(x)}{\sin \mu \pi} & \text{for integral } \nu \end{cases}$$

- `double ROOT::Math::ellint_1(double k,double phi)` - calculates incomplete elliptic integral of the first kind (with  $0 \leq k^2 \leq 1$ ):

$$K(k) = F(k, \pi/2) = \int_0^{\pi/2} \frac{d\theta}{\sqrt{1 - k^2 \sin^2 \theta}}$$

- `double ROOT::Math::ellint_2(double k,double phi)` - calculates the complete elliptic integral of the second kind (with  $0 \leq k^2 \leq 1$ ):

$$E(k) = E(k, \pi/2) = \int_0^{\pi/2} \sqrt{1 - k^2 \sin^2 \theta} d\theta$$

- `double ROOT::Math::ellint_3(double n,double k,double phi)` - calculates the complete elliptic integral of the third kind (with  $0 \leq k^2 \leq 1$ ):

$$\Pi(n, k, \pi/2) = \int_0^{\pi/2} \frac{d\theta}{(1 - n \sin^2 \theta) \sqrt{1 - k^2 \sin^2 \theta}}$$

- `double ROOT::Math::expint(double x)` - calculates the exponential integral:

$$Ei(x) = - \int_{-x}^{\infty} \frac{e^{-t}}{t} dt$$

- `double ROOT::Math::hyperg(double a,double b,double c,double x)` - calculates Gauss' hyper-geometric function:

$${}_2F_1(a, b; c; x) = \frac{\Gamma(c)}{\Gamma(a)\Gamma(b)} \sum_{n=0}^{\infty} \frac{\Gamma(a+n)\Gamma(b+n)}{\Gamma(c+n)} \frac{x^n}{n!}$$

- `double ROOT::Math::legendre(unsigned l,double x)` - calculates the Legendre polynomials for  $l \geq 0$ ,  $|x| \leq 1$  in the Rodrigues representation:

$$P_l(x) = \frac{1}{2^l l!} \frac{d^l}{dx^l} (x^2 - 1)^l$$

- `double ROOT::Math::riemann_zeta(double x)` - calculates the Riemann zeta function:

$$\zeta(x) = \begin{cases} \sum_{k=1}^{\infty} k^{-x} & \text{for } x > 1 \\ 2^x \pi^{x-1} \sin\left(\frac{1}{2}\pi x\right) \Gamma(1-x) \zeta(1-x) & \text{for } x < 1 \end{cases}$$

- `double ROOT::Math::sph_bessel(unsigned n,double x)` - calculates the spherical Bessel functions of the first kind (also called regular spherical Bessel functions):

$$j_n(x) = \sqrt{\frac{\pi}{2x}} J_{n+1/2}(x)$$

- `double ROOT::Math::sph_neumann(unsigned n,double x)` - calculates the spherical Bessel functions of the second kind (also called irregular spherical Bessel functions or spherical Neumann functions):

$$n_n(x) = y_n(x) = \sqrt{\frac{\pi}{2x}} N_{n+1/2}(x)$$

### 13.6.3 Probability Density Functions (PDF)

Probability density functions of various distributions. All the functions, apart from the discrete ones, have the extra location parameter `x0`, which by default is zero. For example, in the case of a gaussian pdf, `x0` is the mean, `mu`, of the distribution. All the probability density functions are defined in the header file `Math/DistFunc.h` and are part of the `MathCore` libraries. The definition of these functions is documented in the [reference doc for statistical functions](#):

```
double ROOT::Math::beta_pdf(double x,double a, double b);
double ROOT::Math::binomial_pdf(unsigned int k,double p,unsigned int n);
double ROOT::Math::breitwigner_pdf(double x,double gamma,double x0=0);
double ROOT::Math::cauchy_pdf(double x,double b=1,double x0=0);
```

```

double ROOT::Math::chisquared_pdf(double x,double r,double x0=0);
double ROOT::Math::exponential_pdf(double x,double lambda,double x0=0);
double ROOT::Math::fdistribution_pdf(double x,double n,double m,double x0=0);
double ROOT::Math::gamma_pdf(double x,double alpha,double theta,double x0=0);
double ROOT::Math::gaussian_pdf(double x,double sigma,double x0=0);
double ROOT::Math::landau_pdf(double x,double s,double x0=0);
double ROOT::Math::lognormal_pdf(double x,double m,double s,double x0=0);
double ROOT::Math::normal_pdf(double x,double sigma,double x0=0);
double ROOT::Math::poisson_pdf(unsigned int n,double mu);
double ROOT::Math::tdistribution_pdf(double x,double r,double x0=0);
double ROOT::Math::uniform_pdf(double x,double a,double b,double x0=0);

```

### 13.6.4 Cumulative Distribution Functions (CDF)

For all the probability density functions, we have the corresponding cumulative distribution functions and their complements. The functions with extension `_cdf` calculate the lower tail integral of the probability density function:

$$D(x) = \int_{-\infty}^x p(x') dx'$$

while those with the `cdf_c` extension calculate the upper tail of the probability density function, so-called in statistics the survival function. For example, the function:

```
double ROOT::Math::gaussian_cdf(double x,double sigma,double x0=0);
```

evaluates the lower tail of the Gaussian distribution:

$$D(x) = \int_{-\infty}^x \frac{1}{\sqrt{2\pi\sigma^2}} e^{-(x'-x_0)^2/2\sigma^2} dx'$$

while the function:

```
double ROOT::Math::gaussian_cdf_c(double x, double sigma, double x0=0);
```

evaluates the upper tail of the Gaussian distribution:

$$D(x) = \int_x^{+\infty} \frac{1}{\sqrt{2\pi\sigma^2}} e^{-(x'-x_0)^2/2\sigma^2} dx'$$

The cumulative distributions functions are defined in the header file `Math/ProbFunc.h`. The majority of the CDF's are present in the `MathCore`, apart from the `chisquared`, `fdistribution`, `gamma` and `tdistribution`, which are in the `MathMore` library.

#### 13.6.4.1 Inverse of the Cumulative Distribution Functions(Quantiles)

For almost all the cumulative distribution functions (`_cdf`) and their complements (`_cdf_c`) present in the library, we provide the inverse functions. The inverse of the cumulative distribution function is called in statistics quantile function. The functions with the extension `_quantile` calculate the inverse of the cumulative distribution function (lower tail integral of the probability density function), while those with the `quantile_c` extension calculate the inverse of the complement of the cumulative distribution (upper tail integral). All the inverse distributions are in the `MathMore` library and are defined in the header file `Math/ProbFuncInv.h`.

The following picture illustrates the available statistical functions (PDF, CDF and quantiles) in the case of the normal distribution.

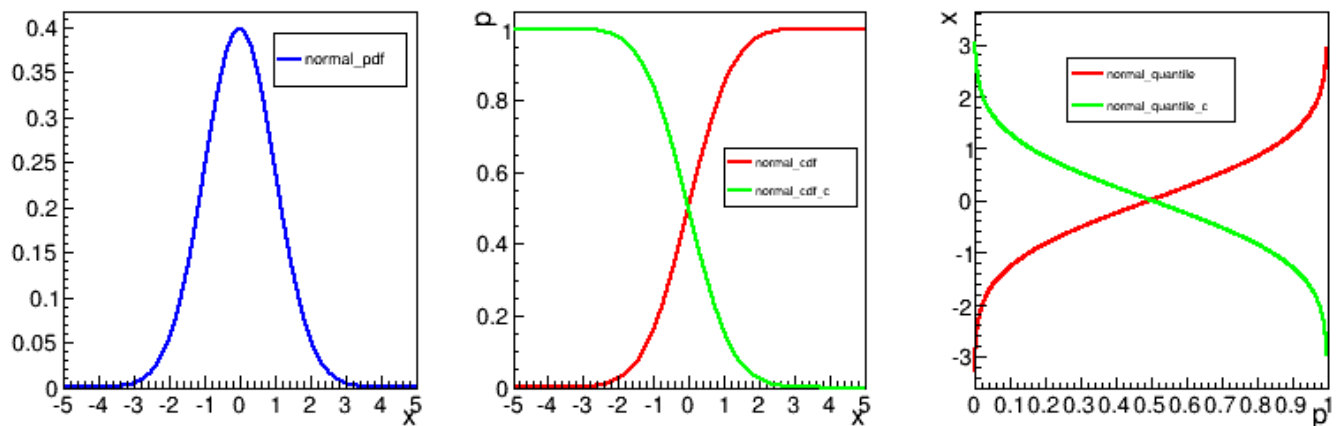

Figure 13.2: PDF, CDF and quantiles in the case of the normal distribution

## 13.7 Linear Algebra: SMatrix Package

The ROOT Linear algebra package is documented in a separate chapter (see “Linear Algebra in ROOT”). **SMatrix** is a C++ package, for high performance vector and matrix computations. It has been introduced in ROOT v5.08. It is optimized for describing small matrices and vectors and It can be used only in problems when the size of the matrices is known at compile time, like in the tracking reconstruction of physics experiments. It is based on a C++ technique, called expression templates, to achieve an high level optimization. The C++ templates can be used to implement vector and matrix expressions such that these expressions can be transformed at compile time to code which is equivalent to hand optimized code in a low-level language like FORTRAN or C (see for example T. Veldhuizen, Expression Templates, C++ Report, 1995).

The **SMatrix** has been developed initially by T. Glebe in Max-Planck-Institut, Heidelberg, as part of the **HeraB** analysis framework. A subset of the original package has been now incorporated in the ROOT distribution, with the aim to provide a stand-alone and high performance matrix package. The API of the current package differs from the original one, in order to be compliant to the ROOT coding conventions.

**SMatrix** contains the generic `ROOT::Math::SMatrix` and `ROOT::Math::SVector` classes for describing matrices and vectors of arbitrary dimensions and of arbitrary type. The classes are templated on the scalar type and on the size, like number of rows and columns for a matrix . Therefore, the matrix/vector dimension has to be known at compile time. An advantage of using the dimension as template parameters is that the correctness of dimension in the matrix/vector operations can be checked at compile time.

**SMatrix** supports, since ROOT v5.10, symmetric matrices using a storage class (`ROOT::Math::MatRepSym`) which contains only the  $N*(N+1)/2$  independent element of a  $N \times N$  symmetric matrix. It is not in the mandate of this package to provide complete linear algebra functionality. It provides basic matrix and vector functions such as matrix-matrix, matrix-vector, vector-vector operations, plus some extra functionality for square matrices, like inversion and determinant calculation. The inversion is based on the optimized Cramer method for squared matrices of size up to  $6 \times 6$ .

The **SMatrix** package contains only header files. Normally one does not need to build any library. In the ROOT distribution a library, `libSMatrix` is produced with the C++ dictionary information for squared and symmetric matrices and vectors up to dimension 7 and based on `Double_t`, `Float_t` and `Double32_t`. The following paragraphs describe the main characteristics of the matrix and vector classes. More detailed information about the **SMatrix** classes API is available in the [online reference documentation](#).

### 13.7.1 Example: Vector Class (SVector)

The template class `ROOT::Math::SVector` represents  $n$ -dimensional vectors for objects of arbitrary type. This class has 2 template parameters, which define at compile time, its properties: 1) type of the contained elements (for example `float` or `double`); 2) size of the vector. The use of this dictionary is mandatory if one want to use **Smatrix** in CINT and with I/O.

### 13.7.1.1 Creating a Vector

The following constructors are available to create a vector:

- Default constructor for a zero vector (all elements equal to zero).
- Constructor (and assignment) from a vector expression, like  $v=p*q+w$ . Due to the expression template technique, no temporary objects are created in this operation.
- Constructor by passing directly the elements. This is possible only for vectors up to size 10.
- Constructor from an iterator copying the data referred by the iterator. It is possible to specify the *begin* and *end* of the iterator or the *begin* and the *size*. Note that for the Vector the iterator is not generic and must be of type  $T^*$ , where T is the type of the contained elements.

In the following example we assume that we are using the namespace `ROOT::Math`

```
//create an empty vector of size 3 ( v[0]=v[1]=v[2]=0)
SVector<double,3> v;
double d[3] = {1,2,3};
SVector<double,3> v(d,3); //create a vector from a C array
```

### 13.7.1.2 Accessing and Setting Methods

The single vector elements can be set or retrieved using the `operator[i]`, `operator(i)` or the iterator interface. Notice that the index starts from zero and not from one as in FORTRAN. Also no check is performed on the passed index. The full vector elements can be set also by using the `SetElements` function passing a generic iterator.

```
double x = m(i);           // return the i-th element
x = *(m.begin()+i);       // return the i-th element
v[0] = 1;                 // set the first element
v(1) = 2;                 // set the second element
*(v.begin()+3) = 3;       // set the third element
std::vector<double> w(3);

// set vector elements from a std::vector<double>::iterator
v.SetElements(w.begin(),w.end());
```

In addition there are methods to place a sub-vector in a vector. If the size of the sub-vector is larger than the vector size a static assert (a compilation error) is produced.

```
SVector<double,N> v;
SVector<double,M> w;
// M <= N otherwise a compilation error is obtained later
// place a vector of size M starting from
// element ioff, v[ioff+i]=w[i]
v.Place_at(w,ioff);
// return a sub-vector of size M starting from
// v[ioff]: w[i]=v[ioff+i]
w = v.Sub < SVector<double,M> > (ioff);
```

For the vector functions see later in the Matrix and Vector Operators and Functions paragraph.



### 13.7.2 Example: Matrix Class (SMatrix)

The template class `ROOT::Math::SMatrix` represents a matrix of arbitrary type with `nrows` x `ncol` dimension. The class has 4 template parameters, which define at compile time, its properties:

- type of the contained elements, `T`, for example `float` or `double`;
- number of rows;
- number of columns;
- representation type. This is a class describing the underlined storage model of the Matrix. Presently exists only two types of this class:
- `ROOT::Math::MatRepStd` for a general `nrows` x `ncols` matrix. This class is itself a template on the contained type `T`, the number of rows and the number of columns. Its data member is an array `T[nrows*ncols]` containing the matrix data. The data are stored in the row-major `C` convention. For example, for a matrix `M`, of size `3x3`, the data `{a0, a1, . . . , a8}` are stored in the following order:

$$M = \begin{pmatrix} a_0 & a_1 & a_2 \\ a_3 & a_4 & a_5 \\ a_6 & a_7 & a_8 \end{pmatrix}$$

- `ROOT::Math::MatRepSym` for a symmetric matrix of size `NxN`. This class is a template on the contained type and on the symmetric matrix size `N`. It has as data member an array of type `T` of size `N*(N+1)/2`, containing the lower diagonal block of the matrix. The order follows the lower diagonal block, still in a row-major convention. For example for a symmetric `3x3` matrix the order of the 6 independent elements `{a0, a1, . . . , a5}` is:

$$M = \begin{pmatrix} a_0 & a_1 & a_3 \\ a_1 & a_2 & a_4 \\ a_3 & a_4 & a_5 \end{pmatrix}$$

#### 13.7.2.1 Creating a Matrix

The following constructors are available to create a matrix:

- Default constructor for a zero matrix (all elements equal to zero).
- Constructor of an identity matrix.
- Copy constructor (and assignment) for a matrix with the same representation, or from a different one when possible, for example from a symmetric to a general matrix.
- Constructor (and assignment) from a matrix expression, like `D=A*B+C`. Due to the expression template technique, no temporary objects are created in this operation. In the case of an operation like `A=A*B+C`, a temporary object is needed and it is created automatically to store the intermediary result in order to preserve the validity of this operation.
- Constructor from a generic STL-like iterator copying the data referred by the iterator, following its order. It is both possible to specify the begin and end of the iterator or the begin and the size. In case of a symmetric matrix, it is required only the triangular block and the user can specify whether giving a block representing the lower (default case) or the upper diagonal part.

Here are some examples on how to create a matrix. We use typedef's in the following examples to avoid the full C++ names for the matrix classes. Notice that for a general matrix the representation has the default value, `ROOT::Math::MatRepStd`, and it is not needed to be specified. Furthermore, for a general square matrix, the number of column may be as well omitted.

```

// typedef definitions used in the following declarations
typedef ROOT::Math::SMatrix<double,3>      SMatrix33;
typedef ROOT::Math::SMatrix<double,2>      SMatrix22;
typedef ROOT::Math::SMatrix<double,3,3,>
ROOT::Math::MatRepSym<double,3>> SMatrixSym3;
typedef ROOT::Math::SVector<double,2>      SVector2;
typedef ROOT::Math::SVector<double,3>      SVector3;
typedef ROOT::Math::SVector<double,6>      SVector6;
SMatrix33  m0;                                // create a zero 3x3 matrix
// create an 3x3 identity matrix
SMatrix33  i = ROOT::Math::SMatrixIdentity();
double  a[9] = {1,2,3,4,5,6,7,8,9};    // input matrix data
// create a matrix using the a[] data
SMatrix33  m(a,9);                        // this will produce the 3x3 matrix
//      ( 1  2  3 )
//      ( 4  5  6 )
//      ( 7  8  9 )

```

Example to fill a symmetric matrix from an `std::vector`:

```

std::vector<double> v(6);
for (int i = 0; i<6; ++i) v[i] = double(i+1);
SMatrixSym3  s(v.begin(),v.end())    // this will produce the
// symmetric matrix
//      ( 1  2  4 )
//      ( 2  3  5 )
//      ( 4  5  6 )
//create a general matrix from a symmetric matrix (the opposite
// will not compile)
SMatrix33  m2 = s;

```

### 13.7.2.2 Accessing and Setting Methods

The matrix elements can be set using the `operator()(irow,icol)`, where `irow` and `icol` are the row and column indexes or by using the iterator interface. Notice that the indexes start from zero and not from one as in FORTRAN. Furthermore, all the matrix elements can be set also by using the `SetElements` function passing a generic iterator. The elements can be accessed by the same methods as well as by using the function `ROOT::Math::SMatrix::apply`. The `apply(i)` has exactly the same behavior for general and symmetric matrices; in contrast to the iterator access methods which behave differently (it follows the data order).

```

SMatrix33  m;
m(0,0) = 1;    // set the element in first row and first column
*(m.begin()+1) = 2;    // set the second element (0,1)
double d[9]={1,2,3,4,5,6,7,8,9};
m.SetElements(d,d+9);    // set the d[] values in m
double x = m(2,1);    // return the element in 3
x = m.apply(7);    // return the 8-th element (row=2,col=1)
x = *(m.begin()+7);    // return the 8-th element (row=2,col=1)
// symmetric matrices
//(note the difference in behavior between apply and the iterators)
x = *(m.begin()+4)    // return the element (row=2,col=1)
x = m.apply(7);    // returns again the (row=2,col=1) element

```

There are methods to place and/or retrieve `ROOT::Math::SVector` objects as rows or columns in (from) a matrix. In addition one can put (get) a sub-matrix as another `ROOT::Math::SMatrix` object in a matrix. If the size of the sub-vector or sub-matrix is larger than the matrix size a static assert (a compilation error) is produced. The non-const methods are:

```

SMatrix33 m;
SVector2  v2(1,2);
// place a vector in the first row from
// element (0,1) : m(0,1)=v2[0]
m.Place_in_row(v2,0,1);
// place the vector in the second column from
// (0,1) : m(0,1) = v2[0]
m.Place_in_col(v2,0,1);
SMatrix22 m2;
// place m2 in m starting from the
// element (1,1) : m(1,1) = m2(0,0)
m.Place_at(m2,1,1);
SVector3  v3(1,2,3);
// set v3 as the diagonal elements
// of m : m(i,i) = v3[i] for i=0,1,2
m.SetDiagonal(v3)

```

The const methods retrieving contents (getting slices of a matrix) are:

```

a = {1,2,3,4,5,6,7,8,9};
SMatrix33  m(a,a+9);
SVector3  irow = m.Row(0);      // return as vector the first row
SVector3  jcol = m.Col(1);      // return as vector the second column

// return a slice of the first row from
// (0,1): r2[0]= m(0,1); r2[1]=m(0,2)
SVector2  r2   = m.SubRow<SVector2> (0,1);
// return a slice of the second column from
// (0,1): c2[0] = m(0,1); c2[1] = m(1,1)
SVector2  c2   = m.SubCol<SVector2> (1,0);

// return a sub-matrix 2x2 with the upper left corner at(1,1)
SMatrix22 subM = m.Sub<SMatrix22> (1,1);

// return the diagonal element in a SVector
SVector3  diag = m.Diagonal();

// return the upper(lower) block of the matrix m
SVector6  vub = m.UpperBlock();    // vub = [ 1, 2, 3, 5, 6, 9 ]
SVector6  vlb = m.LowerBlock();    // vlb = [ 1, 4, 5, 7, 8, 9 ]

```

### 13.7.2.3 Linear Algebra Matrix Functions (Inversion, Determinant)

Only limited linear algebra functionality is available for `SMatrix`. It is possible for squared matrices  $N \times N$ , to find the inverse or to calculate the determinant. Different inversion algorithms are used if the matrix is smaller than  $6 \times 6$  or if it is symmetric. In the case of a small matrix, a faster direct inversion is used. For a large ( $N > 6$ ) symmetric matrix the Bunch-Kaufman diagonal pivoting method is used while for a large ( $N > 6$ ) general matrix an LU factorization is performed using the same algorithm as in the CERNLIB routine `dinv`.

```

// Invert a NxN matrix.
// The inverted matrix replaces the existing one if the
// result is successful
bool ret = m.Invert();           // return the inverse matrix of m.

// If the inversion fails ifail is different than zero ???
int ifail = 0;
ifail = m.Inverse(ifail);

```

```

// determinant of a square matrix - calculate the determinant
// modifying the matrix content and returns it if the calculation
// was successful
double det;
bool ret = m.Det(det);

// calculate determinant by using a temporary matrix; preserves
// matrix content
bool ret = n.Det2(det);

```

### 13.7.3 Example: Matrix and Vector Functions and Operators

#### 13.7.3.1 Matrix and Vector Operators

The `ROOT::Math::SVector` and `ROOT::Math::SMatrix` classes define the following operators described below. The `m1`, `m2`, `m3` are vectors or matrices of the same type (and size) and `a` is a scalar value:

```

m1 == m2 // returns whether m1 is equal to m2
          // (element by element comparison)
m1 != m2 // returns whether m1 is NOT equal to m2
          // (element by element comparison)
m1 < m2  // returns whether m1 is less than m2
          // (element wise comparison)
m1 > m2  // returns whether m1 is greater than m2
          // (element wise comparison)

// in the following m1 and m3 can be general and m2 symmetric,
// but not vice-versa

m1 += m2 // add m2 to m1
m1 -= m2 // subtract m2 to m1
m3 = m1 + m2 // addition
m1 - m2 // subtraction

// Multiplication and division via a scalar value a

m3 = a*m1; m3 = m1*a; m3 = m1/a;

```

**Vector-Vector multiplication:** The operator `*` defines an element by element multiplication between vectors. For the standard vector-vector algebraic multiplication returning a scalar,  $\mathbf{v}^T \mathbf{v}$  (dot product), one must use the `ROOT::Math::Dot` function. In addition, the **Cross (only for vector sizes of 3)**, `ROOT::Math::Cross`, and the Tensor product, `ROOT::Math::TensorProd`, are defined.

**Matrix - Vector multiplication:** The operator `*` defines the matrix-vector multiplication:  $y_i = \sum_j M_{i,j} x_j$ . The operation compiles only if the matrix and the vectors have the right sizes.

```

//M is a N1xN2 matrix, x is a N2 size vector, y is a N1 size vector
y = M * x

```

**Matrix - Matrix multiplication:** The operator `*` defines the matrix-matrix multiplication:  $C_{i,j} = \sum_k A_{i,k} B_{k,j}$ .

```

// A is a N1xN2 matrix, B is a N2xN3 matrix and C is a N1xN3 matrix
C = A * B

```

The operation compiles only if the matrices have the right size. In the case that `A` and `B` are symmetric matrices, `C` is a general one, since their product is not guaranteed to be symmetric.

### 13.7.4 Matrix and Vector Functions

The most used matrix functions are:

- `ROOT::Math::Transpose(M)` returns the transpose matrix  $MT$
- `ROOT::Math::Similarity(v,M)` returns the scalar value resulting from the matrix-vector product  $vTMv$
- `ROOT::Math::Similarity(U,M)` returns the matrix resulting from the product:  $U M U^T$ . If  $M$  is symmetric, the returned resulting matrix is also symmetric
- `ROOT::Math::SimilarityT(U,M)` returns the matrix resulting from the product:  $U^T M U$ . If  $M$  is symmetric, the returned resulting matrix is also symmetric

The major vector functions are:

- `ROOT::Math::Dot(v1,v2)` returns the scalar value resulting from the vector dot product
- `ROOT::Math::Cross(v1,v2)` returns the vector cross product for two vectors of size 3. Note that the `Cross` product is not defined for other vector sizes
- `ROOT::Math::Unit(v)` returns unit vector. One can use also the `v.Unit()` method.
- `ROOT::Math::TensorProd(v1,v2)` returns a general matrix  $M$  of size  $N1 \times N2$  resulting from the tensor product between the vector  $v1$  of size  $N1$  and  $v2$  of size  $N2$ :

For a list of all the available matrix and vector functions see the `SMatrix` online reference documentation.

#### 13.7.4.1 Matrix and Vector I/O

One can print (or write in an output stream) Vectors and Matrices) using the `Print` method or the `<<` operator:

```
// m is a SMatrix or a SVector object
m.Print(std::cout);
std::cout << m << std::endl;
```

In the ROOT distribution, the CINT dictionary is generated for `SMatrix` and `SVector` for for `Double_t`, `Float_t` and `Double32_t` up to dimension 7. This allows the possibility to store them in a ROOT file.

## 13.8 Minuit2 Package

`Minuit2` is a new object-oriented implementation, written in C++, of the popular MINUIT minimization package. Compared with the `TMinuit` class, which is a direct conversion from FORTRAN to C++, `Minuit2` is a complete redesign and re-implementation of the package. This new version provides all the functionality present in the old FORTRAN version, with almost equivalent numerical accuracy and computational performances. Furthermore, it contains new functionality, like the possibility to set single side parameter limits or the FUMILI algorithm (see “FUMILI Minimization Package” in “Fitting Histograms” chapter), which is an optimized method for least square and log likelihood minimizations. `Minuit2` has been originally developed by M. Winkler and F. James in the SEAL project. More information can be found on the [MINUIT Web Site](http://www.cern.ch/minuit/doc/doc.html) and in particular at the following documentation page at <http://www.cern.ch/minuit/doc/doc.html>.

The API has been then changed in this new version to follow the ROOT coding convention (function names starting with capital letters) and the classes have been moved inside the namespace `ROOT::Minuit2`. In addition, the ROOT distribution contains classes needed to integrate `Minuit2` in the ROOT framework, like `TFitterMinuit` and `TFitterFumili`. `Minuit2` can be used in ROOT as another fitter plug-in. For example for using it in histogram fitting, one only needs to do:

```
TVirtualFitter::SetDefaultFitter("Minuit2"); //or Fumili2 for the
// FUMILI algorithm histogram->Fit();
```

For minimization problem, providing an FCN function to minimize, one can do:

```
TVirtualFitter::SetDefaultFitter("Minuit2");
TVirtualFitter * minuit2 = TVirtualFitter::Fitter(0,2);
```

Then set the parameters, the FCN and minimize using the **TVirtualFitter** methods: **SetParameter**, **SetFCN** and **ExecuteCommand**. The FCN function can also be given to **Minuit2** as an instance of a class implementing the **ROOT::Minuit2::FCNBase** interface. In this case one must use directly the **TFitterMinuit** class via the method **SetMinuitFCN**.

Examples on how to use the **Minuit2** and **Fumili2** plug-ins are provided in the tutorials' directory `$ROOTSYS/tutorials/fit:minuit2FitBench.C`, `minuit2FitBench2D.C` and `minuit2GausFit.C`. More information on the classes and functions present in **Minuit2** is available at [online reference documentation](http://seal.cern.ch/documents/minuit/mnusersguide.pdf). In addition, the C++ MINUIT User Guide provides all the information needed for using directly the package without **TVirtualFitter** interface (see <http://seal.cern.ch/documents/minuit/mnusersguide.pdf>). Useful information on MINUIT and minimization in general is provided in the following documents:

F. James, *Minuit Tutorial on Function Minimization* ( <http://seal.cern.ch/documents/minuit/mntutorial.pdf>); F. James, *The Interpretation of Errors in Minuit* ( <http://seal.cern.ch/documents/minuit/mnerror.pdf>);

## 13.9 ROOT Statistics Classes

### 13.9.1 Classes for Computing Limits and Confidence Levels

**TFeldmanCousins** class calculates the CL upper/lower limit for a Poisson process using the Feldman-Cousins method (as described in PRD V57 #7, p3873-3889). No treatment is provided in this method for the uncertainties in the signal or the background.

**TRolke** computes confidence intervals for the rate of a Poisson process in the presence of background and efficiency, using the profile likelihood technique for treating the uncertainties in the efficiency and background estimate. The signal is always assumed to be Poisson; background may be Poisson, Gaussian, or user-supplied; efficiency may be Binomial, Gaussian, or user-supplied. See publication at Nucl. Instrum. Meth. A551:493-503,2005.

**TLimit** class computes 95% C.L. limits using the Likelihood ratio semi-Bayesian method ( method; see e.g. T. Junk, NIM A434, p. 435-443, 1999). It takes signal background and data histograms wrapped in a **TLimitDataSource** as input, and runs a set of Monte Carlo experiments in order to compute the limits. If needed, inputs are fluctuated according to systematic.

### 13.9.2 Specialized Classes for Fitting

**TFractionFitter** fits Monte Carlo (MC) fractions to data histogram (a la HMCMLL, R. Barlow and C. Beeston, Comp. Phys. Comm. 77 (1993) 219-228). It takes into account both data and Monte Carlo statistical uncertainties through a likelihood fit using Poisson statistics. However, the template (MC) predictions are also varied within statistics, leading to additional contributions to the overall likelihood. This leads to many more fit parameters (one per bin per template), but the minimization with respect to these additional parameters is done analytically rather than introducing them as formal fit parameters. Some special care needs to be taken in the case of bins with zero content.

**TMultiDimFit** implements multi-dimensional function parameterization for multi-dimensional data by fitting them to multi-dimensional data using polynomial or Chebyshev or Legendre polynomial

**TSpectrum** contains advanced spectra processing functions for 1- and 2-dimensional background estimation, smoothing, deconvolution, peak search and fitting, and orthogonal transformations.

**RooFit** is a complete toolkit for fitting and data analysis modeling (see the RooFit User Guide at [ftp://root.cern.ch/root/doc/RooFit\\_U\\_29.pdf](ftp://root.cern.ch/root/doc/RooFit_U_29.pdf))

**TSPlot** to disentangle signal from background via an extended maximum likelihood fit and with a tool to access the quality and validity of the fit producing distributions for the control variables. (see M. Pivk and F.R. Le Diberder, Nucl. Inst. Meth.A 555, 356-369, 2005).

### 13.9.3 Multi-variate Analysis Classes

**TMultiLayerPerceptron** is a Neural Network class (see for more details the chapter “Neural Networks”).

**TPrincipal** provides the Principal Component Analysis.

**TRobustEstimator** is a robust method for minimum covariance determinant estimator (MCD).

**TMVA** is a package for multivariate data analysis (see <http://tmva.sourceforge.net/docu/TMVAUsersGuide.pdf> the User’s Guide).





## Chapter 14

# Linear Algebra in ROOT

The linear algebra package is supposed to give a complete environment in ROOT to perform calculations like equation solving and eigenvalue decompositions. Most calculations are performed in double precision. For backward compatibility, some classes are also provided in single precision like **TMatrixF**, **TMatrixFSym** and **TVectorF**. Copy constructors exist to transform these into their double precision equivalent, thereby allowing easy access to decomposition and eigenvalue classes, only available in double precision.

The choice was made not to provide the less frequently used complex matrix classes. If necessary, users can always reformulate the calculation in 2 parts, a real one and an imaginary part. Although, a linear equation involving complex numbers will take about a factor of 8 more computations, the alternative of introducing a set of complex classes in this non-template library would create a major maintenance challenge.

Another choice was to fill in both the upper-right corner and the bottom-left corner of a symmetric matrix. Although most algorithms use only the upper-right corner, implementation of the different matrix views was more straightforward this way. When stored only the upper-right part is written to file.

For a detailed description of the interface, the user should look at the root reference guide at: <http://root.cern.ch/root/Reference.html>

### 14.1 Overview of Matrix Classes

The figure below shows an overview of the classes available in the linear algebra library, `libMatrix.so`. At the center is the base class **TMatrixDBase** from which three different matrix classes, **TMatrixD**, **TMatrixDSym** and **TMatrixDFSparse** derive. The user can define customized matrix operations through the classes **TElementActionD** and **TElementsPosActionD**.

Reference to different views of the matrix can be created through the classes on the right-hand side, see “Matrix Views”. These references provide a natural connection to vectors.

Matrix decompositions (used in equation solving and matrix inversion) are available through the classes on the left-hand side (see “Matrix Decompositions”). They inherit from the **TDecompBase** class. The Eigen Analysis is performed through the classes at the top, see “Matrix Eigen Analysis”. In both cases, only some matrix types can be analyzed. For instance, **TDecompChol** will only accept symmetric matrices as defined **TMatrixDSym**. The assignment operator behaves somewhat different than of most other classes. The following lines will result in an error:

```
TMatrixD a(3,4);
TMatrixD b(5,6);
b = a;
```

It required to first resize matrix b to the shape of a.

```
TMatrixD a(3,4);
TMatrixD b(5,6);
b.ResizeTo(a);
b = a;
```

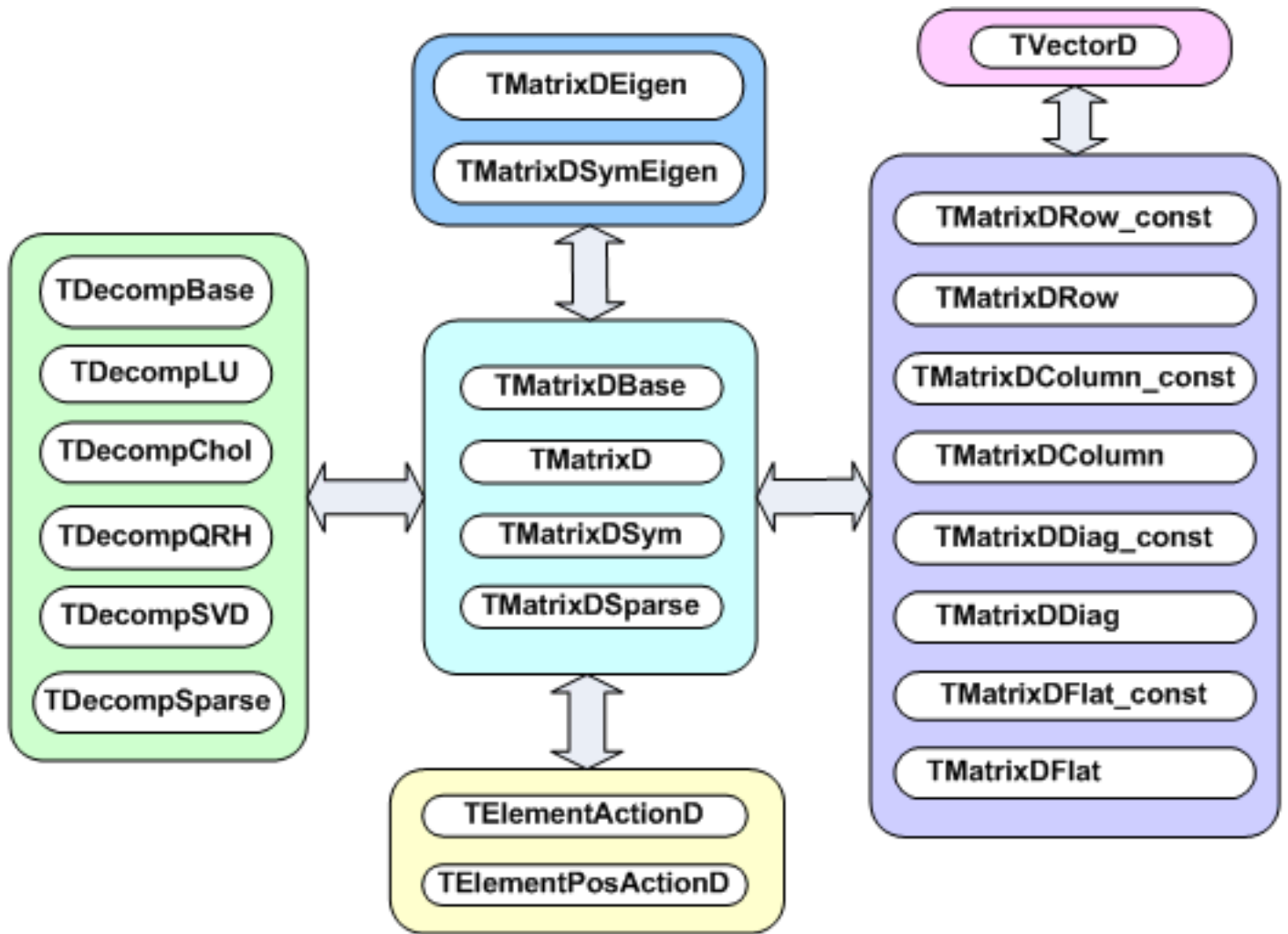

Figure 14.1: Overview of matrix classes

## 14.2 Matrix Properties

A matrix has five properties, which are all set in the constructor:

- **precision** - float or double. In the first case you will use the **TMatrixF** class family, in the latter case the **TMatrixD** one;
- **type** - general (**TMatrixD**), symmetric (**TMatrixDSym**) or sparse (**TMatrixDSparse**);
- **size** - number of rows and columns;
- **index** - range start of row and column index. By default these start at zero;
- **sparse map** - this property is only relevant for a sparse matrix. It indicates where elements are unequal zero.

### 14.2.1 Accessing Properties

The following table shows the methods to access the information about the relevant matrix property:

Method	Descriptions
<code>Int_t GetRowLwb ()</code>	row lower-bound index
<code>Int_t GetRowUpb ()</code>	row upper-bound index
<code>Int_t GetNrows ()</code>	number of rows
<code>Int_t GetColLwb ()</code>	column lower-bound index
<code>Int_t GetColUpb ()</code>	column upper-bound index
<code>Int_t GetNcols ()</code>	number of columns
<code>Int_t GetNoElements ()</code>	number of elements, for a dense matrix this equals: <code>fNrows x fNcols</code>
<code>Double_t GetTol ()</code>	tolerance number which is used in decomposition operations
<code>Int_t *GetRowIndexArray ()</code>	for sparse matrices, access to the row index of <code>fNrows+1</code> entries
<code>Int_t *GetColIndexArray ()</code>	for sparse matrices, access to the column index of <code>fNelems</code> entries

The last two methods in this table are specific to the sparse matrix, which is implemented according to the Harwell-Boeing format. Here, besides the usual shape/size descriptors of the matrix like `fNrows`, `fRowLwb`, `fNcols` and `fColLwb`, we also store a row index, `fRowIndex` and column index, `fColIndex` for the elements unequal zero:

<code>fRowIndex[0, ..., fNrows]:</code>	Stores for each row the index range of the elements in the data and column array
<code>fColIndex[0, ..., fNelems-1]:</code>	Stores the column number for each data element $\neq 0$ .

The code to print all matrix elements unequal zero would look like:

```
TMatrixDSparse a;
const Int_t *rIndex = a.GetRowIndexArray();
const Int_t *cIndex = a.GetColIndexArray();
const Double_t *pData = a.GetMatrixArray();
for (Int_t irow = 0; irow < a.getNrows(); irow++) {
    const Int_t sIndex = rIndex[irow];
    const Int_t eIndex = rIndex[irow+1];
    for (Int_t index = sIndex; index < eIndex; index++) {
        const Int_t icol = cIndex[index];
```

```

    const Double_t data = pData[index];
    printf("data(%d,%d) = %.4en",irow+a.GetfRowLwb(),
        icol+a.GetColLwb(),data);
}
}

```

### 14.2.2 Setting Properties

The following table shows the methods to set some of the matrix properties. The resizing procedures will maintain the matrix elements that overlap with the old shape. The optional last argument `nr_zeros` is only relevant for sparse matrices. If supplied, it sets the number of non-zero elements. If it is smaller than the number overlapping with the old matrix, only the first (row-wise) `nr_zeros` are copied to the new matrix.

Method	Descriptions
<code>SetTol (Double_t tol)</code>	set the tolerance number
<code>ResizeTo (Int_t nrows,Int_t ncols, Int_t nr_nonzeros=-1)</code>	change matrix shape to <code>nrows x ncols</code> . Index will start at zero
<code>ResizeTo(Int_t row_lwb,Int_t row_upb, Int_t col_lwb,Int_t col_upb, Int_t nr_nonzeros=-1)</code>	change matrix shape to <code>row_lwb:row_upb x col_lwb:col_upb</code>
<code>SetRowIndexArray (Int_t *data)</code>	for sparse matrices, set the row index. The array data should contains at least <code>fNrows+1</code> entries column lower-bound index
<code>SetColIndexArray (Int_t *data)</code>	for sparse matrices, set the column index. The array data should contains at least <code>fNelems</code> entries
<code>SetSparseIndex (Int_t nelems new)</code>	allocate memory for a sparse map of <code>nelems_new</code> elements and copy (if exists) at most <code>nelems_new</code> matrix elements over to the new structure
<code>SetSparseIndex (const TMatrixDBase &amp;a)</code>	copy the sparse map from matrix <code>a</code> Note that this can be a dense matrix!
<code>SetSparseIndexAB (const TMatrixDSparse &amp;a, const TMatrixDSparse &amp;b)</code>	set the sparse map to the same of the map of matrix <code>a</code> and <code>b</code>

The second half of the table is only relevant for sparse matrices. These methods define the sparse structure. It should be clear that a call to any of these methods has to be followed by a `SetMatrixArray (...)` which will supply the matrix data, see the next chapter “Creating and Filling a Matrix”.

## 14.3 Creating and Filling a Matrix

The matrix constructors are listed in the next table. In the simplest ones, only the number of rows and columns is given. In a slightly more elaborate version, one can define the row and column index range. Finally, one can also define the matrix data in the constructor. In Matrix Operators and Methods we will encounter more fancy constructors that will allow arithmetic operations.

```

TMatrixD(Int_t nrows,Int_t ncols)
TMatrixD(Int_t row_lwb,Int_t row_upb,Int_t col_lwb,Int_t col_upb)
TMatrixD(Int_t nrows,Int_t ncols,const Double_t *data, Option_t option= "")
TMatrixD(Int_t row_lwb,Int_t row_upb,Int_t col_lwb,Int_t col_upb,  
const Double_t *data,Option_t *option="")

TMatrixDSym(Int_t nrows)
TMatrixDSym(Int_t row_lwb,Int_t row_upb)
TMatrixDSym(Int_t nrows,const Double_t *data,Option_t *option="")
TMatrixDSym(Int_t row_lwb,Int_t row_upb,const Double_t *data, Option_t *opt="")

```

```

TMatrixDSparse(Int_t nrows,Int_t ncols)
TMatrixDSparse(Int_t row_lwb,Int_t row_upb,Int_t col_lwb, Int_t col_upb )
TMatrixDSparse(Int_t row_lwb,Int_t row_upb,Int_t col_lwb,Int_t col_upb,
Int_t nr_nonzeros,Int_t *row,Int_t *col,Double_t *data)

```

---

If only the matrix shape is defined in the constructor, matrix data has to be supplied and possibly the sparse structure. In “Setting Properties” was discussed how to set the sparse structure.

Several methods exist to fill a matrix with data:

`SetMatrixArray(const Double_t*data,Option_t*option="")`, copies the array data. If `option="F"`, the array fills the matrix column-wise else row-wise. This option is only implemented for `TMatrixD` and `TMatrixDSym`. It is expected that the array data contains at least `fNelems` entries.

`SetMatrixArray(Int_t nr,Int_t *irow,Int_t *icol,Double_t *data)`, is only available for sparse matrices. The three arrays should each contain `nr` entries with row index, column index and data entry. Only the entries with non-zero data value are inserted!

`operator()` or `operator[]`, these operators provide the easiest way to fill a matrix but are in particular for a sparse matrix expensive. If no entry for slot  $(i,j)$  is found in the sparse index table it will be entered, which involves some memory management! Therefore, before invoking this method in a loop it is wise to set the index table first through a call to the `SetSparseIndex` method.

`SetSub(Int_t row_lwb,Int_t col_lwb,const TMatrixDBase &source)`, the matrix to be inserted at position  $(row\_lwb,col\_lwb)$  can be both, dense or sparse.

`Use(...)` allows inserting another matrix or data array without actually copying the data. Next table shows the different flavors for the different matrix types.

---

```

Use(TMatrixD &a)
Use(Int_t row_lwb,Int_t row_upb,Int_t col_lwb,Int_t col_upb,Double_t *data)
Use(Int_t nrows,Int_t ncols,Double_t *data)

Use(TMatrixDSym &a)
Use(Int_t nrows,Double_t *data)
Use(Int_t row_lwb,Int_t row_upb,Double_t *data)

Use(TMatrixDSparse &a)
Use(Int_t row_lwb,Int_t row_upb,Int_t col_lwb,Int_t col_upb,Int_t nr_nonzeros,
Int_t *pRowIndex,Int_t *pColIndex,Double_t *pData)
Use(Int_t nrows,Int_t ncols,Int_t nr_nonzeros,Int_t *pRowIndex,
Int_t *pColIndex,Double_t *pData)

```

---

Below follow a few examples of creating and filling a matrix. First we create a Hilbert matrix by copying an array.

```

TMatrixD h(5,5);
TArrayD data(25);
for (Int_t = 0; i < 25; i++) {
    const Int_t ir = i/5;
    const Int_t ic = i%5;
    data[i] = 1./(ir+ic);
}
h.SetMatrixArray(data.GetArray());

```

We also could assign the data array to the matrix without actually copying it.

```

TMatrixD h; h.Use(5,5,data.GetArray());
h.Invert();

```

The array `data` now contains the inverted matrix. Finally, create a unit matrix in sparse format.

```

TMatrixDSparse unit1(5,5);
TArrayI row(5),col(5);
for (Int_t i = 0; i < 5; i++) row[i] = col[i] = i;
TArrayD data(5); data.Reset(1.);
unit1.SetMatrixArray(5,row.GetArray(),col.GetArray(),data.GetArray());

TMatrixDSparse unit2(5,5);
unit2.SetSparseIndex(5);
unit2.SetRowIndexArray(row.GetArray());
unit2.SetColIndexArray(col.GetArray());
unit2.SetMatrixArray(data.GetArray());

```

## 14.4 Matrix Operators and Methods

It is common to classify matrix/vector operations according to BLAS (Basic Linear Algebra Subroutines) levels, see following table:

BLAS level	operations	example	floating-point operations
1	vector-vector	$xTy$	$n$
2	matrix-vector matrix	$Ax$	$n^2$
3	matrix-matrix	$AB$	$n^3$

Most level 1, 2 and 3 BLAS are implemented. However, we will present them not according to that classification scheme it is already boring enough.

### 14.4.1 Arithmetic Operations between Matrices

Description	Format	Comment
element wise sum	C=A+B A+=B Add (A,alpha,B) TMatrixD(A,TMatrixD::kPlus,B)	overwrites A $A = A + \alpha B$ constructor
element wise subtraction	C=A-B A-=B TMatrixD(A,TMatrixD::kMinus,B)	overwrites A constructor
matrix multiplication	C=A*B A*=B C.Mult(A,B) TMatrixD(A,TMatrixD::kMult,B) TMatrixD(A, TMatrixD::kTransposeMult,B) TMatrixD(A, TMatrixD::kMultTranspose,B)	overwrites A constructor of $A.B$ constructor of $A^T.B$ constructor of $A.B^T$
element wise multiplication	ElementMult(A,B)	$A(i,j)*= B(i,j)$
element wise division	ElementDiv(A,B)	$A(i,j)/= B(i,j)$

### 14.4.2 Arithmetic Operations between Matrices and Real Numbers

Description	Format	Comment
element wise sum	C=r+A C=A+r A+=r	overwrites A

element wise subtraction	$C=r-A$ $C=A-r$ $A-=r$	overwrites $A$
matrix multiplication	$C=r*A$ $C=A*r$ $A*=r$	overwrites $A$

---

### 14.4.3 Comparisons and Boolean Operations

The following table shows element wise comparisons between two matrices:

Format	Output	Description
$A == B$	Bool_t	equal to
$A != B$	matrix	Not equal
$A > B$	matrix	Greater than
$A >= B$	matrix	Greater than or equal to
$A < B$	matrix	Smaller than
$A <= B$	matrix	Smaller than or equal to
AreCompatible(A,B)	Bool_t	Compare matrix properties
Compare(A,B)	Bool_t	return summary of comparison
VerifyMatrixIdentity(A,B,verb, maxDev)		Check matrix identity within maxDev tolerance

---

The following table shows element wise comparisons between matrix and real:

Format	Output	Description
$A == r$	Bool_t	equal to
$A != r$	Bool_t	Not equal
$A > r$	Bool_t Bool_t	Greater than
$A >= r$	Bool_t Bool_t	Greater than or equal to
$A < r$		Smaller than
$A <= r$		Smaller than or equal to
VerifyMatrixValue(A,r,verb, maxDev)	Bool_t	Compare matrix value with r within maxDev tolerance

---

### 14.4.4 Matrix Norms

Format	Output	Description
A.RowNorm()	Double_t	norm induced by the infinity vector norm, $\max_i \sum_j  A_{ij} $
A.NormInf()	Double_t	$\max_i \sum_j  A_{ij} $
A.ColNorm()	Double_t	norm induced by the 1 vector norm, $\max_j \sum_i  A_{ij} $
A.Norm1()	Double_t	$\max_j \sum_i  A_{ij} $
A.E2Norm()	Double_t	Square of the Euclidean norm,
A.NonZeros()	Int_t	$\sum_{ji} (A_{ij}^2)$
A.Sum()	Double_t	number of elements unequal zero
A.Min()	Double_t	$\sum_{ji} (A_{ij})$
A.Max()	Double_t	$\min_{ij} (A_{ij})$ $\max_{ij} (A_{ij})$
A.NormByColumn (v, "D")	TMatrixD	$A_{ij} / = \nu_i$ , divide each matrix column by vector v. If the second argument is "M", the column is multiplied.
A.NormByRow (v, "D")	TMatrixD	$A_{ij} / = \nu_j$ , divide each matrix row by vector v. If the second argument is "M", the row is multiplied.

---

### 14.4.5 Miscellaneous Operators

Format	Output	Description
<code>A.Zero()</code>	<code>TMatrixX</code>	$A_{ij} = 0$
<code>A.Abs()</code>	<code>TMatrixX</code>	$A_{ij} =  A_{ij} $
<code>A.Sqr()</code>	<code>TMatrixX</code>	$A_{ij} = A_{ij}^2$
<code>A.Sqrt()</code>	<code>TMatrixX</code>	$A_{ij} = \sqrt{ A_{ij} }$
<code>A.UnitMatrix()</code>	<code>TMatrixX</code>	$A_{ij} = 1$ for $i == j$ else 0
<code>A.Randomize(alpha,beta,seed)</code>	<code>TMatrixX</code>	$A_{ij} = (\beta - \alpha) \cup (0, 1) + \alpha$ a random matrix is generated with elements uniformly distributed between $\alpha$ and $\beta$
<code>A.T()</code>	<code>TMatrixX</code>	$A_{ij} = A_{ji}$
<code>A.Transpose(B)</code>	<code>TMatrixX</code>	$A_{ij} = B_{ji}$
<code>A.Invert(&amp;det)</code>	<code>TMatrixX</code>	Invert matrix A. If the optional pointer to the <code>Double_t</code> argument <code>det</code> is supplied, the matrix determinant is calculated.
<code>A.InvertFast(&amp;det)</code>	<code>TMatrixX</code>	like <code>Invert</code> but for matrices $i = (6 \times 6)$ a faster but less accurate Cramer algorithm is used
<code>A.Rank1Update(v,alpha)</code>	<code>TMatrixX</code>	Perform with vector <code>v</code> a rank 1 operation on the matrix: $A = A + \alpha \cdot v \cdot v^T$
<code>A.RandomizePD(alpha,beta,seed)</code>	<code>TMatrixX</code>	$A_{ij} = (\beta - \alpha) \cup (0, 1) + \alpha$ a random symmetric positive-definite matrix is generated with elements uniformly distributed between $\alpha$ and $\beta$

Output `TMatrixX` indicates that the returned matrix is of the same type as `A`, being `TMatrixD`, `TMatrixDSym` or `TMatrixDSparse`. Next table shows miscellaneous operations for `TMatrixD`.

Format	Output	Description
<code>A.Rank1Update(v1,v2,alpha)</code>	<code>TMatrixD</code>	Perform with vector <code>v1</code> and <code>v2</code> , a rank 1 operation on the matrix: $A = A + \alpha \cdot v_1 \cdot v_2^T$

## 14.5 Matrix Views

Another way to access matrix elements is through the matrix-view classes, `TMatrixDRow`, `TMatrixDColumn`, `TMatrixDDiag` and `TMatrixDSub` (each has also a `const` version which is obtained by simply appending `const` to the class name). These classes create a reference to the underlying matrix, so no memory management is involved. The next table shows how the classes access different parts of the matrix:

class	view
<code>TMatrixDRow const(X,i)</code> <code>TMatrixDRow(X,i)</code>	$\begin{pmatrix} x_{00} & & & & x_{0n} \\ & & & & \\ x_{i0} & \dots & x_{ij} & \dots & x_{in} \\ & & & & \\ x_{n0} & & & & x_{nn} \end{pmatrix}$
<code>TMatrixDColumn const(X,j)</code> <code>TMatrixDColumn(X,j)</code>	$\begin{pmatrix} x_{00} & x_{0j} & x_{0n} \\ & \dots & \\ & x_{ij} & \\ & \dots & \\ x_{n0} & x_{nj} & x_{nn} \end{pmatrix}$



`TMatrixDDiag` `const(X)` `TMatrixDDiag(X)`

$$\begin{pmatrix} x_{00} & & & x_{0n} \\ & \dots & & \\ & & \dots & \\ x_{n0} & & & x_{nn} \end{pmatrix}$$

`TMatrixDSub` `const(X,i,l,j,k)`

`TMatrixDSub(X,i,l,j,k)`

$$\begin{pmatrix} x_{00} & & & x_{0n} \\ & & & \\ & & x_{ij} & \dots & x_{ik} \\ & & x_{lj} & \dots & x_{lk} \\ x_{n0} & & & & x_{nn} \end{pmatrix}$$

### 14.5.1 View Operators

For the matrix views `TMatrixDRow`, `TMatrixDColumn` and `TMatrixDDiag`, the necessary assignment operators are available to interact with the vector class `TVectorD`. The sub matrix view `TMatrixDSub` has links to the matrix classes `TMatrixD` and `TMatrixDSym`. The next table summarizes how the access individual matrix elements in the matrix views:

Format	Comment
<code>TMatrixDRow(A,i)(j)</code> <code>TMatrixDRow(A,i)[j]</code>	element $A_{ij}$
<code>TMatrixDColumn(A,j)(i)</code> <code>TMatrixDColumn(A,j)[i]</code>	element $A_{ij}$
<code>TMatrixDDiag(A(i))</code> <code>TMatrixDDiag(A[i])</code>	element $A_{ij}$
<code>TMatrixDSub(A(i))</code> <code>TMatrixDSub(A,rl,rh,cl,ch)(i,j)</code>	element $A_{ij}$ element $A_{rl+i,cl+j}$

The next two tables show the possible operations with real numbers, and the operations between the matrix views:

Description	Format	Comment
assign real	<code>TMatrixDRow(A,i) = r</code>	row $i$
	<code>TMatrixDColumn(A,j) = r</code>	column $j$
	<code>TMatrixDDiag(A) = r</code>	matrix diagonal
	<code>TMatrixDSub(A,i,l,j,k) = r</code>	sub matrix
add real	<code>TMatrixDRow(A,i) += r</code>	row $i$
	<code>TMatrixDColumn(A,j) += r</code>	column $j$
	<code>TMatrixDDiag(A) += r</code>	matrix diagonal
	<code>TMatrixDSub(A,i,l,j,k) +=r</code>	sub matrix
multiply with real	<code>TMatrixDRow(A,i) *= r</code>	row $i$
	<code>TMatrixDColumn(A,j) *= r</code>	column $j$
	<code>TMatrixDDiag(A) *= r</code>	matrix diagonal
	<code>TMatrixDSub(A,i,l,j,k) *= r</code>	sub matrix

Description	Format	Comment
add matrix slice	<code>TMatrixDRow(A,i1) += TMatrixDRow const(B,i2)</code>	add row $i2$ to row $i1$
	<code>TMatrixDColumn(A,j1) += TMatrixDColumn const(A,j2)</code>	add column $j2$ to column $j1$
	<code>TMatrixDDiag(A) += TMatrixDDiag const(B)</code>	add $B$ diagonal to $A$ diagonal
multiply matrix slice	<code>TMatrixDRow(A,i1) *= TMatrixDRow const(B,i2)</code>	multiply row $i2$ with row $i1$ element wise
	<code>TMatrixDColumn(A,j1) *= TMatrixDColumn const(A,j2)</code>	multiply column $j2$ with column $j1$ element wise
	<code>TMatrixDDiag(A) *= TMatrixDDiag const(B)</code>	multiply $B$ diagonal with $A$ diagonal element wise
	<code>TMatrixDSub(A,i1,l1,j1,k1) *= TMatrixDSub(B,i2,l2,j2,k2)</code>	multiply sub matrix of $A$ with sub matrix of $B$
	<code>TMatrixDSub(A,i,l,j,k) *= B</code>	multiply sub matrix of $A$ with matrix of $B$

In the current implementation of the matrix views, the user could perform operations on a symmetric matrix that violate the symmetry. No checking is done. For instance, the following code violates the symmetry.

```
TMatrixDSym A(5);
A.UnitMatrix();
TMatrixDRow(A,1)[0] = 1;
TMatrixDRow(A,1)[2] = 1;
```

## 14.5.2 View Examples

Inserting row  $i1$  into row  $i2$  of matrix  $A$  can easily accomplished through:

```
TMatrixDRow(A,i1) = TMatrixDRow(A,i2)
```

Which more readable than:

```
const Int_t ncols = A.GetNcols();
Double_t *start = A.GetMatrixArray();
Double_t *rp1 = start+i*ncols;
const Double_t *rp2 = start+j*ncols;
while (rp1 < start+ncols) *rp1++ = *rp2++;
```

Check that the columns of a Haar -matrix of order `order` are indeed orthogonal:

```
const TMatrixD haar = THaarMatrixD(order);
TVectorD colj(1<<order);
TVectorD coll(1<<order);
for (Int_t j = haar.GetCollLwb(); j <= haar.GetColUpb(); j++) {
    colj = TMatrixDColumn_const(haar,j);
    Assert(TMath::Abs(colj*colj-1.0) <= 1.0e-15);

    for (Int_t l = j+1; l <= haar.GetColUpb(); l++) {
```

```

    coll = TMatrixDColumn_const(haar,1);
    Assert(TMath::Abs(colj*coll) <= 1.0e-15);
  }
}

```

Multiplying part of a matrix with another part of that matrix (they can overlap)

```
TMatrixDSub(m,1,3,1,3) *= m.GetSub(5,7,5,7);
```

## 14.6 Matrix Decompositions

The linear algebra package offers several classes to assist in matrix decompositions. Each of the decomposition methods performs a set of matrix transformations to facilitate solving a system of linear equations, the formation of inverses as well as the estimation of determinants and condition numbers. More specifically the classes **TDecompLU**, **TDecompBK**, **TDecompChol**, **TDecompQRH** and **TDecompSVD** give a simple and consistent interface to the LU, Bunch-Kaufman, Cholesky, QR and SVD decompositions. All of these classes are derived from the base class **TDecompBase** of which the important methods are listed in next table:

Method	Action
Bool_t Decompose()	perform the matrix decomposition
Double_t Condition()	calculate $\ A\ _1 \ A^{-1}\ _1$ , see “Condition number”
void Det(Double_t &d1, Double_t &d2)	the determinant is $d1 \cdot 2^{d2}$ . Expressing the determinant this way makes under/over-flow very unlikely
Bool_t Solve(TVectorD &b)	solve $Ax=b$ ; vector <b>b</b> is supplied through the argument and replaced with solution <b>x</b>
TVectorD Solve(const TVectorD &b, Bool_t &ok)	solve $Ax=b$ ; <b>x</b> is returned
Bool_t Solve(TMatrixDColumn &b)	solve $Ax=column(B, j)$ ; $column(B, j)$ is supplied through the argument and replaced with solution <b>x</b>
Bool_t TransSolve(TVectorD &b)	solve $A^T x = b$ ; vector <b>b</b> is supplied through the argument and replaced with solution <b>x</b>
TVectorD TransSolve(const TVectorD b, Bool_t &ok)	solve $A^T x = b$ ; vector <b>x</b> is returned
Bool_t TransSolve(TMatrixDColumn &b)	solve $ATx=column(B, j)$ ; $column(B, j)$ is supplied through the argument and replaced with solution <b>x</b>
Bool_t MultiSolve(TMatrixD &B)	solve $A^T x = b$ ; matrix <b>B</b> is supplied through the argument and replaced with solution <b>X</b>
void Invert(TMatrixD &inv)	call to <b>MultiSolve</b> with as input argument the unit matrix. Note that for a matrix $(m \times n) - A$ with $m > n$ , a pseudo-inverse is calculated
TMatrixD Invert()	call to <b>MultiSolve</b> with as input argument the unit matrix. Note that for a matrix $(m \times n) - A$ with $m > n$ , a pseudo-inverse is calculated

Through **TDecompSVD** and **TDecompQRH** one can solve systems for a  $(m \times n) - A$  with  $m > n$ . However, care has to be taken for methods where the input vector/matrix is replaced by the solution. For instance in the method **Solve(b)**, the input vector should have length  $m$  but only the first  $n$  entries of the output contain the solution. For the **Invert(B)** method, the input matrix **B** should have size  $(m \times n)$  so that the returned  $(m \times n)$  pseudo-inverse can fit in it.

The classes store the state of the decomposition process of matrix  $A$  in the user-definable part of **TObject::fBits**, see the next table. This guarantees the correct order of the operations:

---

<code>kMatrixSet</code>	$A$ assigned
<code>kDecomposed</code>	$A$ decomposed, bit <code>kMatrixSet</code> must have been set.
<code>kDetermined</code>	$\det A$ calculated, bit <code>kDecomposed</code> must have been set.
<code>kCondition</code>	$\ A\ _1 \ A^{-1}\ _1$ is calculated bit <code>kDecomposed</code> must have been set.
<code>kSingular</code>	$A$ is singular

---

The state is reset by assigning a new matrix through `SetMatrix(TMatrixD &A)` for `TDecompBK` and `TDecompChol` (actually `SetMatrix(TMatrixDSym &A)` and `SetMatrix(TMatrixDSparse &A)` for `TMatrixDSparse`).

As the code example below shows, the user does not have to worry about the decomposition step before calling a solve method, because the decomposition class checks before invoking `Solve` that the matrix has been decomposed.

```
TVectorD b = ..;
TMatrixD a = ..;
.
TDecompLU lu(a);
Bool_t ok;
lu.Solve(b,ok);
```

In the next example, we show again the same decomposition but now performed in a loop and all necessary steps are manually invoked. This example also demonstrates another very important point concerning memory management! Note that the vector, matrix and decomposition class are constructed outside the loop since the dimensions of vector/matrix are constant. If we would have replaced `lu.SetMatrix(a)` by `TDecompLU lu(a)`, we would construct/deconstruct the array elements of `lu` on the stack.

```
TVectorD b(n);
TMatrixD a(n,n);
TDecompLU lu(n);
Bool_t ok;
for (...) {
    b = ..;
    a = ..;
    lu.SetMatrix(a);
    lu.Decompose();
    lu.Solve(b,ok);
}
```

### 14.6.1 Tolerances and Scaling

The tolerance parameter `fTol` (a member of the base class `TDecompBase`) plays a crucial role in all operations of the decomposition classes. It gives the user a tool to monitor and steer the operations its default value is  $\varepsilon$  where  $1 + \varepsilon = 1$ .

If you do not want to be bothered by the following considerations, like in most other linear algebra packages, just set the tolerance with `SetTol` to an arbitrary small number. The tolerance number is used by each decomposition method to decide whether the matrix is near singular, except of course SVD that can handle singular matrices. This will be checked in a different way for any decomposition. For instance in LU, a matrix is considered singular in the solving stage when a diagonal element of the decomposed matrix is smaller than `fTol`. Here an important point is raised. The `Decompose()` method is successful as long no zero diagonal element is encountered. Therefore, the user could perform decomposition and only after this step worry about the tolerance number.

If the matrix is flagged as being singular, operations with the decomposition will fail and will return matrices or vectors that are invalid. If one would like to monitor the tolerance parameter but not have the code stop in case of a number smaller than `fTol`, one could proceed as follows:

```
TVectorD b = ..;
TMatrixD a = ..;
```

```

.
TDecompLU lu(a);
Bool_t ok;
TVectorD x = lu.Solve(b,ok);
Int_t nr = 0;
while (!ok) {
    lu.SetMatrix(a);
    lu.SetTol(0.1*lu.GetTol());
    if (nr++ > 10) break;
    x = lu.Solve(b,ok);
}
if (x.IsValid())
cout << "solved with tol =" << lu.GetTol() << endl;
else
cout << "solving failed " << endl;

```

The observant reader will notice that by scaling the complete matrix by some small number the decomposition will detect a singular matrix. In this case, the user will have to reduce the tolerance number by this factor. (For CPU time saving we decided not to make this an automatic procedure).

### 14.6.2 Condition number

The numerical accuracy of the solution  $\mathbf{x}$  in  $A\mathbf{x} = \mathbf{b}$  can be accurately estimated by calculating the condition number  $k$  of matrix  $A$ , which is defined as:

$$k = \|A\|_1 \|A^{-1}\|_1 \text{ where } \|A\|_1 = \max_j (\sum_i |A_{ij}|)$$

A good rule of thumb is that if the matrix condition number is  $10n$ , the accuracy in  $\mathbf{x}$  is  $15 - n$  digits for double precision.

Hager devised an iterative method (W.W. Hager, Condition estimators, SIAM J. Sci. Stat. Comp., 5 (1984), pp. 311-316) to determine  $\|A^{-1}\|_1$  without actually having to calculate  $A^{-1}$ . It is used when calling `Condition()`.

A code example below shows the usage of the condition number. The matrix  $A$  is a (10x10) *Hilbert* matrix that is badly conditioned as its determinant shows. We construct a vector  $\mathbf{b}$  by summing the matrix rows. Therefore, the components of the solution vector  $\mathbf{x}$  should be exactly 1. Our rule of thumb to the 2.1012 condition number predicts that the solution accuracy should be around

$$15 - 12 = 3$$

digits. Indeed, the largest deviation is 0.00055 in component 6.

```

TMatrixDSym H = THilbertMatrixDSym(10);
TVectorD rowsum(10);
for (Int_t irow = 0; irow < 10; irow++)
for (Int_t icol = 0; icol < 10; icol++)
rowsum(irow) += H(irow,icol);
TDecompLU lu(H);
Bool_t ok;
TVectorD x = lu.Solve(rowsum,ok);
Double_t d1,d2;
lu.Det(d1,d2);
cout << "cond:" << lu.Condition() << endl;
cout << "det  :" << d1*TMath::Power(2.,d2) << endl;
cout << "tol  :" << lu.GetTol() << endl;
x.Print();
cond:3.9569e+12
det :2.16439e-53
tol :2.22045e-16
Vector 10 is as follows
|           1           |

```

```

-----
0 | 1
1 | 1
2 | 0.999997
3 | 1.00003
4 | 0.999878
5 | 1.00033
6 | 0.999452
7 | 1.00053
8 | 0.999723
9 | 1.00006

```

### 14.6.3 LU

Decompose an  $n \times n$  matrix  $A$ .

$$PA = LU$$

$P$  permutation matrix stored in the index array `fIndex`: `j=fIndex[i]` indicates that row  $j$  and row  $i$  should be swapped. Sign of the permutation,  $-1^n$ , where  $n$  is the number of interchanges in the permutation, stored in `fSign`.

$L$  is lower triangular matrix, stored in the strict lower triangular part of `fLU`. The diagonal elements of  $L$  are unity and are not stored.

$U$  is upper triangular matrix, stored in the diagonal and upper triangular part of `fU`.

The decomposition fails if a diagonal element of `fLU` equals 0.

### 14.6.4 Bunch-Kaufman

Decompose a real symmetric matrix  $A$

$$A = UDUT$$

$D$  is a block diagonal matrix with 1-by-1 and 2-by-2 diagonal blocks  $D_k$ .

$U$  is product of permutation and unit upper triangular matrices:

$U = P_{n-1}U_{n-1} \cdot \cdot \cdot P_kU_k \cdot \cdot \cdot$  where  $k$  decreases from  $n - 1$  to 0 in steps of 1 or 2. Permutation matrix  $P_k$  is stored in `fIPIV`.  $U_k$  is a unit upper triangular matrix, such that if the diagonal block  $D_k$  is of order  $s$  ( $s = 1, 2$ ), then

$$U_k = \begin{pmatrix} 1 & v & 0 \\ 0 & 1 & 0 \\ 0 & 0 & 1 \end{pmatrix} \begin{matrix} k-s \\ s \\ n-k \end{matrix}$$

$$\begin{matrix} k-s & s & n-k \end{matrix}$$

If  $s = 1$ ,  $D_k$  overwrites  $A(k, k)$ , and  $v$  overwrites  $A(0 : k - 1, k)$ .

If  $s = 2$ , the upper triangle of  $D_k$  overwrites  $A(k-1, k-1)$ ,  $A(k-1, k)$ , and  $A(k, k)$ , and  $v$  overwrites  $A(0 : k - 2, k - 1 : k)$ .

### 14.6.5 Cholesky

Decompose a symmetric, positive definite matrix  $A$

$$A = UTU$$

$U$  is an upper triangular matrix. The decomposition fails if a diagonal element of `fU`  $\leq 0$ , the matrix is not positive negative.

### 14.6.6 QRH

Decompose a  $(m \times n)$  - matrix  $A$  with  $m \geq n$ .

$$A = QRH$$

$Q$  orthogonal  $(m \times n)$  - matrix, stored in **fQ**;

$R$  upper triangular  $(n \times n)$  - matrix, stored in **fR**;

$H$   $(n \times n)$  - Householder matrix, stored through;

**fUp**  $n$  - vector with Householder up's;

**fW**  $n$  - vector with Householder beta's.

The decomposition fails if in the formation of reflectors a zero appears, i.e. singularity.

### 14.6.7 SVD

Decompose a  $(m \times n)$  - matrix  $A$  with  $m \geq n$ .

$$A = USVT$$

$U$   $(m \times m)$  orthogonal matrix, stored in **fU**;

$S$  is diagonal matrix containing the singular values. Diagonal stored in vector **fSig** which is ordered so that **fSig[0] >= fSig[1] >= ... >= fSig[n-1]**;

$V$   $(n \times n)$  orthogonal matrix, stored in **fV**.

The singular value decomposition always exists, so the decomposition will (as long as  $m \geq n$ ) never fail. If  $m < n$ , the user should add sufficient zero rows to  $A$ , so that  $m == n$ . In the SVD, **fTol** is used to set the threshold on the minimum allowed value of the singular values: **min singular = fTol maxi(Sii)**.

## 14.7 Matrix Eigen Analysis

Classes **TMatrixDEigen** and **TMatrixDSymEigen** compute eigenvalues and eigenvectors for general dense and symmetric real matrices, respectively. If matrix  $A$  is symmetric, then  $A = V.D.V^T$ , where the eigenvalue matrix  $D$  is diagonal and the eigenvector matrix  $V$  is orthogonal. That is, the diagonal values of  $D$  are the eigenvalues, and  $V.V^T = I$ , where  $I$  - is the identity matrix. The columns of  $V$  represent the eigenvectors in the sense that  $A.V = V.D$ . If  $A$  is not symmetric, the eigenvalue matrix  $D$  is block diagonal with the real eigenvalues in 1-by-1 blocks and any complex eigenvalues,  $a+ib$ , in 2-by-2 blocks,  $[a,b;-b,a]$ . That is, if the complex eigenvalues look like:

$$\begin{pmatrix} u+iv & . & . & . & . & . \\ . & u-iv & . & . & . & . \\ . & . & a+ib & . & . & . \\ . & . & . & a-ib & . & . \\ . & . & . & . & x & . \\ . & . & . & . & . & y \end{pmatrix}$$

then  $D$  looks like:

$$\begin{pmatrix} u & v & . & . & . & . \\ -v & u & . & . & . & . \\ . & . & a & b & . & . \\ . & . & . & -b & a & . \\ . & . & . & . & x & . \\ . & . & . & . & . & y \end{pmatrix}$$

This keeps  $V$  a real matrix in both symmetric and non-symmetric cases, and  $A.V = V.D$ . The matrix  $V$  may be badly conditioned, or even singular, so the validity of the equation  $A = V.D.V^{-1}$  depends upon the condition number of  $V$ . Next table shows the methods of the classes **TMatrixDEigen** and **TMatrixDSymEigen** to obtain the eigenvalues and eigenvectors. Obviously, **MatrixDSymEigen** constructors can only be called with **TMatrixDSym**:

Format	Output	Description
<code>eig.GetEigenvectors ()</code>	<code>TMatrixD</code>	eigenvectors for both <code>TMatrixDEigen</code> and <code>TMatrixDSymEigen</code>
<code>eig.GetEigenValues ()</code>	<code>TVectorD</code>	eigenvalues vector for <code>TMatrixDSymEigen</code>
<code>eig.GetEigenValues()</code>	<code>TMatrixD</code>	eigenvalues matrix for <code>TMatrixDEigen</code>
<code>eig.GetEigenValuesRe ()</code>	<code>TVectorD</code>	real part of eigenvalues for <code>TMatrixDEigen</code>
<code>eig.GetEigenValuesIm ()</code>	<code>TVectorD</code>	imaginary part of eigenvalues for <code>TMatrixDEigen</code>

Below, usage of the eigenvalue class is shown in an example where it is checked that the square of the singular values of a matrix  $c$  are identical to the eigenvalues of  $c^T$ .  $c$ :

```

const TMatrixD m = THilbertMatrixD(10,10);
TDecompSVD svd(m);
TVectorD sig = svd.GetSig(); sig.Sqr();
// Symmetric matrix EigenVector algorithm
TMatrixDSym mtm(TMatrixDBase::kAtA,m);
const TMatrixDSymEigen eigen(mtm);
const TVectorD eigenVal = eigen.GetEigenValues();
const Bool_t ok = VerifyVectorIdentity(sig,eigenVal,1,1.-e-14);

```

## 14.8 Speed Comparisons

Speed of four matrix operations have been compared between four matrix libraries, `GSL` `CLHEP`, `ROOT v3.10` and `ROOT v4.0`. Next figure shows the CPU time for these four operations as a function of the matrix size:

1. **A\*B** The execution time is measured for the sum of  $A * B_{\text{sym}}$ ,  $B_{\text{sym}} * A$  and  $A * B$ . Notice the `matrix_size3` dependence of execution time. `CLHEP` results are hampered by a poor implementation of symmetric matrix multiplications. For instance, for general matrices of size  $100 \times 100$ , the time is 0.015 sec. while  $A * B_{\text{sym}}$  takes 0.028 sec and  $B_{\text{sym}} * A$  takes 0.059 sec.

Both `GSL` and `ROOT v4.0` can be setup to use the hardware-optimized multiplication routines of the `BLAS` libraries. It was tested on a G4 PowerPC. The improvement becomes clearly visible around sizes of  $(50 \times 50)$  were the execution speed improvement of the `Altivec` processor becomes more significant than the overhead of filling its pipe.

2.  $A^{-1}$  Here, the time is measured for an in-place matrix inversion.

Except for `ROOT v3.10`, the algorithms are all based on an LUfactorization followed by forward/back-substitution. `ROOT v3.10` is using the slower Gaussian elimination method. The numerical accuracy of the `CLHEP` routine is poor:

- up to  $6 \times 6$  the numerical imprecise Cramer multiplication is hard-coded. For instance, calculating  $U=H*H^{-1}$ , where  $H$  is a  $(5 \times 5)$  Hilbert matrix, results in off-diagonal elements of  $10^{-7}$  instead of the  $10^{-13}$  using an LU according to `Crout`.
- scaling protection is non-existent and limits are hard-coded, as a consequence inversion of a Hilbert matrix for `sizes > (12x12)` fails. In order to gain speed the `CLHEP` algorithm stores its permutation info of the pivots points in a static array, making multi-threading not possible.

`GSL` uses LU decomposition without the implicit scaling of `Crout`. Therefore, its accuracy is not as good. For instance a  $(10 \times 10)$  Hilbert matrix has errors 10 times larger than the LU `Crout` result. In `ROOT v4.0`, the user can choose between the `Invert()` and `InvertFast()` routines, where the latter is using the Cramer algorithm for `sizes < 7x7`. The speed graph shows the result for `InvertFast()`.



3.  $A*x=b$  the execution time is measured for solving the linear equation  $A*x=b$ . The same factorizations are used as in the matrix inversion. However, only 1 forward/back-substitution has to be used instead of  $n$  as in the inversion of  $(n \times n)$  matrix. As a consequence the same differences are observed but less amplified. CLHEP shows the same numerical issues as in step the matrix inversion. Since ROOT3.10 has no dedicated equation solver, the solution is calculated through  $x=A^{-1}*b$ . This will be slower and numerically not as stable.
4.  $(A^T * A)^{-1} * A^T$  timing results for calculation of the pseudo inverse of matrix a. The sequence of operations measures the impact of several calls to constructors and destructors in the C++ packages versus a C library like GSL.

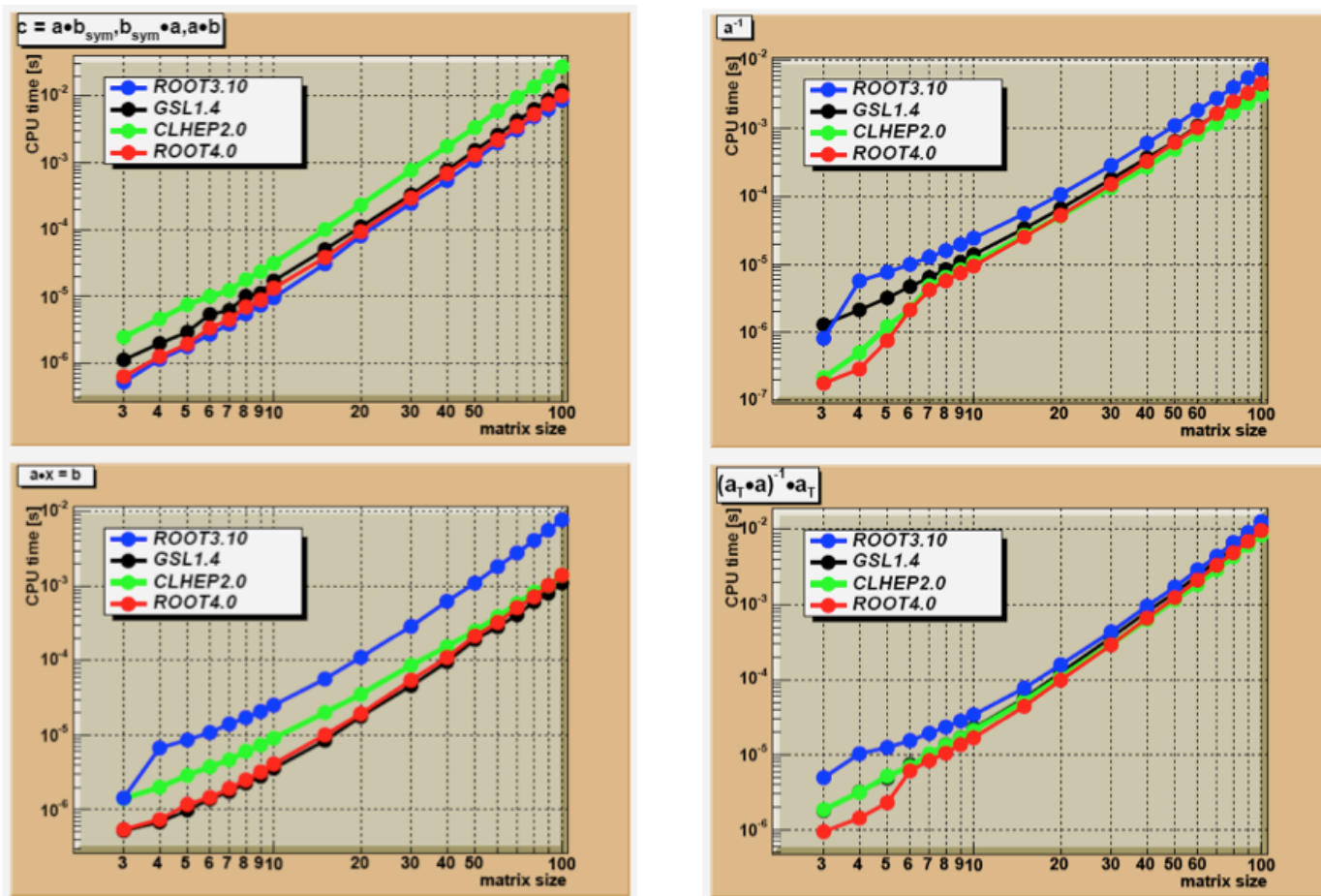

Figure 14.2: Speed comparison between the different matrix packages



# Chapter 15

## Adding a Class

### 15.1 The Role of TObject

The light-weight **TObject** class provides the default behavior and protocol for the objects in the ROOT system. Specifically, it is the primary interface to classes providing object I/O, error handling, inspection, introspection, and drawing. The interface to this service is via abstract classes.

#### 15.1.1 Introspection, Reflection and Run Time Type Identification

Introspection, which is also referred to as reflection, or run time type identification (RTTI) is the ability of a class to reflect upon itself or to “look inside itself. ROOT implements reflection with the **TClass** class. It provides all the information about a class, a full description of data members and methods, including the comment field and the method parameter types. A class with the **ClassDef** macro has the ability to obtain a **TClass** with the **IsA** method.

```
TClass *cl = obj->IsA();
```

It returns a **TClass**. In addition, an object can directly get the class name and the base classes by:

```
const char* name = obj->ClassName();
```

If the class is a descendent of **TObject**, you can check if an object inherits from a specific class, you can use the **InheritsFrom** method. This method returns **kTrue** if the object inherits from the specified class name or **TClass**.

```
Bool_t b = obj->InheritsFrom("TLine");  
Bool_t b = obj->InheritsFrom(TLine::Class());
```

ROOT and CINT rely on reflection and the class dictionary to identify the type of a variable at run time. With **TObject** inheritance come some methods that use Introspection to help you see the data in the object or class. For instance:

```
obj->Dump();           // lists all data members and their current value  
obj->Inspect();       // opens a window to browse data members  
obj->DrawClass();     // Draws the class inheritance tree
```

For an example of `obj->Inspect()`, see “Inspecting Objects”.

#### 15.1.2 Collections

To store an object in a ROOT collection, it must be a descendent of **TObject**. This is convenient if you want to store objects of different classes in the same collection and execute the method of the same name on all members of the collection. For example, the list of graphics primitives are in a ROOT collection called **TList**. When the canvas is drawn, the **Paint** method is executed on the entire collection. Each member may be a different class, and if the **Paint** method is not implemented, **TObject::Paint** will be executed.

### 15.1.3 Input/Output

The `TObject::Write` method is the interface to the ROOT I/O system. It streams the object into a buffer using the `Streamer` method. It supports cycle numbers and automatic schema evolution. See “Input/Output”.

### 15.1.4 Paint/Draw

These graphics methods are defaults; their implementation in `TObject` does not use the graphics subsystem. The `TObject::Draw` method is simply a call to `AppendPad`. The `Paint` method is empty. The default is provided so that one can call `Paint` in a collection. The method `GetDrawOption` returns the draw option that was used when the object was drawn on the canvas. This is especially relevant with histograms and graphs.

### 15.1.5 Clone/DrawClone

Two useful methods are `Clone` and `DrawClone`. The `Clone` method takes a snapshot of the object with the `Streamer` and creates a new object. The `DrawClone` method does the same thing and in addition draws the clone.

### 15.1.6 Browse

This method is called if the object is browse-able and is to be displayed in the object browser. For example the `TTree` implementation of `Browse`, calls the `Browse` method for each branch. The `TBranch::Browse` method displays the name of each leaf. For the object's `Browse` method to be called, the `IsFolder()` method must be overridden to return true. This does not mean it has to be a folder, it just means that it is browse-able.

### 15.1.7 SavePrimitive

This method is called by a canvas on its list of primitives, when the canvas is saved as a script. The purpose of `SavePrimitive` is to save a primitive as a C++ statement(s). Most ROOT classes implement the `SavePrimitive` method. It is recommended that the `SavePrimitive` is implemented in user defined classes if it is to be drawn on a canvas. Such that the command `TCanvas::SaveAs(Canvas.C)` will preserve the user-class object in the resulting script.

### 15.1.8 GetObjectInfo

This method is called when displaying the event status in a canvas. To show the event status window, select the `Options` menu and the `EventStatus` item. This method returns a string of information about the object at position (x, y). Every time the cursor moves, the object under the cursor executes the `GetObjectInfo` method. The string is then shown in the status bar. There is a default implementation in `TObject`, but it is typically overridden for classes that can report peculiarities for different cursor positions (for example the bin contents in a `TH1`).

### 15.1.9 IsFolder

By default an object inheriting from `TObject` is not brows-able, because `TObject::IsFolder()` returns `kFALSE`. To make a class browse-able, the `IsFolder` method needs to be overridden to return `kTRUE`. In general, this method returns `kTRUE` if the object contains browse-able objects (like containers or lists of other objects).

### 15.1.10 Bit Masks and Unique ID

A `TObject` descendent inherits two data members: `fBits` and `fUniqueID`. `fBits` is 32-bit data member used with a bit mask to get object information. Bits 0 - 13 are reserved as global bits, bits 14 - 23 can be used in different class hierarchies.

```
enum EObjBits {
    kCanDelete      = BIT(0), // if can be deleted
    kMustCleanup    = BIT(3), // if destructor must call RecursiveRemove()
    kObjInCanvas    = BIT(3), // for backward compatibility only
    kIsReferenced   = BIT(4), // if referenced by TRef or TRefArray
    kHasUUID        = BIT(5), // if has a UUID, fUniqueID=UUIDNumber
    kCannotPick     = BIT(6), // if cannot be picked in a pad
    kNoContextMenu = BIT(8), // if does not want a context menu
    kInvalidObject  = BIT(13) // object ctor succeeded but the object should not be used
};
```

For example, the bits `kMustCleanup` and `kCanDelete` are used in `TObject`. See “The `kCanDelete` Bit” and “The `kMustCleanup` Bit”. They can be set by any object and should not be reused. Make sure to no overlap in any given hierarchy them. The bit 13 (`kInvalidObject`) is set when an object could not be read from a ROOT file. It will check this bit and will skip to the next object on the file.

The `TObject` constructor initializes the `fBits` to zero depending if the object is created on the stack or allocated on the heap. When the object is created on the stack, the `kCanDelete` bit is set to false to protect from deleting objects on the stack. The high 8 bits are reserved for the system usage; the low 24 bits are user settable. `fUniqueID` is a data member used to give a unique identification number to an object. It is initialized to zero by the `TObject` constructor. ROOT does not use this data member. The two data members (`fBits` and `fUniqueID`) are streamed out when writing an object to disk. If you do not use them, you can save some space and time by specifying:

```
MyClass::Class()->IgnoreTObjectStreamer();
```

This sets a bit in the `TClass` object. If the file is compressed, the savings are minimal since most values are zero; however, it saves some space when the file is not compressed. A call to `IgnoreTObjectStreamer` also prevents the creation of two additional branches when splitting the object. If left alone, two branches called `fBits` and `fUniqueID` will appear.

## 15.2 Motivation

If you want to integrate and use your classes with ROOT, to enjoy features like, extensive RTTI (Run Time Type Information) and ROOT object I/O and inspection, you have to add the following line to your class header files:

```
ClassDef(ClassName,ClassVersionID); //The class title
```

For example in `TLine.h` we have:

```
ClassDef(TLine,1); //A line segment
```

The `ClassVersionID` is used by the ROOT I/O system. It is written on the output stream and during reading you can check this version ID and take appropriate action depending on the value of the ID. See “Streamers”. Every time you change the data members of a class, you should increase its `ClassVersionID` by one. The `ClassVersionID` should be  $\geq 1$ . Set `ClassVersionID=0` in case you don’t need object I/O. To be able to generate properly documentation for your classes using `THtml` you must add the statement:

```
ClassImp(ClassName)
```

For example in `TLine.cxx`:

```
ClassImp(TLine)
```

Note that you should provide a default constructor for your classes, i.e. a constructor with zero parameters or with one or more parameters all with default values in case you want to use object I/O. If do not provide such a default constructor, you MUST implement an I/O constructor. If not you will get a compile time error. See the “The Default Constructor” paragraph in this chapter. The `ClassDef` and `ClassImp` macros are defined in the file `Rtypes.h`. This file is referenced by all ROOT include files, so you will automatically get them if you use a ROOT include file.

### 15.2.1 Template Support

In ROOT version 3.03 and older, ROOT provided special `ClassDef` and `ClassImp` macros for classes with two and three template arguments. In ROOT version 3.04 and above, the macros `ClassDef` and `ClassImp` can be used directly even for a class template. `ClassImp` is used to register an implementation file in a class. For class templates, the `ClassImp` can only be used for a specific class template instance.

```
ClassImp(MyClass1<double>);
```

For multiple template arguments, you will need to use an intermediary `typedef`:

```
typedef MyClass2<int,float> myc_i_f;
ClassImp(myc_i_f);
```

You can also register an implementation for all instances of a class template by using `templateClassImp`:

```
templateClassImp(MyClass3);
```

Here are examples of a header and a `LinkDef` file:

```
// in header file MyClass.h
template <typename T> class MyClass1 {
private:
    T fA;
    ...
public:
    ...
    ClassDef(MyClass1,1)
};
template <typename T1, typename T2> class MyClass2 {
private:
    T1 fA;
    T2 fB;
public:
    ...
    ClassDef(MyClass2,1)
};
template <typename T1, typename T2, typename T3> class MyClass3 {
private:
    T1 fA;
    T2 fB;
    T3 fC;
    ...
public:
    ...
    ClassDef(MyClass3,1)
};

// A LinkDef.h file with all the explicit template instances
// that will be needed at link time
#ifdef __CINT__

#pragma link C++ class MyClass1<float>+;
#pragma link C++ class MyClass1<double>+;
#pragma link C++ class MyClass2<float,int>+;
#pragma link C++ class MyClass2<float,double>+;
#pragma link C++ class MyClass3<float,int,TObject*>+;
#pragma link C++ class MyClass3<float,TEvent*,TObject*>+;

#endif
```

## 15.3 The Default Constructor

ROOT object I/O requires every class to have either a default constructor or an I/O constructor. A default constructor is a constructor with zero parameters or with one or more parameters all with default values. An I/O constructor is a constructor with exactly one parameter which type is a pointer to one of the type marked as an 'io constructor type'. We will come back to this context in a few paragraphs. This default or I/O constructor is called whenever an object is being read from a ROOT database. Be sure that you do not allocate any space for embedded pointer objects in this constructor. This space will be lost (memory leak) while reading in the object. For example:

```
class T49Event : public TObject {
private:
  Int_t      fId;
  TCollection *fTracks;
  ...
public:
  // Error space for TList pointer will be lost
  T49Event() { fId = 0; fTrack = new TList; }
  // Correct default initialization of pointer
  T49Event() { fId = 0; fTrack = 0; }
  ...
};
```

The memory will be lost because during reading of the object the pointer will be set to the object it was pointing to at the time the object was written. Create the `fTrack` list when you need it, e.g. when you start filling the list or in a **not-default** constructor.

```
...
if (!fTrack) fTrack = new TList;
...
```

The constructor actually called by the ROOT I/O can be customized by using the `rootcint` pragma:

```
#pragma link C++ iocortype UserClass;
```

For example, with this pragma and a class named `MyClass`, the ROOT I/O will call the first of the following 3 constructors which exists and is public:

```
MyClass(UserClass*); MyClass(TRootIOctor*);
MyClass(); // Or a constructor with all its arguments defaulted.
```

When more than one pragma `iocortype` is used, the first seen as priority. For example with:

```
#pragma link C++ iocortype UserClass1;
#pragma link C++ iocortype UserClass2;
```

We look for the first existing public constructor in the following order:

```
MyClass(UserClass1*);
MyClass(UserClass2*);
MyClass(TRootIOctor*);
MyClass(); // Or a constructor with all its arguments defaulted.
```

## 15.4 rootcint: The CINT Dictionary Generator

In the following example, we walk through the steps necessary to generate a dictionary, I/O, and inspect member functions. Let's start with a **TEvent** class, which contains a collection of **TTracks**.

The `TEvent.h` header is:

```
#ifndef __TEvent__
#define __TEvent__
#include "TObject.h"
class TCollection;
class TTrack;

class TEvent : public TObject {
private:
    Int_t      fId;           // event sequential id
    Float_t    fTotalMom;    // total momentum
    TCollection *fTracks;    // collection of tracks
public:
    TEvent() { fId = 0; fTracks = 0; }
    TEvent(Int_t id);
    ~TEvent();
    void      AddTrack(TTrack *t);
    Int_t     GetId() const { return fId; }
    Int_t     GetNoTracks() const;
    void      Print(Option_t *opt="");
    Float_t   TotalMomentum();

    ClassDef(TEvent,1); //Simple event class
};
```

The things to notice in these header files are:

- The usage of the `ClassDef` macro
- The default constructors of the **TEvent** and **TTrack** classes
- Comments to describe the data members and the comment after the `ClassDef` macro to describe the class

These classes are intended for you to create an event object with a certain id, and then add tracks to it. The track objects have a pointer to their event. This shows that the I/O system correctly handles circular references.

The `TTrack.h` header is:

```
#ifndef __TTrack__
#define __TTrack__
#include "TObject.h"

class TEvent;
class TTrack : public TObject {
private:
    Int_t      fId;           //track sequential id
    TEvent     *fEvent;      //event to which track belongs
    Float_t    fPx;         //x part of track momentum
    Float_t    fPy;         //y part of track momentum
    Float_t    fPz;         //z part of track momentum
public:
    TTrack() { fId = 0; fEvent = 0; fPx = fPy = fPz = 0; }
    TTrack(Int_t id, Event *ev, Float_t px,Float_t py,Float_t pz);
```



```

Float_t Momentum() const;
TEvent *GetEvent() const { return fEvent; }
void Print(Option_t *opt="");

ClassDef (TTrack,1); //Simple track class
};

#endif

```

Next is the implementation of these two classes.

TEvent.cxx:

```

#include <iostream.h>

#include "TOrdCollection.h"
#include "TEvent.h"
#include "TTrack.h"

ClassImp(TEvent)

...

```

TTrack.cxx:

```

#include <iostream.h>

#include "TMath.h"
#include "Track.h"
#include "Event.h"

ClassImp(TTrack)

...

```

Now using `rootcint` we can generate the dictionary file.

Make sure you use a unique filename, because `rootcint` appends it to the name of static function (`G__cpp_reset_tabableeventdict()` and `G__set_cpp_environmenteventdict()`).

```
rootcint eventdict.cxx -c TEvent.h TTrack.h
```

Looking in the file `eventdict.cxx` we can see, besides the many member function calling stubs (used internally by the interpreter), the `Streamer()` and `ShowMembers()` methods for the two classes. `Streamer()` is used to stream an object to/from a `TBuffer` and `ShowMembers()` is used by the `Dump()` and `Inspect()` methods of `TObject`. Here is the `TEvent::Streamer` method:

```

void TEvent::Streamer(TBuffer &R__b) {
    // Stream an object of class TEvent.
    if (R__b.IsReading()) {
        Version_t R__v = R__b.ReadVersion();
        TObject::(R__b);
        R__b >> fId;
        R__b >> fTotalMom;
        R__b >> fTracks;
    } else {
        R__b.WriteVersion(TEvent::IsA());
        TObject::Streamer(R__b);
        R__b << fId;
    }
}

```

```

    R__b << fTotalMom;
    R__b << fTracks;
}
}

```

The **TBuffer** class overloads the `operator<<()` and `operator>>()` for all basic types and for pointers to objects. These operators write and read from the buffer and take care of any needed byte swapping to make the buffer machine independent. During writing, the **TBuffer** keeps track of the objects that have been written and multiple references to the same object are replaced by an index. In addition, the object's class information is stored. **TEvent** and **TTracks** need manual intervention. Cut and paste the generated `Streamer()` from the `eventdict.cxx` into the class' source file and modify as needed (e.g. add counter for array of basic types) and disable the generation of the `Streamer()` when using the `LinkDef.h` file for next execution of `rootcint`. In case you do not want to read or write this class (no I/O) you can tell `rootcint` to generate a dummy `Streamer()` by changing this line in the source file:

```
ClassDef(TEvent,0);
```

If you want to prevent the generation of `Streamer()`, see the section “Adding a Class with a Shared Library”.

### 15.4.1 Dictionaries for STL

Usually, headers are passed to `rootcint` at the command line. To generate a dictionary for a class from the STL, e.g.

`std::vector<MyClass>`, you would normally pass the header defining **MyClass** and `std::vector`. The latter is a compiler specific header and cannot be passed to `rootcint` directly. Instead, create a little header file that includes both headers, and pass that to `rootcint`.

Often ROOT knows where **MyClass** and the templated class (e.g. `vector`) are defined, for example because the files got `#included`. Knowing these header files ROOT can automatically generate the dictionary for any template combination (e.g. `vector<myClass>`) when it is needed, by generating files starting with **AutoDict\***. You can toggle this feature on or off at the ROOT prompt by executing `.autodict`.

## 15.5 Adding a Class with a Shared Library

**Step 1:** Define your own class in `SClass.h` and implement it in `SClass.cxx`. You must provide a default constructor or an I/O constructor for your class. See the “The Default Constructor” paragraph in this chapter.

```

#include <iostream.h>
#include "TObject.h"
class SClass : public TObject {
private:
    Float_t   fX;           //x position in centimeters
    Float_t   fY;           //y position in centimeters
    Int_t     fTempValue;  //! temporary state value
public:
    SClass()                { fX = fY = -1; }
    void Print() const;
    void SetX(float x) { fX = x; }
    void SetY(float y) { fY = y; }

ClassDef(SClass, 1)
};

```

**Step 2:** Add a call to the `ClassDef` macro to at the end of the class definition (in the `SClass.h` file). `ClassDef(SClass,1)`. Add a call to the `ClassImp` macro in the implementation file (`SClass.cxx`): `ClassImp(SClass)`.

```
// SClass.cxx:
#include "SClass.h"
ClassImp(SClass);
void SClass::Print() const {
    cout << "fX = " << fX << ", fY = " << fY << endl;
}
}
```

You can add a class without using the `ClassDef` and `ClassImp` macros; however, you will be limited. Specifically the object I/O features of ROOT will not be available to you for these classes. See “CINT the C++ Interpreter”. The `ShowMembers` and `Streamer` method, as well as the `>>` operator overloads, are implemented only if you use `ClassDef` and `ClassImp`. See `$ROOTSYS/include/Rtypes.h` for the definition of `ClassDef` and `ClassImp`. To exclude a data member from the `Streamer`, add a `!` as the first character in the comments of the field:

```
Int_t    fTempValue; /// temporary state value
```

### 15.5.1 The LinkDef.h File

**Step 3:** The `LinkDef.h` file tells `rootcint` for which classes to generate the method interface stubs.

```
#ifdef __CINT__
#pragma link C++ class SClass;
#endif
```

Three options can trail the class name:

- `-` : tells `rootcint` **not** to generate the `Streamer` method for this class. This is necessary for those classes that need a customized `Streamer` method.

```
#pragma link C++ class SClass-; /// no streamer
```

- `!` : tells `rootcint` **not** to generate the `operator>>(TBuffer &b, MyClass *&obj)` method for this class. This is necessary to be able to write pointers to objects of classes not inheriting from `TObject`.

```
#pragma link C++ class SClass!; /// no >> operator
/// or
#pragma link C++ class SClass-!; /// no streamer, no >> operator
```

- `+` : in ROOT version 1 and 2 tells `rootcint` to generate a `Streamer` with extra byte count information. This adds an integer to each object in the output buffer, but it allows for powerful error correction in case a `Streamer` method is out of sync with data in the file. The `+` option is mutual exclusive with both the `-` and `!` options.

**IMPORTANT NOTE:** In ROOT Version 3 and later, a “+” after the class name tells `rootcint` to use the new I/O system. The byte count check is always added. The new I/O system has many advantages including support automatic schema evolution, full support for STL collections and better run-time performance. We strongly recommend using it.

```
#pragma link C++ class SClass+; /// add byte count
```

For information on `Streamers` see “Input/Output”. To get help on `rootcint` type on the UNIX command line: `rootcint -h`

### 15.5.1.1 The Order Matters

When using template classes, the order of the pragma statements matters. For example, here is a template class `Tmpl` and a normal class `Norm`, which holds a specialized instance of a `Tmpl`:

```
class Norm {
private:
    Tmpl<int>* fIntTmpl;
public:
    ...
};
```

Then in `Linkdef.h`, the pragma statements must be ordered by listing all specializations before any classes that need them:

```
// Correct Linkdef.h ordering
...
#pragma link C++ class Tmpl<int>;
#pragma link C++ class Norm;
...
```

And not vice versa:

```
// Bad Linkdef.h ordering
...
#pragma link C++ class Norm;
#pragma link C++ class Tmpl<int>;
...
```

In this case, `rootcint` generates `Norm::Streamer()` that makes reference to `Tmpl<int>::Streamer()`. Then `rootcint` gets to process `Tmpl<int>` and generates a specialized `Tmpl<int>::Streamer()` function. The problem is, when the compiler finds the first `Tmpl<int>::Streamer()`, it will instantiate it. However, later in the file it finds the specialized version that `rootcint` generated. This causes the error. However, if the `Linkdef.h` order is reversed then `rootcint` can generate the specialized `Tmpl<int>::Streamer()` before it is needed (and thus never instantiated by the compiler).

### 15.5.1.2 Other Useful Pragma Statements

The complete list of pragma statements currently supported by CINT is:

```
#pragma link [C|C++|off] all [class|function|global|typedef];
#pragma link [C|C++|off]
    [class|struct|union|enum|namespace|protected] [name];
#pragma link [C|C++|off] [global|typedef] [name];
#pragma link [C|C++|off] [nestedclass|nestedtypedef];

#pragma link [C++|C|off|MACRO] function [name]<(argtypes)>;
#pragma link
    [C++|C|off|MACRO] function [classname]::[name]<(argtypes)>;
#pragma link off all methods;
#pragma link [C|C++|off] defined_in [filename];
#pragma link
    [C|C++|off] defined_in [class|struct|namespace] [name];
#pragma link [C|C++|off] all_function [classname];
#pragma link [C|C++|off] all_datamember [classname];
```

The `[classname]` and the `[name]` can also contain wildcards. For example:

```
#pragma link C++ class MyClass*;
```

This will request the dictionary for all the class whose name start with 'MyClass' and are already known to CINT (class templates need to have already been instantiated to be considered).

```
#pragma link [C|C++|off] all [class|function|global|typedef];
```

This pragma statement turns on or off the dictionary generation for all classes, structures, namespaces, global variables, global functions and typedefs seen so far by CINT. Example:

```
// some C++ header definition
#ifdef __MAKECINT__
// turns off dictionary generation for all
#pragma link off all class;
#pragma link off all function;
#pragma link off all global;
#pragma link off all typedef;
#endif
```

The next pragma statement selectively turns on or off the dictionary generation for the specified `class`, `struct`, `union`, `enum` or `namespace`:

```
#pragma link
[C|C++|off] [class|class+protected|
struct|union|enum|namespace] [name];
```

The Dictionary of all public members of class and struct will be generated. If the 'class+protected' flag is used, the dictionary for protected members will also be generated. However, dictionary for protected constructor and destructor will not be generated. This 'class+protected' flag will help you only for plain protected member access, but not for virtual function resolution.

If you use the 'namespace' flag, it is recommended to add also:

```
#pragma link nestedclass;
#pragma link nestedtypedef;
```

The behavior of 'class', 'struct' and 'namespace' flag are identical. Example:

```
// some C++ header definition
#ifdef __MAKECINT__
#pragma link off all class;
#pragma link C++ class A;
#pragma link C++ class B;
#pragma link C++ class C<int>;
#pragma link C++ class+protected D;
#pragma link C++ namespace project1;
#pragma link C++ nestedclass;
#pragma link C++ nestedtypedef;
#endif
```

The next pragma statement selectively turns on or off the dictionary generation for global variables and typedef.

```
#pragma link [C|C++|off] [global|typedef] [name];
```

Example:

```
// some C/C++ header definition
#ifdef __MAKECINT__
#pragma link off all global;
#pragma link off all typedef;
#pragma link C++ global a;
#pragma link C++ typedef Int_t;
#endif
```

This pragma statement turns on the dictionary generation for nested classes and nested typedefs.

```
#pragma link [C|C++|off] [nestedclass|nestedtypedef];
```

Example:

```
// some C/C++ header definition
#ifdef __MAKECINT__
#pragma link off all global;
#pragma link off all typedef;
#pragma link C++ global a;
#pragma link C++ typedef Int_t;
#endif
```

The next pragma statements turn on or off the dictionary generation for the specified function(s) or member function(s). The list of arguments' type is optional. If you omit argument types, all function with specified [name] will be affected. If the list of arguments' type is specified, only the function that has exactly same argument list will be affected.

```
#pragma link [C++|C|off|MACRO] function [fname]<(argtypes)>;
#pragma link
[C++|C|off|MACRO] function [classname]::[fname]<(argtypes)>;
```

The '#pragma link [C++|C] function' and '#pragma link MACRO function' behaves similarly. The '#pragma link [C++|C] function' assumes the target to be a real function which has pointer to it. A pointer to registered function is registered. On the other hand, '#pragma link MACRO function' assumes target to be macro function. Pointer to function cannot be referenced in this case.

For the next example:

```
void f(int a);
void f(double a);
int g(int a,double b);
int g(double x);
#define max(a,b) (a>b?a:b)

class A {
public:
    int h(double y);
    int h(int a,double b);
};
```

The pragma statements are:

```
#ifdef __MAKECINT__
#pragma link off all functions;
#pragma link C++ function f;
#pragma link C++ function g(int,double);
#pragma link C++ MACRO max;
#pragma link C++ class A;
#pragma link off function A::h(double);
#endif
```

Until CINT version 5.15.60, in order to generate dictionary for a member function, not only the member function but also the class itself has to be turned on for the linkage. There was an inconvenience when generating dictionary for template member function afterwards.

From CINT v.5.15.61, a new behavior is introduced. If link for a member function is specified, dictionary is generated even if link to the belonging class is off. For example, if you originally have A.h as follows:

```
// A.h
template<class T> class A {
public:
    template<class E> void f(E& x) { ... }
};
```

And generate dictionary for that:

```
#ifdef __MAKECINT__
#pragma link C++ class A<int>;
#endif
```

Then prepare another header file and instantiate the template member function of A.:

```
// B.h
#include "A.h"

class B {
...
};
```

You can generate dictionary for the newly instantiated template member function only.

```
#ifdef __MAKECINT__
#pragma link off defined_in A.h;
#pragma link C++ function A<int>::f(B&);
#endif
```

The next pragma turns off the dictionary generation of all the member functions in all classes.

```
#pragma link off all methods;
```

Example:

```
#ifdef __MAKECINT__
#pragma link off all methods;
#endif
```

The next pragma statements control the linking of all the member functions or data members for a specified class.

```
#pragma link [C|C++|off] all_function [classname];
#pragma link [C|C++|off] all_datamember [classname];
```

At this moment, there should be no needs to use those statements. Example:

```
#ifdef __MAKECINT__
#pragma link off all_function A;
#pragma link off all_datamember A;
#endif
```

See also: `#pragma link function`.

The next pragma statement turns on/off dictionary generation of the object defined in specific file. The filename has to be the full pathname of the file.

```
#pragma link [C|C++|off] defined_in [filename];
```

Example:

```
// file1.h
// any C++ header definition

// file2.h

#ifdef __MAKECINT__
#pragma link off all classes;
#pragma link off all functions;
#pragma link off all globals;

#pragma link off all typedef;
#pragma link C++ defined_in file1.h;
#endif
```

The next pragma statements turn on or off the dictionary generation of the object defined in a specific scope. The `[scope_name]` should be `class` name, `struct` name or `namespace` name. When using these pragmas, it is recommended to use also:

```
#pragma link C++ nestedclass
```

Otherwise, definitions in enclosed scope do not appear in the dictionary.

```
#pragma link [C|C++|off] defined_in [scope_name];
#pragma link [C|C++|off] defined_in
[class|struct|namespace] [scope_name];
```

Example:

```
namespace ns {
    int a;
    double b;
};
```

The pragma statements are:

```
#ifdef __MAKECINT__
#pragma link C++ defined_in ns;
#pragma link C++ nestedclass;
#endif
```

This statements controls default link mode for `makecint(cint -c-1|-c-2)` and `rootcint`.

```
#pragma link default [on|off]
```

By turning default 'on', all language constructs in given header files will be included in generated CINT dictionary (interface method source file). If default is set to 'off', nothing will be included in the generated dictionary. The next statement explicitly set linkage to each item:



```
#pragma link [C|C++|off] [class|function|global]
```

This pragma statement must be given before `cint/rootcint` reads any C/C++ definitions from header files. For pure CINT, default is on. For ROOT, including `$ROOTSYS/DIR/bin/cint`, default is off. This feature was added from CINT v.5.15.57. Before this version, you had to use explicitly in the ROOT `LinkDef.h` file the next statement:

```
#pragma link off [class|function|global];
```

From 5.15.57, you can omit them. Example:

```
#ifdef __MAKECINT__
#pragma link default off;
#endif

class A {
    int a;
    double b;
};

class B {
    int d;
    double e;
};

#ifdef __MAKECINT__
#pragma link C++ class A;           // only class A is linked, not B
#endif
```

**15.5.1.2.1 Compilation Step 4:** Compile the class using the Makefile. In the Makefile call `rootcint` to make the dictionary for the class. Call it `SClassDict.cxx`. The `rootcint` utility generates the methods `Streamer`, `TBuffer` & `operator>>()` and `ShowMembersfor` for ROOT classes.

```
gmake -f Makefile
```

Load the shared library:

```
root[] .L SClass.so
root[] SClass *sc = new SClass()
root[] TFile *f = new TFile("Afile.root","UPDATE");
root[] sc->Write();
```

For more information on `rootcint` see the `$ROOTSYS/test` directory `Makefile`, `Event.cxx`, and `Event.h` for an example, or follow this link: <http://root.cern.ch/root/RootCintMan.html>

## 15.6 Adding a Class with ACLiC

**Step 1:** Define your class

```
#include "TObject.h"

// define the ABC class and make it inherit from TObject so that
// we can write ABC to a ROOT file
class ABC : public TObject {
```

```

public:
    Float_t a, b, c, p;
    ABC() : a(0), b(0), c(0), p(0){};

// Define the class for the cint dictionary
ClassDef (ABC,1)
};

// Call the ClassImp macro to give the ABC class RTTI and
// full I/O capabilities.

#if !defined(__CINT__)
ClassImp(ABC);
#endif

```

**Step 2:** Load the ABC class in the script.

```

// Check if ABC is already loaded
if (!TClass::GetDict("ABC")) {
    gROOT->ProcessLine(".L ABCClass.C++");
}

// Use the Class
ABC *v = new ABC;
v->p = (sqrt((v->a * v->a) + (v->b * v->b) + (v->c * v->c)));

```

# Chapter 16

## Collection Classes

Collections are a key feature of the ROOT system. Many, if not most, of the applications you write will use collections. If you have used parameterized C++ collections or polymorphic collections before, some of this material will be review. However, much of this chapter covers aspects of collections specific to the ROOT system. When you have read this chapter, you will know

- How to create instances of collections
- The difference between lists, arrays, hash tables, maps, etc.
- How to add and remove elements of a collection
- How to search a collection for a specific element
- How to access and modify collection elements
- How to iterate over a collection to access collection elements
- How to manage memory for collections and collection elements
- How collection elements are tested for equality (`IsEqual()`)
- How collection elements are compared (`Compare()`) in case of sorted collections
- How collection elements are hashed (`Hash()`) in hash tables

### 16.1 Understanding Collections

A collection is a group of related objects. You will find it easier to manage a large number of items as a collection. For example, a diagram editor might manage a collection of points and lines. A set of widgets for a graphical user interface can be placed in a collection. A geometrical model can be described by collections of shapes, materials and rotation matrices. Collections can themselves be placed in collections. Collections act as flexible alternatives to traditional data structures of computers science such as arrays, lists and trees.

#### 16.1.1 General Characteristics

The ROOT collections are polymorphic containers that hold pointers to `TObject`s, so:

- They can only hold objects that inherit from `TObject`
- They return pointers to `TObject`s, that have to be cast back to the correct subclass

Collections are dynamic; they can grow in size as required. Collections themselves are descendants of **TObject** so can themselves be held in collections. It is possible to nest one type of collection inside another to any level to produce structures of arbitrary complexity.

Collections do not own the objects they hold for the very good reason that the same object could be a member of more than one collection. Object ownership is important when it comes to deleting objects; if nobody owns the object it could end up as wasted memory (i.e. a memory leak) when no longer needed. If a collection is deleted, its objects are not. The user can force a collection to delete its objects, but that is the user's choice.

### 16.1.2 Determining the Class of Contained Objects

Most containers may hold heterogeneous collections of objects and then it is left to the user to correctly cast the **TObject** pointer to the right class. Casting to the wrong class will give wrong results and may well crash the program! Therefore, the user has to be very careful. Often a container only contains one class of objects, but if it really contains a mixture, it is possible to ask each object about its class using the **InheritsFrom** method.

For example if `myObject` is a **TObject** pointer:

```
if (myObject->InheritsFrom("TParticle") {
    printf("myObject is a TParticle");
}
```

As the name suggests, this test works even if the object is a subclass of **TParticle**. The member function **IsA()** can be used instead of **InheritsFrom** to make the test exact. The **InheritsFrom** and **IsA** methods use the extensive Run Time Type Information (RTTI) available via the ROOT meta-classes.

### 16.1.3 Types of Collections

The ROOT system implements the following basic types of collections: unordered collections, ordered collections and sorted collections. Next figure shows the inheritance hierarchy for the primary collection classes. All primary collection classes derive from the abstract base class **TCollection**.

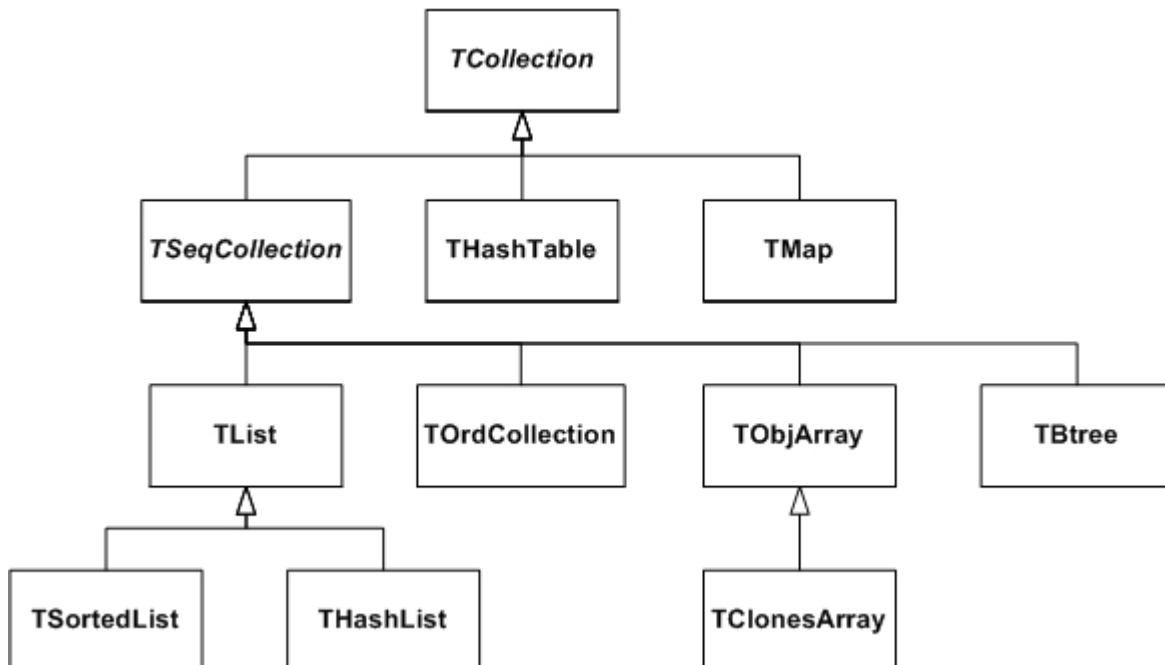

Figure 16.1: The inheritance hierarchy of the primary collection classes

### 16.1.4 Ordered Collections (Sequences)

Sequences are collections that are externally ordered because they maintain internal elements according to the order in which they were added. The following sequences are available:

- **TList**
- **THashList**
- **TOrdCollection**
- **TObjArray**
- **TClonesArray**

The **TOrdCollection**, **TObjArray** as well as the **TClonesArray** can be sorted using their **Sort()** member function (for this, the stored objects must provide a comparison function by overriding **TObject::Compare()** and also must enable sorting by overriding **TObject::IsSortable()** to return true). Ordered collections all derive from the abstract base class **TSeqCollection**. Sorted collections are ordered by an internal (automatic) sorting mechanism. The following sorted collections are available (the stored items must be sortable):

- **TSortedList**
- **TBtree**

Unordered collections don't maintain the order in which the elements were added, i.e. when you iterate over an unordered collection, you are not likely to retrieve elements in the same order they were added to the collection. The following unordered collections are available:

- **THashTable**
- **TMap**

## 16.2 Iterators: Processing a Collection

The concept of processing all the members of a collection is generic, i.e. independent of any specific representation of a collection. To process each object in a collection one needs some type of cursor that is initialized and then steps over each member of the collection in turn. Collection objects could provide this service but there is a snag: as there is only one collection object per collection there would only be one cursor. Instead, to permit the use of as many cursors as required, they are made separate classes called iterator. For each collection class there is an associated iterator class that knows how to sequentially retrieve each member in turn. The relationship between a collection and its iterator is very close and may require that the iterator has full access to the collection (i.e. it is a friend class). In general iterator will be used via the **TIter** wrapper class. For example:

- **TList TListIter**
- **TMap TMapIter**

## 16.3 Foundation Classes

All collections are based on the fundamental classes: **TCollection** and **TIterator**. They are so generic that it is not possible to create objects from them; they are only used as base classes for other classes (i.e. they are abstract base classes).

The **TCollection** class provides the basic protocol (i.e. the minimum set of member functions) that all collection classes have to implement. These include:

- **Add** Adds another object to the collection.

- `GetSize` Returns the number of objects in the collection.
- `Clear` Clears out the collection, but does not delete the removed objects.
- `Delete` Clears out the collection and deletes the removed objects. This should only be used if the collection owns its objects (which are not normally the case).
- `FindObject` Finds an object given either its name or address.
- `MakeIterator` Returns an iterator associated with the collection.
- `Remove` Removes an object from the collection.

The code example below shows a class containing three lists, where the `fTracks` list is the owning collection and the other two lists are used to store a sub-set of the track objects. In the destructor of the class, the method `Delete` is called for the owning collection to delete correctly its entire track objects. To delete the objects in the container use `fTrack->Delete()`. To delete the container itself, do `'delete fTracks'`.

```
class TEvent : public TObject {
private:
    TList *fTracks; //list of all tracks
    TList *fVertex1; //subset of tracks part of vertex1
    TList *fVertex2; //subset of tracks part of vertex2
};
TEvent::~TEvent()
{
    fTracks->Delete();
    delete fTracks;
    delete fVertex1;
    delete fVertex2;
}
```

The `TIterator` class defines the minimum set of member functions that all iterators must support. These include:

- `Next` Returns the next member of the collection or 0 if no more members.
- `Reset` Resets the iterator so that `Next` returns the first object.

## 16.4 A Collectable Class

By default, all objects of `TObject` derived classes can be stored in `ROOT` containers. However, the `TObject` class provides some member functions that allow you to tune the behavior of objects in containers. For example, by default two objects are considered equal if their pointers point to the same address. This might be too strict for some classes where equality is already achieved if some or all of the data members are equal. By overriding the following `TObject` member functions, you can change the behavior of objects in collections:

- `IsEqual()` is used by the `FindObject()` collection method. By default, `IsEqual()` compares the two object pointers.
- `Compare()` returns -1, 0 or 1 depending if the object is smaller, equal or larger than the other object. By default, a `TObject` has not a valid `Compare()` method.
- `IsSortable()` returns true if the class is sort able (i.e. if it has a valid `Compare()` method). By default, a `TObject` is not sort able.
- `Hash()` returns a hash value. It needs to be implemented if an object has to be stored in a collection using a hashing technique, like `THashTable`, `THashList` and `TMap`. By default, `Hash()` returns the address of the object. It is essential to choose a good hash function.

The example below shows how to use and override these member functions.

```

class TObjNum : public TObject {
private:
    Int_t num; // TObjNum is a simple container for an integer.
public:
    TObjNum(Int_t i = 0) : num(i) { }
    ~TObjNum() { }
    void SetNum(Int_t i) { num = i; }
    Int_t GetNum() const { return num; }
    void Print(Option_t *) const
        { printf("num = %dn", num); }
    Bool_t IsEqual(TObject *obj) const
        { return num == ((TObjNum*)obj)->num; }
    Bool_t IsSortable() const { return kTRUE; }
    Int_t Compare(const TObject *obj) const
        { if (num < ((TObjNum*)obj)->num) return -1;
          else if (num > ((TObjNum*)obj)->num) return 1;
          else return 0; }
    ULong_t Hash() const { return num; }
};

```

## 16.5 The TIter Generic Iterator

As stated above, the **TIterator** class is abstract; it is not possible to create **TIterator** objects. However, it should be possible to write generic code to process all members of a collection so there is a need for a generic iterator object. A **TIter** object acts as generic iterator. It provides the same **Next()** and **Reset()** methods as **TIterator** although it has no idea how to support them! It works as follows:

- To create a **TIter** object its constructor must be passed an object that inherits from **TCollection**. The **TIter** constructor calls the **MakeIterator()** method of this collection to get the appropriate iterator object that inherits from **TIterator**.
- The **Next()** and **Reset()** methods of **TIter** simply call the **Next()** and **Reset()** methods of the iterator object.

Therefore, **TIter** simply acts as a wrapper for an object of a concrete class inheriting from **TIterator**.

To see this working in practice, consider the **TObjArray** collection. Its associated iterator is **TObjArrayIter**. Suppose **myarray** is a pointer to a **TObjArray** that contains **MyClass** objects, i.e.

```
TObjArray *myarray;
```

To create a **TIter** object called **myiter**:

```
TIter myiter(myarray);
```

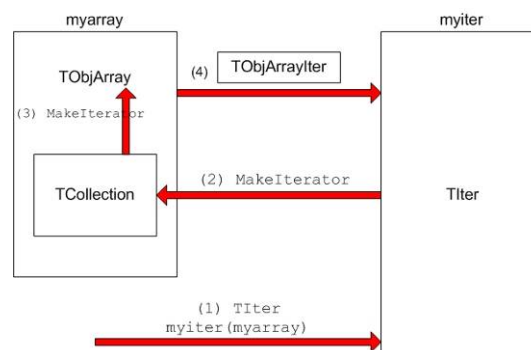

As shown in the diagram, this results in several methods being called:

- The **TIter** constructor is passed a **TObjArray**
- **TIter** asks embedded **TCollection** to make an iterator
- **TCollection** asks **TObjArray** to make an iterator
- **TObjArray** returns a **TObjArrayIter**.

Now define a pointer for **MyClass** objects and set it to each member of the **TObjArray**:

```
MyClass *myobject;
while ((myobject = (MyClass *)myiter.Next())) {
    // process myobject
}
```

The heart of this is the `myiter.Next()` expression which does the following:

- The `Next()` method of the **TIter** object `myiter` is called
- The **TIter** forwards the call to the **TIterator** embedded in the **TObjArrayIter**
- **TIterator** forwards the call to the **TObjArrayIter**
- **TObjArrayIter** finds the next **MyClass** object and returns it
- **TIter** passes the **MyClass** object back to the caller

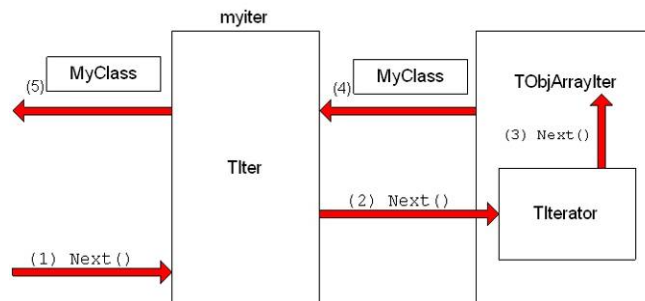

Sometimes the **TIter** object is called `next`, and then instead of writing: `next.Next()` which is legal, but looks rather odd, iteration is written as `next()`. This works because the function operator `()` is defined for the **TIter** class to be equivalent to the `Next()` method.

## 16.6 The TList Collection

A **TList** is a doubly linked list. Before being inserted into the list the object pointer is wrapped in a **TObjLink** object that contains, besides the object pointer also a previous and next pointer.

Objects are typically added using:

- `Add()`
- `AddFirst()`, `AddLast()`
- `AddBefore()`, `AddAfter()`

**Main features of TList:** very low cost of adding/removing elements anywhere in the list.

**Overhead per element:** 1 **TObjLink**, i.e. two 4 (or 8) byte pointers + pointer to `vtable` = 12 (or 24) bytes.

Next figure shows the internal data structure of a **TList**.



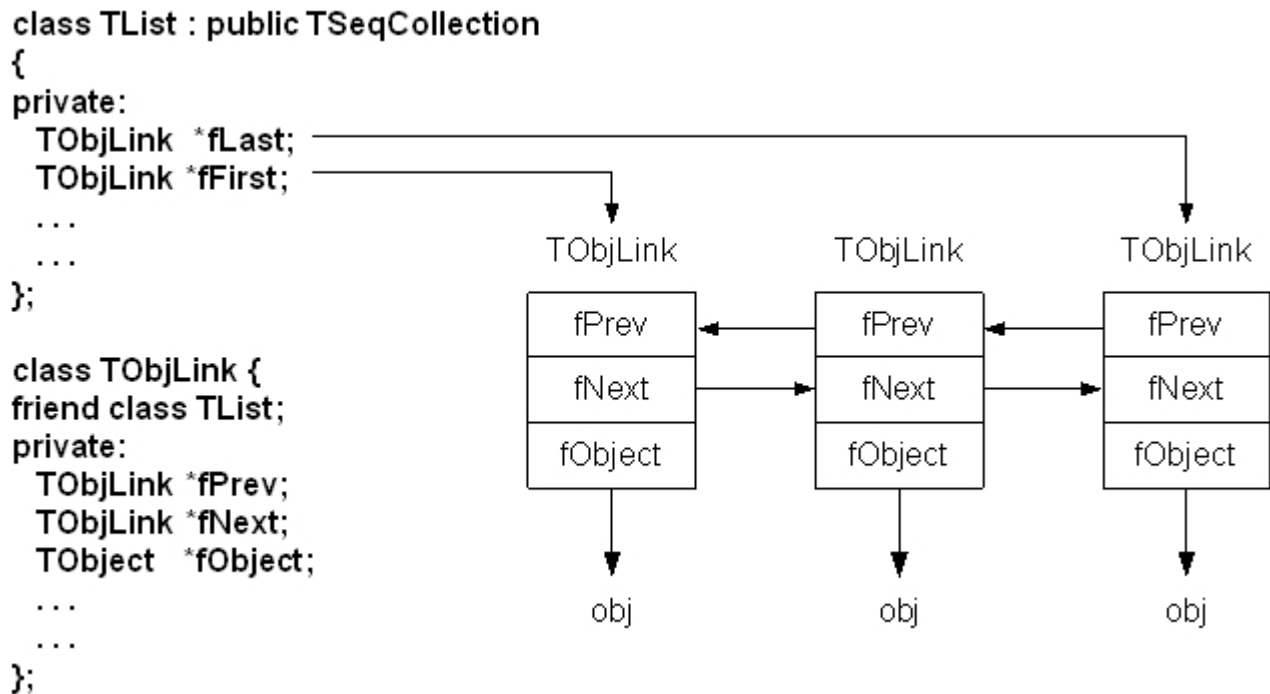

Figure 16.2: The internal data structure of a TList

### 16.6.1 Iterating Over a TList

There are four ways to iterate over a **TList**:

- Using the `ForEach` script:

```
GetListOfPrimitives()->ForEach(TObject,Draw)();
```

- Using the **TList** iterator **TListIter** (via the wrapper class **TIter**):

```
TIter next(GetListOfTracks());
while ((TTrack *obj = (TTrack *)next()))
  obj->Draw();
```

- Using the **TObjLink** list entries (that wrap the **TObject\***):

```
TObjLink *lnk = GetListOfPrimitives()->FirstLink();
while (lnk) {
  lnk->GetObject()->Draw();
  lnk = lnk->Next();
}
```

- Using the **TList**'s `After()` and `Before()` member functions:

```
TFree *idcur = this;
while (idcur) {
  ...
  idcur = (TFree*)GetListOfFree()->After(idcur);
}
```

Method 1 uses internally method 2.

Method 2 works for all collection classes. **TIter** overloads `operator()`.

Methods 3 and 4 are specific for **TList**.

Methods 2, 3 and 4 can also easily iterate backwards using either a backward **TIter** (using argument `kIterBackward`) or by using `LastLink()` and `lnk>Prev()` or by using the `Before()` method.

## 16.7 The TObjArray Collection

A **TObjArray** is a collection which supports traditional array semantics via the overloading of `operator[]`. Objects can be directly accessed via an index. The array expands automatically when objects are added. At creation time one specifies the default array size (default = 16) and lower bound (default = 0). Resizing involves a re-allocation and a copy of the old array to the new. This can be costly if done too often. If possible, set initial size close to expected final size. Index validity is always checked (if you are 100% sure and maximum performance is needed you can use `UncheckedAt()` instead of `At()` or `operator[]`). If the stored objects are sort able the array can be sorted using `Sort()`. Once sorted, efficient searching is possible via the `BinarySearch()` method. The figure shows the internal data structure of a **TObjArray**:

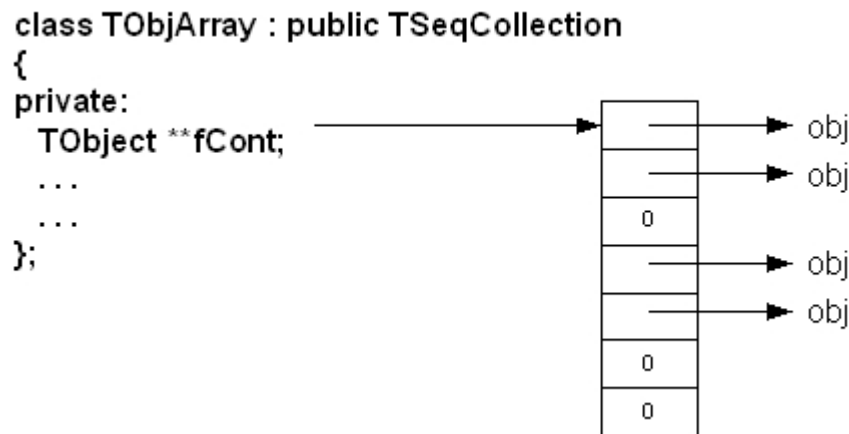

Figure 16.3: The internal data structure of a **TObjArray**

Iterating can be done using a **TIter** iterator or via a simple for loop:

```

for (int i = 0; i <= fArr.GetLast(); i++)
if ((track = (TTrack*)fArr[i]) // or fArr.At(i)
    track->Draw();

```

Main features of **TObjArray** are simple, well-known array semantics. **Overhead per element**: none, except possible over sizing of `fCont`.

## 16.8 TClonesArray An Array of Identical Objects

A **TClonesArray** is an array of identical (clone) objects. The memory for the objects stored in the array is allocated only once in the lifetime of the clones array. All objects must be of the same class. For the rest this class has the same properties as a **TObjArray**.

The figure above shows the internal data structure of a **TClonesArray**. The class is specially designed for repetitive data analysis tasks, where in a loop many times the same objects, are created and deleted. The only supported way to add objects to a **TClonesArray** is via the `new` with placement method. The different `Add()` methods of **TObjArray** and its base classes are not supported.

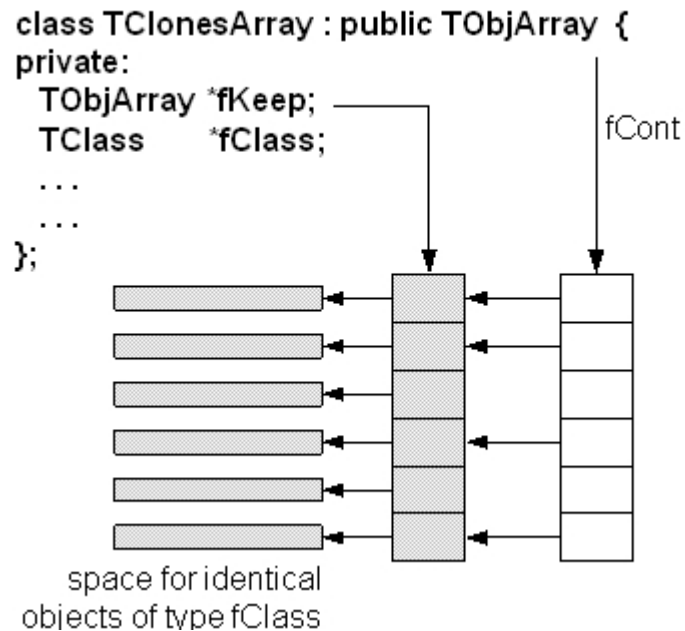

Figure 16.4: The internal data structure of a TClonesArray

### 16.8.1 The Idea Behind TClonesArray

To reduce the very large number of new and delete calls in large loops like this ( $O(100000) \times O(10000)$  times new/delete):

```

TObjArray a(10000);
while (TEvent *ev = (TEvent *)next()) {           // O(100000)
    for (int i = 0; i < ev->Ntracks; i++) {        // O(10000)
        a[i] = new TTrack(x,y,z,...);
        ...
    }
    ...
    a.Delete();
}

```

You better use a **TClonesArray** which reduces the number of new/delete calls to only  $O(10000)$ :

```

TClonesArray a("TTrack", 10000);
while (TEvent *ev = (TEvent *)next()) {           // O(100000)
    for (int i = 0; i < ev->Ntracks; i++) {        // O(10000)
        TTrack *track = (Track*)a.ConstructedAt(i);
        track->Set(x,y,z,...);
        ...
    }
    ...
    a.Clear(); // Or Clear("C") if the track objects must be returned (via Track::Clear) to a default state.
}

```

Considering that a pair of new/delete calls on average cost about 70 ms,  $O(109)$  new/deletes will save about 19 hours. For the other collections, see the class reference guide on the web and the test program `$ROOTSYS/test/tcollex.cxx`.

## 16.9 Template Containers and STL

Some people dislike polymorphic containers because they are not truly “type safe”. In the end, the compiler leaves it the user to ensure that the types are correct. This only leaves the other alternative: creating a new class each time a new

(container organization) / (contained object) combination is needed. To say the least this could be very tedious. Most people faced with this choice would, for each type of container:

Define the class leaving a dummy name for the contained object type. When a particular container was needed, copy the code and then do a global search and replace for the contained class. C++ has a built in template scheme that effectively does just this. For example:

```
template<class T>
class ArrayContainer {
private:
    T *member[10];
    ...
};
```

This is an array container with a 10-element array of pointers to T, it could hold up to 10 T objects. This array is flawed because it is static and hard-coded, it should be dynamic. However, the important point is that the template statement indicates that T is a template, or parameterized class. If we need an `ArrayContainer` for `Track` objects, it can be created by:

```
ArrayContainer<Track> MyTrackArrayContainer;
```

C++ takes the parameter list and substitutes `Track` for T throughout the definition of the class `ArrayContainer`, then compiles the code so generated, effectively doing the same we could do by hand, but with a lot less effort.

This produces code that is type safe, but does have different drawbacks:

- Templates make code harder to read.
- At the time of writing this documentation, some compilers can be very slow when dealing with templates.
- It does not solve the problem when a container has to hold a heterogeneous set of objects.
- The system can end up generating a great deal of code; each container/object combination has its own code, a phenomenon that is sometimes referred to as *code bloat*.
- The Standard Template Library (STL) is part on ANSI C++, and includes a set of template containers.

# Chapter 17

## Physics Vectors

The physics vector classes describe vectors in three and four dimensions and their rotation algorithms. The classes were ported to root from CLHEP see:

<http://wwwinfo.cern.ch/asd/lhc++/clhep/manual/UserGuide/Vector/vector.html>

### 17.1 The Physics Vector Classes

In order to use the physics vector classes you will have to load the Physics library:

```
gSystem.Load("libPhysics.so");
```

There are four classes in this package. They are:

**TVector3** is a general three-vector. A **TVector3** may be expressed in Cartesian, polar, or cylindrical coordinates. Methods include dot and cross products, unit vectors and magnitudes, angles between vectors, and rotations and boosts. There are also functions of particular use to HEP, like pseudo-rapidity, projections, and transverse part of a **TVector3**, and kinetic methods on 4-vectors such as Invariant Mass of pairs or containers of particles.

**TLorentzVector** is a general four-vector class, which can be used either for the description of position and time ( $x, y, z, t$ ) or momentum and energy ( $px, py, pz, E$ ). **TRotation** is a class describing a rotation of a **TVector3** object. **TLorentzRotation** is a class to describe the Lorentz transformations including Lorentz boosts and rotations. In addition, a **TVector2** is a basic implementation of a vector in two dimensions and is not part of the CLHEP translation.

### 17.2 TVector3

**TVector3** is a general three-vector class, which can be used for description of different vectors in 3D. Components of three vectors:

- $x, y, z$  = basic components
- $\theta$  = azimuth angle
- $\phi$  = polar angle
- magnitude =  $mag = \sqrt{x^2 + y^2 + z^2}$
- transverse component =  $perp = \sqrt{x^2 + y^2}$

Using the **TVector3** class, you should remember that it contains only common features of three vectors and lacks methods specific for some particular vector values. For example, it has no translated function because translation has no meaning for vectors.

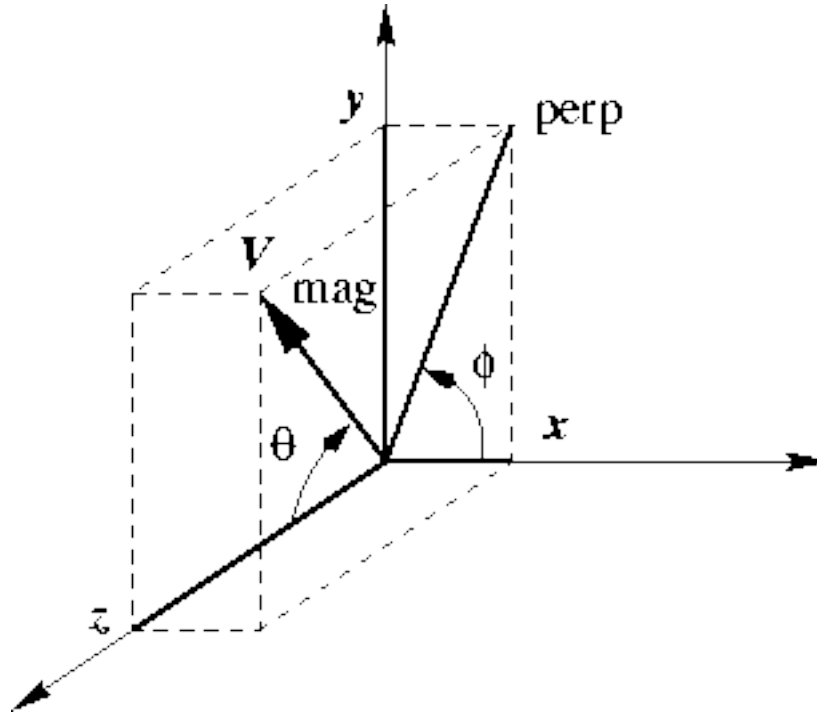

### 17.2.1 Declaration / Access to the Components

**TVector3** has been implemented as a vector of three `Double_t` variables, representing the Cartesian coordinates. By default the values are initialized to zero, however you can change them in the constructor:

```
TVector3 v1;           // v1 = (0,0,0)
TVector3 v2(1);       // v2 = (1,0,0)
TVector3 v3(1,2,3);   // v3 = (1,2,3)
TVector3 v4(v2);      // v4 = v2
```

It is also possible (but not recommended) to initialize a **TVector3** with a `Double_t` or `Float_t` C array. You can get the components by name or by index:

```
xx = v1.X();    or    xx = v1(0);
yy = v1.Y();    yy = v1(1);
zz = v1.Z();    zz = v1(2);
```

The methods `SetX()`, `SetY()`, `SetZ()` and `SetXYZ()` allow you to set the components:

```
v1.SetX(1.); v1.SetY(2.); v1.SetZ(3.);
v1.SetXYZ(1.,2.,3.);
```

### 17.2.2 Other Coordinates

To get information on the **TVector3** in spherical (`rho`, `phi`, `theta`) or cylindrical (`z`, `r`, `theta`) coordinates, the following methods can be used.

```
Double_t m = v.Mag();
// get magnitude (=rho=Sqrt(x*x+y*y+z*z))
Double_t m2 = v.Mag2(); // get magnitude squared
Double_t t = v.Theta(); // get polar angle
Double_t ct = v.CosTheta(); // get cos of theta
Double_t p = v.Phi(); // get azimuth angle
Double_t pp = v.Perp(); // get transverse component
Double_t pp2 = v.Perp2(); // get transverse squared
```

It is also possible to get the transverse component with respect to another vector:

```
Double_t ppv1 = v.Perp(v1);
Double_t pp2v1 = v.Perp2(v1);
```

The pseudo-rapidity ( $\eta = -\ln(\tan(\theta/2))$ ) can be obtained by `Eta()` or `PseudoRapidity()`:

```
Double_t eta = v.PseudoRapidity();
```

These setters change one of the non-Cartesian coordinates:

```
v.SetTheta(.5); // keeping rho and phi
v.SetPhi(.8); // keeping rho and theta
v.SetMag(10.); // keeping theta and phi
v.SetPerp(3.); // keeping z and phi
```

### 17.2.3 Arithmetic / Comparison

The `TVector3` class has operators to add, subtract, scale and compare vectors:

```
v3 = -v1;
v1 = v2+v3;
v1 += v3;
v1 = v1 - v3;
v1 -= v3;
v1 *= 10;
v1 = 5*v2;
if(v1 == v2) {...}
if(v1 != v2) {...}
```

### 17.2.4 Related Vectors

```
v2 = v1.Unit(); // get unit vector parallel to v1
v2 = v1.Orthogonal(); // get vector orthogonal to v1
```

### 17.2.5 Scalar and Vector Products

```
s = v1.Dot(v2); // scalar product
s = v1 * v2; // scalar product
v = v1.Cross(v2); // vector product
```

### 17.2.6 Angle between Two Vectors

```
Double_t a = v1.Angle(v2);
```

### 17.2.7 Rotation around Axes

```
v.RotateX(.5);
v.RotateY(TMath::Pi());
v.RotateZ(angle);
```

### 17.2.8 Rotation around a Vector

```
v1.Rotate(TMath::Pi()/4, v2); // rotation around v2
```

### 17.2.9 Rotation by TRotation Class

**TVector3** objects can be rotated by **TRotation** objects using the `Transform()` method, the operator `*=`, or the operator `*` of the **TRotation** class. See the later section on **TRotation**.

```
TRotation m;
...
v1.Transform(m);
v1 = m*v1;
v1 *= m;           // v1 = m*v1
```

### 17.2.10 Transformation from Rotated Frame

This code transforms `v1` from the rotated frame (`z'` parallel to direction, `x'` in the theta plane and `y'` in the `xy` plane as well as perpendicular to the theta plane) to the (`x`, `y`, `z`) frame.

```
TVector3 direction = v.Unit();
v1.RotateUz(direction); // direction must be TVector3 of unit length
```

## 17.3 TRotation

The **TRotation** class describes a rotation of **TVector3** object. It is a  $3 \times 3$  matrix of `Double_t`:

$$\begin{vmatrix} xx & xy & xz \\ yx & yy & yz \\ zx & zy & zz \end{vmatrix}$$

It describes a so-called active rotation, i.e. a rotation of objects inside a static system of coordinates. In case you want to rotate the frame and want to know the coordinates of objects in the rotated system, you should apply the inverse rotation to the objects. If you want to transform coordinates from the rotated frame to the original frame you have to apply the direct transformation. A rotation around a specified axis means counterclockwise rotation around the positive direction of the axis.

### 17.3.1 Declaration, Access, Comparisons

```
TRotation r; // r initialized as identity
TRotation m(r); // m = r
```

There is no direct way to set the matrix elements - to ensure that a **TRotation** always describes a real rotation. But you can get the values by with the methods `XX()`..`ZZ()` or the `(,)` operator:

```
Double_t xx = r.XX(); // the same as xx=r(0,0)
xx = r(0,0);
if (r==m) {...} // test for equality
if (r!=m) {...} // test for inequality
if (r.IsIdentity()) {...} // test for identity
```

### 17.3.2 Rotation around Axes

The following matrices describe counter-clockwise rotations around the coordinate axes and are implemented in: `RotateX()`, `RotateY()` and `RotateZ()`:

$$Rx(a) = \begin{vmatrix} 1 & 0 & 0 \\ 0 & \cos(a) & -\sin(a) \\ 0 & \sin(a) & \cos(a) \end{vmatrix} \quad Ry(a) = \begin{vmatrix} \cos(a) & 0 & \sin(a) \\ 0 & 1 & 0 \\ -\sin(a) & 0 & \cos(a) \end{vmatrix} \quad Rz(a) = \begin{vmatrix} \cos(a) & -\sin(a) & 0 \\ \sin(a) & \cos(a) & 0 \\ 0 & 0 & 1 \end{vmatrix}$$



```
r.RotateX(TMath::Pi()); // rotation around the x-axis
```

### 17.3.3 Rotation around Arbitrary Axis

The `Rotate()` method allows you to rotate around an arbitrary vector (not necessary a unit one) and returns the result.

```
r.Rotate(TMath::Pi()/3,TVector3(3,4,5));
```

It is possible to find a unit vector and an angle, which describe the same rotation as the current one:

```
Double_t angle;
TVector3 axis;
r.GetAngleAxis(angle,axis);
```

### 17.3.4 Rotation of Local Axes

The `RotateAxes()` method adds a rotation of local axes to the current rotation and returns the result:

```
TVector3 newX(0,1,0);
TVector3 newY(0,0,1);
TVector3 newZ(1,0,0);
a.RotateAxes(newX,newY,newZ);
```

Methods `ThetaX()`, `ThetaY()`, `ThetaZ()`, `PhiX()`, `PhiY()`, `PhiZ()` return azimuth and polar angles of the rotated axes:

```
Double_t tx,ty,tz,px,py,pz;
tx= a.ThetaX();
...
pz= a.PhiZ();
```

### 17.3.5 Inverse Rotation

```
TRotation a,b;
...
b = a.Inverse(); // b is inverse of a, a is unchanged
b = a.Invert(); // invert a and set b = a
```

### 17.3.6 Compound Rotations

The operator `*` has been implemented in a way that follows the mathematical notation of a product of the two matrices which describe the two consecutive rotations. Therefore, the second rotation should be placed first:

```
r = r2 * r1;
```

### 17.3.7 Rotation of TVector3

The `TRotation` class provides an operator `*` which allows expressing a rotation of a `TVector3` analog to the mathematical notation:

$$\begin{pmatrix} x' \\ y' \\ z' \end{pmatrix} = \begin{pmatrix} xx & xy & xz \\ yx & yy & yz \\ zx & zy & zz \end{pmatrix} \times \begin{pmatrix} x \\ y \\ z \end{pmatrix}$$

```
TRotation r;
TVector3 v(1,1,1);
v = r * v;
```

You can also use the `Transform()` method or the operator `*=` of the `TVector3` class:

```
TVector3 v;
TRotation r;
v.Transform(r);
```

## 17.4 TLorentzVector

`TLorentzVector` is a general four-vector class, which can be used either for the description of position and time ( $x, y, z, t$ ) or momentum and energy ( $px, py, pz, E$ ).

### 17.4.1 Declaration

`TLorentzVector` has been implemented as a set a `TVector3` and a `Double_t` variable. By default, all components are initialized by zero.

```
TLorentzVector v1; // initialized by (0.,0.,0.,0.)
TLorentzVector v2(1.,1.,1.,1.);
TLorentzVector v3(v1);
TLorentzVector v4(TVector3(1.,2.,3.),4.);
```

For backward compatibility there are two constructors from a `Double_t` and `Float_t` array.

### 17.4.2 Access to Components

There are two sets of access functions to the components of a `TLorentzVector`: `X()`, `Y()`, `Z()`, `T()` and `Px()`, `Py()`, `Pz()` and `E()`. Both sets return the same values but the first set is more relevant for use where `TLorentzVector` describes a combination of position and time and the second set is more relevant where `TLorentzVector` describes momentum and energy:

```
Double_t xx = v.X();
...
Double_t tt = v.T();
Double_t px = v.Px();
...
Double_t ee = v.E();
```

The components of `TLorentzVector` can also accessed by index:

```
xx = v(0); or xx = v[0];
yy = v(1); yy = v[1];
zz = v(2); zz = v[2];
tt = v(3); tt = v[3];
```

You can use the `Vect()` method to get the vector component of `TLorentzVector`:

```
TVector3 p = v.Vect();
```

For setting components there are two methods: `SetX()`, ..., `SetPx()`, ...:

```

v.SetX(1.); orv.SetPx(1.);
.....
v.SetT(1.);v.SetE(1.);

```

To set more the one component by one call you can use the `SetVect()` function for the `TVector3` part or `SetXYZT()`, `SetPxPyPzE()`. For convenience there is also a `SetXYZM()`:

```

v.SetVect(TVector3(1,2,3));
v.SetXYZT(x,y,z,t);
v.SetPxPyPzE(px,py,pz,e);
v.SetXYZM(x,y,z,m); // v = (x,y,z,e = Sqrt(x*x+y*y+z*z+m*m))

```

### 17.4.3 Vector Components in Non-Cartesian Coordinates

There are a couple of methods to get and set the `TVector3` part of the parameters in `spherical` coordinate systems:

```

Double_t m, theta, cost, phi, pp, pp2, ppv2, pp2v2;
m = v.Rho();
t = v.Theta();
cost = v.CosTheta();
phi = v.Phi();
v.SetRho(10.);
v.SetTheta(TMath::Pi()*0.3);
v.SetPhi(TMath::Pi());

```

or get information about the r-coordinate in cylindrical systems:

```

Double_t pp, pp2, ppv2, pp2v2;
pp = v.Perp(); // get transverse component
pp2 = v.Perp2(); // get transverse component squared
ppv2 = v.Perp(v1); // get transverse component with respect
// to another vector
pp2v2 = v.Perp(v1);

```

there are two more set functions `SetPtEtaPhiE(pt,eta,phi,e)` and `SetPtEtaPhiM(pt,eta,phi,m)` for convenience.

### 17.4.4 Arithmetic and Comparison Operators

The `TLorentzVector` class provides operators to add subtract or compare four-vectors:

```

v3 = -v1;
v1 = v2+v3;
v1+= v3;
v1 = v2 + v3;
v1-= v3;
if (v1 == v2) {...}
if (v1 != v3) {...}

```

### 17.4.5 Magnitude/Invariant mass, beta, gamma, scalar product

The scalar product of two four-vectors is calculated with the  $(-, -, -, +)$  metric:

$$s = v1*v2 = t1*t2-x1*x2-y1*y2-z1*z2$$

The magnitude squared `mag2` of a four-vector is therefore:

$$mag2 = v*v = t*t-x*x-y*y-z*z$$

If `mag2` is negative: `mag = -Sqrt(-mag*mag)`. The methods are:

```

Double_t s, s2;
s = v1.Dot(v2); // scalar product
s = v1*v2; // scalar product
s2 = v.Mag2(); ors2 = v.M2();
s = v.Mag(); s = v.M();

```

Since in case of momentum and energy the magnitude has the meaning of invariant mass **TLorentzVector** provides the more meaningful aliases **M2()** and **M()**. The methods **Beta()** and **Gamma()** returns **beta** and **gamma = 1/Sqrt(1-beta\*beta)**.

### 17.4.6 Lorentz Boost

A boost in a general direction can be parameterized with three parameters which can be taken as the components of a three vector **b=(bx,by,bz)**. With **x=(x,y,z)** and **gamma=1/Sqrt(1-beta\*beta)** (beta being the module of vector b), an arbitrary active Lorentz boost transformation (from the rod frame to the original frame) can be written as:

$$x = x' + (\text{gamma}-1)/(\text{beta}*\text{beta})*(b*x')*b + \text{gamma}*t'*b$$

$$t = \text{gamma}(t' + b*x')$$

The **Boost()** method performs a boost transformation from the rod frame to the original frame. **BoostVector()** returns a **TVector3** of the spatial components divided by the time component:

```

TVector3 b;
v.Boost(bx,by,bz);
v.Boost(b);
b = v.BoostVector(); // b=(x/t,y/t,z/t)

```

### 17.4.7 Rotations

There are four sets of functions to rotate the **TVector3** component of a **TLorentzVector**:

Around Axes:

```

v.RotateX(TMath::Pi()/2.);
v.RotateY(.5);
v.RotateZ(.99);

```

Around an arbitrary axis:

```

v.Rotate(TMath::Pi()/4., v1); // rotation around v1

```

Transformation from rotated frame:

```

v.RotateUz(direction); // direction must be a unit TVector3

```

Rotation by **TRotation**:

```

TRotation r;
v.Transform(r); //or v *= r; (v = r*v)

```

### 17.4.8 Miscellaneous

Angle between two vectors:

```
Double_t a = v1.Angle(v2); // get angle between v1 and v2
```

Methods Plus() and Minus() return the positive and negative light-cone components:

```
Double_t pcone = v.Plus();
Double_t mcone = v.Minus();
```

A general Lorentz transformation (see class TLorentzRotation) can be used by the Transform() method, the \*=, or \* operator of the TLorentzRotation class:

```
TLorentzRotation l;
v.Transform(l);
v = l*v; or v *= l; // v = l*v
```

## 17.5 TLorentzRotation

The TLorentzRotation class describes Lorentz transformations including Lorentz boosts and rotations (see TRotation)

$$\lambda = \begin{vmatrix} xx & xy & xz & xt \\ yx & yy & yz & yt \\ zx & zy & zz & zt \\ tx & ty & tz & tt \end{vmatrix}$$

### 17.5.1 Declaration

By default it is initialized to the identity matrix, but it may also be initialized by other TLorentzRotation, by a pure TRotation or by a boost:

```
TLorentzRotation l; // l is initialized as identity
TLorentzRotation m(l); // m = l
TRotation r;
TLorentzRotation lr(r);
TLorentzRotation lb1(bx,by,bz);
TVector3 b;
TLorentzRotation lb2(b);
```

The Matrix for a Lorentz boosts is:

$$\begin{vmatrix} 1 + \gamma' * bx * bx & \gamma' * bx * by & \gamma' * bx * bz & \gamma * bx \\ \gamma' * bx * bz & 1 + \gamma' * by * by & \gamma' * by * by & \gamma * by \\ \gamma' * bz * bx & \gamma' * bz * by & 1 + \gamma' * bz * bz & \gamma * bz \\ \gamma * bx & \gamma * by & \gamma * bz & \gamma \end{vmatrix}$$

with the boost vector  $\mathbf{b}=(bx,by,bz)$ ;  $\gamma=1/\text{sqrt}(1-\text{beta}*\text{beta})$ ;  $\gamma'=(\gamma-1)/\text{beta}*\text{beta}$ .

### 17.5.2 Access to the Matrix Components/Comparisons

The access to the matrix components is possible with the methods `XX()`, `XY()` ... `TT()`, and with the operator `(int,int)`:

```
Double_t xx;
TLorentzRotation l;
xx = l.XX();           // gets the xx component
xx = l(0,0);          // gets the xx component
if (l == m) {...}     // test for equality
if (l != m) {...}     // test for inequality
if (l.IsIdentity()) {...} // test for identity
```

### 17.5.3 Transformations of a Lorentz Rotation

There are four possibilities to find the product of two `TLorentzRotation` transformations:

```
TLorentzRotation a,b,c;
c = b*a;           // product
c = a.MatrixMultiplication(b); // a is unchanged
a *= b;           // a=a*b
c = a.Transform(b) // a=b*a then c=a
```

Lorentz boosts:

```
Double_t bx, by, bz;
TVector3 v(bx,by,bz);
TLorentzRotation l;
l.Boost(v);
l.Boost(bx,by,bz);
```

Rotations:

```
TVector3 axis;
l.RotateX(TMath::Pi()); // rotation around x-axis
l.Rotate(.5,axis);     // rotation around specified vector
```

Inverse transformation: use the method `Inverse()` to return the inverse transformation keeping the current one unchanged. The method `Invert()` inverts the current `TLorentzRotation`:

```
l1 = l2.Inverse(); // l1 is inverse of l2, l2 unchanged
l1 = l2.Invert(); // invert l2, then l1=l2
```

The matrix for the inverse transformation of a `TLorentzRotation` is as follows:

$$\begin{vmatrix} xx & xy & xz & -tx \\ yx & yy & yz & -ty \\ zx & zy & zz & -tz \\ -xt & -yt & -zt & tt \end{vmatrix}$$

### 17.5.4 Transformation of a TLorentzVector

To apply `TLorentzRotation` to `TLorentzVector` you can use either the `VectorMultiplication()` method or the `*` operator. You can also use the `Transform()` function and the `*=` operator of the class `TLorentzVector`.

```
TLorentzVector v;  
TLorentzRotation l;  
...  
v = l.VectorMultiplication(v);  
v = l * v;  
v.Transform(l);  
v *= l;           // v = l*v
```

### 17.5.5 Physics Vector Example

The test file `$ROOTSYS/test/TestVectors.cxx` is an example of using physics vectors. The vector classes are not loaded by default, and to run it, you will need to load `libPhysics.so` first:

```
root[] .L $ROOTSYS/lib/libPhysics.so  
root[] .x TestVectors.cxx
```

To load the physics vector library in a ROOT application use:

```
gSystem->Load("libPhysics");
```

The example `$ROOTSYS/test/TestVectors.cxx` does not return much, especially if all went well, but when you look at the code you will find examples for many calls.





# Chapter 18

## The Geometry Package

The new ROOT geometry package is a tool for building, browsing, navigating and visualizing detector geometries. The code works standalone with respect to any tracking Monte-Carlo engine; therefore, it does not contain any constraints related to physics. However, the navigation features provided by the package are designed to optimize particle transport through complex geometries, working in correlation with simulation packages such as GEANT3, GEANT4 and FLUKA.

### 18.1 Quick Start: Creating the “world”

This chapter will provide a detailed description on how to build valid geometries as well as the ways to optimize them. There are several components gluing together the geometrical model, but for the time being let us get used with the most basic concepts.

The basic bricks for building-up the model are called **volumes**. These represent the un-positioned pieces of the geometry puzzle. The difference is just that the relationship between the pieces is not defined by neighbors, but by **containment**. In other words, volumes are put one inside another making an in-depth hierarchy. From outside, the whole thing looks like a big pack that you can open finding out other smaller packs nicely arranged waiting to be opened at their turn. The biggest one containing all others defines the “world” of the model. We will often call this **master reference system (MARS)**. Going on and opening our packs, we will obviously find out some empty ones, otherwise, something is very wrong... We will call these leaves (by analogy with a tree structure).

On the other hand, any volume is a small world by itself - what we need to do is to take it out and to ignore all the rest since it is a self-contained object. In fact, the modeller can act like this, considering a given volume as temporary MARS, but we will describe this feature later on. Let us focus on the biggest pack - it is mandatory to define one. Consider the simplest geometry that is made of a single box. Here is an example on how to build it:

#### 18.1.1 Example 1: Creating the World

We first need to load the geometry library. This is not needed if one does `make map` in root folder.

```
root[] gSystem->Load("libGeom");
```

Second, we have to create an instance of the geometry manager class. This takes care of all the modeller components, performing several tasks to insure geometry validity and containing the user interface for building and interacting with the geometry. After its creation, the geometry manager class can be accessed with the global ***gGeoManager***:

```
root[] new TGeoManager("world", "the simplest geometry");
```

We want to create a single volume in our geometry, but since any volume needs to have an associated medium, we will create a dummy one. You can safely ignore the following lines for the time being, since materials and media will be explained in detail later on.

```
root[] TGeoMaterial *mat = new TGeoMaterial("Vacuum",0,0,0);
root[] TGeoMedium   *med = new TGeoMedium("Vacuum",1,mat);
```

We can finally make our volume having a box shape. Note that the world volume does not need to be a box - it can be any other shape. Generally, boxes and tubes are the most recommendable shapes for this purpose due to their fast navigation algorithms.

```
root[] TGeoVolume *top=gGeoManager->MakeBox("Top",med,10.,10.,10.);
```

The default units are in centimeters. Now we want to make this volume our world. We have to do this operation **before** closing the geometry.

```
root[] gGeoManager->SetTopVolume(top);
```

This should be enough, but it is not since always after defining some geometry hierarchy, **TGeo** needs to build some optimization structures and perform some checks. Note the messages posted after the statement is executed. We will describe the corresponding operations later.

```
root[] gGeoManager->CloseGeometry();
```

Now we are really done with geometry building stage, but we would like to see our simple world:

```
root[] top->SetLineColor(kMagenta);
root[] gGeoManager->SetTopVisible(); // the TOP is invisible
root[] top->Draw();
```

### 18.1.2 Example 2: A Geometrical Hierarchy Look and Feel

Before going further, let us get a look and feel of interacting with the modeller. For this, we will use one of the examples illustrating the geometry package. To get an idea on the geometry structure created in this example, just look at the link: <http://root.cern.ch/root/html/tutorials/geom/rootgeom.C.html>. You will notice that this is a bit more complex than just creating the “world” since several other volumes are created and put together in a hierarchy. The purpose here is just to learn how to interact with a geometry that is already built, but just few hints on the building steps in this example might be useful. The geometry here represents the word **ROOT** that is replicated in some symmetric manner. You might for instance ask some questions after having a first look:

**Q:** *"OK, I understand the first lines that load the libGeom library and create a geometry manager object. I also recognize from the previous example the following lines creating some materials and media, but what about the geometrical transformations below?"*

**A:** As explained before, the model that we are trying to create is a hierarchy of volumes based on **containment**. This is accomplished by **positioning** some volumes **inside** others. Any volume is an un-positioned object in the sense that it defines only a **local frame** (matching the one of its **shape**). In order to fully define the mother-daughter relationship between two volumes one has to specify how the daughter will be positioned inside. This is accomplished by defining a **local geometrical transformation** of the daughter with respect to the mother coordinate system. These transformations will be subsequently used in the example.

**Q:** *"I see the lines defining the top level volume as in the previous example, but what about the other volumes named REPLICIA and ROOT?"*

**A:** You will also notice that several other volumes are created by using lines like:

```
TGeoVolume *someVolume = gGeoManager->MakeXXX("someName",
ptrMedium, /* parameters coresponding to XXX ...*/)
```

In the method above **XXX** represent some shape name (Box, Tube, etc.). This is just a simple way of creating a volume having a given shape in one-step (see also section: “Creating and Positioning Volumes”). As for **REPLICA** and **ROOT** volumes, they are just some *virtual volumes\* used for grouping and positioning together other real volumes\**. See “Positioned Volumes (Nodes)”. The same structure represented by (a real or) a virtual volume can be **replicated** several times in the geometry.

**Q:** *"Fine, so probably the real volumes are the ones composing the letters R, O and T. Why one have to define so many volumes to make an R?"*

**A:** Well, in real life some objects have much more complex shapes than an **R**. The modeller cannot just know all of them; the idea is to make a complex object by using elementary building blocks that have known shapes (called **primitive shapes**). Gluing these together in the appropriate way is the user responsibility.

**Q:** *"I am getting the global picture but not making much out of it... There are also a lot of calls to TGeoVolume::AddNode() that I do not understand."*

**A:** A volume is positioned inside another one by using this method. The relative geometrical transformation as well as a copy number must be specified. When positioned, a volume becomes a **node** of its container and a new object of the class **TGeoNode** is automatically created. This method is therefore the key element for the creation of a hierarchical link between two volumes. As it will be described further on in this document, there are few other methods performing similar actions, but let us keep things simple for the time being. In addition, notice that there are some visualization-related calls in the example followed by a final **TGeoVolume::Draw()** call for the top volume. These are explained in details in the section “Visualization Settings and Attributes”. At this point, you will probably like to see how this geometry looks like. You just need to run the example and you will get the following picture that you can rotate using the mouse; or you can zoom / move it around (see what the Help menu of the GL window displays).

```
% root rootgeom.C
```

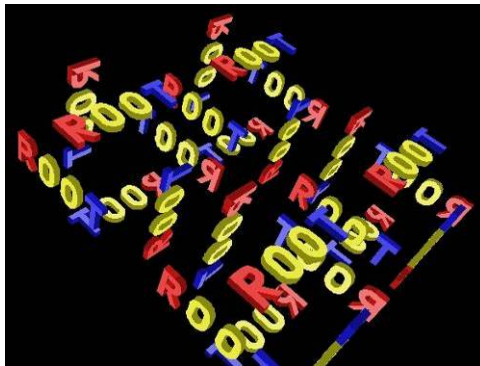

Now let us browse the hierarchy that was just created. Start a browser and double-click on the item `simple1` representing the **gGeoManager** object. Note that right click opens the context menu of the manager class where several global methods are available.

```
root[] new TBrowser;
```

The folders **Materials**, **Media** and **Local transformations** are in fact the containers where the geometry manager stores the corresponding objects. The **Illegal overlaps** folder is empty but can be filled after performing a geometry validity check (see section: “Checking the Geometry”). If tracking is performed using **TGeo**, the folder **Tracks** might contain user-defined tracks that can be visualized/animated in the geometry context (see section: “Creating and Visualizing Tracks”). Since for the time being we are interested more in the geometrical hierarchy, we will focus on the last two displayed items **TOPand** and **TOP\_1**. These are the top volume and the corresponding top node in the hierarchy.

Double clicking on the **TOP** volume will unfold all different volumes contained by the top volume. In the right panel, we will see all the volumes contained by **TOP** (if the same is positioned 4 times we will get 4 identical items). This rule will apply to any clicked volume in the hierarchy. Note that right clicking a volume item activates the volume context menu containing several specific methods. We will call the volume hierarchy developed in this way as the **logical geometry graph**. The volume objects are nodes inside this graph and the same volume can be accessed starting from different branches.

On the other hand, the real geometrical objects that are seen when visualizing or tracking the geometry are depicted in the **TOP\_1** branch. These are the nodes of the **physical tree** of positioned volumes represented by **TGeoNode** objects.

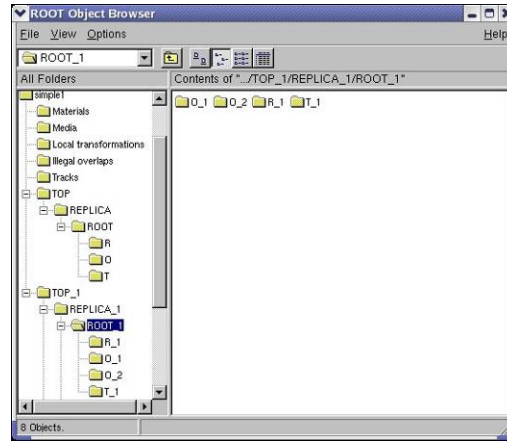

This hierarchy is a tree since a node can have only one parent and several daughters. For a better understanding of the hierarchy, have a look at <http://root.cern.ch/root/html/doc/TGeoManager.html>.

Just close now the X3D window and focus at the wire frame picture drawn in a pad. Activate Options/Event Status. Moving the mouse in the pad, you will notice that objects are sometimes changing color to red. Volumes are highlighted in this way whenever the mouse pointer is close enough to one of its vertices. When this happens, the corresponding volume is selected and you will see in the bottom right size of the ROOT canvas its name, shape type and corresponding path in the physical tree. Right clicking on the screen when a volume is selected will also open its context menu (picking). Note that there are several actions that can be performed both at view (no volume selected) and volume level.

**TView** (mouse not selecting any volume):

- Click-and-drag rotates the view.
- Pressing some keys perform different actions:
- J/K - zoom / unzoom
- H, L, U, I - move the viewpoint
- Right click + `SetParallel ()`/`SetPerspective ()` - switch from parallel to perspective view.
- Right click + `ShowAxis()` - show coordinate axes.
- Right click + `Centered/Left/Side/Top` - change view direction.

**TGeoVolume** (mouse selecting a volume):

- Double click will focus the corresponding volume.
- Right click + `CheckOverlaps()` - run overlap checker on current volume.
- Right click + `Draw ()` - draw that volume according current global visualization options
- Right click + `DrawOnly()` - draw only the selected volume.
- Right click + `InspectShape/Material()` - print info about shape or material.
- Right click + `Raytrace()` - initiate a ray tracing algorithm on current view.
- Right click + `RandomPoints/Rays()` - shoot random points or rays inside the bounding box of the clicked volume and display only those inside visible volumes.
- Right click + `Weight()` - estimates the weight of a volume within a given precision.

Note that there are several additional methods for visibility and line attributes settings.

## 18.2 Materials and Tracking Media

We have mentioned that volumes are the building blocks for geometry, but they describe real objects having well defined properties. In fact, there are just two of them: the material they are made from and their geometrical **shape**. These have to be created before creating the volume itself, so we will describe the bits and pieces needed for making the geometry before moving to an architectural point of view.

As far as materials are concerned, they represent the physical properties of the solid from which a volume is made. Materials are just a support for the data that has to be provided to the tracking engine that uses this geometry package. Due to this fact, the `TGeoMaterial` class is more like a thin data structure needed for building the corresponding native materials of the Monte-Carlo tracking code that uses `TGeo`.

### 18.2.1 Elements, Materials and Mixtures

In order to make easier material and mixture creation, one can use the pre-built table of elements owned by `TGeoManager` class:

```
TGeoElementTable *table = gGeoManager->GetElementTable();
TGeoElement *element1 = table->GetElement(Int_t Z);
TGeoElement *element2 = table->FindElement("Copper");
```

Materials made of single elements can be defined by their atomic mass (A), charge (Z) and density (rho). One can also create a material by specifying the element that it is made of. Optionally the radiation and absorption lengths can be also provided; otherwise they can be computed on-demand [G3]. The class representing them is `TGeoMaterial`:

```
TGeoMaterial(const char *name, Double_t a, Double_t z,
             Double_t density, Double_t radlen=0, Double_t intlen=0);
TGeoMaterial(const char *name, TGeoElement *elem,
             Double_t density);
TGeoMaterial(const char* name, Double_t a, Double_t z,
             Double_t rho,
             TGeoMaterial::EGeoMaterialState state,
             Double_t temperature = STP_temperature,
             Double_t pressure = STP_pressure)
```

Any material or derived class is automatically indexed after creation. The assigned index is corresponding to the last entry in the list of materials owned by `TGeoManager` class. This can be changed using the `TGeoMaterial::SetIndex()` method, however it is not recommended while using the geometry package interfaced with a transport MC. Radiation and absorption lengths can be set using:

```
TGeoMaterial::SetRadLen(Double_t radlen, Double_t intlen);
```

- `radlen`: radiation length. If `radlen<=0` the value is computed using GSMATE algorithm in GEANT3
- `intlen`: absorption length

Material state, temperature and pressure can be changed via setters. Another material property is transparency. It can be defined and used while viewing the geometry with OpenGL.

```
void SetTransparency (Char_t transparency = 0)
```

- `transparency`: between 0 (opaque default) to 100 (fully transparent)

One can attach to a material a user-defined object storing Cerenkov properties. Another hook for material shading properties is currently not in use. Mixtures are materials made of several elements. They are represented by the class `TGeoMixture`, deriving from `TGeoMaterial` and defined by their number of components and the density:

```
TGeoMixture(const char *name, Int_t nel, Double_t rho);
```

Elements have to be further defined one by one:

```

void TGeoMixture::DefineElement(Int_t iel, Double_t a, Double_t z,
    Double_t weight);
void TGeoMixture::DefineElement(Int_t iel, TGeoElement *elem,
    Double_t weight);
void TGeoMixture::DefineElement(Int_t iel, Int_t z, Int_t natoms);

```

or:

```

void AddElement(TGeoMaterial* mat, Double_t weight);
void AddElement(TGeoElement* elem, Double_t weight);
void AddElement(TGeoElement* elem, Int_t natoms);
void AddElement(Double_t a, Double_t z, Double_t weight)

```

- `iel`: index of the element [0,nel-1]
- `a` and `z`: the atomic mass and charge
- `weight`: proportion by mass of the elements
- `natoms`: number of atoms of the element in the molecule making the mixture

The radiation length is automatically computed when all elements are defined. Since tracking MC provide several other ways to create materials/mixtures, the materials classes are likely to evolve as the interfaces to these engines are being developed. Generally in the process of tracking material properties are not enough and more specific media properties have to be defined. These highly depend on the MC performing tracking and sometimes allow the definition of different media properties (e.g. energy or range cuts) for the same material.

## 18.2.2 Radionuclides

A new class **TGeoElementRN** was introduced in this version to provide support for radioactive nuclides and their decays. A database of 3162 radionuclides can be loaded on demand via the table of elements (**TGeoElementTable** class). One can make then materials/mixtures based on these radionuclides and use them in a geometry

```

root[] TGeoManager *geom = new TGeoManager("geom","radionuclides");
root[] TGeoElementTable *table = geom->GetElementTable();
root[] TGeoElementRN *c14 = table->GetElementRN(14,6); // A,Z
root[] c14->Print();
6-C-014 ENDF=60140; A=14; Z=6; Iso=0; Level=0 [MeV]; Dmass=3.0199 [MeV];
Hlife=1.81e+11 [s] J/P=0+; Abund=0; Htox=5.8e-10; Itox=5.8e-10; Stat=0
Decay modes:
BetaMinus          Diso:    0 BR:   100.000% Qval: 0.1565

```

One can make materials or mixtures from radionuclides:

```

root[] TGeoMaterial *mat = new TGeoMaterial("C14", c14, 2.0);

```

The following properties of radionuclides can be currently accessed via getters in the **TGeoElementRN** class:

Atomic number and charge (from the base class **TGeoElement**)

- Isomeric number (ISO)
- ENDF code - following the convention: ENDF=10000\*Z+100\*A+ISO
- Isomeric energy level [MeV]
- Mass excess [MeV]
- Half life [s]
- Spin/Parity - can be retrieved with: **TGeoElementRN::GetTitle()**
- Hynalation and ingestion toxicities
- List of decays - **TGeoElementRN::GetDecays()**

The radioactive decays of a radionuclide are represented by the class `TGeoDecayChannel` and they are stored in a `TObjArray`. Decay provides:

- Decay mode
- Variation of isomeric number
- Q value for the decay [GeV]
- Parent element
- Daughter element

Radionuclides are linked one to each other via their decays, until the last element in the decay chain which must be stable. One can iterate decay chains using the iterator `TGeoElemIter`:

```
root[] TGeoElemIter next(c14);
root[] TGeoElementRN *elem;
root[] while ((elem=next()) next.Print());
6-C-014 (100% BetaMinus) T1/2=1.81e+11
7-N-014 stable
```

To create a radioactive material based on a radionuclide, one should use the constructor:

```
TGeoMaterial(const char *name, TGeoElement *elem, Double_t density)
```

To create a radioactive mixture, one can use radionuclides as well as stable elements:

```
TGeoMixture(const char *name, Int_t nelements, Double_t density);
TGeoMixture::AddElement(TGeoElement *elem,
    Double_t weight_fraction);
```

Once defined, one can retrieve the time evolution for the radioactive materials/mixtures by using one of the next two methods:

1. `TGeoMaterial::FillMaterialEvolution(TObjArray *population, Double_t precision=0.001)`

To use this method, one has to provide an empty `TObjArray` object that will be filled with all elements coming from the decay chain of the initial radionuclides contained by the material/mixture. The precision represent the cumulative branching ratio for which decay products are still considered.

The population list may contain stable elements as well as radionuclides, depending on the initial elements. To test if an element is a radionuclide:

```
Bool_t TGeoElement::IsRadioNuclide() const
```

All radionuclides in the output population list have attached objects that represent the time evolution of their fraction of nuclei with respect to the top radionuclide in the decay chain. These objects (Bateman solutions) can be retrieved and drawn:

```
TGeoBatemanSol *TGeoElementRN::Ratio();
void TGeoBatemanSol::Draw();
```

Another method allows to create the evolution of a given radioactive material/mixture at a given moment in time:

2. `TGeoMaterial::DecayMaterial(Double_t time, Double_t precision=0.001)`

The method will create the mixture that result from the decay of a initial material/mixture at time, while all resulting elements having a fractional weight less than precision are excluded.

A demo macro for radioactive material features is `$ROOTSYS/tutorials/geom/RadioNuclides.C` It demonstrates also the decay of a mixture made of radionuclides.



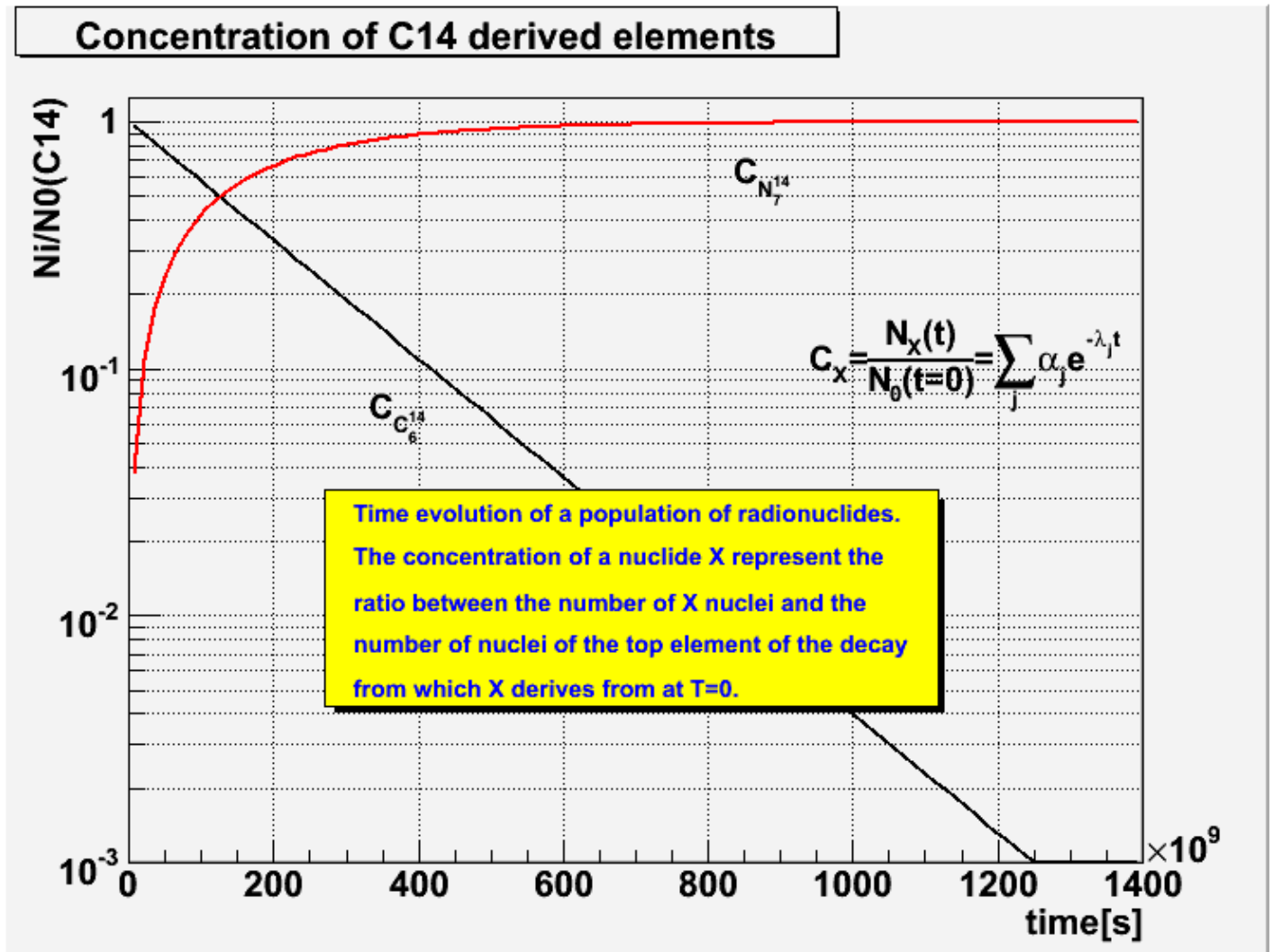

Figure 18.1: Concentration of C14 derived elements



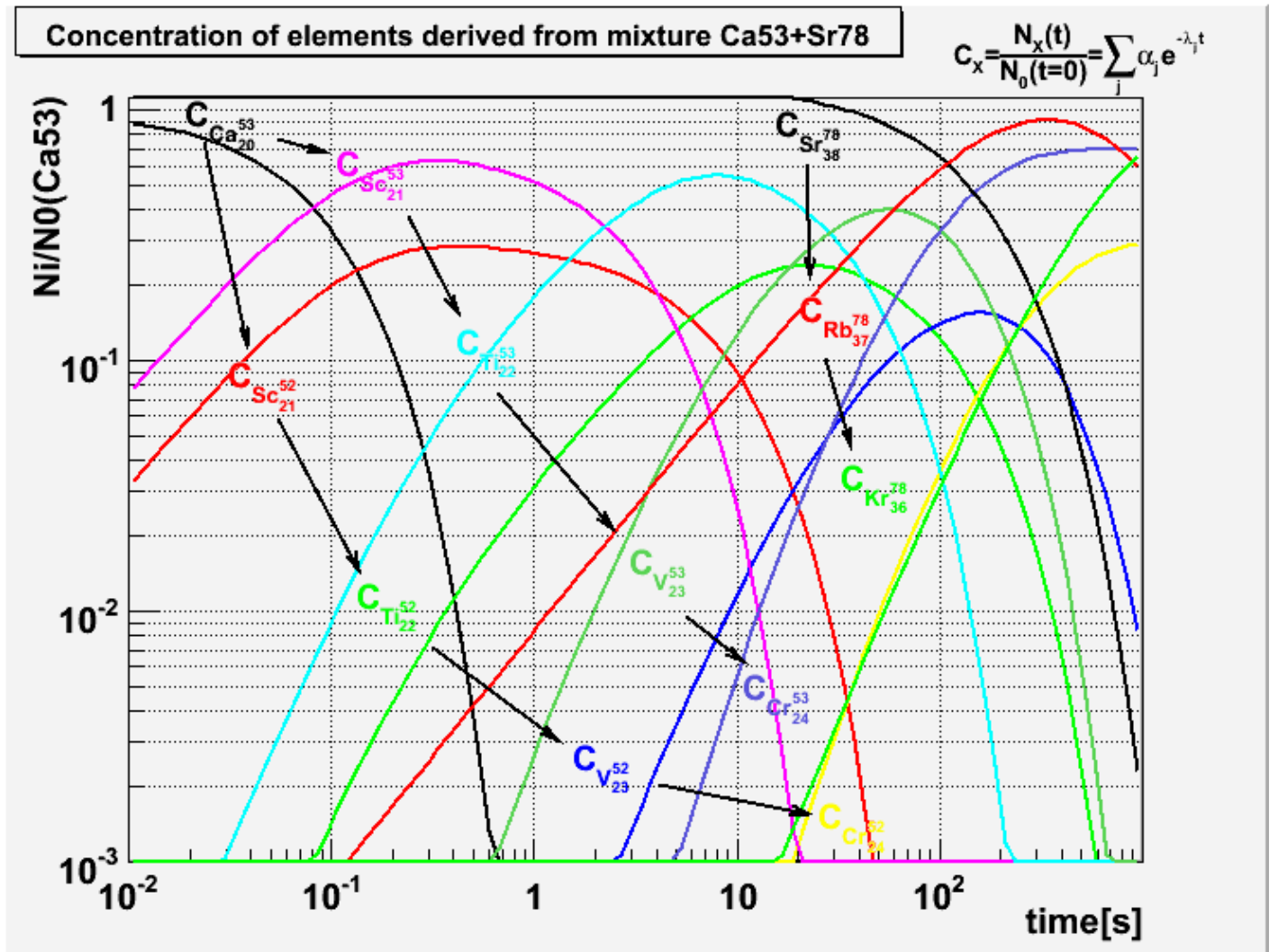

Figure 18.2: Concentration of elements derived from Ca53+Sr78

### 18.2.3 Tracking Media

The class `TGeoMedium` describes tracking media properties. This has a pointer to a material and the additional data members representing the properties related to tracking.

```
TGeoMedium(const char *name, Int_t numed, TGeoMaterial *mat,
           Double_t *params=0);
```

- `name`: name assigned to the medium
- `mat`: pointer to a material
- `params`: array of additional parameters

Another constructor allows effectively defining tracking parameters in GEANT3 style:

```
TGeoMedium(const char *name, Int_t numed, Int_t imat, Int_t ifield,
           Double_t fieldm, Double_t tmaxfd, Double_t stemax,
           Double_t deemax, Double_t epsil, Double_t stmin);
```

This constructor is reserved for creating tracking media from the VMC interface [...]:

- `numed`: user-defined medium index
- `imat`: unique ID of the material
- `others`: see G3 documentation

Looking at our simple world example, one can see that for creating volumes one needs to create tracking media before. The way to proceed for those not interested in performing tracking with external MC's is to define and use only one **dummy tracking medium** as in the example (or a NULL pointer).

### 18.2.4 User Interface for Handling Materials and Media

The `TGeoManager` class contains the API for accessing and handling defined materials:

```
TGeoManager::GetMaterial(name);
```

## 18.3 Shapes

Shapes are geometrical objects that provide the basic modeling functionality. They provide the definition of the **local** coordinate system of the volume. Any volume must have a shape. Any shape recognized by the modeller has to derive from the base `TGeoShape` class, providing methods for:

- Finding out if a point defined in their local frame is contained or not by the shape;
- Computing the distance to enter/exit the shape from a local point, given a known direction;
- Computing the maximum distance in any direction from a local point that does NOT result in a boundary crossing of the shape (safe distance);
- Computing the cosines of the normal vector to the crossed shape surface, given a starting local point and an ongoing direction.

All the features above are globally managed by the modeller in order to provide navigation functionality. In addition to those, shapes have also to implement additional specific abstract methods:

- Computation of the minimal box bounding the shape, given that this box have to be aligned with the local coordinates;
- Algorithms for dividing the shape along a given axis.

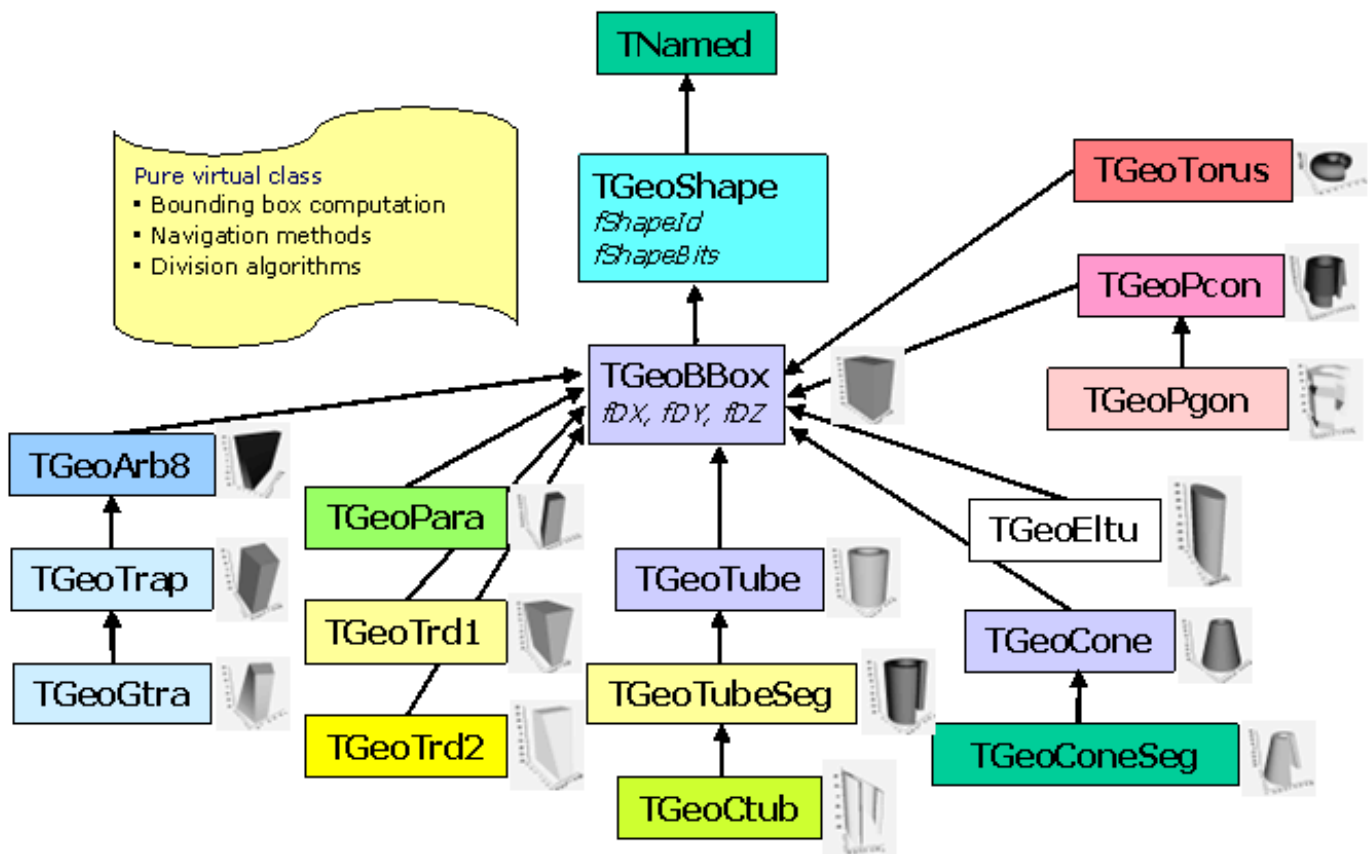

Figure 18.3: Primitive Shapes - the general inheritance scheme

The modeller currently provides a set of 20 basic shapes, which we will call **primitives**. It also provides a special class allowing the creation of shapes as a result of Boolean operations between primitives. These are called **composite shapes** and the composition operation can be recursive (combined composites). This allows the creation of a quite large number of different shape topologies and combinations. You can have a look and run the tutorial: <http://root.cern.ch/root/html/examples/geodemo.C.html>

Shapes are named objects and all primitives have constructors like:

```
TGeoXXX(const char *name,<type> param1,<type> param2, ...);
TGeoXXX(<type> param1,<type> param2, ...);
```

Naming shape primitive is mandatory only for the primitives used in Boolean composites (see “Composite Shapes”). For the sake of simplicity, we will describe only the constructors in the second form.

### 18.3.1 Units

The length units used in the geometry are **arbitrary**. However, there are certain functionalities that work with the assumption that the used lengths are expressed in centimeters. This is the case for shape capacity or volume weight computation. The same is valid when using the ROOT geometry as navigator for an external transport MC package (e.g. GEANT) via the VMC interface.

Other units in use: All angles used for defining rotation matrices or some shape parameters are expressed in **degrees**. Material density is expressed in [g/cm<sup>3</sup>].

### 18.3.2 Primitive Shapes

#### 18.3.2.1 Boxes - TGeoBBox Class

Normally a box has to be build only with 3 parameters: **DX,DY,DZ** representing the half-lengths on X, Y and Z-axes. In this case, the origin of the box will match the one of its reference frame and the box will range from: **-DX** to **DX** on X-axis, from **-DY** to **DY** on Y and from **-DZ** to **DZ** on Z. On the other hand, any other shape needs to compute and store the parameters of their minimal bounding box. The bounding boxes are essential to optimize navigation algorithms. Therefore all other primitives derive from **TGeoBBox**. Since the minimal bounding box is not necessary centered in the origin, any box allows an origin translation (**Ox,Oy,Oz**). All primitive constructors automatically compute the bounding box parameters. Users should be aware that building a translated box that will represent a primitive shape by itself would affect any further positioning of other shapes inside. Therefore it is highly recommendable to build non-translated boxes as primitives and translate/rotate their corresponding volumes only during positioning stage.

```
TGeoBBox(Double_t dx,Double_t dy,Double_t dz,Double_t *origin=0);
```

#### 18.3.2.2 Parallelepiped - TGeoPara class

A parallelepiped is a shape having 3 pairs of parallel faces out of which one is parallel with the XY plane (Z faces). All faces are parallelograms in the general case. The Z faces have 2 edges parallel with the X-axis.

The shape has the center in the origin and it is defined by:

- **dX, dY, dZ**: half-lengths of the projections of the edges on X, Y and Z. The lower Z face is positioned at **-dZ**, while the upper at **+dZ**.
- **alpha**: angle between the segment defined by the centers of the X-parallel edges and Y axis [-90,90] in degrees
- **theta**: theta angle of the segment defined by the centers of the Z faces;
- **phi**: phi angle of the same segment

```
TGeoPara(dX,dY,dZ,alpha,theta,phi);
```

A box is a particular parallelepiped having the parameters: (dX,dY,dZ,0.,0.,0.).

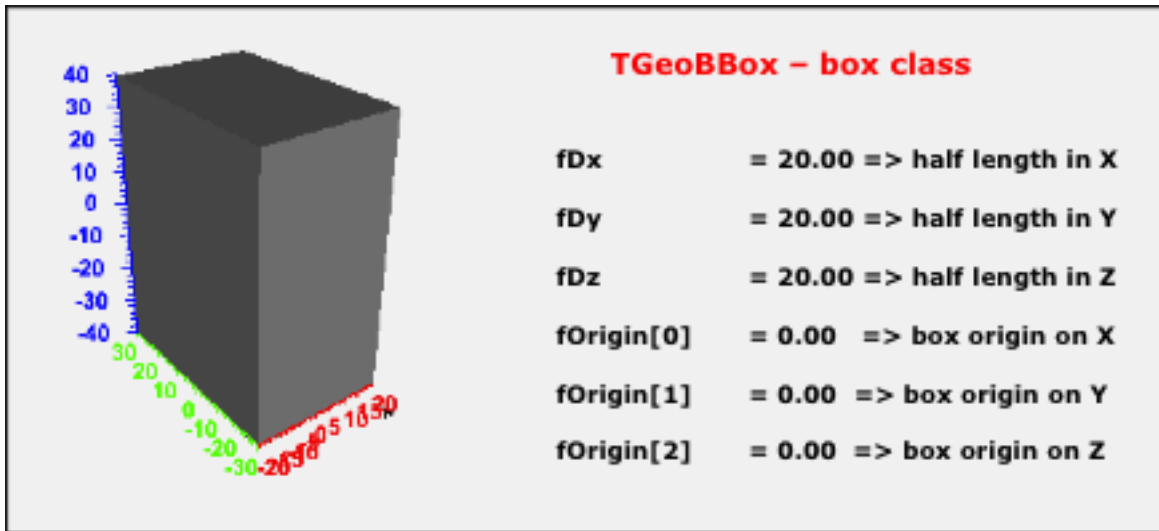

Figure 18.4: TGeoBBox class

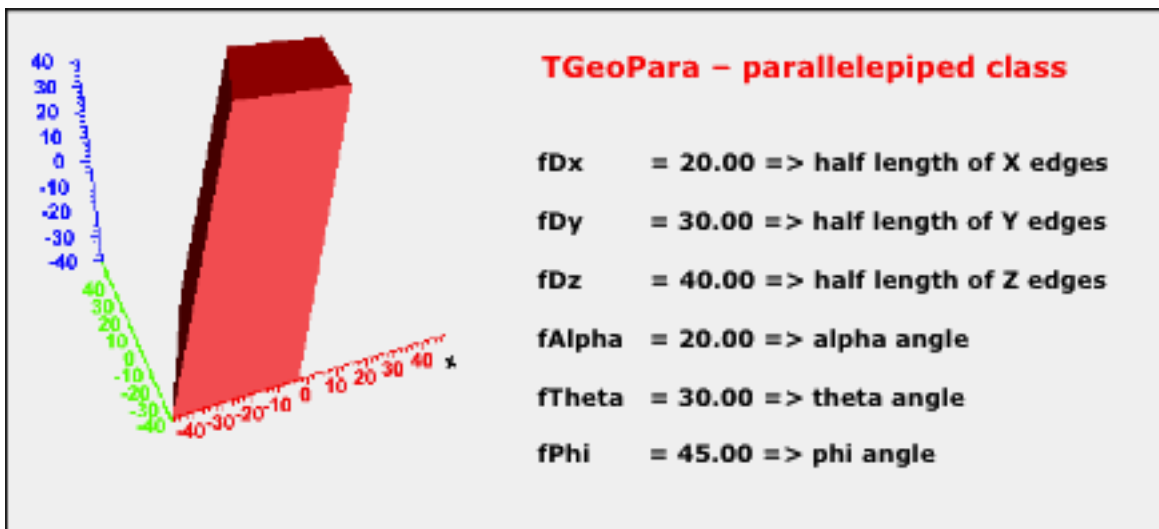

Figure 18.5: TGeoPara class

### 18.3.2.3 Trapezoids

In general, we will call trapezoidal shapes having 8 vertices and up to 6 trapezoid faces. Besides that, two of the opposite faces are parallel to XY plane and are positioned at  $dZ$ . Since general trapezoids are seldom used in detector geometry descriptions, there are several primitives implemented in the modeller for particular cases.

`Trd1` is a trapezoid with only X varying with Z. It is defined by the half-length in Z, the half-length in X at the lowest and highest Z planes and the half-length in Y:

```
TGeoTrd1(Double_t dx1,Double_t dx2,Double_t dy,Double_t dz);
```

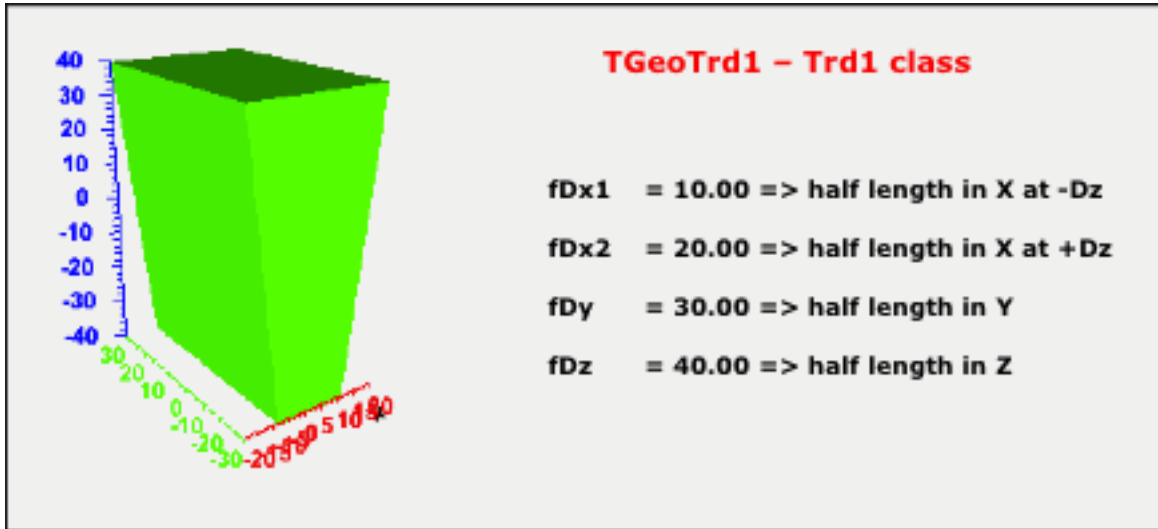

Figure 18.6: TGeoTrd1 class

`Trd2` is a trapezoid with both X and Y varying with Z. It is defined by the half-length in Z, the half-length in X at the lowest and highest Z planes and the half-length in Y at these planes:

```
TGeoTrd2(Double_t dx1,Double_t dx2,Double_t dy1,Double_t dy2, Double_t dz);
```

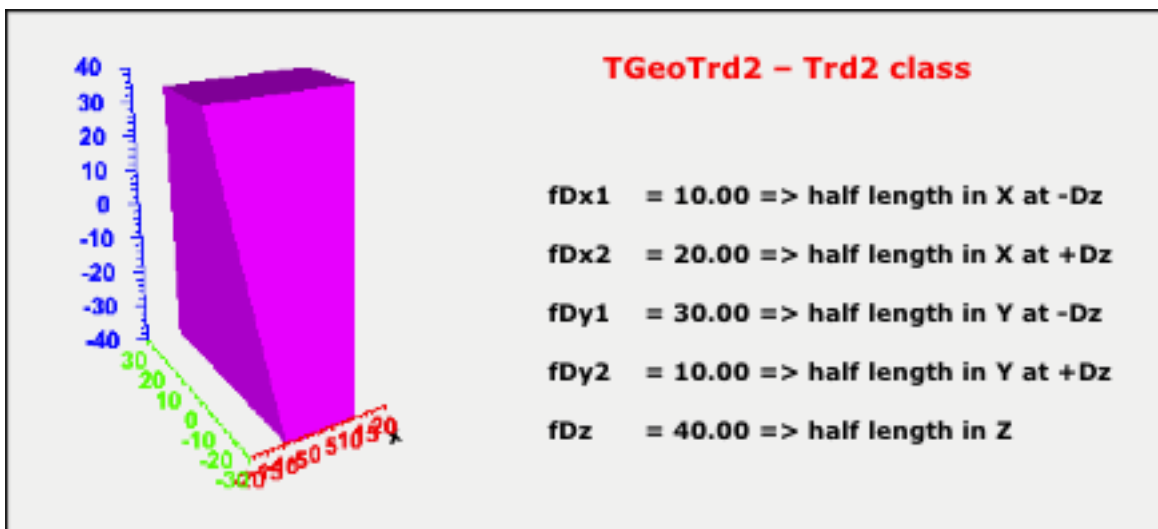

Figure 18.7: TGeoTrd2 class

### 18.3.2.4 General Trapezoid - TGeoTrap Class

A general trapezoid is one for which the faces perpendicular to  $z$  are trapezes but their centers are not necessary at the same  $x, y$  coordinates.

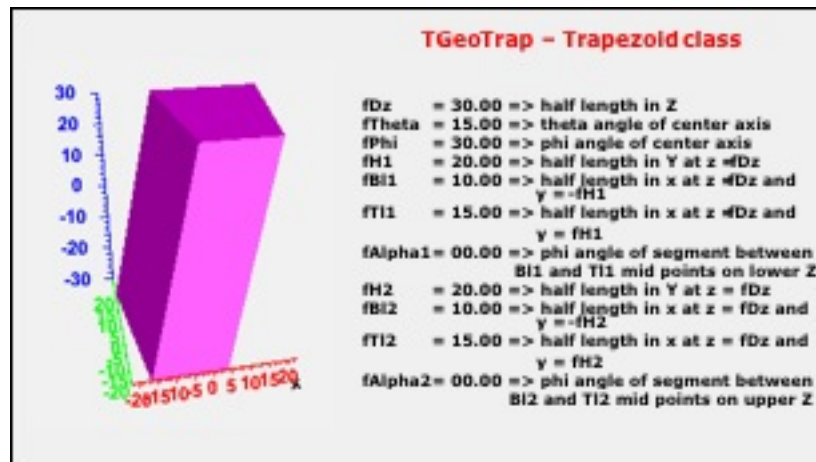

Figure 18.8: TGeoTrap Class

It has eleven parameters: the half length in  $z$ , the polar angles from the center of the face at low  $z$  to that at high  $z$ ,  $H1$  the half length in  $y$  at low  $z$ ,  $LB1$  the half length in  $x$  at low  $z$  and  $y$  low edge,  $LB2$  the half length in  $x$  at low  $z$  and  $y$  high edge,  $TH1$  the angle with respect to the  $y$  axis from the center of low  $y$  edge to the center of the high  $y$  edge, and  $H2, LB2, LH2, TH2$ , the corresponding quantities at high  $z$ .

```
TGeoTrap(Double_t dz,Double_t theta,Double_t phi,
Double_t h1,Double_t b11,Double_t t11,Double_t alpha1,
Double_t h2,Double_t b12,Double_t t12,Double_t alpha2);
```

### 18.3.2.5 Twisted Trapezoid - TGeoGtra class

A twisted trapezoid is a general trapezoid defined in the same way but that is twisted along the  $Z$ -axis. The twist is defined as the rotation angle between the lower and the higher  $Z$  faces.

```
TGeoGtra(Double_t dz,Double_t theta,Double_t phi,Double_t twist,
Double_t h1,Double_t b11,Double_t t11,Double_t alpha1,
Double_t h2,Double_t b12,Double_t t12,Double_t alpha2 );
```

### 18.3.2.6 Arbitrary 8 vertices shapes - TGeoArb8 class

An **Arb8** is defined by two quadrilaterals sitting on parallel planes, at  $dZ$ . These are defined each by 4 vertices having the coordinates  $(X_i, Y_i, +/-dZ), i=0,3$ . The lateral surface of the **Arb8** is defined by the 4 pairs of edges corresponding to vertices  $(i, i+1)$  on both  $-dZ$  and  $+dZ$ . If  $M$  and  $M'$  are the middles of the segments  $(i, i+1)$  at  $-dZ$  and  $+dZ$ , a lateral surface is obtained by sweeping the edge at  $-dZ$  along  $MM'$  so that it will match the corresponding one at  $+dZ$ . Since the points defining the edges are arbitrary, the lateral surfaces are not necessary planes - but twisted planes having a twist angle linear-dependent on  $Z$ .

```
TGeoArb8::TGeoArb8(Double_t dz,Double_t ivert);
```

- $dz$ : half-length in  $Z$ ;
- $ivert = [0,7]$

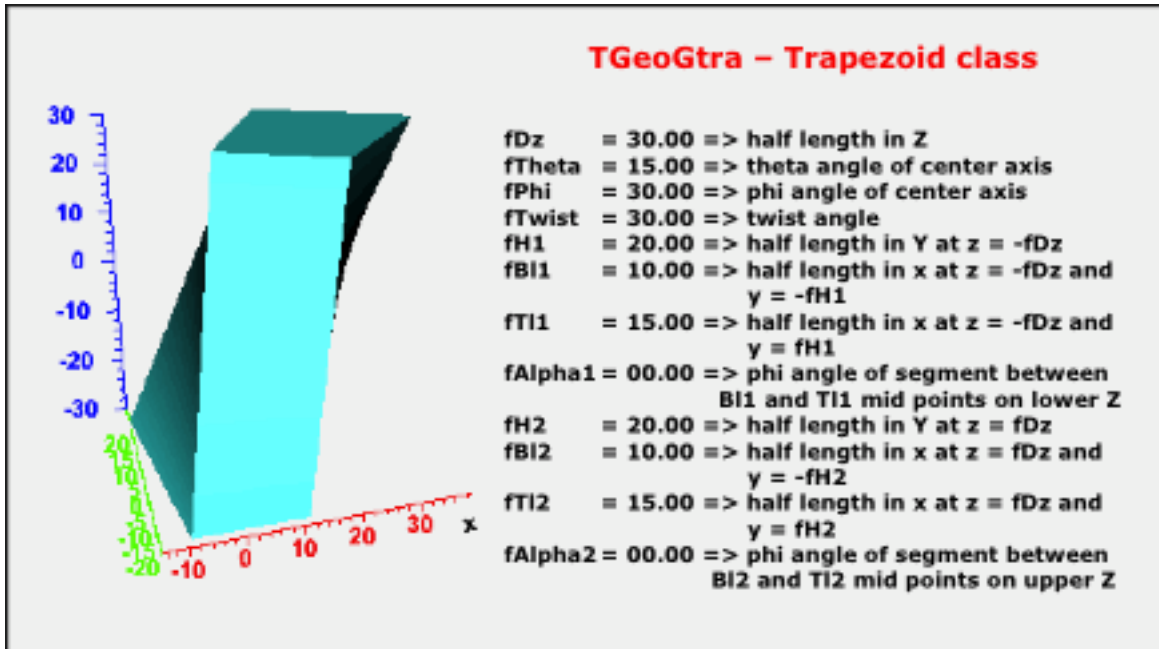

Figure 18.9: TGeoGtra class

Vertices have to be defined clockwise in the XY pane, both at  $+dz$  and  $-dz$ . The quadrilateral at  $-dz$  is defined by indices [0,3], whereas the one at  $+dz$  by vertices [4,7]. The vertex with `index=7` has to be defined last, since it triggers the computation of the bounding box of the shape. Any two or more vertices in each Z plane can have the same (X,Y) coordinates. In this case, the top and bottom quadrilaterals become triangles, segments or points. The lateral surfaces are not necessarily defined by a pair of segments, but by pair segment-point (making a triangle) or point-point (making a line). Any choice is valid as long as at one of the end-caps is at least a triangle.

### 18.3.2.7 Tubes - TGeoTube Class

Tubes have Z as their symmetry axis. They have a range in Z, a minimum and a maximum radius:

```
TGeoTube(Double_t rmin,Double_t rmax,Double_t dz);
```

The full Z range is from  $-dz$  to  $+dz$ .

### 18.3.2.8 Tube Segments - TGeoTubeSeg Class

A tube segment is a tube having a range in phi. The tube segment class derives from **TGeoTube**, having 2 extra parameters: `phi1` and `phi2`.

```
TGeoTubeSeg(Double_t rmin,Double_t rmax,Double_t dz,  
Double_t phi1,Double_t phi2);
```

Here `phi1` and `phi2` are the starting and ending phi values in degrees. The general phi convention is that the shape ranges from `phi1` to `phi2` going counterclockwise. The angles can be defined with either negative or positive values. They are stored such that `phi1` is converted to  $[0,360]$  and `phi2 > phi1`.

### 18.3.2.9 Cut Tubes - TGeoCutub Class

The cut tubes constructor has the form:



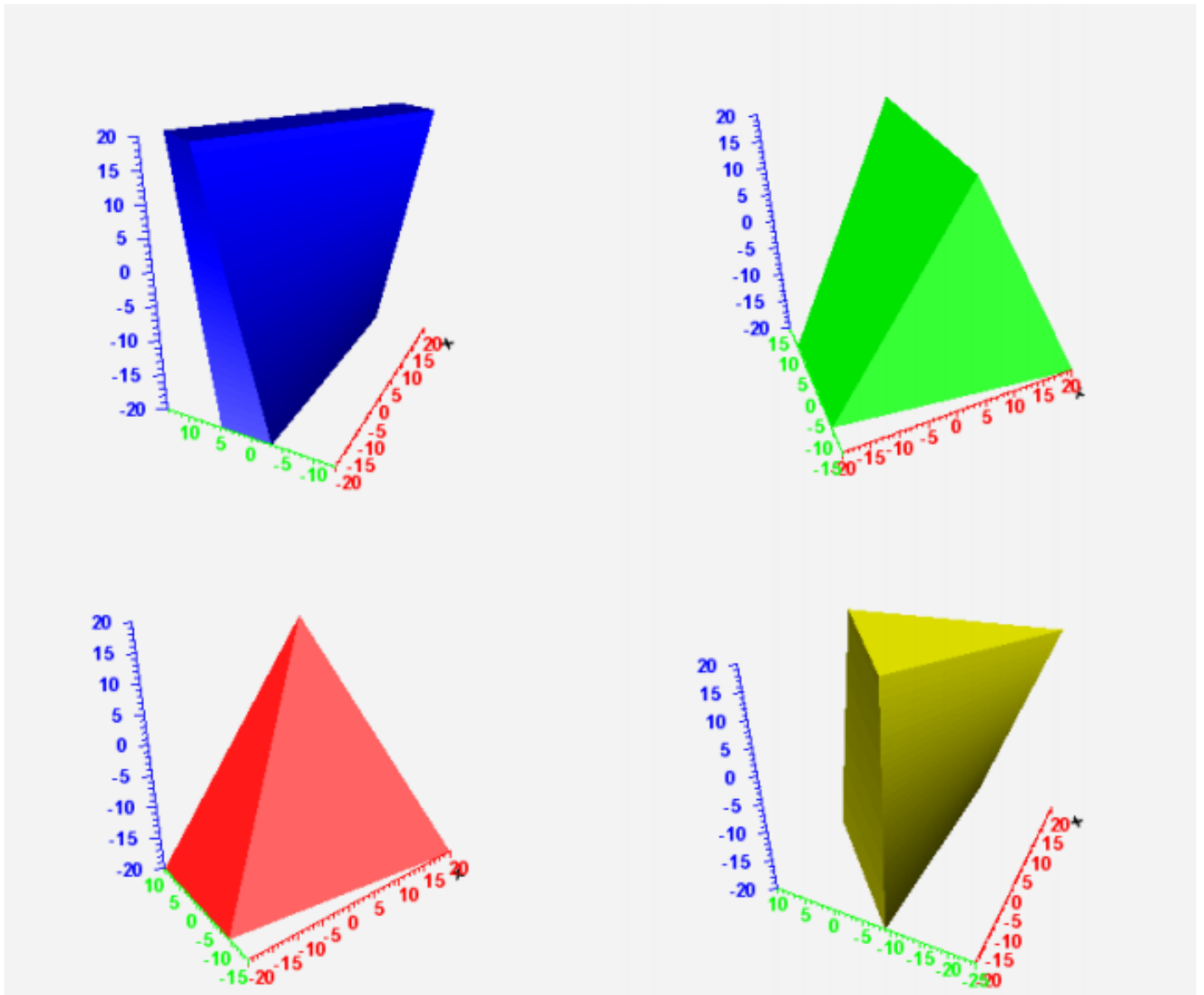

Figure 18.10: TGeoArb8 class

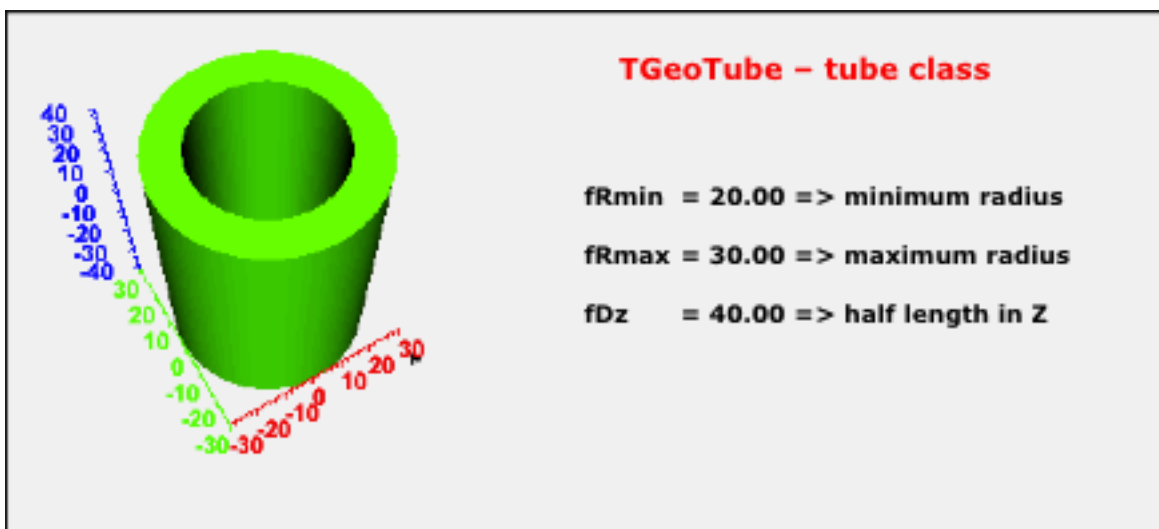

Figure 18.11: TGeoTube Class

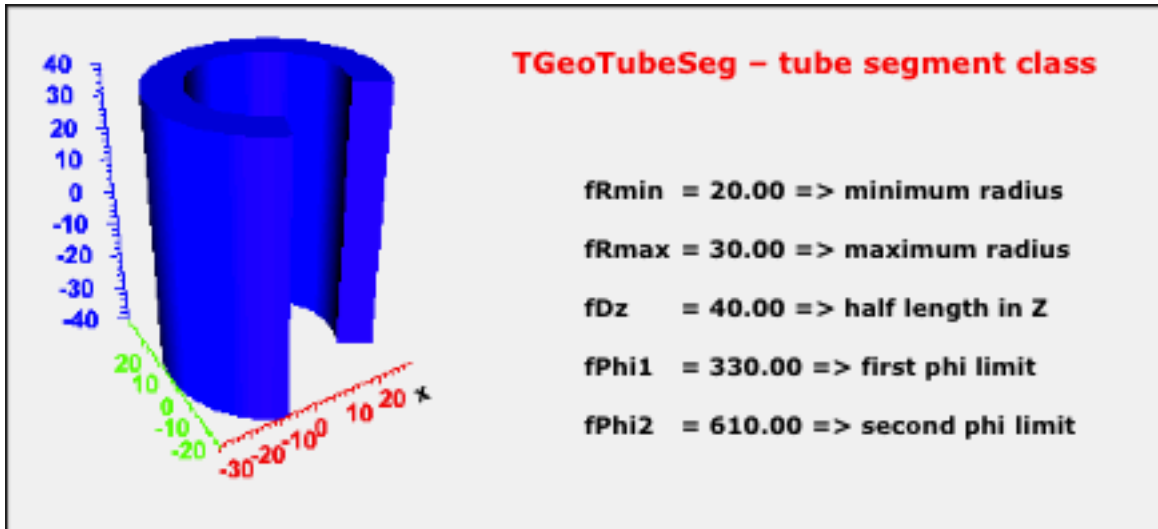

Figure 18.12: TGeoTubeSeg Class

```
TGeoCtub(Double_t rmin,Double_t rmax,Double_t dz,
Double_t phi1,Double_t phi2,
Double_t nxlow,Double_t nylow,Double_t nzlow, Double_t nxhi,
Double_t nyhi,Double_t nzhi);
```

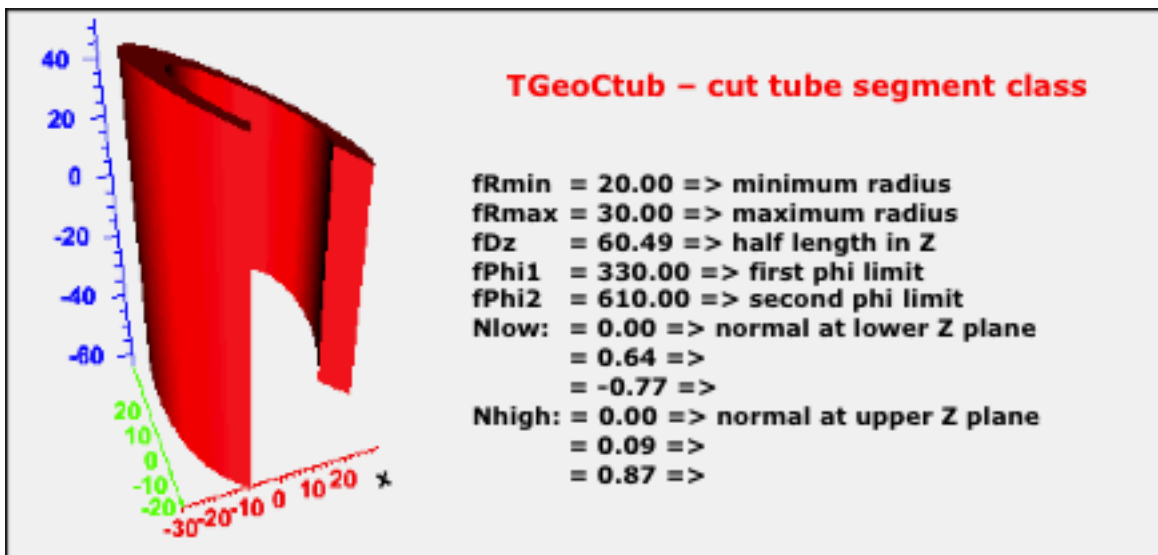

Figure 18.13: TGeoCtub Class

A cut tube is a tube segment cut with two planes. The centers of the 2 sections are positioned at  $dZ$ . Each cut plane is therefore defined by a point  $(0,0,dZ)$  and its normal unit vector pointing outside the shape:

$N_{low}=(N_x,N_y,N_z<0)$ ,  $N_{high}=(N_x',N_y',N_z'>0)$ .

### 18.3.2.10 Elliptical Tubes - TGeoEltu Class

An elliptical tube is defined by the two semi-axes  $A$  and  $B$ . It ranges from  $-dZ$  to  $+dZ$  as all other tubes:

```
TGeoEltu(Double_t a,Double_t b,Double_t dz);
```

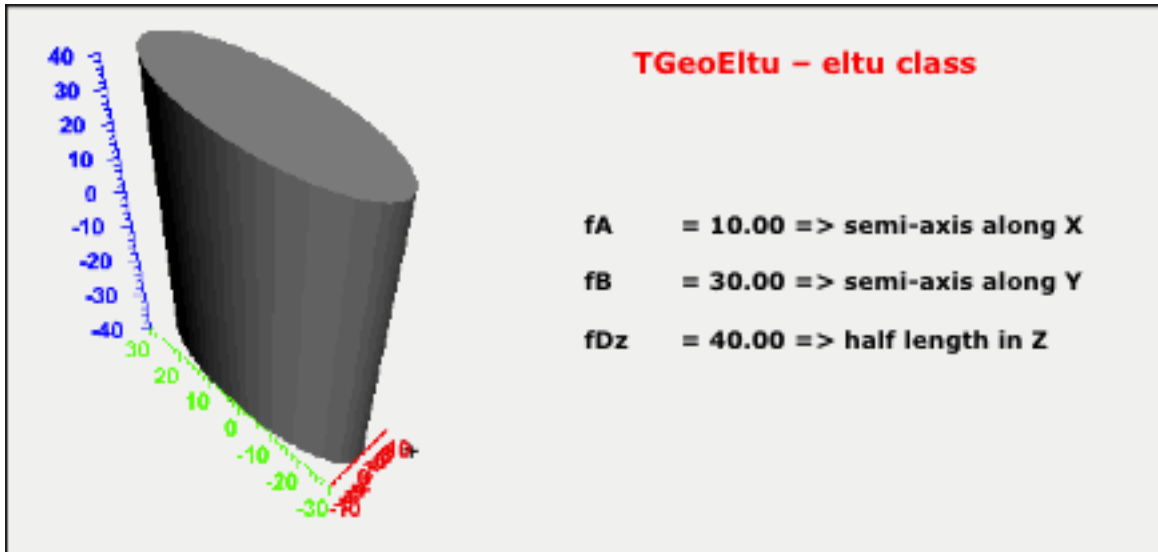

Figure 18.14: TGeoEltu Class

### 18.3.2.11 Hyperboloids - TGeoHype Class

A hyperboloid is represented as a solid limited by two planes perpendicular to the Z axis (top and bottom planes) and two hyperbolic surfaces of revolution about Z axis (inner and outer surfaces). The class describing hyperboloids is **TGeoHype** has 5 input parameters:

```
TGeoHype(Double_t rin,Double_t stin,Double_t rout,
Double_t stout,Double_t dz);
```

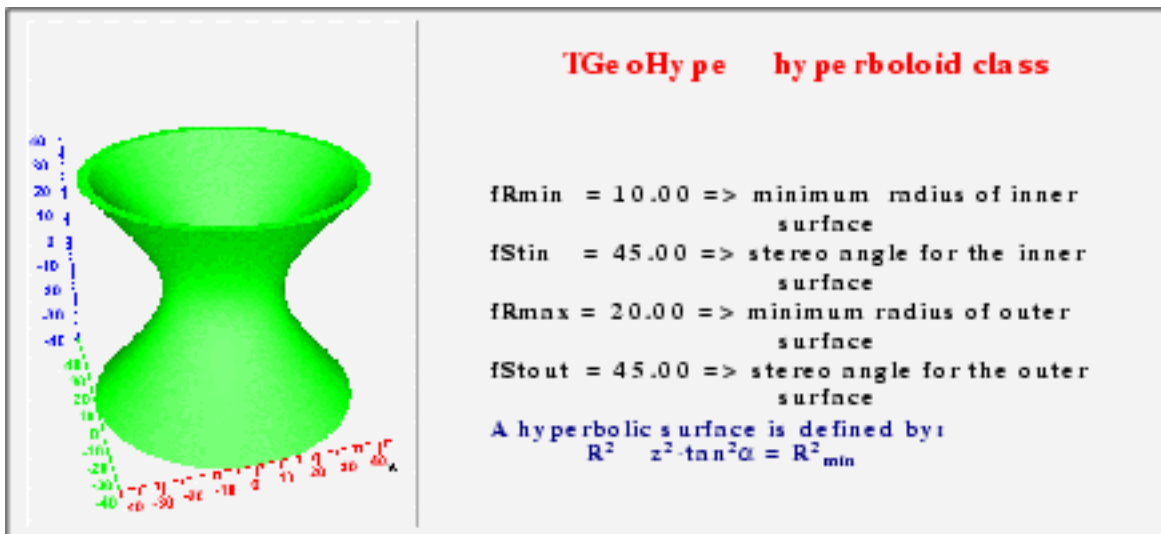

Figure 18.15: TGeoHype Class

The hyperbolic surface equation is taken in the form:

$$r^2 - z^2 \tan^2(\alpha) = r_{2min}^2$$

- $r, z$ : cylindrical coordinates for a point on the surface
- $\alpha$ : stereo angle between the hyperbola asymptotic lines and Z axis
- $r_{2min}$ : minimum distance between hyperbola and Z axis (at  $z=0$ )

The input parameters represent:

- `rin`, `stin`: minimum radius and tangent of stereo angle for inner surface
- `rout`, `stout`: minimum radius and tangent of stereo angle for outer surface
- `dz`: half length in Z (bounding planes positions at  $\pm dz$ )

The following conditions are mandatory in order to avoid intersections between the inner and outer hyperbolic surfaces in the range  $\pm dz$ :

- `rin` < `rout`
- `rout` > 0
- `rin`<sup>2</sup> + `dz`<sup>2</sup>\*`stin`<sup>2</sup> > `rout`<sup>2</sup> + `dz`<sup>2</sup>\*`stout`<sup>2</sup>

Particular cases:

- `rin`=0, `stin`=0: the inner surface is conical
- `stin`=0 / `stout`=0: cylindrical surface(s)

### 18.3.2.12 Cones - TGeoCone Class

The cones are defined by 5 parameters:

```
TGeoCone(Double_t dz, Double_t rmin1, Double_t rmax1,
Double_t rmin2, Double_t rmax2);
```

- `rmin1`: internal radius at Z is  $-dz$
- `rmax1`: external radius at Z is  $-dz$
- `rmin2`: internal radius at Z is  $+dz$
- `rmax2`: external radius at Z is  $+dz$
- `dz`: half length in Z (a cone ranges from  $-dz$  to  $+dz$ )

A cone has Z-axis as its symmetry axis.

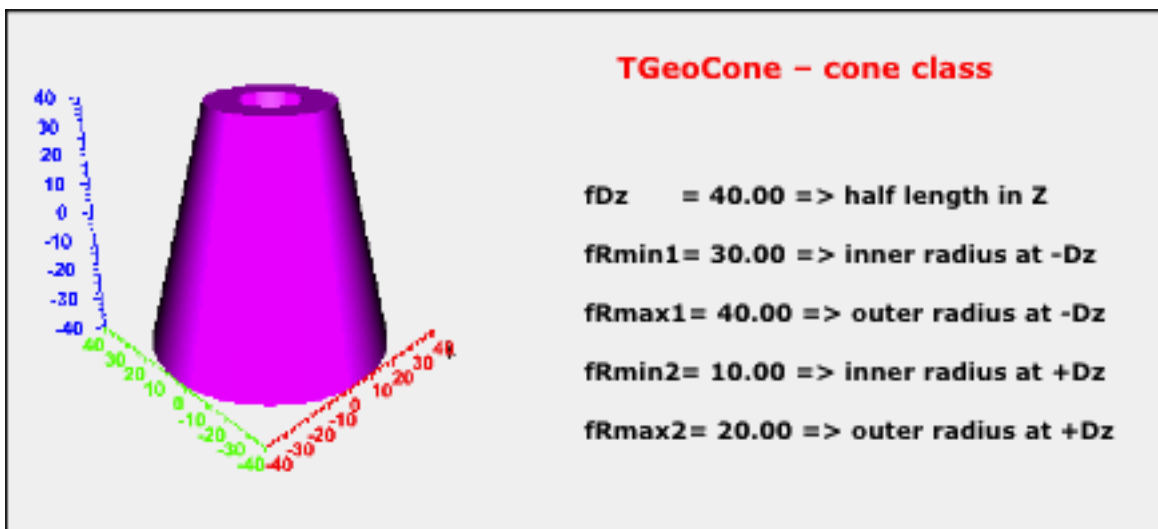

Figure 18.16: TGeoCone Class

### 18.3.2.13 Cone Segments - TGeoConeSeg Class

A cone segment is a cone having a range in phi. The cone segment class derives from **TGeoCone**, having two extra parameters: phi1 and phi2.

```
TGeoConeSeg(Double_t dz,Double_t rmin1,Double_t rmax1,
Double_t rmin2,Double_t rmax2,Double_t phi1,Double_t phi2);
```

Parameters phi1 and phi2 have the same meaning and convention as for tube segments.

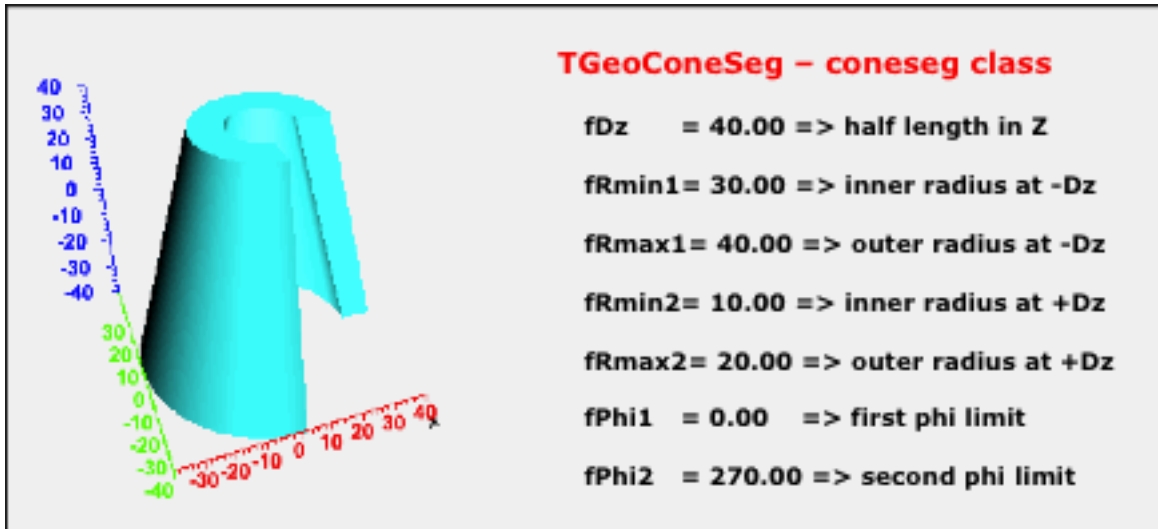

Figure 18.17: TGeoConeSeg Class

### 18.3.2.14 Sphere - TGeoSphere Class

Spheres in **TGeo** are not just balls having internal and external radii, but sectors of a sphere having defined theta and phi ranges. The **TGeoSphere** class has the following constructor.



Figure 18.18: TGeoSphere Class

```
TGeoSphere(Double_t rmin,Double_t rmax,Double_t theta1,
Double_t theta2,Double_t phi1, Double_t phi2);
```

- `rmin`: internal radius of the spherical sector
- `rmax`: external radius
- `theta1`: starting theta value [0, 180) in degrees
- `theta2`: ending theta value (0, 180] in degrees (`theta1 < theta2`)

### 18.3.2.15 Torus : TGeoTorus Class

The torus is defined by its axial radius, its inner and outer radius.

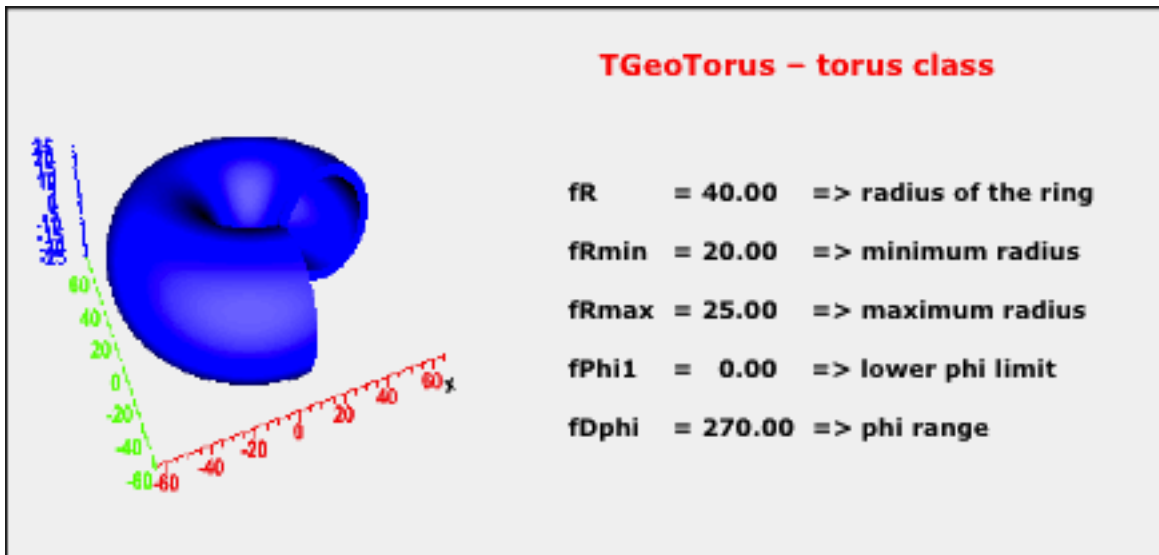

Figure 18.19: TGeoTorus Class

It may have a phirange:

```
TGeoTorus(Double_t R,Double_t Rmin,Double_t Rmax,Double_t Phi1,
Double_t Dphi);
```

- `R`: axial radius of the torus
- `Rmin`: inner radius
- `Rmax`: outer radius
- `Phi1`: starting phi angle
- `Dphi`: total phi range

### 18.3.2.16 Paraboloid : TGeoParaboloid Class

A paraboloid is defined by the revolution surface generated by a parabola and is bounded by two planes perpendicular to Z axis. The parabola equation is taken in the form:  $z = a \cdot r^2 + b$ , where:  $r^2 = x^2 + y^2$ . Note the missing linear term (parabola symmetric with respect to Z axis).

The coefficients `a` and `b` are computed from the input values which are the radii of the circular sections cut by the planes at  $\pm dz$ :

- $-dz = a \cdot r_{low}^2 + b$
- $dz = a \cdot r_{high}^2 + b$

```
TGeoParaboloid(Double_t rlo,Double_t rhi,Double_t dz);
```

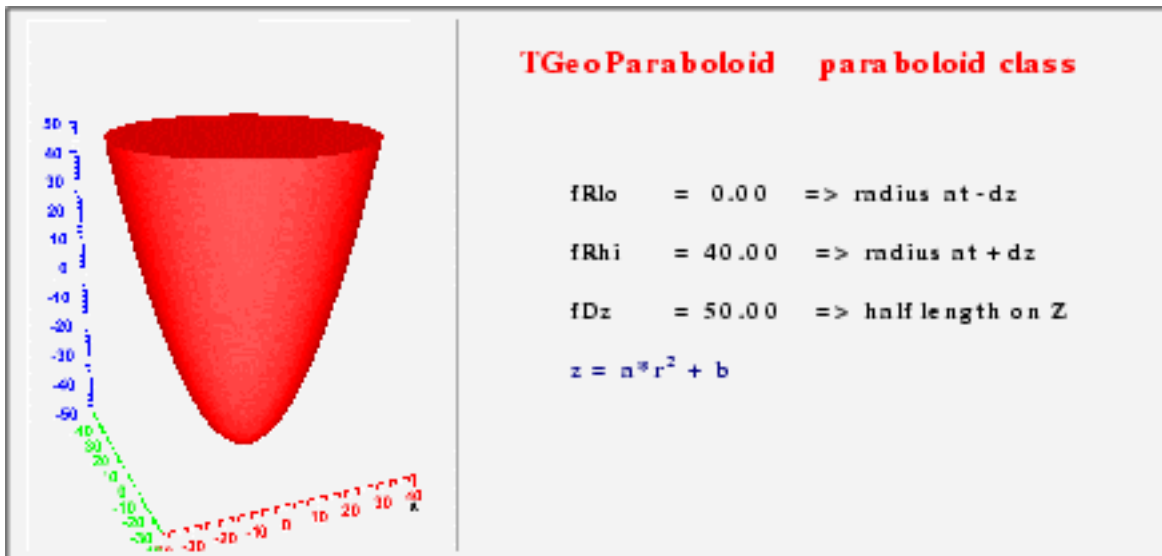

Figure 18.20: TGeoParaboloid Class

### 18.3.2.17 Polycone : TGeoPcon Class

A polycone is represented by a sequence of tubes/cones, glued together at defined Z planes. The polycone might have a phi segmentation, which globally applies to all the pieces. It has to be defined in two steps:

1. First call the **TGeoPcon** constructor to define a polycone:

```
TGeoPcon(Double_t phi1, Double_t dphi, Int_t nz
```

- phi1: starting phi angle in degrees
- dphi: total phi range
- nz: number of Z planes defining polycone sections (minimum 2)

2. Define one by one all sections [0, nz-1]

```
void TGeoPcon::DefineSection(Int_t i, Double_t z,  
Double_t rmin, Double_t rmax);
```

- i: section index [0, nz-1]
- z: z coordinate of the section
- rmin: minimum radius corresponding too this section
- rmax: maximum radius.

The first section (i=0) has to be positioned always the lowest Z coordinate. It defines the radii of the first cone/tube segment at its lower Z. The next section defines the end-cap of the first segment, but it can represent also the beginning of the next one. Any discontinuity in the radius has to be represented by a section defined at the same Z coordinate as the previous one. The Z coordinates of all sections must be sorted in increasing order. Any radius or Z coordinate of a given plane have corresponding getters:

```
Double_t TGeoPcon::GetRmin(Int_t i);  
Double_t TGeoPcon::GetRmax(Int_t i);  
Double_t TGeoPcon::GetZ(Int_t i);
```

Note that the last section should be defined last, since it triggers the computation of the bounding box of the polycone.

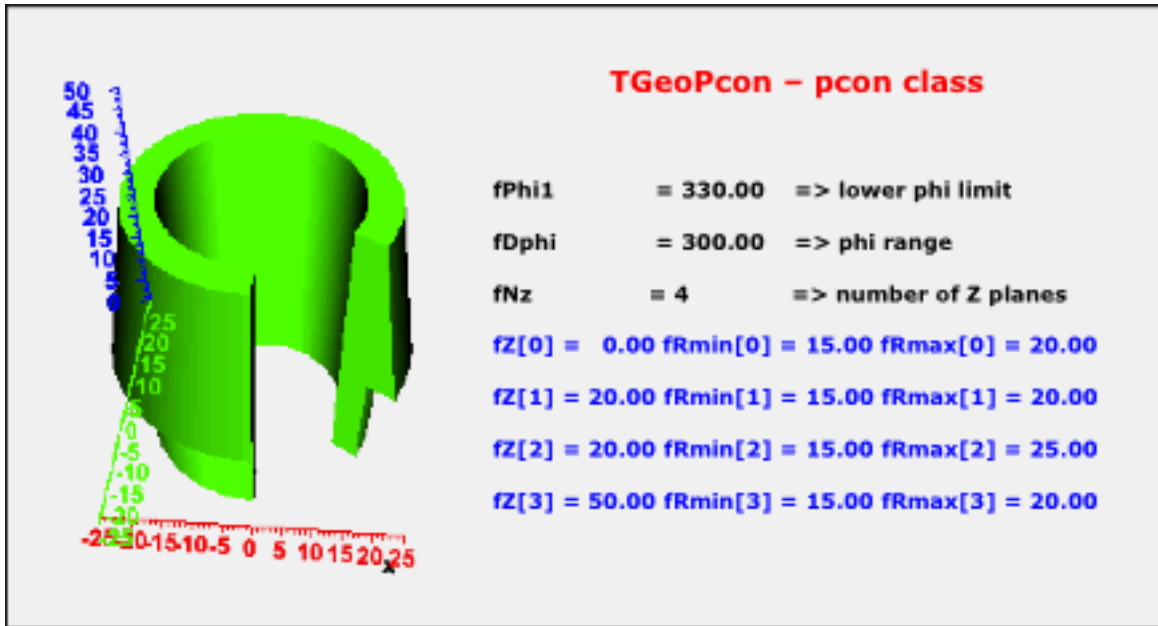

Figure 18.21: TGeoPcon Class

### 18.3.2.18 Polygon: TGeoPgon Class

Polygons are defined in the same way as polycones, the difference being just that the segments between consecutive Z planes are regular polygons. The phi segmentation is preserved and the shape is defined in a similar manner, just that `rmin` and `rmax` represent the radii of the circles inscribed in the inner/outer polygon.

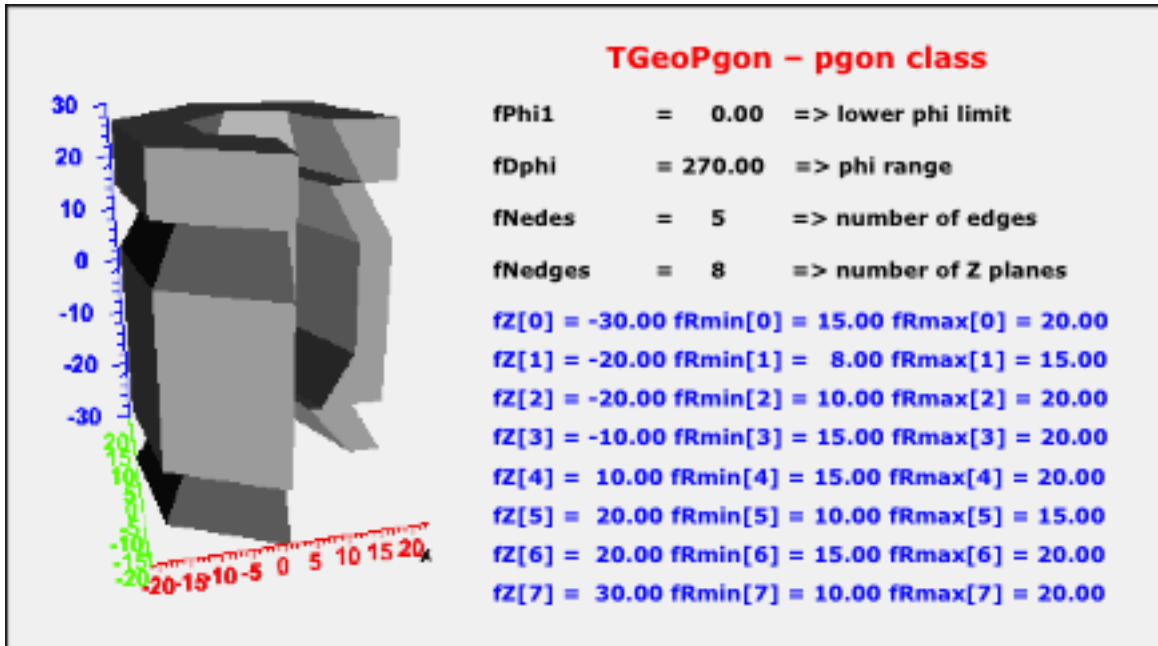

Figure 18.22: TGeoPgon Class

The constructor of a polygon has the form:

```
TGeoPgon(Double_t phi1, Double_t dphi, Int_t nedges, Int_t nz);
```

The extra parameter `nedges` represent the number of equal edges of the polygons, between `phi1` and `phi1+dphi`.



### 18.3.2.19 Polygonal extrusion: TGeoXtru Class

A **TGeoXtru** shape is represented by the extrusion of an arbitrary polygon with fixed outline between several Z sections. Each Z section is a scaled version of the same “blueprint” polygon. Different global XY translations are allowed from section to section. Corresponding polygon vertices from consecutive sections are connected.

An extruded polygon can be created using the constructor:

```
TGeoXtru::TGeoXtru(Int_t nplanes);
```

- **nplanes**: number of Z sections (minimum 2)

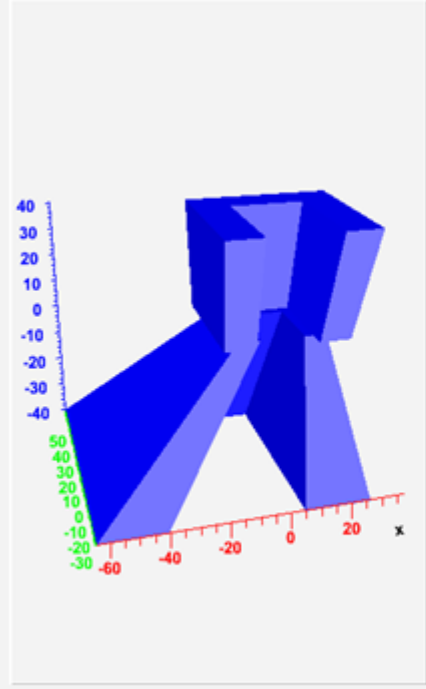

### TGeoXtru – polygonal extrusion class

**fNve = 8 => number of polygon vertices**  
**fNz = 4 => number of Z sections**

**Any Z section is a translated/scaled version of the same blueprint polygon. The shape can have an arbitrary number of Z sections.**

**Create with:**  
**TGeoXtru \*xtru = new TGeoXtru(nz);**

**Define the blueprint polygon:**  
**Double\_t x[8] = {-30,-30,30,30,15,15,-15,-15};**  
**Double\_t y[8] = {-30,30,30,-30,-30,15,15,-30};**  
**xtru->DefinePolygon(8,x,y);**

**Define Z position, X/Y offset and scaling factor for each Z section :**  
**Xtru->DefineSection(0, -40., -20., 10., 1.5);**  
**Xtru->DefineSection(1, 10., 0., 0., 0.5);**  
**Xtru->DefineSection(2, 10., 0., 0., 0.7);**  
**Xtru->DefineSection(3, 40., 20., 20., 0.9);**

**Sections have to be defined in increasing Z order. Two sections can be defined at same Z, but not for the first or last sections.**

Figure 18.23: TGeoXtru Class

The lists of X and Y positions for all vertices have to be provided for the “blueprint” polygon:

```
TGeoXtru::DefinePolygon (Int_t nvertices, Double_t *xv,  
Double_t *yv);
```

- **nvertices**: number of vertices of the polygon
- **xv,yv**: arrays of X and Y coordinates for polygon vertices

The method creates an object of the class **TGeoPolygon** for which the convexity is automatically determined . The polygon is decomposed into convex polygons if needed.

Next step is to define the Z positions for each section plane as well as the XY offset and scaling for the corresponding polygons.

```
TGeoXtru::DefineSection(Int_t snum,Double_t zsection,Double_t x0,  
Double_t y0, Double_t scale);
```

- **snum**: Z section index (0, nplanes-1). The section with **snum = nplanes-1** must be defined last and triggers the computation of the bounding box for the whole shape

- `zsection`: Z position of section `snum`. Sections must be defined in increasing order of Z (e.g. `snum=0` correspond to the minimum Z and `snum=nplanes-1` to the maximum one).
- `x0,y0`: offset of section `snum` with respect to the local shape reference frame T
- `scale`: factor that multiplies the X/Y coordinates of each vertex of the polygon at section `snum`:
- `x[ivert] = x0 + scale*xv[ivert]`
- `y[ivert] = y0 + scale*yv[ivert]`

### 18.3.2.20 Half Spaces: TGeoHalfSpace Class

- A half space is limited just by a plane, defined by a point and the normal direction. The point lies on the plane and the normal vector points outside the half space. The half space is the only shape which is infinite and can be used only in Boolean operations that result in non-infinite composite shapes (see also “Composite Shapes” below). A half space has to be defined using the constructor:

```
TGeoHalfSpace (const char *name, Double_t *point[3],
Double_t *norm[3]);
```

## 18.3.3 Composite Shapes

Composite shapes are Boolean combinations of two or more shape components. The supported Boolean operations are union (+), intersection (\*) and subtraction (-). Composite shapes derive from the base **TGeoShape** class, therefore providing all shape features: computation of bounding box, finding if a given point is inside or outside the combination, as well as computing the distance to entering/exiting. They can be directly used for creating volumes or used in the definition of other composite shapes.

Composite shapes are provided in order to complement and extend the set of basic shape primitives. They have a binary tree internal structure, therefore all shape-related geometry queries are signals propagated from top level down to the final leaves, while the provided answers are assembled and interpreted back at top. This **CSG** (composite solid geometry) hierarchy is effective for small number of components, while performance drops dramatically for large structures. Building a complete geometry in this style is virtually possible but highly not recommended.

### 18.3.3.1 The Structure of Composite Shapes

A composite shape can always be looked as the result of a Boolean operation between only two shape components. All information identifying these two components as well as their positions with respect to the frame of the composite is represented by an object called Boolean node. A composite shape has a pointer to such a Boolean node. Since the shape components may also be composites, they will also contain binary Boolean nodes branching out other two shapes in the hierarchy. Any such branch ends-up when the final leaves are no longer composite shapes, but basic primitives. The figure shows the composite shapes structure.

Suppose that A, B, C and D represent basic shapes, we will illustrate how the internal representation of few combinations look like. We do this only for understanding how to create them in a proper way, since the user interface for this purpose is in fact very simple. We will ignore for the time being the positioning of components. The definition of a composite shape takes an expression where the identifiers are shape names. The expression is parsed and decomposed in 2 sub-expressions and the top-level Boolean operator.

#### 1. Union: A+B+C

Just to illustrate the Boolean expression parsing and the composite shape structure, let's take a simple example. We will describe the union of A, B and C. Both union operators are at the same level. Since:

$$A+B+C = (A+B)+C = A+(B+C)$$

The first (+) is taken as separator, hence the expression split in: A and (B+C). A Boolean node of type **TGeoUnion("A", "B+C")** is created. This tries to replace the 2 expressions by actual pointers to corresponding shapes. The first expression (A) contains no operators therefore is interpreted as representing a shape. The shape named “A” is searched into the list of shapes handled by the manager class and stored as the “left” shape in the Boolean union node. Since the second expression is not yet fully decomposed, the “right” shape in the combination is created as a new composite shape. This will split at

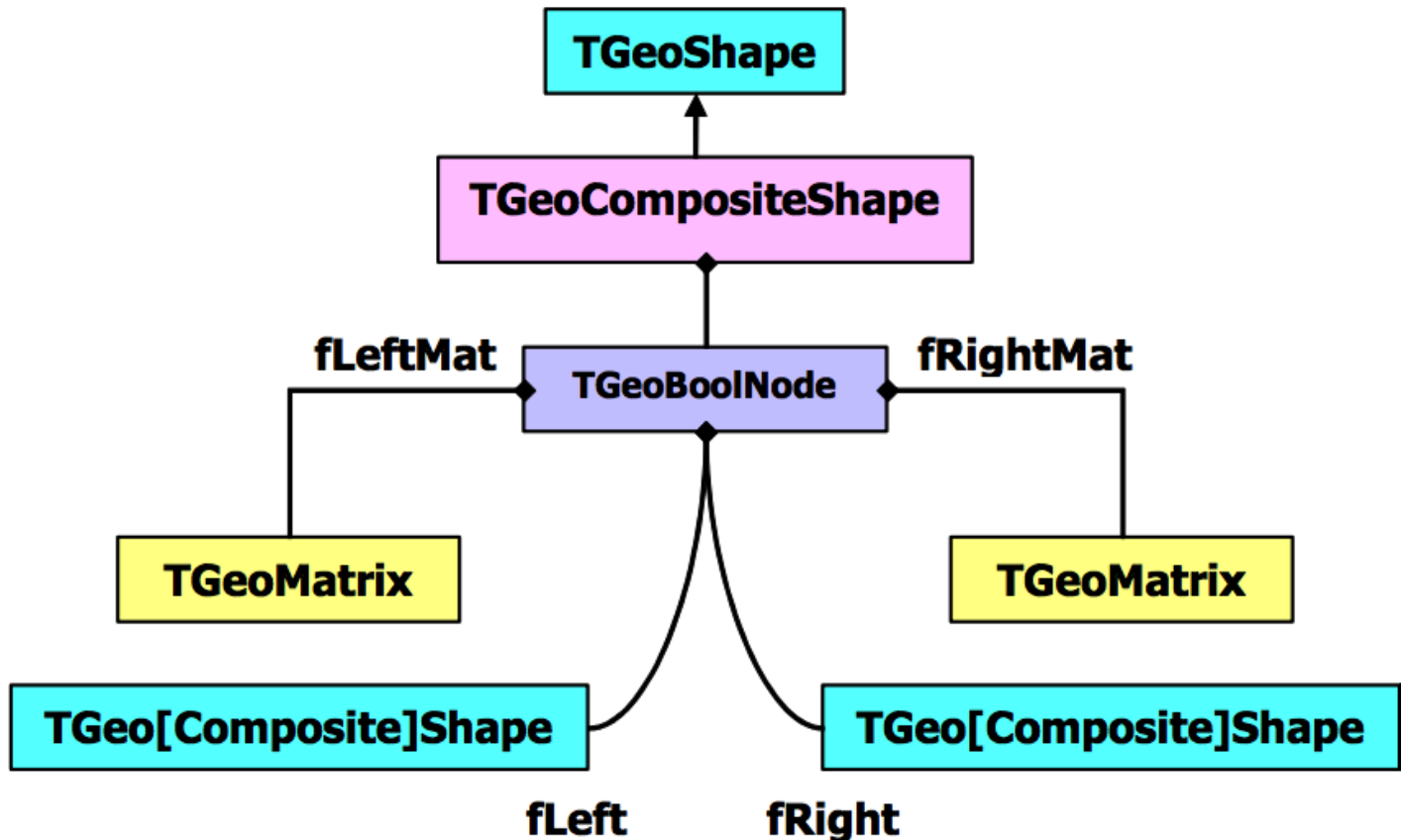

Figure 18.24: The composite shapes structure

its turn  $B+C$  into  $B$  and  $C$  and create a `TGeoUnion("B", "C")`. The  $B$  and  $C$  identifiers will be looked for and replaced by the pointers to the actual shapes into the new node. Finally, the composite “ $A+B+C$ ” will be represented as shown in Fig.17-23.\*\*

To build this composite shape:

```
TGeoCompositeShape *cs1 = new TGeoCompositeShape("CS1", "A+B+C");
```

Any shape entering a Boolean combination can be prior positioned. In order to do so, one has to attach a matrix name to the shape name by using a colon (:). As for shapes, the named matrix has to be prior defined:

```
TGeoMatrix *mat;
// ... code creating some geometrical transformation
mat->SetName("mat1");
mat->RegisterYourself(); // see Geometrical transformations
```

An identifier `shape:matrix` have the meaning: `shape` is translated or rotated with `matrix` with respect to the Boolean combination it enters as operand. Note that in the expression  $A+B+C$  no matrix identifier was provided, therefore the identity matrix was used for positioning the shape components. The next example will illustrate a more complex case.

2.  $(A:m1+B):m2-(C:m3*D:m4):m5$

Let’s try to understand the expression above. This expression means: subtract the intersection of  $C$  and  $D$  from the union of  $A$  and  $B$ . The usage of parenthesis to force the desired precedence is always recommended. One can see that not only the primitive shapes have some geometrical transformations, but also their intermediate compositions.

```
TGeoCompositeShape *cs2 = new TGeoCompositeShape("CS2",
"(A:m1+B):m2-(C:m3*D:m4):m5");
```

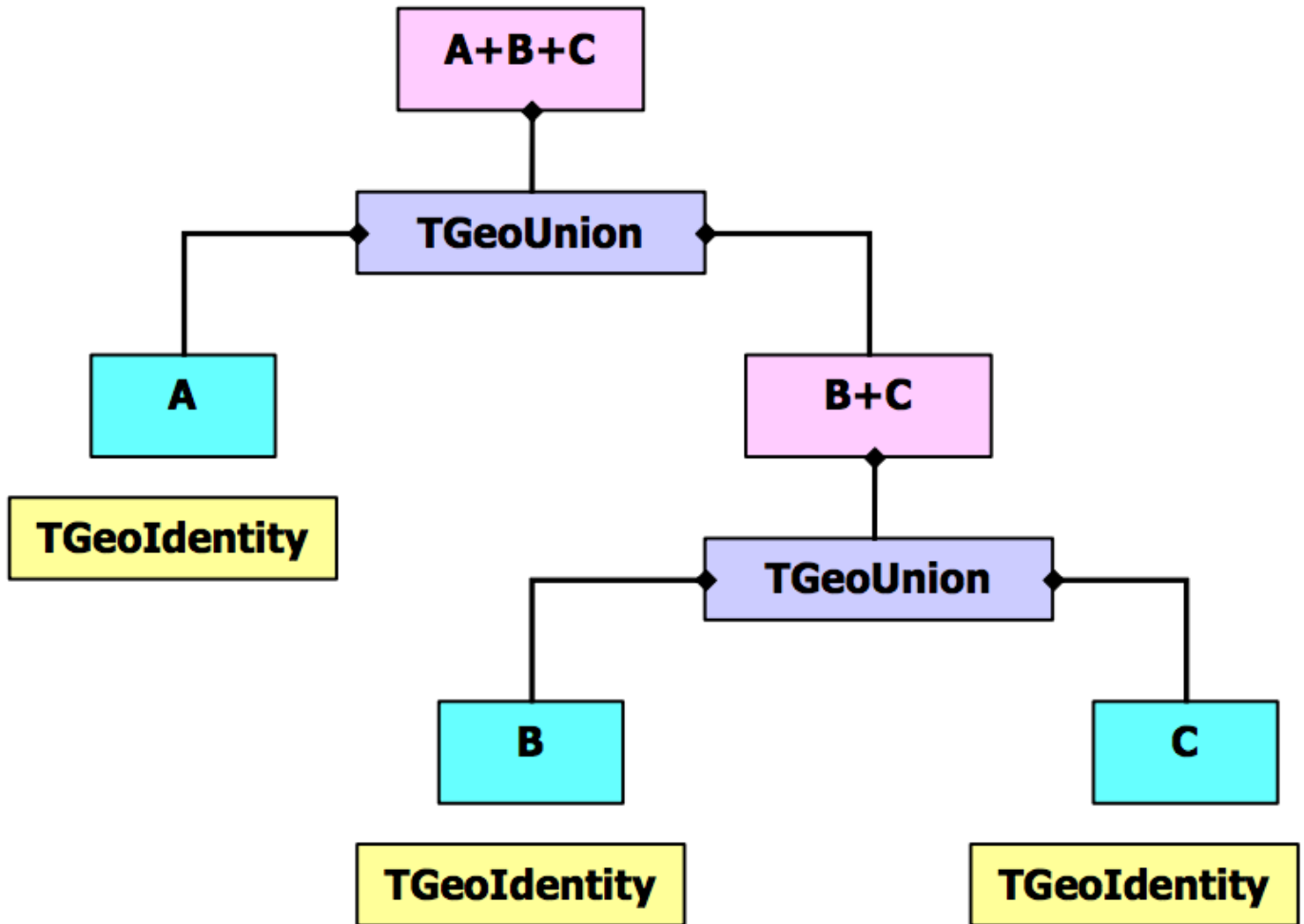
Figure 18.25: Representation of  $A+B+C$

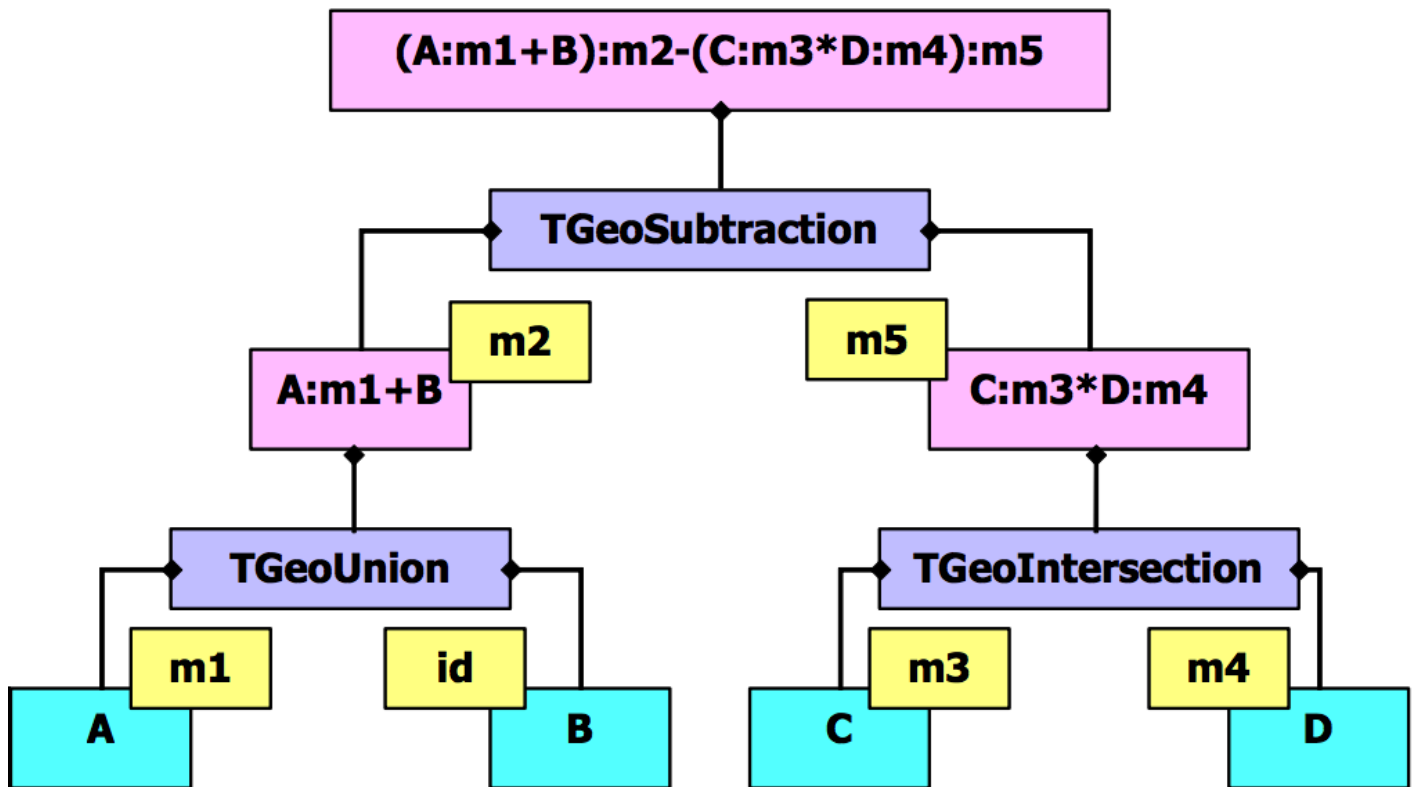

Figure 18.26: Internal representation for composite shapes

Building composite shapes as in the first example is not always quite useful since we were using un-positioned shapes. When supplying just shape names as identifiers, the created Boolean nodes will assume that the shapes are positioned with an identity transformation with respect to the frame of the created composite. In order to provide some positioning of the combination components, we have to attach after each shape identifier the name of an existing transformation, separated by a colon. Obviously all transformations created for this purpose have to be objects with unique names in order to be properly substituted during parsing.

### 18.3.3.2 Composite Shape Example

One should have in mind that the same shape or matrix identifiers can be used many times in the same expression, as in the following example:

```
const Double_t sq2 = TMath::Sqrt(2.);
gSystem->Load("libGeom");
TGeoManager *mgr =
    new TGeoManager("Geom","composite shape example");
TGeoMedium *medium = 0;
TGeoVolume *top = mgr->MakeBox("TOP",medium,100,250,250);
mgr->SetTopVolume(top);

// make shape components
TGeoBBox *sbox = new TGeoBBox("B",100,125*sq2,125*sq2);
TGeoTube *stub = new TGeoTube("T",0,100,250);
TGeoPgon *spgon = new TGeoPgon("P",0.,360.,6,2);
spgon->DefineSection(0,-250,0,80);
spgon->DefineSection(1,250,0,80);

// define some rotations
TGeoRotation *r1 = new TGeoRotation("r1",90,0,0,180,90,90);
```

```

r1->RegisterYourself();
TGeoRotation *r2 = new TGeoRotation("r2",90,0,45,90,45,270);
r2->RegisterYourself();
// create a composite
TGeoCompositeShape *cs = new TGeoCompositeShape("cs",
"((T+T:r1)-(P+P:r1))*B:r2");
TGeoVolume *comp = new TGeoVolume("COMP",cs);
comp->SetLineColor(5);

// put it in the top volume
top->AddNode(comp,1);
mgr->CloseGeometry();
// visualize it with ray tracing
top->Raytrace();

```

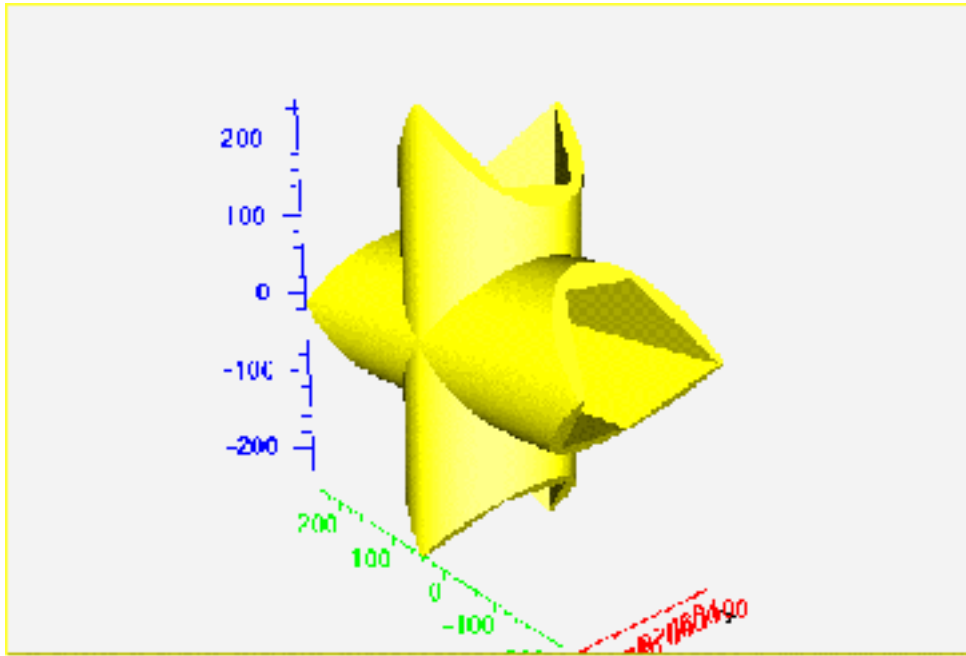

Figure 18.27: A composite shape example

Composite shapes can be subsequently used for defining volumes. Moreover, these volumes contain other volumes, following the general criteria. Volumes created based on composite shapes cannot be divided.

### 18.3.4 Navigation Methods Performed By Shapes

Shapes are named objects and register themselves to the `manager` class at creation time. This is responsible for their final deletion. Shapes can be created without name if their retrieval by name is not needed. Generally shapes are objects that are useful only at geometry creation stage. The pointer to a shape is in fact needed only when referring to a given volume and it is always accessible at that level. Several volumes may reference a single shape; therefore its deletion is not possible once volumes were defined based on it.

The navigation features related for instance to tracking particles are performed in the following way: Each shape implements its specific algorithms for all required tasks in its local reference system. Note that the manager class handles global queries related to geometry. However, shape-related queries might be sometimes useful:

```
Bool_t TGeoShape::Contains(Double_t *point[3]);
```

The method above returns `kTRUE` if the point `*point` is actually inside the shape. The point has to be defined in the local shape reference. For instance, for a box having `DX`, `DY` and `DZ` half-lengths a point will be considered inside if:

```
-DX <= point[0] <= DX
-DY <= point[1] <= DY
-DZ <= point[2] <= DZ
```

```
Double_t TGeoShape::DistFromInside(Double_t *point[3],
Double_t *dir[3], Int_t iact, Double_t step, Double_t *safe);
```

The method computes the distance to exiting a shape from a given point *inside*, along a given direction. This direction is given by its director cosines with respect to the local shape coordinate system. This method provides additional information according the value of *iact* input parameter:

- *iact* = 0 computes only safe distance and fill it at the location given by SAFE;
- *iact* = 1 a proposed STEP is supplied. The safe distance is computed first. If this is bigger than STEP than the proposed step is approved and returned by the method since it does not cross the shape boundaries. Otherwise, the distance to exiting the shape is computed and returned;
- *iact* = 2 computes both safe distance and distance to exiting, ignoring the proposed step;
- *iact* > 2 computes only the distance to exiting, ignoring anything else

```
Double_t TGeoShape::DistFromOutside(Double_t *point[3],
Double_t *dir[3], Int_t iact, Double_t step, Double_t *safe);
```

This method computes the distance to entering a shape from a given point *outside*. It acts in the same way as the previous method.

```
Double_t TGeoShape::Safety(Double_t *point[3], Bool_t inside);
```

This computes the maximum shift of a point in any direction that does not change its *inside/outside* state (does not cross shape boundaries). The state of the point has to be properly supplied.

```
Double_t *TGeoShape::ComputeNormal(Double_t *point[3],
Double_t *dir[3], Double_t *norm[3]);
```

The method above computes the director cosines of normal to the crossed shape surface from a given point towards direction. This is filled into the *norm* array, supplied by the user. The normal vector is always chosen such that its dot product with the direction is positive defined.

### 18.3.5 Creating Shapes

Shape objects embeds only the minimum set of parameters that are fully describing a valid physical shape. For instance, the half-length, the minimum and maximum radius represent a tube. Shapes are used together with media in order to create volumes, which in their turn are the main components of the geometrical tree. A specific shape can be created stand-alone:

```
TGeoBBox *box = new TGeoBBox("s_box", halfX, halfY, halfZ); // named
TGeoTube *tub = new TGeoTube(rmin, rmax, halfZ); // no name
//... (See all specific shape constructors)
```

Sometimes it is much easier to create a volume having a given shape in one step, since shapes are not directly linked in the geometrical tree but volumes are:

```
TGeoVolume *vol_box = gGeoManager->MakeBox("BOX_VOL", pmed, halfX,
halfY, halfZ);
TGeoVolume *vol_tub = gGeoManager->MakeTube("TUB_VOL", pmed, rmin,
rmax, halfZ);
// ... (See MakeXXX() utilities in TGeoManager class)
```

### 18.3.6 Dividing Shapes

Shapes can generally be divided along a given axis. Supported axes are: X, Y, Z, Rxy, Phi, Rxyz. A given shape cannot be divided however on any axis. The general rule is that that divisions are possible on whatever axis that produces still known shapes as slices. The division of shapes are performed by the call `TGeoShape::Divide()`, but this operation can be done only via `TGeoVolume::Divide()` method. In other words, the algorithm for dividing a specific shape is known by the shape object, but is always invoked in a generic way from the volume level. Details on how to do that can be found in the paragraph ‘Dividing volumes’. One can see how all division options are interpreted and which their result inside specific shape classes is.

### 18.3.7 Parametric Shapes

Shapes generally have a set of parameters that is well defined at build time. In fact, when the final geometrical hierarchy is assembled and the geometry is closed, all constituent shapes **MUST** have well defined and valid parameters. In order to ease-up geometry creation, some parameterizations are however allowed.

For instance let’s suppose that we need to define several volumes having exactly the same properties but different sizes. A way to do this would be to create as many different volumes and shapes. The modeller allows however the definition of a single volume having undefined shape parameters.

```
TGeoManager::Volume(const char *name, const char *shape, Int_t nmed);
```

- **name**: the name of the newly created volume;
- **shape**: the type of the associated shape. This has to contain the case-insensitive first 4 letters of the corresponding class name (e.g. “tubs” will match `TGeoTubeSeg`, “bbox” will match `TGeoBBox`)
- **nmed**: the medium number.

This will create a special volume that will not be directly used in the geometry, but whenever positioned will require a list of actual parameters for the current shape that will be created in this process. Such volumes having shape parameters known only when used have to be positioned only with `TGeoManager::Node()` method (see ‘Creating and Positioning Volumes’).

Other case when shape parameterizations are quite useful is scaling geometry structures. Imagine that we would like to enlarge/shrink a detector structure on one or more axes. This happens quite often in real life and is handled by “fitting mother” parameters. This is accomplished by defining shapes with one or more invalid (negative) parameters. For instance, defining a box having `dx=10.`, `dy=10.`, and `dz=-1` will not generate an error but will be interpreted in a different way: A special volume `TGeoVolumeMulti` will be created. Whenever positioned inside a mother volume, this will create a normal `TGeoVolume` object having as shape a box with `dz` fitting the corresponding `dz` of the mother shape. Generally, this type of parameterization is used when positioning volumes in containers having a matching shape, but it works also for most reasonable combinations.

## 18.4 Geometry Creation

A given geometry can be built in various ways, but one has to follow some mandatory steps. Even if we might use some terms that will be explained later, here are few general rules:

- Volumes need media and shapes in order to be created.
- Both containers and contained volumes must be created before linking them together, and the relative transformation matrix must be provided.
- Any volume have to be positioned somewhere otherwise it will not be considered as part of the geometry.
- Visibility or tracking properties of volumes can be provided both at build time or after geometry is closed, but global visualization settings (see section: “The Drawing Package”) should not be provided at build time, otherwise the drawing package will be loaded.

There is also a list of specific rules:



- Positioned volumes should not extrude their container or intersect with others within this unless it is specified (see section: Overlapping Volumes).
- The top volume (containing all geometry trees) must be specified before closing the geometry and must not be positioned - it represents the global reference frame.
- After building the full geometry tree, the geometry must be closed (see the method `TGeoManager::CloseGeometry()`). Voxalization can be redone per volume after this process.

The list is much bigger and we will describe in more detail the geometry creation procedure in the following sections. Provided that geometry was successfully built and closed, the `TGeoManager` class will register itself to ROOT and the logical/physical structures will become immediately browsable.

### 18.4.1 The Volume Hierarchy

The basic components used for building the logical hierarchy of the geometry are the positioned volumes called **nodes**. Volumes are fully defined geometrical objects having a given shape and medium and possibly containing a list of nodes. Nodes represent just positioned instances of volumes inside a container volume but users do not directly create them. They are automatically created as a result of adding one volume inside other or dividing a volume. The geometrical transformation held by nodes is always defined with respect to their mother (relative positioning). Reflection matrices are allowed.

A hierarchical element is not fully defined by a node since nodes are not directly linked to each other, but through volumes (a node points to a volume, which at its turn points to a list of nodes):

```
NodeTop VolTop NodeA VolA ...
```

One can therefore talk about “the node or volume hierarchy”, but in fact, an element is made by a pair volume-node. In the line above is represented just a single branch, but of course from any volume other branches can also emerge. The index of a node in such a branch (counting only nodes) is called **depth**. The top node have always **depth=0**.

Volumes need to have their daughter nodes defined when the geometry is closed. They will build additional structures (called **voxels**) in order to fasten-up the search algorithms. Finally, nodes can be regarded as bi-directional links between containers and contained volumes.

The structure defined in this way is a graph structure since volumes are replicable (same volume can become daughter node of several other volumes), every volume becoming a branch in this graph. Any volume in the logical graph can become the actual top volume at run time (see `TGeoManager::SetTopVolume()`). **All functionalities of the modeller will behave in this case as if only the corresponding branch starting from this volume is the active geometry.**

Nodes are never instantiated directly by users, but created as a result of volume operations. Adding a volume named A with a given **user id** inside a volume B will create a node named **A\_id**. This will be added to the list of nodes stored by B. In addition, when applying a division operation in N slices to a volume A, a list of nodes **B\_1, B\_2, ... , B\_N** is also created. A node **B\_i** does not represent a unique object in the geometry because its container A might be at its turn positioned as node inside several other volumes. Only when a complete branch of nodes is fully defined up to the top node in the geometry, a given path: `/TOP_1/.../A_3/B_7` will represent a unique object. Its global transformation matrix can be computed as the pile-up of all local transformations in its branch. We will therefore call **logical graph** the hierarchy defined by nodes and volumes. The expansion of the logical graph by all possible paths defines a tree structure where all nodes are unique “touchable” objects. We will call this the “physical tree”. Unlike the logical graph, the physical tree can become a huge structure with several millions of nodes in case of complex geometries; therefore, it is not always a good idea to keep it transient in memory. Since the logical and physical structures are correlated, the modeller rather keeps track only of the current branch, updating the current global matrix at each change of the level in geometry. The current physical node is not an object that can be asked for at a given moment, but rather represented by the combination: current node/current global matrix. However, physical nodes have unique ID’s that can be retrieved for a given modeller state. These can be fed back to the modeller in order to force a physical node to become current. The advantage of this comes from the fact that all navigation queries check first the current node; therefore the location of a point in the geometry can be saved as a starting state for later use.

Nodes can be declared as **overlapping** in case they do overlap with other nodes inside the same container or extrude this container (see also ‘Checking the Geometry’). Non-overlapping nodes can be created with:

```
TGeoVolume::AddNode(TGeoVolume *daughter,Int_t copy_No,
TGeoMatrix *matr);
```

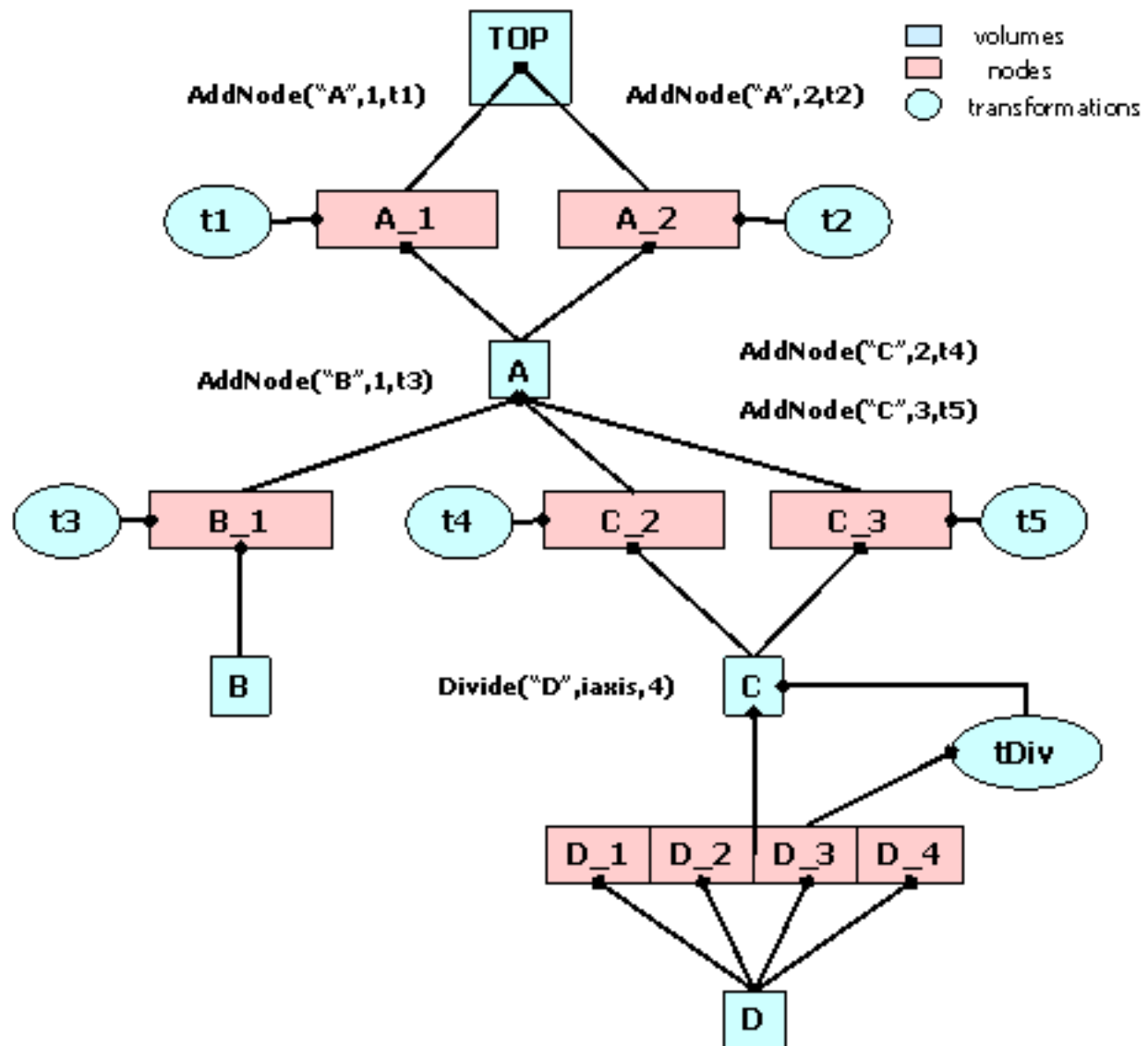

Figure 18.28: A geometry hierarchy in memory

The creation of overlapping nodes can be done with a similar prototype:

```
TGeoVolume::AddNodeOverlap(/*same arguments*/);
```

When closing the geometry, overlapping nodes perform a check of possible overlaps with their neighbors. These are stored and checked all the time during navigation; therefore, navigation is slower when embedding such nodes into geometry. Nodes have visualization attributes as the volume has. When undefined by users, painting a node on a pad will take the corresponding volume attributes.

## 18.4.2 Creating and Positioning Volumes

### 18.4.2.1 Making Volumes

As mentioned before, volumes are the basic objects used in building the geometrical hierarchy. They represent objects that are not positioned, but store all information about the placement of the other volumes they may contain. Therefore a volume can be replicated several times in the geometry. As it was explained, in order to create a volume, one has to put together a shape and a medium, which are already defined.

Volumes have to be named by users at creation time. Every different name may represent a unique volume object, but may also represent more general a family (class) of volume objects having the same shape type and medium, but possibly different shape parameters. It is the user's task to provide different names for different volume families in order to avoid ambiguities at tracking time.

A generic family rather than a single volume is created only in two cases: when a parametric shape is used or when a division operation is applied. Each volume in the geometry stores a unique ID corresponding to its family. In order to ease-up their creation, the manager class is providing an API that allows making a shape and a volume in a single step.

### 18.4.2.2 Example of Volume Creation

```
// Making a volume out of a shape and a medium.
TGeoVolume *vol = new TGeoVolume("VNAME",ptrShape,ptrMed);

// Making a volume out of a shape but without a defined medium.
TGeoVolume *vol = new TGeoVolume("VNAME",ptrShape);

// Making a volume with a given shape in one step
TGeoVolume *vol = gGeoManager->MakeBox("VNAME",ptrMed,dx,dy,dz);
TGeoVolume *vol = gGeoManager->MakeTubs("VNAME",ptrMed,rmin,rmax,
dz,phi1,phi2);

// See class TGeoManager for the rest of shapes.
// Making a volume with a given shape with a unique prototype
TGeoVolume *vol = gGeoManager->Volume("VNAME","XXXX",nmed,upar,
npar);

// Where XXXX stands for the first 4 letters of the specific shape
// classes, nmed is the medium number, upar is an Double_t * array
// of the shape parameters and npar is the number of parameters.
// This prototype allows (npar = 0) to define volumes with shape
// defined only at positioning time (volumes defined in this way
// need to be positioned using TGeoManager::Node() method)
```

### 18.4.2.3 Positioned Volumes (Nodes)

Geometrical modeling is a difficult task when the number of different geometrical objects is 106-108. This is more or less the case for detector geometries of complex experiments, where a 'flat' CSG model description cannot scale with the current CPU performances. This is the reason why models like GEANT [1] introduced an additional dimension (depth) in

order to reduce the complexity of the problem. This concept is also preserved by the ROOT modeller and introduces a pure geometrical constraint between objects (volumes in our case) - containment. This means in fact that any positioned volume has to be contained by another. Now what means contained and positioned?

- We will say that a volume **contains** a point if this is inside the shape associated to the volume. For instance, a volume having a box shape will contain all points  $P=(X,Y,Z)$  verifying the conditions:  $\text{Abs}(P_i)dX_i$ . The points on the shape boundaries are considered as inside the volume. The volume contains a daughter if it contains all the points contained by the daughter.
- The definition of containment works of course only with points defined in the local coordinate system of the considered volume. **Positioning** a volume inside another have to introduce a geometrical transformation between the two. If  $M$  defines this transformation, any point in the daughter reference can be converted to the mother reference by:  
 $P_{\text{mother}} = MP_{\text{daughter}}$

When creating a volume one does not specify if this will contain or not other volumes. Adding daughters to a volume implies creating those and adding them one by one to the list of daughters. Since the volume has to know the position of all its daughters, we will have to supply at the same time a geometrical transformation with respect to its local reference frame for each of them.

```
TGeoVolume::AddNode(TGeoVolume *daughter,Int_t usernumber,
TGeoMatrix *matrix=gGeoIdentity)
```

The objects referencing a volume and a transformation are called **NODES** and their creation is fully handled by the modeller. They represent the link elements in the hierarchy of volumes. Nodes are unique and distinct geometrical objects **ONLY** from their container point of view. Since volumes can be replicated in the geometry, the same node may be found on different branches.

In order to provide navigation features, volumes have to be able to find the proper container of any point defined in the local reference frame. This can be the volume itself, one of its positioned daughter volumes or none if the point is actually outside. On the other hand, volumes have to provide also other navigation methods such as finding the distances to its shape boundaries or which daughter will be crossed first. The implementation of these features is done at shape level, but the local mother-daughters management is handled by volumes. These build additional optimization structures upon geometry closure. In order to have navigation features properly working one has to follow some rules for building a valid geometry.

- The daughter volume(s) must not extrude the mother shape. They are allowed however to have a common boundaries.
- The volumes positioned in the same container must not overlap with each other. They may touch on one boundaries or shape vertex.

The daughter nodes of a volume can be also removed or replaced with other nodes:

```
void RemoveNode(TGeoNode* node)
TGeoNode*ReplaceNode(TGeoNode* nodeorig, TGeoShape* newshape = 0,
TGeoMatrix* newpos = 0, TGeoMedium* newmed = 0)
```

The last method allows replacing an existing daughter of a volume with another one. Providing only the node to be replaced will just create a new volume for the node but having exactly the same parameters as the old one. This helps in case of divisions for decoupling a node from the logical hierarchy so getting new content/properties. For non-divided volumes, one can change the shape and/or the position of the daughter.

#### 18.4.2.4 Virtual Containers and Assemblies of Volumes

Virtual containers are volumes that do not represent real objects, but they are needed for grouping and positioning together other volumes. Such grouping helps not only geometry creation, but also optimizes tracking performance; therefore, it is highly recommended. Virtual volumes need to inherit material/medium properties from the volume they are placed into in order to be “invisible” at tracking time.

Let us suppose that we need to group together two volumes A and B into a structure and position this into several other volumes D,E, and F. What we need to do is to create a virtual container volume C holding A and B, then position C in the other volumes.

Note that C is a volume having a determined medium. Since it is not a real volume, we need to manually set its medium the same as that of D,E or F in order to make it ‘invisible’ (same physics properties). In other words, the limitation in proceeding this way is that D,E, and F must point to the same medium. If this was not the case, we would have to define different virtual volumes for each placement: C, C’ and C", having the same shape but different media matching the corresponding containers. This might not happen so often, but when it does, it forces the creation of several extra virtual volumes. Other limitation comes from the fact that any container is directly used by navigation algorithms to optimize tracking. These must geometrically contain their belongings (positioned volumes) so that these do not extrude its shape boundaries. Not respecting this rule generally leads to unpredictable results. Therefore A and B together must fit into C that has to fit also into D,E, and F. This is not always straightforward to accomplish, especially when instead of A and B we have many more volumes.

In order to avoid these problems, one can use for the difficult cases the class **TGeoVolumeAssembly**, representing an assembly of volumes. This behaves like a normal container volume supporting other volumes positioned inside, but it has neither shape nor medium. It cannot be used directly as a piece of the geometry, but just as a temporary structure helping temporary assembling and positioning volumes.

If we define now C as an assembly containing A and B, positioning the assembly into D,E and F will actually position only A and B directly into these volumes, taking into account their combined transformations A/B to C and C to D/E/F. This looks much nicer, is it? In fact, it is and it is not. Of course, we managed to get rid of the ‘unnecessary’ volume C in our geometry, but we end-up with a more flat structure for D,E and F (more daughters inside). This can get much worse when extensively used, as in the case: assemblies of assemblies.

For deciding what to choose between using virtual containers or assemblies for a specific case, one can use for both cases, after the geometry was closed:

```
gGeoManager->SetTopVolume(ptr_D);
gGeoManager->Test();
gGeoManager->RestoreMasterVolume();
```

The ptr\_D is a pointer to volume D containing the interesting structure. The test will provide the timing for classifying 1 million random points inside D.

#### 18.4.2.5 Examples of Volume Positioning

Now let us make a simple volume representing a copper wire. We suppose that a medium is already created (see **TGeoMedium** class on how to create media).

We will create a TUBE shape for our wire, having Rmin=0cm, Rmax=0.01cm and a half-length dZ=1cm:

```
TGeoTube *tube = new TGeoTube("wire_tube",0,0.01,1);
```

One may omit the name for the shape wire\_tube, if no retrieving by name is further needed during geometry building. Different volumes having different names and materials can share the same shape.

Now let’s make the volume for our wire:

```
TGeoVolume *wire_co = new TGeoVolume("WIRE_CO",tube,
ptrCOPPER); //(*)
```

(\*) Do not bother to delete the media, shapes or volumes that you have created since all will be automatically cleaned on exit by the manager class.

If we would have taken a look inside **TGeoManager::MakeTube()** method, we would have been able to create our wire with a single line:

```
TGeoVolume *wire_co = gGeoManager->MakeTube("WIRE_CO",ptrCOPPER,
0,0.01,1); //(*)
```

(\*) The same applies for all primitive shapes, for which there can be found corresponding `MakeSHAPE()` methods. Their usage is much more convenient unless a shape has to be shared between more volumes.

Let us make now an aluminum wire having the same shape, supposing that we have created the copper wire with the line above:

```
TGeoVolume *wire_al = new TGeoVolume("WIRE_AL",wire_co>GetShape(),
ptrAL);
```

We would like now to position our wire in the middle of a gas chamber. We need first to define the gas chamber:

```
TGeoVolume *chamber = gGeoManager->MakeTube("CHAMBER",ptrGAS,
0,1,1);
```

Now we can put the wire inside:

```
chamber->AddNode(wire_co,1);
```

If we inspect now the chamber volume in a browser, we will notice that it has one daughter. Of course, the gas has some container also, but let us keep it like that for the sake of simplicity. Since we did not supply the third argument, the wire will be positioned with an identity transformation inside the chamber.

#### 18.4.2.6 Overlapping Volumes

Positioning volumes that does not overlap their neighbors nor extrude their container is sometimes quite strong constraint. Having a limited set of geometric shapes might force sometimes overlaps. Since overlapping is contradictory to containment, a point belonging to an overlapping region will naturally belong to all overlapping partners. The answer provided by the modeller to “Where am I?” is no longer deterministic if there is no priority assigned.

There are two ways out provided by the modeller in such cases and we will illustrate them by examples.

- Suppose we have 2 crossing tubes that we have to describe. Such a structure cannot be decomposed in a containment schema. This is a typical example of simple structure that can be handled by using composite shapes. What we have to do is to define as shapes the inner and outer parts of the tubes (tubes having  $R_{min}=0, R_{max}=inner/outer$  radius), then to make a composite:
- $C = (Tub1_{out}+Tub2_{out})-(Tub1_{in}+Tub2_{in})$
- On the other hand, if we have an EM calorimeter having a honeycomb structure, Boolean combinations do not help anymore. Here the problem is that we usually have a very large number of cells that are naturally belonging to the same container. This result in a very flat and slow structure for that particular container, which we would very much want to avoid by introducing additional levels in depth. We can describe the basic cell as a hexahedron that we can represent by using a polygon primitive shape. Instead of putting one by one all cells in the same container, we can define rows of such elements, fitting in box-shaped containers. Then we can put row-beside-row inside the container, making life much easier for its navigation algorithms. The problem is that in order to reproduce the honeycomb structure out of rows of cells, we have to overlap row containers. Woops - we have not obeyed rule No. 2 in positioning. The way out is to position our rows with a special prototype:

```
ptrCAL->AddNodeOverlap("ROW",nRow,matrixRow);
```

This will instruct the modeller that the daughter ROW inside CAL overlaps with something else. The modeller will check this at closure time and build a list of possibly overlapping candidates. This option is equivalent with the option MANY in GEANT3.

The modeller supports such cases only if user declares the overlapping nodes. In order to do that, one should use `TGeoVolume::AddNodeOverlap()` instead of `TGeoVolume::AddNode()`. When two or more positioned volumes are overlapping, not all of them have to be declared so, but at least one. A point inside an overlapping region equally belongs to all overlapping nodes, but the way these are defined can enforce the modeller to give priorities.

The general rule is that the deepest node in the hierarchy containing a point has the highest priority. For the same geometry level, non-overlapping is prioritized over overlapping. In order to illustrate this, we will consider few examples. We will designate non-overlapping nodes as ONLY and the others MANY as in GEANT3, where this concept was introduced:

1. The part of a MANY node B extruding its container A will never be “seen” during navigation, as if B was in fact the result of the intersection of A and B.
2. If we have two nodes A (ONLY) and B (MANY) inside the same container, all points in the overlapping region of A and B will be designated as belonging to A.
3. If A and B in the above case were both MANY, points in the overlapping part will be designated to the one defined first. Both nodes must have the same medium.
4. The slices of a divided MANY will be as well MANY.

One needs to know that navigation inside geometry parts MANY nodes is much slower. Any overlapping part can be defined based on composite shapes - might be in some cases a better way out.

#### 18.4.2.7 Replicating Volumes

What can we do if our chamber contains two identical wires instead of one? What if then we would need 1000 chambers in our detector? Should we create 2000 wires and 1000 chamber volumes? No, we will just need to replicate the ones that we have already created.

```
chamber->AddNode(wire_co,1,new TGeoTranslation(0.2,0,0));
chamber->AddNode(wire_co,2,new TGeoTranslation(0.2,0,0));
```

The 2 nodes that we have created inside chamber will both point to a `wire_co` object, but will be completely distinct: `WIRE_CO_1` and `WIRE_CO_2`. We will want now to place symmetrically 1000 chambers on a pad, following a pattern of 20 rows and 50 columns. One way to do this will be to replicate our chamber by positioning it 1000 times in different positions of the pad. Unfortunately, this is far from being the optimal way of doing what we want. Imagine that we would like to find out which of the 1000 chambers is containing a  $(x,y,z)$  point defined in the pad reference. You will never have to do that, since the modeller will take care of it for you, but let’s guess what it has to do. The most simple algorithm will just loop over all daughters, convert the point from mother to local reference and check if the current chamber contains the point or not. This might be efficient for pads with few chambers, but definitely not for 1000. Fortunately the modeller is smarter than that and creates for each volume some optimization structures called `voxels` to minimize the penalty having too many daughters, but if you have 100 pads like this in your geometry you will anyway loose a lot in your tracking performance. The way out when volumes can be arranged according to simple patterns is the usage of divisions. We will describe them in detail later on. Let’s think now at a different situation: instead of 1000 chambers of the same type, we may have several types of chambers. Let’s say all chambers are cylindrical and have a wire inside, but their dimensions are different. However, we would like all to be represented by a single volume family, since they have the same properties.

#### 18.4.2.8 Volume Families

A volume family is represented by the class `TGeoVolumeMulti`. It represents a class of volumes having the same shape type and each member will be identified by the same name and volume ID. Any operation applied to a `TGeoVolumeMulti` equally affects all volumes in that family. The creation of a family is generally not a user task, but can be forced in particular cases:

```
TGeoManager::Volume(const char *vname,const char *shape,
Int_t nmed);
```

Where: `vname` is the family name, `nmed` is the medium number and `shape` is the shape type that can be:

- `boxfor` `TGeoBBox`
- `trd1for` `TGeoTrd1`
- `trd2for` `TGeoTrd2`
- `trapfor` `TGeoTrap`
- `gtrafor` `TGeoGtra`
- `parafor` `TGeoPara`
- `tube`, `tubsfor` `TGeoTube`, `TGeoTubeSeg`

- cone, consfor TGeoCone, TGeoCons
- eltufor TGeoEltu
- ctubfor TGeoCtub
- pconfor TGeoPcon
- pgonfor TGeoPgon

Volumes are then added to a given family upon adding the generic name as node inside other volume:

```
TGeoVolume *box_family = gGeoManager->Volume("BOXES","box",nmed);
// ...
gGeoManager->Node("BOXES",Int_t copy_no,"mother_name",Double_t x,
Double_t y,Double_t z,Int_t rot_index,Bool_t is_only,
Double_t *upar,Int_t npar);
```

- BOXES- name of the family of boxes
- copy\_no- user node number for the created node
- mother\_name- name of the volume to which we want to add the node
- x,y,z- translation components
- rot\_index- index of a rotation matrix in the list of matrices
- upar- array of actual shape parameters
- npar- number of parameters

The parameters order and number are the same as in the corresponding shape constructors. Another particular case where volume families are used is when we want that a volume positioned inside a container to match one or more container limits. Suppose we want to position the same box inside 2 different volumes and we want the Z size to match the one of each container:

```
TGeoVolume *container1 = gGeoManager->MakeBox("C1",imed,10,10,30);
TGeoVolume *container2 = gGeoManager->MakeBox("C2",imed,10,10,20);
TGeoVolume *pvol      = gGeoManager->MakeBox("PVOL",jmed,3,3,-1);
container1->AddNode(pvol,1);
container2->AddNode(pvol,1);
```

Note that the third parameter of PVOL is negative, which does not make sense as half-length on Z. This is interpreted as: when positioned, create a box replacing all invalid parameters with the corresponding dimensions of the container. This is also internally handled by the **TGeoVolumeMulti** class, which does not need to be instantiated by users.

#### 18.4.2.9 Dividing Volumes

Volumes can be divided according a pattern. The simplest division can be done along one axis that can be: X,Y,Z,Phi,Rxy or Rxyz. Let's take a simple case: we would like to divide a box in N equal slices along X coordinate, representing a new volume family. Supposing we already have created the initial box, this can be done like:

```
TGeoVolume *slicex = box->Divide("SLICEX",1,N);
```

Here SLICEX is the name of the new family representing all slices and 1 is the slicing axis. The meaning of the axis index is the following: for all volumes having shapes like box, trd1, trd2, trap, gtraorpara -1, 2, 3 mean X, Y, Z; for tube, tubs, cone, cons -1 means Rxy, 2 means phi and 3 means Z; for pcon and pgon - 2 means phi and 3 means Z; for spheres 1 means Rand 2 means phi.

In fact, the division operation has the same effect as positioning volumes in a given order inside the divided container - the advantage being that the navigation in such a structure is much faster. When a volume is divided, a volume family corresponding to the slices is created. In case all slices can be represented by a single shape, only one volume is added to the family and positioned N times inside the divided volume, otherwise, each slice will be represented by a distinct volume in the family.

Divisions can be also performed in a given range of one axis. For that, one has to specify also the starting coordinate value and the step:



```
TGeoVolume *slicex = box->Divide("SLICEX",1,N,start,step);
```

A check is always done on the resulting division range: if not fitting into the container limits, an error message is posted. If we will browse the divided volume we will notice that it will contain N nodes starting with index 1 up to N. The first one has the lower X limit at **START** position, while the last one will have the upper X limit at **START+N\*STEP**. The resulting slices cannot be positioned inside another volume (they are by default positioned inside the divided one) but can be further divided and may contain other volumes:

```
TGeoVolume *slicey = slicex->Divide("SLICEY",2,N1);
slicey->AddNode(other_vol,index,some_matrix);
```

When doing that, we have to remember that **SLICEY** represents a family, therefore all members of the family will be divided on Y and the other volume will be added as node inside all.

In the example above all the resulting slices had the same shape as the divided volume (box). This is not always the case. For instance, dividing a volume with **TUBE** shape on **PHI** axis will create equal slices having **TUBESEG** shape. Other divisions can also create slices having shapes with different dimensions, e.g. the division of a **TRD1** volume on Z.

When positioning volumes inside slices, one can do it using the generic volume family (e.g. **slicey**). This should be done as if the coordinate system of the generic slice was the same as the one of the divided volume. The generic slice in case of **PHI** division is centered with respect to X-axis. If the family contains slices of different sizes, any volume positioned inside should fit into the smallest one.

Examples for specific divisions according to shape types can be found inside shape classes.

```
TGeoVolume::Divide(N,Xmin,Xmax,"X");
```

Create a new volume by dividing an existing one (GEANT3 like).

Divides **MOTHER** into **NDIV** divisions called **NAME** along axis **IAXIS** starting at coordinate value **START** and having size **STEP**. The created volumes will have tracking media **ID=NUMED** (if **NUMED=0** -> same media as **MOTHER**).

The behavior of the division operation can be triggered using **OPTION** (case insensitive):

- **N**divide all range in **NDIV** cells (same effect as **STEP<=0**) (**GSDVN** in G3)
- **NX**divide range starting with **START** in **NDIV** cells (**GSDVN2** in G3)
- **S**divide all range with given **STEP**; **NDIV** is computed and divisions will be centered in full range (same effect as **NDIV<=0**) (**GSDVS**, **GSDVT** in G3)
- **SX**same as **DVS**, but from **START** position (**GSDVS2**, **GSDVT2** in G3)

#### 18.4.2.10 Volume Assemblies

In general, geometry contains structures of positioned volumes that have to be grouped and handled together, for different possible reasons. One of these is that the structure has to be replicated in several parts of the geometry, or it may simply happen that they really represent a single object, too complex to be described by a primitive shape.

Usually handling structures like these can be easily done by positioning all components in the same container volume, then positioning the container itself. However, there are many practical cases when defining such a container is not straightforward or even possible without generating overlaps with the rest of the geometry. There are few ways out of this:

- Defining the container for the structure as “overlapping” (see also " Overlapping Volumes \*\*\*\*\*)
- Representing the container as a composite shape - the Boolean union of all components (see also " Composite Shapes “)
- Using an assembly volume - this will be described in the following.

The first two approaches have the disadvantage of penalizing the navigation performance with a factor increasing more than linear of the number of components in the structure. The best solution is the third one because it uses all volume-related navigation optimizations. The class **TGeoVolumeAssembly** represents an assembly volume. Its shape is represented by **TGeoShapeAssembly** class that is the union of all components. It uses volume voxelization to perform navigation tasks.

An assembly volume creates a hierarchical level and it geometrically insulates the structure from the rest (as a normal volume). Physically, a point that is **INSIDE** a **TGeoShapeAssembly** is always inside one of the components, so a **TGeoVolumeAssembly** does not need to have a medium. Due to the self-containment of assemblies, they are very practical to use when a container is hard to define due to possible overlaps during positioning. For instance, it is very easy creating honeycomb structures. A very useful example for creating and using assemblies can be found at: <http://root.cern.ch/root/html/examples/assembly.C.html>.

Creation of an assembly is very easy: one has just to create a **TGeoVolumeAssembly** object and position the components inside as for any volume:

```
TGeoVolume *vol = new TGeoVolumeAssembly(name);
vol->AddNode(vdaughter1, cpy1, matrix1);
vol->AddNode(vdaughter2, cpy2, matrix2);
```

Note that components cannot be declared as “overlapping” and that a component can be an assembly volume. For existing flat volume structures, one can define assemblies to force a hierarchical structure therefore optimizing the performance. Usage of assemblies does **NOT** imply penalties in performance, but in some cases, it can be observed that it is not as performing as bounding the structure in a container volume with a simple shape. Choosing a normal container is therefore recommended whenever possible.

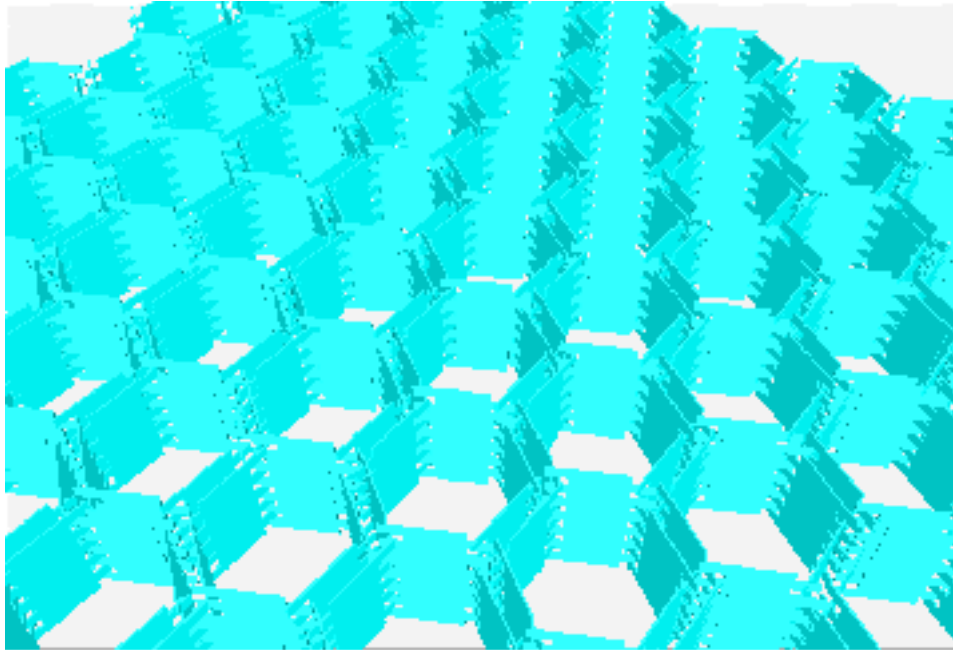

Figure 18.29: Assemblies of volumes

### 18.4.3 Geometrical Transformations

All geometrical transformations handled by the modeller are provided as a built-in package. This was designed to minimize memory requirements and optimize performance of point/vector master-to-local and local-to-master computation. We need to have in mind that a transformation in **TGeo** has two major use-cases. The first one is for defining the placement of a volume with respect to its container reference frame. This frame will be called ‘master’ and the frame of the positioned volume - ‘local’. If **T** is a transformation used for positioning volume daughters, then: **MASTER = T \* LOCAL**

Therefore **T** is used to perform a local to master conversion, while **T-1** for a master to local conversion. The second use case is the computation of the global transformation of a given object in the geometry. Since the geometry is built as ‘volumes-inside-volumes’, the global transformation represents the pile-up of all local transformations in the corresponding branch. Once a given object in the hierarchy becomes the current one, the conversion from master to local coordinates or the other way around can be done from the manager class.

A general homogenous transformation is defined as a 4x4 matrix embedding a rotation, a translation and a scale. The advantage of this description is that each basic transformation can be represented as a homogenous matrix, composition being performed as simple matrix multiplication.

$$\begin{array}{l}
 \text{Rotation:} \left| \begin{array}{cccc} r_{11} & r_{12} & r_{13} & 0 \\ r_{21} & r_{22} & r_{23} & 0 \\ r_{31} & r_{32} & r_{33} & 0 \\ 0 & 0 & 0 & 1 \end{array} \right| \quad \text{Translation:} \left| \begin{array}{cccc} 1 & 0 & 0 & 0 \\ 0 & 1 & 0 & 0 \\ 0 & 0 & 1 & 0 \\ t_x & t_y & t_z & 1 \end{array} \right| \quad \text{Scale:} \left| \begin{array}{cccc} s_x & 0 & 0 & 0 \\ 0 & s_y & 0 & 0 \\ 0 & 0 & s_z & 0 \\ 0 & 0 & 0 & 1 \end{array} \right| \\
 \\
 \text{Inverse rotation:} \left| \begin{array}{cccc} r_{11} & r_{21} & r_{31} & 0 \\ r_{12} & r_{22} & r_{32} & 0 \\ r_{13} & r_{23} & r_{33} & 0 \\ 0 & 0 & 0 & 1 \end{array} \right| \quad \text{Inverse translation:} \left| \begin{array}{cccc} 1 & 0 & 0 & 0 \\ 0 & 1 & 0 & 0 \\ 0 & 0 & 1 & 0 \\ -t_x & -t_y & -t_z & 1 \end{array} \right| \quad \text{Inverse scale:} \left| \begin{array}{cccc} \frac{1}{s_x} & 0 & 0 & 0 \\ 0 & \frac{1}{s_y} & 0 & 0 \\ 0 & 0 & \frac{1}{s_z} & 0 \\ 0 & 0 & 0 & 1 \end{array} \right|
 \end{array}$$

- $r_{ij}$  are the 3x3 rotation matrix components
- $t_x, t_y, t_z$  are the translation components
- $s_x, s_y, s_z$  are arbitrary scale constants on each axis

The disadvantage in using this approach is that computation for 4x4 matrices is expensive. Even combining two translations would become a multiplication of their corresponding matrices, which is quite an undesired effect. On the other hand, it is not a good idea to store a translation as a block of 16 numbers. We have therefore chosen to implement each basic transformation type as a class deriving from the same basic abstract class and handling its specific data and point/vector transformation algorithms.

The base class **TGeoMatrix** defines abstract methods for:

- Translation, rotation and scale getters. Every derived class stores only its specific data, e.g. a translation stores an array of 3 doubles and a rotation an array of 9. However, getting the **TGeoTranslation** rotation array through the base **TGeoMatrix** interface is a legal operation. The answer in this case is a pointer to a global constant array representing an identity rotation.

```

Double_t *TGeoMatrix::GetTranslation() const;
Double_t *TGeoMatrix::GetRotation() const;
Double_t *TGeoMatrix::GetScale() const;

```

- Master-to-local and local-to-master point and vector transformations :

```

void TGeoMatrix::MasterToLocal(const Double_t *master,
Double_t *local)
void TGeoMatrix::LocalToMaster(const Double_t *local,
Double_t *master)
void TGeoMatrix::MasterToLocalVect(const Double_t *master,
Double_t *local)
void TGeoMatrix::LocalToMasterVect(const Double_t *local,
Double_t *master)

```

Here *master* and *local* are arrays of size 3. These methods allow correct conversion also for reflections.

- Transformation type finding:

```

Bool_t TGeoMatrix::IsIdentity() const;
Bool_t TGeoMatrix::IsTranslation() const;
Bool_t TGeoMatrix::IsRotation() const;
Bool_t TGeoMatrix::IsScale() const;
Bool_t TGeoMatrix::IsCombi() const; // (tr. + rot.)
Bool_t TGeoMatrix::IsGeneral() const; // (tr. + rot. + scale)

```

Specific classes deriving from **TGeoMatrix** represent combinations of basic transformations. In order to define a matrix as a combination of several others, a special class **TGeoHMatrix** is provided. Here is an example of matrix creation:

### 18.4.3.1 Matrix Creation Example

```
TGeoRotation r1,r2;
r1.SetAngles(90,0,30);           //rotation defined by Euler angles
r2.SetAngles(90,90,90,180,0,0); //rotation defined by GEANT3 angles
TGeoTranslation t1(-10,10,0);
TGeoTranslation t2(10,-10,5);
TGeoCombiTrans c1(t1,r1);
TGeoCombiTrans c2(t2,r2);
TGeoHMatrix h = c1 * c2; // composition is done via TGeoHMatrix
TGeoHMatrix *ph = new TGeoHMatrix(hm); // class it is what we want
                                       // to use for positioning
                                       // a volume

ph->Print();
...
pVolume->AddNode(pVolDaughter,id,ph) // now ph is owned by
                                     the manager
```

### 18.4.3.2 Rule for Creation of Transformations

Unless explicitly used for positioning nodes (`TGeoVolume::AddNode()`) all matrices deletion have to be managed by users. Matrices passed to geometry have to be created by using `new()` operator and `TGeoManager` class is responsible for their deletion. Matrices that are used for the creation of composite shapes have to be named and registered to the manager class:

```
transf->SetName(name); // if not already named in the constructor
transf->RegisterYourself();
```

Generally, it is advisable to create all intermediate transformations used for making the final combined one on the heap:

```
TGeoRotation r1(...);
TGeoRotation r2(...);
TGeoHMatrix *mat = new TGeoHMatrix("name"); // we want to use only
                                             // this one in geometry

*mat = r1 * r2;
```

### 18.4.3.3 Available Geometrical Transformations

- Translations (`TGeoTranslation` class) represent a  $(dx,dy,dz)$  translation. The only data member is: `Double_t fTranslation[3]`. Translations can be added or subtracted.

```
TGeoTranslation t1;
t1->SetTranslation(-5,10,4);
TGeoTranslation *t2 = new TGeoTranslation(4,3,10);
t2->Subtract(&t1);
```

- Rotations (`TGeoRotation` class) represent a pure rotation. Data members are `Double_t fRotationMatrix[3*3]`. Rotations can be defined either by Euler angles, either, by GEANT3 angles:

```
TGeoRotation *r1 = new TGeoRotation();
r1->SetAngles(phi,theta,psi); // all angles in degrees
```

This represents the composition of: first a rotation about Z axis with angle phi, then a rotation with theta about the rotated X axis, and finally a rotation with psi about the new Z axis.

```
r1->SetAngles(th1,phi1,th2,phi2,th3,phi3)
```

This is a rotation defined in GEANT3 style. Theta and phi are the spherical angles of each axis of the rotated coordinate system with respect to the initial one. This construction allows definition of malformed rotations, e.g. not orthogonal. A check is performed and an error message is issued in this case.

Specific utilities: determinant, inverse.

- Scale transformations (**TGeoScale** class) - represent a scaled shrinking/enlargement, possibly different on all axes. Data members: `Double_t fScale[3]`. Not implemented yet.
- Combined transformations - represent a rotation followed by a translation. Data members: `Double_t fTranslation[3], TGeoRotation *fRotation`.

```
TGeoRotation *rot = new TGeoRotation("rot",10,20,30);
TGeoTranslation trans;
...
TGeoCombiTrans *c1 = new TGeoCombiTrans(trans,rot);
TGeoCombiTrans *c2 = new TGeoCombiTrans("somename",10,20,30,rot)
```

- General transformations: (**TGeoHMatrix** class) represent combined transformations in any order.
- Identity transformation: (**TGeoIdentity** class) is a generic identity transformation represented by a singleton class object `gGeoIdentity`.

#### 18.4.4 Ownership of Geometry Objects

The class **TGeoManager** class contains the entire API needed for building and tracking geometry. It defines a global pointer `gGeoManager` in order to be fully accessible from external code. The manager class is the owner of all geometry objects defined in a session; therefore, users must not try to control their deletion. It contains lists of media, materials, transformations, shapes and volumes. A special case is the one of geometrical transformations. When creating a matrix or a translation, this is by default owned by external objects. The manager class becomes owner of all transformations used for positioning volumes. In order to force the ownership for other transformations, one can use `TGeoMatrix::RegisterYourself()` method. Do not be therefore surprised that some transformations cannot be found by name when creating a composite shape for instance if you did not register them after creation.

Logical nodes (positioned volumes) are created and destroyed by the **TGeoVolume** class. Physical nodes and their global transformations are subjected to a caching mechanism due to the sometimes very large memory requirements of logical graph expansion. The total number of physical instances of volumes triggers the caching mechanism and the cache manager is a client of **TGeoManager**. The manager class also controls the drawing/checking package (**TGeoPainter** client). This is linked with ROOT graphical libraries loaded on demand in order to control visualization actions.

## 18.5 Navigation and Tracking

Tracking is the feature allowing the transport of a given particle knowing its kinematics. A state is determined by any combination of the position  $\vec{r}$  and direction  $\vec{n}$  with respect to the world reference frame. The direction  $\vec{n}$  must be a unit vector having as components the director cosines. The full classification of a given state will provide the following information: the deepest physical node containing the position vector, the distance to the closest boundary along the direction vector, the next physical node after propagating the current point with this distance and the safety distance to the nearest boundary. This information allows the propagation of particles inside a detector geometry by taking into account both geometrical and physical constraints.

We will hereby describe the user interface of **TGeo** to access tracking functionality. This allows either developing a tracker for simple navigation within a given geometry, either interfacing to an external tracking engine such as GEANT. Note that the abstract interface for external trackers can be found in `$ROOTSYS/vmc` folder and it can be used to run GEANT3, GEANT4 and FLUKA-based simulations (\*) by using directly a geometry described with ROOT.

The interface methods related to tracking are incorporated into **TGeoManager** class and implemented in the navigator class **TGeoNavigator**. In order to be able to start tracking, one has to define the initial state providing the starting point  $\vec{r}_0$  and direction  $\vec{n}_0$ . There are several ways of doing that.

### 18.5.1 TGeoNavigator Class

One geometry may have several independent navigators to query to localize points or compute distances. The geometry manager holds a list of active navigators accessible via:

```
TObjArray *navigators = gGeoManager->GetListOfNavigators();
```

Upon closing the geometry a default navigator is provided as first one in this list, but one may add its own via:

```
TGeoNavigator *navig = new TGeoNavigator(gGeoManager);
// Store the index of the user navigator
Int_t inav = gGeoManager->AddNavigator(navig);
// Make its own navigator the active one
gGeoManager->SetCurrentNavigator(inav);
// Switch between navigators
gGeoManager->SetCurrentNavigator(0);
```

A navigator holds several variables describing the current navigation state: current point position, current direction distance to next boundary, isotropic safety, pointer to current and next nodes as well as several tracking flags related to volume boundary conditions or other properties required for track propagation in geometry. Each geometry query affects these variables, so the only way in testing several navigation alternatives and remembering the active navigation state is to use parallel navigation. The following paragraphs will describe the usage of a single navigator. All setters/getters for navigation state parameters as well as navigation queries provided by **TGeoNavigator** are interfaced by **TGeoManager** and will act on the current navigator.

### 18.5.2 Initializing the Starting Point

The current point (x,y,z) known by the modeller is stored as `Double_t fCurrentPoint[3]` by the navigator class. This array of the three coordinates is defined in the current global reference system and can be retrieved any time:

```
Const Double_t *cpoint = gGeoManager->GetCurrentPoint();
```

Initializing this point can be done like:

```
gGeoManager->SetCurrentPoint(x,y,z);
// or:
gGeoManager->SetCurrentPoint(Double_t *point[3]);
```

### 18.5.3 Initializing the Direction

In order to move inside geometry starting with the current point, the modeller needs to know the current direction (nx,ny,nz). This direction is stored as `Double_t fCurrentDirection[3]` by the navigator and it represents a direction in the global frame. It can be retrieved with:

```
Const Double_t *cdir = gGeoManager->GetCurrentDirection();
```

The direction can be initialized in a similar manner as the current point:

```
gGeoManager->SetCurrentDirection(nx,ny,nz);
// or:
gGeoManager->SetCurrentDirection(Double_t *dir);
```

### 18.5.4 Initializing the State

Setting the initial point and direction is not enough for initializing tracking. The modeller needs to find out where the initial point is located in the geometrical hierarchy. Due to the containment based architecture of the model, this is the deepest positioned object containing the point. For illustrating this, imagine that we have a simple structure with a top volume A and another one B positioned inside. Since A is a top volume, its associated node A\_1 will define MARS and our simple hierarchy of nodes (positioned volumes) will be: /A\_1/B\_1. Suppose now that the initial point is contained by B\_1. This implies by default that the point is also contained by A\_1, since B\_1 have to be fully contained by this. After searching the point location, the modeller will consider that the point is located inside B\_1, which will be considered as the representative object (node) for the current state. This is stored as: `TGeoNode *TGeoManager::fCurrentNode` and can be asked from the manager class only after the 'Where am I?' was completed:

```
TGeoNode *current = gGeoManager->GetCurrentNode();
```

In order to find the location of the current point inside the hierarchy of nodes, after setting this point it is mandatory to call the 'Where am I?' method:

```
gGeoManager->FindNode();
```

In order to have more flexibility, there are in fact several alternative ways of initializing a modeller state:

```
// Setting the point and finding the state in one step:
gGeoManager->FindNode(Double_t x,Double_t y,Double_t z);
gGeoManager->FindNode(Double_t *point[3]);
// Setting both initial point and direction and finding the state:
gGeoManager->InitTrack(Double_t x,Double_t y,Double_t z,
Double_t nx, Double_t ny, Double_t nz);
gGeoManager->InitTrack(Double_t *point[3],Double_t *dir[3]);
```

Note that the current point coordinates can be changed and the state re-initialized at any time. This represents the 'Where am I?' geometrical query representing the basic navigation functionality provided by the modeller.

### 18.5.5 Checking the Current State

The current state and all variables related to this are essential during tracking and have to be checked several times. Besides the current point and direction, the following additional information can be retrieved from `TGeoManager` interface:

- The **current path**. This represents a string containing the names and copy numbers of all positioned objects in the current branch written in the /folder/folder/.../folder/file fashion. The final node pointed by the path is the deepest object containing the current point and is representative for the current state. All intermediate **folders** in the path are in fact also nodes "touched" by the current point, but having some "touched" containment. The current path can be retrieved only after the state was initialized and is useful for getting an idea of the current point location.

```
const char *path = gGeoManager->GetPath();
cout << "Current path is: " << path << endl;
/A_1/B_34/C_3/D_1
```

- The **current node, volume and material**. In order to take decisions on post-step or further stepping actions, one has to know these. In order to get a pointer to the current node one can do:

```
TGeoNode *cnode = gGeoManager->GetCurrentNode();
// then:
TGeoVolume *cvol = gGeoManager->GetCurrentVolume();
// or:
cvol = cnode->GetVolume();    // (*)
// then:
TGeoMaterial *cmat = cvol->GetMedium()->GetMaterial();
```



(\*) Note: If the current point is in fact outside the geometry, the current node pointer will not be NULL, but pointing to the top node.

In order to take decisions in such case one needs always to test:

```
if (gGeoManager->IsOutside()) {
    // current point is actually outside
    ... // corresponding action
}
```

Specific information related to the current volume/node like ID's or shape can be then retrieved from the corresponding objects.

- Current state **index**. The number of possible different states of the modeller corresponds to the number of different objects/paths in the geometry. This has nothing to do with the number of nodes, since the same node can be found on different branches. In other words, the number of states corresponds to the number of nodes in the **expanded geometry tree**. Since unfortunately this expansion from logical to physical hierarchy cannot be stored on regular basis due to the large size of the latter, one cannot directly assign state numbers. If the size of the expansion proves however to be small enough (less than about 50 million objects), a parallel structure storing these state indices is built and stored in memory. In such case each state automatically gets an index that can be retrieved after any state initialization. These indices can prove to be quite useful for being able to keep track of the navigation history and force certain states. Let's illustrate how this works with a simple example:
- Suppose we have a simple geometry with a volume B positioned twice inside a container A. Then A is positioned twice in a top container T. The complete list of logical nodes is: T\_1, A\_1, A\_2, B\_1, B\_2. On the other hand we will have more states than logical nodes:
  - /T\_1- 1 state at level = 0
  - /T\_1/A\_1,/T\_1/A\_2- 2 states at level = 1
  - /T\_1/A\_1/B\_1,/T\_1/A\_1/B\_2,/T\_1/A\_2/B\_1,/T\_1/A\_2/B\_2 - 4 states at level = 2
  - All these states will get automatic numbers, starting with 0 corresponding to the top-level state and ending with an integer corresponding to Ntotal\_states-1. The mapping from a given logical node to a state number is generally not possible, as for the node B\_1 that appears as current node for 2 different states. The numbering order of states is therefore not important, but it can be used as in the following lines:

```
gGeoManager->InitTrack(pt,dir); // anything to initialize a state
Int_t istate = gGeoManager->GetCurrentNodeId(); // in fact state Id
{
    //... code changing the current state
}
gGeoManager->CdNode(istate); // forces state's re-initialization
```

- Current **global transformation**. This represents the transformation from MARS to the local reference of the current node, being the product of all local mother-daughter transformations in the branch. The global transformation can be referenced or copied:

```
const TGeoHMatrix *global = gGeoManager->GetCurrentMatrix();
TGeoHMatrix *copy = new TGeoHMatrix(*global);
```

- One often needs to perform **master-to-local** and **local-to-master** point and vector conversions to get from MARS to the local node coordinates. This can be done by using the global transformation or directly the **TGeoManager** corresponding interfaces:

```
Double_t *glob_pt = gGeoManager->GetCurrentPoint();
Double_t *glob_dir = gGeoManager->GetCurrentDirection();
Double_t loc_pt[3], loc_dir[3];
// Go from MARS to local coordinates:
gGeoManager->MasterToLocal(glob_pt,loc_pt); // or:
global->MasterToLocal(glob_pt,loc_pt); // will be omitted from now
```



## 18.5.6 Saving and Restoring the Current State

As we already described, saving and restoring modeller states can be quite useful during tracking and is a feature extensively used by external tracking engines. We will call this navigation history management, which in most of the cases can be performed by handling the state identifiers. For quite big geometries, state indexing is not possible anymore and will be automatically disabled by the modeller. Fortunately there is a backup solution working in any condition: the modeller maintains a stack of states that is internally used by its own navigation algorithms, but user code is also allowed to access it. This works on any stack principle by using PUSH and POP calls and user code is responsible for popping the pushed states in order to keep the stack clean.

```
// push the current state in the stack
Int_t index = gGeoManager->PushPath();
// push state and current point
Int_t index = gGeoManager->PushPoint();
// retrieves the last pushed state (decrements stack index)
gGeoManager->PopPath();
// the same but retrieves also the point location
gGeoManager->PopPoint();
// just decrement stack index without changing state
gGeoManager->PopDummy();
// retrieves a state at given index without changing stack index
gGeoManager->PopPath(Int_t index);
```

## 18.5.7 Navigation Queries

After initializing the current state related to a given point and direction defined in MARS ('Where am I?'), one can query for several geometrical quantities. All the related algorithms work in the assumption that the current point has been localized inside the geometry (by the methods `TGeoManager::FindNode()` or `TGeoManager::InitTrack()`) and the current node or path has not been changed by the user.

### 18.5.7.1 Finding If Current State Is Changed For a New Point

One can find fast if a point different from the current one has or not the same location inside the geometry tree. To do that, the new point should not be introduced by using `TGeoManager::SetCurrentPoint()` method, but rather by calling the specific method:

```
Bool_t TGeoManager::IsSameLocation(Double_t x, Double_t y,
Double_t z, Bool_t change=kFALSE);
```

In the prototype above, `x`, `y` and `z` are the coordinates of the new point. The modeller will check whether the current volume still contains the new point or its location has changed in the geometry hierarchy. If the new location is different, two actions are possible according to the value of `change`:

- `change = kFALSE` (default) - the modeller does not change the current state but just inform the caller about this change.
- `change = kTRUE` - the modeller will actually perform a new 'Where am I?' search after finding out that the location has changed. The current state will be actualized accordingly.

Note that even when performing a normal search on the current state after changing the current point coordinates (e.g. `gGeoManager->FindNode(newX,newY,newZ)`), users can always query if the previous state has changed by using a method having the same name but without parameters:

```
Bool_t TGeoManager::IsSameLocation();
```

### 18.5.7.2 Finding the Distance to the Next Boundary

All tracking engines need to compare the currently proposed physical step with the maximum allowed distance in the current material. The modeller provides this information by computing the distance to the first boundary starting from the current point along a straight line. The starting point and direction for this procedure are the ones corresponding to the current state. The boundary search is initialized inside the current volume and the crossed boundary can belong either to the current node or to one of its daughters. The full prototype of the method is:

```
TGeoNode *TGeoManager::FindNextBoundary(Double_t step=kBig);
```

In the prototype above, besides the current point and direction that are supposed already initialized, the only input parameter is `step`. This represents the maximum step allowed by the tracking algorithm or the **physical step**. The modeller will search for a boundary crossing only up to a distance equal to this value. If a boundary is found, a pointer to the object (node) having it is returned; otherwise the method returns `NULL`.

The computed value for the computed distance can be subsequently retrieved from the manager class:

```
Double_t snext = gGeoManager->GetStep();
Double_t safety = gGeoManager->GetSafeDistance();
```

According the step value, two use cases are possible:

- `step = TGeoShape::kBig` (default behavior; `kBig = 1030`). In this case, there is no limitation on the search algorithm, the first crossed node is returned and the corresponding distance computed. If the current point is outside geometry and the top node is not crossed, the corresponding distance will be set to `kBig` and a `NULL` pointer returned. No additional quantity will be computed.
- `step < kBig`. In this case, the progressive search starting from the current point will be stopped after a distance equal with the supplied step. In addition to the distance to the first crossed boundary, the **safety radius** is also computed. Whenever the information regarding the maximum required step is known it is recommended to be provided as input parameter in order to speed-up the search.

In addition to the distance computation, the method sets an additional flag telling if the current track will enter inside some daughter of the current volume or it will exit inside its container:

```
Bool_t TGeoManager::IsStepEntering() const;
```

A combined task is to first find the distance to the next boundary and then extrapolate the current point/direction with this distance making sure that the boundary was crossed. Finally the goal would be to find the next state after crossing the boundary. The problem can be solved in principle using `FindNextBoundary`, but the boundary crossing can give unpredictable results due to numerical roundings. The manager class provides a method that allows this combined task and ensures boundary crossing. This should be used instead of the method `FindNextBoundary()` whenever the tracking is not imposed in association with an external MC transport engine (which provide their own algorithms for boundary crossing).

```
TGeoNode *TGeoManager::FindNextBoundaryAndStep(Double_t stepmax,
Bool_t comp_safe=kFALSE);
```

The meaning of the parameters here is the same as for `FindNextBoundary`, but the safety value is triggered by an input flag. The output is the node after the boundary crossing.

### 18.5.7.3 Computing the Safe Radius

Other important navigation query for tracking is the computation of the safe distance. This represents the **maximum step** that can be made from the current point in **any direction** that assures that no boundary will be crossed. Knowing this value gives additional freedom to the stepping algorithm to propagate the current track on the corresponding range **without checking** if the current state has changed. In other words, the modeller insures that the current state does not change in any point within the safety radius around the current point.

The computation of the safe radius is **automatically** computed any time when the next boundary is queried within a **limited step**:

```
TGeoNode *crossed = gGeoManager->FindNextBoundary(pstep);
Double_t safety = gGeoManager->GetSafeDistance();
```

Otherwise, the computation of safety can always be forced:

```
Double_t safety = gGeoManager->Safety();
```

#### 18.5.7.4 Making a Step

The modeller is able to make steps starting from the current point along the current direction and having the current step length. The new point and its corresponding state will be automatically computed:

```
TGeoNode *TGeoManager::Step(Bool_t is_geom = kTRUE,
Bool_t cross = kTRUE);
```

We will explain the method above by its use cases. The input flag `is_geom` allows specifying if the step is limited by geometrical reasons (a boundary crossing) or is an arbitrary step. The flag `cross` can be used in case the step is made on a boundary and specifies if user wants to cross or not the boundary. The returned node represents the new current node after the step was made.

- Making a geometrically contained step with boundary crossing (`is_geom=kTRUE`, `cross=kTRUE`) - This is the default method behavior. In this case, the step size is supposed to be already set by a previous `TGeoManager::FindNextBoundary()` call. Due to floating-point boundary uncertainties, making a step corresponding exactly to the distance to next boundary does not insure boundary crossing. If the method is called with this purpose, an extra small step will be made in order to make the crossing the most probable event (`epsil=10-6cm`). Even with this extra small step cannot insure 100% boundary crossing for specific crossed shapes at big incident angles. After such a step is made, additional cross-checks become available:

```
gGeoManager->FindNextBoundary(pstep);
Double_t snext = gGeoManager->GetStep();
// The geometrical step is taken
TGeoNode *newNode = gGeoManager->Step();
// The step=snext+epsil is made
Bool_t hasCrossed = gGeoManager->IsEntering();
// Is the boundary crossed or not?
Bool_t isOnBoundary = gGeoManager->IsOnBoundary(); // The proposed
// geometrically limited step to be made was smaller
// than epsil value.
Bool_t isOutside = gGeoManager->IsOutside();
//Did we exit geometry ?
```

In case the desired end-point of the step should be in the same starting volume, the input flag `cross` should be set to `kFALSE`. In this case, the `epsil` value will be subtracted from the current step.

- Making a step of arbitrary value (`is_geom=kFALSE`, `cross=no matter`). In this case, the step to be made can be either resulting from a `next` computation, either set by hand:

```
gGeoManager->SetStep(stepvalue);
gGeoManager->Step(kFALSE);
```

The step value in this case will exactly match the desired step. In case a boundary crossing failed after geometrically limited stepping, one can force as many small steps as required to really cross the boundary. This is not what generally happens during the stepping, but sometimes small rounding of boundary positions may occur and cause problems. These have to be properly handled by the stepping code.

### 18.5.7.5 The Normal Vector to the Next Crossed Surface at Crossing Point

Supposing we have found out that a particle will cross a boundary during the next step, it is sometimes useful to compute the normal to the crossed surface. The modeller uses the following convention: we define as **normal** ( $\vec{n}$ ) the unit vector perpendicular to a surface in the **next crossing point**, having the orientation such that:  $\vec{n} \cdot \vec{d} > 0$ . Here  $\vec{d}$  represents the current direction. The next crossing point represents the point where a ray shot from the current point along the current direction crosses the surface.

```
Double_t *TGeoManager::FindNormal(Bool_t forward=kTRUE);
```

The method above computes the normal to the next crossed surface in forward or backward direction (i.e. the current one), assuming the state corresponding to a current arbitrary point is initialized. An example of usage of normal computation is ray tracing.

The two most important features of the geometrical modeller concerning tracking are scalability and performance as function of the total number of physical nodes. The first refers to the possibility to make use of the available memory resources and at the same time be able to resolve any geometrical query, while the second defines the capability of the modeller to respond quickly even for huge geometries. These parameters can become critical when simulating big experiments like those at LHC.

### 18.5.8 Creating and Visualizing Tracks

In case the modeller is interfaced with a tracking engine, one might consider quite useful being able to store and visualize at least a part of the tracks in the context of the geometry. The base class **TVirtualGeoTrack** provides this functionality. It currently has one implementation inside the drawing package (**TGeoTrack** class). A track can be defined like:

```
TVirtualGeoTrack(Int_t id,Int_t pdg,TVirtualGeoTrack *parent=0,
TObject *particle=0);
```

Where: **id** is user-defined id of the track, **pdg** - pdg code, **parent** - a pointer to parent track, **particle** - a pointer to an arbitrary particle object (may be a **TParticle**).

A track has a list of daughters that have to be filled using the following method:

```
TVirtualGeoTrack *TVirtualGeoTrack::AddDaughter(Int_t id,Int_t pdg,
TObject *particle=0);
```

The method above is pure virtual and have to create a track daughter object. Tracks are fully customizable objects when inheriting from **TVirtualGeoTrack** class. We will describe the structure and functionality provided by the default implementation of these, which are **TGeoTrack** objects.

A **TGeoTrack** is storing a list of **control points** ( $x,y,z$ ) belonging to the track, having also time information ( $t$ ). The painting algorithm of such tracks allows drawing them in any time interval after their creation. The track position at a given time is computed by interpolation between control points.

```
myTrack->AddPoint(x,y,z,t);
```

The creation and management of tracks is in fact fully controlled by the **TGeoManager** class. This holds a list of **primary tracks** that is also visible during browsing as **Tracks** folder. Primary tracks are tracks having no parent in the tracking history (for instance the output of particle generators may be considered as primaries from tracking point of view). The manager class holds in **TGeoManager::fCurrentTrack** a pointer to the current track. **When starting tracking a particle, one can create a track object like:**

```
Int_t track_index = gGeoManager->AddTrack(id, pdg, ptrParticle);
```

Here **track\_index** is the index of the newly created track in the array of primaries. One can get the pointer of this track and make it known as current track by the manager class:

```
TVirtualGeoTrack *track = gGeoManager->GetTrack(track_index);
gGeoManager->SetCurrentTrack(track);
// or directly
gGeoManager->SetCurrentTrack(track_index);
TVirtualGeoTrack *current = gGeoManager->GetCurrentTrack();
```

One can also look for a track by user id or track index:

```
ptrTrack = gGeoManager->GetTrackOfId(user_id);
ptrParent = gGeoManager->GetParentTrackOfId(user_id);
ptrTrack = gGeoManager->GetTrack(index);
```

Supposing a particle represented by a primary track decays or interacts, one should not create new primaries as described before, but rather add them as secondary:

```
TVirtualGeoTrack *secondary =
ptrTrack->AddTrack(secondId,pdg,secondParticle);
```

At any step made by the current track, one is able to add control points to either primary or secondary:

```
track->AddPoint(x,y,z,t);
```

After tracks were defined and filled during tracking, one will be able to browse directly the list of tracks held by the manager class. Any track can be drawn using its `Draw()` and `Animate()` methods, but there are also global methods for drawing or animation that can be accessed from `TGeoManager` context menu:

```
TGeoManager::DrawTracks(Option_t *option);
TGeoManager::AnimateTracks(Double_t tmin=0.,Double_t tmax=1E-8,
Int_t nframes=200,Option_t *option="");
```

The drawing/animation time range is a global variable that can be directly set:

```
gGeoManager->SetTminTmax(tmin, tmax);
// without arguments resets the time range to the maximum value
```

Once set, the time range will be active both for individual or global track drawing. For animation, this range is divided to the desired number of frames and will be automatically updated at each frame in order to get the animation effect.

The option provided to all track-drawing methods can trigger different track selections:

**default:** A track (or all primary tracks) drawn without daughters

**/D:** Track and first level descendents only are drawn

**/\*:** Track and all descendents are drawn

**/Ntype:** All tracks having `name=type` are drawn

Generally several options can be concatenated in the same string (E.g. `"/D /Npion-`").

For animating tracks, additional options can be added:

**/G:** Geometry animate. Generally when drawing or animating tracks, one has to first perform a normal drawing of the geometry as convenient. The tracks will be drawn over the geometry. The geometry itself will be animated (camera moving and rotating in order to “catch” the majority of current track segments.)

**/S:** Save all frames in gif format in the current folder. This option allows creating a movie based on individual frames.



## 18.6 Checking the Geometry

Several checking methods are accessible from the context menu of volume objects or of the manager class. They generally apply only to the visible parts of the drawn geometry in order to ease geometry checking, and their implementation is in the **TGeoChecker** class. The checking package contains an overlap checker and several utility methods that generally have visualization outputs.

### 18.6.1 The Overlap Checker

An overlap is any region in the Euclidian space being contained by more than one positioned volume. Due to the containment scheme used by the modeller, all points inside a volume have to be also contained by the mother therefore are overlapping in that sense. This category of overlaps is ignored due to the fact that any such point is treated as belonging to the deepest node in the hierarchy.

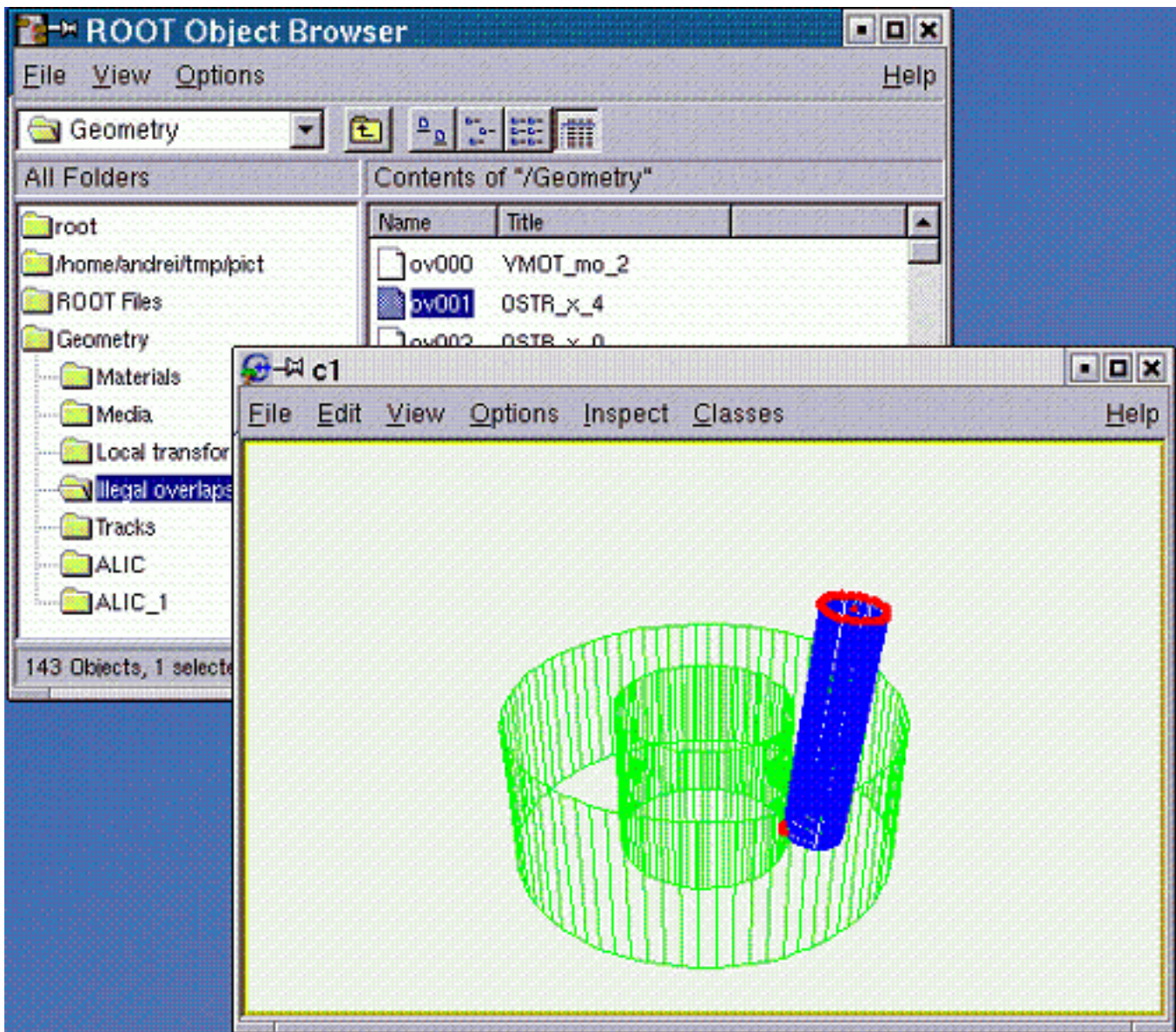

Figure 18.30: Extruding volumes

A volume containment region is in fact the result of the subtraction of all daughters. On the other hand, there are two other categories of overlaps that are considered illegal since they lead to unpredictable results during tracking.

- A) If a positioned volume contains points that are not also contained by its mother, we will call the corresponding region

as an **extrusion**. When navigating from outside to inside (trying to enter such a node) these regions are invisible since the current track has not yet reached its mother. This is not the case when going the other way since the track has first to exit the extruding node before checking the mother. In other words, an extrusion behavior is dependent on the track parameters, which is a highly undesirable effect.

- B) We will call **overlaps** only the regions in space contained by more than one node inside the same container. The owner of such regions cannot be determined based on hierarchical considerations; therefore they will be considered as belonging to the node from which the current track is coming from.

When coming from their container, the ownership is totally unpredictable. Again, the ownership of overlapping regions highly depends on the current track parameters.

We must say that even the overlaps of type A) and B) are allowed in case the corresponding nodes are created using `TGeoVolume::AddNodeOverlap()` method. Navigation is performed in such cases by giving priority to the non-overlapping nodes. The modeller has to perform an additional search through the overlapping candidates. These are detected automatically during the geometry closing procedure in order to optimize the algorithm, but we will stress that extensive usage of this feature leads to a drastic deterioration of performance. In the following we will focus on the non-declared overlaps of type A) and B) since this is the main source of errors during tracking. These are generally non-intended overlaps due to coding mistakes or bad geometry design. The checking package is loaded together with the painter classes and contains an automated overlap checker.\*\*

This can be activated both at volume level (checking for illegal overlaps only one level inside a given volume) and from the geometry manager level (checking full geometry):

```
myVolume->CheckOverlaps(precision, option);
gGeoManager->CheckOverlaps(precision);
myNode->CheckOverlaps(precision);
```

Here precision represents the desired maximum accepted overlap value in centimeters (default value is 0.1). This tool checks all possible significant pairs of candidates inside a given volume (not declared as overlapping or division volumes). The check is performed by verifying the mesh representation of one candidate against the shape of the other. This sort of check cannot identify all possible overlapping topologies, but it works for more than 95% and is much faster than the usual shape-to-shape comparison. For a 100% reliability, one can perform the check at the level of a single volume by using `option="d"` or `option="d<number>"` to perform overlap checking by sampling the volume with `<number>` random points (default 1 million). This produces also a picture showing in red the overlapping region and estimates the volume of the overlaps.

An extrusion A) is declared in any of the following cases:

- At least one of the vertices of the daughter mesh representation is outside the mother volume (in fact its shape) and having a safety distance to the mother greater than the desired value;
- At least one of the mother vertices is contained also by one of its daughters, in the same conditions.

An overlap B) is declared if:

- At least one vertex of a positioned volume mesh is contained (having a safety bigger than the accepted maximum value) by other positioned volume inside the same container. The check is performed also by inverting the candidates.

The code is highly optimized to avoid checking candidates that are far away in space by performing a fast check on their bounding boxes. Once the checking tool is fired-up inside a volume or at top level, the list of overlaps (visible as Illegal overlaps inside a **TBrowser**) held by the manager class will be filled with **TGeoOverlap** objects containing a full description of the detected overlaps. The list is sorted in the decreasing order of the overlapping distance, extrusions coming first. An overlap object name represents the full description of the overlap, containing both candidate node names and a letter (x-extrusion, o-overlap) representing the type. Double-clicking an overlap item in a **TBrowser** produces a picture of the overlap containing only the two overlapping nodes (one in blue and one in green) and having the critical vertices represented by red points. The picture can be rotated/zoomed or drawn in X3d as any other view. Calling `gGeoManager->PrintOverlaps()` prints the list of overlaps.

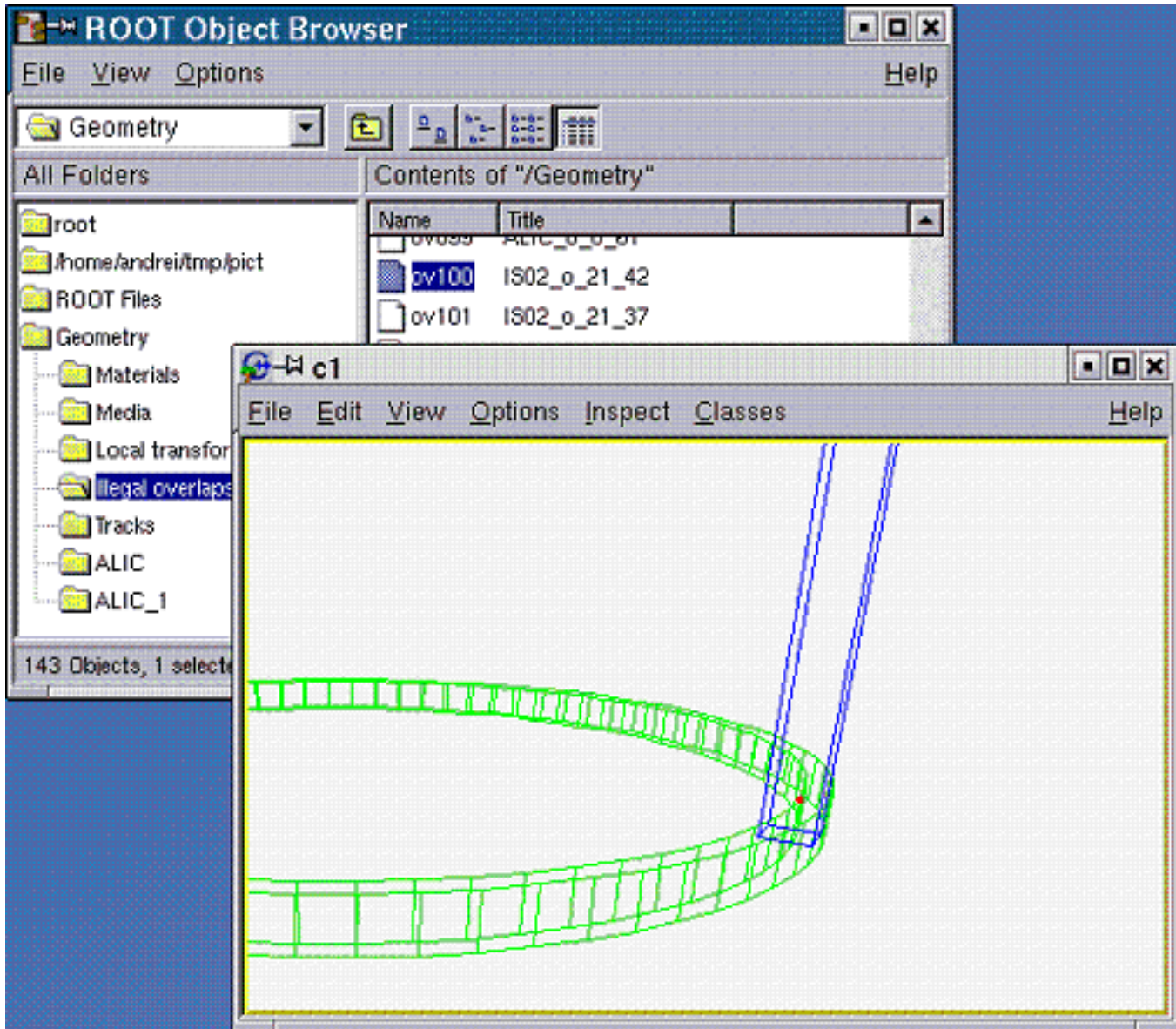

Figure 18.31: Overlap checking



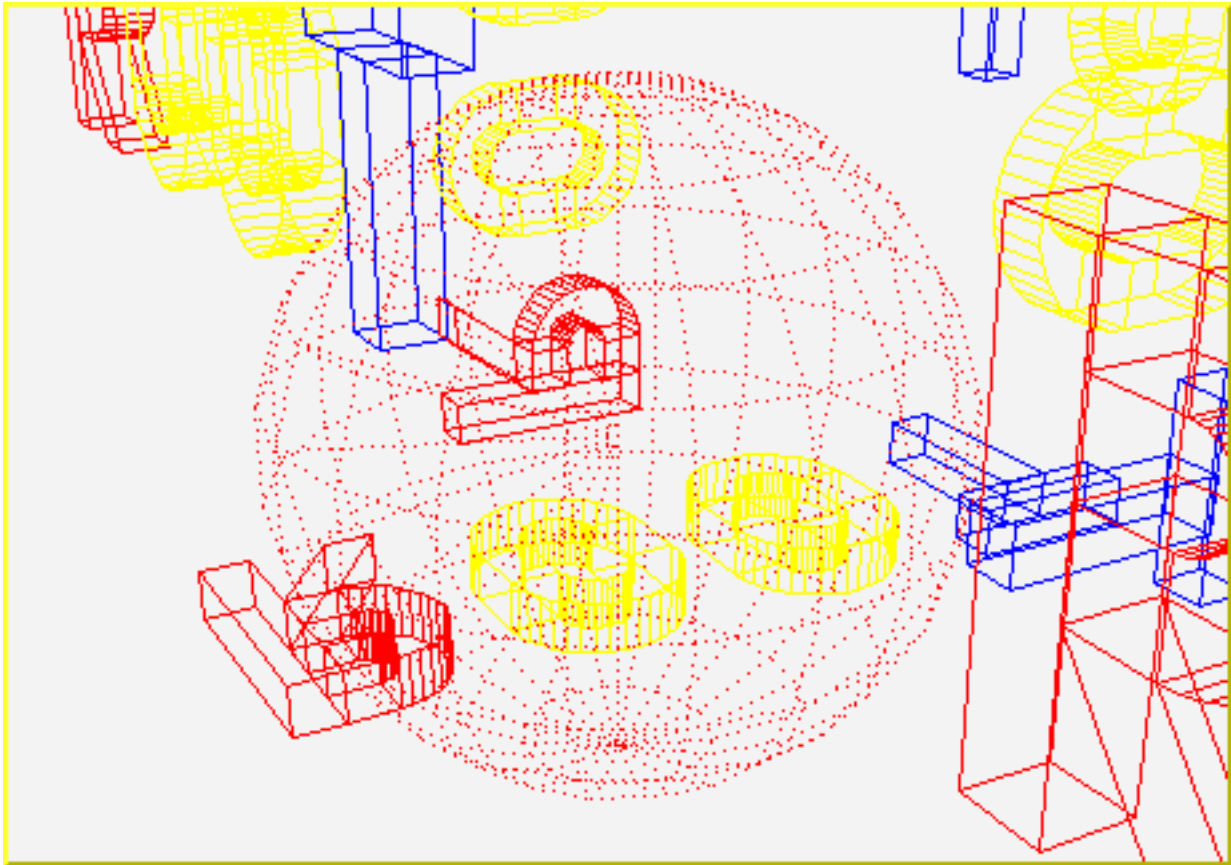

Figure 18.32: Safety computation checking

### 18.6.2 Graphical Checking Methods

In order to check a given point, `CheckPoint(x,y,z)` method of `TGeoManager` draws the daughters of the volume containing the point one level down, printing the path to the deepest physical node holding this point. It also computes the closest distance to any boundary.

A method to check the validity of a given geometry is shooting random points. This can be called with the method `TGeoVolume::RandomPoints()` and it draws a volume with the current visualization settings. Random points are generated in the bounding box of the drawn volume. The points are drawn with the color of their deepest container. Only points inside visible nodes are drawn.

A ray tracing method can be called `TGeoVolume::RandomRays()`. This shoots rays from a given point in the local reference frame with random directions. The intersections with displayed nodes appear as segments having the color of the touched node.

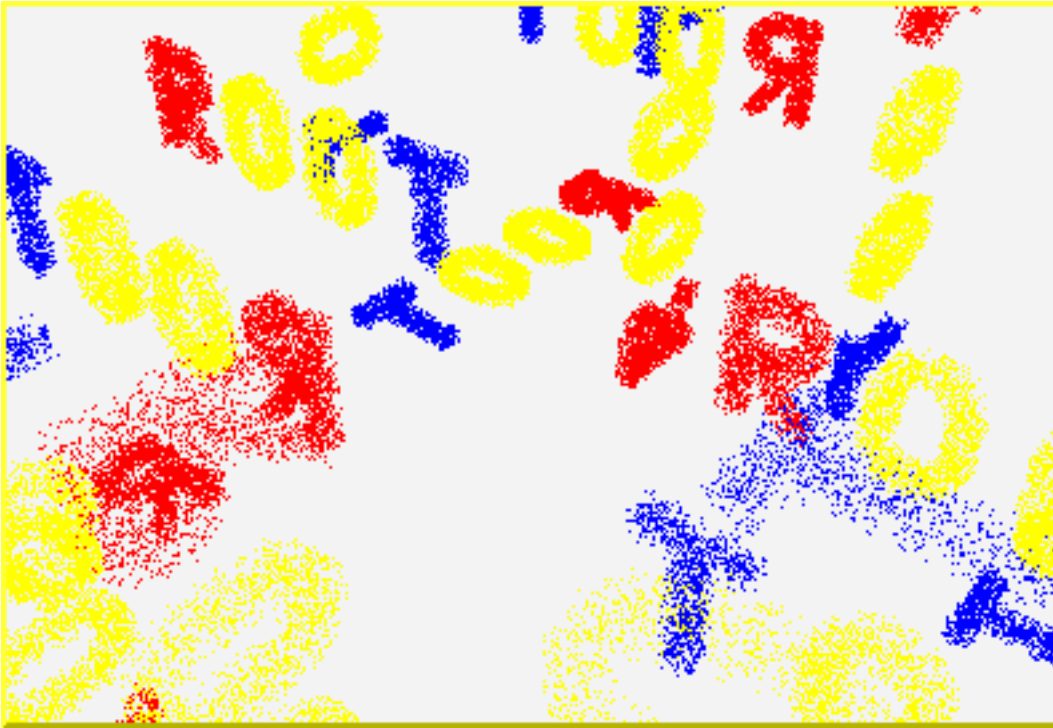

Figure 18.33: Random points

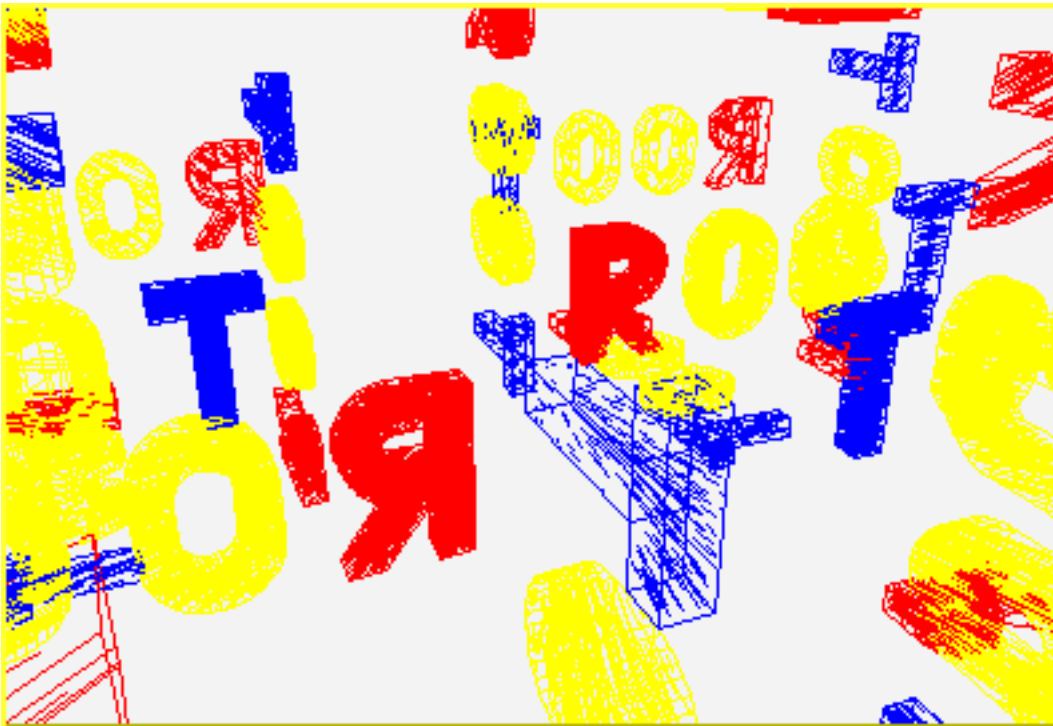
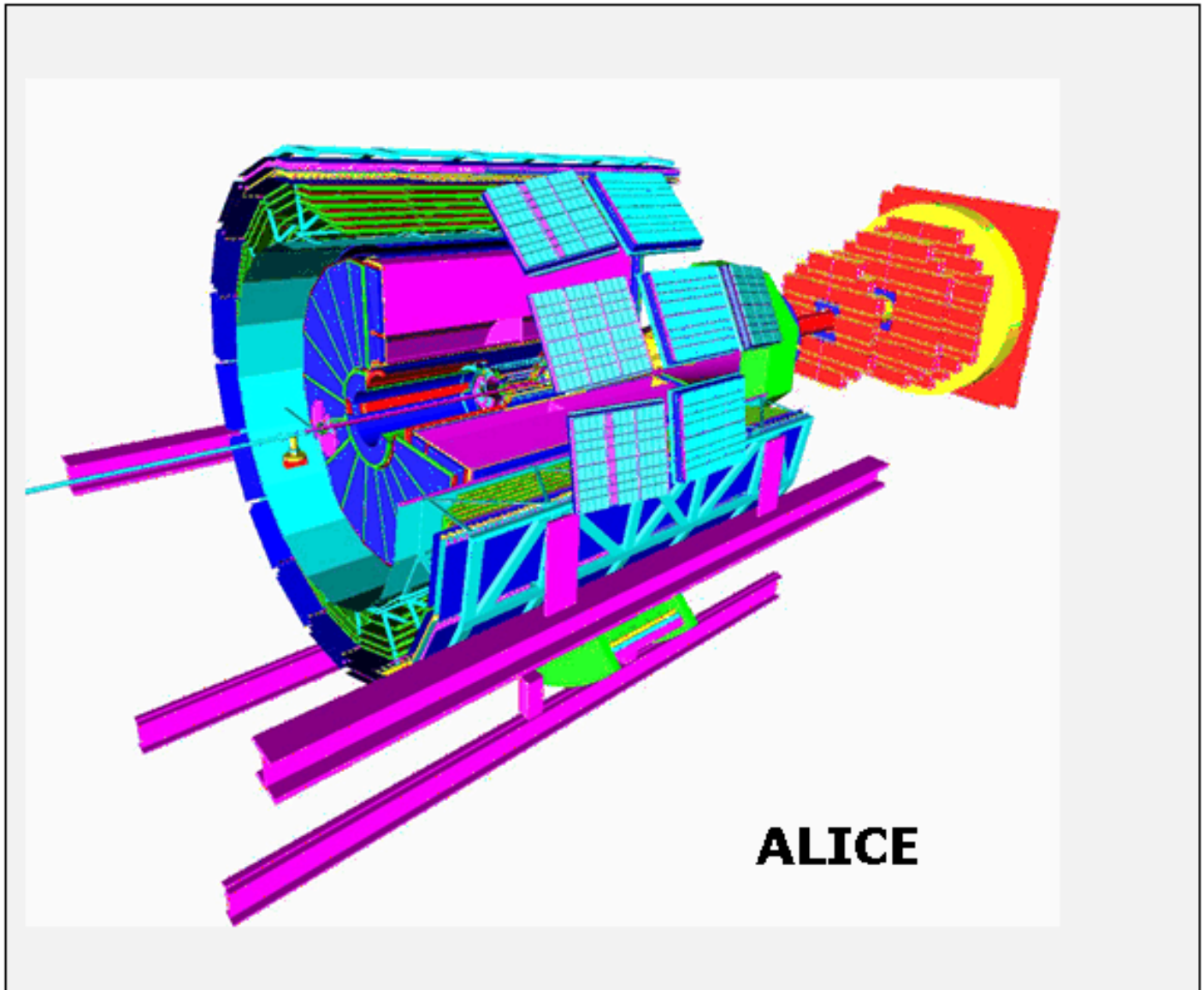

Figure 18.34: Random rays

## 18.7 The Drawing Package



The

modeller provides a powerful drawing package, supporting several different options of visualization. A library separated from the main one provides all functionality being linked with the underlying ROOT visualization system. This library is dynamically loaded by the plug-in manager only when drawing features are requested. The geometrical structures that can be visualized are volumes and volume hierarchies.

The main component of the visualization system is volume primitive painting in a ROOT pad. Starting from this one, several specific options or subsystems are available, like: X3D viewing using hidden line and surface removal algorithms, OpenGL viewing\* or ray tracing.

The method `TGeoManager::GetGeomPainter()` loads the painting library in memory.

This is generally not needed since it is called automatically by `TGeoVolume::Draw()` as well as by few other methods setting visualization attributes.

### 18.7.1 Drawing Volumes and Hierarchies of Volumes

The first thing one would like to do after building some geometry is to visualize the volume tree. This provides the fastest validation check for most common coding or design mistakes. As soon as the geometry is successfully closed, one should draw it starting from the top-level volume:

```
//... code for geometry building
root [] gGeoManager->CloseGeometry();
root [] gGeoManager->GetMasterVolume()->Draw();
```

Doing this ensures that the original top-level volume of the geometry is drawn, even if another volume is currently the geometry `root`. OK, I suppose you already did that with your simple geometry and immediately noticed a new ROOT canvas popping-up and having some more or less strange picture inside. Here are few questions that might come:

- *Q: "The picture is strangely rotated; where are the coordinate axes?"*

**A:** If drawn in a new canvas, any view has some default viewpoint, center of view and size. One can then perform mouse/keyboard actions to change them:

- Mouse left-click and drag will rotate the view;
- Some keys can be pressed when the view canvas is selected: J/K zoom/un-zoom, U/I move up/down, L/H move left/right. The coordinate axes display as well as changing top or side viewpoints can be activated from the **TView** context menu: right-click on the picture when no object is selected;
- *Q: "Every line is black! I cannot figure out what is what..."*

**A:** Volumes can have different colors (those known by ROOT of course). Think at using them after each volume creation: `myvolume->SetLineColor(Int_t color)`; otherwise everything is by default black.

- *Q: "The top volume of my geometry is a box but I see only its content."*

**A:** By default the drawn volume is not displayed just because we do not want to hide its content when changing the view to HLR or solid mode. In order to see it in the default wire frame picture one has to call `TGeoManager::SetTopVisible()`.

- *Q: "I do not see all volumes in my tree but just something inside."*

**A:** By default, `TGeoVolume::Draw()` paints the content of a given volume three levels down. You can change this by using: `gGeoManager::SetVisLevel(n)`;

Not only that, but none of the volumes at intermediate levels (0-2) are visible on the drawing unless they are final 'leaves' on their branch (e.g. have no other volumes positioned inside). This behavior is the default one and corresponds to 'leaves' global visualization mode (`TGeoManager::fVisOption = 1`). **In order to see on the screen the intermediate containers, one can change this mode: `gGeoManager->SetVisOption(0)`.**

- *Q: "Volumes are highlighted when moving the mouse over their vertices. What does it mean?"*

**A:** Indeed, moving the mouse close to some volume vertices selects it. By checking the **Event Status** entry in the root canvas **Options** menu, you will see exactly which is the selected node in the bottom right. Right-clicking when a volume is selected will open its context menu where several actions can be performed (e.g. drawing it).

- *Q: "OK, but now I do not want to see all the geometry, but just a particular volume and its content. How can I do this?"*

**A:** Once you have set a convenient global visualization option and level, what you need is just call the `Draw()` method of your interesting volume. You can do this either by interacting with the expanded tree of volumes in a ROOT browser (where the context menu of any volume is available), either by getting a pointer to it (e.g. by name): `gGeoManager->GetVolume("vol_name")->Draw()`;

## 18.7.2 Visualization Settings and Attributes

Supposing you now understand the basic things to do for drawing the geometry or parts of it, you still might be not happy and wishing to have more control on it. We will describe below how you can tune some fine settings. Since the corresponding attributes are flags belonging to volume and node objects, you can change them at any time (even when the picture is already drawn) and see immediately the result.

### 18.7.2.1 Colors and Line Styles

We have already described how to change the line colors for volumes. In fact, volume objects inherit from `TAttLine` class so the line style or width can also be changed:

```
myVolume->SetLineColor(kRed);
myVolume->SetLineWidth(2);
myVolume->SetLineStyle(kDotted);
```

When drawing in solid mode, the color of the drawn volume corresponds to the line color.

### 18.7.2.2 Visibility Settings

The way geometry is build forces the definition of several volumes that does not represent real objects, but just virtual containers used for grouping and positioning volumes together. One would not want to see them in the picture. Since every volume is by default visible, one has to do this sort of tuning by its own:

```
myVolumeContainer->SetVisibility(kFALSE);
```

As described before, the drawing package supports two main global options: 1 (default) - only final volume leaves; 0 - all volumes down the drawn one appear on the screen. The global visible level put a limitation on the maximum applied depth. Combined with visibility settings per volume, these can tune quite well what should appear on the screen. However, there are situations when users want to see a volume branch displayed down to the maximum depth, keeping at the same time a limitation or even suppressing others. In order to accomplish that, one should use the volume attribute: `Visible daughters`. By default, all daughters of all volumes are displayed if there is no limitation related with their level depth with respect to the top drawn volume.

## 18.7.3 Ray Tracing

Ray tracing is a quite known drawing technique based on tracking rays from the eye position through all pixels of a view port device. The pixel color is derived from the properties of the first crossed surface, according some illumination model and material optical properties. While there are currently existing quite sophisticated ray tracing models, `TGeo` is currently using a very simple approach where the light source is matching the eye position (no shadows or back-tracing of the reflected ray). In future we are considering providing a base class in order to be able to derive more complex models.

Due to the fact that the number of rays that have to be tracked matches the size in pixels of the pad, the time required by this algorithm is proportional to the pad size. On the other hand, the speed is quite acceptable for the default ROOT pad size and the images produced by using this technique have high quality. Since the algorithm is practically using all navigation features, producing ray-traced pictures is also a geometry validation check. Ray tracing can be activated at volume level as the normal `Draw()`.

```
myVolume->Raytrace()
```

Once ray-tracing a view, this can be zoomed or rotated as a usual one. Objects on the screen are no longer highlighted when picking the vertices but the corresponding volumes is still accessible.

### 18.7.3.1 Clipping Ray-traced Images

A ray-traced view can be `clipped` with any shape known by the modeller. This means that the region inside the clipping shape is subtracted from the current drawn geometry (become invisible). In order to activate clipping, one has to first define the clipping shape(s):

1. `TGeoShape *clip1, *clip2, ...`

One might switch between several clipping shapes. Note that these shapes are considered defined in the current `MARS`. Composite shapes may be used.

2. `gGeoManager->SetClippingShape(clip1);`

One can activate or deactivate clipping at any time: `gGeoManager->SetClipping(flag);`



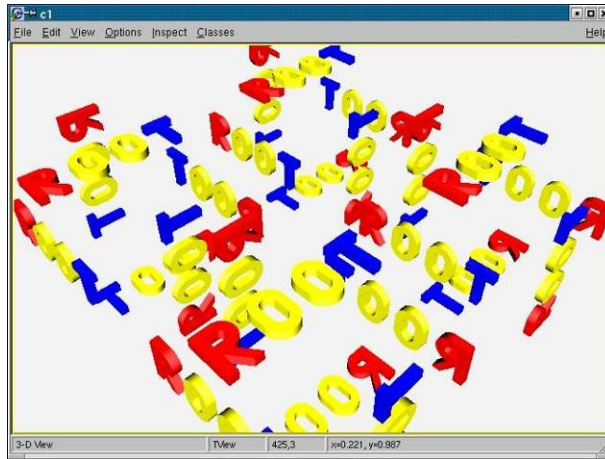

Figure 18.35: Ray-traced view in a pad

3. Perform ray-tracing: `gGeoManager->GetTopVolume()->Raytrace();`

One can redo the steps 2-3 as many times as needed. Let us look how the `rootgeom` example looks clipped with a tube.

## 18.8 Representing Misalignments of the Ideal Geometry

The ideal positioning of a detector does not match its position in the experimental hall. This generally happens not only for the detector modules, but also for their components. The accurate knowledge of the detector real misalignments can be extremely important for getting close to its designed resolution and the expected tracking efficiency. **TGeo** offers tools for representing positioning misalignments, applying them to the ideal geometry and performing navigation under these conditions. Detector tracking algorithms can then directly query the geometry for navigation purposes or for retrieving actual misalignment information.

### 18.8.1 Physical Nodes

Physical nodes are the actual “touchable” objects in the geometry, representing actually a path of positioned volumes starting with the top node: `path=/TOP/A_1/B_4/C_3`, where A, B, C represent names of volumes. The number of physical nodes is given by the total number of possible of branches in the geometry hierarchy. In case of detector geometries and specially for calorimeters this number can be of the order 106-109, therefore it is impossible to create all physical nodes as objects in memory. In **TGeo**, physical nodes are represented by the class **TGeoPhysicalNode** and can be created on demand for alignment purposes:

```
TGeoPhysicalNode(const char* path)
```

The knowledge of the path to the objects that need to be misaligned is essential since there is no other way of identifying them. One can however create “symbolic links” to any complex path to make it more representable for the object it designates:

```
TGeoPNEEntry(const char* unique_name, const char* path)
void TGeoPNEEntry::SetPhysicalNode(TGeoPhysicalNode *node)
```

Such a symbolic link hides the complexity of the path to the align object and replaces it with a more meaningful name. In addition, **TGeoPNEEntry** objects are faster to search by name and they may optionally store an additional user matrix.

```
// Creating a symlink object.
TGeoPNEEntry *TGeoManager::SetAlignableEntry(const char *unique_n,
const char*path)
```

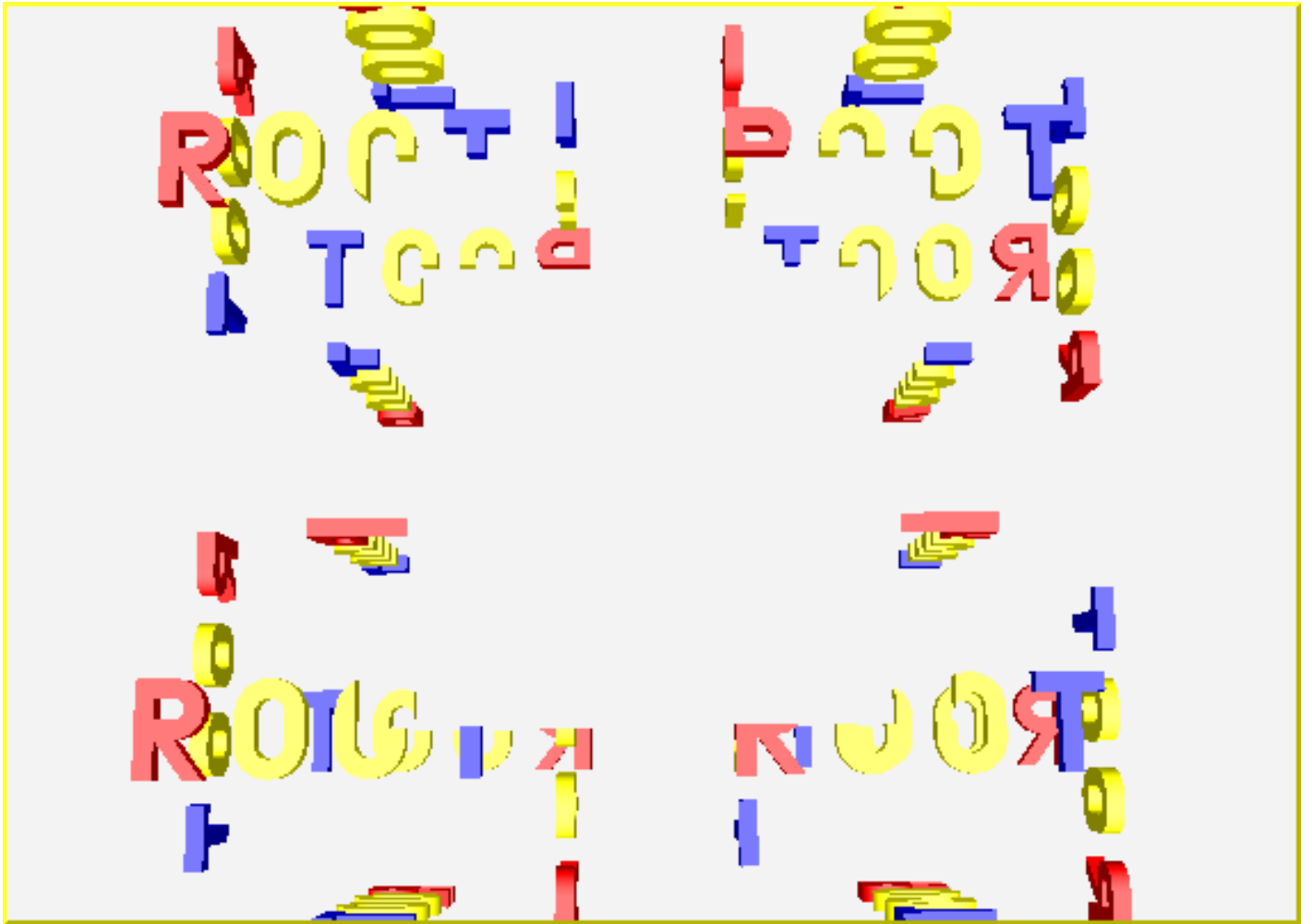

Figure 18.36: Ray-tracing example with box-clipping

```
// Retrieving an existing alignable object.
TGeoPNode *TGeoManager::GetAlignableEntry(const char *name)
// Retrieving an existing alignable object at a given index.
TGeoPNode *GetAlignableEntry(Int_t index)
```

Physical nodes store internally the full list of logical nodes corresponding to the elements from the string path, as well as the global transformation matrix for each of them. The top node corresponds to the level 0 in the stored array, while the last node will correspond to level n. For each level, the node, volume and global matrix can be retrieved using corresponding getters:

```
TGeoHMatrix *GetMatrix(Int_t level=-1) const
TGeoNode *GetNode(Int_t level=-1) const
TGeoShape *GetShape(Int_t level=-1) const
TGeoVolume *GetVolume(Int_t level=-1) const
```

By default the object at level n is retrieved (the alignable object).

Once created, a physical node can be misaligned, meaning that its positioning matrix or even the shape.:

```
void Align(TGeoMatrix* newmat=0, TGeoShape* newshape=0,
Bool_t check=kFALSE)
```

The convention used is that newmat represents the new local matrix of the last node in the branch with respect to its mother volume. The `Align()` method will actually duplicate the corresponding branch within the logical hierarchy, creating new volumes and nodes. This is mandatory in order to avoid problems due to replicated volumes and can create exhaustive memory consumption if used abusively.

Once aligned, a physical node is ready to be tracked. The operation can be done only after the geometry was closed.

Important NOTE: Calling the `Align()` method for a physical node changes the node pointers for the stored node branch in the active geometry, Due to this the other defined physical nodes containing elements of this path will be invalid. Example:

```
TGeoPhysicalNode *pn1 =
gGeoManager->MakePhysicalNode("/A_1/B_1/C_2");
TGeoPhysicalNode *pn2 =
gGeoManager->MakePhysicalNode("/A_1/B_1/C_3");
...
pn1->Align(...);
```

The call to `pn1->Align()` will invalidate the pointer to the node B\_1 in pn2 object.. The way out is to either call `pn1->Align()` before the creation of pn2, either to use a global method that will correct all existing physical nodes:

```
void RefreshPhysicalNodes(Bool_t lock = kTRUE)
```

The method above will optionally lock the possibility of doing any further misalignment.

## 18.9 Geometry I/O

Once geometry is successfully built, it can be saved in a root file, as C++ macro or as GDML file by calling:

```
TGeoManager::Export(const char *filename,const char*keyname="",
Option_t *opt="vg")
```

- `Filename` is the name of the file to be written (mandatory). Depending on the extension of the file, the geometry is exported either as root file or .C(.cxx) macro or GDML file in case extension is .gdml.
- `keyname` is the name of the key in the file (default “”)



- `opt = "v"` is an export voxelization (default), otherwise voxelization is recomputed after loading the geometry, `"g"` this option (default) is taken into account only for exporting to gdml file and it ensures compatibility with Geant4 (e.g. it adds extra plane to incorrectly set polycone, it checks whether offset of Phi division is in  $(-360;0>$  range, ...), for this gdml export there are two more option, that are not set by default: `"f"` and `"n"`. If none of this two options are set, then names of solids and volumes in resulting gdml file will have incremental suffix (e.g. TGeoBBox\_0x1, TGeoBBox\_0x2, ...). If `"f"` option is set then then suffix will contain pointer of object (e.g. TGeoBBox\_0xAAAAA01, ...). Finally if option `"n"` is set then no suffix will be added, though in this case uniqueness of the names is not ensured and it can cause that file will be invalid.

Loading geometry from a root file can be done in the same way as for any other ROOT object, but a static method is also provided:

```
TGeoManager::Import(const char *filename, const char *keyname="",
Option_t *opt="")
```

Example:

```
// Writing to a file geometry definition ending with:
root [] gGeoManager->CloseGeometry();
// geometry is ready
root [] gGeoManager->Export("MyGeom.root");
// file MyGeom.root produced
root [] gGeoManager->Export("MyGeom.C");
// C++ macro MyGeom.C produced
root [] gGeoManager->Export("MyGeom.gdml");
// GDML file MyGeom.gdml produced
root [] myVolume->SaveAs("MyVolume.C");
// C++ macro for the branch starting
// with MyVolume
// Reading from a file
root [] gSystem->Load("libGeom");
root [] TGeoManager::Import("MyGeom.root"); // geometry is ready
```

Note that not all-current information held by the modeller is written on the file. For instance, the painter and checker objects are not written, as well as the temporary current navigation properties: current node path, point or direction. On the other hand, all objects belonging to the geometrical hierarchy will always be written. The idea is to be able to retrieve the geometry in a ready state, ignoring what the state variables that can be always re-initialized. When the code is generated for a given **TGeoVolume** in the geometry, just the branch starting with that volume will be saved in the file. Executing the generated code will create a geometry that has **MyVolume** as top volume. In this case, only the materials/media/matrices used effectively in the **MyVolume** branch are exported to file.

Volumes can be made persistent in the same way the full geometry is. Exporting is straightforward (module1, 2 are pointers to **TGeoVolume** objects):

```
module1->Export("file.root");
// by default file is overwritten
module2->Export("file.root", "", "update");
// to the same file
```

Importing will append the volume to the current TGeoManager or will create one:

```
TGeoManager *geom = new TGeoManager("myGeom", "");
TGeoVolume *top = geom->MakeBox(...);
geom->SetTopVolume(top);
//name of volume or key (depending on export usage)
TGeoVolume *module1 = TGeoVolume::Import("file.root", "MOD1");
TGeoVolume *module2 = TGeoVolume::Import("file.root", "MOD2");
top->AddNode(module1, 1, new TGeoTranslation(0,0,100));
top->AddNode(module2, 1, new TGeoTranslation(0,0,-100));
// One should close himself the geometry
geom->CloseGeometry();
```

### 18.9.1 GDML

Few lines above word GDML was used. GDML stands for **Geometry Description Markup Language**. It is an application-independent geometry description format based on XML. It is mainly used for geometry interchange between ROOT and Geant4 framework. More details about this project can be found <http://gdml.web.cern.ch>. This feature (importing/exporting from/to gdml file format) is disabled by default in ROOT installation. To enable this feature add `--enable-gdml` option to `./configure` script call.

## 18.10 Navigation Algorithms

This section will describe the main methods and algorithms used for implementing the navigation features within the geometrical modeller. This includes navigation queries at shape level, global geometrical queries and optimization mechanisms.

### 18.10.1 Finding the State Corresponding to a Location (x,y,z)

For reminder, a geometry state is a ‘touchable’ object in the geometry hierarchy. It is represented by a path like: `/TOP_1/A_1/B_3/C_1`, where `B_3` for instance is a copy of volume `B` positioned inside volume `A`. A state is always associated to a transformation matrix `M` of the touchable with respect to the global reference frame (obtained by piling-up all local transformations of nodes in the branch with respect to their containers). The current state and the corresponding global matrix are updated whenever the geometry depth is modified. The global transformations corresponding to all nodes in the current branch are kept in an array: `(MTOP_1, MA_1, MB_3, ...)`.

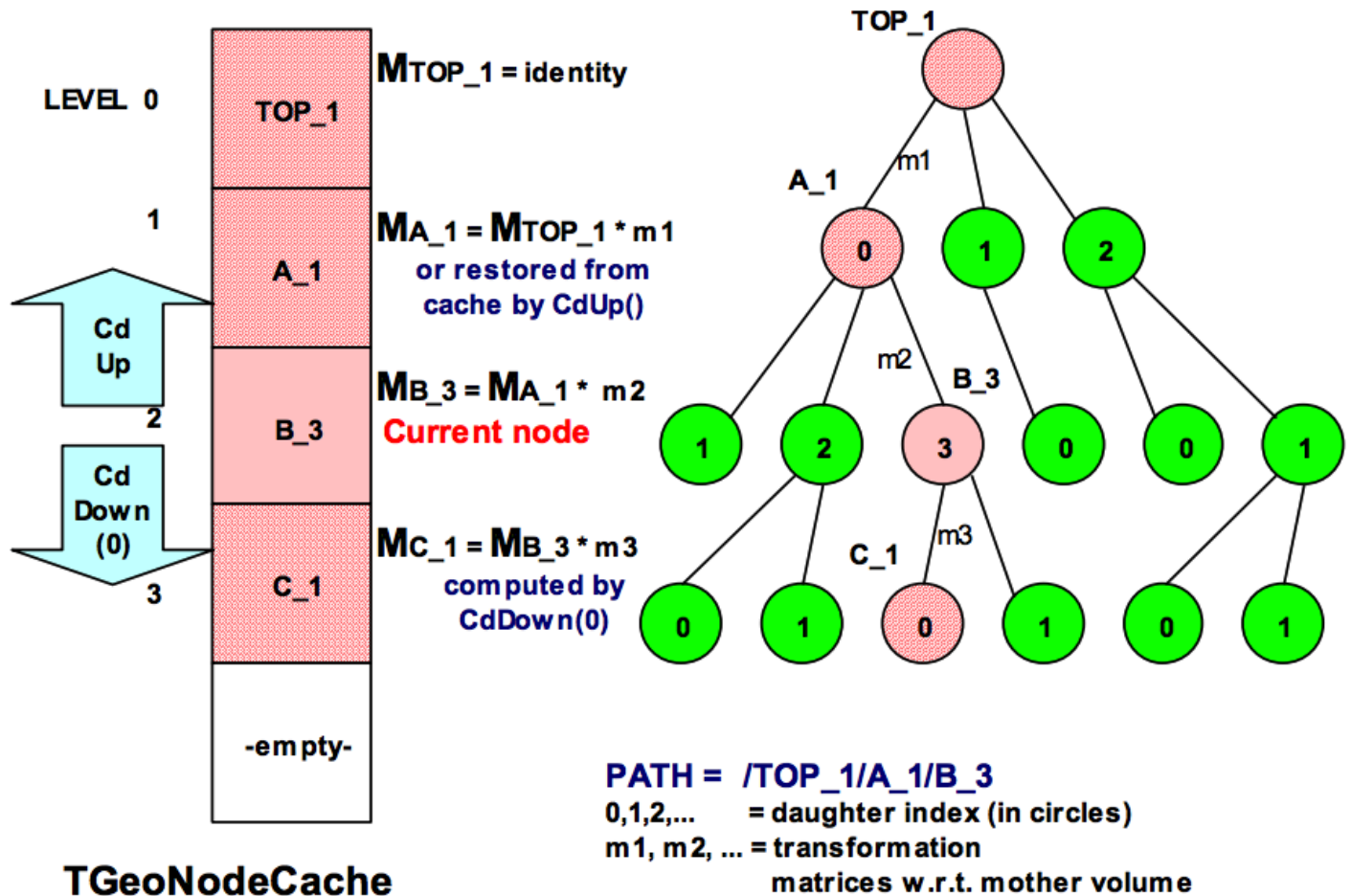

Figure 18.37: Navigation in the geometry hierarchy

The elementary operations for changing the state are:

```
TGeoManager::CdUp();
TGeoManager::CdDown(i);
TGeoManager::CdTop()
```

The current state accounting and global matrix handling after these operations are depicted in the figure below. Now let us suppose that we have a particle at position  $P(x,y,z)$ . The first thing needed for transporting it is the current object our particle is into, so that we can retrieve its material properties. This task is done by:

```
TGeoNode *TGeoManager::FindNode(x,y,z)
```

Note that the current particle position can be set using **SetCurrentPosition(x,y,z)** method of the manager class, in which case **FindNode()** can be called without arguments. The method returns a pointer to the *deepest node* that geometrically contains  $P$  (in our case let us suppose it is  $B_3$ ). Since a node is just a positioned volume, we can then get a pointer to the volume, medium or material objects related to it. *Deepest* means that  $B_3$  still contains point  $P$  (as well as  $A_1$  and  $TOP_1$ ), but none of the daughters of volume **B** does. After finding out the node containing the particle, one can check if the geometry state is different compared to the last located point:

```
Bool_t *TGeoManager::IsSameLocation()
```

The algorithm for finding where a point is located in geometry is presented in the figure 17-36.

It always starts by checking if the last computed modeller state is the answer. This optimizes the search when continuously tracking a particle. The main actions performed are:

- moving up and down in the logical node tree while updating the current node and its global matrix
- converting the global position into the local frame of the current node/volume
- checking whether the local position lies within the geometrical shape of the current volume - if this is the case continue the search downwards for the daughters of the current node, otherwise search upwards its containers until the top level is reached.
- the number of candidate nodes to be checked at a given level is minimized by an additional optimization structure: voxels. This is effective even in case there is only one daughter of the current volume.
- in case the current node is declared as possibly overlapping, the method FindInCluster() is invoked. This method checks all different possibilities within the cluster of overlapping candidates. One of the candidates is prioritized if one of the following conditions is fulfilled (in order):
- Is declared as non-overlapping (these are anyway searched first)
- Has at least one daughter that contains the current point
- Was already declared as containing the point at a previous step

### 18.10.2 Finding the Distance to Next Crossed Boundary

The most important feature provided by the modeller related to track propagation is the computation of the distance to the next boundary along a straight line.

The relevant state parameters used for this task are:

- Current particle position and direction  $(x,y,z,nx,ny,nz)$ , where  $n_i$  is the direction cosine with axis  $(i)$ .
- Current node (and path) in geometry must be set by calling `TGeoManager::FindNode(x,y,z)` beforehand. The method computing the distance to next boundary is:

```
TGeoNode *TGeoManager::FindNextBoundary(stepmax, path)
```

The output node returned by the method is the object which shape boundary will be crossed first. The distance to the next crossing can be retrieved after the call:

```
Double_t TGeoManager::GetStep()
```

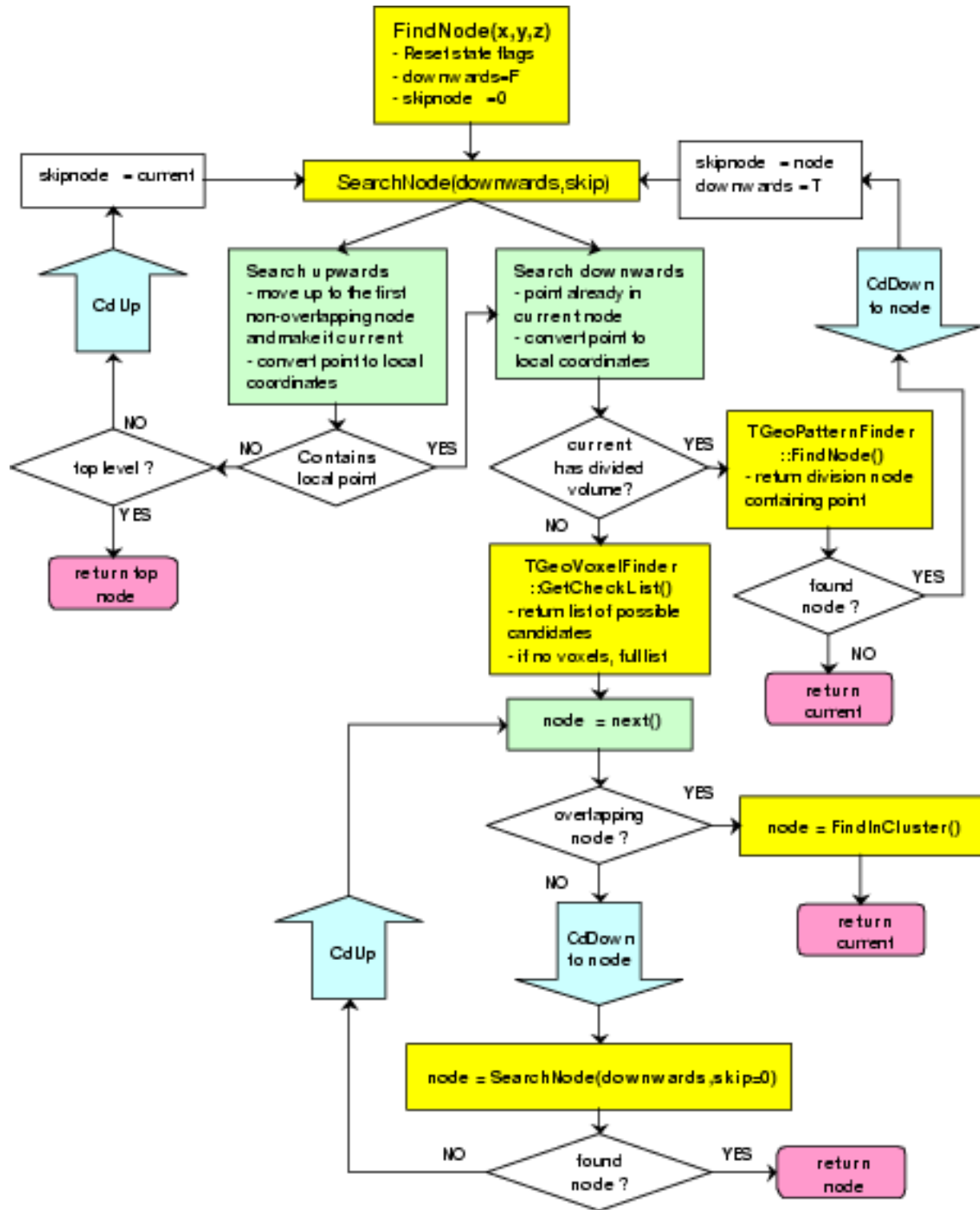

Figure 18.38: Finding the location of a point in the geometry hierarchy

- The main input parameter is `stepmax`, which act as a trigger for different features. The absolute value of this parameter represents the step value proposed by the user. The algorithm will never try o search for boundaries further than this distance. In case no boundary is found the returned node will be the current one and the computed step to boundary will be equal to abs (`stepmax`) having the meaning “*step approved*”. The default value for `stepmax` is `TGeoShape::Big` with the meaning that boundaries are looked for without limitation.

According the values of the input parameters the method will perform additional optional tasks:

`|stepmax| < TGeoShape::Big()` ‘ ‘

The safe distance in the current volume is also computed. Moving the particle from its current location with this distance in any direction is safe in the sense that will never change the current state.

`stepmax < 0`

The global matrix for the object that will have the next crossed boundary is also computed. This can be retrieved for masterlocal point or vector conversions: `TGeoManager::GetNextMatrix()`

In case the computation of the normal vector to the next crossed surface is required, using a negative `stepmax` value is recommended. In this case one can subsequently call a method for fast normal computation:

`Double_t *TGeoManager::FindNormalFast()`

`path 0`

In case a path to a given physical object is specified, the distance to its boundary is computed ignoring the rest of the geometry

### 18.10.2.1 Output Values

`TGeoManager::GetStep()`: distance to next boundary.

`TGeoManager::GetSafeDistance()`: safe distance (in case it was computed).

`TGeoManager::IsOnBoundary()`: the initial point ( $x, y, z$ ) was (or was not) on a boundary within `TGeoShape::Tolerance()`.

The algorithm checks first if the computation of safety was required. If this is the case and the global point coordinates did not change from the last query, the last computed safety is taken. Otherwise, the method `TGeoManager::Safety ()` is invoked. A safety value less than `TGeoShape::Tolerance()` will set the flag `IsOnBoundary` to true. On the other hand, a safety value bigger than the proposed step will stop the computation of the distance to next boundary, returning the current geometry location with the meaning that the proposed step is safe.

The next stage is to check if computation of the distance to a give physical object specified by a path was required. If this is the case, the modeller changes the state to point to the required object, converts the current point and direction coordinates to the local frame of this object and computes the distance to its shape. The node returned is the one pointed by the input path in case the shape is crossed; otherwise the returned value is NULL. In case the distance to next crossed boundary is required, the current point has to be physically INSIDE the shape pointed by the current volume. This is only insured in case a call to `TGeoManager::FindNode()` was performed for the current point. Therefore, the first step is to convert the global current point and direction in the local reference frame of the current volume and to compute the distance to exit its shape from inside. The returned value is again compared to the maximum allowed step (the proposed one) and in case the distance is safe no other action is performed and the proposed step is approved. In case the boundary is closer, the computed distance is taken as maximum allowed step. For optimization purposed, for particles starting very close to the current volume boundary (less than 0.01 microns) and exiting the algorithm stops here.

After computing the distance to exit the current node, the distance to the daughter of the current volume which is crossed next is computed by `TGeoManager::FindNextDaughterBoundary()`. This computes the distance to all daughter candidates that can be possibly crossed by using volume voxelization. The algorithm is efficient in average only in case the number of daughters is greater than 4. For fewer nodes, a simple loop is performed and the minimum distance (from a point outside each shape) is taken and compared to the maximum allowed step. The step value is again updated if `step < stepmax`.

A special case is when the current node is declared as possibly overlapping with something else. If this is the case, the distance is computed for all possibly overlapping candidates, taking into account the overlapping priorities (see also: "Overlapping volumes").

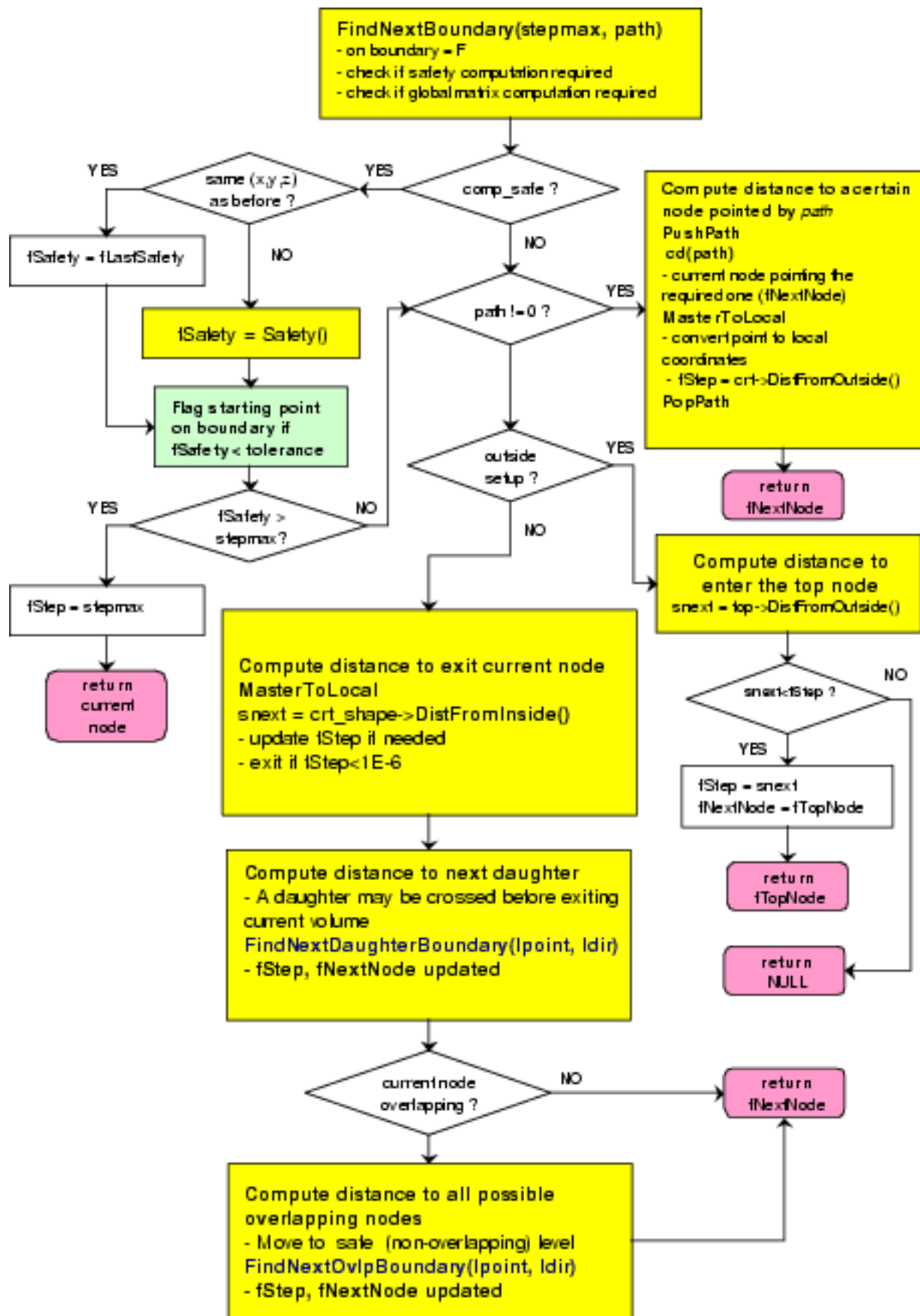

Figure 18.39: Finding the distance to the next crossed boundary

The global matrix describing the next crossed physical node is systematically computed in case the value of  $t$  the proposed step is negative. In this case, one can subsequently call `TGeoManager::ComputeNormalFast()` to get the normal vector to the crossed surface, after propagating the current point with the `TGeoManager::GetStep()` value. This propagation can be done like:

```
Double_t *current_point = gGeoManager->GetCurrentPoint();
Double_t *current_dir = gGeoManager->GetCurrentDirection();
for (Int_t i=0; i<3; i++)
    current_point[i] += step * current_dir[i];
```

Note: The method `TGeoManager::FindNextBoundary()` does not modify the current point/direction nor the current volume/state. The returned node is the next crossed one, but the physical path (state) AFTER crossing the boundary is not determined. In order to find out this new state, one has to propagate the point with a distance slightly bigger than the computed step value (which is accurate within numerical precision). A method that performs this task finding the next location is `TGeoManager::Step()`, described in "Making a Step", but users may implement more precise methods to insure post-step boundary crossing.

## 18.11 Geometry Graphical User Interface

The `geombuilder` package allows you to create and edit geometries. The package provides a library of all GUI classes related to geometry. Each editable geometry class `TGeoXXX` have a correspondent editor `TGeoXXXEditor` that provides a graphics user interface allowing to edit some (or all) parameters of a geometry object. The editable objects are geometry manager, volumes, nodes, shapes, media, materials and matrices. The interfaces provide also access to specific functionality of geometry objects. The editing mechanism is based on ROOT GED (Graphics Editors) functionality and the library is loaded using the plug-in mechanism.

### 18.11.1 Editing a Geometry

There are two different use cases having different ways of invoking the geometry editors. The first one applies when starting with geometry from scratch and using the builder functionality to create new geometry objects. In this case, one should use the sequence:

```
root[] TGeoManager *geom = new TGeoManager("MyGeom",
"Test builder");
root[] geom->Edit(Option_t *option="");
```

The lines above will create a new `TGeoManager` class, create an empty canvas and start the editor in the left-sided editor frame attached to the canvas. To open the editor in a separate frame one should provide a non-empty string as option to the `Edit()` method.

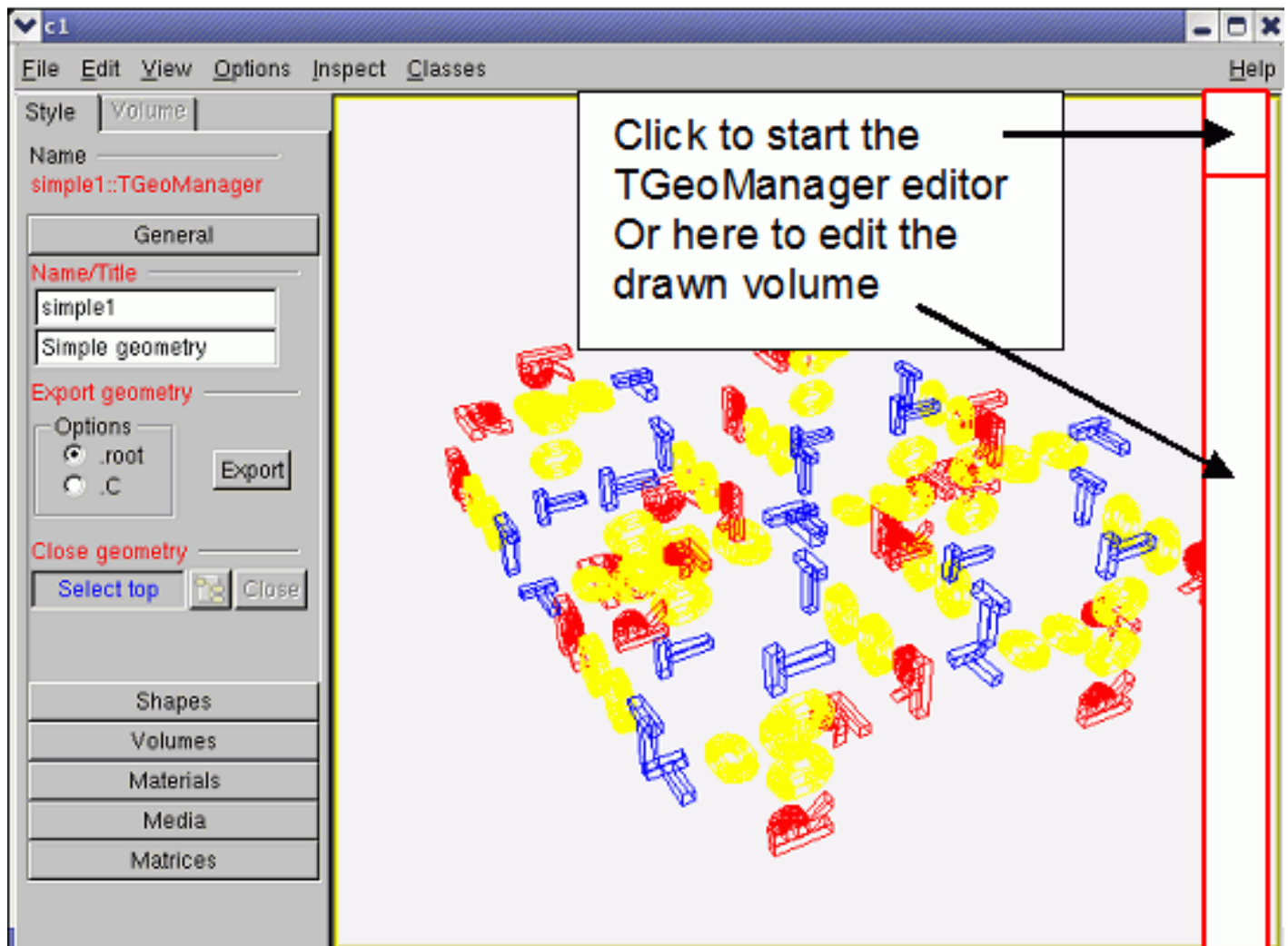
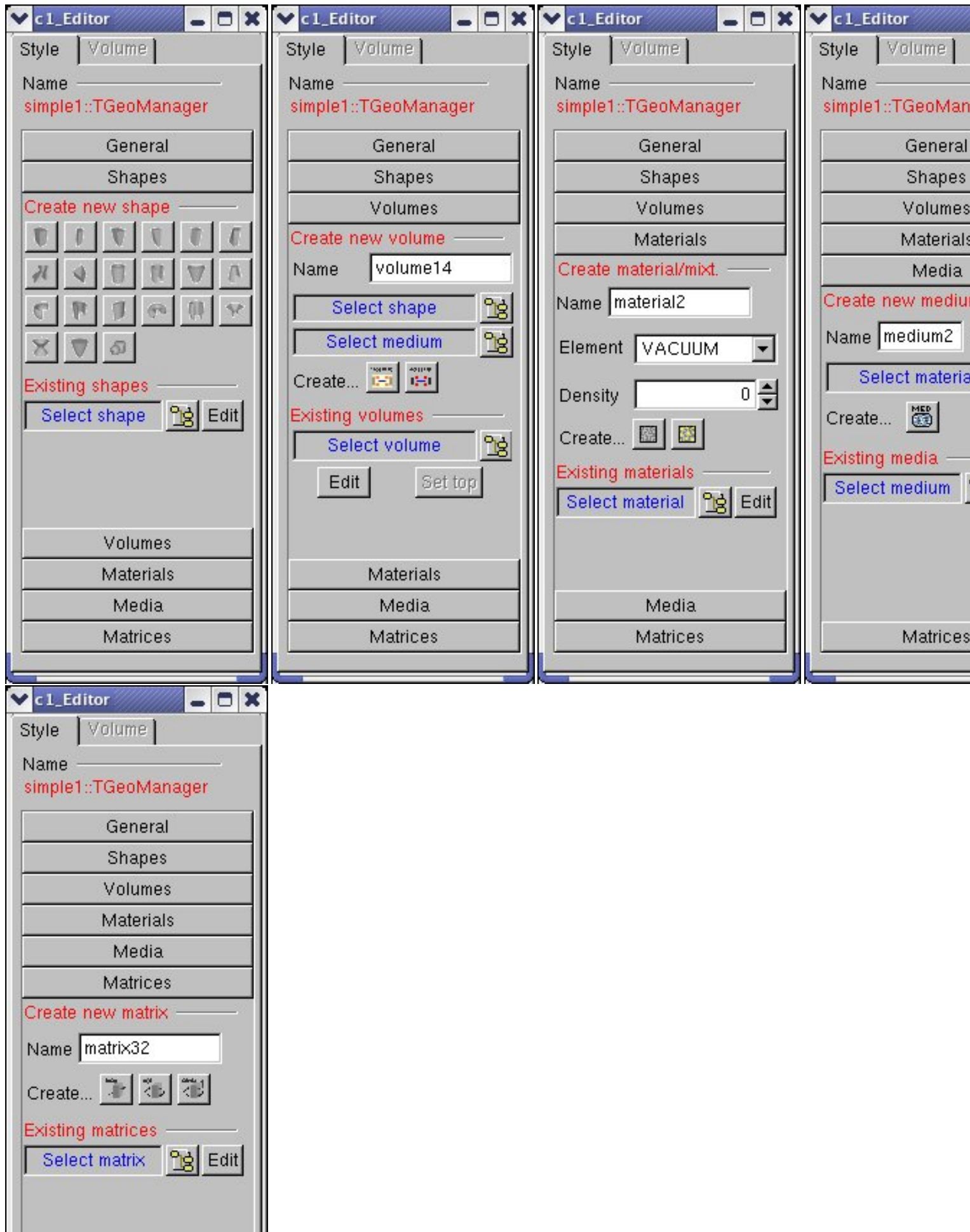

Figure 18.40: The geometry manager editor





## 18.11.2 The Geometry Manager Editor



The second use case applies when starting to edit an existing geometry. Supposing the geometry was loaded into memory, besides the first method that still applies one can also edit drawn geometry objects. For this, the menu entry View/Editor of the canvas containing for instance a drawn volume must be activated. For starting the volume editor one can click on a volume. The GUI of the **TGeoManager** class can be started by clicking on the top-right 40x40 pixels corner of the pad with a drawn geometry.

This is the main entry point for editing the geometry or creating new objects. Once the interface is created (using one of the methods described above), several categories can be accessed via a shutter GUI widget:

- *General.* This allows changing the name/title of the geometry, setting the top volume, closing the geometry and saving the geometry in a file. The file name is formed by `geometry_name.C` or `.root` depending if the geometry need to be saved as a C macro or a `.root` file.
- *Shapes.* The category provides buttons for creation of all supported shapes. The new shape name is chosen by the interface, but can be changed from the shape editor GUI. Existing shapes can be browsed and edited from the same category.
- *Volumes.* The category allows the creation of a new volume having a given name, shape and medium. For creating a volume assembly only the name is relevant. Existing volumes can be browsed or edited from this category.
- *Materials.* Allows creation of new materials/mixtures or editing existing ones.
- *Media.* The same for creation/editing of tracking media (materials having a set of properties related to tracking)
- *Matrices.* Allows creation of translations, rotations or combined transformations. Existing matrices can also be browser/edited.

### 18.11.3 Editing Existing Objects

For editing an existing object from one of the categories described above, the interface imposes first a selection among all objects of the corresponding type stored in the geometry. This can be done by clicking the button next to the blue label *Select <object>*. The dialog interfaces are generally different for different types of objects. The volume selection dialog offers the possibility to select either a volume already connected to the geometry hierarchy or non-connected ones. Selection for shapes and matrices is split into categories represented by top-level list tree items for: boxes, tubes, translations, rotations, etc.

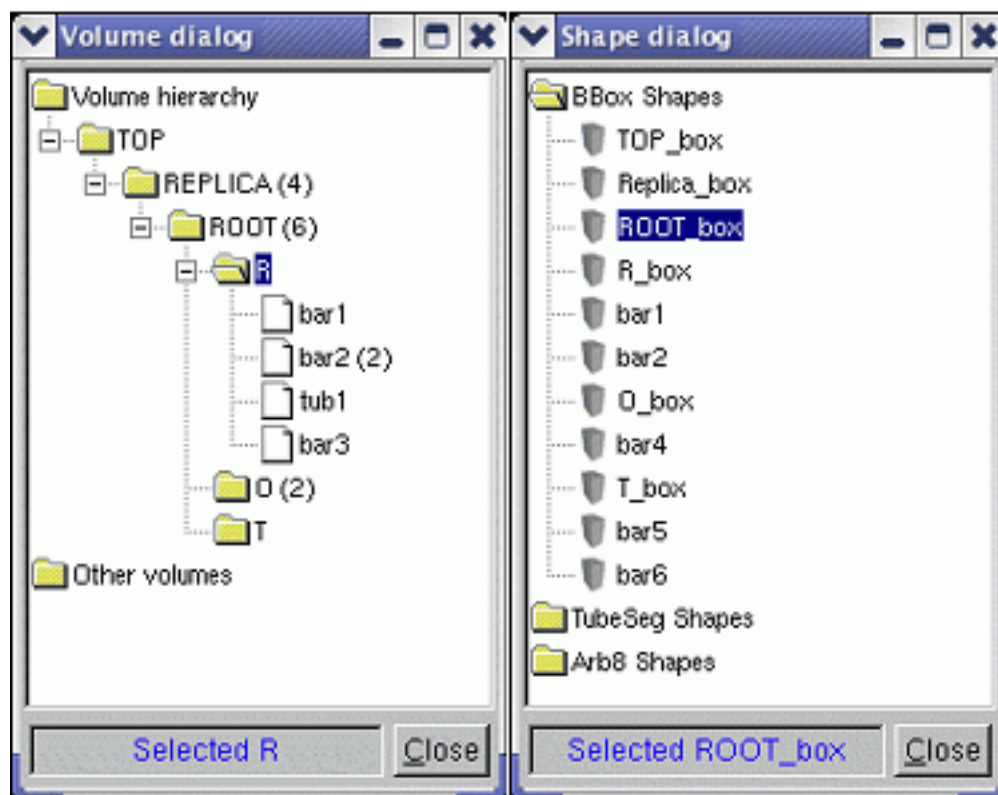
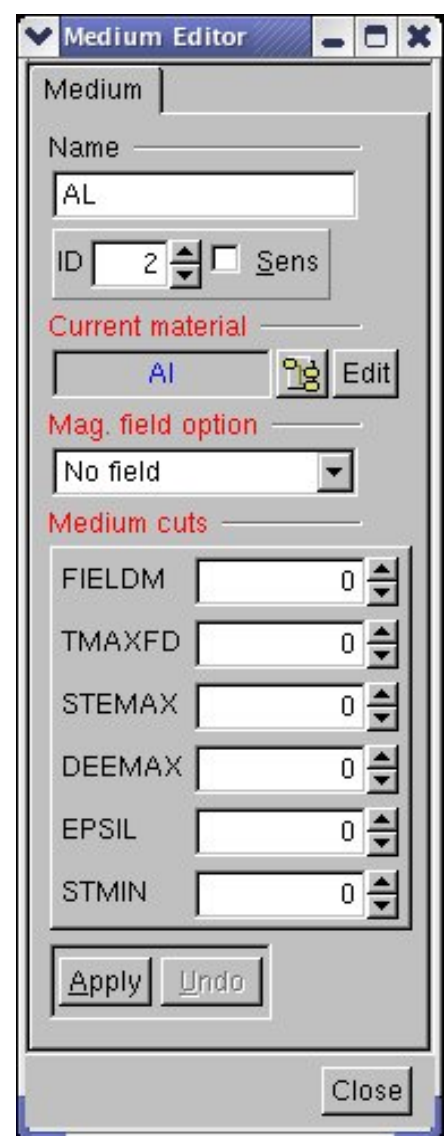
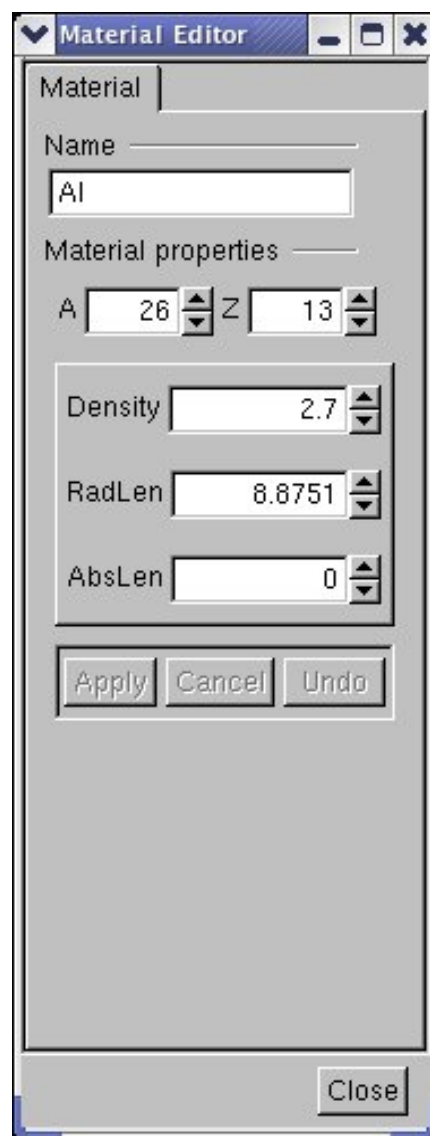
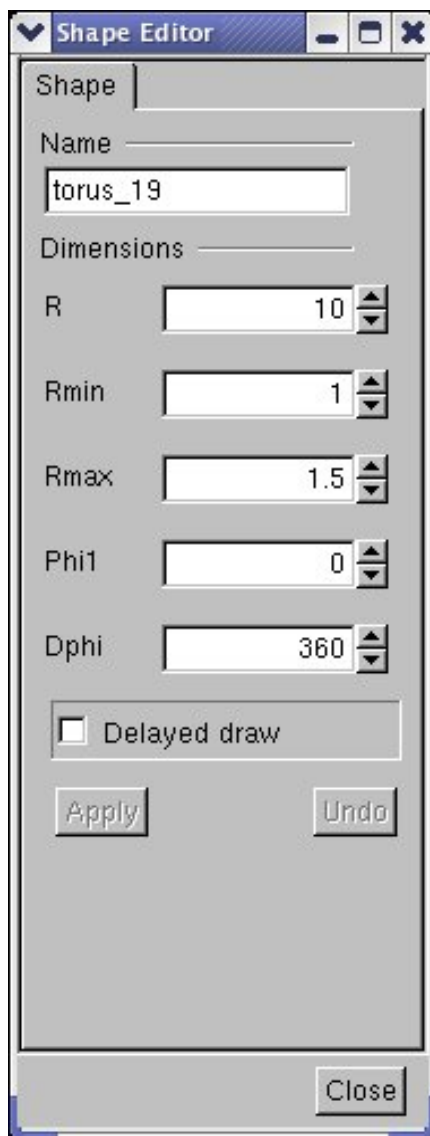
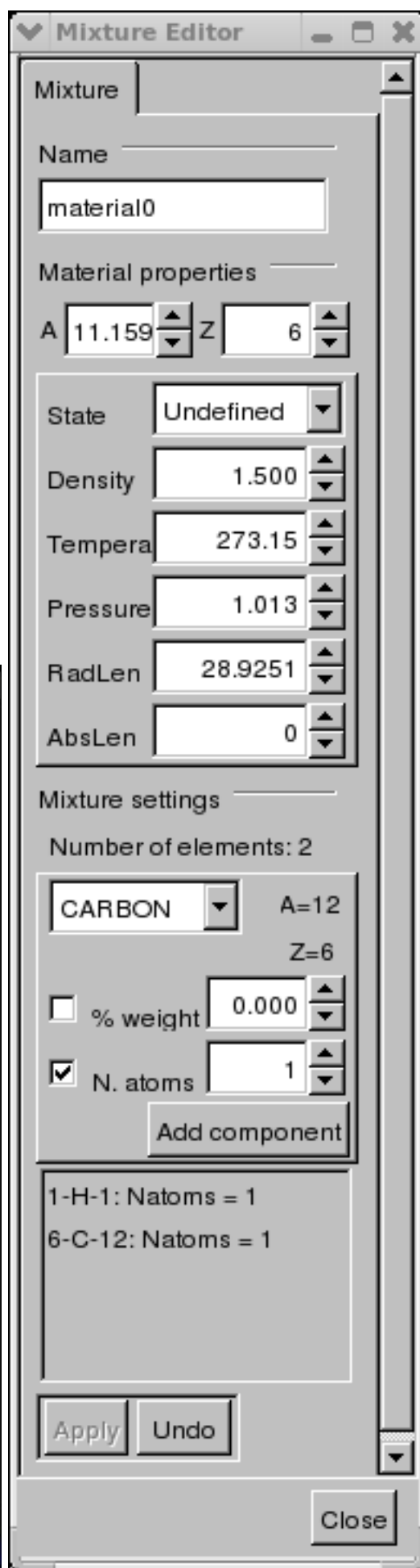
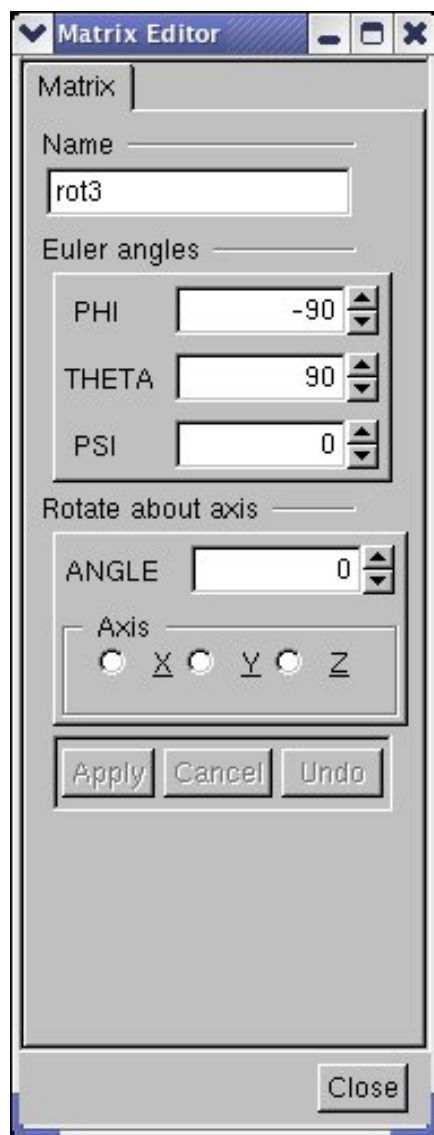

Figure 18.41: Selection dialogs for different TGeo objects

Once a selection is made and the dialog is closed, the selected item name will appear in the corresponding label and the button **Edit** will start the object editor in a transient frame. Closing these transient frames will not delete, but just hide existing opened editors for later reuse. Their lifetime is determined by the canvas to which the manager editor is attached to, since these will be destroyed together.





For most editors, the functionalities Apply and Undo are provided.

For shapes, changing any of the shape parameters will activate the “Apply” button only if the check button “Delayed draw” is checked, otherwise the changes are immediately applied. Once the apply button is pressed, the changes are applied to the edited shape and drawn. The “Undo” button becomes active after the first modification has been applied. It allows restoring the initial parameters of the shape.

NOTE: In this version the “Undo” does not allow restoring an intermediate state of the parameters that was applied - it will always restore the parameters at the moment the shape was edited.

All material properties changes are undoable. The mixture editor currently allows adding elements one by one in the mixture composition. This can be done either by element weight fraction or by number of atoms. Once an element was added using one method the other method is not selectable anymore. Summing component fractions up to 1 in the final mixture is the user responsibility. Adding materials as components of a mixture is not supported in this version.

The elements that were added to the mixture appear in the bottom of the mixture editor. The operations performed on mixture are not undoable.

#### 18.11.4 Creation of New Objects

As described above, all geometry object creators are accessible within the geometry manager editor frame. Generally, if the new object that needs to be created does not depend on other objects, it will be built with a set of default parameters. This is the case for all shapes (except composite shapes) and matrices. For all the other objects the interface forces the selection of components before creating the object.

#### 18.11.5 Editing Volumes

Volumes are hierarchical components in the geometry, therefore their editor is more complex. It provides the following functionalities:

- *General.* This category allows changing the name of the volume and selecting other shape or medium among existing ones.
- *Daughters.* The category allows removing existing daughter nodes or adding new ones. The button “Position” allows editing the positioning matrix of a given node.

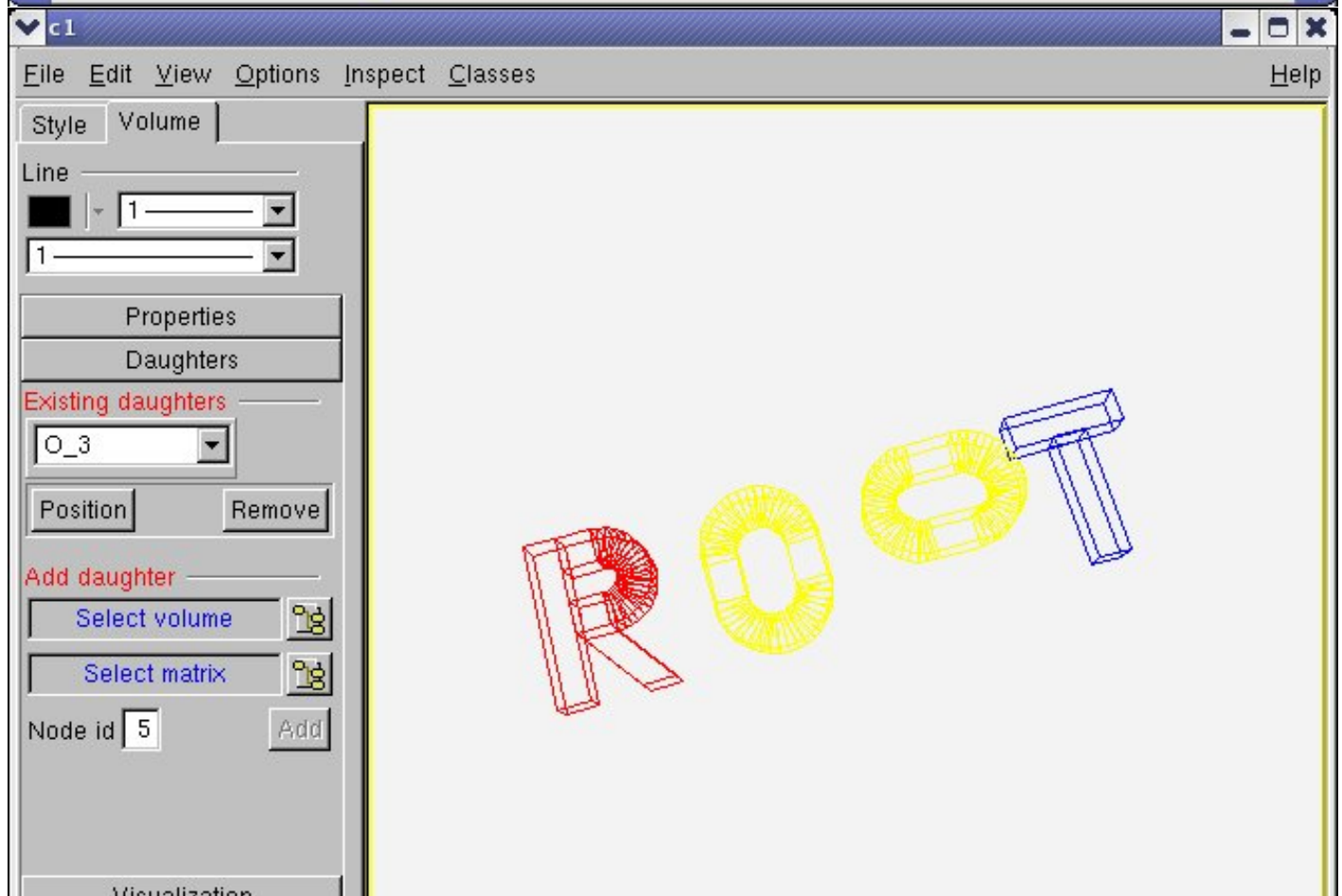
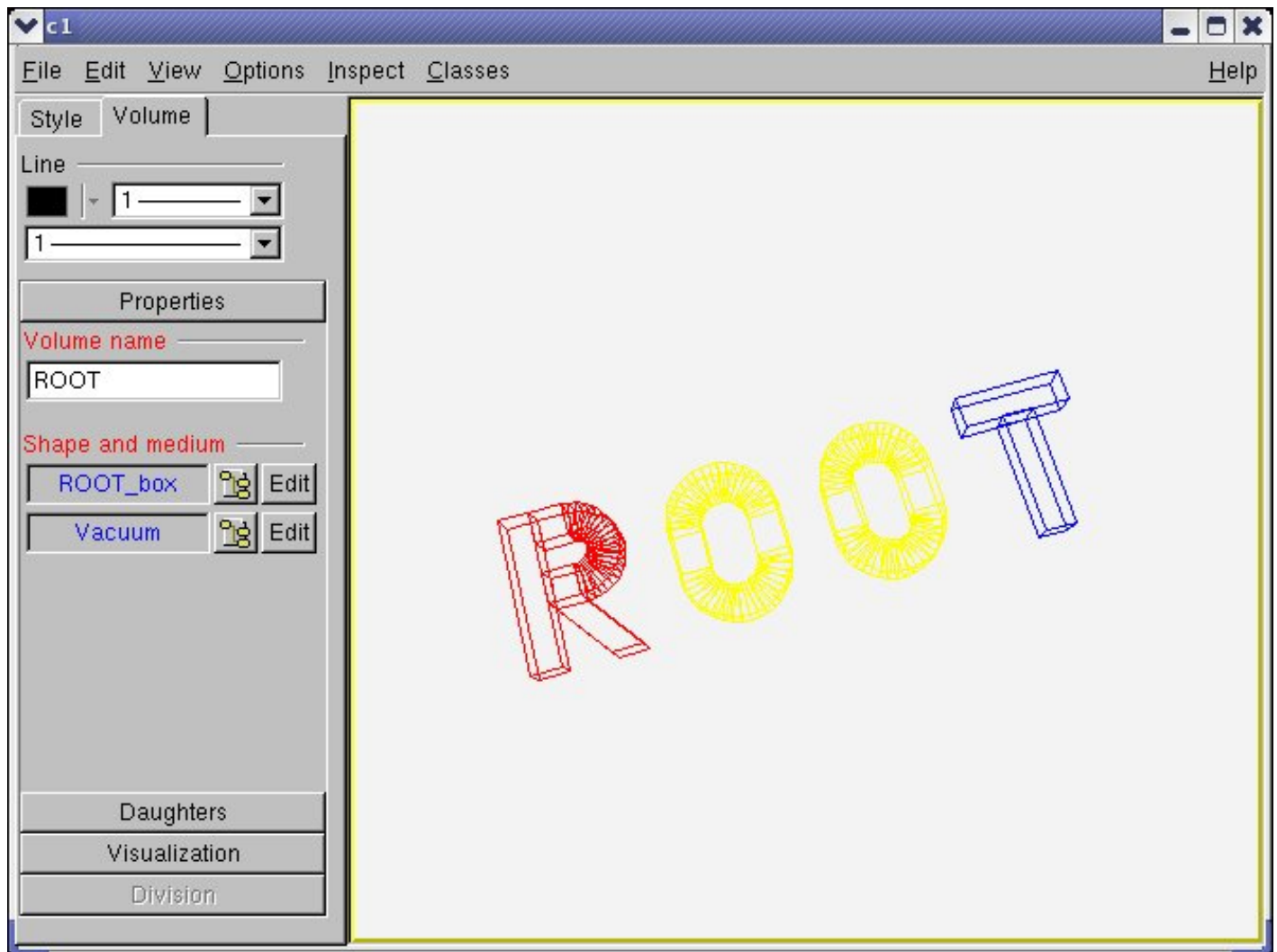

- *Visualization.* This category allows changing the visibility of the edited volume or for its daughters, as well as other visualization settings. The radio button “*All*” allows viewing all volumes down to the selected depth. “*Leaves*” will draw only the deepest nodes that have the selected depth or lower level ones that have no daughters inside. “*Only*” will allow drawing only the edited volume. The check button “*Raytrace*” will just draw the current selection in solid mode using the ray-tracing algorithm provided by TGeo.



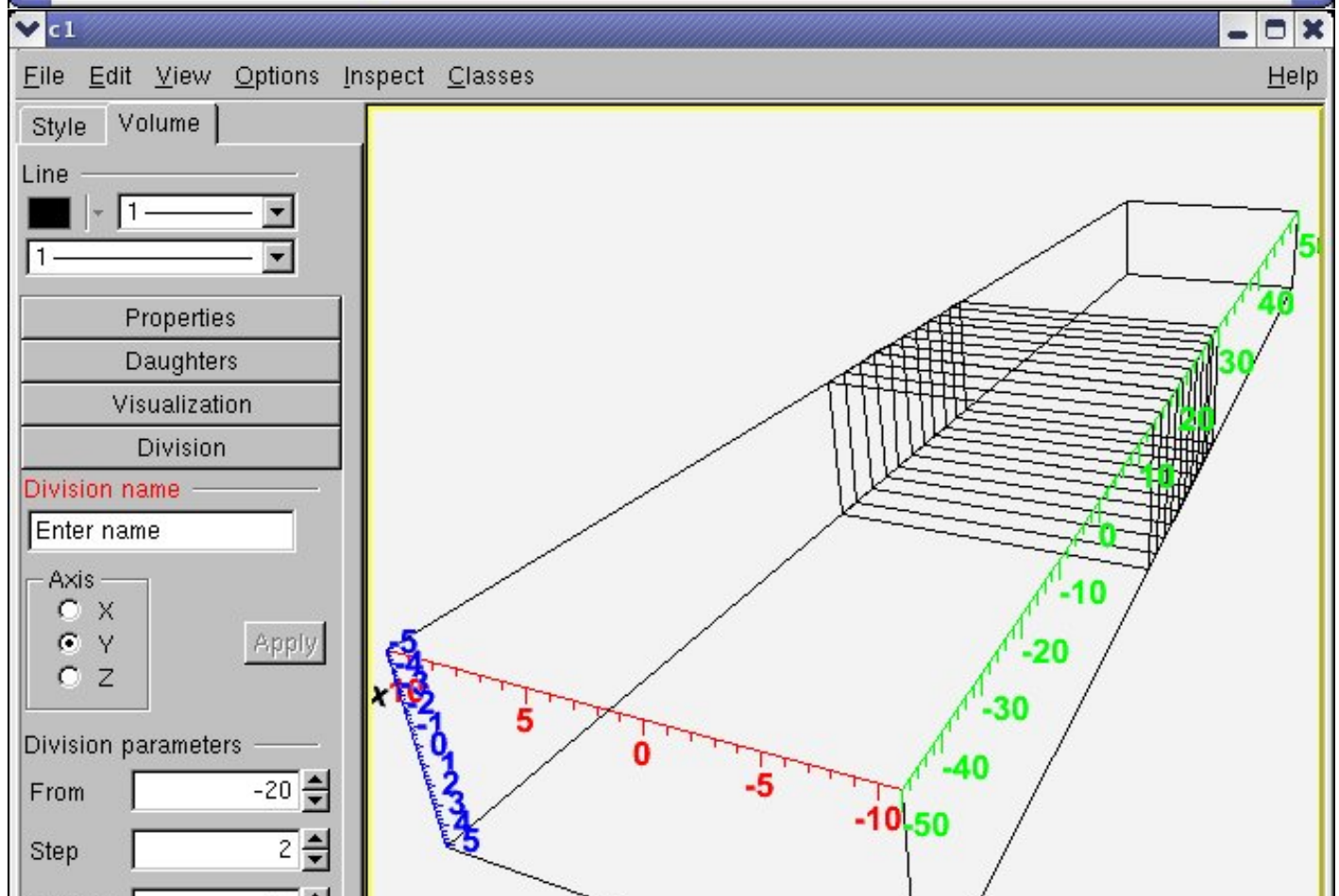
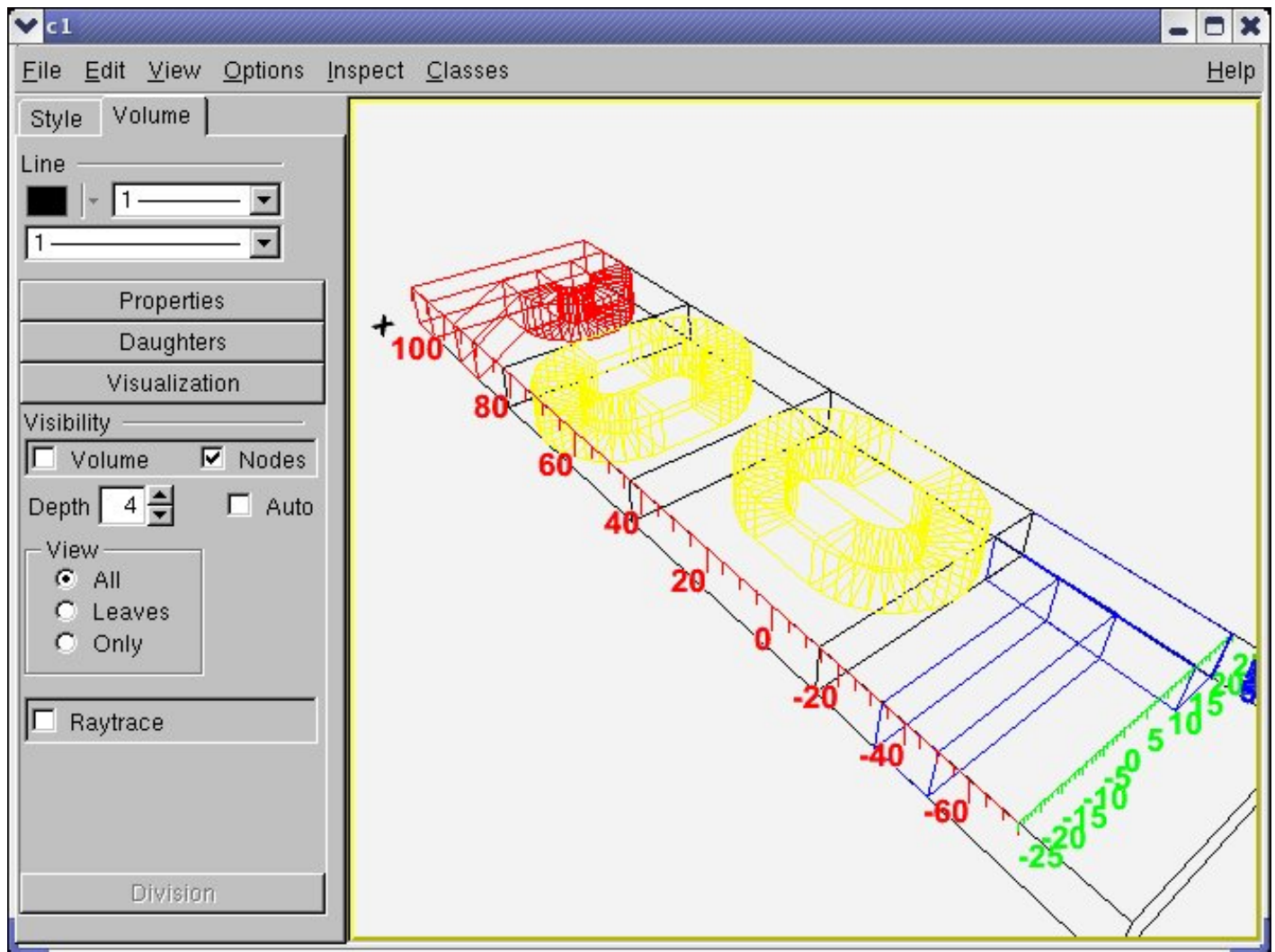

- *Division.* Allows dividing the edited volume according a given pattern. The division axes that are allowed are presented in a radio-button group. The number entries labeled “*From*”, “*Step*” and “*Nslices*” correspond to the divisioning parameters on the selected axis. The range of the division is between **start** and **start+ndiv\*step** values and its validity is checked upon changing one of the values.

NOTE: When changing a value in a number entry by typing a number, press ENTER at the end to validate. This applies for taking into account and validation of any number change in the geometry editors.

### 18.11.6 How to Create a Valid Geometry with Geometry Editors

1. Create a new geometry manager and start the editor as described at the beginning.
2. Create at least one material from the “*Materials*” shutter item category. Generally, for creating objects, the interface is always in the **TGeoManagerEditor** in different categories - one should just provide a name and requested parameters.
3. Create a shape that will be used for the top volume within the “*Shapes*” category. For the moment, the shapes that have editors are Box, Para, Trd1, Trd2, Tube, Tube segment, Cone, Cone segment, Hype, Pcon, Torus and Sphere.
4. Create a medium from one of the existing materials from the “*Medium*” category. You will notice that some categories as “*Volume*” and “*Medium*” are inactive at the beginning because at that time there is no material yet (for making a medium) and no shape (for making a volume). These categories are dynamically activated once all the required components are defined.
5. Create a volume from the “*Volumes*” category. You will notice that contrary to the other editors, the volume editor is opened in a tab, not transient - this is because it is more complex.
6. Go back to “*General*” category and select the newly created volume as the top one (you can do it also from the volume category). This is just for starting. To create some hierarchy, one has to create several other volumes and the matrices to position them. Once this is done, use the volume editor interface to:
  - add/remove daughters, change shape, edit position of daughters
  - change visualization settings
  - divide the volume (only if there are no daughters yet)
7. Close the geometry from the “*General*” category.

# Chapter 19

## Python and Ruby Interfaces

Python is a popular, open-source, dynamic programming language with an interactive interpreter. Its interoperability with other programming languages, both for extending Python as well as embedding it, is excellent and many existing third-party applications and libraries have therefore so-called “Python bindings.” PyROOT provides Python bindings for ROOT: it enables cross-calls from ROOT/CINT into Python and vice versa, the intermingling of the two interpreters, and the transport of user-level objects from one interpreter to the other. PyROOT enables access from ROOT to any application or library that itself has Python bindings, and it makes all ROOT functionality directly available from the python interpreter.

### 19.1 PyROOT Overview

The Python scripting language is widely used for scientific programming, including high performance and distributed parallel code (see <http://www.scipy.org>). It is the second most popular scripting language (after Perl) and enjoys a wide-spread use as a “glue language”: practically every library and application these days comes with Python bindings (and if not, they can be easily written or generated).

PyROOT, a Python extension module, provides the bindings for the ROOT class library in a generic way using the CINT dictionary. This way, it allows the use of any ROOT classes from the Python interpreter, and thus the “glue-ing” of ROOT libraries with any non-ROOT library or applications that provide Python bindings. Further, PyROOT can be loaded into the CINT interpreter to allow (as of now still rudimentary) access to Python classes. The best way to understand the benefits of PyROOT is through a few examples.

#### 19.1.1 Glue-ing Applications

The PyQt library, see <http://www.riverbankcomputing.co.uk/pyqt>, provides Python bindings for the Qt cross-platform GUI framework ( <http://www.trolltech.com>). With PyROOT and PyQt, adding ROOT application layer code to a Qt GUI, becomes children play. The following example shows how a Python class can be used to have ROOT code respond to a click on a Qt widget.

```
# Glue-ing Qt and ROOT through Python
import sys, ROOT
from qt import *

theApp = QApplication( sys.argv)
box = QVBox()
box.resize(QSize(40,10).expandedTo(box.minimumSizeHint()))

class myButton(QPushButton):
    def __init__( self,label,master):
        QPushButton.__init__(self,label,master)
        self.setFont( QFont('Times',18,QFont.Bold))
```

```

def browse(self):
    self.b = ROOT.TBrowser()

bb = myButton('browser',box)
QObject.connect( bb,SIGNAL('clicked()'),bb.browse)

theApp.setMainWidget(box)
box.show()
theApp.exec_loop()

```

When the example is run, a Qt button is displayed, and when the button is clicked, a **TBrowser** instance is created and will appear on the screen. PyROOT takes care of feeding system events to ROOT widgets, so the **TBrowser** instance and the button behave properly when users interact with them.

### 19.1.2 Access to ROOT from Python

There are several tools for scientific analysis that come with bindings that allow the use of these tools from the Python interpreter. PyROOT provides this for users who want to do analysis in Python with ROOT classes. The following example shows how to fill and display a ROOT histogram while working in Python. Of course, any actual analysis code may come from somewhere else through other bindings, e.g. from a C++ program.

When run, the next example will display a 1-dimensional histogram showing a Gaussian distribution. More examples like the one above are distributed with ROOT under the \$ROOTSYS/tutorials directory.

**# Example: displaying a ROOT histogram from Python**

```

from ROOT import gRandom, TCanvas, TH1F

c1 = TCanvas('c1', 'Example', 200, 10, 700, 500)
hpx = TH1F('hpx', 'px', 100, -4, 4)

for i in xrange(25000):
    px = gRandom.Gaus()
    hpx.Fill(px)

hpx.Draw()
c1.Update()

```

### 19.1.3 Access to Python from ROOT

Access to Python objects from CINT is not completely fleshed out. Currently, ROOT objects and built-in types can cross the boundary between the two interpreters, but other objects are much more restricted. For example, for a Python object to cross, it has to be a class instance, and its class has to be known to CINT first (i.e. the class has to cross first, before the instance can). All other cross-coding is based on strings that are run on the Python interpreter and vice-versa.

With the ROOT v4.00/06 and later, the **TPython** class will be loaded automatically on use, for older editions, the `libPyROOT.so` needs to be loaded first before use. It is possible to switch between interpreters by calling `TPython::Prompt()` on the ROOT side, while returning with `^D (EOF)`. State is preserved between successive switches, and string based cross calls can nest as long as shared resources are properly handled.

```

// Example: accessing the Python interpreter from ROOT
// either load PyROOT explicitly or rely on auto-loading
root[] gSystem->Load( "libPyROOT" );
root[] TPython::Exec("print1+1");
2

// create a TBrowser on the Python side, and transfer it back and forth
root[] TBrowser* b = (void*)TPython::Eval("ROOT.TBrowser()");
(class TObject*)0x8d1daa0

```

```

root [] TPython::Bind(b,"b");

// builtin variables can cross-over (after the call i==2)
root [] int i = TPython::Eval( "1+1" );
root [] i
(int)2

```

## 19.1.4 Installation

There are several ways of obtaining PyROOT, and which is best depends on your specific situation. If you work at CERN, you can use the installation available on `afs`. Otherwise, you will want to build from source, as PyROOT is not build by default in the binaries distributed from the ROOT project site. If you download the ROOT binaries, take care to download and install the Python distribution from <http://www.python.org/> against which they were built.

### 19.1.4.1 Environment Settings

ROOT installations with the build of PyROOT enabled are available from the CERN `afs cell /afs/cern.ch/sw/root/<version>/<platform>`. To use them, simply modify your shell environment accordingly. For Unix:

```

export PATH=$ROOTSYS/bin:$PYTHONDIR/bin:$PATH

export LD_LIBRARY_PATH=$ROOTSYS/lib:$PYTHONDIR/lib:$LD_LIBRARY_PATH

export PYTHONPATH=$ROOTSYS/lib:$PYTHONPATH

```

For Windows:

```

set PATH=%ROOTSYS%/bin;%PYTHONDIR%/bin;%PATH%

set PYTHONPATH=%ROOTSYS%/bin;%PYTHONPATH%

```

where `$ROOTSYS` should be set to `/afs/cern.ch/sw/root/<version>/<platform>`, and `PYTHONDIR` to `/afs/cern.ch/sw/lcg/extern/<version>/<platform>` as appropriate. Note that the latest version of Python is 2.4.1.

### 19.1.4.2 Building from Source

The standard installation instructions for building ROOT from source apply, with the addition that the build of PyROOT needs to be enabled at the configuration step. First, follow the instructions for obtaining and unpacking the source, and setting up the build environment.

Then, use the following command to configure the build process (of course, feel free to add any additional flags you may need):

```
$ ./configure <arch> [--with-python-incdir=<dir>] [--with-python-libdir=>dir]
```

For details on `<arch>` see the official build pages, the Python include directory should point to the directory that contains `Python.h` and the library directory should point to the directory containing `libpythonx.y.so`, where 'x' and 'y' are the major and minor version number, respectively. If you do not specify include and library directories explicitly, the configuration process will try the `PYTHONDIR` environment variable or, alternatively, the standard locations.

A recent distribution of Python is required: version 2.4.3 is preferred, but the older 2.2.x and 2.3.x versions suffice and are supported as well. Versions older than 2.2 are not supported and will not work. Note that one problem with 2.2 is that the shared library of the Python interpreter core is not build by default and the `'-enable-shared'` flag should thus be used when building Python from source. If the Python interpreter that is installed on your system is too old, please obtain a new version from [http://www.python.org.](http://www.python.org/)

Once configured, you continue the build process the normal way:

```

$ make

$ make cintdlls

$ make install

```

After some time, a library called `libPyROOT.so` (or `libPyROOT.dll`, on Windows) will be created in the `$ROOTSYS/lib($ROOTSYS/bin on Windows)` directory and a top Python module, `ROOT.py`, will be copied into the same place. The final step is to setup the shell environment, which is similar to what is described in the chapter ‘Environment Settings’. Note that the `$ROOTSYS` entries are probably already there if you followed the standard instructions, and that the `PYTHONDIR` entries should be replaced as appropriate by your choice at configuration time, or be left out if you had the configuration script pick up them up from a default location.

### 19.1.5 Using PyROOT

Since it is an extension module, the usage of PyROOT probably comes naturally if you’re used to Python. In general, PyROOT attempts to allow working in both Python and ROOT style, and although it is succeeding, it isn’t perfect: there are edges. The following sections explain in some detail what you can expect, and what you need to watch out for.

#### 19.1.5.1 Access to ROOT Classes

Before a ROOT class can be used from Python, its dictionary needs to be loaded into the current process. Starting with ROOT version 4.00/06, this happens automatically for all classes that are declared to the auto-loading mechanism through so-called `rootmap` files. Effectively, this means that all classes in the ROOT distributions are directly available for import. For example:

```
from ROOT import TCanvas          # available at startup
c = TCanvas()

from ROOT import TLorentzVector  # triggers auto-load of libPhysics
l = TLorentzVector()
```

Although it is not recommended, a simple way of working with PyROOT is doing a global import:

```
from ROOT import *

c = TCanvas()
l = TLorentzVector()
```

Keeping the ROOT namespace (“`import ROOT`”), or only importing from ROOT those classes that you will actually use (see above), however, will always be cleaner and clearer:

```
import ROOT

c = ROOT.TCanvas()
l = ROOT.TLorentzVector()
```

Since it is foreseen that most people will use the simple approach anyway, the request to copy all from module ROOT will not actually result in copying all ROOT classes into the current namespace. Instead, classes will still be bound (and possibly loaded) on an as-needed basis. Note carefully how this is different from other Python (extension) modules, and what to expect if you use the normal inspection tools (such as e.g. ‘`dir()`’). This feature prevents the inspection tools from being swamped by an enormous amount of classes, but they can no longer be used to explore unknown parts of the system (e.g. to find out which classes are available). Furthermore, because of this approach, `<tab>`-completion will usually not be available until after the first use (and hence creation) of a class.

Access to class static functions, public data members, enums, etc. is as expected. Many more example uses of ROOT classes from Python can be found in the tutorials directory in the ROOT distribution. The recipes section contains a description on working with your own classes (see “Using Your Own Classes”).

### 19.1.5.2 Access to STL Classes

Before STL classes can be used, you have to make sure that the CINT extension dlls are build (the “cintdlls” make target). Note that they do not compile on as many platforms as ROOT itself. Further, if you want to use template instantiations of STL classes with any of your own classes, make sure that a dictionary is available, e.g. by using ACLiC.

The STL classes live in the ROOT.std namespace (or, if you prefer to get them from there, in the ROOT module directly, but doing so makes the code less clear, of course). Be careful in their use, because Python already has types called “string” and “list.”

In order to understand how to get access to a templated class, think of the general template as a meta class. By instantiating the meta class with the proper parameters, you get an actual class, which can then be used to create object instances. An example usage:

```
>>> from ROOT import std
>>> v = std.vector<int>()
>>> for i in range(0,10):
...     v.push_back(i)
...
>>> for i in v:
...     print(i, end=' ')
1 2 3 4 5 6 7 8 9
>>>
>>> list(v)
[0, 1, 2, 3, 4, 5, 6, 7, 8, 9]
>>>
```

The parameters to the template instantiation can either be an actual type or value (as is used here, “int”), or a string representation of the parameters (e.g. “double”), or a mixture of both (e.g. “TCanvas, 0” or “double, 0”). The “std::vector<int>” class is one of the classes builtin by default into the CINT extension dlls. You will get a non-functional class (instances of which can still be passed around to C++) if the corresponding dictionary doesn’t exist.

### 19.1.5.3 Access to ROOT Globals

Most globals and global functions can be imported directly from the ROOT.py module, but some common ones (most notably **gMinuit**, although that variable now exists at startup from release 5.08 onward) do not exist yet at program startup, as they exist in modules that are loaded later (e.g. through the auto-loading mechanisms). An example session should make this clear:

```
>>> from ROOT import *
>>> gROOT                                     # directly available
<ROOT.TROOT object at 0x399c30>
>>> gMinuit                                   # library not yet loaded: not available
Traceback (most recent call last):
File "<stdin>", line 1, in ?
NameError: name 'gMinuit' is not defined
>>> TMinuit                                  # use of TMinuit class forces auto-loading
<class '__main__.TMinuit'>
>>> gMinuit                                   # now gMinuit is available
<__main__.TMinuit object at 0x1458c70>
>>> not not gMinuit                          # but it is the null pointer, until set
False
>>> g = TMinuit()
>>> not not gMinuit
True
```

It is also possible to create globals interactively, either by executing a CINT macro, or by a call to **gROOT.ProcessLine()**. These globals are made available in the same way: either use them directly after creation in ‘from ROOT import \*’ more, or get them from the ROOT namespace after an ‘import ROOT’.



As of 5.08, the behaviour of ROOT globals is the same as python globals, which is sometimes counterintuitive: since they are references, they can be changed only if done so directly through their containing module. The following session shows that in detail:

```
>>> from ROOT import *
>>> print(gDebug)
0
>>> gROOT.ProcessLine( 'gDebug = 7;' )
>>> print(gDebug)
0                                # local gDebug is unchanged
>>> gDebug = 5                    # changes _local_ reference only
>>> print(gDebug)
5                                # locally correct, but ...
>>> gROOT.ProcessLine( 'cout << gDebug << endl;' )
7                                # ... ROOT global unchanged
>>> import ROOT
>>> print(ROOT.gDebug)
7                                # still the old value (not '5')
>>> ROOT.gDebug = 3              # changes ROOT module reference
>>> gROOT.ProcessLine( 'cout << gDebug << endl;' )
3                                # ROOT global properly changed
>>>
```

The above is another good reason to prefer ‘import ROOT’ over ‘from ROOT import \*’.

#### 19.1.5.4 Access to Python

The access to Python from CINT goes through the **TPython** class, or directly if a Python object or class has crossed the border. The **TPython** class, which looks approximately like this:

```
class TPython {
public:
    // load a Python script as if it were a macro
    static void LoadMacro(const char* name);

    // execute a Python statement (e.g. "import ROOT")
    static void Exec(const char* cmd);

    // evaluate a Python expression (e.g. "1+1")
    static const TPyReturn& Eval(const char* expr);

    // bind a ROOT object with, at the Python side, the name "label"
    static bool Bind(TObject* obj,const char* label);

    // enter an interactive Python session (exit with ^D)
    static void Prompt();
};
```

`LoadMacro(const char* name)` - the argument is a name of a Python file that is to be executed (‘execfile’), after which any new classes are automatically made available to CINT. Since it is non-selective, use with care.

`ExecScript(const char* name,int argc=0,const char** argv=0)` - the argument is a name of a python file that is to be executed (‘execfile’) in a private namespace to minimize side-effects. Optionally, you can add CLI-style arguments which are handed to the script through ‘sys.argv’ in the normal way.

`Exec(const char* cmd)`- the argument is a string of Python code that is executed as a statement. There is no return value, but an error message will be printed if there are problems such as syntax errors.



`Eval(const char* expr)`- the argument is a string of Python code that is evaluated as an expression. The result of the expression is returned, if it is either a builtin type (int, long, float, double, and `const char*` are supported), a Python type that can cross, or a ROOT type. If a ROOT type is returned, an explicit cast to `void*` is needed to assign the return value to a local pointer (which may have a different type), whereas builtin types will be cast implicitly, if possible, to the type of the local variable to which they are assigned.

`Bind(TObject* obj, const char* label)` - transfer a ROOT object from the CINT to the Python interpreter, where it will be referenced with a variable called "label".

`Prompt()` - Transfer the interactive prompt to Python.

With the ROOT v4.00/06 and later, the `TPython` class will be loaded automatically on use, for older editions, the `libPyROOT.so` needs to be loaded first with `gSystem->Load()` before use. Refer back to the other example of the use of `TPython` that was given in "Access to Python from ROOT".

To show in detail how Python access can be used, an example Python module is needed, as follows:

```
print('creating class MyPyClass ... ')
class MyPyClass:
    def __init__(self):
        print('in MyPyClass.__init__')
        self._browser = None
    def gime(self, what):
        return what
```

This module can now be loaded into a CINT session, the class used to instantiate objects, and their member functions called for showing how different types can cross:

```
root[] TPython::LoadMacro("MyPyClass.py");
creating class MyPyClass ...
root[] MyPyClass m;
in MyPyClass.__init__
root[] char* s = m.gime("aap");
root[] s
(char* 0x41ee7754)"aap"
```

Note that the `LoadMacro()` call makes the class automatically available, such that it can be used directly. Otherwise, a `gROOT->GetClass()` call is required first.

### 19.1.5.5 Callbacks

The simplest way of setting a callback to Python from CINT, e.g. for a button, is by providing the execution string. See for example `tutorials/pyroot/demo.py` that comes with the ROOT installation:

```
# [...]
bar = ROOT.TControlBar('vertical', 'Demos')
bar.AddButton('Help on Demos', r'TPython::Exec("execfile('demoshelp.py')");', 'Click Here For Help on Running t
bar.AddButton('browser', r'TPython::Exec("b = Tbrowser()");', 'Start the ROOT browser')
# [...]
```

Here, the callback is a string that will be interpreted by CINT to call `TPython::Exec()`, which will, in turn, interpret and execute the string given to it. Note the use of raw strings (the 'r' in front of the second argument string), in order to remove the need of escaping the backslashes.

### 19.1.5.6 CINT Commands

In interactive mode, the Python exception hook is used to mimic some of the CINT commands available. These are: `.q`, `!.`, `.x`, `.L`, `.cd`, `.ls`, `.pwd`, `?.` and `.help`. Note that `.x` translates to Python `'execfile()'` and thus accepts only Python files, not CINT macros.

## 19.1.6 Memory Handling

The Python interpreter handles memory for the user by employing reference counting and a garbage collector (for new-style objects, which includes PyROOT objects). In C++, however, memory handling is done either by hand, or by an application specific, customized mechanism (as is done in ROOT). Although PyROOT is made aware of ROOT memory management, there are still a few boundary conditions that need to be dealt with by hand. Also, the heuristics that PyROOT employs to deal with memory management are not infallible. An understanding in some detail of the choices that are made is thus important.

### 19.1.6.1 Automatic Memory Management

There are two global policies that can be set: heuristics and strict. By default, the heuristic policy is used, in which the following rules are observed:

- A ROOT object created on the Python interpreter side is owned by Python and will be deleted once the last Python reference to it goes away. If, however, such an object is passed by non-const address as a parameter to a C++ function (with the exception of the use as “self” to a member function), ownership is relinquished.
- A ROOT object coming from a ROOT call is not owned, but before it passes to the Python interpreter, its “must cleanup” bit is set if its type is a class derived from `TObject`. When the object goes out of scope on the C++ side, the Python object will change type into an object that largely behaves like None.

The strict policy differs in that it will never relinquish ownership when passing an object as a parameter to a function. It is then up to the developer to prevent double deletes. Choosing one or the other policy is done by:

```
ROOT.SetMemoryPolicy( ROOT.kMemoryStrict )
```

for the strict policy, or for the heuristic policy:

```
ROOT.SetMemoryPolicy( ROOT.kMemoryHeuristics )
```

Care must be taken in the case of graphic objects: when drawn on the current pad, a reference to the graphics is kept that PyROOT isn't currently aware of, and it is up to the developer to keep at least one Python reference alive. See `$ROOTSYS/tutorials/pyroot/zdemo.py` (available in the latest release) for an example. Alternatively, one can tell python to give up ownership for individual instances:

```
o = ROOT.TObject()
ROOT.SetOwnership( o, False )      # True to own, False to release
```

### 19.1.6.2 Memory Management by Hand

If needed, you can explicitly destroy a ROOT object that you own through its associated `TClass`:

```
myobject.IsA().Destructor(myobject)
```

which will send out the deletion notification to the system (thus you do not need to care anymore at this point about Python reference counting, the object will go, even if it's reference count is non-zero), and free the memory.

## 19.1.7 Performance

The performance of PyROOT when programming with ROOT in Python is similar to that of CINT. Differences occur mainly because of differences in the respective languages: C++ is much harder to parse, but once parsed, it is much easier to optimize. Consequently, individual calls to ROOT are typically faster from PyROOT, whereas loops are typically slower.

When programming in Python, the modus operandi is to consider performance generally “good enough” on the outset, and when it turns out that, it is not good enough; the performance critical part is converted into C/C++ in an extension module. The school of thought where pre-mature optimization is the root of all evil should find this way of working very satisfying. In addition, if you look at their history, you will see that many of the standard Python modules have followed this path.

Your code should always make maximum use of ROOT facilities; such that most of the time is spending in compiled code. This goes even for very simple things: e.g. do not compute invariant masses in Python, use **TLorentzVector** instead. Moreover, before you start optimizing, make sure that you have run a profiler to find out where the bottlenecks are. Some performance, without cost in terms of programmer effort, may be gained by using **psyco**, see the next link: <http://psyco.sourceforge.net>, a Python just in time compiler (JIT). Note, however, that **psyco** is limited to Intel i386 CPUs. Since **psyco** optimizes Python, not PyROOT calls; it generally does not improve performance that much if most of your code consists of ROOT API calls. Mathematical computations in Python, on the other hand, benefit a lot.

Every call to a Python member function results in a lookup of that member function and an association of this method with 'self'. Furthermore, a temporary object is created during this process that is discarded after the method call. In inner loops, it may be worth your while (up to 30%), to short-cut this process by looking up and binding the method before the loop, and discarding it afterwards. Here is an example:

```
hpx = TH1F('hpx', 'px', 100, -4, 4)
hpxFill = hpx.Fill          # cache bound method
for i in xrange(25000):
    px = gRandom.Gaus()
hpxFill(px)                 # use bound method: no lookup needed
del hpxFill                 # done with cached method
```

Note that if you do not discard the bound method, a reference to the histogram will remain outstanding, and it will not be deleted when it should be. It is therefore important to delete the method when you're done with it.

## 19.1.8 Use of Python Functions

It is possible to mix Python functions with ROOT and perform such operations as plotting and fitting of histograms with them. In all cases, the procedure consists of instantiating a ROOT **TF1**, **TF2**, or **TF3** with the Python function and working with that ROOT object. There are some memory issues, so it is for example not yet possible to delete a **TF1** instance and then create another one with the same name. In addition, the Python function, once used for instantiating the **TF1**, is never deleted.

Instead of a Python function, you can also use callable instances (e.g., an instance of a class that has implemented the `__call__` member function). The signature of the Python callable should provide for one or two arrays. The first array, which must always be present, shall contain the x, y, z, and t values for the call. The second array, which is optional and its size depends on the number given to the **TF1** constructor, contains the values that parameterize the function. For more details, see the **TF1** documentation and the examples below.

### 19.1.8.1 Plotting Python Function

This is an example of a parameter less Python function that is plotted on a default canvas:

```
from ROOT import TF1, TCanvas

def identity( x ):
    return x[0]

# create an identity function
```

```
f = TF1('pyf1', identity, -1., 1.)

# plot the function
c = TCanvas()
f.Draw()
```

Because no number of parameters is given to the **TF1** constructor, '0' (the default) is assumed. This way, the 'identity' function need not handle a second argument, which would normally be used to pass the function parameters. Note that the argument 'x' is an array of size 4. The following is an example of a parameterized Python callable instance that is plotted on a default canvas:

```
from ROOT import TF1, TCanvas

class Linear:
    def __call__( self, x, par ):
        return par[0] + x[0]*par[1]

# create a linear function with offset 5, and pitch 2
f = TF1('pyf2',Linear(),-1.,1.,2)
f.SetParameters(5.,2.)

# plot the function
c = TCanvas()
f.Draw()
```

Note that this time the constructor is told that there are two parameters, and note in particular how these parameters are set. It is, of course, also possible (and preferable if you only use the function for plotting) to keep the parameters as data members of the callable instance and use and set them directly from Python.

### 19.1.8.2 Fitting Histograms

Fitting a histogram with a Python function is no more difficult than plotting: instantiate a **TF1** with the Python callable and supply that **TF1** as a parameter to the **Fit()** member function of the histogram. After the fit, you can retrieve the fit parameters from the **TF1** instance. For example:

```
from ROOT import TF1, TH1F, TCanvas

class Linear:
    def __call__( self, x, par ):
        return par[0] + x[0]*par[1]

# create a linear function for fitting
f = TF1('pyf3',Linear(),-1.,1.,2)

# create and fill a histogram
h = TH1F('h','test',100,-1.,1.)
f2 = TF1('cf2','6.+x*4.5',-1.,1.)
h.FillRandom('cf2',10000)

# fit the histo with the python 'linear' function
h.Fit(f)

# print results
par = f.GetParameters()
print('fit results: const =', par[0], ',pitch =', par[1])
```

### 19.1.9 Working with Trees

Next to making histograms, working with trees is probably the most common part of any analysis. The **TTree** implementation uses pointers and dedicated buffers to reduce the memory usage and to speed up access. Consequently, mapping **TTree** functionality to Python is not straightforward, and most of the following features are implemented in ROOT release 4.01/04 and later only, whereas you will need 5.02 if you require all of them.

#### 19.1.9.1 Accessing an Existing Tree

Let us assume that you have a file containing **TTrees**, **TChains**, or **TNtuples** and want to read the contents for use in your analysis code. This is commonly the case when you work with the result of the reconstruction software of your experiment (e.g. the combined ntuple in ATLAS). The following example code outlines the main steps (you can run it on the result of the `tree1.C` macro):

```
from ROOT import TFile

# open the file
myfile = TFile('tree1.root')

# retrieve the ntuple of interest
mychain = myfile.Get('t1')
entries = mychain.GetEntriesFast()

for jentry in xrange(entries):
    # get the next tree in the chain and verify
    ientry = mychain.LoadTree(jentry)
    if ientry < 0:
        break

    # copy next entry into memory and verify
    nb = mychain.GetEntry(jentry)
    if nb<=0:
        continue

    # use the values directly from the tree
    nEvent = int(mychain.ev)
    if nEvent<0:
        continue

    print(mychain.pz, '=', mychain.px*mychain.px, '+', mychain.py*mychain.py)
```

Access to arrays works the same way as access to single value tree elements, where the size of the array is determined by the number of values actually read from the file. For example:

```
# loop over array tree element
for d in mychain.mydoubles:
    print(d)

# direct access into an array tree element
i5 = mychain.myints[5]
```

#### 19.1.9.2 Writing a Tree

Writing a ROOT **TTree** in a Python session is a little convoluted, if only because you will need a C++ class to make sure that data members can be mapped, unless you are working with built-in types. Here is an example for working with the latter only:

```

from ROOT import TFile, TTree
from array import array

h = TH1F('h1','test',100,-10.,10.)
f = TFile('test.root','recreate')
t = TTree('t1','tree with histos')
maxn = 10
n = array('i',[0])
d = array('f',maxn*[0.])
t.Branch('mynum',n,'mynum/I')
t.Branch('myval',d,'myval[mynum]/F')

for i in range(25):
    n[0] = min(i,maxn)
    for j in range(n[0]):
        d[j] = i*0.1+j
        t.Fill()

f.Write()
f.Close()

```

The use of arrays is needed, because the pointer to the address of the object that is used for filling must be given to the `TTree::Branch()` call, even though the formal argument is declared a `'void*'`. In the case of ROOT objects, similar pointer manipulation is unnecessary, because the full type information is available, and `TTree::Branch()` has been Pythonized to take care of the call details. However, data members of such objects that are of built-in types, still require something extra since they are normally translated to Python primitive types on access and hence their address cannot be taken. For that purpose, there is the `AddressOf()` function. As an example:

```

from ROOT import TFile, TTree
from ROOT import gROOT, AddressOf

gROOT.ProcessLine(
"struct MyStruct { Int_t fMyInt1; Int_t fMyInt2; Int_t fMyInt3; Char_t fMyCode[4]; };" );

from ROOT import MyStruct
mystruct = MyStruct()
f = TFile('mytree.root','RECREATE')
tree = TTree('T','Just A Tree')
tree.Branch('myints',mystruct,'MyInt1/I:MyInt2:MyInt3')
tree.Branch('mycode',AddressOf(mystruct,'fMyCode'),'MyCode/C')
for i in range(0,10):
    mystruct.fMyInt1 = i
    mystruct.fMyInt2 = i*i
    mystruct.fMyInt3 = i*i*i
    mystruct.fMyCode = "%03d" % i      # note string assignment

    tree.Fill()

f.Write()
f.Close()

```

The C++ class is defined through the `gROOT.ProcessLine()` call, and note how the `AddressOf()` function is used for data members of built-in type. Most of the above is for ROOT version 5.02 and later only. For older releases, and without further support, here is an example as to how you can get hold of a pointer-to-pointer to a ROOT object:

```

h = TH1F()
addressofobject = array('i',[h.IsA().DynamicCast(h.IsA(),h)])

```

### 19.1.10 Using Your Own Classes

A user's own classes can be accessed after loading, either directly or indirectly, the library that contains the dictionary. One easy way of obtaining such a library, is by using ACLiC:

```
$ cat MyClass.C
class MyClass {
public:

MyClass(int value = 0) {
m_value = value;
}

void SetValue(int value) {
m_value = value;
}

int GetValue() {
return m_value;
}

private:
    int m_value;
};

$ echo .L MyClass.C+ | root.exe -b
[...]
Info in <TUnixSystem::ACLiC>: creating shared library [..]/MyClass_C.so
$
```

Then you can use it, for example, like so:

```
from ROOT import gSystem

# load library with MyClass dictionary
gSystem.Load('MyClass_C')

# get MyClass from ROOT
from ROOT import MyClass
# use MyClass
m = MyClass(42)
print(m.GetValue())
```

You can also load a macro directly, but if you do not use ACLiC, you will be restricted to use the default constructor of your class, which is otherwise fully functional. For example:

```
from ROOT import gROOT

# load MyClass definition macro (append '+' to use ACLiC)
gROOT.LoadMacro('MyClass.C')

# get MyClass from ROOT
from ROOT import MyClass

# use MyClass
m = MyClass()
m.SetValue(42)
print(m.GetValue())
```

## 19.2 How to Use ROOT with Ruby

Ruby ROOT is a Ruby extension module that allows the user to interact with any ROOT class from the Ruby scripting language. The Ruby module resolves ROOT Classes and Methods at run-time using the CINT API, so there is no need for wrapping specific Classes to be used in Ruby. The Ruby module, also, contains a **TRuby** class to execute Ruby statements via CINT and export C++ Objects to Ruby objects, interactively.

### 19.2.1 Building and Installing the Ruby Module

The Ruby extension module is not built by default when building ROOT from sources. The user should follow the standard installation instructions and enable the build of the Ruby module. Ruby version  $\geq 1.8$  is required.

```
./configure <arch> --enable-ruby --enable-explicitlink
[--with-ruby-include=<dir>] [--with-ruby-libdir=<dir>]
gmake
```

If you do not specify include and library directories configure will use Ruby to grab the directories where Ruby's headers and library are located. A library called `libRuby.so` [`libRuby.dll`] will be created in the `$ROOTSYS/lib` [`$ROOTSYS/bin`].

#### 19.2.1.1 Setting up the Environment

For working with the Ruby module, the `LD_LIBRARY_PATH` [`PATH`] and `RUBYLIB`, need to be set in addition to the standard `$ROOTSYS`.

For UNIX Platforms:

```
export LD_LIBRARY_PATH=$ROOTSYS/lib:$LD_LIBRARY_PATH
export RUBYLIB=$ROOTSYS/lib:$RUBYLIB
```

For Windows:

```
set PATH=%ROOTSYS%/bin;%PATH%
set RUBYLIB=%ROOTSYS%/bin;%RUBYLIB%
```

#### 19.2.1.2 Running ROOT scripts from Ruby

The user should make sure that the ruby command is the one of the installation that has been used to build the Ruby extension module. If the `RUBYLIB` environment variable is set correctly, the user can execute a Ruby script with ROOT functionality in the following way:

```
ruby -rlibRuby foo.rb
```

Another way is to start the Ruby script with the Ruby require command:

```
require 'libRuby'
```

An example is as follows:

```
require 'libRuby'
gROOT.Reset
c1 = TCanvas.new('c1','Example with Formula',200,10,700,500)
#
# Create a one dimensional function and draw it
#
fun1 = TF1.new('fun1','abs(sin(x)/x)',0,10)
c1.SetGridx
c1.SetGridy
fun1.Draw
c1.Update
```



The user can find a number of examples in the `$ROOTSYS/tutorials`. To run them you need to execute the command:

```
cd $ROOTSYS/tutorials
```

```
ruby demo.rb
```

### 19.2.1.3 Invoking the Ruby Module from CINT Interpreter

A ROOT user can run any Ruby command and eventually to run IRB, the Interactive Ruby Shell. The commands to execute are:

```
root [] TRuby::Exec("require '/usr/local/lib/root/libRuby'");
root [] TRuby::Exec("c1 = TBrowser.new");
root [] TRuby::Eval("c1.GetName");
root [] TRuby::Eval("puts c1.GetName");
Browser
root [] TCanvas *c2 = new TCanvas("ruby test", "test", 10, 10, 100, 100);
root [] TRuby::Bind(c2, "$c");
root [] TRuby::Eval("puts $c.GetTitle");
test
root [] TRuby::Prompt();
root [] TRuby::Prompt();
irb(main):001:0> print 1
1=> nil
irb(main):002:0>
```

Notice that whenever you bind a ROOT Object in the Ruby side, you need to use a global Ruby variable, that is a variable with a leading "\$".



# Chapter 20

## The Tutorials and Tests

This chapter is a guide to the examples that come with the installation of ROOT. They are located in two directories: `$ROOTSYS/tutorials` and `$ROOTSYS/test`.

### 20.1 `$ROOTSYS/tutorials`

The tutorials directory contains many example scripts. *To have all examples working you must have write permission and you will need to execute `hsimple.C` first.* If you do not have write permission in the directory `$ROOTSYS/tutorials`, copy the entire directory to your area. The script `hsimple.C` displays a histogram as it is being filled, and creates a ROOT file used by the other examples.

To execute it type:

```
> cd $ROOTSYS/tutorials
> root
*****
*                                     *
*           W E L C O M E to R O O T   *
*                                     *
*   Version   5.16/00       27 June 2006 *
*                                     *
*   You are welcome to visit our Web site *
*           http://root.cern.ch          *
*                                     *
*****
FreeType Engine v2.1.9 used to render TrueType fonts.
Compiled on 28 June 2007 for linux with thread support.

CINT/ROOT C/C++ Interpreter version 5.16.21, June 22, 2007
Type ? for help. Commands must be C++ statements.
Enclose multiple statements between { }.
root[0] .x hsimple.C
```

Now execute `demos.C`, which brings up the button bar shown on the left. You can click on any button to execute another example. To see the source, open the corresponding source file (for example `fit1.C`). Once you are done, and want to quit the ROOT session, you can do so by typing `.q`.

```
root[] .x demos.C
root[] .q
```



## 20.2 \$ROOTSYS/test

The test directory contains a set of examples that represent all areas of the framework. When a new release is cut, the examples in this directory are compiled and run to test the new release's backward compatibility.

We see these source files:

---

<code>Makefile</code>	Makefile to build all test programs.
<code>hsimple.cxx</code>	Simple test program that creates and saves some histograms
<code>MainEvent.cxx</code>	Simple test program that creates a ROOT Tree object and fills it with some simple structures but also with complete histograms. This program uses the files <code>Event.cxx</code> , <code>EventCint.cxx</code> and <code>Event.h</code> . An example of a procedure to link this program is in <code>bind_Event</code> . Note that the <code>Makefile</code> invokes the <code>rootcint</code> utility to generate the CINT interface <code>EventCint.cxx</code>
<code>Event.cxx</code>	Implementation for classes <code>Event</code> and <code>Track</code>
<code>minexam.cxx</code>	Simple test program for data fitting
<code>tcollex.cxx</code>	Example usage of the ROOT collection classes
<code>tcollbm.cxx</code>	Benchmarks of ROOT collection classes
<code>ctorture.cxx</code>	Test program for the class <code>TComplex</code>
<code>tstring.cxx</code>	Example usage of the ROOT string class
<code>vmatrix.cxx</code>	Verification program for the <code>TMatrix</code> class
<code>vvector.cxx</code>	Verification program for the <code>TVector</code> class
<code>vlazy.cxx</code>	Verification program for lazy matrices
<code>hworld.cxx</code>	Small program showing basic graphics
<code>guitest.cxx</code>	Example usage of the ROOT GUI classes
<code>gui viewer .cxx</code>	Another ROOT GUI example program
<code>Hello.cxx</code>	Dancing text example
<code>Aclock.cxx</code>	Analog clock (a la X11 <code>xclock</code> )
<code>Tetris.cxx</code>	The known Tetris game based on the ROOT graphics
<code>stress.cxx</code>	Important ROOT stress testing program
<code>stress*.cxx</code>	Stress testing of different ROOT classes
<code>bench.cxx</code>	STL and ROOT container test and benchmarking program
<code>QpRandomDriver.cxx</code>	Verification program for Quadratic programming classes in Quadp library
<code>DrawTest.sh</code>	Entry script to extensive <code>TTree</code> query test suite
<code>dt_*</code>	Scripts used by <code>DrawTest.sh</code>

---

The `$ROOTSYS/test` directory is a gold mine of root-wisdom nuggets, and we encourage you to explore and exploit it. These instructions will compile all programs in `$ROOTSYS/test`:

If you do not have write permission in the `$ROOTSYS/test` directory, copy the entire `$ROOTSYS/test` directory to your area. The `Makefile` is a useful example of how ROOT applications are linked and built. Edit the `Makefile` to specify your architecture by changing the `ARCH` variable, for example, on an SGI machine type: `ARCH = sgikcc`.

Now compile all programs:

```
% gmake
```

This will build several applications and shared libraries. We are especially interested in `Event`, `stress`, and `guitest`.

### 20.2.1 Event - An Example of a ROOT Application

Event is created by compiling `MainEvent.cxx`, and `Event.cxx`. It creates a ROOT file with a tree and two histograms. When running `Event` we have four optional arguments with defaults:

---

	Argument	Default
1	Number of Events (1 ... n)	400
2	Compression level: 0: no compression at all. 1: If the split level is set to zero, everything is compressed according to the <code>gzip</code> level 1. If split level is set to 1, leaves that are not floating point numbers are compressed using the <code>gzip</code> level 1. 2: If the split level is set to zero, everything is compressed according to the <code>gzip</code> level 2. If split level is set to 1, all non floating point leaves are compressed according to the <code>gzip</code> level 2 and the floating point leaves are compressed according to the <code>gzip</code> level 1 ( <code>gzip</code> level -1). Floating point numbers are compressed differently because the gain when compressing them is about 20 - 30%. For other data types it is generally better and around 100%.	1
3	Split or not Split 0: only one single branch is created and the complete event is serialized in one single buffer 1: a branch per variable is created.	1 (Split)
4	Fill 0: read the file 1: write the file, but don't fill the histograms 2: don't write, don't fill the histograms 10: fill the histograms, don't write the file 11: fill the histograms, write the file 20: read the file sequentially 25: read the file at random	1 (Write, no fill)

---

#### 20.2.1.1 Effect of Compression on File Size and Write Times

You may have noticed that a ROOT file has up to nine compression level, but here only levels 0, 1, and 2 are described. Compression levels above 2 are not competitive. They take up to much write time compared to the gain in file space. Below are three runs of `Event` on a Pentium III 650 MHz and the resulting file size and write and read times.

No Compression:

```
> Event 400 0 1 1
400 events and 19153182 bytes processed.
RealTime=6.840000 seconds, CpuTime=3.560000 seconds
compression level=0, split=1, arg4=1
You write 2.800173 Mbytes/Realtime seconds
You write 5.380107 Mbytes/Cputime seconds
```

```
> ls -l Event.root
... 19752171 Feb 23 18:26 Event.root
```

```
> Event 400 0 1 20
400 events and 19153182 bytes processed.
RealTime=0.790000 seconds, CpuTime=0.790000 seconds
You read 24.244533 Mbytes/Realtime seconds
You read 24.244533 Mbytes/Cputime seconds
```

We see the file size without compression is 19.75 MB, the write time is 6.84 seconds and the read time is 0.79 seconds.

Compression = 1: event is compressed:

```
> Event 400 1 1 1
400 events and 19153182 bytes processed.
RealTime=6.440000 seconds, CpuTime=4.020000 seconds
compression level=1, split=1, arg4=1
You write 2.974096 Mbytes/Realtime seconds
You write 4.764473 Mbytes/Cputime seconds

> ls -l Event.root
...      17728188 Feb 23 18:28 Event.root

> Event 400 1 1 20
400 events and 19153182 bytes processed.
RealTime=0.900000 seconds, CpuTime=0.900000 seconds
You read 21.281312 Mbytes/Realtime seconds
You read 21.281312 Mbytes/Cputime seconds
```

We see the file size 17.73, the write time was 6.44 seconds and the read time was 0.9 seconds.

Compression = 2: Floating point numbers are compressed with level 1:

```
> Event 400 2 1 1
400 events and 19153182 bytes processed.
RealTime=11.340000 seconds, CpuTime=9.510000 seconds
compression level=2, split=1, arg4=1
You write 1.688993 Mbytes/Realtime seconds
You write 2.014004 Mbytes/Cputime seconds

> ls -l Event.root
...      13783799 Feb 23 18:29 Event.root

> Event 400 2 1 20
400 events and 19153182 bytes processed.
RealTime=2.170000 seconds, CpuTime=2.170000 seconds
You read 8.826351 Mbytes/Realtime seconds
You read 8.826351 Mbytes/Cputime seconds
```

The file size is 13.78 MB, the write time is 11.34 seconds and the read time is 2.17 seconds.

This table summarizes the findings on the impact of compressions:

Compression	File Size	Write Times	Read Times
0	19.75 MB	6.84 sec.	0.79 sec.
1	17.73 MB	6.44 sec.	0.90 sec.
2	13.78 MB	11.34 sec.	2.17 sec.

### 20.2.1.2 Setting the Split Level

Split Level = 0:

Now we execute Event with the split parameter set to 0:

```
> Event 400 1 0 1
> root
root[] TFile f("Event.root")
root[] TBrowser T
```

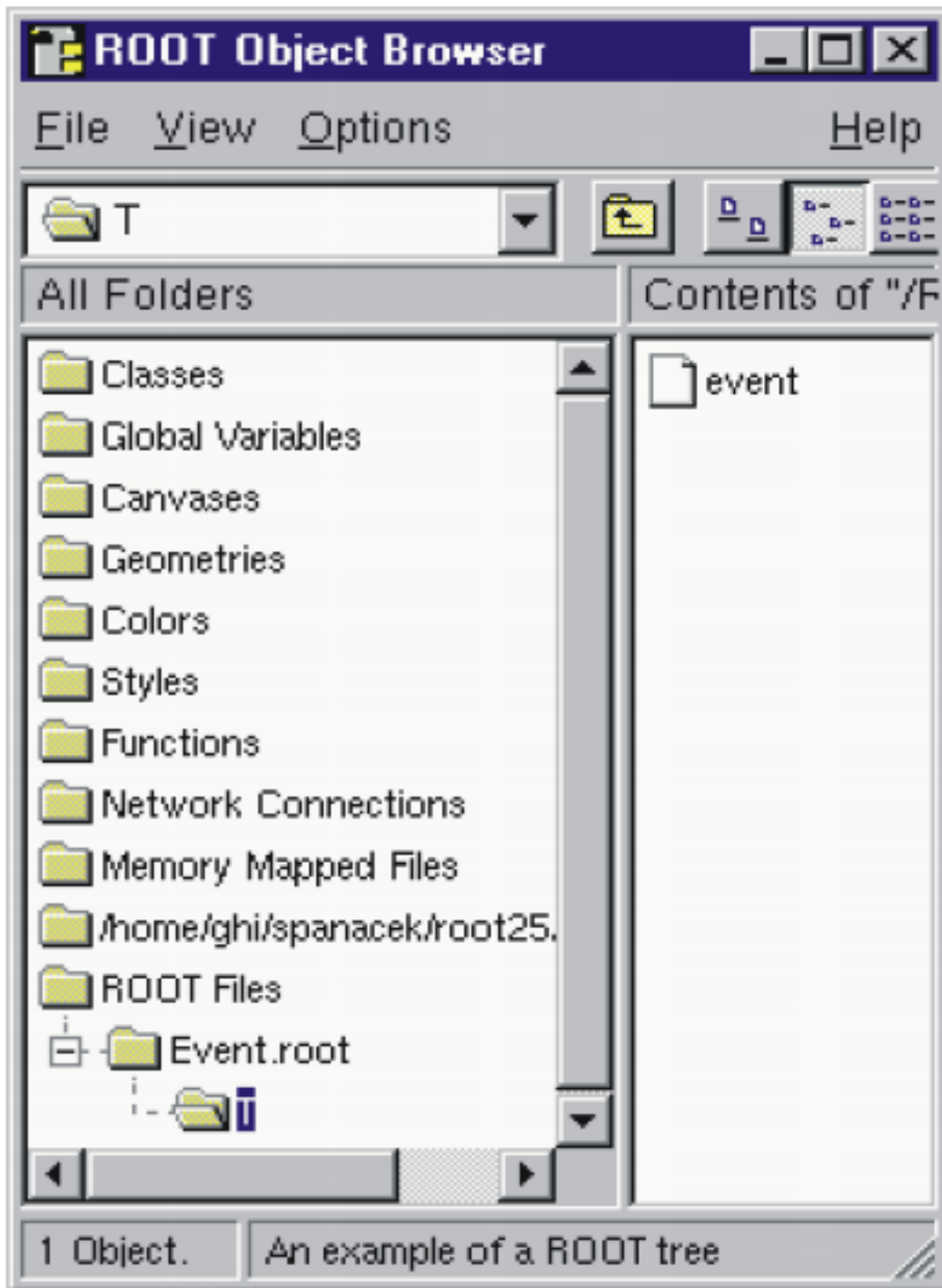



We notice that only one branch is visible (event). The individual data members of the `Event` object are no longer visible in the browser. They are contained in the event object on the event branch, because we specified no splitting. Split Level = 1: Setting the split level to 1 will create a branch for each data member in the Event object. First we execute `Event` and set the split level to 1 and start the browser to examine the split tree:

```
> Event 400 1 1 1

> root
root[] TFile f("Event.root")
root[] TBrowser browser
```

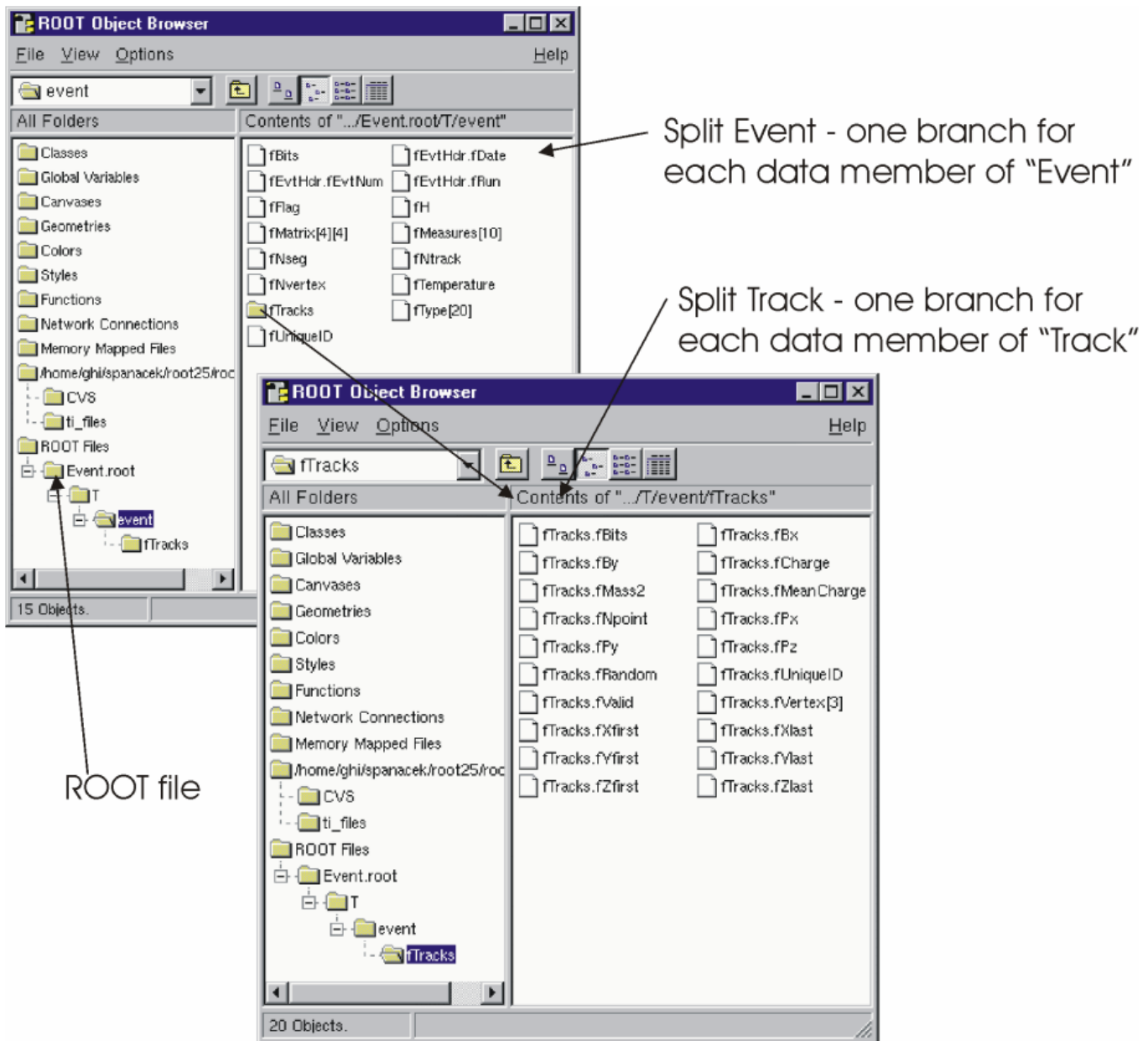

### 20.2.2 stress - Test and Benchmark

The executable `stress` is created by compiling `stress.cxx`. It completes sixteen tests covering the following capabilities of the ROOT framework.

- Functions, Random Numbers, Histogram Fits
- Size & compression factor of a ROOT file
- Purge, Reuse of gaps in **TFile**
- 2D Histograms, Functions, 2D Fits
- Graphics & PostScript
- Subdirectories in a ROOT file
- **TNtuple**, Selections, **TCutG**, **TEventList**
- Split and Compression modes for Trees
- Analyze **Event.root** file of stress 8
- Create 10 files starting from **Event.root**
- Test chains of Trees using the 10 files
- Compare histograms of test 9 and 11
- Merging files of a chain
- Check correct rebuilt of **Event.root** in test 13
- Divert Tree branches to separate files
- CINT test (3 nested loops) with LHCb trigger

The program **stress** takes one argument, the number of events to process. The default is 1000 events. Be aware that executing **stress** with 1000 events *will create several files consuming about 100 MB of disk space*; running **stress** with 30 events will consume about 20 MB. The disk space is released once **stress** is done.

There are two ways to run **stress**:

From the system prompt or from the ROOT prompt using the interpreter.

```
> cd $ROOTSYS/test
> stress           // default 1000 events
> stress 30       // test with 30 events
```

Start ROOT with the batch mode option (-b) to suppress the graphic output.

```
> root -b
root[] .L stress.cxx
root[] stress(1000)// test with 1000 events
root[] stress(30)// test with 30 events
```

The output of **stress** includes a pass/fail conclusion for each test, the total number of bytes read and written, and the elapsed real and CPU time. It also calculates a performance index for your machine relative to a reference machine a DELL Inspiron 7500 (Pentium III 600 MHz) with 256 MB of memory and 18GB IDE disk in ROOTMARKS. Higher ROOTMARKS means better performance. The reference machine has 200 ROOTMARKS, so the sample run below with 53.7 ROOTMARKS is about four times slower than the reference machine.

Here is a sample run:

```
% root -b
root[] .x stress.cxx(30)
```

```
Test 1 : Functions, Random Numbers, Histogram Fits..... OK
Test 2 : Check size & compression factor of a Root file..... OK
```

```

Test 3 : Purge, Reuse of gaps in TFile..... OK
Test 4 : Test of 2-d histograms, functions, 2-d fits..... OK
Test 5 : Test graphics & PostScript .....OK
Test 6 : Test subdirectories in a Root file..... OK
Test 7 : TNtuple, selections, TCutG, TEventList..... OK
Test 8 : Trees split and compression modes..... OK
Test 9 : Analyze Event.root file of stress 8..... OK
Test 10 : Create 10 files starting from Event.root..... OK
Test 11 : Test chains of Trees using the 10 files..... OK
Test 12 : Compare histograms of test 9 and 11..... OK
Test 13 : Test merging files of a chain..... OK
Test 14 : Check correct rebuilt of Event.root in test 13..... OK
Test 15 : Divert Tree branches to separate files..... OK
Test 16 : CINT test (3 nested loops) with LHCb trigger..... OK
*****
* IRIX64 fnpat1 6.5 01221553 IP27
*****
stress   : Total I/O = 75.3 Mbytes, I = 59.2, O = 16.1
stress   : Compr I/O = 75.7 Mbytes, I = 60.0, O = 15.7
stress   : Real Time = 307.61 seconds Cpu Time = 292.82 seconds
*****
* ROOTMARKS = 53.7 * Root2.25/00 20000710/1022

```

### 20.2.3 guitest - A Graphical User Interface

The `guitest` example, created by compiling `guitest.cxx`, tests and illustrates the use of the native GUI widgets such as cascading menus, dialog boxes, sliders and tab panels. It is a very useful example to study when designing a GUI. Some examples of the output of `guitest` are shown next. To run it type `guitest` at the system prompt in the `$ROOTSYS/test` directory. We have included an entire chapter on this subject where we explore `guitest` in detail and use it to explain how to build our own ROOT application with a GUI. See “Writing a Graphical User Interface”.

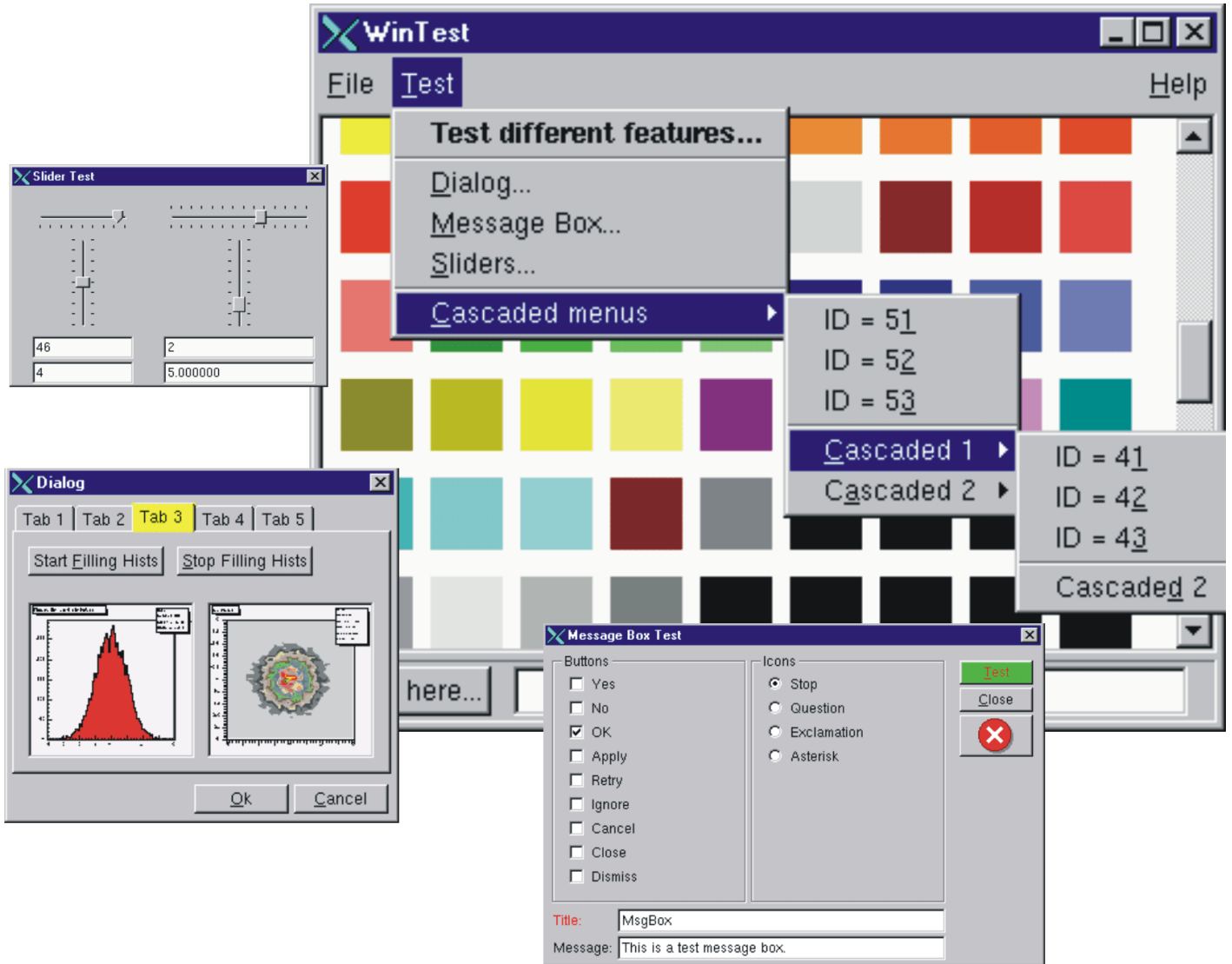

Figure 20.1: Native GUI widgets

# Chapter 21

## Example Analysis

This chapter is an example of a typical physics analysis. Large data files are chained together and analyzed using the `TSelector` class.

### 21.1 Explanation

This script uses four large data sets from the H1 collaboration at DESY Hamburg. One can access these data sets (277 Mbytes) from the ROOT web site at: <ftp://root.cern.ch/root/h1analysis/>

The physics plots generated by this example cannot be produced using smaller data sets.

There are several ways to analyze data stored in a ROOT Tree

- Using `TTree::Draw`:
- This is very convenient and efficient for small tasks. A `TTree::Draw` call produces one histogram at the time. The histogram is automatically generated. The selection expression may be specified in the command line.
- Using the `TTreeView`:
- This is a graphical interface to `TTree::Draw` with the same functionality.
- Using the code generated by `TTree::MakeClass`:
- In this case, the user creates an instance of the analysis class. He has the control over the event loop and he can generate an unlimited number of histograms.
- Using the code generated by `TTree::MakeSelector`: Like for the code generated by `TTree::MakeClass`, the user can do complex analysis. However, he cannot control the event loop. The event loop is controlled by `TTree::Process` called by the user. This solution is illustrated by the code below. The advantage of this method is that it can be run in a parallel environment using PROOF (the Parallel Root Facility).

A chain of four files (originally converted from PAW ntuples) is used to illustrate the various ways to loop on ROOT data sets. Each contains a ROOT Tree named “h42”. The class definition in `h1analysis.h` has been generated automatically by the ROOT utility `TTree::MakeSelector` using one of the files with:

```
h42->MakeSelector("h1analysis");
```

This produces two files: `h1analysis.h` and `h1analysis.C`. A skeleton of `h1analysis.C` file is made for you to customize. The `h1analysis` class is derived from the ROOT class `TSelector`. The following members functions of `h1analysis` (i.e. `TSelector`) are called by the `TTree::Process` method.

- **Begin**: This function is called every time a loop over the tree starts. This is a convenient place to create your histograms.

- `Notify()`: This function is called at the first entry of a new tree in a chain.
- `ProcessCut`: This function is called at the beginning of each entry to return a flag true if the entry must be analyzed.
- `ProcessFill`: This function is called in the entry loop for all entries accepted by `Select`.
- `Terminate`: This function is called at the end of a loop on a `TTree`. This is a convenient place to draw and fit your histograms.

To use this program, try the following session.

First, turn the timer on to show the real and CPU time per command.

```
root[] gROOT->Time();
```

*Step A:* create a `TChain` with the four H1 data files. The chain can be created by executed this short script `h1chain.C` below. `$H1` is a system symbol pointing to the H1 data directory.

```
{
  TChain chain("h42");
  chain.Add("$H1/dstarmb.root");
  //21330730 bytes, 21920 events
  chain.Add("$H1/dstarp1a.root");
  //71464503 bytes, 73243 events
  chain.Add("$H1/dstarp1b.root");
  //83827959 bytes, 85597 events
  chain.Add("$H1/dstarp2.root");
  //100675234 bytes, 103053 events
}
```

Run the above script from the command line:

```
root[] .x h1chain.C
```

*Step B:* Now we have a directory containing the four data files. Since a `TChain` is a descendent of `TTree` we can call `TChain::Process` to loop on all events in the chain. The parameter to the `TChain::Process` method is the name of the file containing the created `TSelector` class (`h1analysis.C`).

```
root[] chain.Process("h1analysis.C")
```

*Step C:* Same as step B, but in addition fill the event list with selected entries. The event list is saved to a file "`elist.root`" by the `TSelector::Terminate` method. To see the list of selected events, you can do `elist->Print("all")`. The selection function has selected 7525 events out of the 283813 events in the chain of files. (2.65 per cent)

```
root[] chain.Process("h1analysis.C", "fillList")
```

*Step D:* Process only entries in the event list. The event list is read from the file in `elist.root` generated by step C.

```
root[] chain.Process("h1analysis.C", "useList")
```

*Step E:* The above steps have been executed with the interpreter. You can repeat the steps B, C, and D using `ACLIC` by replacing "`h1analysis.C`" by "`h1analysis.C+`" or "`h1analysis.C++`".

*Step F:* If you want to see the differences between the interpreter speed and `ACLIC` speed start a new session, create the chain as in step 1, then execute

```
root[] chain.Process("h1analysis.C+", "useList")
```

The commands executed with the four different methods B, C, D and E produce two canvases shown below:

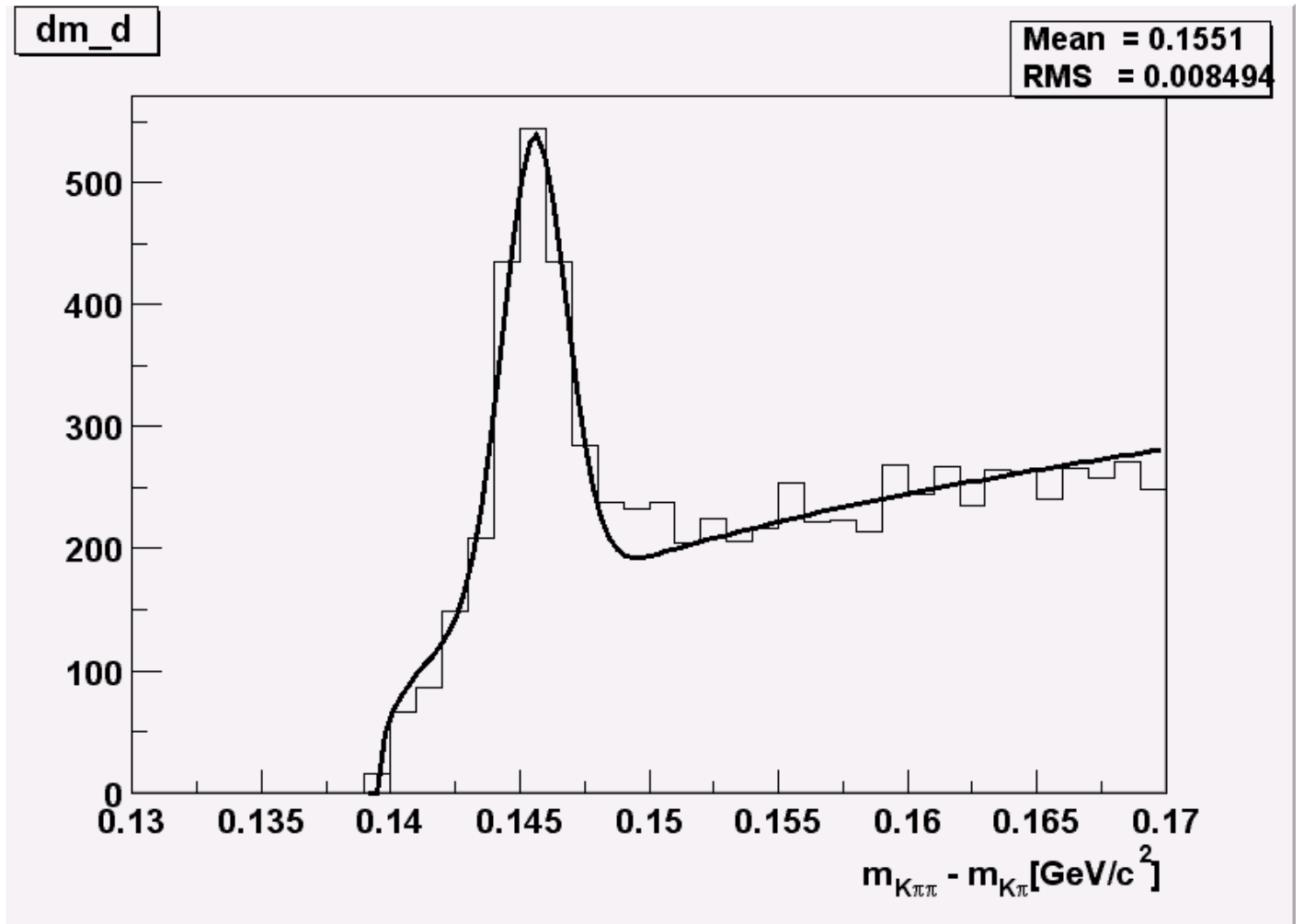

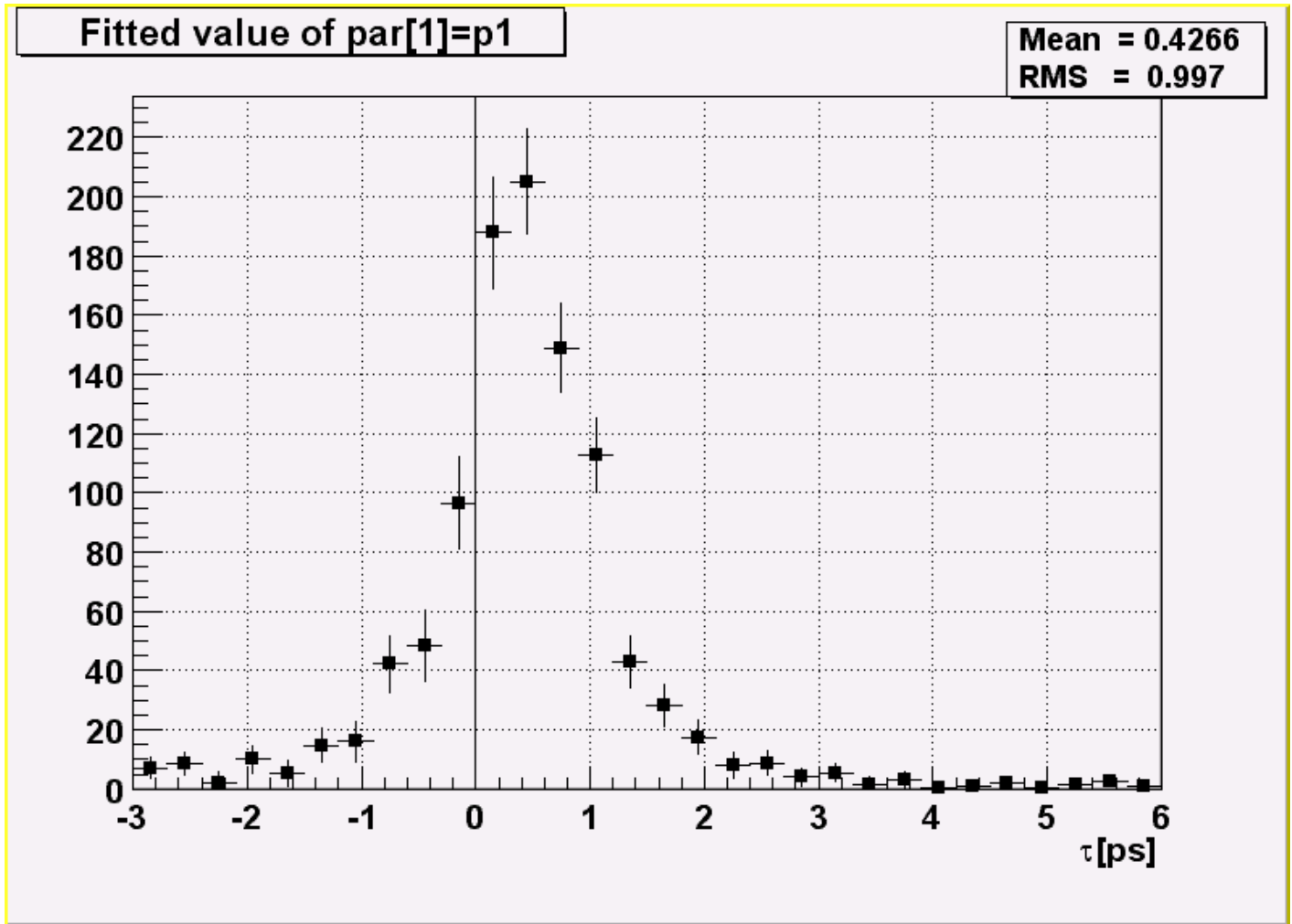

## 21.2 Script

This is the `h1analysis.C` file that was generated by `TTree::MakeSelector` and then modified to perform the analysis.

```
#include "h1analysis.h"
#include "TH2.h"
#include "TF1.h"
#include "TStyle.h"
#include "TCanvas.h"
#include "TLine.h"
#include "TEventList.h"

const Double_t dxbin = (0.17-0.13)/40; // Bin-width
const Double_t sigma = 0.0012;
TEventList *elist = 0;
Bool_t useList, fillList;
TH1F *hdmd;
TH2F *h2;

//-----
Double_t fdm5(Double_t *xx, Double_t *par)
{
  Double_t x = xx[0];
  if (x <= 0.13957) return 0;

```



```

Double_t xp3 = (x-par[3])*(x-par[3]);
Double_t res = dxbin*(par[0]*TMath::Power(x-0.13957,par[1])
+ par[2]/2.5066/par[4]*TMath::Exp(-xp3/2/par[4]/par[4]));
return res;
}

//-----
Double_t fdm2(Double_t *xx, Double_t *par)
{
    Double_t x = xx[0];
    if (x <= 0.13957) return 0;
    Double_t xp3 = (x-0.1454)*(x-0.1454);
    Double_t res = dxbin*(par[0]*TMath::Power(x-0.13957,0.25)
+ par[1]/2.5066/sigma*TMath::Exp(-xp3/2/sigma/sigma));
    return res;
}

//-----
void h1analysis::Begin(TTree *tree)
{
    // function called before starting the event loop
    // -it performs some cleanup
    // -it creates histograms
    // -it sets some initialization for the event list

    //initialize the Tree branch addresses
    Init(tree);

    //print the option specified in the Process function
    TString option = GetOption();
    printf("Starting h1analysis with process option: %sn",option.Data());

    //Some cleanup in case this function had already been executed
    //Delete any previously generated histograms or functions
    gDirectory->Delete("hdmd");
    gDirectory->Delete("h2*");
    delete gROOT->GetFunction("f5");
    delete gROOT->GetFunction("f2");

    //create histograms
    hdmd = new TH1F("hdmd", "dm_d", 40, 0.13, 0.17);
    h2 = new TH2F("h2", "ptD0 vs dm_d", 30, 0.135, 0.165, 30, -3, 6);

    //process cases with event list
    fillList = kFALSE;
    useList = kFALSE;
    fChain->SetEventList(0);
    delete gDirectory->GetList()->FindObject("elist");

    // case when one creates/fills the event list
    if (option.Contains("fillList")) {
        fillList = kTRUE;
        elist = new TEventList("elist", "selection from Cut", 5000);
    }

    // case when one uses the event list generated in a previous call
    if (option.Contains("useList")) {
        useList = kTRUE;
        TFile f("elist.root");
        elist = (TEventList*)f.Get("elist");
    }
}

```

```

    if (elist) elist->SetDirectory(0);
    //otherwise the file destructor will delete elist
    fChain->SetEventList(elist);
}
}
//-----
Bool_t h1analysis::ProcessCut(Int_t entry)
{ // Selection function to select D* and D0.

    //in case one event list is given in input,
    //the selection has already been done.
    if (useList) return kTRUE;
    // Read only the necessary branches to select entries.
    // return as soon as a bad entry is detected
    b_md0_d->GetEntry(entry);
    if (TMath::Abs(md0_d-1.8646) >= 0.04) return kFALSE;
    b_ptds_d->GetEntry(entry);
    if (ptds_d <= 2.5) return kFALSE;
    b_etads_d->GetEntry(entry);
    if (TMath::Abs(etads_d) >= 1.5) return kFALSE;
    b_ik->GetEntry(entry); ik--;
    //original ik used f77 convention starting at 1
    b_ipi->GetEntry(entry);
    ipi--;
    b_ntracks->GetEntry(entry);
    b_nhitrp->GetEntry(entry);
    if (nhitrp[ik]*nhitrp[ipi] <= 1) return kFALSE;
    b_rend->GetEntry(entry);
    b_rstart->GetEntry(entry);
    if (rend[ik]-rstart[ik] <= 22) return kFALSE;
    if (rend[ipi]-rstart[ipi] <= 22) return kFALSE;
    b_nlhk->GetEntry(entry);
    if (nlhk[ik] <= 0.1) return kFALSE;
    b_nlhpi->GetEntry(entry);
    if (nlhpi[ipi] <= 0.1) return kFALSE;
    b_ipis->GetEntry(entry);
    ipis--;
    if (nlhpi[ipis] <= 0.1) return kFALSE;
    b_njets->GetEntry(entry);
    if (njets < 1) return kFALSE;

    // if option fillList, fill the event list
    if (fillList) elist->Enter(fChain->GetChainEntryNumber(entry));

    return kTRUE;
}
//-----
void h1analysis::ProcessFill(Int_t entry)
{ // Function called for selected entries only

    // read branches not processed in ProcessCut
    b_dm_d->GetEntry(entry);
    //read branch holding dm_d
    b_rpd0_t->GetEntry(entry);
    //read branch holding rpd0_t
    b_ptd0_d->GetEntry(entry);
    //read branch holding ptd0_d //continued...
    //fill some histograms

```

```

    hdmd->Fill(dm_d);
    h2->Fill(dm_d, rpd0_t/0.029979*1.8646/ptd0_d);
}

//-----
void h1analysis::Terminate()
{ // Function called at the end of the event loop

    //create the canvas for the h1analysis fit
    gStyle->SetOptFit();
    TCanvas *c1 = new TCanvas("c1", "h1analysis analysis", 10, 10, 800, 600);
    c1->SetBottomMargin(0.15);
    hdmd->GetXaxis()->SetTitle("m_{K#pi#pi}-m_{K#pi}[GeV/c^{2}]");
    hdmd->GetXaxis()->SetTitleOffset(1.4);

    //fit histogram hdmd with function f5 using
    //the loglikelihood option
    TF1 *f5 = new TF1("f5", fdm5, 0.139, 0.17, 5);
    f5->SetParameters(1000000, .25, 2000, .1454, .001);
    hdmd->Fit("f5", "lr");

    //create the canvas for tau d0
    gStyle->SetOptFit(0);
    gStyle->SetOptStat(1100);
    TCanvas *c2 = new TCanvas("c2", "tauD0", 100, 100, 800, 600);
    c2->SetGrid();
    c2->SetBottomMargin(0.15);

    // Project slices of 2-d histogram h2 along X ,
    // then fit each slice with function f2 and make a
    // histogram for each fit parameter.
    // Note that the generated histograms are added
    // to the list of objects in the current directory.

    TF1 *f2 = new TF1("f2", fdm2, 0.139, 0.17, 2);
    f2->SetParameters(10000, 10);
    h2->FitSlicesX(f2, 0, 0, 1, "qln");
    TH1D *h2_1 = (TH1D*)gDirectory->Get("h2_1");
    h2_1->GetXaxis()->SetTitle("#tau[ps]");
    h2_1->SetMarkerStyle(21);
    h2_1->Draw();
    c2->Update();
    TLine *line = new TLine(0, 0, 0, c2->GetUymax());
    line->Draw();

    // save the event list to a Root file if one was produced
    if (fillList) {
        TFile efile("elist.root", "recreate");
        elist->Write();
    }
}

```



# Chapter 22

## Networking

In this chapter, you will learn how to send data over the network using the ROOT socket classes.

### 22.1 Setting-up a Connection

*On the serverside*, we create a **TServerSocket** to wait for a connection request over the network. If the request is accepted, it returns a full-duplex socket. Once the connection is accepted, we can communicate to the client that we are ready to go by sending the string “go”, and we can close the server socket.

```
{ // server
  TServerSocket *ss = new TServerSocket(9090,kTRUE);
  TSocket *socket = ss->Accept();
  socket->Send("go");
  ss->Close();
}
```

*On the clientside*, we create a socket and ask the socket to receive input.

```
{ // client
  TSocket *socket = new TSocket("localhost",9090);
  Char str[32];
  socket->Recv(str,32);
}
```

### 22.2 Sending Objects over the Network

We have just established a connection and you just saw how to send and receive a string with the example “go”. Now let’s send a histogram.

*To send an object (in our case on the client side)* it has to derive from **TObject** class because it uses the **Streamers** to fill a buffer that is then sent over the connection. On the receiving side, the **Streamers** are used to read the object from the message sent via the socket. For network communication, we have a specialized **TBuffer**, a descendant of **TBuffer** called **TMessage**. In the following example, we create a **TMessage** with the intention to store an object, hence the constant **kMESS\_OBJECT** in the constructor. We create and fill the histogram and write it into the message. Then we call **TSocket::Send** to send the message with the histogram.

```
...
// create an object to be sent
TH1F *hpx = new TH1F("hpx","px distribution",100,-4,4);
hpx->FillRandom("gaus",1000);
```

```

// create a TMessage to send the object
TMessage message(kMESS_OBJECT);

// write the histogram into the message buffer
message.WriteObject(hpx);

// send the message
socket->Send(message);
...

```

On the receiving end (in our case the server side), we write a while loop to wait and receive a message with a histogram. Once we have a message, we call `TMessage::ReadObject`, which returns a pointer to `TObject`. We have to cast it to a `TH1` pointer, and now we have a histogram. At the end of the loop, the message is deleted, and another one is created at the beginning.

```

while (1) {
    TMessage *message;
    socket->Recv(message);
    TH1 *h = (TH1*)message->ReadObject(message->GetClass());
    delete message;
}

```

## 22.3 Closing the Connection

Once we are done sending objects, we close the connection by closing the sockets at both ends.

```
Socket->Close();
```

This diagram summarizes the steps we just covered:

## 22.4 A Server with Multiple Sockets

Chances are that your server has to be able to receive data from multiple clients. The class we need for this is `TMonitor`. It lets you add sockets and the `TMonitor::Select` method returns the socket with data waiting. Sockets can be added, removed, or enabled and disabled. Here is an example of a server that has a `TMonitor` to manage multiple sockets:

```

{
    TServerSocket *ss = new TServerSocket (9090, kTRUE);

    // Accept a connection and return a full-duplex communication socket.
    TSocket *s0 = ss->Accept();
    TSocket *s1 = ss->Accept();

    // tell the clients to start
    s0->Send("go 0");
    s1->Send("go 1");

    // Close the server socket (unless we will use it
    // later to wait for another connection).
    ss->Close();

    TMonitor *mon = new TMonitor;
    mon->Add(s0);
}

```

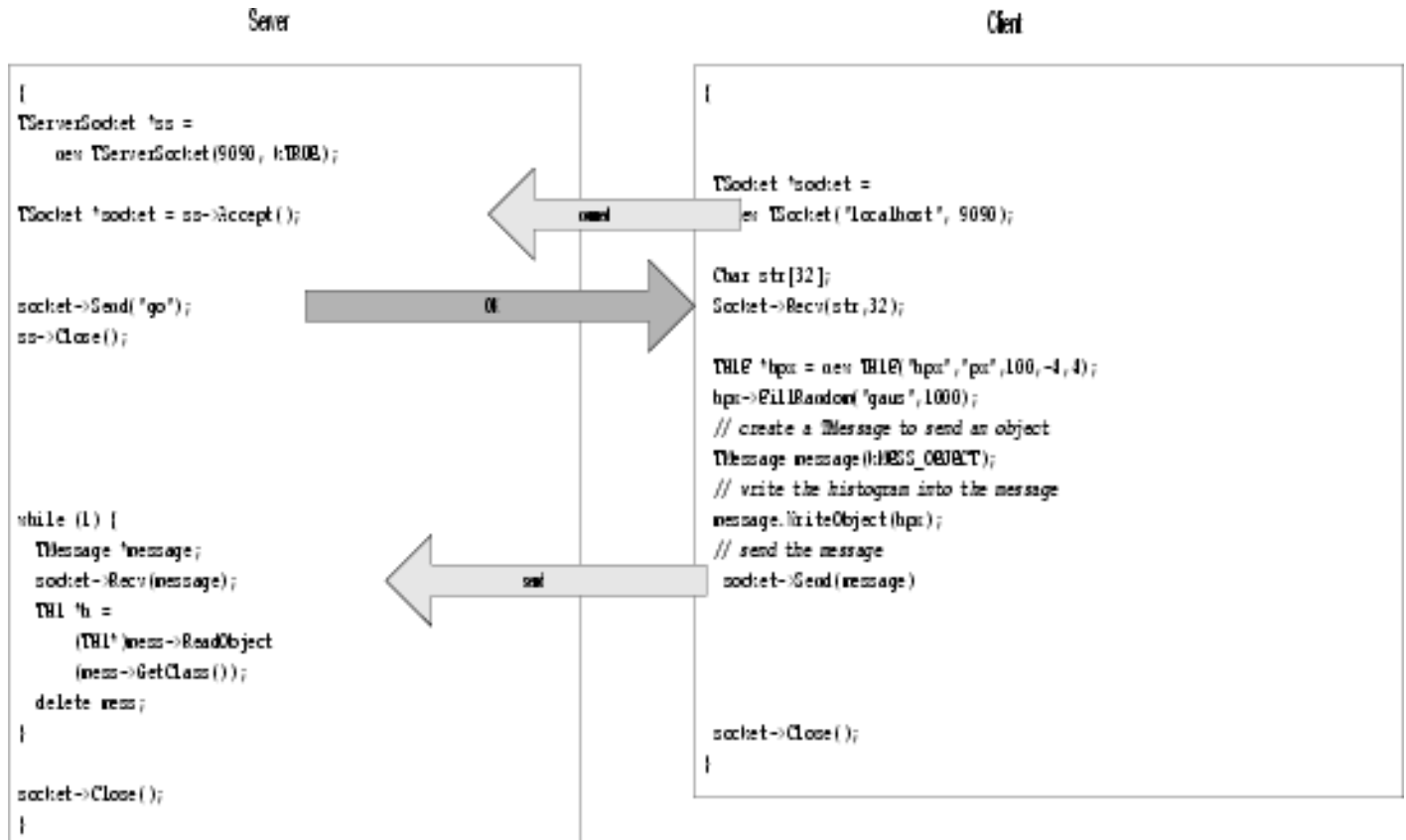

Figure 22.1: Server - Client setting-up and closing the connection

```

mon->Add(s1);

while (1) {
  TMessage *mess;
  TSocket *s;
  s = mon->Select();
  s->Recv(mess);
  ...
}
}

```

The full code for the example above is in `$ROOTSYS/tutorials/net/hserv.C` and `$ROOTSYS/tutorials/net/hclient.C`.





# Chapter 23

## Threads

A thread is an independent flow of control that operates within the same address space as other independent flows of controls within a process. In most UNIX systems, thread and process characteristics are grouped into a single entity called a process. Sometimes, threads are called “lightweight processes”.

Note: This introduction is adapted from the AIX 4.3 Programmer’s Manual.

### 23.1 Threads and Processes

In traditional single-threaded process systems, a process has a set of properties. In multi-threaded systems, these properties are divided between processes and threads.

#### 23.1.1 Process Properties

A process in a multi-threaded system is the changeable entity. It must be considered as an execution frame. It has all traditional process attributes, such as:

- Process ID, process group ID, user ID, and group ID
- Environment
- Working directory

A process also provides a common address space and common system resources:

- File descriptors
- Signal actions
- Shared libraries
- Inter-process communication tools (such as message queues, pipes, semaphores, or shared memory)

#### 23.1.2 Thread Properties

A thread is the schedulable entity. It has only those properties that are required to ensure its independent flow of control. These include the following properties:

- Stack
- Scheduling properties (such as policy or priority)

- Set of pending and blocked signals
- Some thread-specific data (TSD)

An example of thread-specific data is the error indicator, `errno`. In multi-threaded systems, `errno` is no longer a global variable, but usually a subroutine returning a thread-specific `errno` value. Some other systems may provide other implementations of `errno`. With respect to ROOT, a thread specific data is for example the `gPad` pointer, which is treated in a different way, whether it is accessed from any thread or the main thread.

Threads within a process must not be considered as a group of processes (even though in Linux each thread receives an own process id, so that it can be scheduled by the kernel scheduler). All threads share the same address space. This means that two pointers having the same value in two threads refer to the same data. Also, if any thread changes one of the shared system resources, all threads within the process are affected. For example, if a thread closes a file, the file is closed for all threads.

### 23.1.3 The Initial Thread

When a process is created, one thread is automatically created. This thread is called the initial thread or the main thread. The initial thread executes the main routine in multi-threaded programs.

Note: At the end of this chapter is a glossary of thread specific terms

## 23.2 Implementation of Threads in ROOT

The `TThread` class has been developed to provide a platform independent interface to threads for ROOT.

### 23.2.1 Installation

For the time being, it is still necessary to compile a threaded version of ROOT to enable some very special treatments of the canvas operations. We hope that this will become the default later.

To compile ROOT, just do (for example on a debian Linux):

```
./configure linuxdeb2 --with-thread=/usr/lib/libpthread.so
gmake depend
gmake
```

This configures and builds ROOT using `/usr/lib/libpthread.so` as the `Pthread` library, and defines `R__THREAD`.

This enables the thread specific treatment of `gPad`, and creates `ROOTSYS/lib/libThread.so`.

Note: The parameter `linuxdeb2` has to be replaced with the appropriate ROOT keyword for your platform.

### 23.2.2 Classes

`TThread` class implements threads . The platform dependent implementation is in the `TThreadImp` class and its descendant classes (e.g. `TPosixThread` ).

`TMutex` class implements `mutex` locks. A mutex is a mutually exclusive lock. The platform dependent implementation is in the `TMutexImp` class and its descendant classes (e.g. `TPosixMutex` )

`TCondition` class implements a condition variable. Use a condition variable to signal threads. The platform dependent implementation is in the `TConditionImp` and `TPosixCondition` classes .

`TSemaphore` class implements a counting semaphore. Use a semaphore to synchronize threads. The platform dependent implementation is in the `TMutexImp` and `TConditionImp` classes.

### 23.2.3 TThread for Pedestrians

To run a thread in ROOT, follow these steps:

#### 1. Initialization

Add these lines to your `rootlogon.C`:

```
{
  ...
  // The next line may be unnecessary on some platforms
  gSystem->Load("/usr/lib/libpthread.so");
  gSystem->Load("$ROOTSYS/lib/libThread.so");
  ...
}
```

This loads the library with the `TThread` class and the `pthread` specific implementation file for Posix threads.

#### 2. Coding

Define a function (e.g. `void* UserFun(void* UserArgs)`) that should run as a thread. The code for the examples is at the web site of the authors (Jörn Adamczewski, Marc Hemberger). After downloading the code from this site, you can follow the example below:

<http://www-linux.gsi.de/~go4/HOWTOthreads/howtothreadsbody.html>

#### 3. Loading

Start an interactive ROOT session. Load the shared library:

```
root [] gSystem->Load("mhs3.so");           // or
root [] gSystem->Load("CalcPiThread.so");
```

#### 4. Creating

Create a thread instance (see also example `RunMhs3.C` or `RunPi.C`) with:

```
root [] TThread *th = new TThread(UserFun,UserArgs);
```

When called from the interpreter, this gives the name “`UserFun`” to the thread. This name can be used to retrieve the thread later. However, when called from compiled code, this method does not give any name to the thread. So give a name to the thread in compiled use:

```
root [] TThread *th = new TThread("MyThread", UserFun, UserArgs);
```

You can pass arguments to the thread function using the `UserArgs`-pointer. When you want to start a method of a class as a thread, you have to give the pointer to the class instance as `UserArgs`.

#### 5. Running

```
root [] th->Run();
root [] TThread::Ps(); // like UNIX ps c.ommand;
```

With the `mhs3` example, you should be able to see a canvas with two pads on it. Both pads keep histograms updated and filled by three different threads. With the `CalcPi` example, you should be able to see two threads calculating Pi with the given number of intervals as precision.

## 23.2.4 TThread in More Details

CINT is not thread safe yet, and it will block the execution of the threads until it has finished executing.

### 23.2.4.1 Asynchronous Actions

Different threads can work simultaneously with the same object. Some actions can be dangerous. For example, when two threads create a histogram object, ROOT allocates memory and puts them to the same collection. If it happens at the same time, the results are undetermined. To avoid this problem, the user has to synchronize these actions with:

```
TThread::Lock()    // Locking the following part of code
...              // Create an object, etc...
TThread::Unlock() // Unlocking
```

The code between `Lock()` and `Unlock()` will be performed uninterrupted. No other threads can perform actions or access objects/collections while it is being executed. The methods `TThread::Lock()` and `TThread::Unlock()` internally use a global `TMutex` instance for locking.

The user may also define his own `TMutex` `MyMutex` instance and may locally protect his asynchronous actions by calling `MyMutex.Lock()` and `MyMutex.Unlock()`.

### 23.2.4.2 Synchronous Actions: TCondition

To synchronize the actions of different threads you can use the `TCondition` class, which provides a signaling mechanism. The `TCondition` instance must be accessible by all threads that need to use it, i.e. it should be a global object (or a member of the class which owns the threaded methods, see below). To create a `TCondition` object, a `TMutex` instance is required for the `Wait` and `TimedWait` locking methods. One can pass the address of an external mutex to the `TCondition` constructor:

```
TMutex MyMutex;
TCondition MyCondition(&MyMutex);
```

If zero is passed, `TCondition` creates and uses its own internal mutex:

```
TCondition MyCondition(0);
```

You can now use the following methods of synchronization:

- `TCondition::Wait()` waits until any thread sends a signal of the same condition instance: `MyCondition.Wait()` reacts on `MyCondition.Signal()` or `MyCondition.Broadcast()`. `MyOtherCondition.Signal()` has no effect.
- If several threads wait for the signal from the same `TCondition` `MyCondition`, at `MyCondition.Signal()` only one thread will react; to activate a further thread another `MyCondition.Signal()` is required, etc.
- If several threads wait for the signal from the same `TCondition` `MyCondition`, at `MyCondition.Broadcast()` all threads waiting for `MyCondition` are activated at once.

In some tests of `MyCondition` using an internal mutex, `Broadcast()` activated only one thread (probably depending whether `MyCondition` had been signaled before).

- `MyCondition.TimedWait(secs,nanosecs)` waits for `MyCondition` until the *absolute* time in seconds and nanoseconds since beginning of the epoch (January, 1st, 1970) is reached; to use relative timeouts “delta”, it is required to calculate the absolute time at the beginning of waiting “now”; for example:

```
Ulong_t now,then,delta;           // seconds
TDateTime myTime;                // root daytime class
myTime.Set();                     // myTime set to "now"
now=myTime.Convert();             // to seconds since 1970
```

- Return value `wait` of `MyCondition.TimedWait` should be 0, if `MyCondition.Signal()` was received, and should be nonzero, if timeout was reached.

The conditions example shows how three threaded functions are synchronized using `TCondition`: a ROOT script `condstart.C` starts the threads, which are defined in a shared library (`conditions.cxx`, `conditions.h`).

### 23.2.4.3 Xlib Connections

Usually `Xlib` is not thread safe. This means that calls to the X could fail, when it receives X-messages from different threads. The actual result depends strongly on which version of `Xlib` has been installed on your system. The only thing we can do here within ROOT is calling a special function `XInitThreads()` (which is part of the `Xlib`), which should (!) prepare the `Xlib` for the usage with threads.

To avoid further problems within ROOT some redefinition of the `gPad` pointer was done (that's the main reason for the recompilation). When a thread creates a `TCanvas`, this object is actually created in the main thread; this should be transparent to the user. Actions on the canvas are controlled via a function, which returns a pointer to either thread specific data (TSD) or the main thread pointer. This mechanism works currently only for `gPad*`, `gDirectory*`, `gFile` and will be implemented soon for other global Objects as e.g. `gVirtualX`.

### 23.2.4.4 Canceling a TThread

Canceling of a thread is a rather dangerous action. In `TThread` canceling is forbidden by default. The user can change this default by calling `TThread::SetCancelOn()`. There are two cancellation modes: deferred and asynchronous.

#### 23.2.4.5 Deferred

Set by `TThread::SetCancelDeferred()` (default): When the user knows safe places in his code where a thread can be canceled without risk for the rest of the system, he can define these points by invoking `TThread::CancelPoint()`. Then, if a thread is canceled, the cancellation is deferred up to the call of `TThread::CancelPoint()` and then the thread is canceled safely. There are some default cancel points for `pthread`s implementation, e.g. any call of the `TCondition::Wait()`, `TCondition::TimedWait()`, `TThread::Join()`.

#### 23.2.4.6 Asynchronous

Set by `TThread::SetCancelAsynchronous()`: If the user is sure that his application is cancel safe, he could call:

```
TThread::SetCancelAsynchronous();
TThread::SetCancelOn();
// Now cancelation in any point is allowed.
...
// Return to default
TThread::SetCancelOff();
TThread::SetCancelDeferred();
```

To cancel a thread `TThread* th` call:

```
th->Kill();
```

To cancel by thread name:

```
TThread::Kill(name);
```

To cancel a thread by ID:

```
TThread::Kill(tid);
```

To cancel a thread and delete `th` when cancel finished:

```
th->Delete();
```

Deleting of the thread instance by the operator `delete` is dangerous. Use `th->Delete()` instead. C++ `delete` is safe only if thread is not running. Often during the canceling, some clean up actions must be taken. To define clean up functions use:

```
void UserCleanUp(void *arg) {
    // here the user cleanup is done
    ...
}
TThread::CleanUpPush(&UserCleanUp, arg);
    // push user function into cleanup stack "last in, first out"
TThread::CleanUpPop(1); // pop user function out of stack and
    // execute it, thread resumes after this call
TThread::CleanUpPop(0); // pop user function out of stack
    // _without_ executing it
```

Note: `CleanUpPush` and `CleanUpPop` should be used as corresponding pairs like brackets; unlike `pthread`s cleanup stack (which is *not* implemented here), `TThread` does not force this usage.

### 23.2.4.7 Finishing thread

When a thread returns from a user function the thread is finished. It also can be finished by `TThread::Exit()`. Then, in case of `thread-detached` mode, the thread vanishes completely. By default, on finishing `TThread` executes the most recent cleanup function (`CleanUpPop(1)` is called automatically once).

## 23.3 Advanced TThread: Launching a Method in a Thread

Consider a class `Myclass` with a member function that shall be launched as a thread.

```
void* Myclass::Thread0((void* arg)
```

To start `Thread0` as a `TThread`, class `Myclass` may provide a method:

```
int_t Myclass::Threadstart(){
    if(!mTh){
        mTh= new TThread("memberfunction",
            (void*)(void *)&Thread0, (void*) this);
        mTh->Run();
        return 0;
    }
    return 1;
}
```

Here `mTh` is a `TThread*` pointer which is member of `Myclass` and should be initialized to 0 in the constructor. The `TThread` constructor is called as when we used a plain C function above, except for the following two differences.

First, the member function `Thread0` requires an explicit cast to `(void*)(void *)`. This may cause an annoying but harmless compiler warning:

```
Myclass.cxx:98: warning:
    converting from "void (Myclass::*)(void *)" to "void *" )
```

Strictly speaking, `Thread0` must be a static member function to be called from a thread. Some compilers, for example `gcc` version 2.95.2, may not allow the `(void*) (void*)s` cast and just stop if `Thread0` is not static. On the other hand, if `Thread0` is static, no compiler warnings are generated at all. Because the `'this'` pointer is passed in `'arg'` in the call to `Thread0(void *arg)`, you have access to the instance of the class even if `Thread0` is static. Using the `'this'` pointer, non static members can still be read and written from `Thread0`, as long as you have provided Getter and Setter methods for these members. For example:

```
Bool_t state = arg->GetRunStatus();
arg->SetRunStatus(state);
```

Second, the pointer to the current instance of `Myclass`, i.e. `(void*) this`, has to be passed as first argument of the threaded function `Thread0` (C++ member functions internally expect this pointer as first argument to have access to class members of the same instance). `pthreads` are made for simple C functions and do not know about `Thread0` being a member function of a class. Thus, you have to pass this information by hand, if you want to access all members of the `Myclass` instance from the `Thread0` function.

Note: Method `Thread0` cannot be a virtual member function, since the cast of `Thread0` to `void(*)` in the `TThread` constructor may raise problems with C++ virtual function table. However, `Thread0` may call another virtual member function virtual `void Myclass::Func0()` which then can be overridden in a derived class of `Myclass`. (See example `TMhs3`).

Class `Myclass` may also provide a method to stop the running thread:

```
Int_t Myclass::Threadstop() {
    if (mTh) {
        TThread::Delete(mTh);
        delete mTh;
        mTh=0;
        return 0;
    }
    return 1;
}
```

Example `TMhs3`: Class `TThreadframe` (`TThreadframe.h`, `TThreadframe.cxx`) is a simple example of a framework class managing up to four threaded methods. Class `TMhs3` (`TMhs3.h`, `TMhs3.cxx`) inherits from this base class, showing the `mhs3` example 8.1 (`mhs3.h`, `mhs3.cxx`) within a class. The `Makefile` of this example builds the shared libraries `libTThreadframe.so` and `libTMhs3.so`. These are either loaded or executed by the `ROOT` script `TMhs3demo.C`, or are linked against an executable: `TMhs3run.cxx`.

### 23.3.1 Known Problems

Parts of the `ROOT` framework, like the interpreter, are not yet thread-safe. Therefore, you should use this package with caution. If you restrict your threads to distinct and 'simple' duties, you will be able to benefit from their use. The `TThread` class is available on all platforms, which provide a POSIX compliant thread implementation. On Linux, Xavier Leroy's Linux Threads implementation is widely used, but the `TThread` implementation should be usable on all platforms that provide `pthread`.

**Linux Xlib on SMP machines** is not yet thread-safe. This may cause crashes during threaded graphics operations; this problem is independent of `ROOT`.

**Object instantiation:** there is no implicit locking mechanism for memory allocation and global `ROOT` lists. The user has to explicitly protect his code when using them.

## 23.4 The Signals of ROOT

The list of default signals handled by `ROOT` is:

```

kSigChildkSigPipe
kSigBuskSigAlarm
kSigSegmentationViolationkSigUrgent
kSigIllegalInstructionkSigFloatingException
kSigSystemkSigWindowChanged

```

The signals *kSigFloatingException\**, *kSigSegmentationViolation\**, *kSigIllegalInstruction\**, and *kSigBus\** cause the printing of the **\*\*\* Break \*\*\*** message and make a long jump back to the ROOT prompt. No other custom **TSignalHandler** can be added to these signals.

The *kSigAlarm\** signal handles asynchronous timers. The *kSigWindowChanged\** signal handles the resizing of the terminal window. The other signals have no other behavior then that to call any registered **TSignalHandler::Notify()**.

When building in interactive application the use of the **TRint** object handles the **kSigInterrupt** signal. It causes the printing of the message: **\*\*\* Break \*\*\* keyboard interrupt** and makes a long jump back to the ROOT command prompt. If no **TRint** object is created, there will be no **kSigInterrupt** handling. All signals can be reset to their default UNIX behavior via the call of **TSytem::ResetSignal()**. All signals can be ignored via **TSytem::IgnoreSignal()**. The **TSytem::IgnoreInterrupt()** is a method to toggle the handling of the interrupt signal. Typically it is called to prevent a SIGINT to interrupt some important call (like writing to a ROOT file).

If **TRint** is used and the default ROOT interrupt handler is not desired, you should use **GetSignalHandler()** of **TApplication** to get the interrupt handler and to remove it by **RemoveSignalHandler()** of **TSytem**.

## 23.5 Glossary

The following glossary is adapted from the description of the Rogue Wave **Threads.h++** package.

A **process** is a program that is loaded into memory and prepared for execution. Each process has a private address space. Processes begin with a single thread.

A **thread** is a sequence of instructions being executed in a program. A thread has a program counter and a private stack to keep track of local variables and return addresses. A multithreaded process is associated with one or more threads. Threads execute independently. All threads in a given process share the private address space of that process.

**Concurrency** exists when at least two threads are in progress at the same time. A system with only a single processor can support concurrency by switching execution contexts among multiple threads.

**Parallelism** arises when at least two threads are executing simultaneously. This requires a system with multiple processors. Parallelism implies concurrency, but not vice-versa.

A function is **reentrant** if it will behave correctly even if a thread of execution enters the function while one or more threads are already executing within the function. These could be the same thread, in the case of recursion, or different threads, in the case of concurrency.

**Thread-specific data (TSD)** is also known as thread-local storage (TLS). Normally, any data that has lifetime beyond the local variables on the thread's private stack are shared among all threads within the process. Thread-specific data is a form of static or global data that is maintained on a per-thread basis. That is, each thread gets its own private copy of the data.

Left to their own devices, threads execute independently. **Synchronization** is the work that must be done when there are, in fact, interdependencies that require some form of communication among threads. Synchronization tools include mutexes, semaphores, condition variables, and other variations on locking.

A **critical section** is a section of code that accesses a non-sharable resource. To ensure correct code, only one thread at a time may execute in a critical section. In other words, the section is not reentrant.

A **mutex**, or mutual exclusion lock, is a synchronization object with two states locked and unlocked. A mutex is usually used to ensure that only one thread at a time executes some critical section of code. Before entering a critical section, a thread will attempt to lock the mutex, which guards that section. If the mutex is already locked, the thread will block until the mutex is unlocked, at which time it will lock the mutex, execute the critical section, and unlock the mutex upon leaving the critical section.

A **semaphore** is a synchronization mechanism that starts out initialized to some positive value. A thread may ask to wait on a semaphore in which case the thread blocks until the value of the semaphore is positive. At that time the semaphore



count is decremented and the thread continues. When a thread releases semaphore, the semaphore count is incremented. Counting semaphores are useful for coordinating access to a limited pool of some resource.

**Readers/Writer Lock** - a multiple-reader, single-writer lock is one that allows simultaneous read access by many threads while restricting write access to only one thread at a time. When any thread holds the lock for reading, other threads can also acquire the lock reading. If one thread holds the lock for writing, or is waiting to acquire the lock for writing, other threads must wait to acquire the lock for either reading or writing.

Use a **condition variable** in conjunction with a mutex lock to automatically block threads until a particular condition is true.

**Multithread Safe Levels** - a possible classification scheme to describe thread-safety of libraries:

- All public and protected functions are reentrant. The library provides protection against multiple threads trying to modify static and global data used within a library. The developer must explicitly lock access to objects shared between threads. No other thread can write to a locked object unless it is unlocked. The developer needs to lock local objects. The spirit, if not the letter of this definition, requires the user of the library only to be familiar with the semantic content of the objects in use. Locking access to objects that are being shared due to extra-semantic details of implementation (for example, copy-on-write) should remain the responsibility of the library.
- All public and protected functions are reentrant. The library provides protection against multiple threads trying to modify static and global data used within the library. The preferred way of providing this protection is to use mutex locks. The library also locks an object before writing to it. The developer is not required to explicitly lock or unlock a class object (static, global or local) to perform a single operation on the object. Note that even multithread safe level II hardly relieves the user of the library from the burden of locking.

A thread suffers from **deadlock** if it is blocked waiting for a condition that will never occur. Typically, this occurs when one thread needs to access a resource that is already locked by another thread, and that other thread is trying to access a resource that has already been locked by the first thread. In this situation, neither thread is able to progress; they are deadlocked.

A **multiprocessor** is a hardware system with multiple processors or multiple, simultaneous execution units.

- Examples can be found at <http://www-linux.gsi.de/~go4/HOWTOthreads/howtothreadsbody.html> (the thread authors' web site - Jörn Adamczewski and Marc Hemberger).



## Chapter 24

# PROOF: Parallel Processing

The Parallel ROOT Facility, PROOF, is an extension of ROOT allowing transparent analysis of large sets of ROOT files in parallel on remote computer clusters or multi-core computers. The main design goals for the PROOF system are:

*Transparency* : there should be as little difference as possible between a local ROOT based analysis session and a remote parallel PROOF session, both being interactive and giving the same results.

*Scalability* : the basic architecture should not put any implicit limitations on the number of computers that can be used in parallel.

*Adaptability* : the system should be able to adapt itself to variations in the remote environment (changing load on the cluster nodes, network interruptions, etc.).

Being an extension of the ROOT system, PROOF is designed to work on objects in ROOT data stores, though, for the time being, it mainly addresses the case of **TTree** based object collections.

PROOF is primarily meant as an interactive alternative to batch systems for Central Analysis Facilities and departmental workgroups (Tier-2's). However, thanks to a multi-tier architecture allowing multiple levels of masters, it can be easily adapted to wide range virtual clusters distributed over geographically separated domains and heterogeneous machines (GRIDs).

While pure interactivity might not always be possible when performing a complicated analysis on a very large data set, PROOF still tries to give the user the interactive experience with something we call “interactive batch”. With “interactive batch” the user can start very long running queries, disconnect the client and at any time, any location and from any computer reconnect to the query to monitor its progress or retrieve the results. This feature gives it a distinct advantage over purely batch based solutions, that only provide an answer once all sub-jobs have been finished.

Details about the PROOF system and the way to use it can be found at <sup>1</sup>

The PROOF development is a joint effort between CERN and MIT.

---

<sup>1</sup><http://root.cern.ch/twiki/bin/view/ROOT/PROOF>

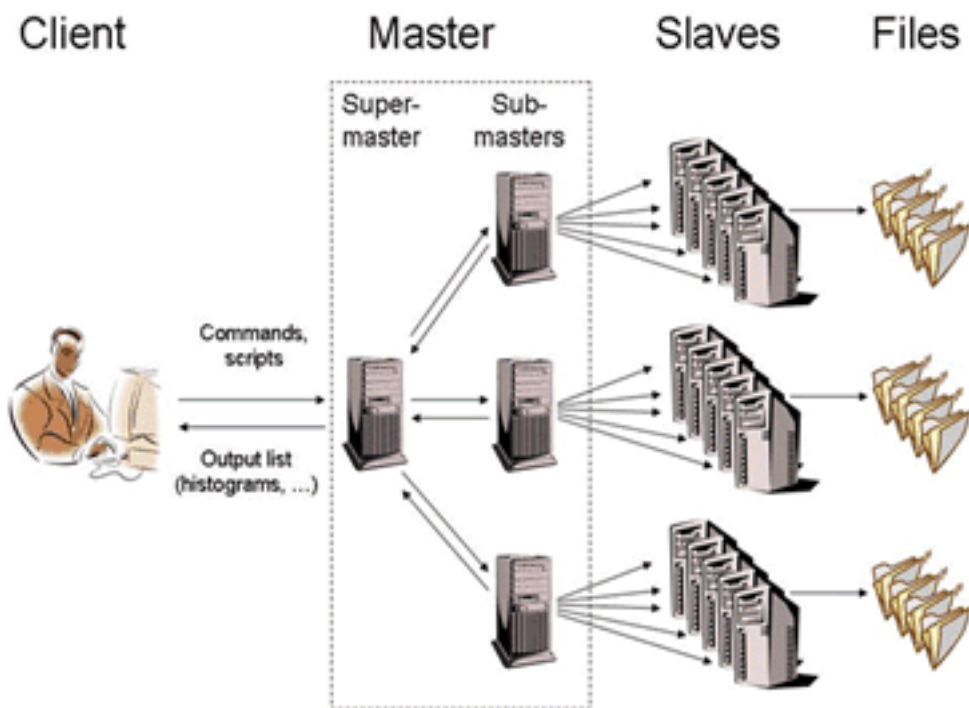

Figure 24.1: The Multi-tier structure of a PROOF cluster

# Chapter 25

## Writing a Graphical User Interface

The ROOT GUI classes support an extensive and rich set of widgets with the Windows 95 look and feel. The widget classes interface to the underlying graphics system via a single abstract class. Concrete versions of this abstract class have been implemented for X11 and Win32, thereby making the ROOT GUI fully cross-platform. Originally the GUI classes were based on Hector Peraza's Xclass'95 widget library <http://xclass.sourceforge.net/>

### 25.1 The ROOT GUI Classes

Features of the GUI classes in a nutshell:

- Originally based on the Xclass'95 widget library
- A rich and complete set of widgets
- Win'95 look and feel
- All machine dependent graphics calls abstracted via the **TVirtualX** "abstract" class
- Completely scriptable via the C++ interpreter (fast prototyping)
- Supports signal/slot event handling as pioneered by Trolltech's Qt
- Full class documentation is generated automatically (as for all ROOT classes)
- Code generation for variety of GUI's

### 25.2 Widgets and Frames

The ROOT GUI classes provide of set of components that allow an easy way to develop cross-platform GUI applications with a Windows look and feel.

The main widgets are:

- Simple widgets: labels, icons, push buttons, either with text or pixmaps, check buttons, radio buttons, menu bars and popup menus, scroll bars, list boxes, combo boxes, group frames, text entry widgets, tab widgets, progress bars, sliders, tool tips
- Complex widgets: shutter, toolbar, status bar, list view, list tree
- Common dialogs: File Open/Save, File Properties, Font Selection, Color Selection, About
- The widgets are shown in frames:
- frame, composite frame, main frame, transient frame, group frame

- Arranged by layout managers:
- horizontal layout, vertical layout, row layout, list layout, tile layout, matrix layout

Using a combination of layout hints:

- left, right, center x, center y, top, bottom, expand x, expand y, fixed offsets

Event handling by signals/slots and messaging (as opposed to callbacks):

- in response to actions widgets send messages and emit signals
- associated frames process these messages or the slot methods connected to the signals are executed

## 25.3 TVirtualX

The GUI classes interface to the platform dependent low level graphics system via the semi-abstract graphics base class **TVirtualX**. Currently concrete implementations exist for X11 and Win32 (MacOS X is fully supported via Apple's X11 implementation). Thanks to this single graphics interface, porting the ROOT GUI to a new platform requires only the implementation of **TVirtualX**.

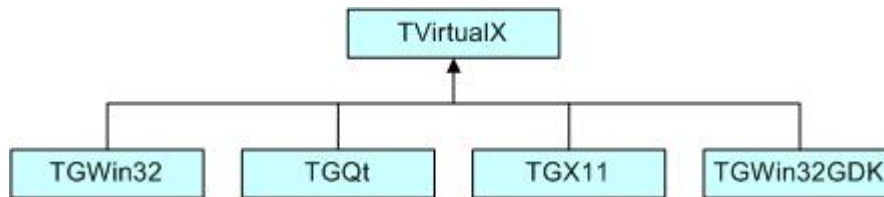

The **TGQt** interface is currently still under development.

## 25.4 A Simple Example

We will start with a simple example that builds a small application containing a canvas and two buttons: Draw and Exit. Its functionality will be very simple: every time you click on Draw button, the graphics of the function  $\sin(x)/x$  will be drawn in randomly chosen interval in the canvas window, if you click on Exit - you close the application. This example shows the basic concepts for almost any GUI-application in ROOT and it is important to understand how it is constructed. The example program is written as a named script. See “CINT the C++ Interpreter”. Remember that the named script can be executed via

```
root[] .x example.C
```

only if the filename (without extension) and the function entry point are both the same.

We need to say a few words about the parent-children relationship between the widgets before going through the real code. The widgets' behaviors are based on this relationship. Every parent widget is responsible for where the children are and it ensures all properties and behavior for them. For example, if you want to hide several widgets, it will be enough to hide their parent widget. Later you can show the parent and the children will appear too. Writing your code you have to specify the parent-child relationship. Usually in a child constructor the address of the parent is passed as an argument. In general frames are parents of simple widgets. In this example you will see how we organize the parent-children relationship by using frame widgets in addition to the canvas window and button widgets.

Let's now go through the code of the `example.C`.

The first lines include ROOT header files. The header file names are almost always as the class names (**TApplication**, **TF1**, **TCanvas**), but there are cases when similar classes are grouped together in one header file: all frames are declared in `TGFrame.h`, all buttons - in `TGButton.h`, etc. Our small example is based on an object of the class `MyMainFrame`.

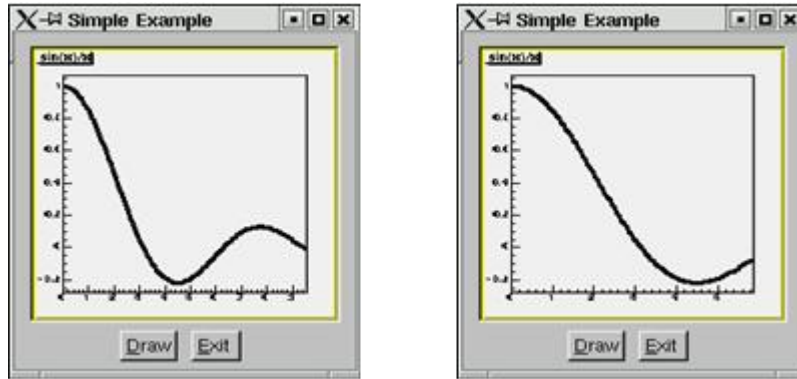

```
new MyMainFrame(gClient->GetRoot(),200,200);
```

The first parameter `gClient->GetRoot()` makes the initial connection to the window server. It is a pointer to the root window of the screen, which is obtained from `gClient`. The next two parameters initialize the width and height of the application window in pixels. Let see what `MyMainFrame` is. The three arguments pass to the `TGMainFrame` constructor when we create the `fMain` object.

The first thing to note is the inclusion of the `RQ_OBJECT` macro in the class declaration of `MyMainFrame`. It is necessary to provide a standalone class signal/slot capability. The signal/slot communication mechanism is described in a separate chapter. See “Event Processing: Signals and Slots”.

```
// example.C
```

```
#include <TGClient.h>
#include <TCanvas.h>
#include <TF1.h>
#include <TRandom.h>
#include <TGButton.h>
#include <TGFrame.h>
#include <TRootEmbeddedCanvas.h>
#include <RQ_OBJECT.h>

class MyMainFrame {
    RQ_OBJECT("MyMainFrame")
private:
    TGMainFrame      *fMain;
    TRootEmbeddedCanvas *fEcanvas;
public:
    MyMainFrame(const TGWindow *p,UInt_t w,UInt_t h);
    virtual ~MyMainFrame();
    void DoDraw();
};

MyMainFrame::MyMainFrame(const TGWindow *p,UInt_t w,UInt_t h) {
    // Create a main frame
    fMain = new TGMainFrame(p,w,h);

    // Create canvas widget
    fEcanvas = new TRootEmbeddedCanvas("Ecanvas",fMain,200,200);
    fMain->AddFrame(fEcanvas, new TGLayoutHints(kLHintsExpandX |
        kLHintsExpandY, 10,10,10,1));

    // Create a horizontal frame widget with buttons
    TGHorizontalFrame *hframe = new TGHorizontalFrame(fMain,200,40);
    TGTextButton *draw = new TGTextButton(hframe,"&Draw");
    draw->Connect("Clicked()", "MyMainFrame", this, "DoDraw()");
    hframe->AddFrame(draw, new TGLayoutHints(kLHintsCenterX,
        5,5,3,4));
```

```

TGTextButton *exit = new TGTextButton(hframe,"&Exit",
                                     "gApplication->Terminate(0)");
hframe->AddFrame(exit, new TGLayoutHints(kLHintsCenterX,
                                       5,5,3,4));
fMain->AddFrame(hframe, new TGLayoutHints(kLHintsCenterX,
                                       2,2,2,2));

/ Set a name to the main frame
fMain->SetWindowName("Simple Example");

// Map all subwindows of main frame
fMain->MapSubwindows();

// Initialize the layout algorithm
fMain->Resize(fMain->GetDefaultSize());

// Map main frame
fMain->MapWindow();
}
void MyMainFrame::DoDraw() {
    // Draws function graphics in randomly chosen interval
    TF1 *f1 = new TF1("f1","sin(x)/x",0,gRandom->Rndm()*10);
    f1->SetLineWidth(3);
    f1->Draw();
    TCanvas *fCanvas = fEcanvas->GetCanvas();
    fCanvas->cd();
    fCanvas->Update();
}
MyMainFrame::~MyMainFrame() {
    // Clean up used widgets: frames, buttons, layout hints
    fMain->Cleanup();
    delete fMain;
}
void example() {
    // Popup the GUI...
    new MyMainFrame(gClient->GetRoot(),200,200);
}

```

The `TGMainFrame` class defines a top level window that interacts with the system window manager. Its method `CloseWindow()` is invoked when `Alt+F4` are pressed or a window manager close/exit command is used. To terminate the application when this happens you need to override the `CloseWindow()` method and call `gApplication->Terminate(0)`.

The main frame can be considered as a container where all widgets of the application are organized with respect to their parent-child relationship. After the main frame we create `fEcanvas` - an object of class `TRootEmbeddedCanvas`. It is a quite complex widget and we will explain it in detail later. For the moment keep in mind only its main purpose - to create a `TCanvas` - the ROOT basic whiteboard for drawing and editing different graphical objects.

```
fEcanvas = new TRootEmbeddedCanvas("Ecanvas",fMain,200,200);
```

In the `TRootEmbeddedCanvas` constructor we pass the address of the main frame widget `fMain` as a second parameter. This pass is important because it makes `fMain` the parent of the canvas window. The first parameter `Ecanvas` is the name of the `TCanvas`, the last two parameters give the width and height of canvas window in pixels. Next step is to add `fEcanvas` to the parent frame defining its appearance inside the parent window. We use the method `AddFrame()`:

```
fMain->AddFrame(fEcanvas,new TGLayoutHints(kLHintsExpandX |
                                       kLHintsExpandY, 10, 10, 10, 1));
```

It adds the `fEcanvas` into the list of children widgets of the main frame `fMain`. The specification of how it should be placed inside the parent frame is made by the `TGLayoutHints` object. Setting its first parameter to



`kLHintsExpandX|kLHintsExpandY` we define the canvas window as expanded on x and y in the frame. The next four parameters define amounts of padding in left, right, top and bottom in pixels. This means that the canvas window will be expanded when the parent window expands, but it will keep around a frame of 10 pixels on left, right, top and 1 pixel on bottom.

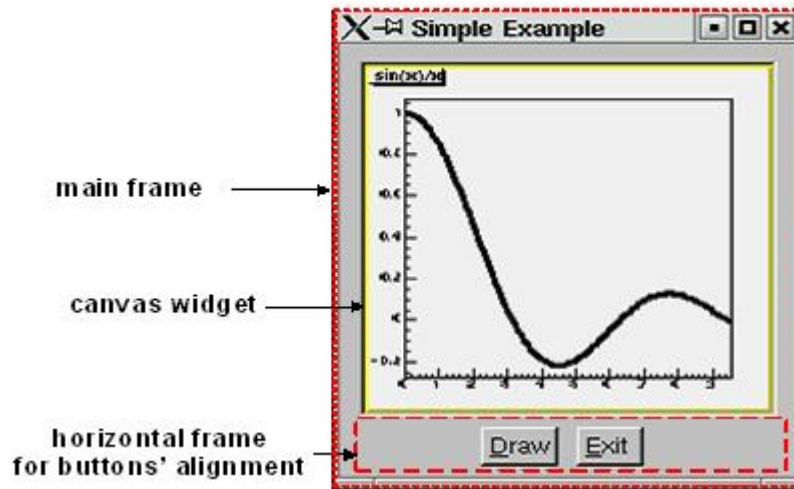

The laying out is always made with respect to the parent-children relationship. There is a special chapter presenting the different layout managers, but we will quickly introduce the concept here. The layout process will apply not to the embedded canvas window but to its parent - the main frame. A popular layout manager and the one used in this case is the vertical layout manager which arranges its widgets vertically in a column.

The next widget we create as a child of the main frame is the horizontal frame `hframe`:

```
TGHorizontalFrame *hframe=new TGHorizontalFrame(fMain,200,40);
```

The first parameter of its constructor is again the address of its parent, `fMain`. The next ones define the frame width and height in pixels. The name of the class `TGHorizontalFrame` gives a hint that a horizontal layout will apply on its children widgets. The Draw and Exit buttons will be laid out horizontally. Here are their constructors:

```
TGTextButton *draw = new TGTextButton(hframe,"&Draw");
hframe ->AddFrame(draw, new TGLayoutHints(kLHintsCenterX,5,5,3,4));
TGTextButton *exit = new TGTextButton(hframe,"&Exit",
                                     "gApplication->Terminate(0)");
hframe ->AddFrame(exit,new TGLayoutHints(kLHintsCenterX,5,5,3,4));
```

They are created as objects of the `TGTextButton` class that represent the command buttons with a text label. When you click on a command button it performs the action shown on its label. These buttons are well known as “push buttons” or just “buttons”. The parent address `hframe` is passed as first parameter. The second one defines the button label and normally indicates the action to be taken when the button is clicked. It is possible to define a hot key for the button at that point using the hot string for its label. A hot string is a string with a “hot” character underlined. This character we call the button hot key. It shows the assigned keyboard mnemonic for the button choice. Following our example, this means that you can use `Alt+D` to click on Draw button and `Alt+E` to click on Exit. There is a possibility to specify a command string as third parameter of the button constructor. We use it to assign the command `gApplication->Terminate(0)`. The application will be terminated when you click on the Exit button.

We call again `AddFrame()` to add the buttons to their parent widget giving layout hints for each of them. This time we would like to have centered buttons with an amount of 5 pixels on the left, 5 on the right, 3 on the top and 4 on the bottom. You can feel already that the same steps are repeated three times: to create a new widget with passing a parent address as a parameter, to define layout hints for it and to add it in the parent list. The next line is something new:

```
draw->Connect("Clicked()", "MyMainFrame", this, "DoDraw()");
```

Here we connect a signal to a slot. Whenever the draw button is clicked, it emits a signal that something has happened (it is clicked) to whom might be interesting in the outside world. The widget does not know who will use this information. On the other side of the program world there is some code which should be executed when the button is clicked. This code is called a slot. Think about slots as normal C++ functions or class methods. The line above specifies that the slot `MyMainFrame::DoDraw()` will be executed when the draw button is clicked. Our slot draws the graphics of  $\sin(x)/x$  in randomly chosen interval every time the draw button sends a signal "I am clicked". The signal/slot communication mechanism originally featured in Qt by TrollTech (see <http://doc.trolltech.com/3.1/signalsandslots.html>). ROOT supports its own version of signals/slots. We will return to that point in details later. We specified all child widgets of the horizontal frame (the Draw and Exit buttons in our case). Next, we need to add their parent frame to the main frame:

```
fMain->AddFrame(hframe,new TGLayoutHints(kLHintsCenterX,2,2,2,2));
```

The last thing to do is to set the main window title and to make all widgets visible. Commonly in all systems windows are assigned by name to be identified by users. This name is displayed in the application's title bar and can be set by:

```
fMain->SetWindowName("Simple Example");
```

The next lines make the widgets visible. The first one maps all child frames of the top-level frame; the last one - the main frame itself, i.e. makes it appear on the screen.

```
fMain->MapSubwindows();
fMain->Resize(fMain->GetDefaultSize());
fMain->MapWindow();
```

The line in between has an important mission - to execute all layout specifications for the widgets before the top-level window itself is shown on the screen. We can run the named script via the CINT interpreter with the command:

```
root[] .x example.C
```

The event processing starts. If you change the state of a widget, it emits a signal and the corresponding slot is executed ensuring the functionality we want for this small example.

The steps we passed can be generalized as follows:

- Opening of the connection to the system
- Definition of main frame (top level window)
- Creation of widgets as children of the top-level frame; assign them desired properties following the steps:
- Create a new widget passing its parent in the constructor
- Connect widget's signals with desired slots to ensure desired functionality
- Define widget's layout and add it to the parent list of children
- Set main window attributes
- Map all sub windows
- Initialize the layout algorithm via `Resize(GetDefaultSize())` method
- Map the main frame
- Execution of the even-processing loop

### 25.4.1 A Standalone Version

As usual a standalone program in C++ has to contain a `main()` function - the starting point for the application execution. In this case it is better to separate the program code creating a program header file `example2a.h` with the `MyMainFrame` class declaration and `example2a.cxx` with the class methods implementation. To run our simple example as a standalone application we need to create in addition an object of class `TApplication`. It will make a correct initialization of the dictionaries if it is not yet done. It will be responsible for holding everything together and to handle all events in the application. Its environment provides an interface to the ROOT graphics system and by calling the `Run()` method the event loop starts and the application program is waiting for the user action. The application exits only if the top level window is not closed. Two header files are used in addition: `TApplication.h` - for the class `TApplication` and `TGClient.h` that is used to make initial connection to the graphics system. The class `TApplication` must be instantiated only once in any given application. The original list of argument options can be retrieved via the `Argc()` and `Argv()` methods.

Note: to have signals/slots working we need to create a dictionary for the class `MyMainFrame`, i.e. we create the file `ex2aLinkDef.h` containing the line:

```
#pragma link C++ class MyMainFrame;
```

We compile the example:

```
rootcint -f ex2aDict.cxx -c example2a.h ex2aLinkDef.h
g++ -o example2a example2a.cxx ex2aDict.cxx `root-config --cflags --glibs`
```

`example2a.h`

```
#include <TQObject.h>
#include <RQ_OBJECT.h>

class TGWindow;
class TGMainFrame;
class TRootEmbeddedCanvas;

class MyMainFrame {
    RQ_OBJECT("MyMainFrame")
private:
    TGMainFrame          *fMain;
    TRootEmbeddedCanvas *fEcanvas;
public:
    MyMainFrame(const TGWindow *p,UInt_t w,UInt_t h);
    virtual ~MyMainFrame();
    void DoDraw();
};
```

`example2a.cxx`

```
#include <TApplication.h>
#include <TGClient.h>
#include <TCanvas.h>
#include <TF1.h>
#include <TRandom.h>
#include <TGButton.h>
#include <TRootEmbeddedCanvas.h>
#include "example2a.h"

MyMainFrame::MyMainFrame(const TGWindow *p,UInt_t w,UInt_t h) {...}
MyMainFrame::~MyMainFrame() { ... }
void MyMainFrame::DoDraw() { ... }
void example() { ... }
```

```

int main(int argc, char **argv) {
    TApplication theApp("App",&argc,argv);
    example();
    theApp.Run();
    return 0;
}

```

The class `MyMainFrame` could derive from `TGMainFrame`. In that case the `RQ_OBJECT` macro is not needed anymore, since the functionality it provides is obtained now via inheritance from `TGMainFrame`. This will reflect in the `MyMainFrame` class declaration and in the code of the `MyMainFrame::MyMainFrame` constructor as follows:

example2b.h

```

#include <TGFrame.h>
class MyMainFrame : public TGMainFrame {
private:
    TRootEmbeddedCanvas *fEcanvas;
public:
    MyMainFrame(const TGWindow *p,UInt_t w,UInt_t h);
    virtual ~MyMainFrame() { ... }
    void DoDraw(){ ... }
    ClassDef(MyMainFrame,0)
};

```

example2b.cxx

```

#include <TApplication.h>
#include <TGClient.h>
#include <TCanvas.h>
#include <TF1.h>
#include <TRandom.h>
#include <TGButton.h>
#include <TRootEmbeddedCanvas.h>
#include "example2b.h"

MyMainFrame::MyMainFrame(const TGWindow *p,UInt_t w,UInt_t h)
    : TGMainFrame(p,w,h) {

    // Creates widgets of the example
    fEcanvas = new TRootEmbeddedCanvas ("Ecanvas",this,200,200);
    AddFrame(fEcanvas, new TLayoutHints(kLHintsExpandX |
                                      kLHintsExpandY, 10,10,10,1));
    TGHORIZONTALFRAME *hframe=new TGHORIZONTALFRAME(this, 200,40);
    TGTextButton *draw = new TGTextButton(hframe,"&Draw");
    draw->Connect("Clicked()", "MyMainFrame", this, "DoDraw()");
    hframe->AddFrame(draw, new TLayoutHints(kLHintsCenterX,
                                          5,5,3,4));
    TGTextButton *exit = new TGTextButton(hframe,"&Exit ",
                                          "gApplication->Terminate()");
    hframe->AddFrame(exit, new TLayoutHints(kLHintsCenterX,
                                          5,5,3,4));
    AddFrame(hframe,new TLayoutHints(kLHintsCenterX,2,2,2,2));

    // Sets window name and shows the main frame
    SetWindowName("Simple Example");
    MapSubwindows();
    Resize(GetDefaultSize());
    MapWindow();
}

```

## 25.5 Widgets Overview

The word widget is a contraction of windows and gadget. Almost all GUI elements are widgets. A button is a widget, a menu item is a widget, a scrollbar is a widget, and a complete dialog box is a widget too. Some widgets may have sub widgets. For example, a dialog box can contain buttons, text fields, a combo-box, etc.

On the screen widgets look like rectangular areas with special behaviors. In terms of the object-oriented programming we can define a widget in ROOT as an object of a class deriving from **TGObject**.

This section presents all currently supported widgets in ROOT and their most useful methods. All of them can be considered as building blocks for an application, and most of them can be found in dialogs. Provided snippets of the code will give you practical guidelines where and how to use certain widgets. The macro `$ROOTSYS/tutorials/gui/guitest.C` contains the complete source code.

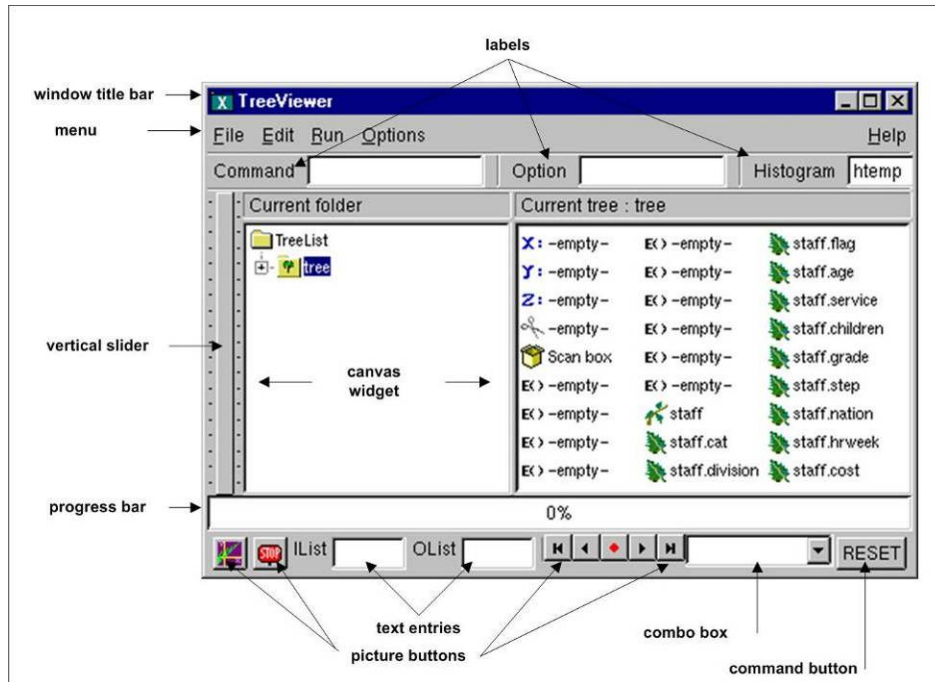

Figure 25.1: Widgets created by ROOT GUI classes

Any custom widget can be created by sub classing existing widgets. To achieve a better understanding of the widgets' properties they are separated by their type and their inheritance. As all of them inherit from **TGObject** and most from **TGWidget**, these base classes are described first.

### 25.5.1 TGObject

**TGObject** is the base class for all ROOT GUI classes. It inherits from **TObject**. The two data members of this class contain important information about X11/Win32 window identifier and the connection to the host's graphics system. Every GUI element, which derives from **TGObject** has access to the **TGClient** via the data member `fClient` of **TGObject**. **TGClient** creates the connection with the host's graphics system and sets up the complete graphics system for all widgets.

### 25.5.2 TGWidget

The widgets base class **TGWidget** is typically used as a mix-in class via multiple inheritances. Its properties are available for all deriving widgets: **TGButton**, **TGComboBox**, **TGTab**, **TGColorPalette**, **TGColorPick**, **TGDoubleSlider**, **TGListTree**, **TGNumberEntry**, **TGScrollBar**, **TGShutterItem**, **TGTextEntry**, **TGSlider**, **TGListBox**, **TGView**.

This class has four data members keeping information about the widget id - important for event processing, the window which handles the widget's events, the widget status flags and the assigned command (if there is any). The general properties of **TGWidget** are specified by `SetFlags(Int_t flags)` and `ClearFlags(Int_t flags)` methods. The status

flags are: `kWidgetWantFocus`, `kWidgetHasFocus`, and `kWidgetIsEnabled`. The method `Associate(const TGWindow* w)` - sets the window which handles the widget events. `SetCommand(const char* command)` - sets the command to be executed. The command string can be gathering via `GetCommand()` method. For example, the third parameter in `TGTextButton` constructor can be omitted and set later in your program, i.e. instead of:

```
TGTextButton *exit = new TGTextButton(hframe, "&Exit",
                                     "gApplication->Terminate());
```

You will have the following the two lines:

```
TGTextButton *exit = new TGTextButton(hframe, "&Exit");
exit->SetCommand("gApplication->Terminate());
```

The method `IsEnabled()` - returns `kTRUE` if the widget has flag `kWidgetIsEnabled` and it accepts user events. This method is very important for creating a good user interface because it allows you to disable or enable a widget depending on the situation of your application. As a standard all disabled widgets are displayed “grayed out”. `HasFocus()` - returns `kTRUE` if the widget has the input focus (i.e. flag `kWidgetHasFocus` is set). Remember that only one item in a complex widget as a dialog can have the value of `HasFocus()` sets as true. `WantFocus()` - returns `kTRUE` if the flag `kWidgetWantFocus` is set.

### 25.5.3 TGWindow

`TGWindow` is a ROOT GUI window base class. It inherits from `TGObject` and `TGFrame` derives from it. The application does not use it directly. It creates and registers a new window within the system. This window has common characteristics: existing parent, location, size in height and width (it has a default minimum size 1, 1 under which it cannot shrink), border with particular view, state, specific attributes. If there are no specified arguments their values will be taken from the parent. It receives events from the window system and can paint a representation of itself on the screen.

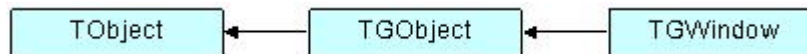

### 25.5.4 Frames

Most of the frame classes are mainly created for arranging widgets in a window. The class `TGFrame` is a subclass of `TGWindow` providing additional window characteristics and overriding some methods of `TGWindow`. It is a base class for the simple widgets as buttons, labels, etc. Its only purpose is to draw a frame around widgets that do not have a frame of their own. The main groups of `TGFrame` member functions are:

- Window’s functions: `DoRedraw()`, `DeleteWindow()`, `Activate()`, etc.
- Geometry functions: `Move()`, `Resize()`, `SetSize()`, etc.
- Graphics handlers: `ChangeBackground()`, `ChangeOptions()`, etc.
- Mouse and keyboard functions: `HandleButton()`, `HandleFocusChange()`, `HandleKey()`, `HandleMotion()`, etc.
- Event handlers: `HandleEvent()`, `ProcessEvent()`, `GetSender()`, `SendMessage()`, `ProcessMessage()`, `GetLastClick()`, etc.

Ones of `TGFrame` member functions provide direct functionality; others - will be overridden by `TGFrame` subclasses to ensure particular widget’s functionality. There are two constructors provided in `TGFrame` class. One creates a frame using an externally created window:

```
TGFrame(TGClient *c, Window_t id, const TGWindow *parent = 0);
```

For example, it can register the root window (called by `TGClient`), or a window created via `TVirtualX::InitWindow()` (window id is obtained by `TVirtualX::GetWindowID()` method). The other `TGFrame` constructor is:

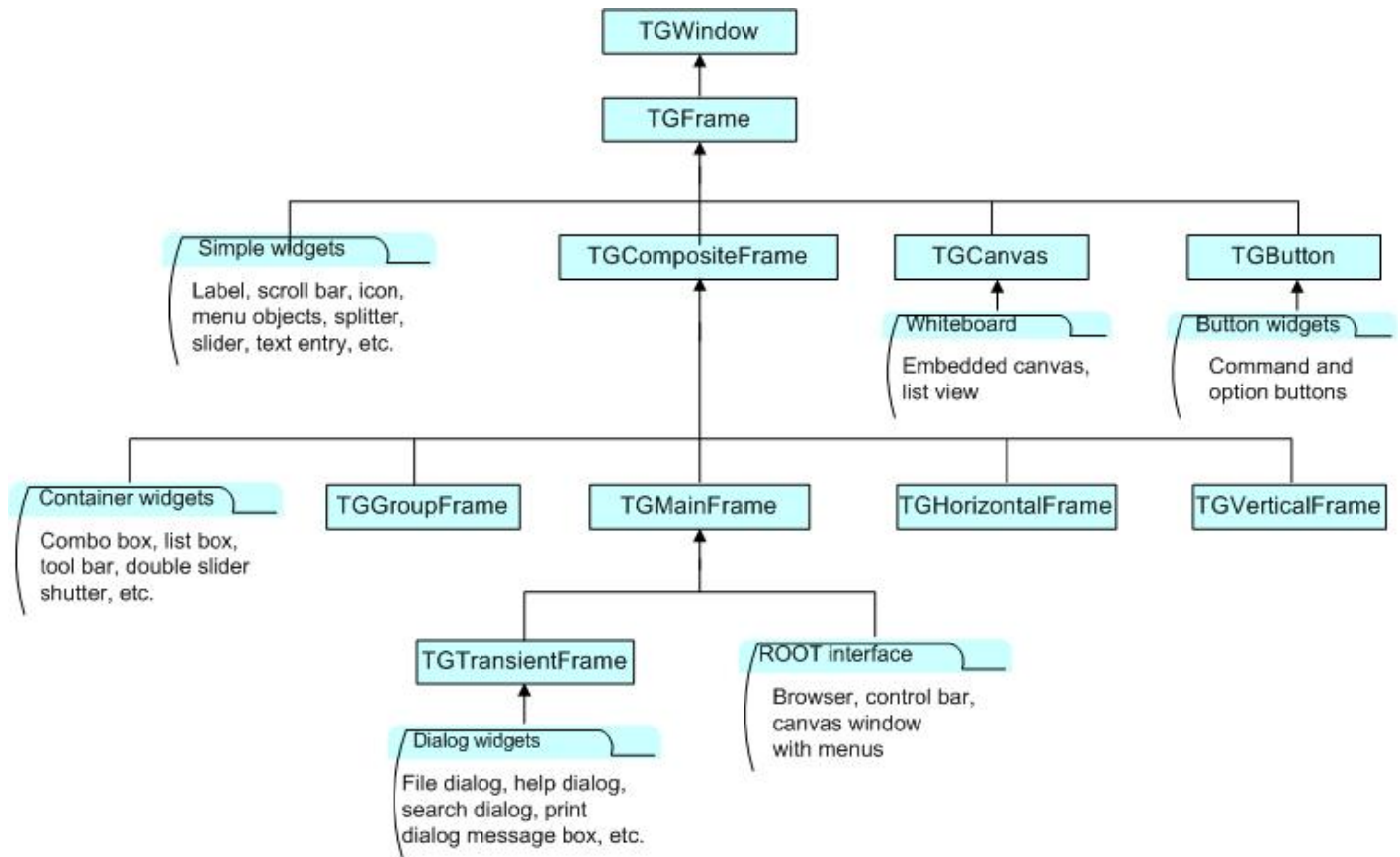

Figure 25.2: The GUI classes hierarchy

```

TGFrame(const TGWindow *p, UInt_t w, UInt_t h, UInt_t options=0,
        ULong_t back = GetDefaultBackground());

```

The options parameter is the bitwise OR between defined frame types. Here is a short description of these types:



---

Frame Type	Description
<code>kChildFrame</code>	a frame embedded in a parent
<code>kMainFrame</code>	a main frame interacting with the system Window Manager
<code>kTransientFrame</code>	a top level dialog's frame
<code>kVerticalFrame</code>	a frame that layouts its children in a column
<code>kHorizontalFrame</code>	a frame that layouts its children in a row
<code>kSunkenFrame</code>	a frame with a sunken board appearance
<code>kRaisedFrame</code>	a frame with a raised board appearance
<code>kFitWidth</code>	a frame with dynamically scaled width
<code>kFitHeight</code>	a frame with dynamically scaled height
<code>kFixedWidth</code>	a frame with fixed width
<code>kFixedHeight</code>	a frame with fixed height
<code>kFixedSize</code>	= <code>kFixedWidth   kFixedHeight</code> a frame with fixed width and height
<code>kDoubleBorder</code>	a frame having a double line border
<code>kOwnBackground</code>	a frame having own background
<code>kTempFrame</code>	a temporary frame shown in certain circumstances; for example, it is used for creation of tool tip widget

---

The method `ChangeOption(UInt_t options)` allows you to change frame options. Next example shows you how to change `kVerticalFrame` option to `kHorizontalFrame`:

```
frame->ChangeOptions((frame->GetOptions() & ~kVerticalFrame) |
                    kHorizontalFrame);
```

The class `TGCompositeFrame` is the base class of all composite widgets as a menu bar, a list box, a combo box, etc. It subclasses `TGFrame` and has in addition a layout manager and a list of child frames/widgets. There are two steps to do the design using a composite frame widget. First you put all widgets you need within this frame and assign them desired properties using `AddFrame()`, then you lay them out by the `Layout()` method according to the assigned layout manager. The method `AddFrame()` creates an instance of `TGFrameElement` class for every child widget of a composite frame. This class has three public data members: the child pointer, its layout hints, and a status variable showing if the child is visible or hidden. If no hints are specified, the default layout hints are used. Because the layout is very important part of any design we include a special section about layout management and layout hints.

You can set a layout manager for the composite frame via:

```
compFrame->SetLayoutManager(TGLayoutManager *l);
```

The child widgets cannot be added to different composite frames.

Any child frame can be removed from the parent list by:

```
compFrame->RemoveFrame(TGFrame *f);
```

You can hide or show a child frame of a composite frame using the methods: `HideFrame(TGFrame *f)` or `ShowFrame(TGFrame *f)`. You should call, for example `HideFrame(TGFrame *f)`, only after the frames have been laid out and the sub windows of the composite frame have been mapped via method `MapSubwindows()`, i.e.



```

frame->AddFrame(hFrame1,fLayout1);
frame->AddFrame(hFrame2,fLayout2);
frame->Resize(frame->GetDefaultSize()); // lays out frames
frame->MapSubwindows();                // maps subwindows
frame->HideFrame(hFrame2);             // hides frame hFrame2
frame->MapWindow();                    // maps main frame

```

The state information about a child frame can be obtained from the methods `GetState(TGFrame *f)`, `IsArranged(TGFrame *f)`, and `IsVisible(TGFrame *f)`.

The method `Cleanup()` deletes all objects of the composite frame added via `AddFrame()`. All `TGFrameElement` objects (frames and layout hints) must be unique, i.e. cannot be shared.

We already mentioned that `TGMainFrame` class defines top level windows interacting with the system window manager. It handles applications with a menu bar, toolbar, text entry fields and other widgets surrounding a central area (e.g. a canvas widget). It lays out a set of related widgets and provides the typical application main window behavior. As you can see from the Figure above, it inherits from `TGCompositeFrame` and is inherited by `TGTransientFrame` and several `ROOT` interface classes: `TViewerX3D`, `TRootBrowser`, `TRootCanvas`, `TRootControlBar`, `TTreeView`.

To fix the size of a top level window you have to use the method `TGMainFrame::SetWMSize()`. This call tells the Window Manager that it should not resize the window. The option `kFixedSize` works only for embedded frames like `TGCompositeFrame` and derived classes (in combination with layout hints).

The `TGVerticalFrame` and `TGHorizontalFrame` are composite frames that lay out their child frames in vertical or horizontal way in the same order as they were added and according to their hints preferences.

The `TGTransientFrame` class defines transient windows that typically are used for dialogs. They extend and complete an interaction within a limited context. Always transient frames are displayed from another window or another dialog. They may appear because of a command button being activated or a menu item being selected. They may also present automatically when an additional input and the user attention are required by a certain condition.

The `TGGroupFrame` class presents a very convenient frame which surrounds visually a group of logically connected widgets: radio buttons, related check boxes, two or more functionally related controls.

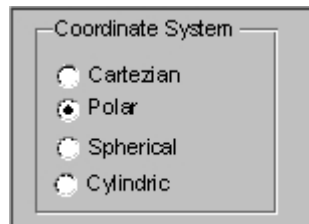

It is a composite frame with a border and a title. The title explains the purpose of the group and should be a noun or noun phrase. Here is an example taken from `guitest.C`:

```

groupFrame = new TGGroupFrame(tf,"Options",kVerticalFrame);
groupFrame->SetTitlePos(TGGroupFrame::kLeft);

```

The second line sets the title position on the left. You can change it to be centered or right aligned if you use `TGGroupFrame::kCenter` or `TGGroupFrame::kRight` as a parameter.

Be conservative in the use of borders because of the potential for clutter. Do not place them around single entry fields, single combo boxes, list boxes and groups of command buttons. The design of these widgets provides them with a border. The picture above provides kind of borders to avoid.

## 25.6 Layout Management

The layout process is an integral part of any GUI. When you create a simple message window, laying out its few buttons and text widgets is quite simple. However, this process becomes increasingly difficult if you have to implement large GUI's

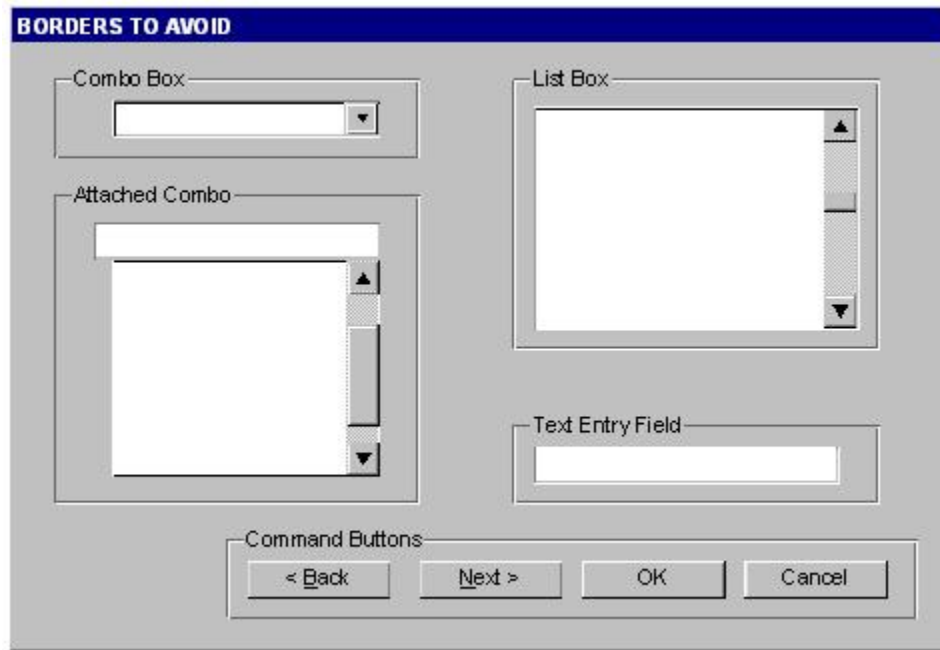

with many widgets that should behave properly when the GUI is resized or uses a different font type or size. Layout management is the process of determining the size and position of every widget in a container.

A layout manager is an object that performs layout management for the widgets within a container. You already know that when adding a component (child widget) to a container (parent widget) you can provide alignment hints (or rely on the default ones). These hints are used by the layout manager to correctly position the widgets in the container. The **TGLayoutManager** is an abstract class providing the basic layout functionality.

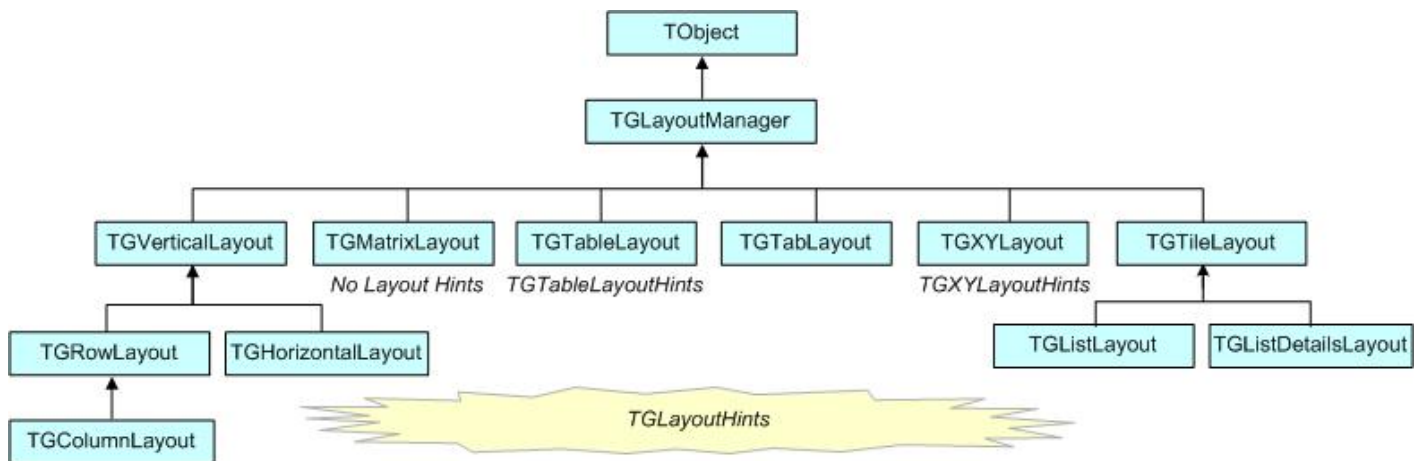
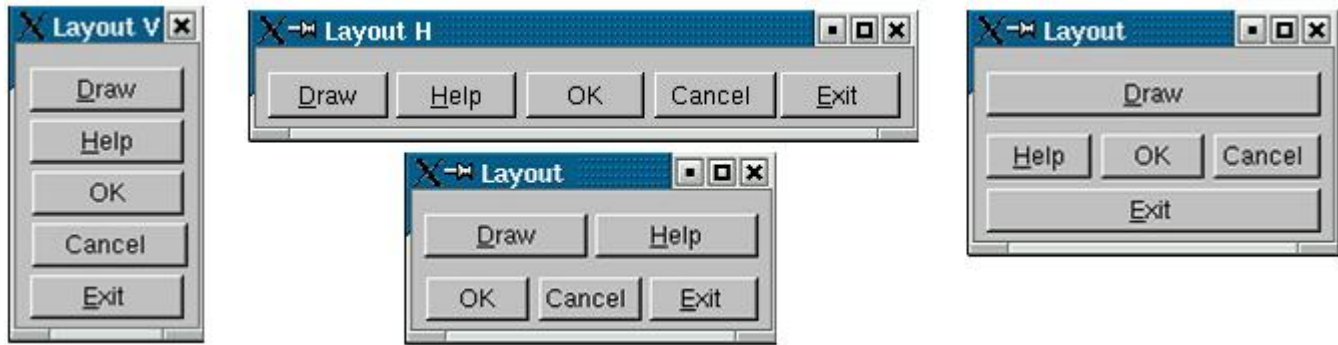

Figure 25.3: The layout classes hierarchy

The base “container” class is **TGCompositeFrame**. You can easily change the layout manager using the **SetLayoutManager(TGLayoutManager \*l)** method. Setting the proper layout manager for each container is the first step you have to do. The container uses that layout manager to position and size the components before they are painted. ROOT currently provides the layout managers shown on the picture above.

The next important step is to provide hints about every widget in the container, i.e. to provide positions and right amount of space between the components. The **TGLayoutHints** objects set hints by specifying the white space in pixels around every widget.

Let’s see an example with five buttons. First you put them in a container, assign them desired properties, and then you lay them out according to the layout manager. This process can be repeated: you go back and add, remove or change some of the widgets and lay them out again.



Once created, you can consider these widgets as elementary objects even though they are compound ones. The pictures above present four different layouts of five buttons. The first one shows laid out vertically buttons. Almost everywhere you can find this vertical orientation. Looking at dialogs you see that often they consist of number of rows laid out below each other. Some of the rows could have an internal vertical structure as well. The second picture shows the same buttons laid out horizontally - the next common orientation. The other two show different layouts based on mixed use of the vertical and horizontal orientation. You might recognize their pattern: two (third picture) and three (last picture) rows that are vertically laid out.

As we already explained the layout process is always applying to a container. It will be enough to define the container frame with vertical or horizontal layout to have buttons as in the first and second pictures.

To design them in several rows we need to use additional frames as invisible containers: two horizontal frames, children of a vertical parent frame; or one horizontal frame laid out vertically with the Draw and Exit buttons. For widgets in a group it is obvious to use a vertical layout.

The layout hints data member of **TGLayoutHints** is the bit wise OR between the hints:

Hints	Description
<code>kLHintsNoHints</code>	no specified layout hints, the default ones will be used
<code>kLHintsLeft</code>	specifies the frame position to the left of the container frame after other frames with the same hint into the list
<code>kLHintsCenterX</code>	specifies the frame position centered horizontally (with vertical containers only)
<code>kLHintsRight</code>	specifies the frame position to the right of the container frame before any other laid out frames with the same hint into the list
<code>kLHintsTop</code>	specifies the frame position to the top of the container frame, below any laid out frames with the same hint
<code>kLHintsCenterY</code>	specifies the frame position centered vertically (with horizontal containers only)
<code>kLHintsBottom</code>	specifies the frame position to the bottom of the container frame, above any laid out frames with the same hint
<code>kLHintsExpandX</code>	specifies the frame to be expanded up to the width of the container frame. If the container frame is a vertical frame - it will fit the whole width. If it is a horizontal frame - after the positioning of all frames the available "free" width space is shared between the frames having this hint
<code>kLHintsExpandY</code>	specifies the frame to be expanded up to the height of the container frame. If the container frame is a horizontal frame - it will fit the whole height. If the container frame is a vertical frame - after the arrangement of all frames the available "free" height space is shared between the frames having this hint
<code>kLHintsNormal</code>	= <code>kLHintsLeft</code>   <code>kLHintsTop</code> - default hints

Layout policy:

Child frames never modify their container frame. The container frame can (or cannot) adapt its size in the layout process. It can show all or a part of its frames. Every **TGFrame** object has a default minimum size (1, 1) assured by **TGWindow**.

## 25.7 Event Processing: Signals and Slots

Event handling is the interaction between different objects with the goal of the objects reacting to

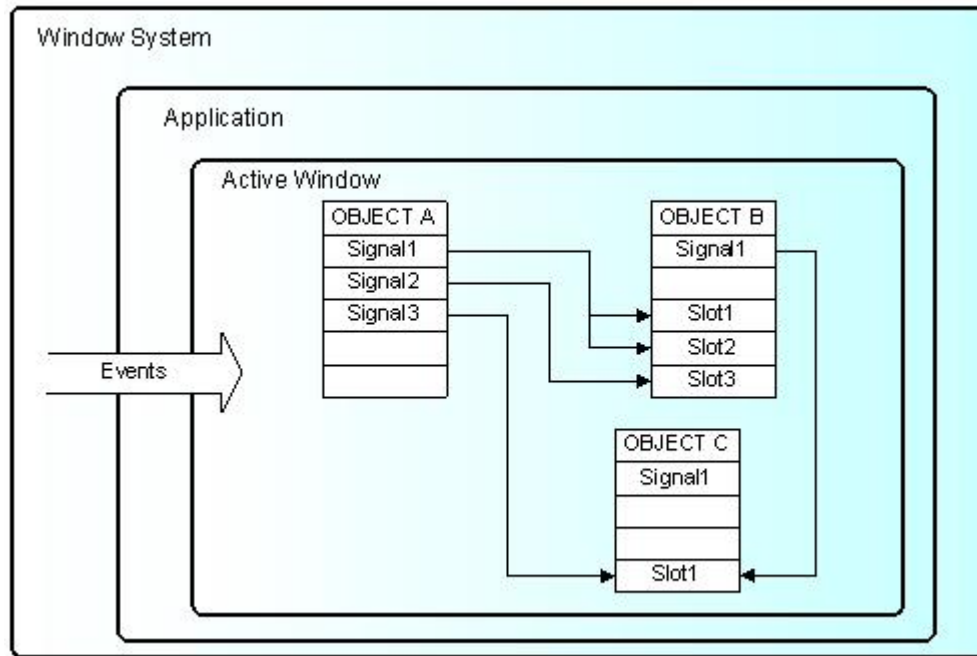

in C++. The objects are the instances of classes that don't know anything about each other. They interact and allow method calls of other object's methods. The idea is simple: any object can send out (emit) a signal in certain situations saying that something happened. This is all it does to communicate and it does not know whether anything is interested in this information. On the other side there might be an object waiting for that signal and ready to react to it. This object disposes of special instruments to listen to the sent out signals. To have a communication we need a message transmission between the objects. In this simple example we use signals and slots. The code of the method `TGButton::Clicked()` is:

```
virtual void Clicked() { Emit("Clicked()"); } // *SIGNAL*
```

I.e. any button emits the signal `Clicked()` any time someone clicks on it. As you can see this method is virtual and could be overridden if you need to. In our simple example we call the `Connect()` method to connect the `Clicked()` signal of Draw button with `MyMainFrame::DoDraw()`:

```
draw->Connect("Clicked()", "MyMainFrame", this, "DoDraw()");
```

In the same way we can connect to the signal `Clicked()` of the Exit button with the system call `gApplication->Terminate()`. We declare a new slot `DoExit()`, implement it to invoke the termination call and associate this slot with the signal `Clicked()` of the Exit button.

The code of `example.C` can be changed as follows:

```
public:
...
    void DoExit(); // a new slot is added
}
void MyMainFrame::DoExit() {
    gApplication->Terminate();
}
MyMainFrame::MyMainFrame(const TGWindow *p, UInt_t w, UInt_t h) {
...
    TGTextButton *exit = new TGTextButton(hframe, "&Exit ");
    // connects signal Clicked() with slot DoExit()
    exit->Connect("Clicked()", "MyMainFrame", this, "DoExit()");
...
}
```

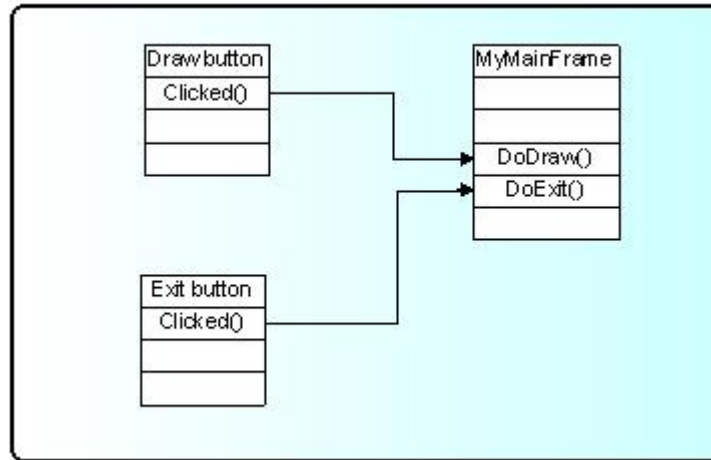

Here is an abstract view of the signal/slots connections in `example.C`:

To benefit from this mechanism your classes must inherit from `TQObject` or otherwise the class definition must start with `RQ_OBJECT("ClassName")` macro. This macro allows the signals/slots communication mechanism to be applied between compiled and interpreted classes in an interactive ROOT session without having the class derive from `TQObject`. Every signal method declaration is followed by a comment `"*SIGNAL*"`. Only instances of a class that defines a signal or instances of its subclasses can emit the signal. The ROOT implementation of a popular example presenting signals and slots is the next. Let's have a minimal class declaration:

```

class MyClass {
private:
    Int_t fValue;
public:
    MyClass() { fValue=0; }
    Int_t GetValue() const { return fValue; }
    void SetValue(Int_t);
};
  
```

It will become the following as interpreted:

```

class MyClass {
    RQ_OBJECT("MyClass")
private:
    Int_t fValue;
public:
    MyClass() { fValue=0; }
    Int_t GetValue() const { return fValue; }
    void SetValue(Int_t); // *SIGNAL*
};
  
```

Both class declarations have the same data member and public methods to access the value. By placing the `RQ_OBJECT("MyClass")` macro inside the `MyClass` body (`MyClass` is not inherited from `TQObject`) we allow this class to use the signal/slot communication. Any instance of this class can tell the outside world that the state of its data member has changed by emitting a signal `SetValue(Int_t)`. A possible implementation of `MyClass::SetValue()` can be:

```

void MyClass::SetValue(Int_t v) {
    if (v != fValue) {
        fValue = v;
        Emit("SetValue(Int_t)",v);
    }
}
  
```

The line `Emit("SetValue(Int_t)",v)` activates the signal `SetValue(Int_t)` with argument `v`. You can use any of the methods `TQObject::Emit("full_method_name",arguments)` to emit a signal. We create two instances of `MyClass` and connect them together:

```
MyClass *objA = new MyClass();
MyClass *objB = new MyClass();
objA->Connect("SetValue(Int_t)","MyClass",objB,"SetValue(Int_t)");
objB->SetValue(11);
objA->SetValue(79);
objB->GetValue();           // the value is 79
```

By calling the method `objA->Connect()`, `objA` connects its signal “`SetValue(Int_t)`” to the “`MyClass::SetValue(Int_t)`” method (slot) of `objB`. Next, when you call `objA->SetValue(79)` object `objA` emits a signal which `objB` receives and `objB->SetValue(79)` is invoked.

It is executed immediately, just like a normal function call. `objB` will emit the same signal in turn, but nobody is interested in this signal, since no slot has been connected to it. Signals are currently implemented for all ROOT GUI classes, event handlers (`TFileHandler`, `TSignalHandler`, etc.), timers (`TTimer`) and pads (`TPad`, `TCanvas`, etc.). To find all defined signals you just do: `grep '*SIGNAL*' $ROOTSYS/include/*.h`

As a programmer you build the sender-receiver part of object connections using the `TQObject::Connect()` method. You can connect one signal to many different slots. The slots will be activated in order they were connected to the signal. You can change this order using the methods `LowPriority()` and `HightPriority()` of `TQObject`. Also, many signals can be connected to one slot of a particular object or a slot can be connected to a signal for all objects of a specific class. It is even possible to connect a signal directly to another signal - this will emit the second signal immediately after the first one is emitted.

All signals and slots are normal class methods and can take any number of arguments of any type. The common methods of `TQObject` that activate a signal with any number and type of parameters are:

```
Emit(signal_name,param);
```

With no parameters `param` the method will be:

```
ApplyButton->Emit("Clicked()");
```

`param` can be a single parameter or an array of `Long_t` parameters as it is shown below:

```
TQObject *processor; // data processor
TH1F      *hist;     // filled with processor results
...
processor->Connect("Evaluated(Float_t, Float_t)", "TH1F", hist,
                  "Fill(Axis_t x, Axis_t y)");
...
Long_t args[2];
args[0]=(Long_t)processor->GetValue(1);
args[0]=(Long_t)processor->GetValue(2);
...
processor->Emit("Evaluated(Float_t, Float_t)", args);
...
```

To use signals and slot you need something that brings them together. The class `TQObject` has several methods creating sender-receiver connections. Some of them are static and can be called without having an instance of the class. The ROOT implementation of signals and slots allows connections to any known CINT object. The class name parameter in the `Connect()` methods must be a class with a dictionary (interpreted classes have an implicit dictionary).

```
TGButton *button;
TH2      *hist;
...
TQObject::Connect(button,"Clicked()", "TH2", hist, "Draw(Option_t*)");
```

You can replace it with 0 (zero) and in this case the slot string defines a global or interpreted function name. The receiver parameter should be zero too. For example:

```
TQObject::Connect(button, "Clicked()",0,0, "hsimple()");
```

To make a single connection from all objects of a class you should write:

```
TQObject::Connect("Channel", "AlarmOn()", "HandlerClass", handler,
    "HandleAlarm()");
```

The first argument specifies the class name Channel. The signal AlarmOn() of any object of the class Channel is connected to the HandleAlarm() method of the handler object of the class HandlerClass.

In example.C we have used the not-static Connect() method:

```
Bool_t Connect(const char *signal, const char *receiver_class,
    void *receiver, const char *slot);
```

It needs to know four things: the signal that should be connected, the receiver class, the object that will receive the signal, and the slot that will be connected to the signal. Because this method is non-static we can write this as a receiver parameter.

In all methods you have to specify the signal and the slot with their names and parameter types. Do not write values instead of types in that place. It is possible to pass a parameter by value to a slot method in the following way:

```
Connect(myButton, "Pressed()", "TH1", hist, "SetMaximum(=123) ");
Connect(myButton, "Pressed()", "TH1", hist, "Draw(=\"LEGO\")");
```

As you see the parameter's value is preceded by the equation symbol (=).

You have the possibility to destroy a signal/slot connection by using Disconnect() methods. There are three ways to do this:

1/ to destroy all connections to an object's signals;

2/ to destroy all connections to a particular object's signal; 3/ to detach an object from a specific receiver:

```
Disconnect(myObject); // case 1
Disconnect(myObject, "mySignal"); // case 2
Disconnect(myObject, 0, myReceiver, 0); // case 3
```

Three parameters of these methods could be replaced by 0. The meaning in these cases would be "any signal", "any receiving object", "any slot of the receiving object", i.e. 0 is used as a wildcard. The sender parameter cannot be 0, because you can disconnect signals from one given object. If the signal parameter is 0, the receiver and the slot are disconnected from any signal. Giving the name of the signal you disconnect this signal.

In addition to all Qt features the ROOT version of signals/slots gives you the possibility to connect slots to a class. The slots will be executed every time the specified signal is emitted by any object of this class. A slot can have default arguments and it can be either a class method or stand-alone function (compiled or interpreted).

The method TObject::HasConnection(signale\_name) checks if there is an object connected to this signal and returns true if it is the case.

Using TObject::NumberOfConnections(), TObject::NumberOfSignals() you can check how many signals or connections has the object.

The rules for using signals/slots mechanism in a standalone executable program do not differ from what was described previously. Let's remind that

- a slot can be any class method with a generated CINT dictionary



- a slot can be a function with a dictionary

Detailed information how to generate a dictionary can be found on <http://root.cern.ch/root/CintGenerator.html>

The following example demonstrates how to use signals/slots mechanism in a standalone executable program on linux platform with the gcc compiler.

tst.C

```
#include <TQObject.h>
#include <RQ_OBJECT.h>

class A {
    RQ_OBJECT("A")
private:
    Int_t fValue;
public:
    A() : fValue(0) { }
    ~A() { }
    void SetValue(Int_t value); // *SIGNAL*
    void PrintValue() const { printf("value = %d\n", fValue); }
};

void A::SetValue(Int_t value) { // Set new value
    // Emit signal "SetValue(Int_t)" with a single parameter
    if (value != fValue) {
        fValue = value;
        Emit("SetValue(Int_t)", fValue);
    }
}

// Main program
#ifdef STANDALONE
int main(int argc, char **argv) {
    A* a = new A();
    A* b = new A();
    a->Connect("SetValue(Int_t)", "A", b, "SetValue(Int_t)");
    printf("\n***** Test of SetValue(Int_t) signal *****\n");
    b->SetValue(10);
    printf("\nt***** b before *****\n");
    b->PrintValue();
    a->SetValue(20);
    printf("\t***** b after a->SetValue(20) *****\n");
    b->PrintValue();
    return 0;
}
#endif
```

ACLiC simplifies this procedure and allows the dictionary generation by:

```
root[] .L tst.C++
```

It will create the shared library `tst_C.so`.

The next line will create an executable:

```
g++ -otst tst.C 'root-config --cflags --libs' ./tst_C.so -DSTANDALONE
```

The library `tst_C.so` is a dynamically loaded library and should be located in `$LD_LIBRARY_PATH`. The current working directory should be added to `$LD_LIBRARY_PATH` via:

```
export LD_LIBRARY_PATH=$LD_LIBRARY_PATH:./
```

To run it, you just do:

```
./tst
```



## 25.8 Widgets in Detail

### 25.8.1 Buttons

Buttons are a popular group of widgets designed to provide specific interfaces for user interaction. **TGButton** is an abstract class defining the general button behavior: width, height, state, its group, tool tip text, etc.

There are two main groups of buttons: command buttons with a text or graphics inside that indicate the action to be accomplished and option buttons well known as radio and check buttons that select or change properties. The first group is presented in ROOT by **TGPictureButton** and **TGTextButton** classes. They yield an action as soon as they are clicked. It can be opening/closing a dialog box or invoking a specific function in an application. Remember the Draw button from the example. The radio and check buttons from the second group are used to select an option. There is a visual difference between these two groups: the text buttons appear “pressed in” only while they are clicked, while the radio and check buttons change their appearance when they are selected and keep that appearance afterwards.

A text button is represented by the class **TGTextButton**. We already used its constructor in the example. The button label indicates the action to be taken when the button is selected or pressed. The text can be a hot string defining a hot key (known as shortcut key also) for this selection. The hot key is an underlined character in a button label that shows the assigned keyboard mnemonic for its choice. A button that prompts more information for users has the label generally followed by ellipsis (...).



As we saw the hot strings “&Draw” and “&Exit” define the text labels “Draw” and “Exit” and keyboard mnemonics **Alt+D**, **Alt+E** for their selection. The letter D and E appear underlined on the screen. All text buttons should have a unique shortcut key with the exception of OK and Cancel.

These buttons are usually placed within a window to provide fast access to frequently used or critical commands. They help in situations where a command is not available through the menu bar. You already know that a command string can be passed in the text button via the constructor:

```
TGTextButton(const TGWindow *p, const char *s, const char *cmd,
             Int_t id, GContext_t norm, FontStruct_t font,
             UInt_t options);
```

A button label can be changed by **SetText(new\_label)**. There are important guidelines to be followed about a button label. The text has to provide a meaningful description of the performed action. The single-word label should be used whenever possible, only two-three words for clarity, if necessary. Do not number labels. Always follow all platform presentation and usage guidelines for standard button functions. Let’s remember a few standard names and definitions of well known buttons:

**OK** - any changed information in a window is accepted and the window is closed;

**Cancel** - closes window without implementing submitted changes;

**Reset** - resets defaults and cancels any changed information that has not be submitted;

**Apply** - any changed information is accepted and again displayed in the window that remains open;

**Close** - closes the window;

**Help** - opens online Help.

Below are examples of text buttons. Note the two placement methods. The first example should be used when there are one to three command buttons; the second one when there are more than three buttons.

Picture buttons are usually rectangular in shape with an icon or graphics label. These buttons may appear alone or placed in a group at the window’s top or side. They are most frequently used to quickly access commands, many of which are normally accessed through the tool bar. For example, the picture buttons below can be used to provide different styles of a histogram drawing.

Here is the example how to create the first button:

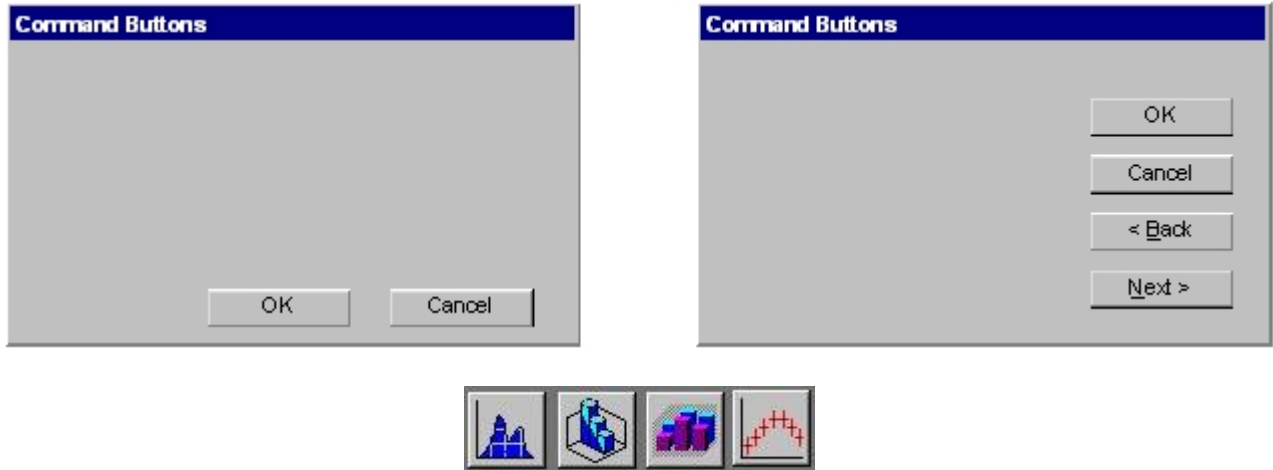

```
TGPictureButton *fPicture = new TGPictureButton(parent,
    gClient->GetPicture("h1_s.xpm"), 11);
```

The picture of file `h1_s.xpm` is used in the button. All `.xpm` files are located in the directory `$ROOTSYS/icons`. You can assign a command directly as a parameter of the picture button constructor. The picture of `TGPictureButton` can be changed by:

```
fPicture->SetPicture("h2_s.xpm");
```

The advantage of command buttons is that they are always visible, providing a reminder of their existence. They can be inscribed with a meaningful description of what they do by `TGToolTip("Some describing text")`. Their activation is much easier and faster than using a two-step menu bar/pull-down sequence. The only disadvantage of the text and picture buttons is that they consume considerable screen space if they are many. Having no more than six command buttons per window or dialog box helps to appropriately balance the application's effectiveness, its real efficiency, and the operational simplicity.

The classes `TGRadioButton` and `TGCheckButton` present the option buttons in ROOT. Like the text buttons, they have text or hot string as a label. Radio buttons are grouped in logical sets of two or more and appear with a text label to the right. The choices are mutually exclusive and only one setting is permitted at one time. They represent visually all alternatives and it is easy to access and compare choices. They facilitate the situations where all alternatives cannot be easily remembered or where displaying the alternatives together helps to understand and select the proper choice. It is very useful to provide a default setting whenever it is possible. When it is not possible to establish a default setting because of the nature of the information, it is better to leave all radio buttons blank.

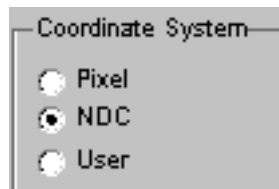

A columnar orientation is the preferred manner of radio buttons presentation. If the vertical space on the window is limited, they can be oriented horizontally. Selection choices should be organized logically in groups. Here is the example that produces the image above:

```
br = new TGButtonGroup(p,"Coordinate system",kVerticalFrame);
fR[0] = new TGRadioButton(bg,new TGHotString("&Pixel"));
fR[1] = new TGRadioButton(bg,new TGHotString("&NDC "));
fR[2] = new TGRadioButton(bg,new TGHotString("&User "));
fR[1]->SetState(kButtonDown);
br->Show();
```

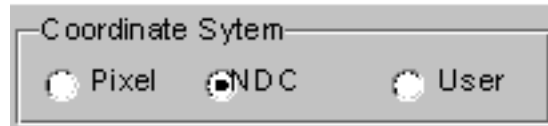

It is enough to change `kVerticalFrame` to `kHorizontalFrame` in `TGButtonGroup` constructor and you will have radio buttons aligned horizontally:

The class `TGButtonGroup` will help you to organize button widgets in a group. There is no need to call `AddFrame()` since the buttons are added automatically with a default layout hint to their parent by `TGButtonGroup::Show()` as shown in the previous example. The buttons in the group have assigned identifiers. Any button in a group emits a `Clicked()` signal with this identifier when it is clicked. This giving an ideal solution to connect several `Clicked()` signals to one slot.

An exclusive button group switches off all toggle buttons except the selected one. The group is by default non-exclusive but its entire radio buttons will be mutually exclusive.

`TGHButtonGroup` and `TGVButtonGroup` are convenience classes that offer you a thin layer on top of `TGButtonGroup`. `TGHButtonGroup` organize button widgets in a group of one horizontal row, `TGVButtonGroup` in a group of one column. You can also organize buttons in rows and columns using the provided constructor and `TGMatrixLayout`.

Do not use a radio button to indicate the presence or absence of a state - use a check box instead.

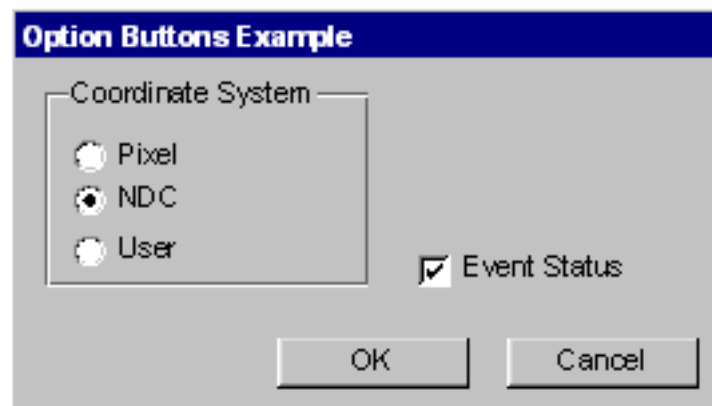

To have the check button “Event Status” and to set it as selected we need to write:

```
TGCheckBox *estat = new TGCheckBox(p, "Event Status",1);
estat->SetState(kButtonDown);
```

Check boxes show the selected choices and any number of them can be selected, including none. Their proper usage is for setting attributes, properties or values; also for data or choices that are discrete, small and fixed in number, not easily remembered. With check boxes all alternatives are visible: it is easy to access and compare choices because they can all be seen together. Each option acts as a switch and can be either “on” or “off”. It is never changed in contents. Checkboxes differ from radio buttons in that they permit selection of more than one alternative. Each box can be switched on or off independently. These buttons can be used alone or grouped in sets. It is good practice to provide default settings for check boxes whenever it is possible.

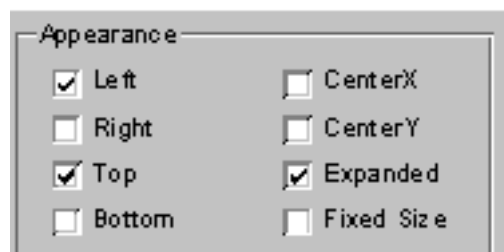

This can be done by:

```
SetState(EButtonState state)
```

The parameter `state` can be one of `kButtonUp`, `kButtonDown`, `kButtonEngaged`, `kButtonDisabled`.

Check boxes can be used to affect other controls. The contents of a list can, for example, be filtered by setting a check box. In any case, use a check box only when both states of a choice are clearly opposite and unambiguous. If opposite states are not clear, it is better to use two radio buttons.

Choice description, i.e. check box label, must be clear, meaningful, fully spelled out, and displayed in mixed-type text. Whenever the use of a given button is inappropriate, for whatever reason, that button should be disabled:

```
button->SetState(kButtonDisabled);
```

Never make a button appear and disappear.

In general, option buttons should not offer more than eight choices. If the number of choices exceeds this maximum, it is better to use a multiple selection list box.

The method `IsToggleButton()` gives the information whether a radio button or a check button is selected. An option button can be set or unset via its method `PSetState(EButtonState state)`.

The method `HandleKey(event)` is called when the defined hotkey is hit for any button. It sets the selected option button or clicks the selected text button and invokes its defined action.

## 25.8.2 Text Entries

A `TGTextEntry` is a one-line text input widget. It contains text that is entered or modified through the keyboard. This text may be displayed in different way according to the set echo mode. Users can control them by `SetEchoMode()`, `GetEchoMode()` methods.

- `kNormal` - display characters as they are entered (default);
- `kNoEcho` - do not display anything;
- `kPassword` - display asterisks instead of the characters actually entered.

The way in which typed characters are inserted in the text entry is defined by `TGTextEntry::EInsertMode` and can be toggled by the Insert key:

- `kInsert` - typed character are inserted (cursor has shape of short line)
- `kReplace` - entered characters substitute already typed ones (cursor has the shape of filled rectangle).

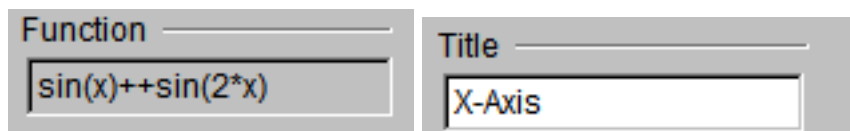

There are different text alignment modes defined by `TGWidget::ETextJustification`. They are valid until text fits the frame width of the text entry field.

- `kTextLeft` - left-side text alignment
- `kTextRight` - right-side text alignment
- `kTextCenterX` - center text alignment along x direction
- `kTextTop` - top-side text alignment
- `kTextBottom` - bottom-side text alignment
- `kTextCenterY` - center text alignment along y direction

### 25.8.3 Number Entries

The `TGNumberEntry` class present number entry widgets. A number entry is a single-line field followed by two small, vertically arranged up-down buttons. Its purpose is to make a selection by either scrolling through a small set of meaningful predefined choices or typing numbers. The `TGNumberFormat` class contains `enum` types to specify the numeric format. The number entry widget is based on `TGTextEntry`. It allows only numerical input. The widget supports numerous formats including integers, hex numbers, real numbers, fixed fraction real and time/date formats. It also allows to restrict input values to non-negative or positive numbers and to specify explicit limits.

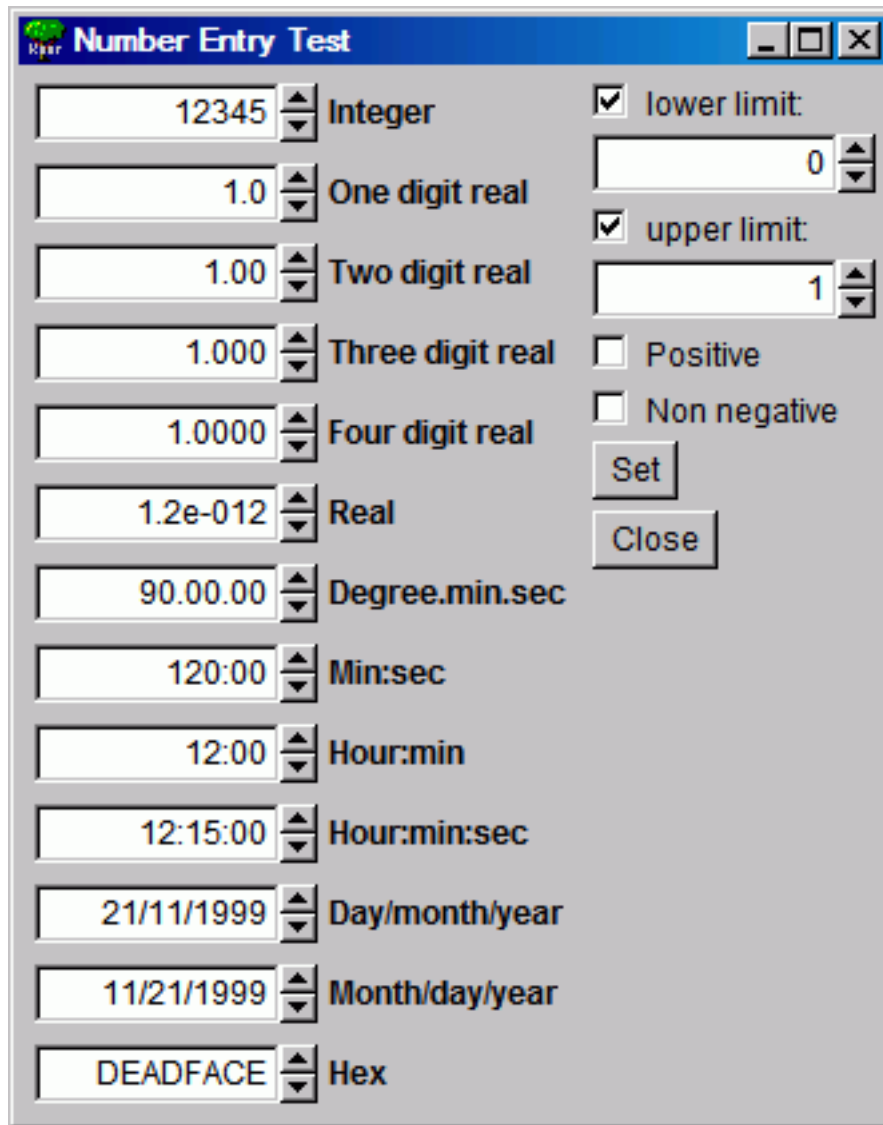

The following styles are supported:

- `kNESInteger` - integer number
- `kNESRealOne` - real number with one digit (no exponent)
- `kNESRealTwo` - real number with two digits (no exponent)
- `kNESRealThree` - real number with three digits (no exponent)
- `kNESRealFour` - real number with four digits (no exponent)
- `kNESReal` - arbitrary real number
- `kNESDegree` - angle in degree:minutes:seconds format

- `kNESMinSec` - time in minutes:seconds format
- `kNESHourMin` - time in hour:minutes format
- `kNESHourMinSec` - time in hour:minutes:seconds format
- `kNESDayYear` - date in day/month/year format
- `kNESMDayYear` - date in month/day/year format
- `kNESHex`- hexadecimal number

The following attributes can be specified:

- `kNEAAnyNumber` - any number is allowed
- `kNEANonNegative` - only non-negative numbers are allowed
- `kNEAPositive` - only positive numbers are allowed

Explicit limits can be specified individually:

- `kNELNoLimits` - no limits
- `kNELLimitMin` - lower limit only
- `kNELLimitMax` - upper limit only
- `kNELLimitMinMax` - both lower and upper limits

```
fn1 = new TGNumberEntry(parent, 0.005, 9, kENTRY1,
    TGNumberFormat::kNESRealThree, //style
    TGNumberFormat::kNEAAnyNumber, //input value filter
    TGNumberFormat::kNELLimitMinMax, //specify limits
    -1., 1.); //limit values
```

`TGNumberEntryField` is a number entry input widget.

```
Nent = new TGNumberEntryField(hgrunf2, kNENT_ID, 0.6,
    TGNumberFormat::kNESRealThree,
    TGNumberFormat::kNEAAnyNumber);
```

`TGNumberEntryField` is a plain vanilla entry field, whereas `TGNumberEntry` adds two small buttons to increase and decrease the numerical value in the field. The number entry widgets also support using the up and down cursor keys to change the numerical values. The step size can be selected with control and shift keys:

- -small step (1 unit/factor of 3)
- Shift medium step (10 units/factor of 10)
- Controllarge step (100 units/factor of 30)
- Shift+Controlhuge step (1000 units/factor of 100)

The steps are either linear or logarithmic. The default behavior is set when the entry field is created, but it can be changed by pressing the alt key at the same time.

## 25.8.4 Menus

Menus provide a list of commands or options helping the user to select and to perform a task. The menu system classes are `TGMenuBar`, `TGMenuItem`, `TGPopupMenu`, and `TGMenuEntry`.

The `TGMenuBar` class implements a menu bar widget. It is used to specify and provide access to common and frequently used application actions described in menu titles, implemented by `TGMenuItem` class. The menu bar is the highest-level of the menu system and it is a starting point for all interactions. Also, it is always visible and allows using the keyboard equivalents. The geometry of the menu bar is automatically set to the parent widget, i.e. the menu bar automatically resizes itself so that it has the same width as its parent (typically `TGMainFrame`).

The menu bar is as a container for its menus - objects of the type `TGPopupMenu`. Popup menus can appear in a menu bar. They can be a sub-menu of another popup menu (cascading menus) or can be standalone (as a context menu). They are made of one or more menu items choices. When displayed, the menu items are arranged in a vertical list. Usually they correspond to actions (e.g. `Open`). These items can be labeled with text, graphics or a combination of both. Each of them should have a character defined as its unique key for access. Grouped logically by their functionality, they are separated visually by menu separators in groups. For example, The `File` menu is a common menu title for tasks that apply to a file, as `Open,Save,Close,Print...`

```
// a popup menu
fMenuFile = new TGPopupMenu(gClient->GetRoot());

// adding menu entries
fMenuFile->AddEntry("&Open...",M_FILE_OPEN);
fMenuFile->AddEntry("&Save",M_FILE_SAVE);
fMenuFile->AddEntry("S&ave as...",M_FILE_SAVEAS);
fMenuFile->AddEntry("&Close", -1);

// adding separator
fMenuFile->AddSeparator();

// next group of menu entries
fMenuFile->AddEntry("&Print",M_FILE_PRINT);
fMenuFile->AddEntry("P&rint setup...",M_FILE_PRINTSETUP);
. . .
fMenuFile->AddSeparator();
fMenuFile->AddEntry("E&xit",M_FILE_EXIT);
```

First we create the `File` menu by creating an object of class `TGPopupMenu` and adding menu entries with `AddEntry` method. Its first parameter is a hot string, the second - a menu ID. The ampersand character (&) denotes shortcut for each menu entry; you can use the letter after it to manage the menu via keyboard. There are three groups of menu entries separated visually by two separators.

You can add a sub-menu by using the method `TGPopupMenu::AddPopup`. Its first parameter is again a string, the second one - a pointer to a `TGPopupMenu` object that will appear as a sub-menu when the menu entry will be selected. The often used visual indicator of a sub- menu is a right-facing arrow to the right of the parent menu item. Generally only one level of cascading menus is recommended and you should be careful in using more. Next lines show how to create a menu bar with `File,Test` and `Help` menus:

```
// menu bar item layout hints
fMenuItemLayout = new TGLayoutHints(kLHintsTop|kLHintsLeft,0,4,0,0);
fMBHelpLayout = new TGLayoutHints(kLHintsTop|kLHintsRight);

// menu bar
fMenuBar = new TGMenuBar(fMain,100,20,kHorizontalFrame);

// adding popup menus
fMenuBar->AddPopup("&File", fMenuFile, fMenuItemLayout);
fMenuBar->AddPopup("&Test", fMenuTest, fMenuItemLayout);
fMenuBar->AddPopup("&Help", fMenuHelp, fMBHelpLayout);
```

Using the method `TGMenuBar::AddPopup` we add three `TGPopupMenu` objects to the menu bar `fMenuBar`. The first parameter is a hot string used by `TGMenuItem` object. When you add a popup menu to the menu bar, a `TGMenuItem` object is created by the menu bar. It is the name of the popup menu. A menu title should have a one-word name that reflects the purpose of all items within the corresponding popup menu. It should also have a defined character as its unique access key. The second parameter is the popup menu we would like to add. The third one is an object of `TGLayoutHints` type that defines how the menu title will be laid out in the menu bar. In our example the *File* and *Test* menus will be laid out to the left of the menu bar with 4 pixels distance in between, the *Help* menu - will be laid out to the right.

The menu classes provide a very flexible menu system: you can enable, disable, add or remove menu items dynamically. The method `HideEntry(menuID)` hides the menu entry (the entry will not be shown in the popup menu). To enable a hidden entry you should call `EnableEntry(menuID)` method. By default all entries are enabled. The method `DisableEntry(menuID)` helps you to disable a menu entry - it will appear in sunken relieve. The `DeleteEntry(menuID)` method will delete the specified entry from the menu.

A few words about the menu design. A menu should be kept consistent and simple. All related items need to be in a popup menu. The cascade menus should be used judiciously. Try to limit them to one, maximum two levels.

There are some rules for naming the menu objects:

- Define unique names within a menu
- Use capitalized one-word names allowing the quick scan of the menu
- Define unique access key for any menu item
- Indicate by ellipsis (...) after the title with no space when a menu item will pop-up a dialog box

The proper kind of graphical menus is a critical point to every application success and depends of three main factors:

- number of presented items in the menu
- how often the menu is used
- how often the menu contents may change

### 25.8.5 Toolbar



A toolbar (`TGToolBar`) is a composite frame that contains `TGPictureButton` objects. It provides an easy and fast access to most frequently used commands or options across multiple application screens. Also, it invokes easily a sub application within an application. All its functions can be obtained by application menus. It is located horizontally at the top of the main window just below the menu bar. All other subtask and sub-feature bars are positioned along sides of window.

```
// toolbar icon files
const char *xpms[] = {
    "x_pic.xpm",
    "y_pic.xpm",
    "z_pic.xpm",
    0
};
// toolbar tool tip text
const char *tips[] = {
    "X Settings",
    "Y Settings",
    "Z Settings",
```



```

    0
};
// toolbar button separator
int separator = 5;

// structure containing toolbar button information
ToolBarData_t t[3];

// creation of a toolbar object as a child of main frame
TGToolBar *tb = new TGToolBar(fMain,520,80);

for (int i = 0; i < 3; i++) {
    // filling the ToolBarData_t with information
    t[i].fPixmap = xpms[i]; // icon file
    t[i].fTipText = tips[i]; // tool tip text
    t[i].fStayDown = kFALSE; // button behavior if clicked
    t[i].fId = i+1; // button id
    t[i].fButton = NULL; // button pointer

    if (strlen(xpms[i]) == 0) {
        separator = 5;
        continue;
    }
    tb->AddButton(fMain,&t[i],separator);
    separator = 0;
}
// adding the tool bar to the main frame
fMain->AddFrame(tb, new TGLayoutHints(kLHintsTop|kLHintsExpandX));

// adding a horizontal line as a separator
TGHorizontal3DLine *lh = new TGHorizontal3DLine(fMain);
fMain->AddFrame(lh, new TGLayoutHints(kLHintsTop|kLHintsExpandX));

```

To have a tool bar in your application you do not need to do anything special - only to create objects: a tool bar and its picture buttons. This sample code creates the following three toolbar buttons:



First we need to complete a `ToolBarData_t` structure for each tool bar button before adding it to the tool bar. This structure contains:

- the icon file name “filename.xpm”
- the tool tip text - a short help message explaining the button purpose
- the Boolean variable defining the button behavior when is clicked
- `kFALSE` - do not stay down
- `kTRUE` - to stay down
- the button ID
- the button pointer (`TGButton *`) - should be `NULL`

We create an array `*xpms[]` containing the icon file names that will be used for a picture button creation. If you write only the file names here `ROOT` will search these files in `$ROOTSYS/icons` directory. If the icon files are not there, you should provide the full path name also. The array `*tips[]` contains the tool tip texts for buttons. The integer variable `separator` is used to set the distance between two groups of toolbar buttons. It defines the amount of pixels to the left for each button.

We create a tool bar object and add the buttons using the `AddButton` method. The variable separator helps us to define no space between the buttons in a group (0), and 5 pixels extra-space before and after. All buttons added via this method will be deleted by the toolbar. On return the `TGButton` field of the `ToolBarData_t` structure is filled in (if the icon pixmap was valid). The first parameter is the window to which the button messages will be sent. Lastly, we create an object of class `TGHorizontal3DLine` - a horizontal 3D line. It will separate the toolbar from the menu bar because the layout hints we define as `kLHintsTop | kLHintsExpandX`.

It is user friendly to allow the possibility for the tool bar to be turned on or off (via a menu). If you use a single tool bar, it should fill the complete width of its parent. When using more than one, you should also think about setting the bar size to the end of the most right button. This way other bars can be displayed in the same row below the menu bar.

Tool bar buttons should have equal size, meaningful and unique icons, and short meaningful tool tip text. The related buttons should be grouped together by frequency or sequence of use, or importance. Potentially destructive buttons must be separated from them to avoid accidental activation and potentially catastrophic results. Temporarily not available items should be displayed grayed out.

## 25.8.6 List Boxes

The purpose of a list box is to display a collection of items from which single or multiple selection can be made. It is always visible, having a scroll bar when the displayed area is not enough to show all items. The choices may be mutually exclusive (a list box with single selection) or not mutually exclusive (a list box with multiple selection).

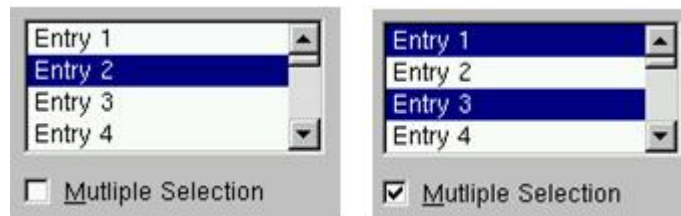

The proper usage of the list boxes is for selecting values, or objects, or setting attributes. You have to create them to display 4 to 8 choices at one time (3 is a required minimum in case of lack of screen space). The list should contain not more than 40 items accessible by scrolling view (vertical scroll bar). If more are required, you should provide a method for using search criteria or scoping the options. The best list boxes use is for textual data or choices. They should be wide enough to display fully all items. When it is not possible, break the long items with ellipsis and provide tool tip that displays the full item text.

The list box widget is represented by `TGListBox`, `TGLBContainer`, `TGLBEntry` and `TGTextLBEntry` classes. Currently entries are simple text strings (`TGTextLBEntry`). A `TGListBox` looks a lot like a `TGCanvas`. It has a `TGViewPort` containing a `TGLBContainer` which contains the entries and it also has a vertical scrollbar which becomes visible if there are more items than fit in the visible part of the container. The `TGListBox` is user callable. The other classes are service classes of the list box. Here is a sample code showing how to create a list box with ten entries:

```
// list box widget containing 10 entries
int fFirstEntry = 0, fLastEntry = 10;
char tmp[20];
TGListBox *fListBox = new TGListBox(parent, 90);
for (i = fFirstEntry; i < fLastEntry; i++) {
    sprintf(tmp, "Entry %i", i+1);
    fListBox->AddEntry(tmp, i);
}
fListBox->Resize(150, 80);
parent->AddFrame(fListBox, new TGLayoutHints(kLHintsTop|kLHintsLeft,
                                           5, 5, 5, 5));
```

We create the list box widget passing the parent window pointer and giving an ID number. Next we add entries with specified string and ID to the list box. Before adding the list box to its parent widget, it should be resized via `Resize(width, height)` method. The list box width and height are in pixels. The default entry layout hints are `kLHintsExpandX | kLHintsTop`. If you want to add entries using different ones, call the method:

```
TGListBox::AddEntry(TGLBEntry *lbe, TGLayoutHints *lhints);
```

It adds the specified **TGLBEntry** and **TGLayoutHints** to the list box. There are several methods providing a flexible entry manipulation: you can insert, add or remove list box items dynamically. The list box entry IDs are used in these methods and also in event processing routines. In our example the integer variables **fFirstEntry** and **fLastEntry** contain the information about the first and last entry IDs. You can add or remove a list box entry using them in the following way:

```
// adding an entry
fLastEntry++;
sprintf(tmp, "Entry %i", fLastEntry);
fListBox->AddEntry(tmp, fLastEntry);
fListBox->MapSubwindows();
fListBox->Layout();
. . .
// removing an entry
if (fFirstEntry < fLastEntry) {
    fListBox->RemoveEntry(fFirstEntry);
    fListBox->Layout();
    fFirstEntry++;
}
```

A single-selection list box is used for selecting only one item in a list.

A multiple-selection list box permits selection of more than one item. The selected choices should be visible - you have several choices to do this:

- to mark selected choices with a check mark or highlight them
- to provide a summary list box to the right of the list box, containing the selected choices
- to provide a display-only text control indicating the number of selected choices (its position should be justified upper-right above the list box)
- if the actions **Select All** or **Deselect All** must be quickly or frequently performed, use command buttons

### 25.8.7 Combo Boxes

A combo box is a single-selection list box that shows only the currently selected entry and a prompt button displayed as a downward arrow. The prompt button provides a visual cue that a list box is hidden. Its main advantage is consuming of quite a bit of screen space. When the user clicks on it, a list pops up, from which a new choice can be made. After a new item is chosen the combo box folds again showing the new selection.

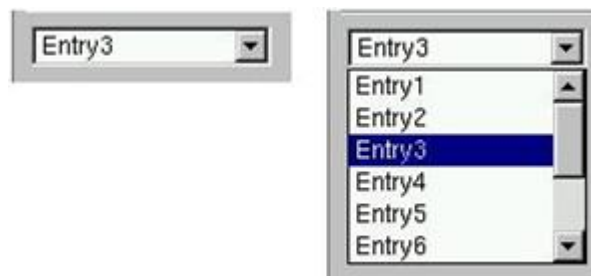

The combo box widget is represented by the user callable class **TGComboBox**. The class **TGComboBoxPopup** is a service class. The combo box constructor is very similar to the list box one. The first parameter is a parent widget pointer again, the second - an integer value that will be used as combo box ID. The method used for adding entries is very similar to the list box method we used before. The method **Select(entryID)** sets the current combo box entry.

```

char tmp[20];
// combo box layout hints
fLcombo = new TGLayoutHints(kLHintsTop | kLHintsLeft,5,5,5,5);
// combo box widget
TGComboBox *fCombo = new TGComboBox(parent,100);
for (i = 0; i < 10; i++) {
    sprintf(tmp, "Entry%i", i+1);
    fCombo->AddEntry(tmp, i+1);
}
fCombo->Resize(150, 20);
// Entry3 is selected as current
fCombo->Select(2);
parent->AddFrame(fCombo, fLcombo);

```

You have the same flexibility to add, insert or remove entries. As with list boxes you can retrieve the information for currently selected item via `GetSelected` or `GetSelectedEntry` methods. The first one returns the entry ID, the second - the current entry pointer (`TGLBEntry *`).

### 25.8.8 Sliders

A slider is a scale with an indicator (slider) that you can drag to choose a value from a predefined range. It may be oriented horizontally or vertically. In both cases it provides an excellent indication of where a value exists within a range of values.



The class `TGHSlider` represents the horizontal slider; `TGVSlider` - the vertical one. Both inherit from the base class `TGSlider` that creates the main slider parameters: the range of values within a value can be selected; the indicator type; the tick mark scale. Using its methods `SetRange`, `SetPosition` and `SetScale` you can set these parameters. To retrieve the set slider value you can call `GetPosition` method.

Next sample code creates a horizontal slider `hslider` with a tick mark of type `kSlider1`. Its width is 150 pixels, and its scale is placed down (`kScaleDownRight`). The last parameter in the `TGHSlider` constructor is the slider ID. It will be used for event processing. The methods `SetRange` and `SetPosition` set the range and the current tick mark position of the slider.

```

hslider = new TGHSlider(parent,150,kSlider1|kScaleDownRight,sID);
hslider->SetRange(0,50);
hslider->SetPosition(39);

```

Slider values can be set by using the mouse to drag the slider across the scale until the desired value is reached. Another way is to click in the slider trough instead of dragging.

#### 25.8.8.1 Double Slider

Double slider widgets allow easy selection of a min and a max value out of a range. They can be either horizontal or vertical oriented. There is a choice of different types of tick marks: `kDoubleScaleNo`, `kScaleDownRight`, `kDoubleScaleBoth`.

To change the `min` value you should press the left mouse button near to the left (`TGDoubleHSlider`) or bottom (`TGDoubleVSlider`) edge of the slider. Alternatively, to change the `max` value you need to press the mouse near to the right (`TGDoubleHSlider`) or top (`TGDoubleVSlider`) edge of the slider. To change both values simultaneously you should press the left mouse button near to the center of the slider.

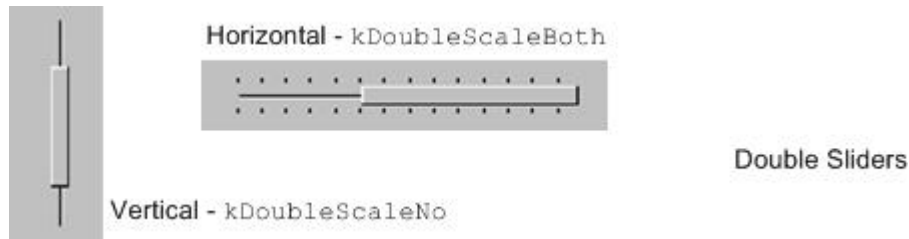

**TGDoubleSlider** is an abstract base class that creates the main slider parameters. The concrete class to use for a vertical double slider is **TGDoubleVSlider** and **TGDoubleHSlider** for a horizontal one. The double slider constructors are similar to those of the other sliders. If you set `kDoubleScaleNo` as a scale parameter no scale will be drawn. Here is an example:

```
vDslider = new TGDoubleVSlider(p,100,kDoubleScaleNo,dsliderID);
vDslider->SetRange(-10,10);
```

### 25.8.9 Triple Slider

The new **TGTripleHSlider** and **TGTripleVSlider** classes inherit from the double slider widgets and allow easy selection of a range and a pointer value. The pointer position can be constrained into the selected range or can be relative to it.

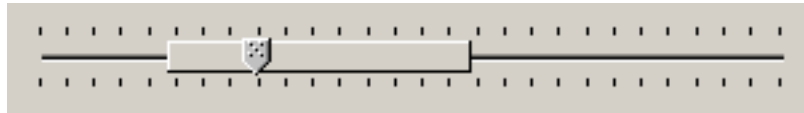

To change the slider range value press the left mouse button near to the left/right (top/bottom) edges of the slider. To change both values simultaneously press the mouse button near to the slider center. To change pointer value press the mouse on the pointer and drag it to the desired position.

```
fSlider = new TGTripleHSlider(parent,100,kDoubleScaleBoth,kSLD_ID,
                             kHorizontalFrame);
parent->AddFrame(fSlider,new TGLayoutHints(kLHintsExpandX,5,5,5,5));
fSlider->SetConstrained(kTRUE);
fSlider->SetRange(rmin, rmax);
fSlider->SetPosition(pmin, pmax);
fSlider ->SetPointerPosition(pvalue);
```

### 25.8.10 Progress Bars

A progress bar is a widget that shows that an operation is in progress and how much time is left. It is a long rectangular bar, initially empty, that fills with a color as a process is being performed. The filled-in area indicates the percentage of the process that has been completed. You should use this widget for waits exceeding **one minute**. For a very time consuming operation it is better to break the operation into subtasks and provide a progress bar for each of them.



A progress bar may be oriented horizontally or vertically. The horizontally oriented progress bar fills with a color from left to right; the vertically oriented - from bottom to top. A percent complete message provides an indication of the

completed part of the process. It is a good practice to include some descriptive text of the process to keep users informed and entertained while they are waiting for process completion.

The picture below shows the progress bars you can create using the classes `TGProgressBar`, `TGHProgressBar`, and `TGHProgressBar`.

```
// vertical frame with three horizontal progressive bars
TGVerticalFrame *vframe = new TGVerticalFrame(fMain, 10, 10);
fHProg1 = new TGHProgressBar(vframe, TGProgressBar::kStandard, 300);
fHProg1->ShowPosition();
fHProg1->SetBarColor("yellow");
fHProg2 = new TGHProgressBar(vframe, TGProgressBar::kFancy, 300);
fHProg2->SetBarColor("lightblue");
fHProg2->ShowPosition(kTRUE, kFALSE, "%.0f events");
fHProg3 = new TGHProgressBar(vframe, TGProgressBar::kStandard, 300);
fHProg3->SetFillType(TGProgressBar::kBlockFill);

vframe->AddFrame(fHProg1, new TGLayoutHints(kLHintsTop|kLHintsLeft|
                                         kLHintsExpandX, 5, 5, 5, 10));
vframe->AddFrame(fHProg2, new TGLayoutHints(kLHintsTop|kLHintsLeft|
                                         kLHintsExpandX, 5, 5, 5, 10));
vframe->AddFrame(fHProg3, new TGLayoutHints(kLHintsTop|kLHintsLeft|
                                         kLHintsExpandX, 5, 5, 5, 10));
vframe->Resize(200, 200);
```

### 25.8.11 Static Widgets

The classes `TGLabel` and `TGIcon` show some information - text or graphics. The line below creates a label object. The syntax is very simple: you specify the parent widget and a string object holding the desired text.

```
TGLabel *label = new TGLabel(parentWidget, "Label's string");
```

Next sample creates an icon object. First we create an object of type `TGPicture`. The `TGPicture` objects are never created directly by the application code. We call `TGClient` telling it the pixmap's file name to create a `TGPicture` object and, in turn, it will return a pointer to the created object. If the pixmap file cannot be found the returned pointer will be `NULL`. As usual, the first parameter of a `TGIcon` constructor is the parent frame. The second one is the `TGPicture` object holding the pixmap we want to show. Last two parameters define the width and height of pixmap in pixels. In the end we add the created icon object to its parent.

```
// icon widget
const TGPicture *ipic=(TGPicture *)gClient->GetPicture("leaf.xpm");
TGIcon *icon = new TGIcon(parent, ipic, 40, 40);
parent->AddFrame(icon, new TGLayoutHints(kLHintsLeft|kLHintsBottom,
                                       1, 15, 1, 1));
```

The `TGPicture` objects are cached by `TGClient` in order to keep the resource usage low and to improve the efficiency of the client-server windowing systems. `TGClient` will check whether a pixmap with the same name was already loaded before to register a new picture object. If it finds it, it will return a pointer to the existing object. Also, it will increase the usage counter for the object.

All `TGPicture` objects are managed by the class `TGPicturePool`. `TGClient` creates an object of this type upon initialization. Normally your application program does not deal directly with this class because all manipulations go through `TGClient` class.

Once you have finished with using of the `TGPicture` object, you should call the method `TGClient::FreePicture(const TGPicture *pic)` to free it. The usage counter of the picture object will be decreased and when it reaches zero - the `TGPicture` object will be deleted.

### 25.8.12 Status Bar

The status bar widget is used to display some information about the current application state: what is being viewed in the window, a descriptive message about selected objects, or other non-interactive information. It may also be used to explain highlighted menu and tool bar items.

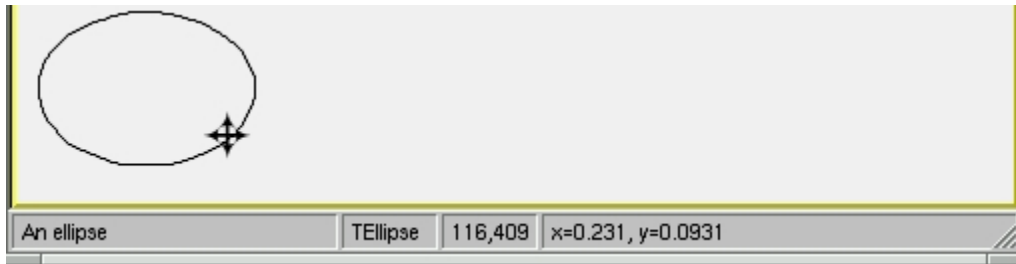

An application can only have one status bar at a time.

There is nothing special to create a status bar in your application. You should decide how many fields you need to present the current application state to the user. By default a status bar consists of one part. Multiple parts can be created by `SetParts` method. Its first parameter is an array of integers that give the percentage size of each part. The second parameter gives the number of status bar parts. Using `SetText` method you can set a text for any part.

```
// status bar
Int_t parts[] = {33, 10, 10, 47};
fStatusBar = new TGStatusBar(fMain,50,10,kHorizontalFrame);
fStatusBar->SetParts(parts,4);
fMain->AddFrame(fStatusBar, new TGLayoutHints(kLHintsBottom |
      kLHintsLeft | kLHintsExpandX, 0, 0, 2, 0));
...
// fill status bar fields with information; selected is the object
// below the cursor; atext contains pixel coordinates info
fStatusBar->SetText(selected->GetTitle(),0);
fStatusBar->SetText(selected->GetName(),1);
fStatusBar->SetText(atext,2);
fStatusBar->SetText(selected->GetObjectInfo(px,py),3);
```

### 25.8.13 Splitters

A window can be split into two parts (panes) by using a horizontal or a vertical splitter. A horizontal splitter resizes the frames above and below of it; a vertical splitter resizes the frames left and right of it.

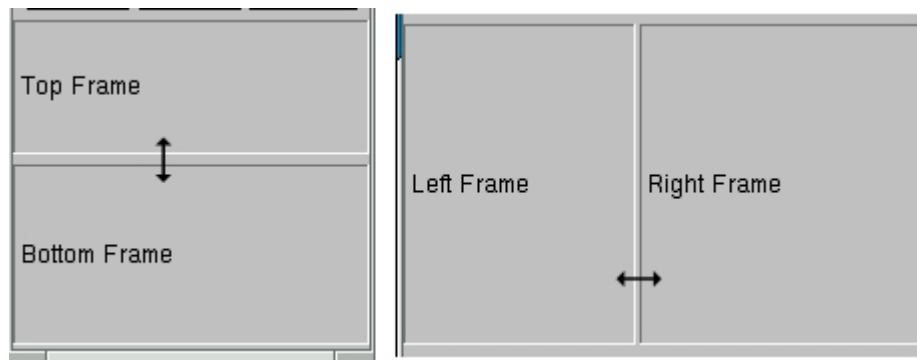

This widget is represented by `TGSplitter`, `TGHSplitter`, and `TGVSplitter` classes. Currently there is no special graphics representation for splitter widgets; only the cursor changes when crossing a splitter.

There is nothing special to create a splitter - two lines of code only:



```
TGHSplitter *hsplitter = new TGHSplitter(fVf);
hsplitter->SetFrame(fH1,kTRUE);
```

You call a horizontal **TGHSplitter** or a vertical **TGVSplitter** splitter constructor and after you set the frame to be resized via **SetFrame** method. In spite of that, there are rules to be followed when you create a splitter in your application.

For a horizontal splitter they are:

- the parent of a horizontal splitter must inherit from **TGCompositeFrame** and must have a vertical layout
- the above resized frame must have **kFixedHeight** option set
- use layout hints **kLHintsTop | kLHintsExpandX** when adding the **above** resized frame to its parent
- use layout hints **kLHintsBottom | kLHintsExpandX | kLHintsExpandY** when adding the bottom resized frame to its parent
- set the **above** frame to be resized using **SetFrame** method; the second parameter should be **kTRUE**

You can see these rules in the code below:

```
// Create horizontal splitter
fVf = new TGVerticalFrame(fMain,10,10);
fH1 = new TGHorizontalFrame(fVf,10,10, kFixedHeight);
fH2 = new TGHorizontalFrame(fVf,10,10);
fFtop = new TGCompositeFrame(fH1,10,10, kSunkenFrame);
fFbottom = new TGCompositeFrame(fH2,10,10,kSunkenFrame);
fLtop = new TGLLabel(fFtop,"Top Frame");
fLbottom = new TGLLabel(fFbottom,"Bottom Frame");

fFtop->AddFrame(fLtop, new TGLayoutHints(kLHintsLeft |
    kLHintsCenterY,3,0,0,0));
fFbottom->AddFrame(fLbottom, new TGLayoutHints(kLHintsLeft |
    kLHintsCenterY,3,0,0,0));
fH1->AddFrame(fFtop, new TGLayoutHints(kLHintsTop |
    kLHintsExpandY | kLHintsExpandX,0,0,1,2));
fH2->AddFrame(fFbottom,new TGLayoutHints(kLHintsTop |
    kLHintsExpandY | kLHintsExpandX,0,0,1,2));
fH1->Resize(fFtop->GetDefaultWidth(),fH1->GetDefaultHeight()+20);
fH2->Resize(fFbottom->GetDefaultWidth(),fH2->GetDefaultHeight()+20);
fVf->AddFrame(fH1, new TGLayoutHints(kLHintsTop | kLHintsExpandX));

TGHSplitter *hsplitter = new TGHSplitter(fVf);
hsplitter->SetFrame(fH1,kTRUE);
fVf->AddFrame(hsplitter,new TGLayoutHints(kLHintsTop |
    kLHintsExpandX));
fVf->AddFrame(fH2, new TGLayoutHints(kLHintsBottom |
    kLHintsExpandX | kLHintsExpandY));
```

For a vertical splitter the rules are:

- the parent of a vertical splitter must inherit from **TGCompositeFrame** and must have a horizontal layout
- the left resized frame must have **kFixedWidth** option set
- use layout hints **kLHintsLeft | kLHintsExpandY** when adding the left resized frame to the parent
- use layout hints **kLHintsRight|kLHintsExpandX |kLHintsExpandY** when adding the right resized frame to the parent
- set the **left** frame to be resized using **SetFrame** method; the second parameter should be **kTRUE**



Next is a sample code for a vertical splitter:

```
// Create vertical splitter
fHf = new TGHorizontalFrame(fMain, 50, 50);
fV1 = new TGVerticalFrame(fHf, 10, 10, kFixedWidth);
fV2 = new TGVerticalFrame(fHf, 10, 10);
fFleft = new TGCompositeFrame(fV1, 10, 10, kSunkenFrame);
fFright = new TGCompositeFrame(fV2, 10, 10, kSunkenFrame);

fLleft = new TGLLabel(fFleft, "Left Frame");
fLright = new TGLLabel(fFright, "Right Frame");

fFleft->AddFrame(fLleft, new TGLayoutHints(kLHintsLeft |
    kLHintsCenterY,3,0,0,0));
fFright->AddFrame(fLright, new TGLayoutHints(kLHintsLeft |
    kLHintsCenterY,3,0,0,0));
fV1->AddFrame(fFleft,new TGLayoutHints(kLHintsTop |
    kLHintsExpandX | kLHintsExpandY,0,0,5,5));
fV2->AddFrame(fFright,new TGLayoutHints(kLHintsTop |
    kLHintsExpandX | kLHintsExpandY, 0, 0, 5, 5));
fV1->Resize(fFleft->GetDefaultWidth()+20, fV1->GetDefaultHeight());
fV2->Resize(fFright->GetDefaultWidth(), fV1->GetDefaultHeight());
fHf->AddFrame(fV1,new TGLayoutHints(kLHintsLeft | kLHintsExpandY));

splitter = new TGVSplitter(fHf,2,30);
splitter->SetFrame(fV1, kTRUE);
fHf->AddFrame(splitter,new TGLayoutHints(kLHintsLeft |
    kLHintsExpandY));
fHf->AddFrame(fV2,new TGLayoutHints(kLHintsRight | kLHintsExpandX |
    kLHintsExpandY));
```

### 25.8.14 TGCanvas, ViewPort and Container

When all display information cannot be presented in a window, the additional information must be found and made visible. A **TGCanvas** is a frame containing two scrollbars (horizontal and vertical) and a viewport (**TGViewPort**). The viewport acts as the window through which we look at the contents of the container frame. A **TGContainer** frame manages a content area. It can display and control a hierarchy of multi-column items, and provides the ability to add new items at any time. By default it doesn't map sub-windows, which are items of the container. In this case sub-window must provide **DrawCopy** method, see for example **TGLVEntry** class. It is also possible to use option which allows mapping sub-windows. This option has much slower drawing speed in case of more than 1000 items placed in container. To activate this option the **fMapSubwindows** data member must be set to **kTRUE** (for example **TTVLVContainer** class).

A scroll bar only is available when scrolling is necessary. It consists of three elements: a slider box and two directional scroll arrows (buttons).

```
fCanvas = new TGCanvas(parent, w, h);
fContents = new TGListTree(fCanvas, kHorizontalFrame);
fContents->Associate(parent);
parent->AddFrame(fCanvas, new TGLayoutHints(kLHintsExpandX |
    kLHintsExpandY));

// or
fCanvas = new TGCanvas(parent, w, h);
fContents = new TGListTree(fCanvas->GetViewPort(),100,100,
    kHorizontalFrame);
fContents->SetCanvas(fCanvas);
fContents->Associate(parent);
fCanvas->SetContainer(fContents);
parent->AddFrame(fCanvas, new TGLayoutHints(kLHintsExpandX |
    kLHintsExpandY));
```

The **TGContainer** class can handle the following keys:

F7, Ctnrl-F activate a search dialog

F3, Ctnrl-G continue to search

End go to the last item in container

Home go to the first item in container

PageUp navigate up

PageDown navigate down

arrow keys navigate inside container

Return/Enter equivalent to double click of the mouse button

Ctrl-A select all items

Space invert selection.

### 25.8.15 Embedded Canvas

This class creates a **TGCanvas** in which a well known ROOT **TCanvas** is embedded. A pointer to the **TCanvas** can be obtained via the `GetCanvas()` member function.

```
fEc1 = new TRootEmbeddedCanvas("ec1", fParent, 100, 100);
fParent ->AddFrame(fEc1, new TLayoutHints(kLHintsExpandX |
                                         kLHintsExpandY));
fEc2 = new TRootEmbeddedCanvas("ec2", fParent, 100, 100);
fParent ->AddFrame(fEc2, new TLayoutHints(kLHintsExpandX |
                                         kLHintsExpandY));

fEc1->GetCanvas()->SetBorderMode(0);
fEc2->GetCanvas()->SetBorderMode(0);
fEc1->GetCanvas()->SetBit(kNoContextMenu);
fEc1->GetCanvas()->Connect("ProcessedEvent(Int_t,Int_t,Int_t,TObject*)",
                          "MyClass", this, "HandleMyCanvas(Int_t,Int_t,Int_t,TObject*)");
```

To embed a canvas derived from a **TCanvas** do the following:

```
TRootEmbeddedCanvas *embed = new TRootEmbeddedCanvas(0, p, w, h);
// note name must be 0, not null string ""
Int_t wid = embed->GetCanvasWindowId();
TCanvas *myc = new TCanvas("myname", 10, 10, wid);
embed->AdoptCanvas(myc);
// the TCanvas is adopted by the embedded canvas and will be
// destroyed by it
```

## 25.9 The ROOT Graphics Editor (GED)

Everything drawn in a ROOT canvas is an object. There are classes for all objects, and they fall into hierarchies. In addition, the ROOT has fully cross-platform GUI classes and provides all standard components for an application environment with common ‘look and feel’. The object-oriented, event-driven programming model supports the modern signals/slots communication mechanism. It handles user interface actions and allows total independence of interacting objects and classes. This mechanism uses the ROOT dictionary information and the CINT the C++ Interpreter to connect signals to slots methods.

Therefore, all necessary elements for an object-oriented editor design are in place. The editor complexity can be reduced by splitting it into discrete units of so-called *object editors*. Any object editor provides an object specific GUI. The main purpose of the ROOT graphics editor is the organization of the object editors’ appearance and the task sequence between them.

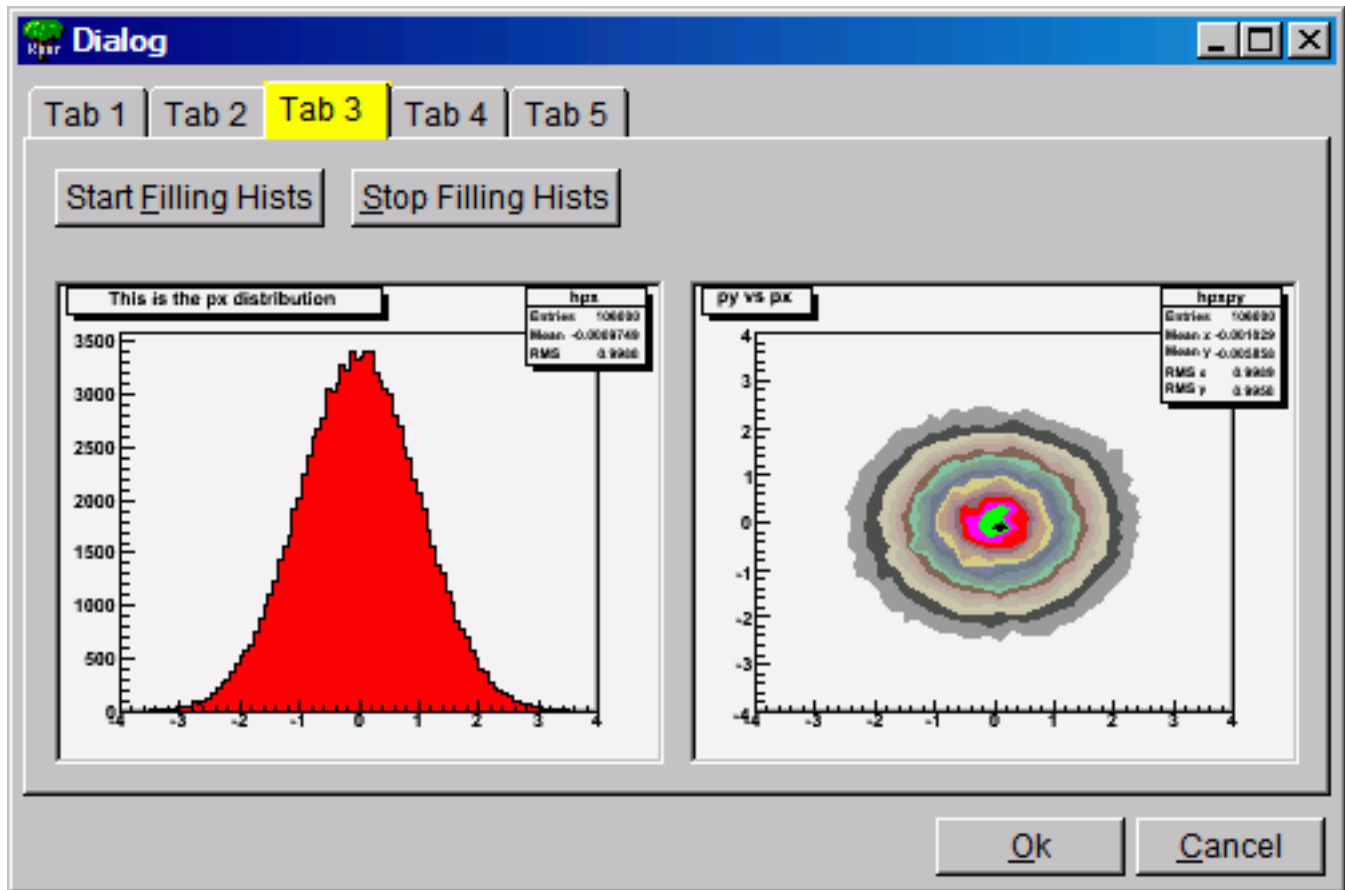

### 25.9.1 Object Editors

Every object editor follows a simple naming convention: to have as a name the object class name concatenated with *'Editor'* (e.g. for **TGraph** objects the object editor is **TGraphEditor**). Thanks to the signals/slots communication mechanism and to the method `DistanceToPrimitive()` that computes a “distance” to an object from the mouse position, it was possible to implement a signal method of the canvas that says which is the selected object and to which pad it belongs. Having this information the graphics editor loads the corresponding object editor and the user interface is ready for use. This way after a click on ‘axis’—the axis editor is active; a click on a ‘pad’ activates the pad editor, etc.

The algorithm in use is simple and is based on the object-oriented relationship and communication. When the user activates the editor, according to the selected object `<obj>` in the canvas it looks for a class name `<obj>Editor`. For that reason, the correct naming is very important. If a class with this name is found, the editor verifies that this class derives from the base editor class **TGedFrame**. If all checks are satisfied, the editor makes an instance of the object editor. Then, it scans all object base classes searching the corresponding object editors. When it finds one, it makes an instance of the base class editor too.

Once the object editor is in place, it sets the user interface elements according to the object’s status. After that, it is ready to interact with the object following the user actions.

The graphics editor gives an intuitive way to edit objects in a canvas with immediate feedback. Complexity of some object editors is reduced by hiding GUI elements and revealing them only on users’ requests.

An object in the canvas is selected by clicking on it with the left mouse button. Its name is displayed on the top of the editor frame in red color. If the editor frame needs more space than the canvas window, a vertical scroll bar appears for easy navigation.

### 25.9.2 Editor Design Elements

The next rules describe the path to follow when creating your own object editor that will be recognized and loaded by the graphics editor in ROOT, i.e. it will be included as a part of it.

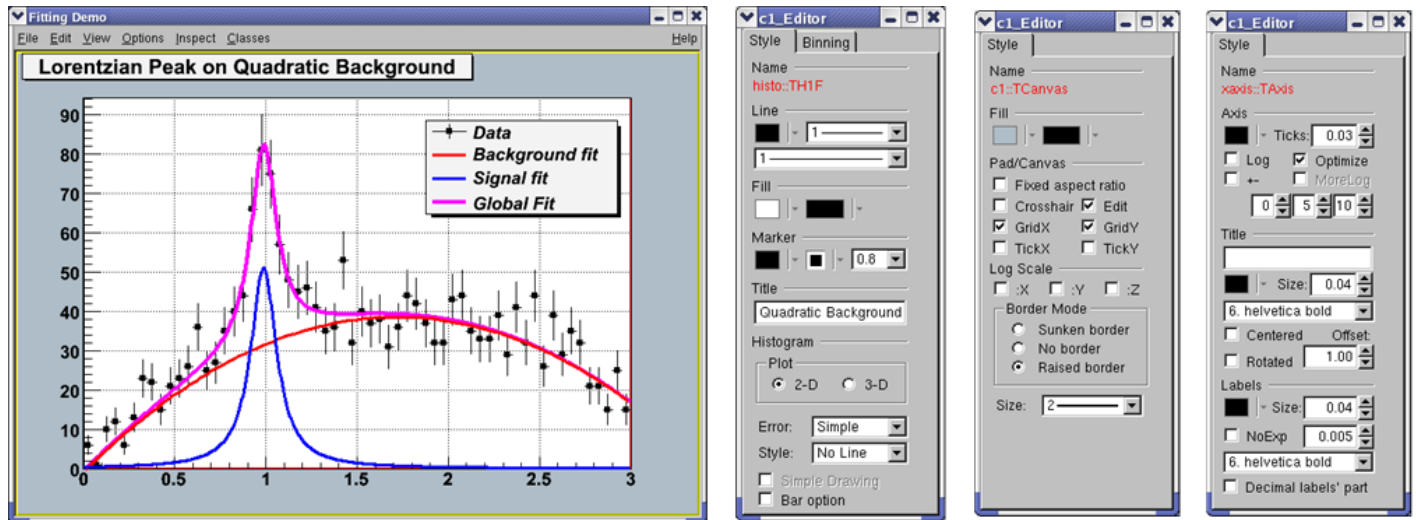

Figure 25.4: Histogram, pad and axis editors

- Derive the code of your object editor from the base editor class **TGedFrame**.
- Keep the correct naming convention: the name of the object editor should be the object class name concatenated with the word 'Editor'.
- Provide a default constructor.
- Use the signals/slots communication mechanism for event processing.
- Implement the virtual method `SetModel(TObject *obj)` where all widgets are set with the current object's attributes. This method is called when the editor receives a signal from the canvas saying that an object is the selected.
- Implement all necessary slots and connect them to appropriate signals that GUI widgets send out. The GUI classes in ROOT are developed to emit signals whenever they change a state that others might be interested. As we noted already, the signals/slots communication mechanism allows total independence of the interacting classes.

### 25.9.2.1 Creation and Destruction

GED-frames are constructed during traversal of class hierarchy of the selected object, executed from method `TGedEditor::SetModel()`. When a new object of a different class is selected, the unneeded GED-frames are cached in memory for potential reuse. The frames are deleted automatically when the editor is closed.

Note: A deep cleanup is assumed for all frames put into the editor. This implies:

- do not share the layout-hints among GUI components;
- do not delete child widgets in the destructor as this is done automatically.

### 25.9.2.2 Using Several Tabs

Sometimes you might need to use several tabs to organize properly your class-editor. Each editor tab is a resource shared among all the class-editors. Tabs must be created from the constructor of your editor-class by using the method:

```
TGVerticalFrame* TGedFrame::CreateEditorTabSubFrame(const Text_t *name),
```

It returns a pointer to a new tab container frame ready for use in your class. If you need to hide/show this frame depending on the object's status, you should store it in a data member. See for examples: `TH1Editor`, `TH2Editor`.

### 25.9.2.3 Base-Class Editors Control

Full control over base-class editors can be achieved by re-implementing virtual method `void TGedFrame::ActivateBaseClassEditors(TClass* c1)`. It is called during each compound editor rebuild and the default implementation simply offers all base-classes to the publishing mechanism.

To prevent inclusion of a base-class into the compound editor, call:

```
void TGedEditor::ExcludeClassEditor(TClass* class, Bool_t recurse)
```

Pointer to the compound GED-editor is available in `TGedFrame`'s data-member:

```
TGedEditor *fGedEditor
```

Ordering of base-class editor frames follows the order of the classes in the class hierarchy. This order can be changed by modifying the value of `TGedFrame`'s data member `Int_t fPriority`. The default value is 50; smaller values move the frame towards to the top. This priority should be set in the editor constructor.

## 25.10 Drag and Drop

Drag and Drop support is introduced for Linux (via Xdnd - the drag and drop protocol for X window system) and for Windows (via Clipboard). Users can select something in ROOT with a mouse press, drag it (moves the mouse while keeping the mouse button pressed) and release the mouse button someplace else. When the button is released the selected data is "dropped" at that location. This way, a histogram from an opened ROOT file in the browser can be dragged to any `TCanvas`.

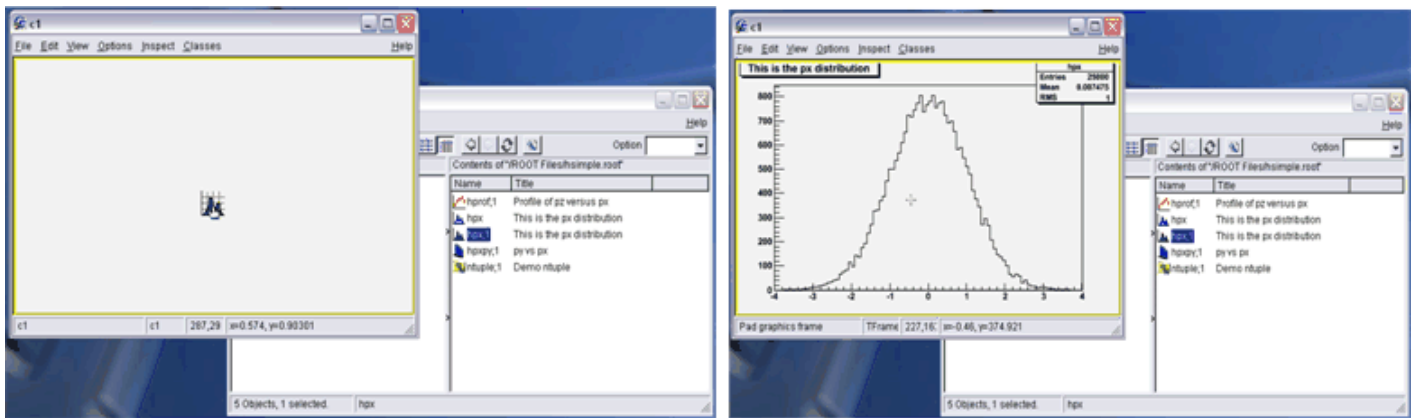

A script file from the browser can be dropped to a `TGTextView` or `TGTextEdit` widget in `TGTextEditor`.

On Linux, it is possible to drag objects between ROOT and an external application. For example to drag a macro file from the ROOT browser to the Kate editor. On Windows, drag and drop works only within a single ROOT application (for the time being), but works also from Windows Explorer to `TCanvas` or to `TGTextEdit`.

### 25.10.1 Drag and Drop Data Class

The Drag and Drop Data class `TDNDdata` is used to describe and handle the transferred data during an drag and drop operation. It consists of:

`Atom_t fDataType`: atom describing the data type.

`Atom_t fAction`: atom describing the action (copy, move, link); currently, only copy is used.

`void *fData`: actual data (buffer).

`Int_t fDataLength`: length (size) of data buffer.

Currently two types are recognized by ROOT: “application/root” for ROOT objects and “text/uri-list” for path/filenames (uri comes from Unique Resource Identifier). A text/uri-list is a standard file listing format for drag and drop that specifies a list of files (each file per line). Each line ends with a carriage return and newlinern. File names have to be valid, url-encoded URI’s as shown below:

```
file://localhost/usr/bin/opera or file://localhost/c:/programs/myfile.txt
file://server/data/software.xml or http://root.cern.ch/root/images/ftpstats.gif
```

The atoms and the drag and drop manager (**TGDNDManager**), are created at the main application creation time (class **TGMainFrame**).

Setting a Drag Source - first, create and fill data:

```
TH1F *h = new TH1F("h", "h", 1000, -3, 3);
h->FillRandom("gaus", 50000);
TDNDdata data;
TBufferFile *buf = new TBufferFile(TBuffer::kWrite);
buf->WriteObject(h);
data.fData = buf->Buffer();
data.fDataLength = buf->Length();
data.fDataType = gVirtualX->InternAtom("application/root");
```

Then, set a GUI widget as DND Source, and associate the data. Source widget can be any class inheriting from **TGFrame**.

```
SourceWidget=new TGIcon(this, gClient->GetPicture("f1_s.xpm"), 32, 32);
SourceWidget->SetDNDSource(kTRUE);
SourceWidget->SetDNDdata(&data);
```

Setting A Drop Target - set the widget as DND Target, and set the DND types it must be aware of: as **SourceWidget**, **TargetWidget** can be any class inheriting from **TGFrame**.

```
TargetWidget = new TRootEmbeddedCanvas("Target", this, 700, 400);
TargetWidget->SetDNDTarget(kTRUE);
gVirtualX->SetDNDaware(TargetWidget->GetId(),
                      gDNDManager->GetTypeList());
```

**gDNDManager->GetTypeList()** returns the list of types recognized by ROOT.

Note that the Widget may receive drag and drop messages with drop-data it does not understand, and thus it should only accept drops of the proper type.

## 25.10.2 Handling Drag and Drop Events

Once a widget has been set as DND Target, it has to handle Drag and Drop events.

**Atom\_t HandleDNDEnter(Atom\_t \*typelist)** - this method is used to handle a drag operation entering the widget. The **typelist** parameter is the list of types the data contains. If the list contains one type the widget understands, it should return this type to notify the manager that the drop would be accepted, i.e. :

```
for (int i = 0; typelist[i] != kNone; ++i) {
    if (typelist[i] == gVirtualX->InternAtom("application/root"))
        // accept "application/root" DND type
        return typelist[i];
}
// other type not accepted
return kNone;
```

**Atom\_t HandleDNDposition(Int\_t x, Int\_t y, Atom\_t action, Int\_t xroot, Int\_t yroot)**- this method should be used to handle the drag position in widget coordinates (x,y) or in root coordinates (xroot,yroot).

```

// get the pad over which the cursor is
TPad *pad = fCanvas->Pick(x, y, 0);
if (pad) {
    pad->cd();
    gROOT->SetSelectedPad(pad);
}
return action;

```

Bool\_t HandleDNDdrop(TDNDdata data) - *this is the place where the widget actually receives the data. First, check the data format (see description of `**TDNDData`\* - Drag and Drop data class) and then use it accordingly. In the case of ROOT object, here is an example of how to retrieve it:*

```

if (data->fDataType == gVirtualX->InternAtom("application/root")) {
    TBufferFile buf(TBuffer::kRead, data->fDataLength,
                   (void *)data->fData);
    buf.SetReadMode();
    TObject *obj = (TObject *)buf.ReadObjectAny(TObject::Class());
    if (obj->IsA()->GetMethodAllAny("Draw"))
        obj->Draw();
}

```

In the case of URI/list, the use is:

```

if (data->fDataType == gVirtualX->InternAtom("text/uri-list")) {
    TString sfname((char *)data->fData);
    TUrl uri(sfname.Data());
    if (sfname.EndsWith(".jpg"))
        TImage *img = TImage::Open(uri.GetFile());
}

```

Bool\_t HandleDNDleave() is used if a specific action has to be performed when the drag operation leaves the widget.





# Chapter 26

## ROOT/Qt Integration Interfaces

### 26.1 Qt-ROOT Implementation of TVirtualX Interface (BNL)

Qt-ROOT implementation of **TVirtualX** (Qt-layer) is to provide a convenient way of creating the complex end-user applications that require both Qt GUI and ROOT features. The primary goal is to allow “embedding” the ROOT classes like **TCanvas** and **TPad** into the arbitrary Qt widgets and using it seamlessly with other Qt-based components and Qt-based third party libraries. **TGQt** ROOT class, a Qt-based implementation of **TVirtualX** interface is an optional ROOT component. The implementation was developed and is supported by the collaboration at [Brookhaven National Laboratory](#).

#### 26.1.1 Installation

##### 26.1.1.1 Qt Package Installation and Configuration

ROOT Qt-layer requires a “good” properly configured Qt package version. To install it, one has to:

1. Make sure the adequate version of Qt system. Even though Qt ROOT implementation theoretically can work with any Qt release version 3.xx, we found the earlier versions of the package not reliable and recommend installing the Qt version 3.3 or higher. The package was tested against Qt 4.3 also (Qt 4.3 and higher versions contain some features introduced by TrollTech to back the ROOT applications).
2. Check the Qt package configuration and its compilation options are consistent with those used to compile and install ROOT alone. For Qt 3.x, we recommend configuring Qt as follows:

```
./configure -thread -no-xft -qt-gif -no-exceptions
```

I.e. one is required to build the Qt version with the “thread” support and with “no exceptions”. Generally, you are free to select the remaining Qt options like the types of the different image formats provided etc. You can check the Qt installation parameters by looking up the file:

```
more $QTDIR/config.status
```

No special flag for Qt 4.3 build and higher have been set yet to make QtRoot working.

3. Attention. The Qt port for 4.3 and above versions should be considered as an experimental one. Most examples in this manual are for Qt version 3.3 and they need to be adjusted for Qt 4.3.x.

##### 26.1.1.2 Qt-layer Installation

The Qt-layer is included into the ROOT distribution kit. To install it one has to configure ROOT. The installation does not change any other components of the ROOT package. It produces several extra-shared libraries that may be dynamically loaded into the ROOT session at start time with the regular ROOT plug-in mechanism to replace the “native” GUI interface. To install Qt-layer one should follow the ROOT installation procedure providing the QTDIR environment variable points to the proper version of Qt system. Many Linux flavors come with the pre-installed Qt. May sure you are not going to pick the obsolete version.

```
% cd root
% ./configure <target> --enable-qt
% gmake
% gmake install
```

### 26.1.1.3 Qt Main C++ Classes CINT Dictionary

The ROOT CINT dictionary allows to call the Qt main classes directly from the ROOT command prompt is an optional component and it is not created during the “Qt-layer installation”. To build / re-build the Qt main classes ROOT dictionary one can invoke the make

```
% cd root
% gmake qtcint
```

The dictionary contains so-called Qt main classes as defined by TrollTech on the Web page: <http://doc.trolltech.com/3.3/mainclasses.html>. The dictionary is NOT loaded automatically and it should be loaded by the user ROOT macro as needed.

### 26.1.1.4 Qt-layer Configuration

Any ROOT-based application should be configured to use Qt-layer using ROOT “Environment Setup”. The correct `QTDIR` environment variable to locate the proper version of Qt package should be provided as well. There are several ways to customize the ROOT setup environment to activate Qt-layer.

Look up at `$ROOTSYS/etc/system.rootrc`. Find there the definition of `Gui.Backend` and `Gui.Factory`:

```
# GUI specific settings
Gui.Backend:          native
Gui.Factory:          native
```

Now you can either edit the file `$ROOTSYS/etc/system.rootrc` or provide your own custom `.rootrc` redefine the options:

```
# GUI specific settings
Gui.Backend:          qt
Gui.Factory:          qt
```

If you need to switch often from native layer to qt one back and force you may find convenient to define the type of GUI using some external environment variable defining options indirectly:

```
# GUI specific settings
Gui.Backend:          $(GUI)
Gui.Factory:          $(GUI)
```

The last step is to make sure your `LD_LIBRARY_PATH` variable point to the `$QTDIR/lib` directory. Optionally, you can define the Qt Widget “look and feel” using the option `Gui.Style` option. The number of different styles to choose from is defined by your local Qt installation. Usually you can choose from “window”, “motif”, “cde”, “motifplus”, “platinum”, “sgi”, “compact”, “windowsxp”, “aqua” or “macintosh”. For example, the option defined below will force the “windows” look and feel on any platform.

```
# Qt GUI style setting
Gui.Style:            windows
```

The default style is so-called “native” style. That is defined by the current application environment.

## 26.1.2 Applications

As soon as you customize ROOT “Environment Setup” to use Qt-layer you can start any ROOT session or stand-alone ROOT-based applications and ... even though your applications will be using the Qt package you should not see any difference. This merely means if the only thing you want to do is just use ROOT or some ROOT-based stand-alone application “as is” then you probably do not need to switch to Qt-layer and should skip this section entirely. It is recommended you communicate the lower graphical layer via the generic **TVirtualX** interface provided by the global **gVirtualX**.

### 26.1.2.1 Qt-based ROOT Applications

“ROOT application” is the application that either instantiates the ROOT **TApplication** / **TRint** class and enters the ROOT event loop or is the shared library that can be loaded into the already running ROOT application via **TSystem::Load** method or via ROOT plug-in mechanism. You must neither initialize Qt **QApplication** nor enter the Qt event loop. Qt-layer takes care about these two steps. What you need is to instantiate the Qt object of your choice and to keep playing ROOT rules.

```
#include <TRint.h>
#include <qpushbutton.h>
int main( int argc, char **argv ) {
    // Create an interactive ROOT application
    TRint *theApp = new TRint("Rint", &argc, argv);
    // Create Qt object within ROOT application
    QPushButton hello( "Hello world!", 0 );
    hello.resize( 100, 30 );
    hello.show();
    // and enter the ROOT event loop...
    theApp->Run();
}
```

Under UNIX, you can build the stand-alone ROOT HelloWorld Qt-based application with the command

```
g++ `root-config --cflags --glibs` -I$QTDIR/include -L$QTDIR/lib
    -lqt-mt HelloWorld.cxx -o HelloWorld
```

### 26.1.2.2 ROOT-based Qt Applications

“Qt application” is the application that either instantiates the Qt **QApplication** and enters the Qt event loop or is the shared library that can be loaded into the already running Qt application via Qt plug-in mechanism. You must neither initialize ROOT **TApplication** / **TRint** nor enter the ROOT event loop. Qt-layer takes care about both of these steps. What you need is just to instantiate the embedded and regular ROOT objects of your choice and keep playing Qt rules. ROOT-based Qt applications treat the “native” style of the ROOT **Gui.Backend** and **Gui.Factory** parameters as “qt”. For example,

```
// Minimal ROOT based Qt example
#include <qapplication.h>
#include "TGraph.h"
#include "TQtWidget.h"
#include "TCanvas.h"

int main( int argc, char **argv ) {

    QApplication *app = new QApplication(argc, argv);
    TQtWidget *MyWidget= new TQtWidget(0,"MyWidget");
    // Create any other Qt-widget here
    MyWidget->show();
}
```

```

MyWidget->GetCanvas()->cd();
TGraph *mygraph;
float x[3] = {1,2,3};
float y[3] = {1.5, 3.0, 4.5};
mygraph = new TGraph(3,x,y);
mygraph->SetMarkerStyle(20);
mygraph->Draw("AP");
MyWidget->GetCanvas()->Update();
app->exec();
return 0;
}

```

The code above can be converted into the running application using qmake, TrollTech provided, build utility. As soon as you have qmake project file `HelloCanvas.pro`:

```

# Automatically generated by qmake (1.07a) Sun Jun 26 02:03:47 2005
# Adjusted by hand to include $ROOTSYS/include/rootcint.pri file

```

```

TEMPLATE = app thread
CONFIG -= moc
INCLUDEPATH += .

# include "by hand" the qmake include file from
# ROOT distribution to define
# 1. include path to the ROOT system header files
# 2. the list of the ROOT shared libraries to link
# Qt application against of
# 3. qmake rules to generate ROOT/Cint dictionaries

include("$(ROOTSYS)/include/rootcint.pri")

# Input
SOURCES += HelloCanvas.cxx

```

You can get the running ROOT-based Qt application with the Unix shell commands:

```

qmake HelloCanvas.pro
make
HelloCanvas

```

### 26.1.2.3 Qt Project for Creation of ROOT Shared Libraries with Qt Components and ROOT Dictionaries

It is possible and desirable to create the ROOT-based Qt application with TrollTech provided qmake utility. To do that one should include one qmake include file, namely, `$ROOTSYS/include/rootcint.pri` with one extra line in the project file (as the example above has revealed). The include file defines all necessary components one needs to compile and link the healthy Qt application against of the ROOT shared libraries. It contains the qmake rules to create the ROOT/CINT dictionary from the list of the provided header files.

For example, we may convert the stand-alone Qt-based ROOT application above into C++ class with `RootCint` dictionary, that one loads into the interactive ROOT session and invokes interactively. This task requires four simple files.

1. Class dictionary definition file `LinkDef.h`:

```

#ifdef __CINT__
#pragma link off all globals;
#pragma link off all classes;
#pragma link off all functions;

```

```
#pragma link C++ class TMyQButton;

#endif
```

2. Class header file TMyQButton.h:

```
#ifndef ROOT_TMyQButton
#define ROOT_TMyQButton
#include "Rtypes.h"

class QPushButton;
class TVirtualPad;

class TMyQButton {
private:
    QPushButton *fMyButton;
public:
    TMyQButton(const char*name="");
    virtual ~TMyQButton();
    void SetSize(UInt_t w, UInt_t h);
    void Show(Bool_t show=kTRUE);
    void SetText(const char *text);
    void SetOn(Bool_t on=kTRUE);
    void SetStyle(const char * style);
};
#endif
```

3. Class implementation file TMyQButton.cxx:

```
#include "TMyQButton.h"
#include <qpushbutton.h>

// This class allow you to create and manipulate the QPushButton
// interactively
TMyQButton::TMyQButton(const char *name) {
    // Create Qt QPushButton interactively
    fMyButton = new QPushButton(name,0);
}

TMyQButton::~TMyQButton() { delete fMyButton; }

void TMyQButton::SetSize(UInt_t w, UInt_t h) {
    // Resize the Qt button
    fMyButton->resize(w,h);
}

void TMyQButton::Show(Bool_t show) {
    // Show / hide the button
    if (show) fMyButton->show();
    else fMyButton->hide();
}

void TMyQButton::SetText(const char *text) {
    // Set / change the button text
    fMyButton->setText(text);
}

void TMyQButton::SetOn(Bool_t on) {
    fMyButton->setOn(on);
}
```

```
void TMyQPushButton::SetStyle(const char * style) {
    // Set button's look and feel
    // The possible styles are defined by the local Qt installation.
    // For example the possible style can be: "window", "motif",
    // "cde", "sgi", "motifplus", "platinum", "compact", "windowsxp",
    // "aqua", "macintosh"
    fMyButton->setStyle(style);
}

```

4. qmake project file MyQPushButton.pro:

```
TEMPLATE = lib dll thread
# Input
HEADERS += TMyQPushButton.h
SOURCES += TMyQPushButton.cxx

CREATE_ROOT_DICT_FOR_CLASSES = $$HEADERS LinkDef.h
include("$(ROOTSYS)/include/rootcint.pri")

```

At this point, you are ready to produce the class-shared library with the ROOT/CINT dictionary by invoking two shell commands (as above):

```
qmake MyQPushButton.pro
make

```

In addition, get you class into the interactive Root session:

```
root[] gSystem->Load("lib

```

Please, pay your attention that class implementation does not contain any Qt system initialization call. Since the above example is a ROOT application, do not forget, one needs the `.rootrc` file to assign “qt” value for the options `Gui.Backend` and `Gui.Factory`.

Note: Do not mix the ROOT GUI and Qt GUI API within the same class implementation.

#### 26.1.2.4 Using Qt “Designer” to Create Qt GUI with Embedded ROOT Objects

Qt package is equipped with [Qt designer](#) - a powerful tool to create the high quality, robust GUI interfaces for your applications. It is possible and desirable to use this utility to create the ROOT-based Qt GUI. To do that one should add the `$(ROOTSYS)/include/rootcint.pri` in the project file generated by designer and configure Qt designer to use the so-called “custom widget” defined by `$(ROOTSYS)/include/TQtWidget.cw`. The file defines the custom `TQtWidget` Qt widget to back the embedded `TCanvas` objects. To customize your designer start `designer` and select “Edit Custom Widget” menu:

Open “Edit Custom Widget” dialog and load the `TQtWidget` (“embedded” `TCanvas`) widget definition into the designer. One should do this at once. Designer will remember the last configuration and will be restoring it for all subsequent designer sessions.

Now, you can create your shining GUI interface that contains `TCanvas` / `TPad` object with all features of these famous ROOT classes.

We strongly recommend you to read the “Quick Start” section of the Qt designer manual <http://doc.trolltech.com/3.3/designer-manual.html>. One can find further information, the examples of the working ROOT-based Qt projects including all examples of this section as well as the list of the references and publications on the Qt project Web site <http://root.bnl.gov>

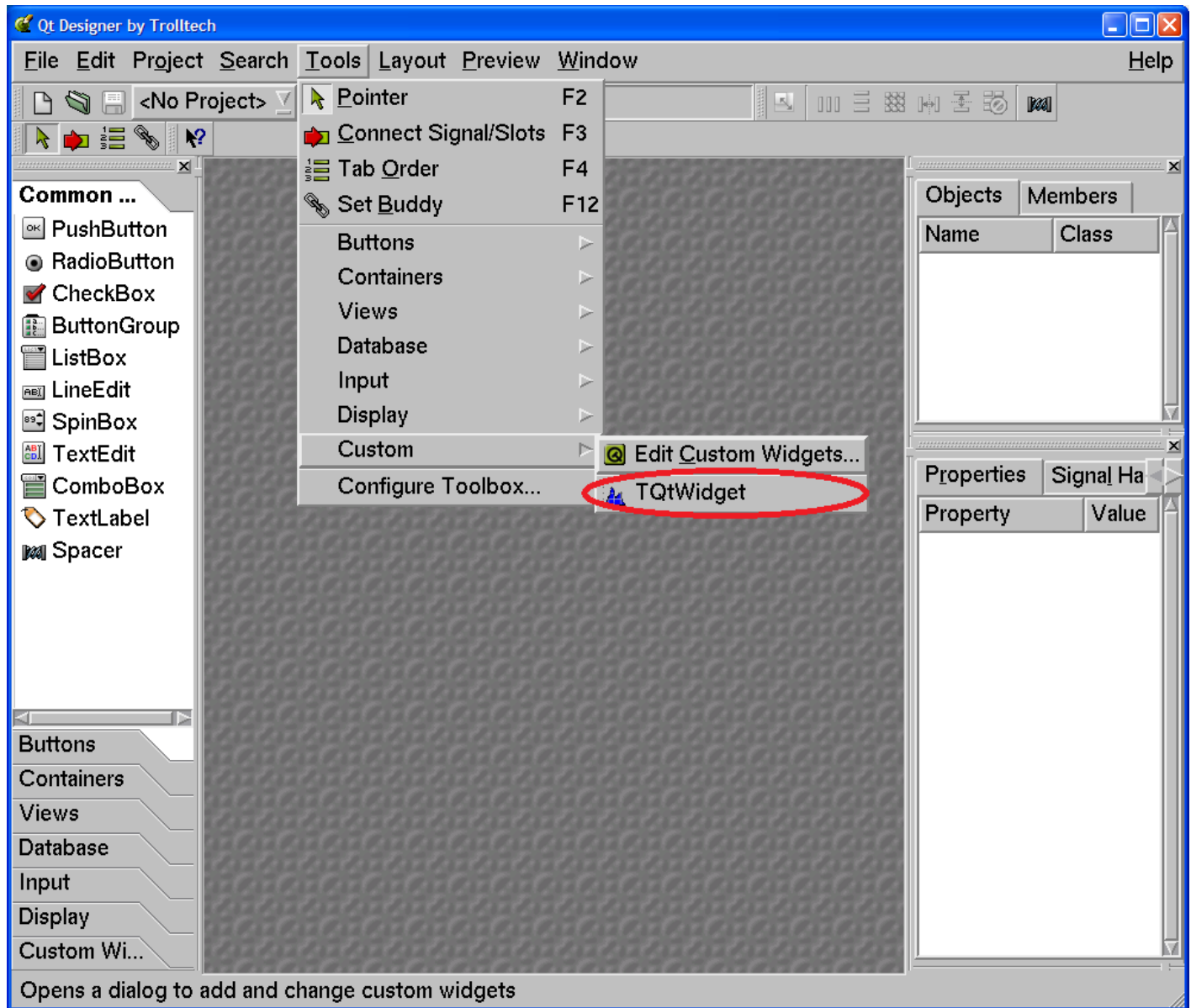

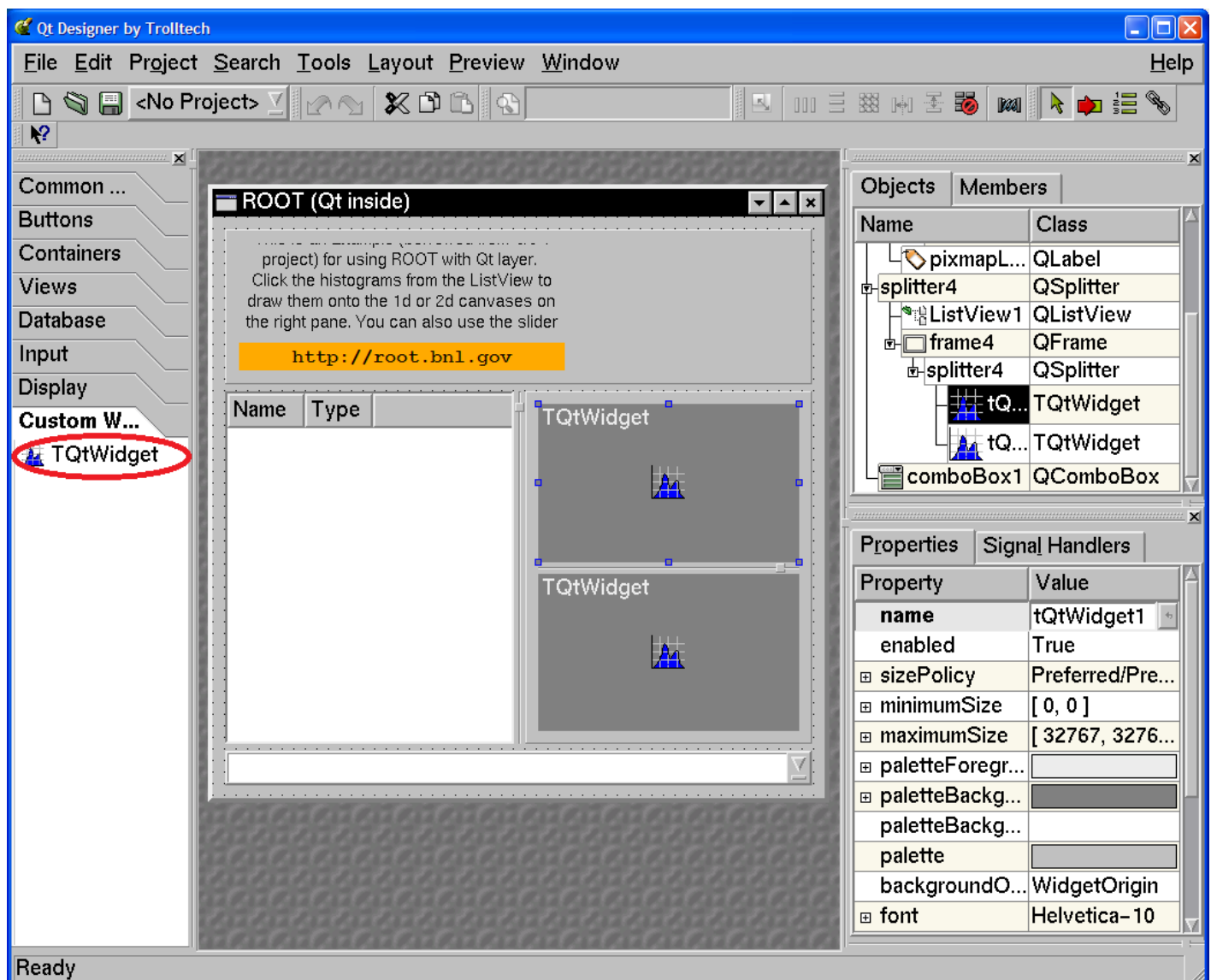
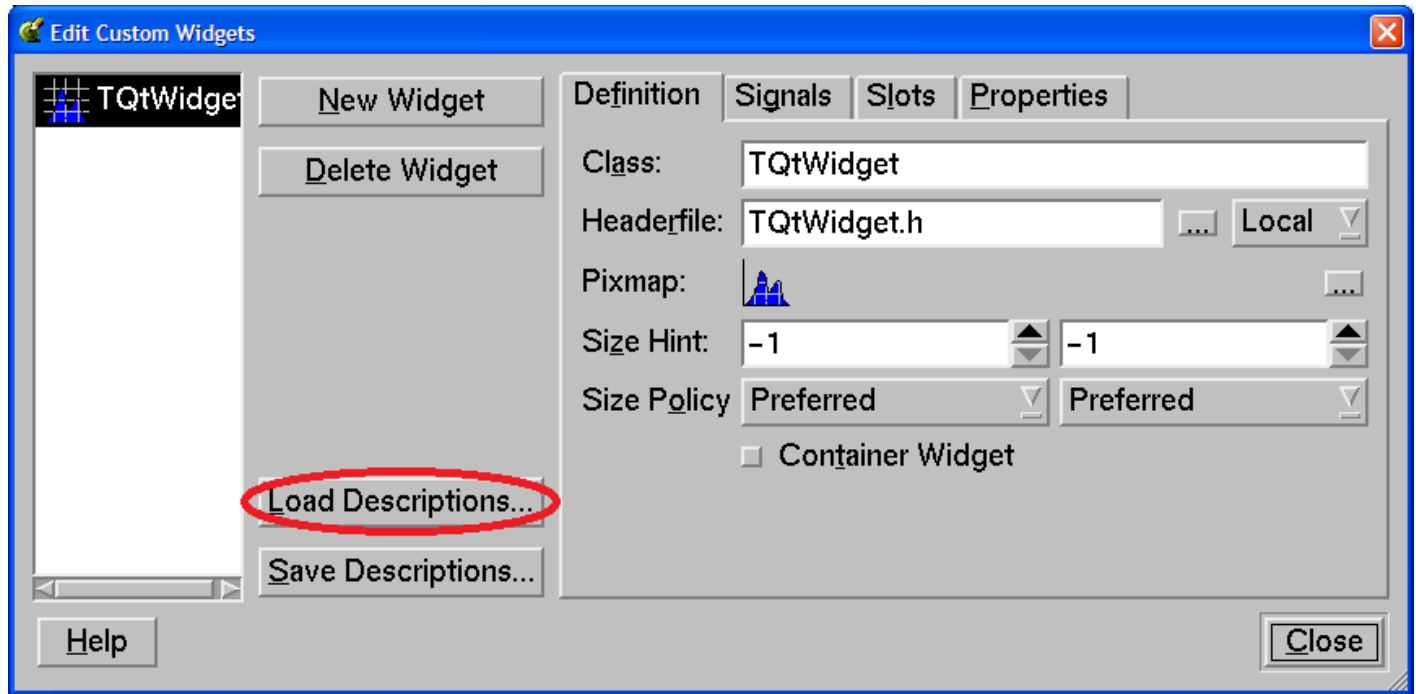



### 26.1.2.5 Using Qt Class Library from the ROOT C++ Interpreter

Since the Qt package is a regular C++ class library to use it within ROOT C++ interpreter environment one should either load the dedicated RootCint dictionary or apply ACLiC mode.

For example, the following ROOT interactive session is to popup the “Open File” Qt dialog box and print out the file name selected by the user via the dialog.

```
root[] gSystem->Load("qtcint");
root[] cout << QFileDialog::getOpenFileName() << endl;
```

The ROOT session:

```
root[] gSystem->Load("qtcint");
root[] QPainter p;
root[] p.setup(); // Display the Qt "Setup printer" dialog box
root[] Int_t id = gPad->GetPixmapID();
root[] QPixmap *pix = (QPixmap *) (TGQt::iwid(id));
root[] QPainter pnt(&p);
root[] pnt.drawPixmap(0,0,*pix);
```

is to display the Qt “Setup Printer” dialog and use QPainter object to print the current TPad image to the selected printer. To use the more complex Qt-related code one is advised to apply “ACLiC - Automatic Compiler of Libraries for CINT” (see CINT the C++ Interpreter). For example:

```
#ifndef __CINT__
# include <qfiledialog.h>
# include <qstringlist.h>
# include <qstring.h>
#endif
void FileDialog() {
    // This is small ACLiC wrapper to use Qt 3.3 QFileDialog class
    // See: http://doc.trolltech.com/3.3/qfiledialog.html#getOpenFileNames
    // To use, invoke ACLiC from the ROOT prompt:
    // root [] .x FileDialog .C++
    QStringList files = QFileDialog::getOpenFileNames ();
    QStringList::Iterator it = files.begin();
    while ( it != files.end() ) {
        printf ("Next file selected: %sn", (const char *) (*it));
        ++it;
    }
}
```

With the ROOT ACLiC session:

```
root [0] .x FileDialog.C++
Info in <TUnixSystem::ACLiC>: creating shared library macros/./FileDialog_C.so
Next file selected: macros/QtFileDialog.C
Next file selected: macros/QtMultiFileDialog.C
Next file selected: macros/QtMultiFileDialog_C.so
Next file selected: macros/QtPrintDialog.C
Next file selected: macros/QtPrintDialog_C.so
```

the Qt generated “Open File Dialog” pops up and prints out the list of the selected files.

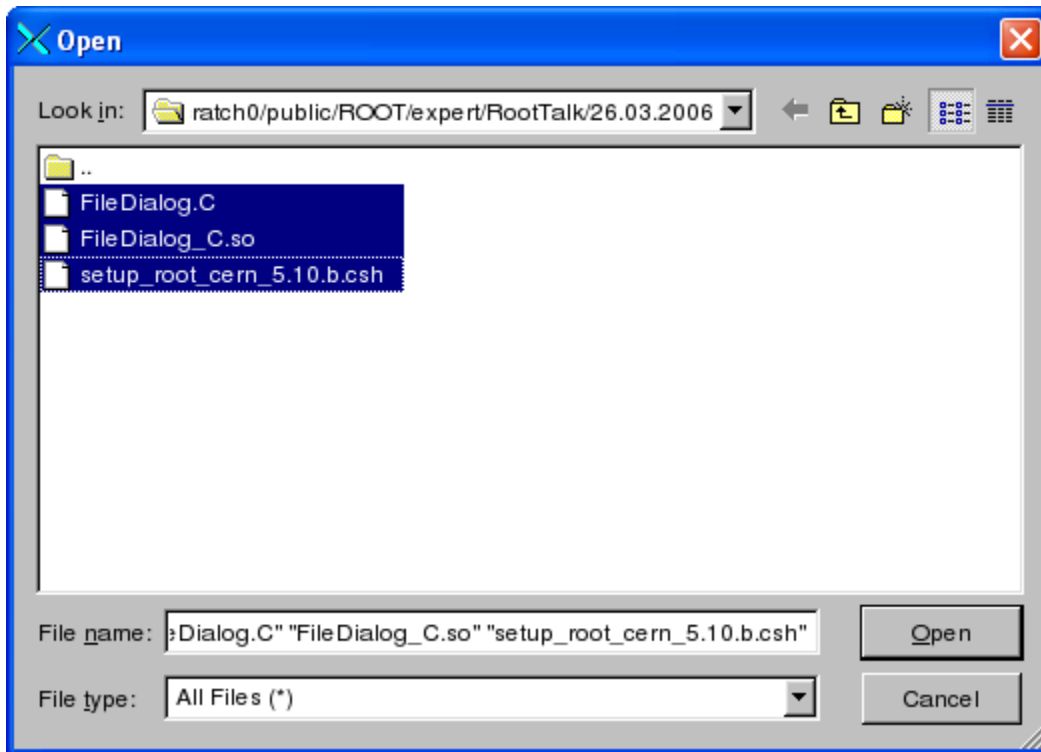

### 26.1.3 TQtWidget Class, Qt Signals / Slots and TCanvas Interface

**TQtWidget** is a **QWidget** with the **QPixmap** double buffer. It is designed to back the ROOT **TCanvasImp** class interface and it can be used as a regular Qt Widget to create Qt-based GUI with the embedded **TCanvas** objects. It was mentioned the class can be used as a “custom widget” to create the advanced GUI with the TrollTech “designer” utility.

To do that **TQtWidget** class can emit the set of the “Qt signals” and it is equipped with the collection of the dedicated “Qt slots”.

#### 26.1.3.1 TQtWidget Public Qt Slots

**TQtWidget** class inherits all slots of its base **QWidget** class (see: <http://doc.trolltech.com/3.3/qwidget.html>). In addition, it is in possession of two groups of the dedicated slots.

```
virtual void cd();
virtual void cd(int subpadnumber);
```

Make the associated **TCanvas/TPad** the current one, the proxy interface to the embedded **TCanvas::cd()** and **TCanvas::cd(int subpadnumber)** methods.

```
virtual bool Save(const QString &fileName) const
virtual bool Save(const char *fileName) const
virtual bool Save(const QString &fileName, const char *format,
                 int quality=60) const
virtual bool Save(const char *fileName, const char *format,
                 int quality=60) const
```

The slots are to save the double buffer of the **TQtWidget** object using the default or specified save format. The default save format is defined either by the “known” file extension or by the “default” file format.

The default format can be changed by **TQtWidget::SetSaveFormat** method and it is set to be “PNG” at the class constructor.

### 26.1.3.2 TQtWidget Qt Signals

The class object emits the different signals that can be used to create the sophisticated GUI applications.

The signal `CanvasPainted()` is emitted to notify the GUI that the double buffer of the widget has been filled and buffer has been painted onto the screen. In the other words, this signal means that all `TObject` objects of the embedded `TCanvas` have been visualized on the screen. The signal:

```
Saved(bool ok)
```

is emitted to notify the GUI that a `TCanvas` has been saved into the file:

```
RootEventProcessed(TObject *selected, unsigned int event, TCanvas *c)
```

This signal notifies the Qt framework that the Qt mouse/keyboard event has been process by ROOT. The signal is disabled by default, i.e. the connected slot is not called unless the signal is explicitly enabled with `TQtWidget::EnableSignalEvents` method.

For example, to create a custom response to the mouse crossing of a `TCanvas`, you need to connect the `RootEventProsecced` signal with your qt slot. The next piece of the code demonstrates that:

```
connect(tQtWidget, SIGNAL(RootEventProcessed(TObject *,
                                     unsigned int, TCanvas *)),
        this, SLOT(CanvasEvent(TObject *, unsigned int, TCanvas *)));
. . .
void qtrootexample1::CanvasEvent(TObject *obj, unsigned int event,
                                 TCanvas *)
{
    TQtWidget *tipped = (TQtWidget *)sender();
    const char *objectInfo = obj->GetObjectInfo(tipped->GetEventX(),
        tipped->GetEventY());
    QString tipText ="You have ";
    if (tipped == tQtWidget1)
        tipText += "clicked";
    else
        tipText += "passed";
    tipText += " the object <";
    tipText += obj->GetName();
    tipText += "> of class ";
    tipText += obj->ClassName();
    tipText += " : ";
    tipText += objectInfo;

    QWhatsThis::display(tipText)
}
```

## 26.2 GSI QtROOT

The Qt Interface developed at Darmstadt GSI is a lightweight interface that enables the user to write a Qt 3 application, which can use ROOT. The Native Qt 4 support is planned and will be available in the near future. Furthermore, existing Qt 3 Application can use this interface to have almost full access to the Root functionality (see “Create the Main file for the project” below). Using this interface a full access to both ROOT and Qt widgets is possible in one application.

An Embedded Root canvas can be set inside any Qt widget by C++ calls or using the Qt designer. To use the Qt 3.x designer to make ROOT applications with Qt GUI’s follow the steps described below:

- 1) Add the `TQRootCanvas` to the Qt Designer:

- Start the designer
- In the designer menu choose tools->custom->Edit Custom Widget
- In the Edit Custom Widget window choose “Load Description”
- From GSI Qt-Root interface directory load the file “TQRootCanvas.cw”

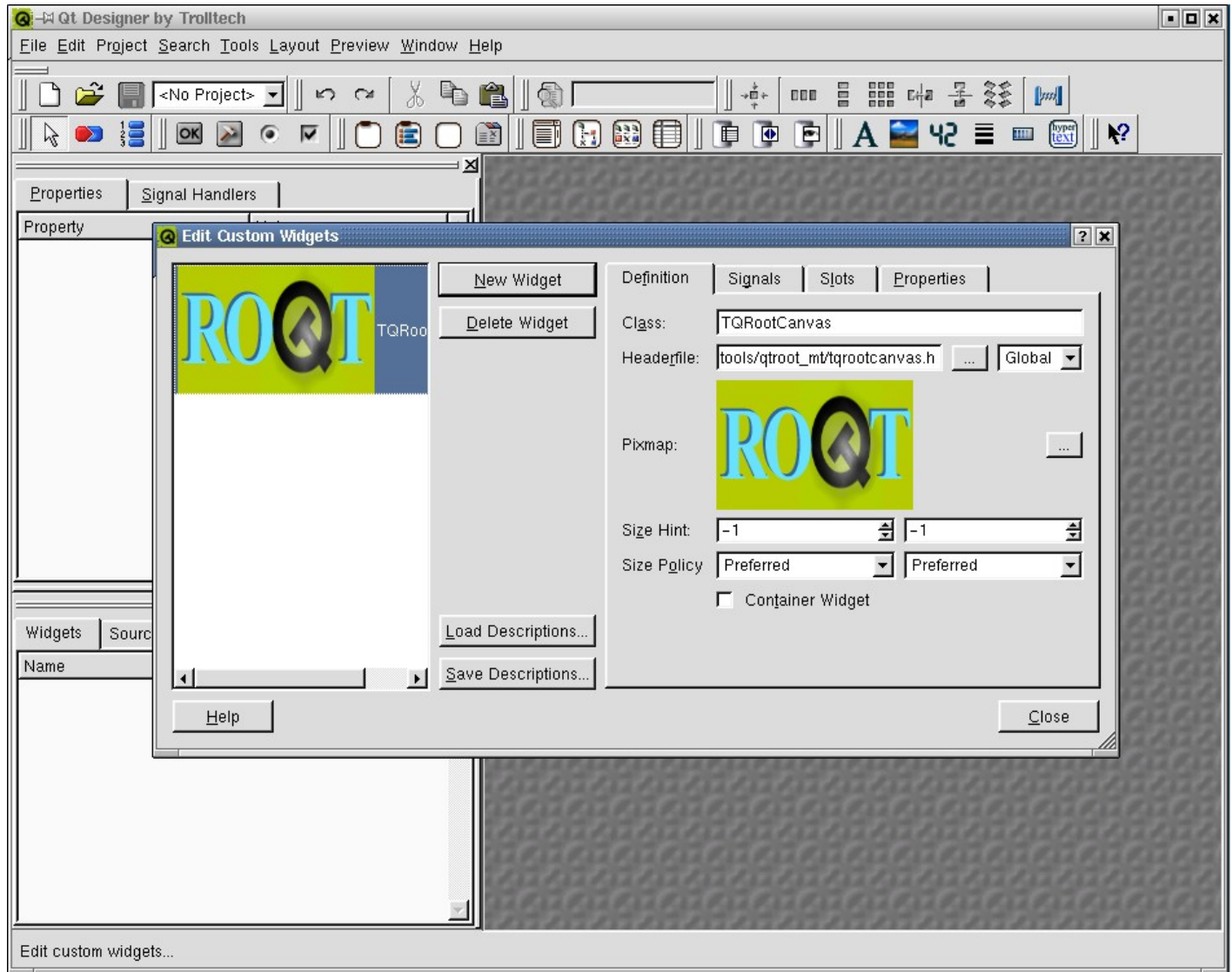

Now you will see the **TQRootCanvas** in the Class field, you will also see all other parameters, signals, slots and properties of the **TQRootCanvas**.

Now we are ready use the **TQRootCanvas** within the Qt 3.x designer.

### 26.2.1 Create a New Project in the Designer

- 1). Choose “File->New”
- 2). Select C++ Project
- 3). Create the Project in a directory of your choice.
- 4). In the project settings (Project->Setting from the designer main window) select the C++ tab. Add ROOT and GSI Qt-Root libraries into the Libs entry field. For example:

```
-L(ROOTSYS)/lib -lCore -lCint -lHist -lGraf -lGraf3d -lGpad -lTree -lRint -lPostscript -lMatrix
-lPhysics -lnsl -lm -ldl -rdynamic -lqtgsi
```

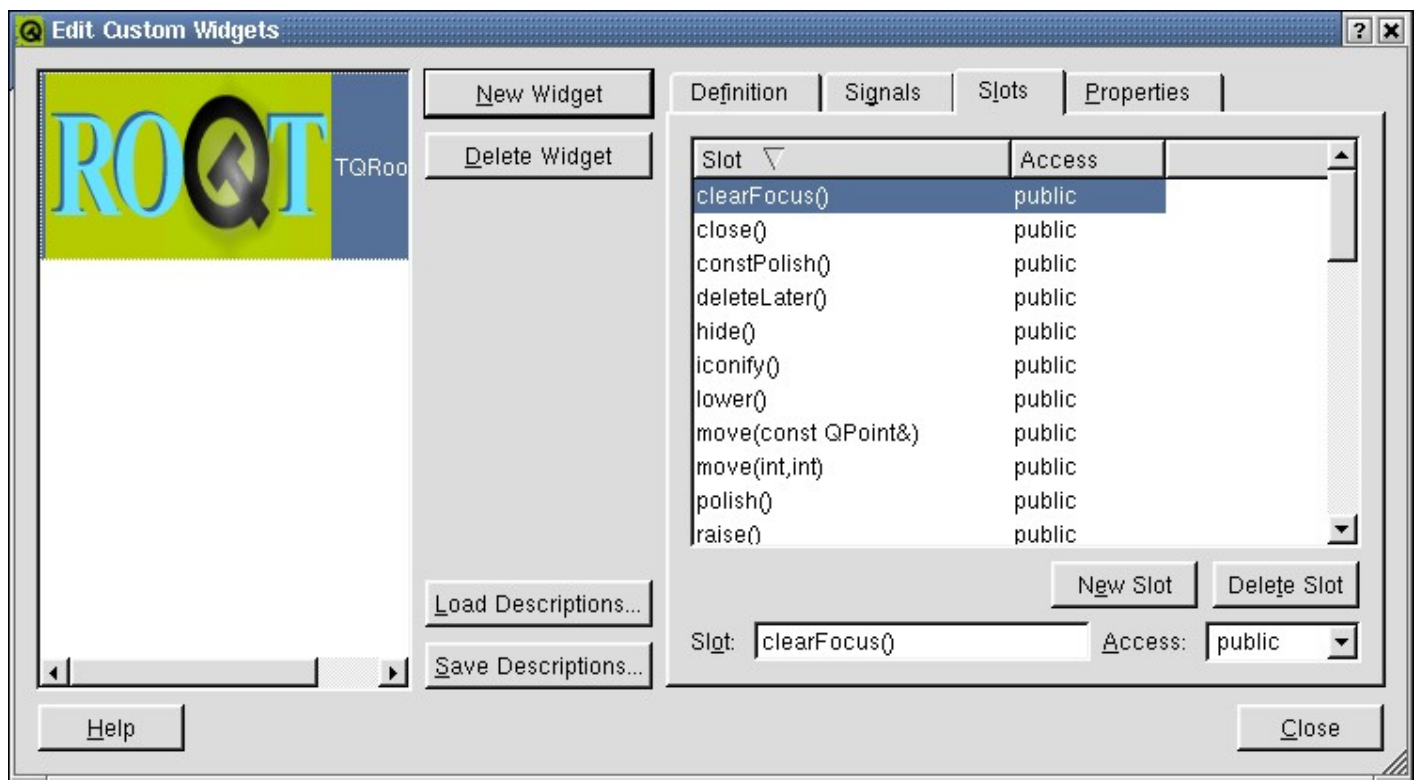
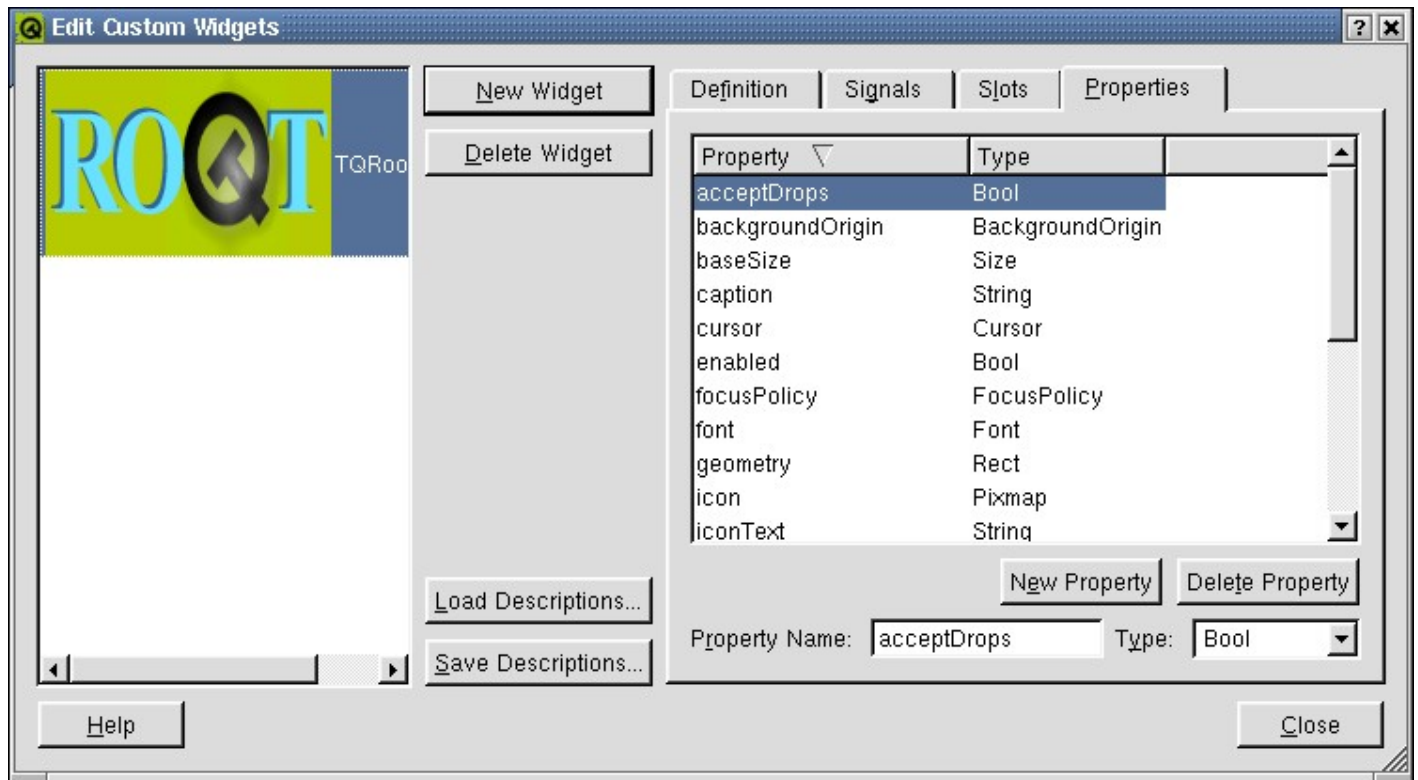

Add `$(ROOTSYS)/include` into Includepath entry field.

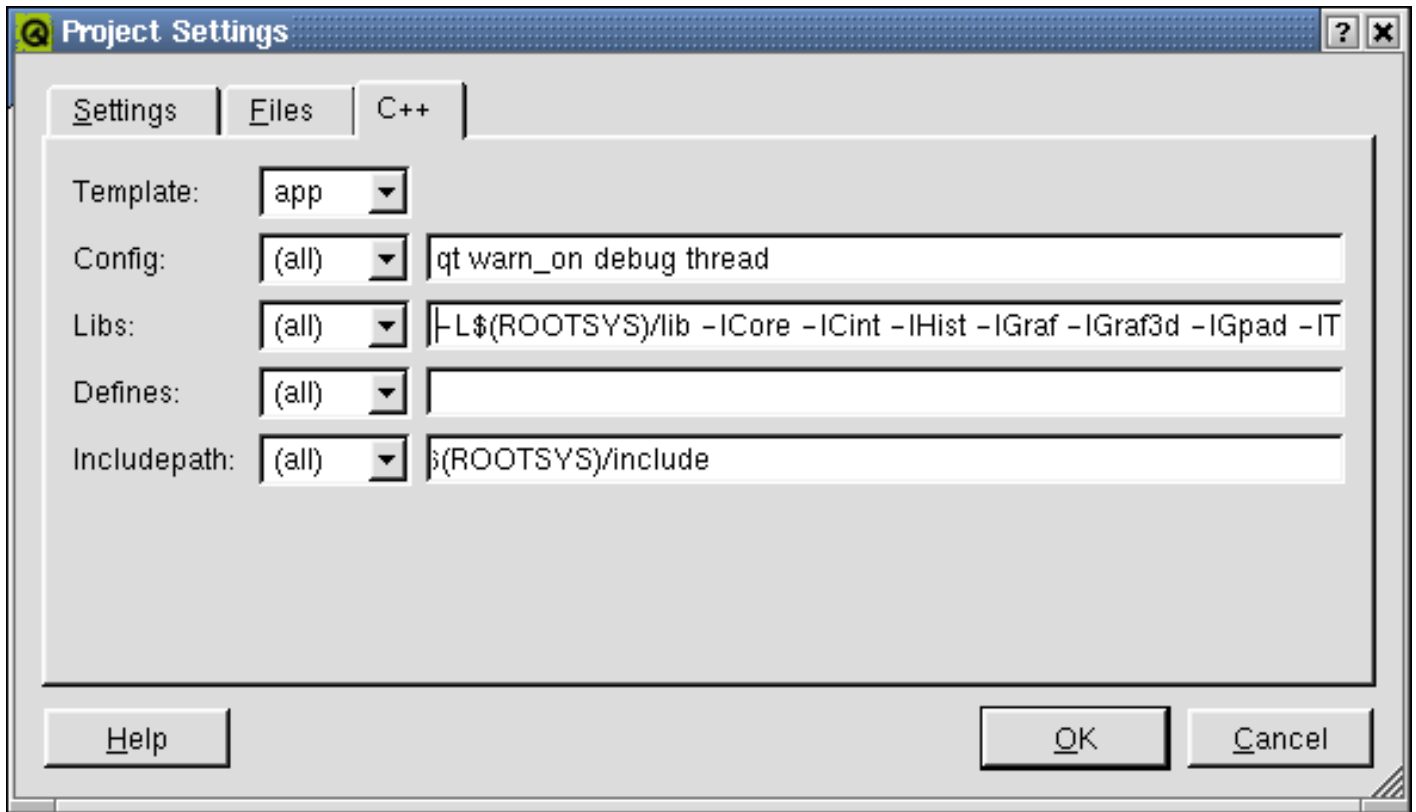

These settings will be saved in `project.pro` file and `qmake` will generate the `Makefile` according to them. Now you can create your own widgets in the designer and add them to the project.

### 26.2.2 main()

The main file should look like:

```
#include "TQtApplication.h"
#include "TQtRootApplication.h"
#include "MyWidget1.h"
int main( int argc, char ** argv ){
    TQtRootApplication a( argc, argv, 0);
    TQtApplication app("uno",&argc,argv);
    MyWidget1 *w = new MyWidget1;
    w->show();
    a.connect(&a, SIGNAL(lastWindowClosed()), &a, SLOT(quit()));
    return a.exec();
}
```



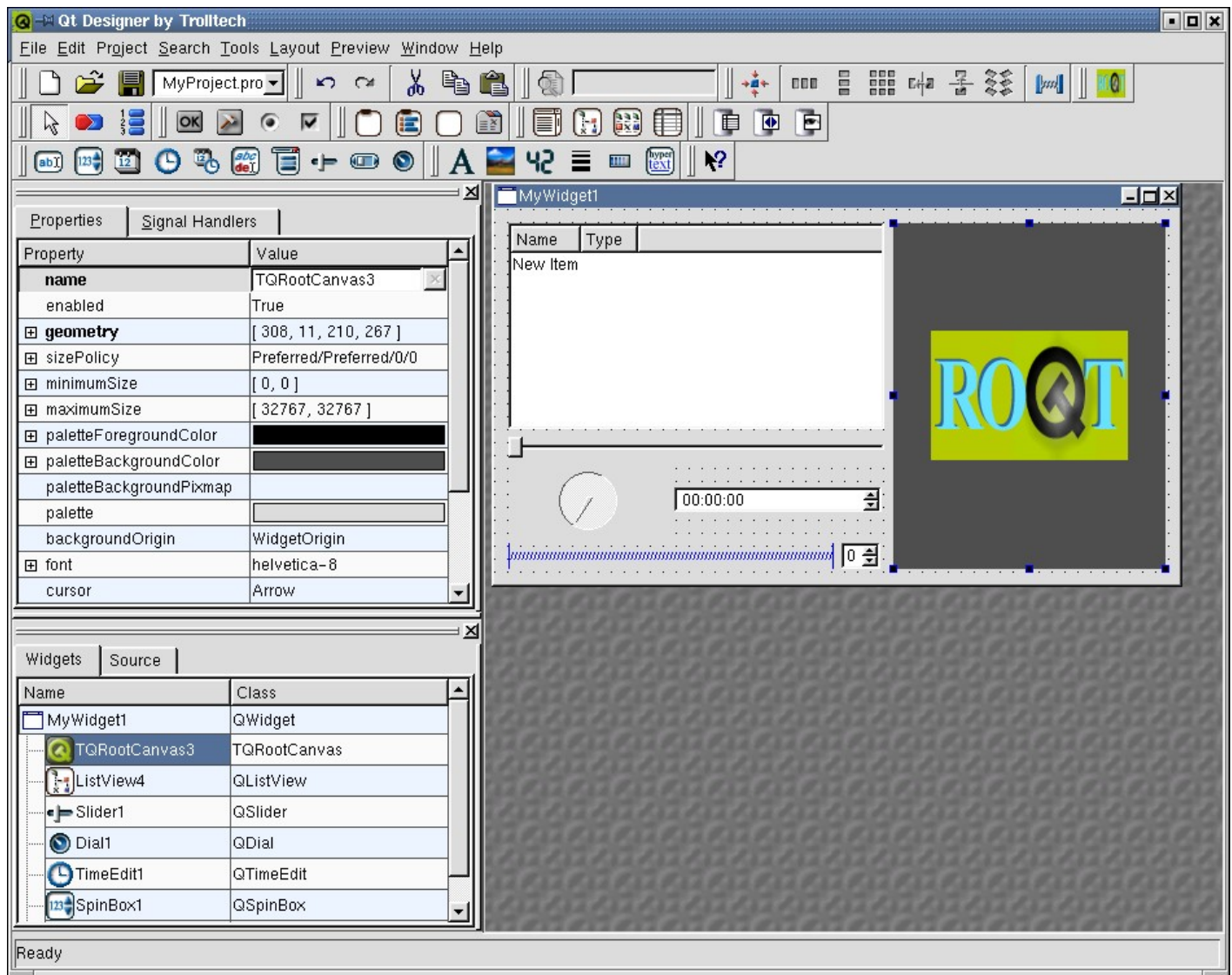





# Chapter 27

## Automatic HTML Documentation

**THtml** is ROOT's documentation engine. It can be used to document your classes in a reference guide, and to convert your text or source files to HTML.

### 27.1 Reference Guide

The Reference Guide for the ROOT classes at <http://root.cern.ch/root/html/> has been generated by ROOT's **THtml** class. Just as for ROOT's classes, it can generate (and update) a reference guide for your classes, too. You document your classes using source code comments. All comments will be automatically put into a `<pre></pre>` environment to keep the indentation and line length. You can write "raw" HTML by enclosing comments in the keywords `Begin_Html` and `End_Html`.

To generate documentation for the class **TObject** you could run the following commands:

```
root [] THtml h
root [] h.SetInputDir("${ROOTSYS}");
root [] h.MakeClass("TObject");
root [] h.CreateJavascript();
root [] h.CreateStylesheet();
```

The comments following the first comment of the form `//_____`, before any method, is assumed to be the **class description**. As with any other documentation part, it has to be a continuous block of comments.

Any documented class will have an **class index entry** in the `ClassIndex.html`, showing their name with a link to their documentation page and a miniature description. This description for e.g. the class `MyClass` has to be given in `MyClass`'s header file as documentation.

A **method description** block starts immediately after `{` and looks like this:

```
void TWorld::HelloWorldFunc(string *text)
{
// This is a documentation example of the function TWorld::HelloWorldFunc
helloWorld.Print(text);
}
```

Like in a class description block, everything until the first non-commented line is considered as a valid member function description block.

**Data members** are documented by putting a C++ comment behind their declaration in the header file, e.g.

```
Int_t fIAmADataMember; // this is a data member
```

When documenting a class, `THtml` creates both a “beautified” version of the source file and a web page containing the class documentation. The documentation also shows the **author** and a **copyright statement**. This information is extracted from the source file. The author can be in the format

```
// Author: Enrico Fermi
```

for people that have an entry in CERN’s XWho database, and for those who have not:

```
// Author: Enrico Fermi <mailto:enrico@fnal.gov>
```

The copyright statement is introduced by the string “\* Copyright” inside a comment.

You should read the class reference page at <http://root.cern.ch/root/html/THtml.html> to learn about all of `THtml`’s features.

### 27.1.1 Product and Module Documentation

For `THtml`, a product like ROOT is a combination of several modules. It can include user-provided document for both products and modules. The name of the product can be set by calling `THtml::SetProductName()`. By default, the documentation is searched for in the `doc/` subdirectory of the source tree, and in the `../doc` directory, relative to the directory of first source file of a module. This can be set by calls to `THtml::SetProductDocDir()` and `THtml::SetModuleDocPath()`.

The documentation is generated as an index page with links to further files. This index page includes the file `index.txt` converted to HTML (via `THtml::Convert()`) or the file `index.html` (without conversion to HTML, of course), if any of these files exist. The index page will also contain a list of links to all files in the directory that end on `.html` or `.txt`. Files ending on `.txt` will be converted to HTML before they are copied to the output directory. For each file, the link’s text will be the file name without extension, with underscores replaced by spaces.

You can see an example of the module documentation including links, the corresponding `index.html`, and the module class index at [http://root.cern.ch/root/html/HIST\\_Index.html](http://root.cern.ch/root/html/HIST_Index.html).

## 27.2 Converting Sources (and Other Files) to HTML

`THtml` can take a file (C++ or text) and convert it to HTML. There are two main use cases:

The output of a **macro** converted to HTML will almost look like the beautified source file of a class reference. The `Begin_Html/End_Html` keywords are supported; comments, strings, and keywords are colored like in `THtml`’s output for source code.

The macro `Event.cxx` in `$ROOTSYS/test` can be seen as an example of documented ROOT macros at <http://root.cern.ch/root/html/examples/Event.cxx.html>

`THtml::Convert()` converts a single text file to HTML. For example, it can be run on a change log. Each known class name will be linked to its documentation page. An example is ROOT’s change log at <http://root.cern.ch/root/html/examples/V5.16.txt.html>

To convert the source file `MyCode.C` to HTML, you can run

```
root [] THtml h
root [] h.Convert("MyCode.C", "Look At My Code", "htmlout/");
```

This will create the file `htmlout/MyCode.C.html`. The HTML page will have the title “Look At My Code”.

### 27.3 Special Documentation Elements: Directives

A common documentation problem is the inclusion of images. They are usually generated externally, which poses problems with where to keep the images, and how to keep them up to date. `THtml` solves this by offering a few special documentation elements: macro and latex directives.

### 27.3.1 Latex Directive

Documentation surrounded by the keywords `BEGIN_LATEX` / `END_LATEX` will be passed to ROOT Latex engine `TLatex`. The keywords can be written with small or capital letters (case insensitive). The output will be stored to an image file, which gets automatically included in the documentation.

```
// This function calculates BEGIN_LATEX
// F(x_{\frac{1}{2}}) = \prod(x < x_{\frac{1}{2}}) = \frac{1}{2}
// END_LATEX
```

T<sub>Html</sub> will inject the following picture:

$$F(x_{\frac{1}{2}}) = \prod(x < x_{\frac{1}{2}}) = \frac{1}{2}$$

The image file name is generated from the formula and will be unique for all the documentation. It is stored along-side the documentation, and it will be automatically regenerated when the documentation is updated. The handling of the Latex directive is done by the class `TDocLatexDirective`.

The `BEGIN_LATEX` keyword can take the following parameters:

- `fontsize`: sets the `TLatex` font size. The default value is 16.
- `separator`: sets a list of characters for which a new column will be started. This allows aligned, multi-line, multi-column layout, which can be useful for e.g. mathematical derivations. It is unset by default, meaning the Latex directive will only generate one column.
- `rseparator`: like separator, but a regular expression. Columns start with a match of this regular expression. Only one of separator or rseparator can be given.
- `align`: defines the alignment of the columns. Note that the column delimiter counts as a column itself!

Example invocation, where the font size is set to 10, new columns are started by the characters '=' and ',', and the two columns are left aligned with the separator column centered:

```
Begin_Latex(fontsize=10, separator='=',', align=lcl)
```

### 27.3.2 Macro Directive

A more general approach is offered by the Macro directive, enclosed in the keywords `BEGIN_MACRO` / `END_MACRO`. The keywords can be written with small or capital letters (case insensitive). If the text enclosed by these keywords contains the character '{' the text is assumed to be source code. Otherwise it is assumed to be a file name relative to the current file's path, and taking into account the paths specified by `THtml::AddMacroPath()`. **The macro file or the C++ source is executed when generating the documentation. It is expected to return a T<sub>Object</sub>\***, which will be saved to a GIF file, by calling the virtual function `TObject::SaveAs()`.

The `BEGIN_MACRO` keyword can take the following parameters:

- `GUI`: will end batch mode. This is needed e.g. for creating screen shots of GUI elements, where the call to `TObject::SaveAs()` will invoke `TGObject::SaveAs()` which needs the graphics system to be initialized.
- `source`: requests the source of the macro to be shown in a second tab on the HTML page. This is useful e.g. for example macros, showing how the image was generated. Lines that should be executed but not shown in the source tab can be hidden by ending them with `*HIDE*` (most probably as a comment). Lines may be hidden because they are not needed for the understanding of the macro or because they only make sense in the context of the documentation, like the statement returning the `TObject*`.

Example invocation, with enabled ROOT graphics system and a source tab:

```
Begin_Macro(gui, source)
```

## 27.4 Customizing HTML

**THtml** allows a vast amount of customizations, from a custom style to custom links, to customized java scripts. By default, the style sheet is taken from `$ROOTSYS/etc/html/ROOT.css` when the documentation is generated. The path for `ROOT.css` can be changed by calling `THtml::SetEtcDir()`; it should contain the same CSS classes and entity IDs as the original `ROOT.css`. This style sheet is an easy means of customizing the layout and appearance of the documentation pages. Many of **THtml** setting can be customized by calls to **THtml** member functions or by settings in `.rootrc`, as documented in the **THtml** class reference page <http://root.cern.ch/root/html/THtml>. The following will enumerate some of the highlights.

### 27.4.1 Referencing Documentation for other Libraries

When **THtml** generates documentation for classes it recognizes all class names known to ROOT. If **THtml** does not have sources for a class it determines the class's library name. This has to be set by means of `rootmap` files, see Library Autoloading of this User's Guide. Given the library name, **THtml** searches for an entry in its map of libraries to documentation URLs. If it finds it, it will create a link to the documentation at that URL for all occurrences of a given class name. One can set the URL `./mylib/` for a library name `MyLib` by setting `Root.Html.MyLib: ./mylib/` or by calling `THtml::SetLibURL("MyLib", "./mylib/")`. Occurrences of class `MyClass` of `MyLib` will now be referenced as `./mylib/MyClass.html`.

### 27.4.2 Search Engine

**THtml** can invoke external search engines. The ROOT reference guide sets `Root.Html.Search` to <http://www.google.com/search?q=%s+site%3A%u>. Calling `THtml::SetSearchStemURL()` will set the same. If this URL stem is set, **THtml** will create search fields in the index pages. It will send the words entered in these search fields as `%s` in the URL; `%u` will be replaced by the current document's path, allowing a site- and directory-specific search.

### 27.4.3 ViewCVS

Most code is managed in a version control system like CVS. ViewCVS is a WWW reader interface to the versioning control system that allows e.g. tracking a file's changes. **THtml** will reference these pages automatically if the `.rootrc` variable `Root.Html.ViewCVS` is set to the URL stem of the ViewCVS installation. Alternatively, one can call `THtml::SetViewCVS()`.

### 27.4.4 Wiki Pages

In some contexts it might be desirable to let users comment on classes, e.g. for suggestions of use or alternatives, details of behavior, and cross references to other relevant classes. A successful example of this is the PHP.net documentation with its user annotations. **THtml** can include a link to a class's Wiki page by setting the Wiki base URL via `Root.Html.WikiURL` or `THtml::SetWikiURL()`.

## 27.5 Tutorial

You can run the tutorial `htmllex.C` to see how **THtml** converts a script to HTML and how it creates the corresponding class reference:

```
root[] .x $(ROOTSYS)/tutorials/htmllex.C+
```

Have a look at the HTML version of the macro in `htmldoc/htmllex.C.html` (which should be the same as the one at <http://root.cern.ch/root/html/examples/htmllex.C.html>).

It demonstrates how to generate documentation for your classes and for ROOT classes and how to “beautify” a macro.

## Chapter 28

# Appendix A: Install and Build ROOT

### 28.1 License

ROOT is made available under the LGPL v2.1 license. For full details see the file LICENSE in the ROOT distribution.

### 28.2 Installing ROOT

To install ROOT you will need to go to the ROOT website at: <http://root.cern.ch/drupal/content/downloading-root>

You have a choice to download the binaries or the source. The source is quicker to transfer since it is only 31 MB, but you will need to compile and link it. The binaries range from 50 MB to 100 MB depending on the target platform.

### 28.3 Choosing a Version

The ROOT developers follow the principle of “release early and release often”, however a very large portion of a user base requires a stable product therefore generally three versions of the system is available for download - new, old and pro:

- The *new* version evolves quickly, with weekly or bi-weekly releases. Use this to get access to the latest and greatest, but it may not be stable. By trying out the new version you can help us converge quickly to a stable version that can then become the new pro version. If you are a new user we would advice you to try the new version.
- The *pro* (production) version is a version we feel comfortable with to exposing to a large audience for serious work. The change rate of this version is much lower than for the new version, it is about 3 to 6 months.
- The *old* version is the previous pro version that people might need for some time before switching the new pro version. The old change rate is the same as for pro.

### 28.4 Installing Precompiled Binaries

The binaries are available for downloading from <http://root.cern.ch/drupal/content/downloading-root>. Once downloaded you need to unzip and de-tar the file. For example, if you have downloaded ROOT v5.30 for Linux-SLC5:

```
% gunzip root_v5.30.00.Linux-slc5-gcc4.3.tar.gz
% tar xvf root_v5.30.00.Linux-slc5-gcc4.3.tar
```

This will create the directory root. Before getting started read the file README/README. Also, read the Introduction chapter for an explanation of the directory structure.

## 28.5 Installing the Source

You have a choice to download a compressed (tar ball) file containing the source, or you can use the Subversion (svn) source code change control system and check out the most recent source. The compressed file is a one time only choice; every time you would like to upgrade you will need to download the entire new version. Choosing the CVS option will allow you to get changes as they are submitted by the developers and you can stay up to date.

### 28.5.1 Installing and Building the Source from a Compressed File

To install the ROOT source you can download the tar file containing all the source files from the ROOT website. The first thing you should do is to get the latest version as a tar file. Unpack the source tar file, this creates directory 'root':

```
% tar zxvf root_v5.30.xx.source.tar.gz
```

Type the build commands:

```
% cd root
% ./configure --help
% ./configure [<arch>]
% (g)make
```

Add bin/ to PATH and lib/ to LD\_LIBRARY\_PATH. For the sh shell family do:

```
% . bin/thisroot.sh
```

and for the csh shell family do:

```
% source bin/thisroot.csh
```

Try running root:

```
% root
```

It is also possible to setup and build ROOT in a fixed location. Please check README/INSTALL for more a detailed description of this procedure.

#### 28.5.1.1 Target directory

By default, ROOT will be built in the \$ROOTSYS directory. In that case the whole system (binaries, sources, tutorials, etc.) will be located under the \$ROOTSYS directory.

#### 28.5.1.2 Makefile targets

The Makefile is documented in details in the README/BUILDSYSTEM file. It explains the build options and targets.

## 28.5.2 More Build Options

To build the library providing thread support you need to define either the environment variable 'THREAD=-lpthread' or the configure flag '--with-thread=-lpthread' (it is the default for the linuxegcs architecture). [Note: this is only tested on Linux for the time being.] To build the library providing CERN RFIO (remote I/O) support you need to define either the environment variable 'RFIO=<path>/libshift.a' or the configure flag '--with-rfio=<path>/libshift.a'. For pre-built version of libshift.a see <ftp://root.cern.ch/root/shift/>

To build the PAW and Geant3 conversion programs h2root and g2root you need to define either the environment variable 'CERNLIB=<cernlibpath>' or the configure flag '--with-cern-libdir=<cernlibpath>'.

To build the MySQL interface library you need to install MySQL first. Visit <http://www.mysql.com/> for the latest versions.

To build the strong authentication module used by rootd, you first have to install the SRP (Secure Remote Password) system. Visit <http://srp.stanford.edu>

To use the library you have to define either the environment variable 'SRP=<srpdir>' or the configure flag '--with-srp=<srpdir>'.

To build the event generator interfaces for Pythia and Pythia6, you first have to get the Pythia libraries available from <ftp://root.cern.ch/root/pythia6.tar.gz>.

To use the libraries you have to define either 'PYTHIA=<pythiadir>' or the configure flag '--with-pythia=<pythiadir>'. The same applies for Pythia6.

### 28.5.2.1 Installing the Source from Subversion

This paragraph describes how to checkout and build ROOT from Subversion for Unix systems. For description of a checkout for other platforms, please see ROOT installation web page: <http://root.cern.ch/drupal/content/installing-root-source>.

```
% svn co http://root.cern.ch/svn/root/trunk root
U root/...
U ...
% cd root
% ./configure --help
% ./configure [<arch>]
% (g)make
```

If you are a part of collaboration, you may need to use setup procedures specific to the particular development environment prior to running (g)make. For more install instructions and options, see the file README/INSTALL.

### 28.5.2.2 Subversion for Windows

Although there exists a native version of Subversion for Windows, we only support the build process under the Cygwin environment. You must have svn version 1.6 or newer. The checkout and build procedure is similar to that for UNIX. For detailed install instructions, see the file README/INSTALL.

### 28.5.2.3 Staying up-to-date

To keep your local ROOT source up-to-date with the Subversion repository you should regularly run the command:

```
% svn up
```

## 28.6 File system.rootrc

ROOT Environment settings are handled via the class `TEnv`. `gEnv->Print()` shows which values are active. Any settings can be obtained by `TEnv::GetValue` methods that return an integer, double or character value for a named resource. If the resource is not found, the default value (given as the second parameter) is returned.

```
fShowEventStatus = gEnv->GetValue("Canvas.ShowEventStatus",kFALSE);
```

Via the method `TEnv::SetValue` allows you can set the value of a resource or create a new resource:

```
gEnv->SetValue("Root.ObjectStat",1);
```

Path used by dynamic loader to find shared libraries and macros. Paths are different for Unix and Windows. The example shows the defaults for all ROOT applications for either Unix or Windows:

```
Unix.*.Root.DynamicPath:  .:$(ROOTSYS)/lib
Unix.*.Root.MacroPath:    .:$(ROOTSYS)/macros
WinNT.*.Root.DynamicPath: .;$(ROOTSYS)/bin;$(PATH)
WinNT.*.Root.MacroPath:  .;$(ROOTSYS)/macros
```

Path where to look for TrueType fonts:

```
Unix.*.Root.UseTTFonts:   true
*.*.Root.TTFontPath:     $(ROOTSYS)/fonts
```

Use Net\* API functions:

```
WinNT.UseNetAPI:         true
```

Use thread library (if exists).

```
Unix.*.Root.UseThreads:  false
```

Select the compression algorithm (0=old zlib, 1=new zlib). Setting this to '0' may be a security vulnerability.

```
Root.ZipMode:           1
```

Show where item is found in the specified path:

```
Root.ShowPath:          false
```

Activate memory statistics (size and cnt are used to trap allocation of blocks of a certain size after cnt attempts).

```
Root.MemStat:           0
Root.MemStat.size:      -1
Root.MemStat.cnt:       -1
Root.ObjectStat:        0
```

Activate memory leak checker (use in conjunction with `$(ROOTSYS)/bin/memprobe`). Currently only works on Linux with gcc.

```
Root.MemCheck:          0
Root.MemCheckFile:      memcheck.out
```

Global debug mode. When >0 turns on progressively more details debugging.

```
Root.Debug:             0
Root.Stacktrace:        yes
```

Settings for X11 behaviour.



```
X11.Sync:                no
X11.FindBestVisual:      yes
```

Default editor in use.

```
Unix.*.Editor:           vi
WinNT.*.Editor:          notepad
```

Default 3d Viewer. By default 3-D views are shown in the pad, if the next line is activated, the default viewer will be OpenGL.

```
Viewer3D.DefaultDrawOption: ogl
```

Default Fitter (current choices are Minuit, Minuit2, Fumili and Fumili2).

```
Root.Fitter:             Minuit
```

Specify list of file endings which TTabCom (TAB completion) should ignore.

```
TabCom.FileIgnore:       .cpp:.h:.cmz
```

### 28.6.1 TCanvas Specific Settings

Opaque move and resize show full pad during the operation instead of only the outline. Especially for resize you will need serious CPU power. UseScreenFactor=true means to size canvas according to size of screen, so a canvas still looks good on a low resolution laptop screen without having to change canvas size in macros.

```
Canvas.MoveOpaque:       false
Canvas.ResizeOpaque:     false
Canvas.UseScreenFactor:   true
```

Hight color 2 is the red one.

```
Canvas.HighLightColor:   2
```

Next three settings are related to different user interface parts of canvas window. If they are set to true, the corresponding event status bar, tool bar, graphics editor to beactivated by default.

```
Canvas.ShowEventStatus:  false
Canvas.ShowToolBar:      false
Canvas.ShowEditor:       false
```

AutoExec allows TExec objects to be executed on mouse and key events.

```
Canvas.AutoExec:         true
```

Canvas print directory is set to the current one by default:

```
Canvas.PrintDirectory    .
```

Printer settings:

```

WinNT.*.Print.Command:   AcroRd32.exe
#Unix.*.Print.Command:  a2ps -P%p --landscape --columns=2 --margin=30 -rf8.0 %f
Print.Printer:          32-rb20-hp
Print.Directory:        .
Print.FileType:         pdf

```

Default histogram binnings used by `TTree::Draw()` method.

```

Hist.Binning.1D.x:      100
Hist.Binning.2D.x:      40
Hist.Binning.2D.y:      40
Hist.Binning.2D.Prof:   100
Hist.Binning.3D.x:      20
Hist.Binning.3D.y:      20
Hist.Binning.3D.z:      20
Hist.Binning.3D.Profx:  100
Hist.Binning.3D.Profy:  100

```

Default statistics names used for parameters in `TPaveStats`:

```

Hist.Stats.Entries      Entries
Hist.Stats.Mean         Mean
Hist.Stats.MeanX        Mean x
Hist.Stats.MeanY        Mean y
Hist.Stats.RMS          RMS
Hist.Stats.RMSX         RMS x
Hist.Stats.RMSY         RMS y
Hist.Stats.Underflow    Underflow
Hist.Stats.Overflow     Overflow
Hist.Stats.Integral     Integral
Hist.Stats.Skewness     Skewness
Hist.Stats.SkewnessX    Skewness x
Hist.Stats.SkewnessY    Skewness y
Hist.Stats.Kurtosis     Kurtosis
Hist.Stats.KurtosisX    Kurtosis x
Hist.Stats.KurtosisY    Kurtosis y

```

## 28.6.2 THtml Specific Settings

See the reference guide documentation of `THtml` class at <http://root.cern.ch/root/html/doc/THtml.html> for more details.

XHTML content charset (see <http://www.w3.org/TR/2002/REC-xhtml1-20020801>, default: ISO-8859-1) is set by:

`Root.Html.Charset:`

Stem of a search engine for the documentation, where `%s` is replaced by the term entered in the search text box (example: <http://www.google.com/search?q=%s+site%3Aroot.cern.ch%2Froot%2Fhtml>, default is "")

`Root.Html.Search:`

Link to the site's search engine (default: "", example: <http://root.cern.ch/root/Search.phtml>)

`Root.Html.SearchEngine:`

String to prepend to `TClass::GetImplFileName()` names containing directories when looking for source files (default: "", example: `../root`)

Root.Html.SourcePrefix:

Link stem to ViewCVS entry for classes, where a class name is assumed to match a file name (default: "", example: <http://root.cern.ch/viewcvs>).

Root.Html.ViewCVS:

Stem of the CERN XWho system (default: <http://consult.cern.ch/xwho/people?>)

Root.Html.XWho:

If set to Doc++, allow method documentation in front of method even for methods in the source file (default: "")

Root.Html.DescriptionStyle:

Search path for the source and header files with their default settings:

```
Unix.*.Root.Html.SourceDir:  .:src:include
WinNT.*.Root.Html.SourceDir: .;src;include
```

URL stem for ROOT documentation pages (default is "").

```
Root.Html.Root:              http://root.cern.ch/root/html
```

Filesystem output directory for generated web pages (default: `htmldoc`).

```
Root.Html.OutputDir:        htmldoc/
```

Address of the package's home page (default: <http://root.cern.ch>):

Root.Html.HomePage:

Location of user defined header and footer files, see <http://root.cern.ch/root/html/THtml#conf:header> (defaults are "", example: `../header.txt`, `../footer.txt`):

```
Root.Html.Header:
Root.Html.Footer:
```

Tag for detecting class description comments (default value is set below).

```
Root.Html.Description:      //-----
```

Tag for detecting "Author" comment (default value is set below).

```
Root.Html.Author:          // Author:
```

Tag for detecting "last updated" comment. **THtml** uses the current date if this tag is not found in a class source file (default value is set below).

```
Root.Html.LastUpdate:      // @(#)
```

Tag for detecting "Copyright" comment (default value is set below).

```
Root.Html.Copyright:       * Copyright
```

### 28.6.3 GUI Specific Settings

Set the “native” ROOT GUI interface to be used in a ROOT session. If set to “qt”, the “native” GUI interface is replaced with one based on Qt by the regular ROOT plug-in mechanism.

```
Gui.Backend:          native
Gui.Factory:         native
```

GUI default fonts in use:

```
Gui.DefaultFont:     -adobe-helvetica-medium-r-*-12-*-*-*-*-*iso8859-1
Gui.MenuFont:       -adobe-helvetica-medium-r-*-12-*-*-*-*-*iso8859-1
Gui.MenuHiFont:    -adobe-helvetica-bold-r-*-12-*-*-*-*-*iso8859-1
Gui.DocFixedFont:  -adobe-courier-medium-r-*-12-*-*-*-*-*iso8859-1
Gui.DocPropFont:   -adobe-helvetica-medium-r-*-12-*-*-*-*-*iso8859-1
Gui.IconFont:      -adobe-helvetica-medium-r-*-10-*-*-*-*-*iso8859-1
Gui.StatusFont:    -adobe-helvetica-medium-r-*-10-*-*-*-*-*iso8859-1
```

Regular background and foreground colors in use:

```
Gui.BackgroundColor: #c0c0c0
Gui.ForegroundColor: black
```

Selection background and foreground colors in use:

```
Gui.SelectBackgroundColor: #000080
Gui.SelectForegroundColor: white
```

Document background and foreground colors in use:

```
Gui.DocumentBackgroundColor: white
Gui.DocumentForegroundColor: black
```

Tooltip background and foreground colors in use:

```
Gui.TooltipBackgroundColor: LightYellow
Gui.TooltipForegroundColor: black
```

Path where all GUI icons in use can be found:

```
Gui.IconPath:        $(HOME)/icons:$(ROOTSYS)/icons:.
```

Mime type file setting:

```
Gui.MimeTypeFile:    $(HOME)/.root.mimes
```

If \$(HOME)/.root.mimes does not exist, defaults to this:

```
#Gui.MimeTypeFile:    $(ROOTSYS)/etc/root.mimes
```

### 28.6.4 TBrowser Settings

Current icon style selection - can be either `small`, `big`, `list`, `details`:

```
Browser.IconStyle:      small
```

Current sorting rule applied on the browser objects - can be `name`, `type`, `size`, `date`:

```
Browser.SortBy:        name
```

Number of items in a group view:

```
Browser.GroupView:     10000
```

Show or not hidden items:

```
Browser.ShowHidden:    no
```

Create a thumbnail view after executing the macro (default is `yes`).

```
Browser.AutoThumbnail: yes
```

### 28.6.5 TRint Specific Settings

Rint (interactive ROOT executable) specific alias, logon and logoff macros.

```
Rint.Load:              rootalias.C
Rint.Logon:             rootlogon.C
Rint.Logoff:            rootlogoff.C
```

Record ROOT session commands in a given history file (default is `$(HOME)/.root_hist`). If set to `-`, it turn off the command recording.

```
Rint.History:           $(HOME)/.root_hist
```

Next two lines set the history file size handling. Once `HistSize` is reached, the last `HistSave` entries are removed. If `HistSize` is set to 0, it turns off command recording. Both values can be overridden by environment variable `ROOT_HIST=size[:save]`, where the `“:save”` part is optional.

```
Rint.HistSize:          500
Rint.HistSave:          400
```

### 28.6.6 ACLiC Specific Settings

`ACLiC.Linkdef` specifies the suffix that will be added to the script name to try to locate a custom linkdef file when generating the dictionary.

```
ACLiC.Linkdef:          _linkdef
```

The top directory for storing the libraries produced by ACLiC is set by:

```
ACLiC.BuildDir:         /where/I/would/like/my/compiled/scripts
```

The additional include directives for ACLiC compilations are set by:

```
ACLiC.IncludePaths:     -I/where/the/includes/are
```

## 28.6.7 PROOF Related Variables

PROOF debug options.

```
Proof.DebugLevel: 0
Proof.DebugMask: -1
```

PROOF GDB hooks allows a debugger to be attached early in the startup phase of `proofserv:0` - don't wait; 1 - master `proofserv` enters wait loop; 2 - slave `proofserv` enters wait loop; 3 - any `proofserv` enters wait loop

```
Proof.GdbHook: 0
```

On the master to enable the parallel startup of workers using threads set next to “yes” (default is “no”):

```
Proof.ParallelStartup: no
```

```
Proof.StatsHist: no
Proof.StatsTrace: no
Proof.SlaveStatsTrace: no
```

```
Proof.CondorHome: /opt/condor
Proof.CondorConfig: /opt/condor/etc/condor_config
```

```
PEAC.GmUrl: http://somewhere:8080/clarens/
PEAC.LmUrl: http://elsewhere:8080/clarens/
```

Certificate and key

```
Clarens.CertFile: $(HOME)/.globus/usercert.pem
Clarens.KeyFile: $(HOME)/.globus/userkey.pem
```

### 28.6.7.1 Settings Related to Authentication for rootd and proofd

Default authentication method for `rootd` and `proofd`. These are supported for backward compatibility but have a very low priority. System defaults are generated by `configure` as a list in `system.rootauthrc` in `$ROOTSYS/etc/` or `/etc/root`; the file `$(HOME)/.rootauthrc` can be used to override the system defaults.

The value meaning: 0=UsrPwD, 1=SRP, 2=Krb5, 3=Globus,4=SSH, 5=UidGid.

```
Rootd.Authentication: 0
Proofd.Authentication: 0
```

Connection is shutdown at timeout expiration. Timeout is in seconds. Negotiation cannot be attempted at low level (i.e. inside `TAAuthenticate::Authenticate()`) because of synchronization problems with the server. At higher level, `TAAuthenticate::HasTimedOut()` gives information about timeout: 0 = no timeout; 1 = timeout, no methods left; 2 = timeout, still methods to be tried. Caller should decide about an additional attempt. Timeout is disabled by default (< 0). It can be changed on-the-fly with the method `TAAuthenticate::SetTimeout(to_value)`.

```
Auth.Timeout: -1
```

Password dialog box is set to 0 if you do not want a dialog box to be popped-up when a password is requested. Default setting is 1.

```
Auth.UsePasswdDialogBox: 0
```

Set the following to 1 if you want full SRP authentication in PROOF (Client-to-Master and Master-to-Slave).

```
Proofd.SendSRPPwd:      0
```

Set next to 1 to use SSH authentication in PROOF servers (Master-to-Slave or Slaves-to-DataServers). This is switched off by default because credentials forwarding for SSH is not controlled by the system; however the user may have other ways to guarantee it, so it may want to switch it on.

```
ProofServ.UseSSH:      0
```

Default login name (if not defined it is taken from \$(HOME)).

```
UsrPwd.Login:          qwerty
SRP.Login:             qwerty
Krb5.Login:            qwerty@LOCAL.DOM.AIN
Globus.Login:          cd:~/globus cf:usercert.pem kf:userkey.pem
ad:/etc/grid-security/certificates
SSH.Login:             qwerty
UidGid.Login:          qwerty
```

To be prompted for login information.

```
UsrPwd.LoginPrompt:   yes
SRP.LoginPrompt:      yes
Krb5.LoginPrompt:     yes
Globus.LoginPrompt:   yes
SSH.LoginPrompt:      yes
UidGid.LoginPrompt:   yes
```

To reuse established security context.

```
UsrPwd.ReUse:         yes
SRP.ReUse:            no
Krb5.ReUse:           no
Globus.ReUse:         yes
SSH.ReUse:            yes
```

Duration validity of the sec context for UsrPwd, SRP and SSH. Format: <hours>:<minutes> (default 24:00)

```
#UsrPwd.Valid:        24:00
#SRP.Valid:           24:00
#SSH.Valid:           24:00
```

To control password encryption for UsrPwd authentication.

```
UsrPwd.Crypt:         yes
```

Globus Miscellaneous - Globus Proxy duration: HH:MM (ex 12:15 for 12 hours and 15 min); 'default' for system default.

```
Globus.ProxyDuration: default
#Globus.ProxyDuration: 12:15
```

Number of bits for the initial key.

```
Globus.ProxyKeyBits:  1024
```

Path to alternative 'ssh' (to override \$PATH if ever needed).

SSH.ExecDir: /usr/bin

In case of error, SSH returns 1 (or 256=0x100). To trap those errors for which one should retry, error printouts must be parsed; any substring found under the `TEnv SSH.ErrorRetry` triggers a retry condition; strings can be added here in the form (including double quotes):

+SSH.ErrorRetry: "<error\_string>"

This is what one usually gets if the server has reached the maximum number of sshd daemons (defined by `MaxStartups` in `sshd_config`); this is a typical case in which one should retry.

SSH.ErrorRetry: "Connection closed by remote host"

Max number of retries for SSH in case of retry error (see above).

SSH.MaxRetry: 100

Type of key to be used for RSA encryption: 0=local; 1=SSL (default if openssl available).

RSA.KeyType: 1

In case of 'RSA.KeyType: 1' this specifies the number of bits to be used for the Blowfish key used to encrypt the exchanged information: default - 256, minimum - 128, maximum - 15912.

SSL.BFBits: 256

### 28.6.7.2 Server Authentication in TServerSocket

General setting: file with server access rules

SrvAuth.DaemonRc: /etc/root/system.daemonrc

Check of host equivalence via /etc/hosts.equiv or \$HOME/.rhosts.

SrvAuth.CheckHostsEquivalence: 1

SRP: pass file (default \$HOME/.rootdpass).

SrvAuth.SRPpassfile: \$HOME/.rootdpass

Globus/GSI: hostcert configuration file.

SrvAuth.HostCert: /etc/root/hostcert.conf

Globus/GSI: gridmap file.

SrvAuth.GridMap: /etc/grid-security/grid-mapfile

SSH: port for the sshd daemon.

SrvAuth.SshdPort: 22



Force file opening via **TNetFile** (**TXNetFile**) if a hostname is specified in the Url. By default, for local files **TFile::Open()** invokes directly **TFile**.

**TFile.ForceRemote:**            **yes**

Special cases for the **TUrl** parser, where the special cases are parsed in a protocol + file part, like `rfio:host:/path/file.root`, `castor:/path/file.root` or `/alien/path/file.root`. In case the file namespace descriptor ends with `-` the namespace is not a part of the filename. Extend in private `.rootrc` with a `+Url.Special` line.

**Url.Special:**                **file: rfio: hpss: castor: gfal: dcache:**  
**+Url.Special:**                **/alien/- /castor/**

### 28.6.7.3 PROOF XRD Client Variables

Debug level (if `<=0` : none, `1` : low, `2` : medium, `3` : high)

**XProof.Debug:**                **0**

Socket read timeout [in secs: default 10 secs]

**XProof.ReadTimeout:** **10**

The following env vars are handled by **TXNetFile** and related classes (module `netx`, `libNetx.so`).

**XNet.ConnectTimeout** - maximum time to wait before server's response on a connect [10 s]

**XNet.RequestTimeout** - maximum time to wait before considering a read/write failure [60 s]

**XNet.ConnectDomainAllowRE** - sequence of **TRegexp** regular expressions separated by a `|`. A domain is granted access to for the first connection if it matches one of these regexps. Example:

`slac.stanford.edu|pd.infn.it|fe.infn.it`

**XNet.ConnectDomainDenyRE** - sequence of **TRegexp** regular expressions separated by a `|`. A domain is denied access to for the first connection if it matches one of these regexps.

**XNet.RedirDomainAllowRE** - sequence of **TRegexp** regular expressions separated by a `|`. A domain is granted access to for a redirection if it matches one of these regexps. Example:

**XNet.RedirDomainDenyRE** - sequence of **TRegexp** regular expressions separated by a `|`. A domain is granted access to for a redirection if it matches one of these regexps.

**XNet.MaxRedirectCount** - maximum number of redirections from server [default - 255]

**XNet.Debug** - log verbosity level (0=nothing,1=messages of interest to the user, 2=messages of interest to the developers (includes also user messages), 3=dump of all sent/received data buffers (includes also user and developers messages). [default - 0]

**XNet.ReconnectTimeout** - sleep-time before going back to the load balancer (or rebounding to the same failing host) after a read/write error [default - 10s]

**XNet.StartGarbageCollectorThread** - for test/development purposes. Normally nonzero (true), but as workaround for external causes someone could be interested in not having the garbage collector thread around. [experimental!]

**XNet.GoAsynchronous** - default is 0. When activated, **XTNetFile** works in async mode, allowing input buffering and unsolicited responses [experimental!]

**XNet.TryConnect** - Number of tries connect to a single server before giving up.

**XNet.TryConnectServersList** - number of connect retries to the whole server list given [default - 240]

**XNet.PrintTAG** - Print a particular string the developers can choose to quickly recognize the version at run time [default - 0]

Example of custom setting for the Rint application (`root.exe`). This overrides the default specified above for a generic application. Color 5 is yellow.

**Rint.Canvas.HighlightColor:**            **5**

## 28.7 Documentation to Download

- The latest ROOT Users Guide
- <http://root.cern.ch/root/doc/RootDoc.html>
- ROOT Reference Guide
- <http://root.cern.ch/root/Reference.html>

# Index

<b>A</b>	
adding a class	
ACLiC.....	453
shared library.....	446
<b>B</b>	
benchmarks.....	384
box-and whisker plot.....	370
<b>C</b>	
C++.....	155
candle plot.....	370
candle stick plot.....	370
CINT.....	161
<b>D</b>	
documentation	
class.....	669
<b>G</b>	
Geometry.....	477
Graphical User Interface.....	609
GUI application.....	583
<b>H</b>	
histogram.....	57
profile.....	377
rebin.....	60, 100, 105
<b>I</b>	
I/O.....	277
install ROOT.....	25, 673
<b>L</b>	
list	
entry.....	372
event.....	372
<b>P</b>	
parallel poordinates.....	362
parallel processing.....	607
PROOF.....	607
Python.....	559
<b>Q</b>	
Qt.....	653
<b>R</b>	
Ruby.....	559
<b>T</b>	
TPad.....	193
transparency	
parallel coordinates.....	370
tree	
chains.....	385
friend.....	386
MakeClass.....	378
MakeSelector.....	382
scan.....	371